

KYMCO Downtown 350i Service Manual

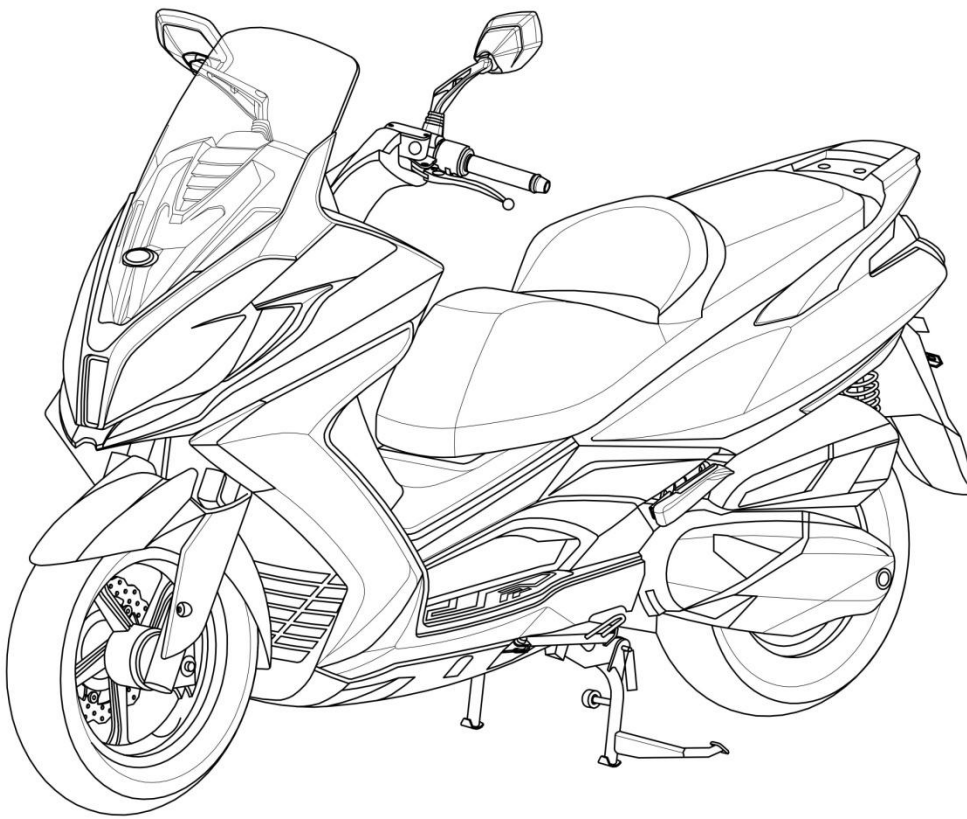

Using this manual

This manual has been designed to assist trained mechanics in servicing the models listed above. If you do not have the proper training or tools to perform a particular task it is best if you seek out a service professional.

This manual was written using the latest information available at the time of publication. Illustrations in this manual are shown to help you with the basics of performing the jobs listed. The pictures in this manual may not depict the actual vehicle you're working on, however the procedures will be similar.

Inexperienced technicians without the correct tools and knowledge may not be able to perform these jobs as intended. Caution needs to be taken for the vehicle and its operator as serious injury can occur. Always read a procedure in its entirety before attempting any repairs.

KYMCO reserves all rights to this publication and does not permit the reproduction or use of this publication, in full or in part, in any manner without our express written permission. No trademark or patent liability is assumed with respect to the use of the information contained in this manual.

While the instructions, photographs and illustrations in this manual have been reviewed for accuracy it is up to the individual performing the procedures to use good judgement when performing any procedures described. Every precaution has been taken in the manufacture of this manual however the publisher assumes no responsibility for errors and omissions. Furthermore, no liability or responsibility is assumed for damages to property or injury to persons resulting from the use of the information contained in this guide. Use of this information to perform service procedures is done entirely at your own risk.

1. Quick Reference

This chapter provides a quick reference source of technical specifications and information for KYMCO Downtown 350i models.

<u>Component Location</u>	1-2
<u>Special Tools</u>	1-6
<u>Specifications</u>	1-7
<u>Torque Specifications</u>	1-19
<u>Troubleshooting</u>	1-22
<u>VIN and Engine Number Location</u>	1-27

2. Periodic Maintenance

This chapter covers the periodic maintenance for the KYMCO Downtown 350i.

<u>Maintenance Schedule</u>	2-2
<u>Air Filter Servicing</u>	2-4
<u>Brake Fluid</u>	2-6
<u>Brake Inspection</u>	2-13
<u>Engine Compression Test</u>	2-15
<u>Coolant Level Check</u>	2-17
<u>Engine Oil</u>	2-21
<u>General Lubrication</u>	2-36
<u>Hose Inspection</u>	2-37
<u>Side Stand</u>	2-38
<u>Spark Plug</u>	2-40
<u>Steering</u>	2-43
<u>Suspension</u>	2-44
<u>Throttle Free Play</u>	2-46
<u>Tires</u>	2-52
<u>Final Drive Oil</u>	2-54
<u>Valve Clearance</u>	2-60

3.External Components

This chapter covers the location and servicing of the external components for the KYMCO Downtown 350i model.

REAR PART

<u>Seat</u>	3-3
<u>Luggage Box</u>	3-7
<u>Rear Carrier</u>	3-9
<u>Rear Center Cover</u>	3-10
<u>Body Cover</u>	3-11
<u>Rear Inner Fender</u>	3-16
<u>Rear Tire Fender</u>	3-17
<u>Heat Shield</u>	3-18
<u>Exhaust System</u>	3-20

4.Engine

This chapter covers the location and servicing of the engine components for the KYMCO Downtown 350i model.

<u>Cylinder Head Cover</u>	4-5
<u>Camshaft</u>	4-8
<u>Cylinder Head</u>	4-23
<u>Valves</u>	4-31
<u>Cylinder and Piston</u>	4-37
<u>Starter Clutch</u>	4-62
<u>Generator</u>	4-69
<u>Oil Pump</u>	4-73
<u>Crankcase</u>	4-77
<u>Crankshaft</u>	4-87
<u>Engine Removal</u>	4-90

5. Cooling System

This chapter covers the location and servicing of the cooling system components for the KYMCO Downtown 350i model.

Coolant	5-3
Radiator	5-12
Water Temperature Sensor (WTS)	5-22
Water Pump	5-28

6. Fuel Injection System

This chapter covers the location and servicing of the fuel system components for the KYMCO Downtown 350i model.

Airbox	6-4
Fuel Tank	6-8
Fuel Pump	6-13
Throttle Body Removal	6-21
Throttle Cable	6-32
Throttle Body	6-35
Fuel Injector	6-41
TPS ISC Reset Procedure	6-46
Self-Diagnosis	6-47
F.I. Diagnostic Tool	6-54

7. CVT Continuously Variable Transmission

This chapter covers the location and servicing of the CVT components for the KYMCO Downtown 350i model.

Belt Case	7-2
CVT Removal	7-7
CVT Installation	7-26

8. Final Drive

This chapter covers the location and servicing of the final drive components for the KYMCO Downtown 350i model.

<u>Final Drive Oil</u>	8-3
<u>Final Reduction</u>	8-8

9. Electrical Systems

This chapter covers the location and servicing of the electrical systems for the KYMCO Downtown 350i model.

<u>Electrical Specifications</u>	9-8
<u>Fuses</u>	9-10
<u>ECU Removal</u>	9-11
<u>Ignition System</u>	9-15
<u>Charging System</u>	9-22
<u>Battery</u>	9-24
<u>Relays</u>	9-28
<u>Starting System</u>	9-30
<u>Starter Motor</u>	9-34
<u>Switches</u>	9-36
<u>Lights</u>	9-48
<u>Horn</u>	9-56

10.Brakes

This chapter covers the location and servicing of the brake system components for the KYMCO Downtown 350i model.

<u>Brake Pad Replacement</u>	10-2
<u>Master Cylinders</u>	10-13
<u>Master Cylinders</u>	10-22
<u>Front Brake Caliper</u>	10-26
<u>Rear Brake Caliper</u>	10-31
<u>Brake Disc</u>	10-37
ABS	10-42

11.Steering

This chapter covers the location and servicing of the steering components for the KYMCO Downtown 350i model.

<u>Handlebar</u>	11-2
Grips	11-8
Steering stem	11-8

12.Front Suspension

This chapter covers the location and servicing of the front fork components for the KYMCO Downtown 350i model.

<u>Front Fork Removal</u>	12-2
<u>Front Fork Installation</u>	12-6
<u>Fork Disassembly</u>	12-8
<u>Fork Assembly</u>	12-17

13.Rear Suspension

This chapter provides information on the rear suspension components of the KYMCO Downtown 350i model.

<u>Shock Absorbers</u>	13-2
Rear Fork	13-8

14.Wheels

This chapter covers the location and servicing of the wheels for the KYMCO Downtown 350i model.

<u>Bearing Replacement</u>	14-2
<u>Front Wheel</u>	14-6
<u>Rear Wheel</u>	14-11
<u>Wheel Inspection</u>	14-19
<u>Wheel Specifications</u>	14-21

1. Quick Reference

This chapter provides a quick reference source of technical specifications and information for KYMCO Downtown 350i models.

<u>Component Location</u>	1-2
<u>Special Tools</u>	1-5
<u>Specifications</u>	1-6
<u>Torque Specifications</u>	1-19
<u>Troubleshooting</u>	1-22
<u>VIN and Engine Number Location</u>	1-27

Component Location

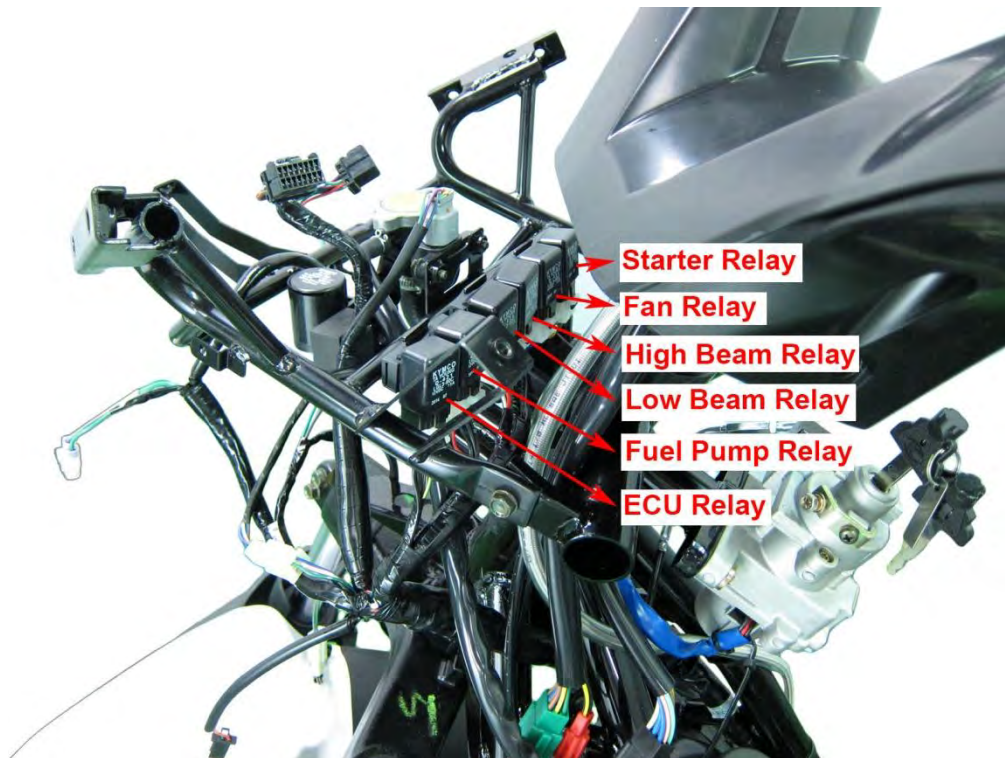
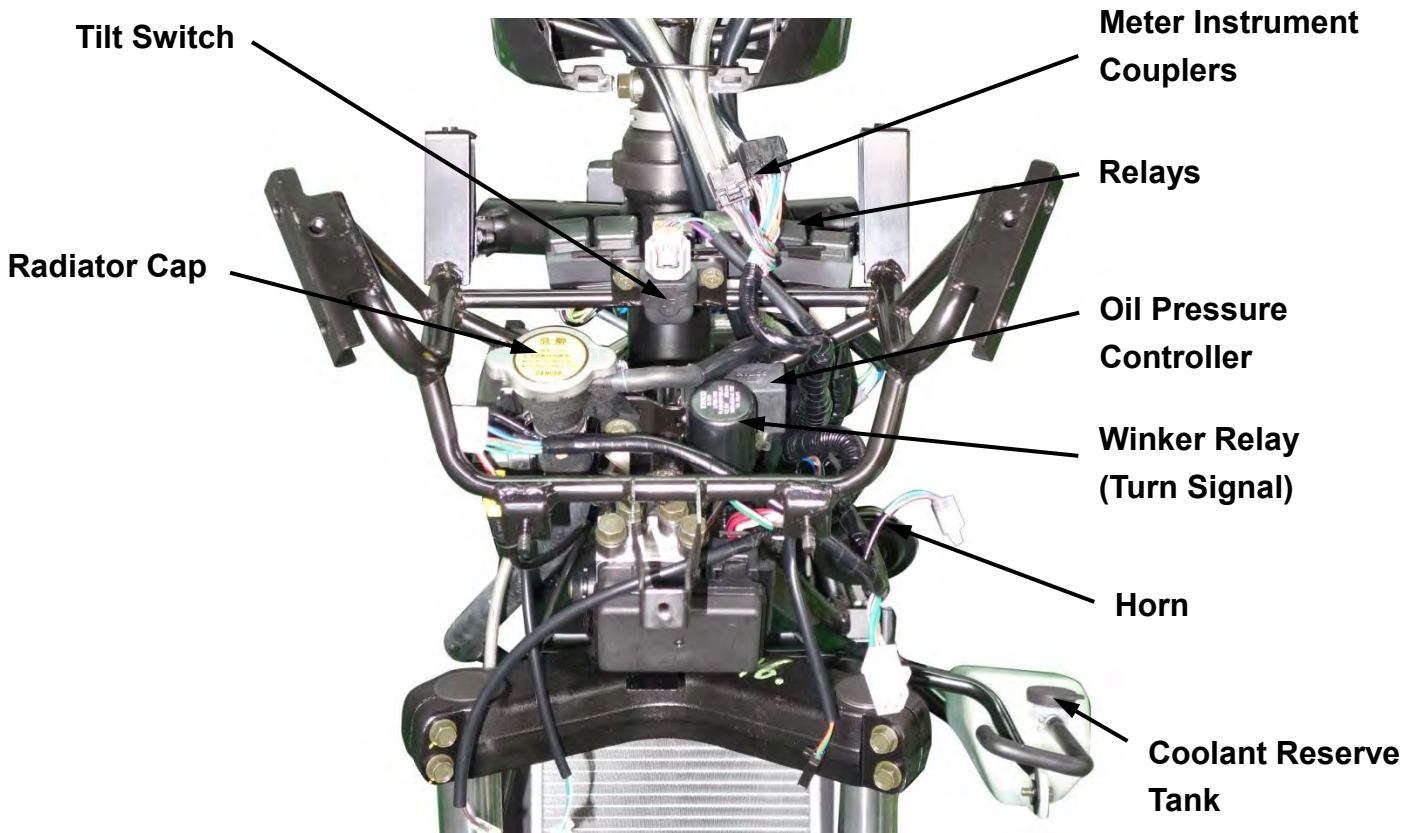

Component Location

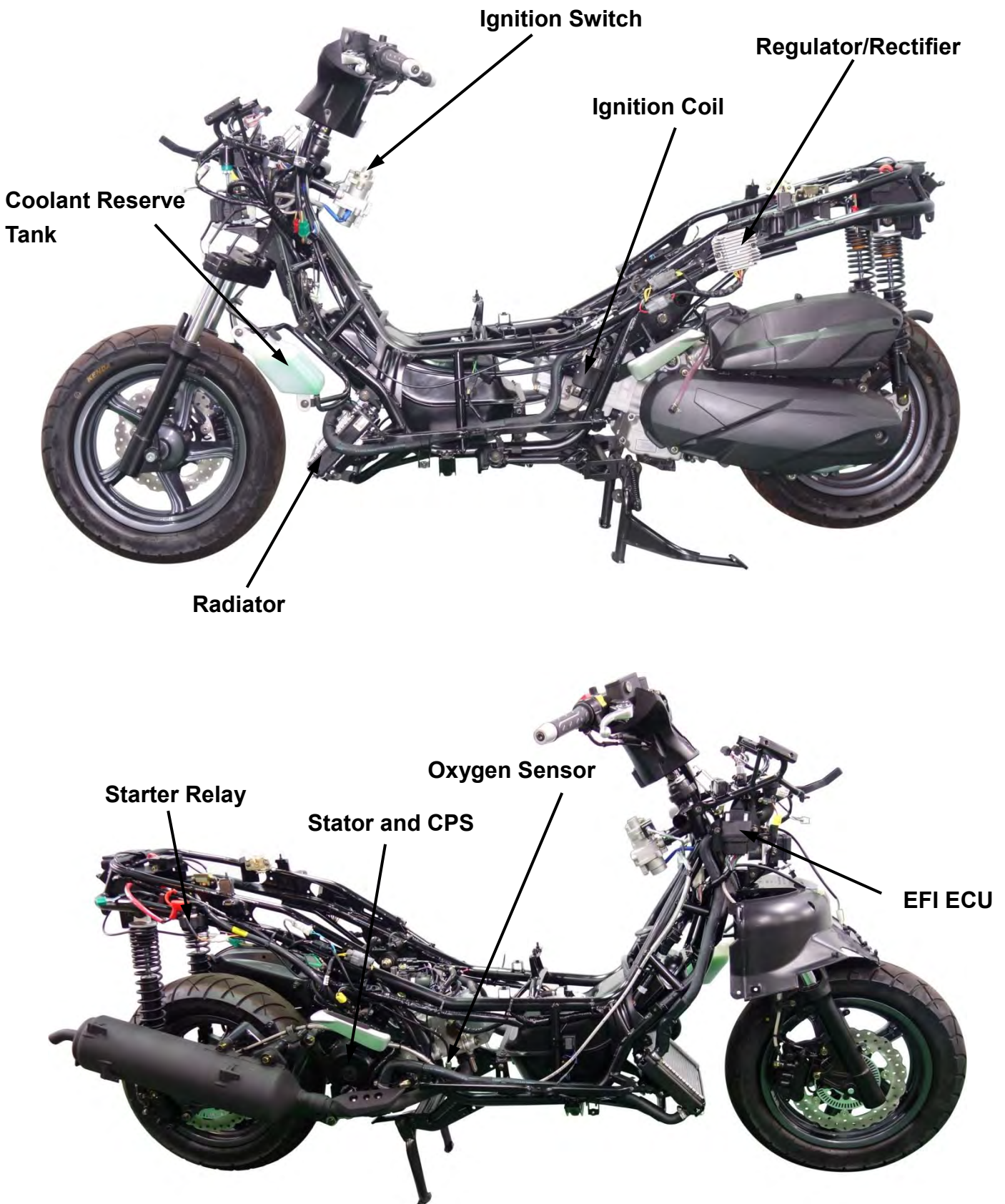

Component Location

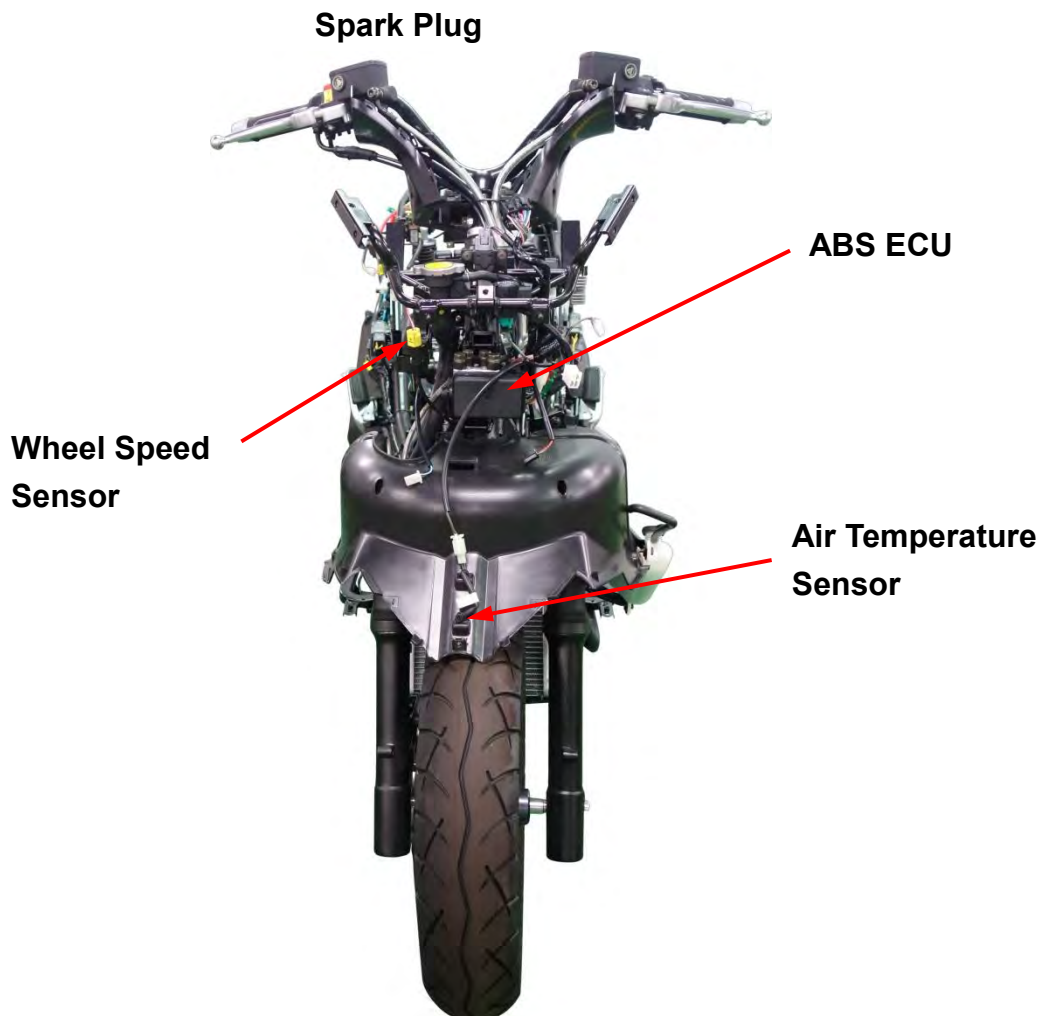
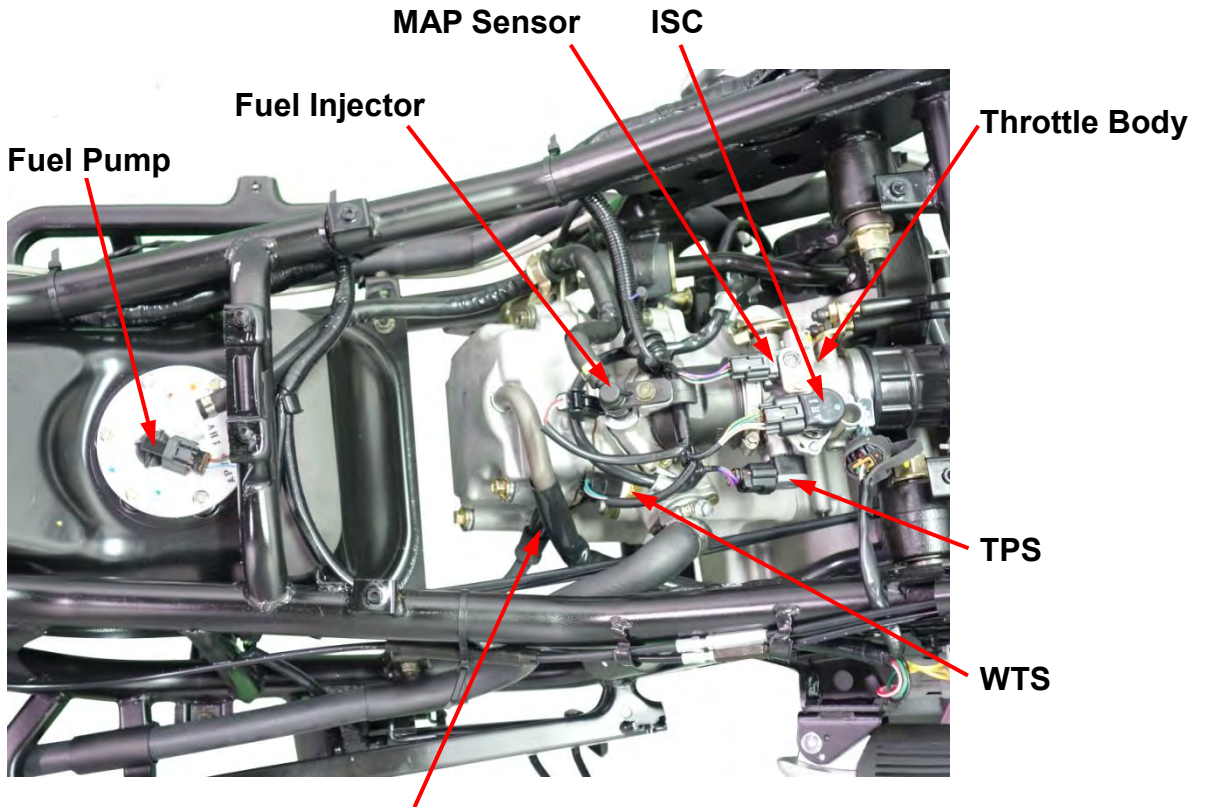

Special Tools

SPECIAL TOOLS		
ITEM	TOOL NO.	DESCRIPTION
FLYWHEEL PULLER	A120E00003	Flywheel Puller (M28x1)
TAPPET ADJUSTER	A120E00012	Adjusting valve clearance
OIL SEAL & BEARING DRIVER	A120E00014	General Driver Set
UNIVERSAL HOLDER	A120E00021	Holding clutch pulley and flywheel
#41 NUT AND FITTING TOOL	A120E00028	Clutch disassembly
THREAD PROTECTOR	A120E00029	Crankshaft thread protector
BEARING PULLER	A120E00037	General Puller Set
VALVE COTTER INSTALLER	A120E00051	Valve cotter installation
CLUTCH SPRING COMPRESSOR	A120E00053	Clutch disassembly
STEERING STEM LOCK NUT WRENCH (32 mm)	F002	Steering stem removal & installation

KYMCO Downtown 350i Specifications

General Information

Name (Model Code)		Downtown 350i (ACD5)
Overall length (mm)		2250
Overall width (mm)		780
Overall height (mm)		1310
Wheel base (mm)		1553
Engine type		4 stroke OHC
Displacement (cc)		321
Fuel recommended		90 # nonleaded gasoline
Curb weight (kg)	Front wheel	78
	Rear wheel	111
	Total	189
Max. weight capacity (kg)	Front wheel	130
	Rear wheel	234
	Total	364
Tires	Front wheel	120/80-14
	Rear wheel	150/70-13
Ground clearance (mm)		140
Performance	Braking distance (m)	7.9m / 40 km/hr
	Min. turning radius (m)	2.5

Engine	Starting system		Starting motor	
	Type		Gasoline, 4-stroke	
	Cylinder arrangement		SINGLE CYLINDER	
	Combustion chamber type		Semi-sphere	
	Valve arrangement		O.H.C. Chain drive	
	Bore x stroke (mm)		75.3 x 72	
	Compression ratio		10.7	
	Compression pressure		12 (kg/cm ²)	
	Max. Horsepower		30.05/7500 PS/rpm	
	Max. Torque		3.2 / 5750 Kg-m/rpm	
	Valve timing	Intake	Open	9.5° BTDC
			Close	37.5° ABDC
		Exhaust	Open	40° BBDC
			Close	10° ATDC
	Valve clearance (cold) (mm)	Intake	0.10	
		Exhaust	0.10	
	Idle speed (rpm)		1600 ± 100	
	Lubrication System	Lubrication type		Forced pressure & Wet pump
		Oil pump type		Inner/outer rotor type
		Oil filter type		Full-flow filtration
Oil capacity		1.5 liter		
Cooling Type		Liquid cooling		

Fuel System	Air cleaner type & No		Paper element, wet		
	Fuel capacity		12.5 liter		
	Injection	Brand		Keihin	
		Type		Throttle body	
		Venturi dia.(mm)		34	
Fuel pump pressure		3 Bar			
Electrical Equipment	Ignition System	Type		ECU	
		Spark plug	Spec.	CR7E (NGK)	
			Gap	0.6-0.7 mm	
	Battery Capacity		12V10AH		
Power Drive System	Clutch Type		Dry multi-clutch		
	Transmission Gear	Type		CVT	
		Operation		Automatic centrifugal type	
	Reduction Gear	Type		Two-stage reduction	
		Reduction ratio	1st	2.24 ~ 0.72	
2nd			7.222		
Moving Device	Tire type		Tubeless		
	Wheel material		Aluminum		
	Tire pressure Kg/cm ² (psi)	Front	2.0 (28.4)		
		Rear	2.25 (32)		
	Handle turning angle(L/R)	Left	40°		
Right		40°			
Brake system type		Front	Disc brake		
		Rear	Disc brake		
Damping Device	Suspension type	Front	Telescope		
		Rear	Swing arm		
	Shock absorber stroke	Front	110 mm		
		Rear	100 mm		
Frame type		UNDER BONE			

ENGINE		
Throttle grip free play	2 ~ 6 mm	
Spark plug	NGK: CR7E	
Spark plug gap	0.6 mm ~ 0.7 mm	
Valve clearance	IN: 0.10 mm	EX: 0.10 mm
Idle speed	1600 ± 100 rpm	
Cylinder compression	12 ± 2 kg/cm ²	
Ignition timing	ECU	
Coolant type	Coolant type	
Engine oil capacity:		
At disassembly	1.5 Liter	
At change	1.3 Liter	
Gear oil type:	SAE 90	
Gear oil capacity:		
At disassembly	0.23 Liter	
At change	0.21 Liter	

Coolant capacity:		
Radiator and hose with cool coolant	870 cc	
Reserve tank	490 cc	

Engine

Item		Standard (mm)
Valve clearance (cold)	IN	0.10
	EX	0.10
Camshaft cam height	IN	34.2987
	EX	34.1721
Valve rocker arm I.D.	IN	10.00 - 10.015
	EX	10.00 - 10.015
Valve rocker arm shaft O.D.	IN	9.972 - 9.987
	EX	9.972 - 9.987
Valve seat width	IN	1.2
	EX	1.2
Valve stem O.D.	IN	4.990 - 4.975
	EX	4.970 - 4.955
Valve guide I.D.	IN	5.00 - 5.012
	EX	5.00 - 5.012
Valve stem-to-guide clearance	IN	0.010 - 0.037
	EX	0.030 - 0.057

Item		Standard (mm)	
Cylinder	I.D.	75.3	
	Taper limit	0.05	
	Out of round limit	0.05	
Piston, piston ring	Ring-to-groove clearance	Top	0.015 - 0.055
		Second	0.015 - 0.055
	Ring end gap	Top	0.10 - 0.25
		Second	0.10 - 0.25
		Oil side rail	0.2 - 0.7
	Piston O.D.		
	Piston O.D. measuring point		9 mm from bottom of skirt
	Piston-to-cylinder clearance		0.101 - 0.040
	Piston pin hole I.D.		15.002 - 15.008
Piston pin O.D.		14.994 - 15.000	
Piston-to-piston pin clearance		0.002 - 0.014	
Connecting rod small end I.D. Bore		15.016 - 15.034	

Item		Standard (mm)	Service Limit (mm)
Crankshaft	Connecting rod big end side clearance	0.15 - 0.35	0.6
	Connecting rod big end radial clearance	0 - 0.008	0.05

Bearing Color				
Crankshaft mark	Crankcase mark			
	A	B	C	D
A	black	green	green	red
B	green	green	red	---

Item	Service Limit (mm)
Starter drive gear I.D.	22.15
Starter drive gear O.D.	41.50

CVT

Item	Standard (mm)	Service Limit (mm)
Clutch lining thickness	4.0	2.0
Clutch outer I.D.	152.1 - 152.2	152.2
Weight roller O.D (Drive Pulley)	19.92 - 20.08	20.08

Cooling System

Radiator cap relief pressure		0.9 ± 0.15 kg/cm ² (12.8 ± 2.1 psi)
Thermostat temperature	Begins to open	71 °C
	Full-open	80 °C
	Valve lift	3.5 - 4.5 mm

COOLANT MIXTURE (WITH ANTI-RUST AND ANTI-FREEZING EFFECTS)

Freezing Point	Mixing Rate	KYMCO SIGMA Coolant Concentrate	Distilled Water
-9°C	20%	344 cc	1375 cc
-15°C	30%	516 cc	1203 cc
-25°C	40%	688 cc	1031 cc
-37°C	50%	860 cc	859 cc
-44.5°C	55%	945 cc	774 cc

COOLANT GRAVITY CHART						
Temp. C° Coolant concentration	0	5	10	15	20	25
5%	1.009	1.009	1.008	1.008	1.007	1.006
10%	1.018	1.107	1.017	1.016	1.015	1.014
15%	1.028	1.027	1.026	1.025	1.024	1.022
20%	1.036	1.035	1.034	1.033	1.031	1.029
25%	1.045	1.044	1.043	1.042	1.040	1.038
30%	1.053	1.051	1.051	1.049	1.047	1.045
35%	1.063	1.062	1.060	1.058	1.056	1.054
40%	1.072	1.070	1.068	1.066	1.064	1.062
45%	1.080	1.078	1.076	1.074	1.072	1.069
50%	1.086	1.084	1.082	1.080	1.077	1.074
55%	1.095	1.093	1.091	1.088	1.085	1.082
60%	1.100	1.098	1.095	1.092	1.089	1.086

Temp. C° Coolant concentration	30	35	40	45	50
5%	1.005	1.003	1.001	0.009	0.997
10%	0.013	1.011	1.009	1.007	1.005
15%	1.020	1.018	1.016	1.014	1.012
20%	1.027	1.025	1.023	1.021	1.019
25%	1.036	1.034	1.031	1.028	1.025
30%	1.043	1.041	1.038	1.035	1.032
35%	1.052	1.049	1.046	1.043	1.040
40%	1.059	1.056	1.053	1.050	1.047
45%	1.056	1.063	1.062	1.057	1.054
50%	1.071	1.068	1.065	1.062	1.059
55%	1.079	1.076	1.073	1.070	1.067
60%	1.083	1.080	1.077	1.074	1.071

Fuel Injection System

ITEM		SPECIFICATIONS
Throttle body identification number		ACD5
Idle speed		1600 ± 100 rpm
Throttle grip free play		2 - 6 mm (1/16 - 1/4 in)
Fuel injector resistance (at 20°C/68°F)		9.9 - 13.5 Ω
Fuel pump resistance (at 20°C/68°F)	Float at full position	1100 ± 33 Ω
	Float at empty position	100 ± 3 Ω
Fuel pump standard pressure (at 40 L/Hr)		3 Bar 294 ± 6 kPa 42 ± 0.9 psi
Water temperature sensor resistance	At -20°C/-4°F	18.8 KΩ
	At 40°C/104°F	1.136 KΩ
	At 100°C/212°F	0.1553 KΩ
Intake pressure sensor (MAP) pressure (at 1 - 4.2 V)		13.332 kPa (0.13332 kgf/ cm ² , 1.89 psi) - 119.99 KPa (1.1999 kgf/ cm ² , 17.04 psi)
Inductive ignition coil		Primary: 3.57 - 4.83 Ω Secondary: 10.42~14.49 KΩ
Throttle position sensor (TPS) resistance (at 20°C/68°F)		3500 - 6500 Ω
Crank position sensor voltage (at 200 rpm)		100 - 130 Ω
O ² heater sensor resistance (at 20°C/68°F)		6.7 - 9.5 Ω (engine warming condition)
Tilt switch voltage	Standard	0.4 - 1.4 V
	Over 65° (fall down)	3.7 - 4.4 V

CELP FAILURE CODES LIST				
Blinks	Failure Codes	Contents	Causes	Symptoms
06	P0120	Faulty TPS	<ul style="list-style-type: none"> • Faulty TPS voltage range (0.3 - 4.5 V) • Loose or poor connection on TPS Sensor • Open or short circuit on the TPS wire • Faulty TPS itself. 	Engine operates normally
09	P0105	Faulty MAP	<ul style="list-style-type: none"> • Faulty MAP voltage range (1 - 4.2 V) • Loose or poor connection on MAP Sensor • Open or short circuit on MAP wire • Faulty MAP itself 	Engine operates normally
12	P0115	Faulty WTS (water temp.)	<ul style="list-style-type: none"> • Faulty ECT Ω range (-20°C: 18.8 Ω/40°C: 1.136 Ω/100°C: 0.1553 Ω) • Loose or poor connection on ECT • Open or short circuit on ECT wire • Faulty ECT 	Engine operates normally
15	P1630	Faulty Tilt switch (Roll)	<ul style="list-style-type: none"> • Faulty Tilt switch voltage range (inclined angle <65°: 0.4 - 1.4 V/ Inclined angle >65°: 3.7 - 4.4 V) • Loose or poor connection on Tilt switch • Open or short circuit in Tilt switch wire • Faulty tilt switch 	Engine operates normally
17	P0130	Faulty O ² sensor	<ul style="list-style-type: none"> • Faulty O² sensor voltage range (A/F below 14.7: > 0.7V/ A/F over 14.7: < 0.18 V) • Loose or poor connection on O² sensor • Open or short circuit on O² sensor wire • Faulty O² sensor 	Engine operates normally
33	P0201	Faulty injector (Nozzle)	<ul style="list-style-type: none"> • Faulty Fuel injector Ω range (9.945 - 13.5 Ω) • Loose or poor connection on injector • Open or short circuit on injector wire • Faulty fuel injector 	Engine fails to be operated

37	P0351	Faulty inductive ignition coil	<ul style="list-style-type: none"> • Faulty Inductive ignition coil Ω range ($4.2 \Omega \pm 15\%$) • Loose or poor connection on inductive ignition coil • Open or short circuit on inductive ignition coil wire • Faulty inductive ignition coil 	Engine fails to be operated
41	P0230	Faulty fuel pump	<ul style="list-style-type: none"> • Faulty Fuel pump fl range (F: $1100 \pm 33 \Omega$ E: $100 + 3 \Omega$) • Loose or poor connection on fuel pump • Open or short circuit on fuel pump wire • Faulty fuel pump 	Engine fails to be operated
43	-	Radiator fan relay	<ul style="list-style-type: none"> Open radiator fan relay Detached coupler 	Engine operates normally
45	P0135	Faulty O ² sensor heater	<ul style="list-style-type: none"> • Faulty O² sensor heater Ω range ($6.7 - 9.5 \Omega$) • Loose or poor connection on O² sensor heater • Open or short circuit on O² sensor heater wire • Faulty O² sensor heater 	Engine starts normally but not smooth
49	P1505	Faulty ISC	<ul style="list-style-type: none"> • Loose or poor contacts on ISC • Open or short circuit in ISC wire • Faulty ISC 	Engine operates normally
66	P0335	Faulty CPS	<ul style="list-style-type: none"> • Loose or poor connection on CPS sensor • Open or short circuit on CPS wire • Faulty CPS sensor 	Engine starts normally but not smooth

Axle/Brakes/Wheels

Item	Standard mm (in)	Service Limit
Axle shaft runout	—	0.2 mm (0.008 in)
Brake disk thickness (front)	3.8 - 4.2 (0.15 - 0.165)	0.3 mm (0.012 in)
Brake disk thickness (rear)	5.0 (0.2)	—
Brake disk runout	—	0.4 mm
Brake master cylinder I.D.	12.7 - 12.74 (0.508 - 0.5096)	—
Brake master cylinder piston O.D.	12.65 - 12.68 (0.506 - 0.5072)	—
Front brake caliper piston O.D.	26.93 - 26.96 (1.0602 - 1.0614)	—
Front brake caliper cylinder I.D.	27 - 27.05 (1.063 - 1.065)	—

Item	Standard (mm)
Wheel rim runout service limit	max 5
Rear brake disk thickness	5.0
Rear brake disk runout	max 0.4
Rear brake caliper piston O.D.	25.33 - 25.36
Rear brake caliper cylinder I.D.	25.40 - 25.45

Electrical

Item		Standard	
Battery	Capacity		12V 10AH
	Voltage (20°C)	Fully charged	13.2V
		Insufficient charged	< 12.3V
	Charging current		1.2A* 5 - 10H
Item		Standard	
Spark plug	Standard type	NGKCR7E	
Spark plug gap		0.6 - 0.7 mm	
Inductive Ignition Coil	Primary coil	3.57 - 4.83 Ω	
	Secondary coil without plug cap	10.42 - 14.49 KΩ	
Throttle Position Sensor		3500 - 6500 Ω	
Fuel Pump		1.9 Ω approx.	
Fuel Injector		11.7 ± 0.6 Ω	
Water Temperature Sensor		2.076 KΩ ± 10% (25°C)	
Oxygen Sensor (engine warming condition)		6.7 Ω - 9.5 Ω	
Crank Position Sensor		115 Ω ± 15 Ω	
Tilt Switch		0.4V - 1.4V(normal) 3.7V - 4.4V (fall down)	

Water temperature sensor resistance	At -20°C/-4°F	18.8 KΩ
	At 40°C/104°F	1.136 KΩ
	At 100°C/212°F	0.1553 KΩ

Item	Standard	Service Limit
Starter motor brush length	12.5 mm	8.5 mm

Torque Specifications

ENGINE					
Item	Qty	Thread size (mm)	Torque		Remarks
			kgf-m	lb-ft	
Cylinder head stud bolt:					
1. Stud bolt (Inlet pipe side)	2	6	0.7-1.1	5.06-7.96	Double end bolt
2. Stud bolt (EX pipe side)	2	8	0.7-1.1	5.06-7.96	Double end bolt
Cylinder head stud nut	4	10	3.4-3.8	24.59-27.48	
Right crankcase cover bolt	15	6	1.0-1.4	7.23-10.13	
Left crankcase cover bolt	15	6	1.0-1.4	7.23-10.13	
Transmission case bolts	9	8	0.8-1.2	1.7-2.6	
Bolt B stud 10*180	4	10	1.0-1.4	7.23-10.13	Apply oil to thread
Valve adjusting lock nut	4	5	0.7-1.1	5.06-7.96	Apply oil to thread
Cam sprocket bolt	2	6	1.0-1.4	7.23-10.13	Apply thread lock
Camshaft set plate bolt	1		1.2	2.0	Apply thread lock
Final drive oil check\drain bolt	2	8	0.8-1.2	5.79-8.68	
Engine oil drain bolt	1	12	2.0-3.0	14.47-21.70	
Engine oil strainer cap	1		1.02	7.2	
Clutch outer nut (driven pulley)	1	12	5.0-6.0	36.17-43.40	
Starter motor mounting bolt	2	6	1.0-1.4	7.23-10.13	
Mission case bolt	6	8	1.8-2.2	13.02-15.91	
Drive face nut	1	14	9.0-10.0	65.10-72.33	Apply oil to thread
Clutch drive plate nut	1		7.5	55.32	
Drive plate comp	1	28	5.0-6.0	36.17-43.40	
Cam chain tensioner bolt	2	6	1.0-1.4	7.23-10.13	
Cam chain tensioner pivot	1	8	0.8-1.2	5.79 - 8.68	
Oneway clutch bolt	3	8	1.8-2.2	13.02-15.91	Apply thread lock
ACG flywheel nut	1	14	5.5-6.5	39.78-47.01	
Spark plug	1	12	1.5-2.0	10.84-14.47	
Water pump impeller	1	7	1.0-1.4	7.23-10.13	Left thread
Water pump cover bolts	4	6	1.0-1.4	7.23-10.13	

FRAME							
-------	--	--	--	--	--	--	--

No.	ITEM	THREAD SIZE AND TYPE	TORQUE		Kgf-m	REMARK	THREAD DWG NO.	
			Kgf-m	N-m				
1	STEERING							
	HANDLE POST	M10x1.25	4.0~5.0	40~50	4.5	U NUT	90106-GEN5-9000	
	BRIDGE BOLT	M8x1.25	2.4~3.0	24~30	2.7	—	95801-08040-08	
	STEM LOCK	BC1	6.0~6.5	60~65	6.3	—	50306-1F96-0010	
	RACE NUT(HEAD)	BC1	1.8~2.2	18~22	2.0	—	53220-LBA2-E000	
2	WHEEL							
	FR. AXLE	M14x1.5	1.5~2.5	15~25	2.0	—	44301-LEA7-E000	
	RR. AXLE NUT	M16x1.5	11~13	110~130	12	U NUT	90305-KFW6-9120-M1	
3	SUSPENSION							
	FR FORK BOLT	M8x1.25	2.0~2.6	20~26	2.3	—	96700-KED9-9000	
	RR. CUSH. UP	M10x1.25	3.5~4.5	35~45	4.0	—	95801-10035-00	
	RR. CUSH. LWR	M10x1.25	3.5~4.5	35~45	4.0	—	95801-10035-00	
4	BRAKE							
	FR CALIPER	M10x1.25	3.0~4.0	30~40	3.5	—	90122-LEA7-E000	
	RR CALIPER	M10x1.25	3.0~4.0	30~40	3.5	—	90122-LEA7-E000	
	BRK OIL BOLT	M10x1.25	3.0~4.0	30~40	3.5	—	90145-MS9-6120-M	
	M/C HOLDER	M6x1.0	1.0~1.4	10~14	1.2	—	96001-06028-06	
	M/C CAP SCREW	M4x0.7	0.12~0.2	1.2~2.0	0.16	—	96000-04012-1A	
	C/P BLEEDER	M8x1.25	0.4~0.7	4.0~7.0	0.55	—	4335A-LBA2-E100	
	DISK BOLT	M8x1.25	3.2~3.8	32~38	3.5	—	90105-LEA7-E000	
5	ENG HANGER							
	FRAME SIDE	M14x1.5	6.0~7.0	60~70	6.5	U NUT	90106-LKF5-E000	
	ENG SIDE	M10x1.25	4.5~5.5	45~55	5.0	U NUT	90304-GHE8-0040	
6	MUFFLER							
	EXH. PIPE	M8x1.25	1.8~2.2	18~22	2.0	—	90033-GFY6-9000	
	MUFF. BRKT/RR FORK	M10x1.25	3.5~4.5	35~45	4.0	FLANGE BOLT	90131-LKG7-E000	
7	RR FORK/ENG CASE	M10x1.25	3.0~4.0	30~40	3.5	—	95801-10060-06	
8								
	SPDMT SENSOR CABLE	M6x1.0	1.0~1.4	10~14	1.2	—	96001-06012-06	
	IGN COIL	M6x1.0	1.0~1.4	10~14	1.2	—	94050-06080	
	O2 SENSOR	M12x1.25	2.0~3.0	20~30	2.5	—	—	
	MAIN STAND	M10x1.25	3.0~4.0	30~40	3.5	U NUT	90304-LEA1-9000	
	RR CARRIER	M8x1.25	2.0~2.8	20~28	2.4	—	90106-KKC4-9000	

General Torque Specifications

Item	Torque	
	kgf-m	lb-ft
5 mm bolt, nut	0.45 - 0.6	3.25 - 4.34
6 mm bolt, nut	0.8 - 1.2	5.79 - 8.68
8 mm bolt, nut	1.8 - 2.5	13.02 - 18.08
10 mm bolt, nut	3.0 - 4.0	21.70 - 28.93
12 mm bolt, nut	5.0 - 6.0	36.17 - 43.40
5 mm screw	0.45 - 0.6	3.25 - 4.34
6 mm screw, SH bolt	0.7 - 1.1	5.06 - 7.96
6 mm flange bolt, nut	1.0 - 1.4	7.23 - 10.13
8 mm flange bolt, nut	2.4 - 3.0	17.36 - 21.70
10 mm flange bolt, nut	3.0 - 4.5	21.70 - 32.55

Troubleshooting

Vehicle can not be started

Preliminary 6 Step Inspection

1. Is the battery fully charged (12 V or higher). See the [Battery](#) topic for more information.
2. Key-On and listen for any action with Fuel Pump / Fuel Pump Relay (It will turn off automatically in 5-10 seconds)
3. Key-On to check for any failure lamp light up on dashboard. See the [Self-Diagnosis](#) topic for more information.
4. Is the Idle screw of Throttle Valve being changed or loose?
5. Has the vehicle under regular service? Is the gas station a good one?
6. Is the spark plug the correct model of specified by the vehicle builder? See the [Spark Plug](#) topic for more information.

General Troubleshooting

ENGINE WILL NOT START OR IS HARD TO START

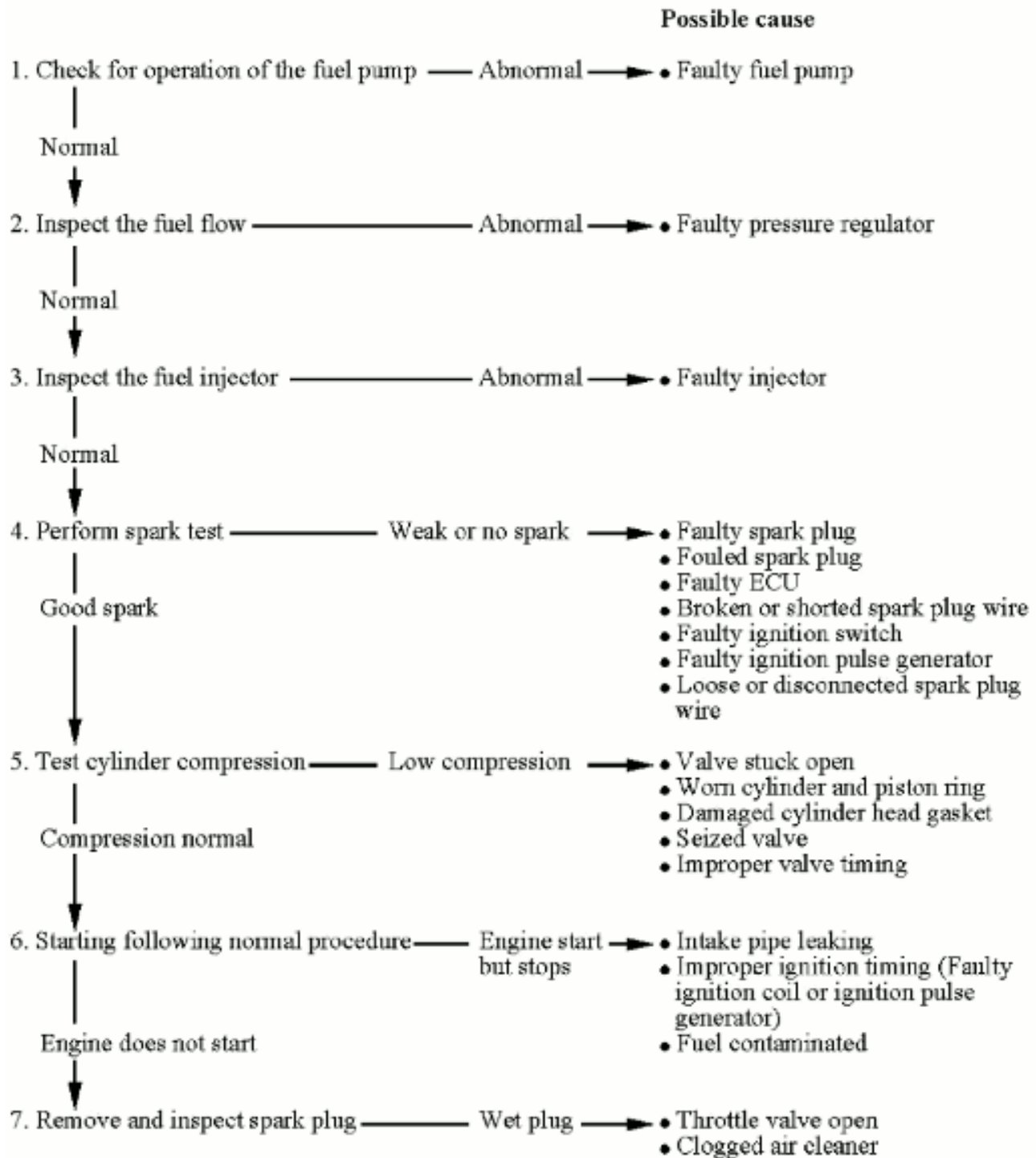

ENGINE LACKS POWER

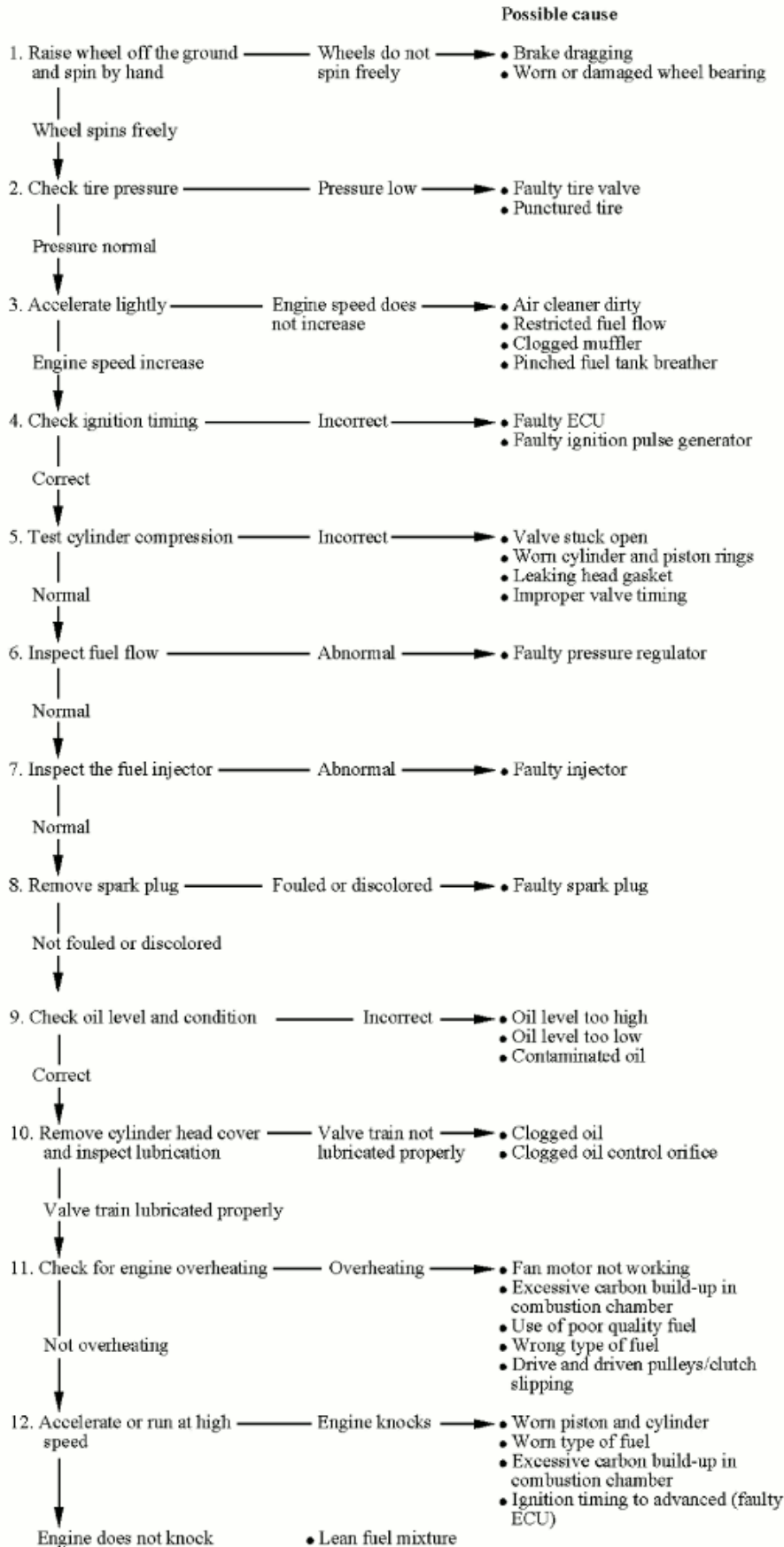

POOR PERFORMANCE AT LOW AND IDLE SPEED

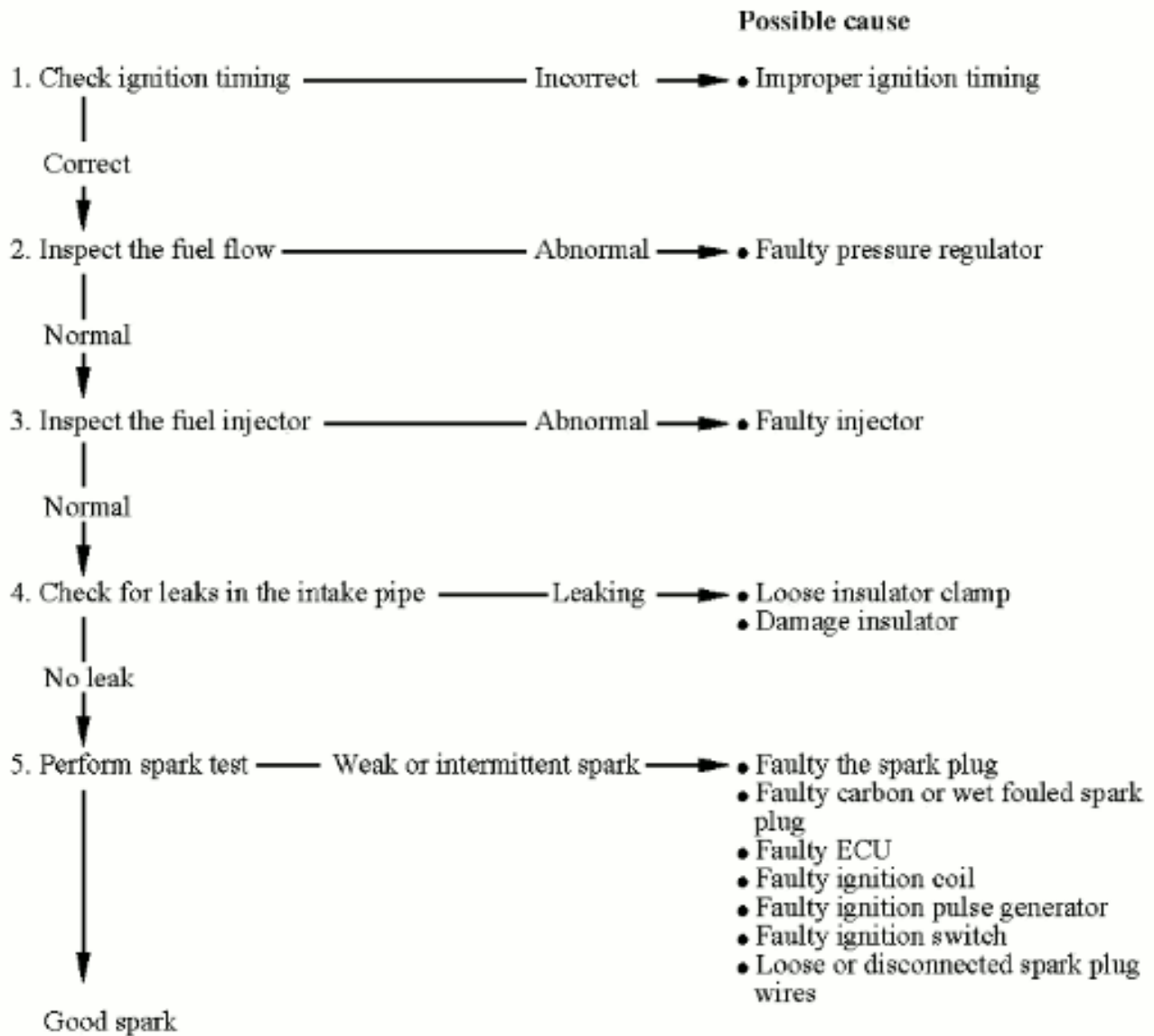

POOR PERFORMANCE AT HIGH SPEED

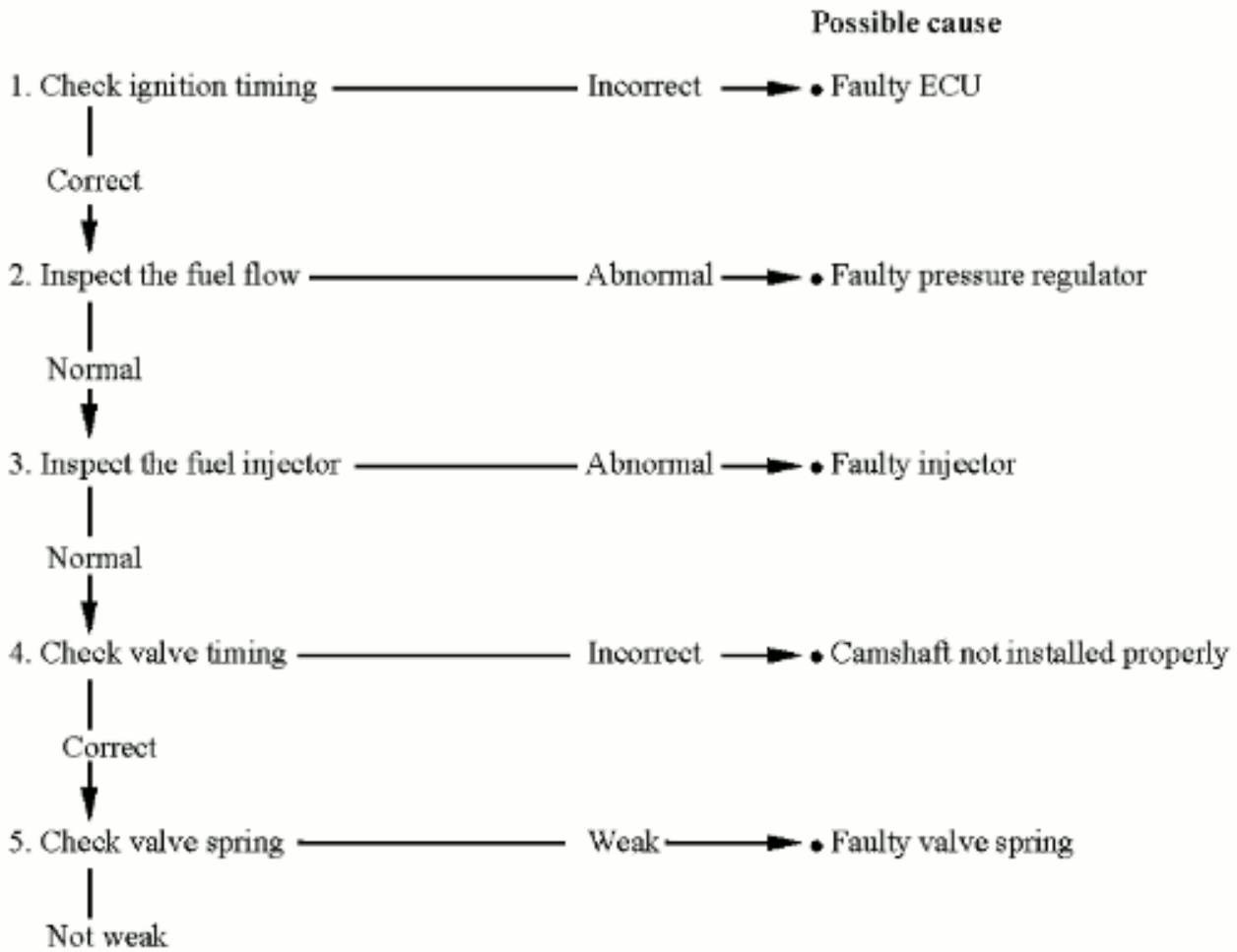

POOR HANDLING

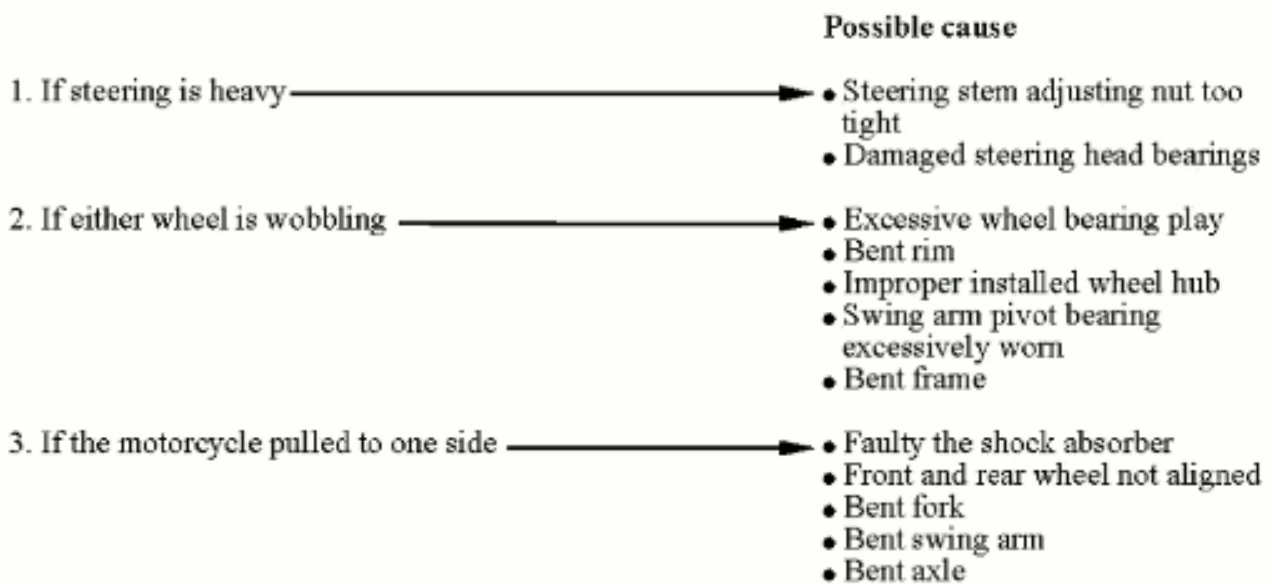

VIN and Engine Number Location

Identification Numbers Record

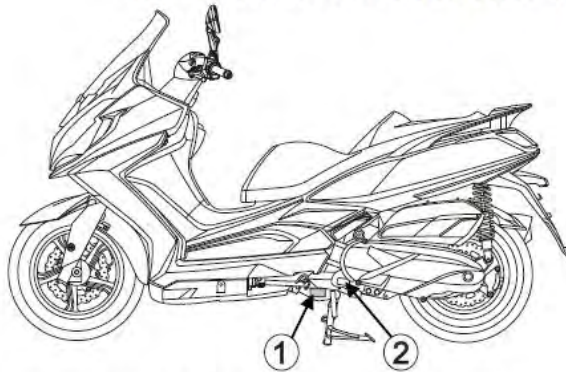

1. VEHICLE IDENTIFICATION NUMBER (VIN)

2. ENGINE SERIAL NUMBER (ESN)

3. FRAME SERIAL NUMBER (VIN)

Record the Vehicle Identification Number ①, Engine Serial Number ② and Frame Serial Number ③ in the boxes above for future reference (to assist you in ordering parts from your authorized KYMCO dealer or for reference in case the vehicle is stolen).

2.Periodic Maintenance

This chapter covers the periodic maintenance for the KYMCO Downtown 350i.

<u>Maintenance Schedule</u>	2-2
<u>Air Filter Servicing</u>	2-4
<u>Brake Fluid</u>	2-6
<u>Brake Inspection</u>	2-13
<u>Engine Compression Test</u>	2-15
<u>Coolant Level Check</u>	2-17
<u>Engine Oil</u>	2-21
<u>General Lubrication</u>	2-36
<u>Hose Inspection</u>	2-37
<u>Side Stand</u>	2-38
<u>Spark Plug</u>	2-40
<u>Steering</u>	2-43
<u>Suspension</u>	2-44
<u>Throttle Free Play</u>	2-46
<u>Tires</u>	2-52
<u>Final Drive Oil</u>	2-54
<u>Valve Clearance</u>	2-60

WARNING:

- Before running the engine, make sure that the working area is well ventilated. Never run the engine in a closed area. The exhaust contains poisonous carbon monoxide gas, which may cause death to people.
- Gasoline is extremely flammable and is explosive under some conditions. The working area must be well ventilated and do not smoke or allow flames or sparks near the working area or fuel storage area.

Maintenance Schedule

Perform the pre-ride inspection (Owner's Manual) at each scheduled maintenance period. This interval should be judged by odometer reading or months, whichever comes first.

Maintenance schedule legend

I: INSPECT AND CLEAN, ADJUST, LUBRICATE OR REPLACE IF NECESSARY

C: CLEAN

R: REPLACE

A: ADJUST

L: LUBRICATE

The maintenance schedule specifies the maintenance required to keep your DOWNTOWN 350i scooter in peak operating condition. Maintenance work should be performed in accordance with KYMCO standards and specifications by properly trained and equipped technicians. Your KYMCO dealer meets all of these requirements.

* Should be serviced by your KYMCO dealer, unless you have the proper tools, service data and are technically qualified.

** In the interest of safety, we recommend these items be serviced only by your KYMCO dealer. KYMCO recommends that your KYMCO dealer road test your scooter after each periodic maintenance service is completed.

FREQUENCY	WHICHEVER COMES FIRST	ODOMETER READING							
		X 1000 km	1	5	10	15	20	25	30
ITEM		X 1000 mi	0.6	3	6	9	12	15	18
		MONTH	1	6	12	18	24	30	36
*	Air Filter Servicing			R	R	R	R	R	R
	Spark Plug			I	R	I	R	I	R
*	Throttle Free Play			I	I	I	I	I	I
*	Valve Clearance			I	A	I	A	I	A
*	Hose Inspection				I		I		I
	Hose Inspection		C	C	C	C	C	C	C
*	Engine Oil		R	R	R	R	R	R	R
*	Engine Oil			C	R	C	R	C	R
*	Engine Oil		R	R	R	R	R	R	R
*	Fuel Injection Diagnostic Tool				I		I		I
*	Final Drive Oil		R	R	R	R	R	R	R
*	CVT Removal			I	I	I	I	I	I
*	CVT Removal				I		I		I
*	DRIVE BELT			I	I	I	R	I	I
	Brake Fluid			I	R	I	R	I	R
	Brake Pad Replacement			I	I	I	I	I	I
	Brakes			I	I	I	I	I	I
*	Switches			I	I	I	I	I	I
	Steering			I	I	I	I	I	I
*	Lights			I	I	I	I	I	I
*	Torque Specifications			I	I	I	I	I	I
**	Wheels/Tires			I	I	I	I	I	I
	Coolant Level Check			I	R	I	R	I	R

Air Filter Servicing

SAFETY FIRST: Protective gloves and eyewear are recommended at this point.

Replace the air filter according to the [Maintenance Schedule](#), and more often in exceptionally rainy or dusty areas.

Removal



Remove the 8 air filter cover screws with a #2 Phillips screwdriver.

Remove the air filter cover.

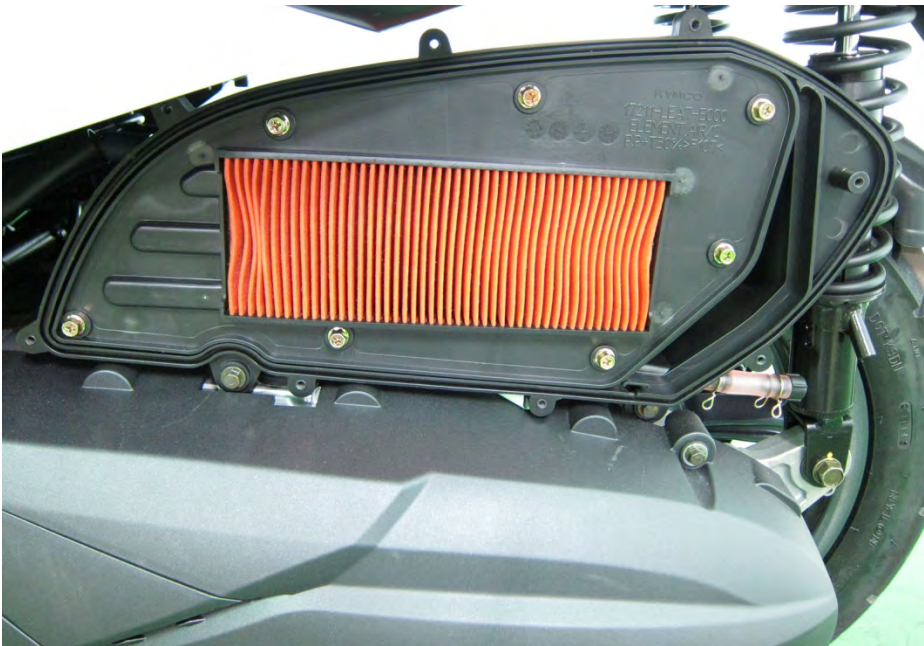

Remove the 7 air filter bolts with an 8 mm socket or a #2 Phillips screwdriver.

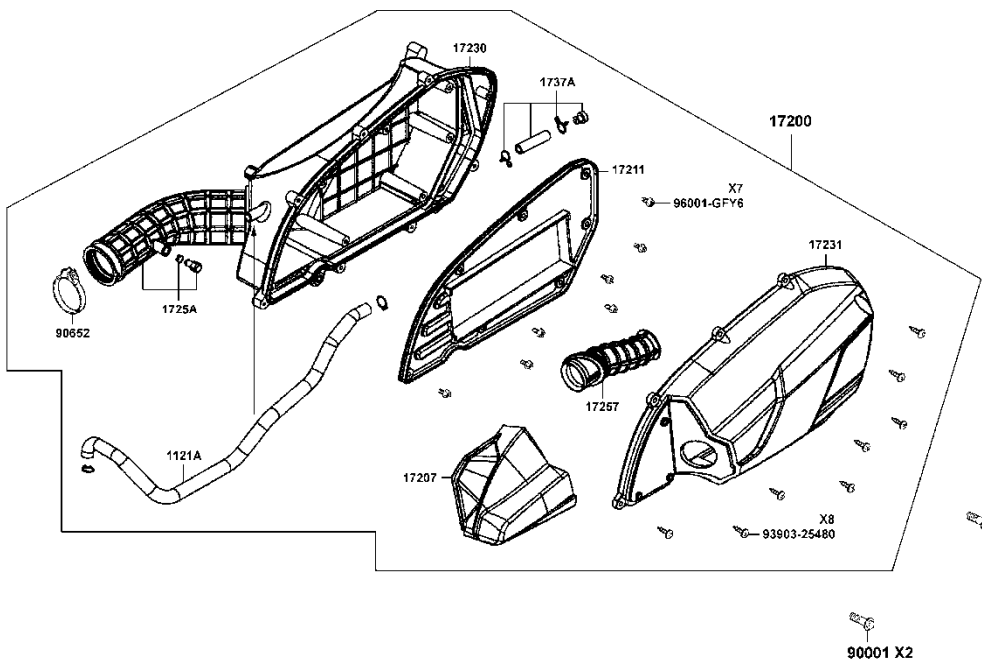

Remove the air filter from the airbox. Discard the air filter in favor of a new item.

Caution:

- The air cleaner element has a viscous type paper element. Do not clean it with compressed air.
- Be sure to install the air cleaner element and cover securely.

Brake Fluid

The KYMCO Downtown 350i uses DOT 4 brake fluid that should be inspected after 3,000 mi (5,000 km) of use. It should be flushed and bled every 12 months, 6,000 mi (10,000 km), whenever the brakes feel spongy, or if the brake system has been taken apart and rebuilt. Always use fresh brake fluid from a tightly sealed container.

SAFETY FIRST: Protective gloves and eyewear are recommended at this point.

Warning: Brake fluid is very caustic and can damage paint, chrome and plastic. Wipe up any spills immediately.

Inspection



Turn the handlebars until the top of the master cylinder reservoir is level with the ground. Do this for both master cylinder reservoirs and check the level of brake fluid.

Draining

The brake bleeding process is the same for the front and rear brakes.



Remove the two master cylinder cover screws with a #2 Phillips head screwdriver.



Remove the cylinder cover.



Remove the master cylinder cover, plastic piece and rubber diaphragm. Clean and inspect the rubber diaphragm for tears or other damage. Replace as necessary.



Pull off the rubber cap over the bleeder valve and crack open the bleeder valve on the brake caliper using an 8 mm wrench. This valve is usually very tight so use a box end wrench or a 6 point socket and ratchet to prevent rounding off the head. Snug the bleeder valve back down.



Open the valve and remove the old brake fluid with a Mighty -Vac or a similar device.

Bleeding



Place a length of 6 mm inside diameter clear hose on the bleeder valve and place the other end in a suitable container. A spare battery vent hose works well for this job.



Fill the brake fluid with the proper type from a fresh, newly opened container.

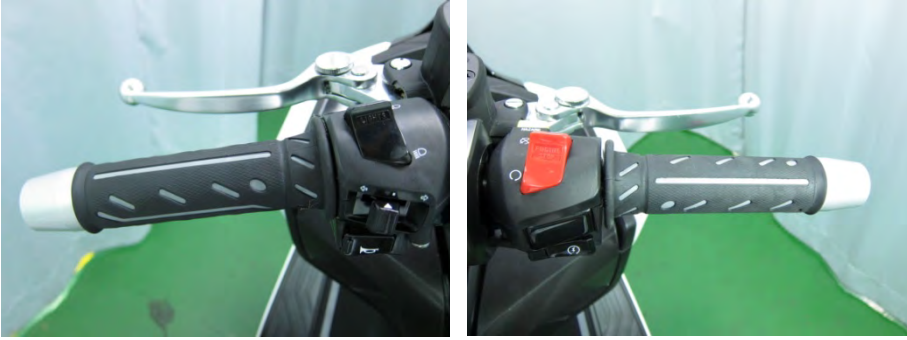

Pump the brake lever several times and hold the lever in. While holding the lever in, crack open the bleeder valve. The front brake lever will travel all the way to the grip and brake fluid and/or air will come out of the bleeder valve into the 6 mm hose. Tighten the bleeder valve before releasing the front brake lever. Pump the lever several times again and repeat the process.

Be certain to check the master cylinder reservoir occasionally to make sure the reservoir doesn't run dry. Add more brake fluid as necessary. Continue this process until clean brake fluid comes out of the bleeder valve and there are no air bubbles. The brake lever should feel firm.

Tighten the bleeder valve to specification and push its rubber cover over the nipple.

(Air Bleeder Valve Torque: 7.5 N-m or 5.5 lb-ft)



Make sure the reservoir has the proper amount of fluid.



Place the rubber diaphragm, plastic piece and cover over the reservoir.



Thread in the reservoir cover screws and tighten them securely with a #2 Phillips screwdriver.

Check the function of the brakes before operating the machine.

Brake Inspection

SAFETY FIRST: Protective gloves and eyewear are recommended at this point.

Brake Lever Adjuster



There is adjuster on each brake lever. Each adjuster has four positions so that the released lever position can be adjusted to suit the rider's hands. To adjust the distance of the lever from the handlebar grip, push the lever forward and turn the adjuster knob to align the number with the arrow mark on the lever holder.

Brake lever adjusters

There is adjuster on each brake lever. Each adjuster has four positions so that the released lever position can be adjusted to suit the rider's hands.

To adjust the distance of the lever from the handlebar grip, push the lever ① forward and turn the adjuster knob ② to align the number with the arrow mark ③ on the lever holder.



■ **NOTE:** The distance from the grip to the released lever is at its closest at number 4 and the furthest away at number 1.



Brake Fluid

Brake Pad Wear

WARNING

For appropriate brake action, make sure the groove of the adjusting nut is aligned with the pin in the brake arm.

Inspect the brake pad and shoe thickness to verify there is enough material for the brakes to function properly.

1. If the wear indicator grooves in the front brake pads are no longer visible  , it is an indication that the brake pads are worn and require replacement.
2. If the wear indicator grooves in the rear brake pads are no longer visible  , it is an indication that the brake pads are worn and require replacement.

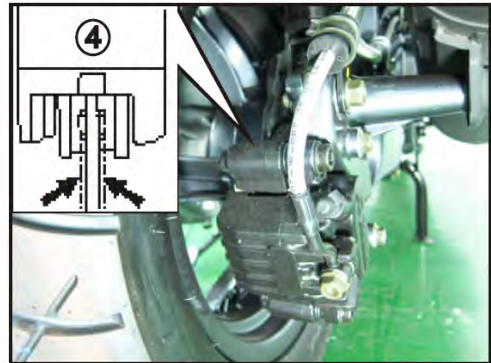
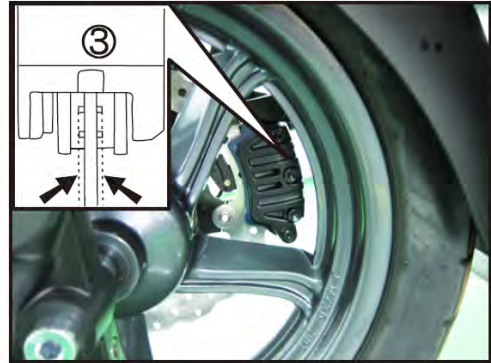

WARNING

The brakes will wear quickly if the lever is continually applied during riding (dragging the brake).
Consult your KYMCO dealer for braking system service.

Replace the pads if the brake wear exceeds the wear indicator lines or if the wear is uneven.

Note: Keep grease and oil off the brake discs to avoid brake failure.

Engine Compression Test

SAFETY FIRST: Protective gloves and eyewear are recommended at this point.

Remove the seat. See the [Seat](#) topic for more information.

Remove the luggage box. See the [Luggage Box](#) topic for more information.

Before testing the compression make sure the cylinder head bolts are tightened securely and the valve clearance is specification. See the [Cylinder Head](#) and [Valve Clearance](#) topics for more information.

Remove the spark plug. See the [Spark Plug](#) topic for more information.

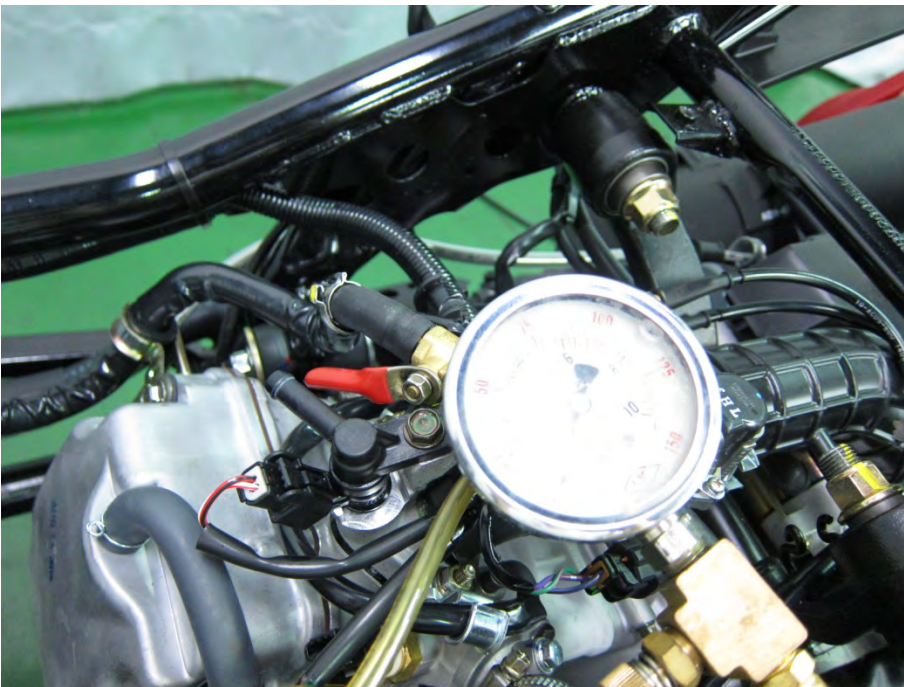

Thread a compression tester into the spark plug hole hand tight. Hold the throttle all the way open. Crank the engine with the starter motor until the needle on the gauge stops rising. Do not crank the engine more than a few seconds.

Cylinder compression	$12 \pm 2 \text{ kg/cm}^2$
----------------------	----------------------------

Low compression is an indication of excessive engine wear, possibly worn rings or poorly sealing valves, or maybe a tight valve with not enough valve clearance. High compression is possibly an indication of excessive carbon buildup on the piston or performance modifications.

Install the spark plug. See the [Spark Plug](#) topic for more information.

Install the luggage box. See the [Luggage Box](#) topic for more information.

Install the seat. See the [Seat](#) topic for more information.

Coolant Level Check

SAFETY FIRST: Protective gloves and eyewear are recommended at this point.

SAFETY FIRST: Antifreeze is highly toxic and can kill pets and animals if drunk. Do not leave coolant where animals (including children!) can get to it.

Inspection

Start the engine and bring it up to operating temperature.
Place the scooter on level ground and up on its center stand.

The coolant reserve tank is under the left floorboard.



Remove the left floorboard.



Remove the engine coolant lid screw with a #2 Phillips. And remove the engine coolant lid.



Open the coolant reserve tank lid. Siphon the coolant out of the reserve tank with an appropriate suction device. If a suction device is unavailable remove the reserve tank and pour it out. See the [Radiator](#) topic for more information.

Coolant level inspection

The reserve tank is under left floorboard .Check the coolant level through the inspection window 1 at the left side skirt white the engine is at the normal operating temperature , with the scooter In an upright position.

If the coolant level is below the LOWER level mark 3 ,remove the left floor mat ,remove the lid screw 4 ,the reserve tank lid 5 ,and then the reserve tank cap 6 to add coolant mixture until it reaches the upper level mark 2 .

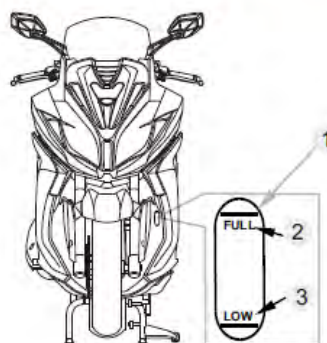

⚠ WARNING

Add coolant to the reserve tank only. Do not attempt to add coolant by removing the radiator cap. Coolant in the radiator is under pressure and is very hot and can cause serious burns.



Remove the engine coolant reserve tank cover.



Open the coolant reserve tank lid.



Add coolant to the tank until it reaches the upper level mark.

Note: Do not add coolant through the radiator cap.

For more information on the engine coolant see the [Coolant](#) topic.

Engine Oil

SAFETY FIRST: Protective gloves and eyewear are recommended at this point.

Caution: Hot engine oil can burn. Avoid letting used motor oil contact exposed skin.

TROUBLESHOOTING

Oil level too low

1. Natural oil consumption
2. Oil leaks
3. Worn or poorly installed piston rings
4. Worn valve guide or seal

Poor lubrication pressure

1. Oil level too low
2. Clogged filter or oil passages
3. No use the specified oil

Oil Specifications

Use a fully synthetic quality 4-stroke engine oil to ensure longer service life of the scooter. Only use oils that have a SJ rating above per the API service classification.

Engine oil viscosity : SAE 5W-50

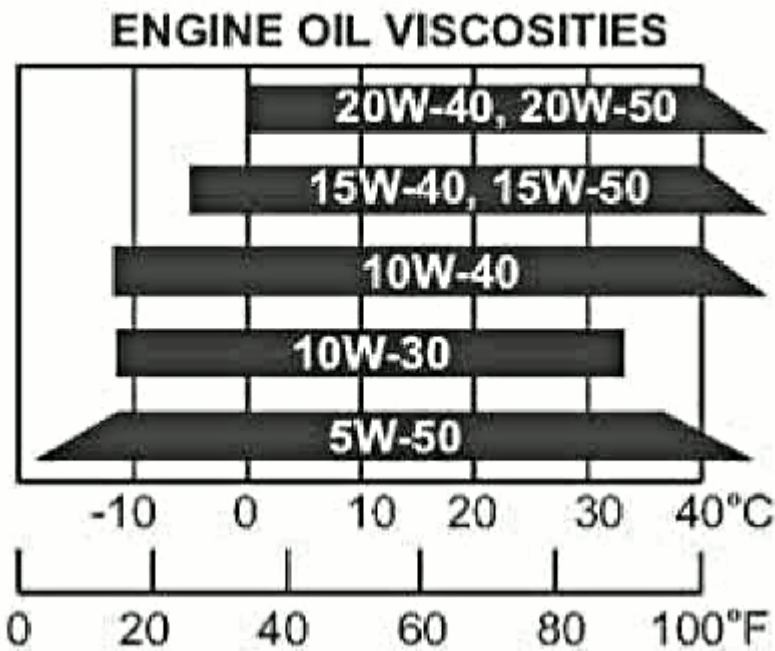

If these viscosities are not available, select an alternative engine oil according to the chart shown above.

Engine oil capacity	
At disassembly	1.5 Liter
At change	1.3 Liter

Inspection

Oil Level

Check the engine oil level each day before operating the scooter.

Place the motorcycle upright on level ground for engine oil level check. Run the engine for 2 ~ 3 minutes and check the oil level after the engine is stopped for 2 ~ 3 minutes.



The oil filler cap/dipstick is located on the right side of the engine.

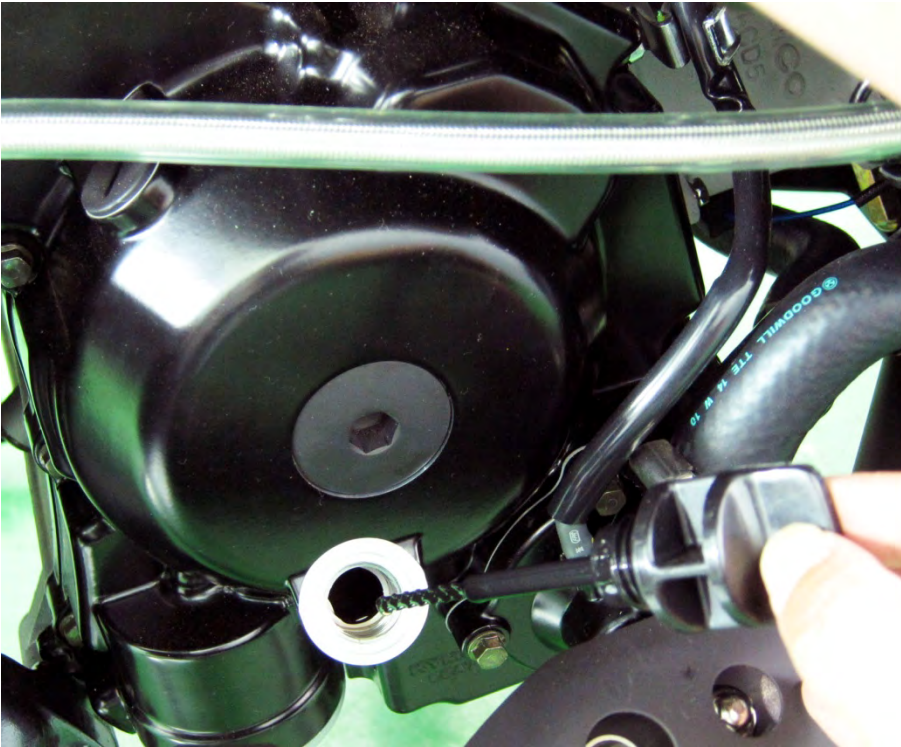

Remove the oil filler cap/dipstick and wipe off the oil. Inspect the O-ring and replace it as needed. Insert the dipstick in without threading it in. Remove the dipstick and check the oil level.

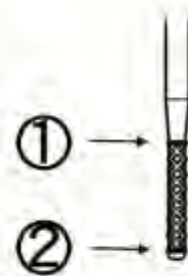

The level must be maintained between the upper (1) and lower level (2) marks on the oil filler cap/dipstick.



If the oil level is at or below the lower mark add more of the same type and brand of oil to the engine through the oil filler hole. If the oil level is too high remove the drain plug and the excess oil.

Servicing

Draining

Warm the engine as with the inspection, this will heat the engine and allow the oil to drain out faster and more completely. The vehicle should be on level ground. Stop the engine.

Caution: Hot engine oil can burn. Avoid letting used motor oil contact exposed skin.



Place an oil pan under the engine. The oil drain bolt is located on the left side of the engine.



Loosen the engine oil drain bolt with a 17 mm socket. Remove the bolt and allow the oil to drain into the pan.



Discard the old sealing washer.

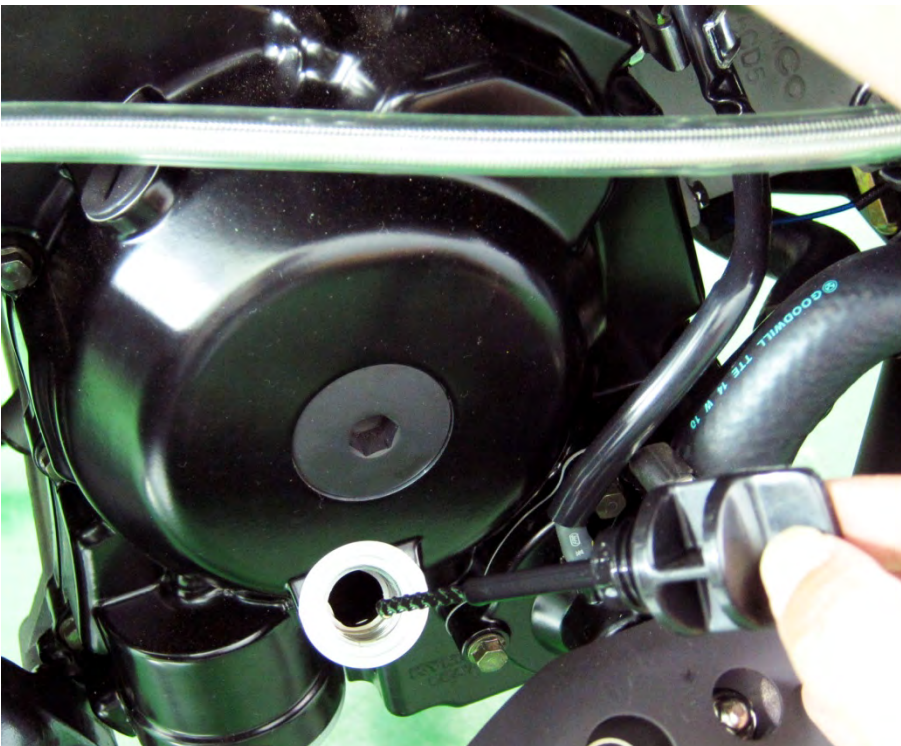

Remove the oil filler cap to allow for faster oil draining. Inspect the oil filler cap O-ring and replace it as needed.



When the oil has drained completely Install the drain bolt with a new sealing washer. Tighten the drain bolt to specification with a 17 mm socket.

Item	Qty	Torque		Remarks
		kgf-m	lb-ft	
Oil Drain bolt	1	2.5	18.08	New sealing washer

Strainer Screen



Remove the oil strainer screen bolt with a 17 mm socket. Inspect the strainer screen bolt O-ring and replace it as needed.



Remove the oil strainer screen.



Remove the O-rings from the oil strainer screen and inspect them. Replace the O-rings if they are in poor condition. Inspect the oil strainer screen for debris and damage. Clean it with a high flash point solvent and compressed air. Metal debris in the strainer screen can be an indicator of engine wear or damage.

NOTE: Always wear safety glasses when using compressed air and never point it directly at yourself or anyone else.



Return the O-rings to the oil strainer screen and install it into the left side of the engine. Tighten the oil strainer screen cap to specification with a 17 mm socket.

Item	Qty	Torque	
		kgf-m	lb-ft
Engine oil strainer cap	1	1.02	7.2

Filter Replacement



The oil filter compartment is located on the bottom of the engine below the oil filler cap/dipstick. Ready an oil drain pan to catch any remaining engine oil.



Loosen the oil filter cap with a 24 mm socket.



Remove the oil filter cap with spring and take out the used oil filter.



Inspect the oil filter cap O-ring and spring. Replace the items if they are in poor condition.



Install the spring to the oil filter cap. Apply a light coat of engine oil to the oil filter cap O-ring.



Pour a small amount of fresh engine oil into the oil filter. Insert the oil filter into place with the rubber seal side facing up.



Install the oil filter cap with spring. Make sure the spring fits against the filter correctly. Tighten the oil filter cap securely with a 24 mm socket.

Item	Qty	Torque	
		kgf-m	lb-ft
Engine oil filter cap	1	1.0	7.2

Filling

Add the oil to the engine through the oil filler/dipstick hole.



Use a fully synthetic quality 4-stroke engine oil to ensure longer service life of the scooter. Only use oils that have a SJ rating above per the API service classification.

Engine oil viscosity : SAE 5W-50

Engine oil capacity	
At disassembly	1.5 Liter
At change	1.3 Liter

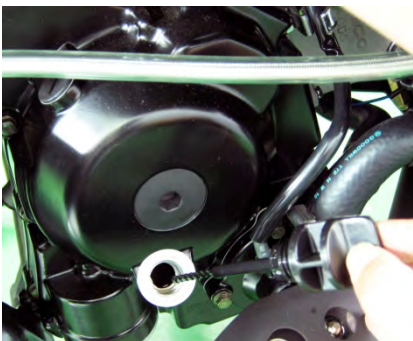

Install the oil filler cap. Start the engine and let it run for several minutes. Check for any oil leaks. Stop the engine and check the [Engine Oil](#).

General Lubrication

SAFETY FIRST: Protective gloves and eyewear are recommended at this point.

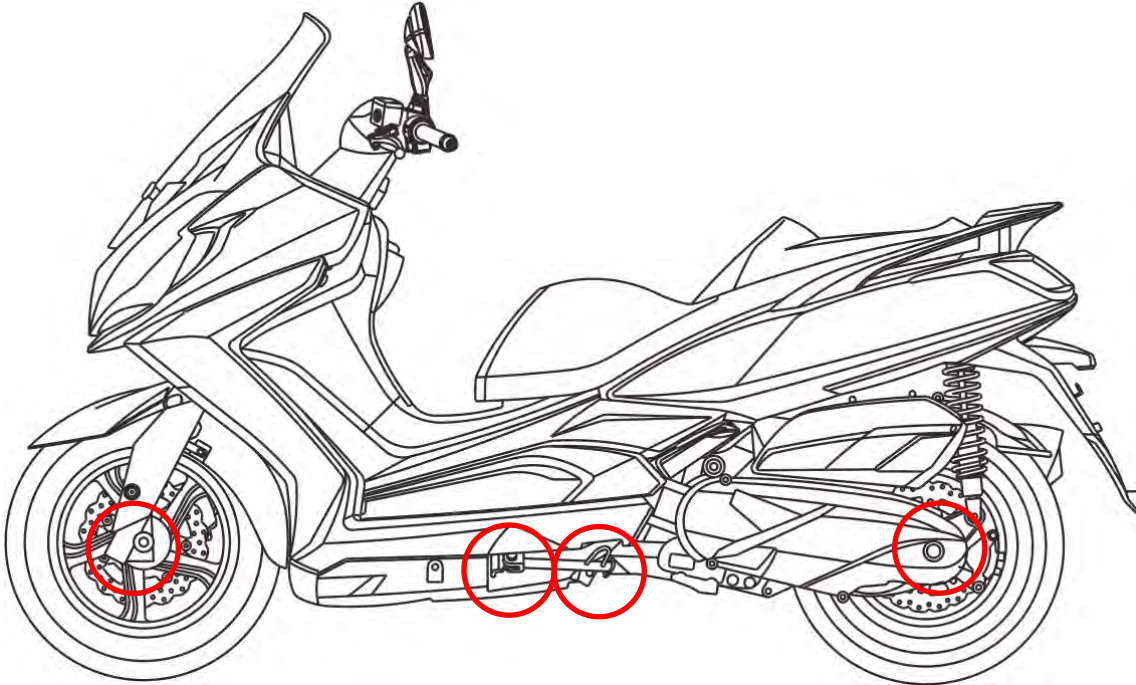

The frame lubrication points are listed below. Use general purpose grease. Apply clean engine oil or grease to cables and movable parts not specified. This will avoid abnormal noise and increase the durability of the motorcycle.

- Front Wheel Axle
- Side Stand Pivot
- Center Stand Pivot
- Rear Wheel axle

Hose Inspection

Remove the seat. See the [Seat](#) topic for more information.

Remove the luggage box. See the [Luggage Box](#) topic for more information.



Inspect the breather hose for damage and deterioration.

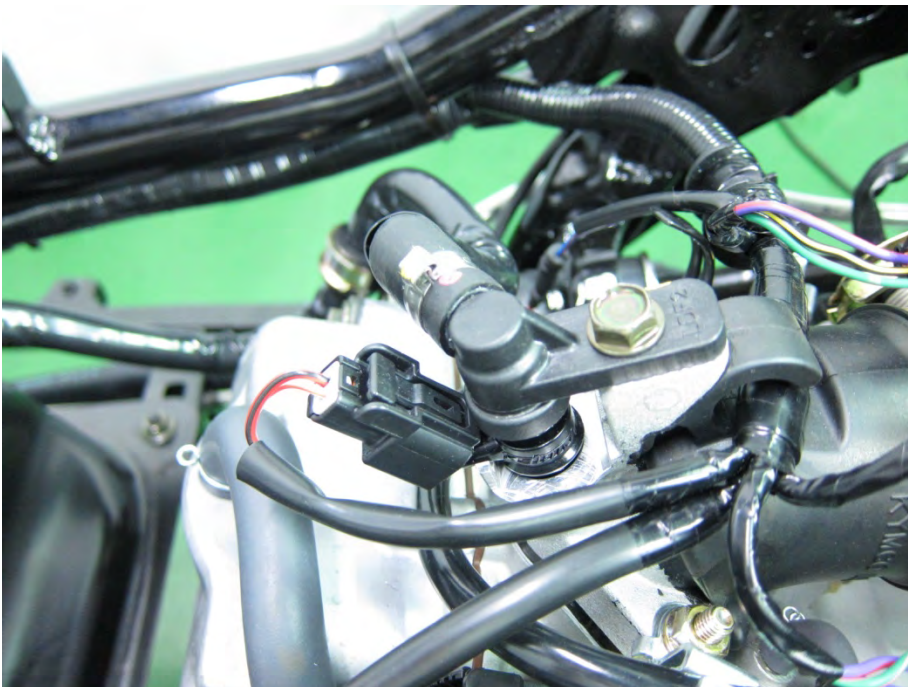

Inspect the fuel hose for damage and deterioration.

Side Stand

SAFETY FIRST: Protective gloves and eyewear are recommended at this point.

Interlock Function Check



Your scooter's side stand is not only necessary when you park, but it contains an important safety feature. This feature cuts-off the ignition if you try to ride the scooter when the side stand is down. Perform the following side stand inspection.



Check the side stand ignition cut-off system;

1. Place the scooter on its center stand.
2. Put the side stand up and start the engine.
3. Lower the side stand.
4. The engine should stop as you put the side stand down.

Note: If the side stand system does not operate as described, see your KYMCO dealer for service.

Spark Plug

SAFETY FIRST: Protective gloves and eyewear are recommended at this point.

Removal

Remove the seat. See the [Seat](#) topic for more information.

Remove the luggage box. See the [Luggage Box](#) topic for more information.

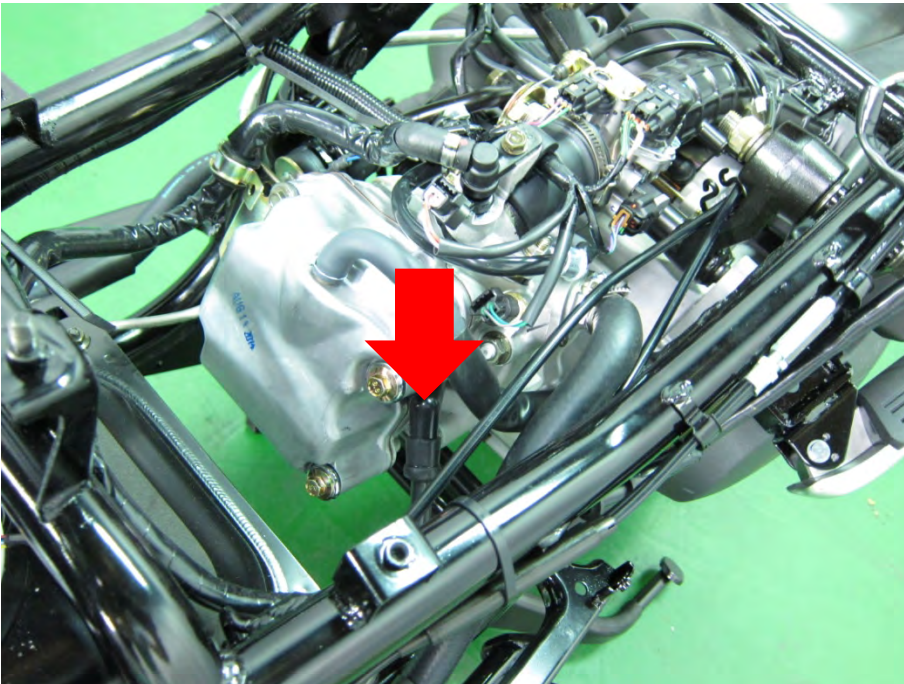

The spark plug is located on the left side of the cylinder.

remove the spark plug wire off of the spark plug.

Clean off the area surrounding the spark plug with compressed air or a shop towel to make sure debris doesn't get into the combustion chamber when the spark plug is removed.

NOTE: Always wear safety glasses when using compressed air and never point it directly at yourself or anyone else.



Remove the spark plug with a spark plug with a 5/8 in socket.

Spark plug	NGKCR7E
------------	---------

Inspection



Always check the gap of the spark plug before installation. If the gap needs to be adjusted bend the ground electrode carefully. Inspect the color of the porcelain nose of the spark plug. The color of the spark plug can indicate how the mixture is burning. A white colored plug shows a lean mixture, where a dark plug shows a rich mixture. Do not hesitate to replace a spark plug. Always replace a spark plug if any part of it is damaged.

Spark plug gap	0.6 - 0.7 mm
----------------	--------------

Installation

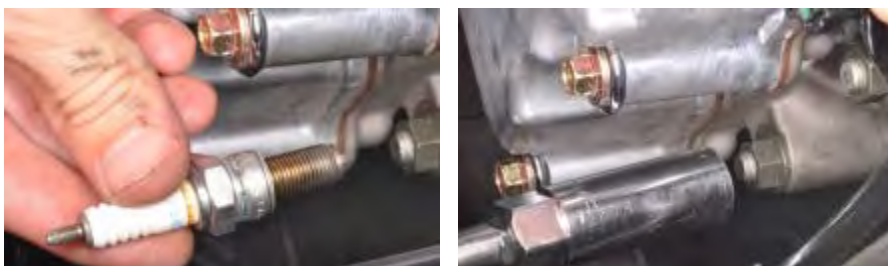

Thread the spark plug by hand before using a socket to tighten. Torque to specification with a 5/8" spark plug socket. Do not over tighten the spark plug. The cylinder head is made out of soft metal, and it can be easily damaged.

Item	Torque
Spark plug	17.2 N-m (1.5 - 2 ft-lb, 10.84 - 14.47 kgf-m)

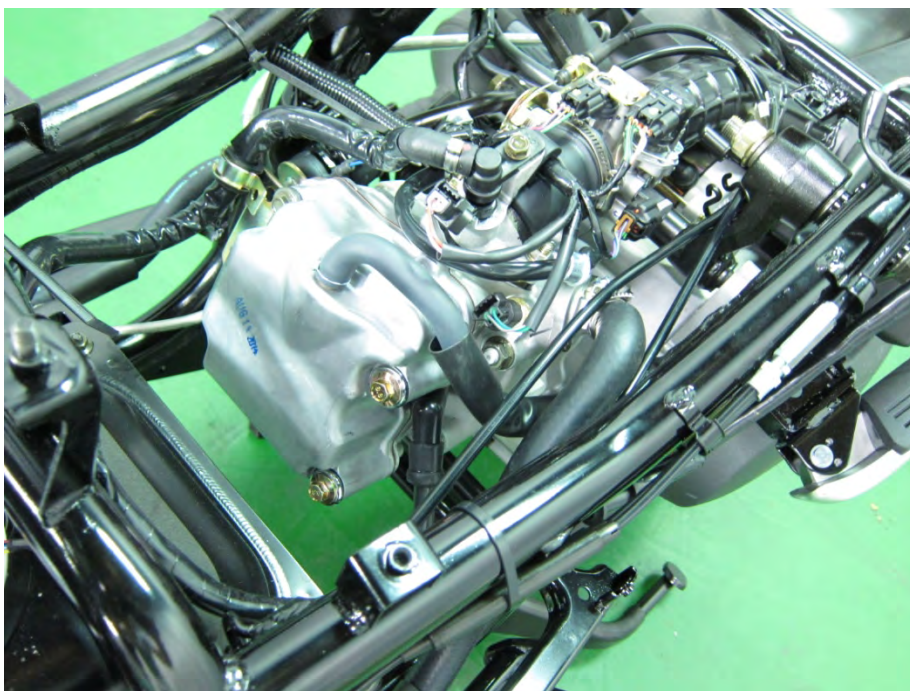

Install the spark plug wire over the plug.

Install the luggage box. See the [Luggage Box](#) topic for more information.

Install the seat. See the [Seat](#) topic for more information.

Steering

SAFETY FIRST: Protective gloves and eyewear are recommended at this point.

Inspection

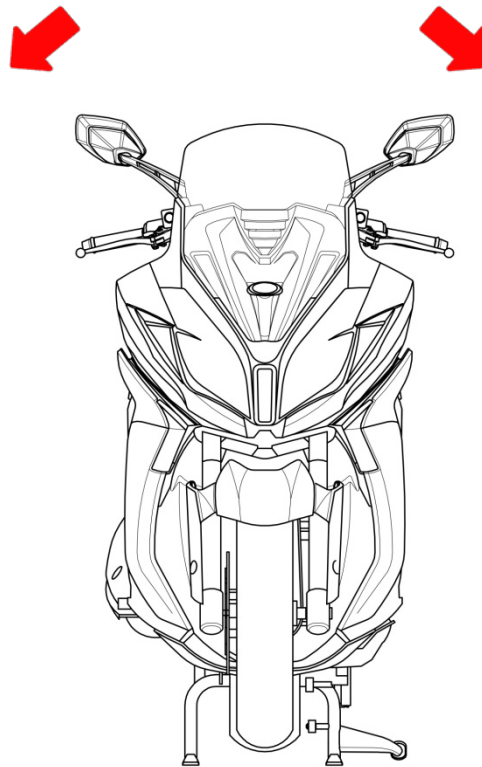

Raise the front wheel off the ground and check that the steering handlebar rotates freely. If the handlebar moves unevenly, binds, or has vertical movement, adjust the steering head bearing. See the [Steering Stem Removal](#) topic for more information.

Suspension

SAFETY FIRST: Protective gloves and eyewear are recommended at this point.

Front Suspension

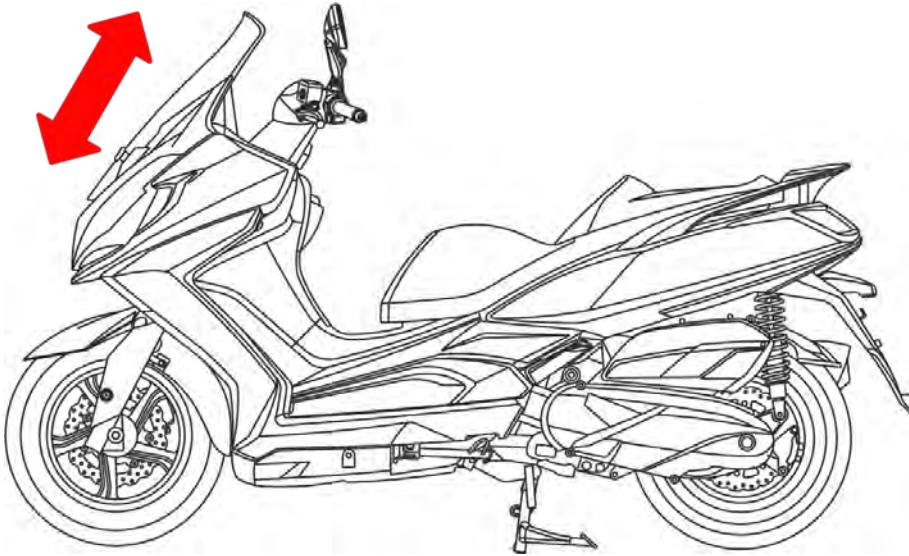

Check the action of the front shock absorbers by compressing them several times. Check the entire shock absorber assembly for oil leaks, looseness or damage.

Pre-Load Setting

Suspension

Each shock absorber ⑨ on your scooter has 5 spring preload adjustment positions for different load or riding conditions.

Use a pin spanner ⑩ to adjust the rear shock spring preload. Position 1 is for light loads and smooth road conditions. Position 3 to 5 increase spring preload for a stiffer rear suspension and can be used when the scooter is heavily loaded. Be certain to adjust both shock absorbers to the same spring preload positions.

Standard spring preload position: 3

CAUTION

Always adjust the shock absorber pre-load position in sequence (1-2-3-4-5 or 5-4-3-2-1). Attempting to adjust directly from 1 to 5 or 5 to 1 may damage the shock absorber.



Each shock absorber on the scooter has 5 spring preload adjustment positions for different load or riding conditions.

Position 1 is for light loads and smooth road conditions. Position 3 to 5 increase spring preload for stiffer rear suspension and can be used when the scooters heavily loaded. Be certain to adjust both shock absorbers to the same spring preload positions.

Throttle Free Play

SAFETY FIRST: Protective gloves and eyewear are recommended at this point.

Inspection

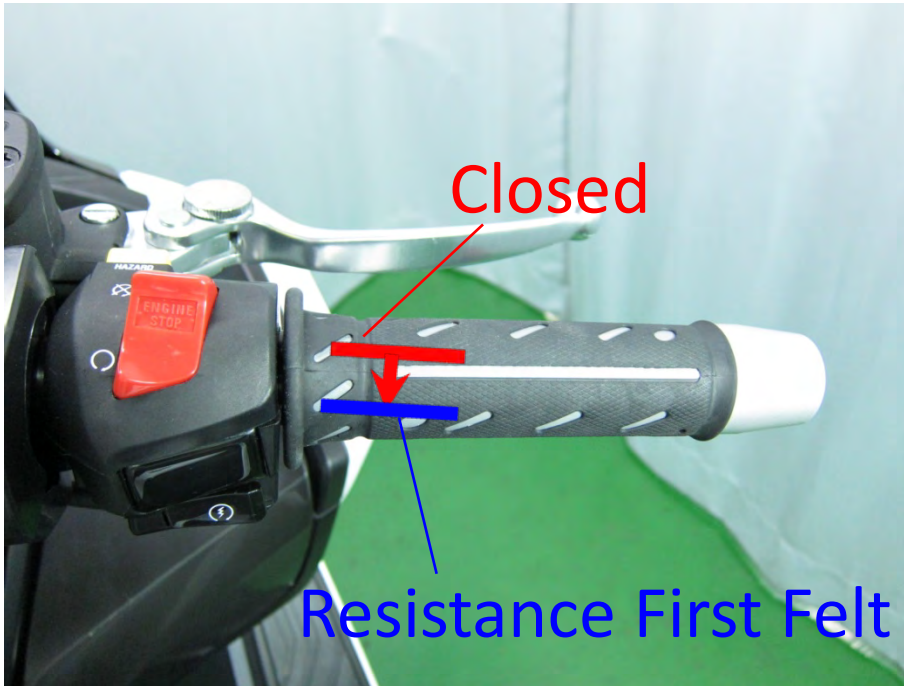

Check the throttle cable free play by gently rotating the throttle grip back until resistance is felt.

Throttle grip free play	2 ~ 6 mm
-------------------------	----------

Make sure the throttle moves smoothly and returns on its own. Start the engine and let it warm up. Turn the handlebars from side to side, if the engine rpm changes either the free play is too small or the throttle cables are not routed properly. Check and correct the cause.

Major adjustment

Major adjustment of the throttle grip free play is made with the adjusting nut at the throttle body side.

Remove the seat. See the [Seat](#) topic for more information.

Remove the luggage box. See the [Luggage Box](#) topic for more information.

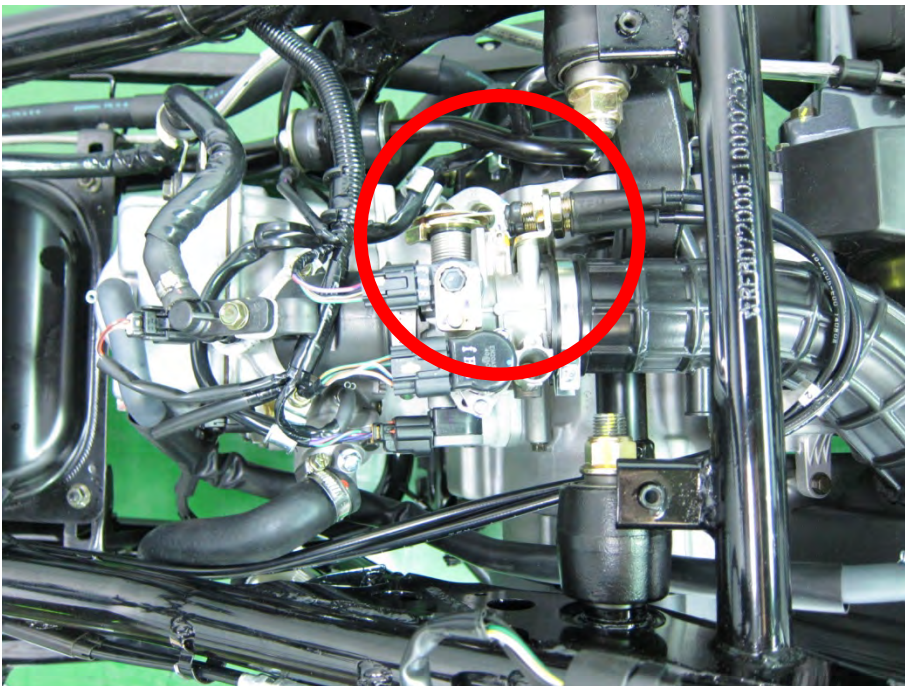

The throttle cables meet the throttle body on the right side.

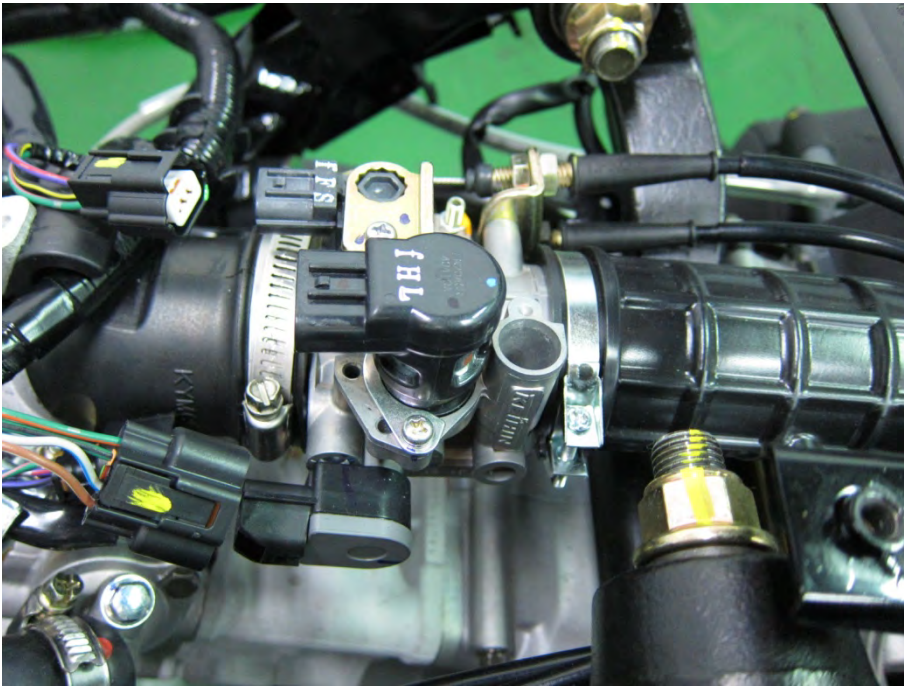

The top throttle cable is the opening cable and the bottom is the closing cable.

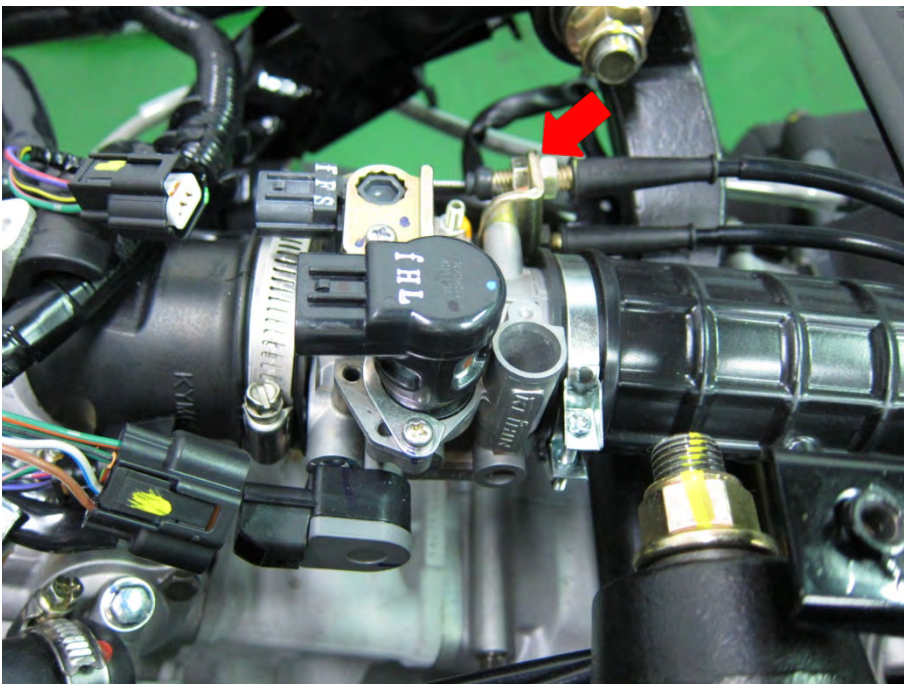

Loosen the lock nut (forward) with a 12 mm wrench.



Turn the adjuster nut (rear) to adjust the throttle free play.

When the free play has been moved into specification hold the adjuster in place and tighten the locknut securely. Adjust the closing cable as needed for a proper throttle action.

Install the luggage box. See the [Luggage Box](#) topic for more information.

Install the seat. See the [Seat](#) topic for more information.

Minor Adjustment



Minor adjustments of the throttle free play can be made with the cable adjusters below the grip throttle.



Slide down the rubber cover.



Loosen the throttle cable adjuster lock nut with a 10 mm wrench.



Turn the adjuster with an 8 mm wrench to achieve the specified free play.

When the free play has been moved into specification hold the adjuster in place and tighten the locknut securely.



Slide the rubber cover over the adjuster and lock nut.
Inspect the throttle operation.

Tires

SAFETY FIRST: Protective gloves and eyewear are recommended at this point.

Check tires before each ride for wear and air pressure.



Check tire air pressure before riding when tires are cold.

Cold inflation tire pressure	Solo riding	Front	2.00 kg/cm ² (28.4 psi)
		Rear	2.25 kg/cm ² (32 psi)
	Dual riding	Front	2.00 kg/cm ² (28.4 psi)
		Rear	2.25 kg/cm ² (32 psi)



Replace tires if the tread depth reaches the wear mark or fails to meet the minimum tread depth.

Tires	Front wheel	120/80-14 58S
	Rear wheel	150/70-13 64S

Final Drive Oil

SAFETY FIRST: Protective gloves and eyewear are recommended at this point.

Place the scooter on level ground and up on its center stand.

The oil drain bolt and oil filler bolt are located on the transmission.

Gear oil type:	SAE 90
Gear oil capacity:	
At disassembly	0.23 Liter
At change	0.21 Liter

Draining

Place the vehicle on its center stand on level ground. Place a suitable oil drain pan under the transmission oil drain plug.

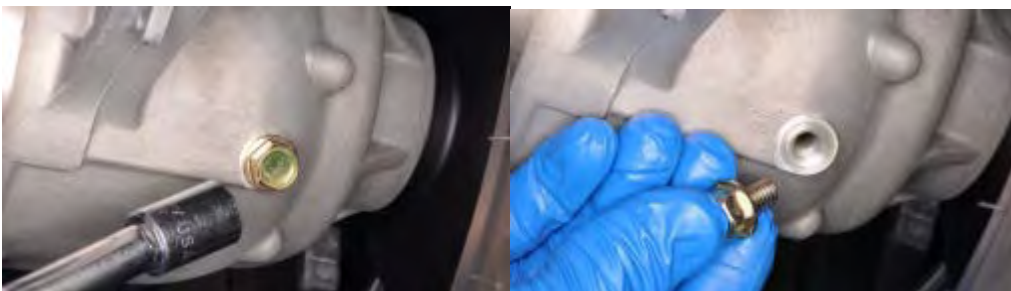
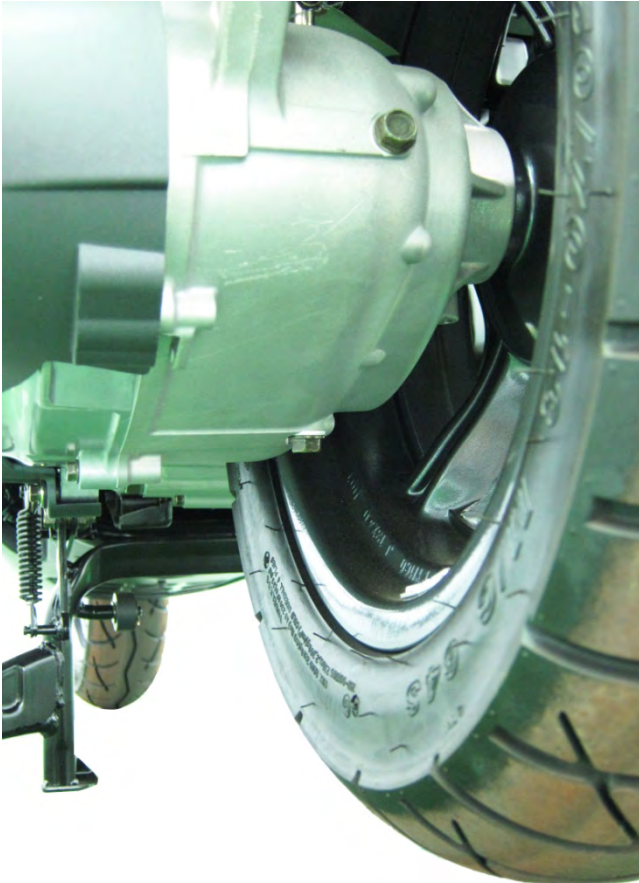

Remove the transmission oil level filler bolt with a 12 mm socket.



Place a suitable container under the drain plug to capture the final drive oil. Loosen the oil drain plug with a 12 mm socket. Remove the drain plug and slowly rotate the rear wheel to drain the transmission oil.

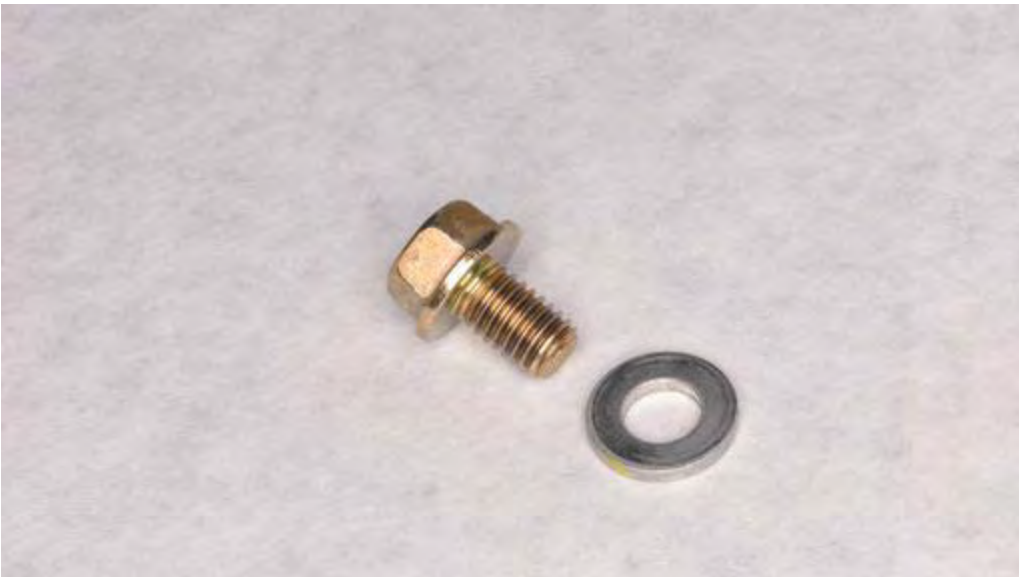

Inspect the drain plug and washer.



Install the oil drain plug and washer with a 12 mm socket. Tighten to specification.

Item	Qty	Thread size (mm)	Torque	
			kgf-m	lb-ft
Final drive oil drain bolt	1	8	0.8 - 1.2	5.79 - 8.68

Filling

Fill the final drive with the specified quantity of oil with a syringe.

Gear oil type:	SAE 90
Gear oil capacity:	
At disassembly	0.23 Liter
At change	0.21 Liter



Thread in the final drive oil level filler bolt.



Install the oil filler plug and torque it to specification with a 12 mm socket.

Item	Qty	Thread size (mm)	Torque	
			kgf-m	lb-ft
Final drive oil filler bolt	1	8	0.8 - 1.2	5.79 - 8.68

Valve Clearance

SAFETY FIRST: Protective gloves and eyewear are recommended at this point.

The valve clearance specification is only relevant if the engine is cold (below 35°C or 95°F).

Inspection

Remove the seat. See the [Seat](#) topic for more information.

Remove the luggage box. See the [Luggage Box](#) topic for more information.

Remove the spark plug. See the [Spark Plug](#) topic for more information.

Remove the cylinder head cover. See the [Cylinder Head Cover](#) topic for more information.

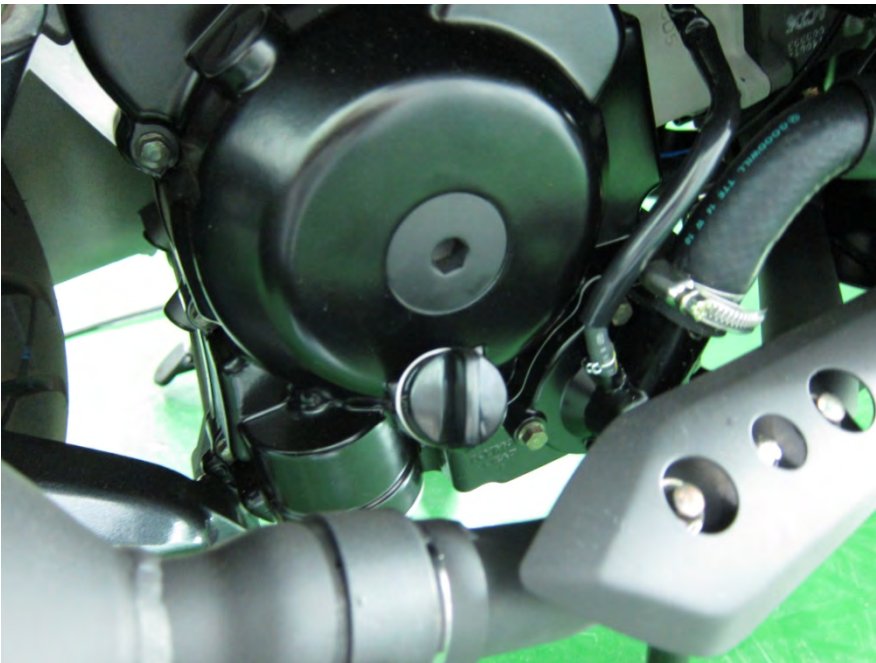

Remove the crankshaft cap on the right side of the engine with a large flat blade screwdriver. Inspect the O-ring on the cap and replace it as needed.

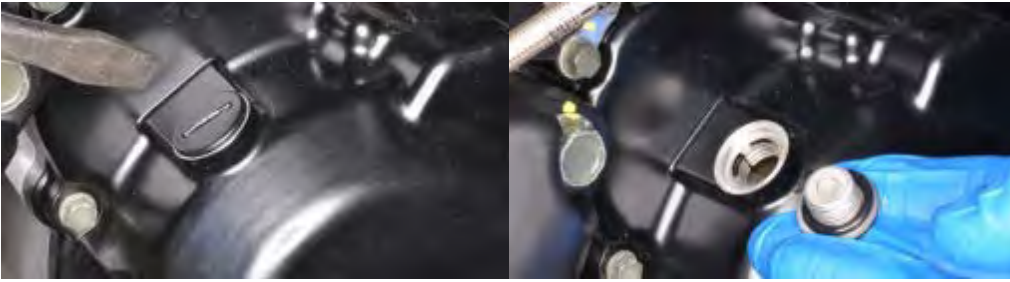

Remove the timing inspection cap from the right side of the engine with a large flat blade screwdriver. Inspect the O-ring on the cap and replace it as needed.

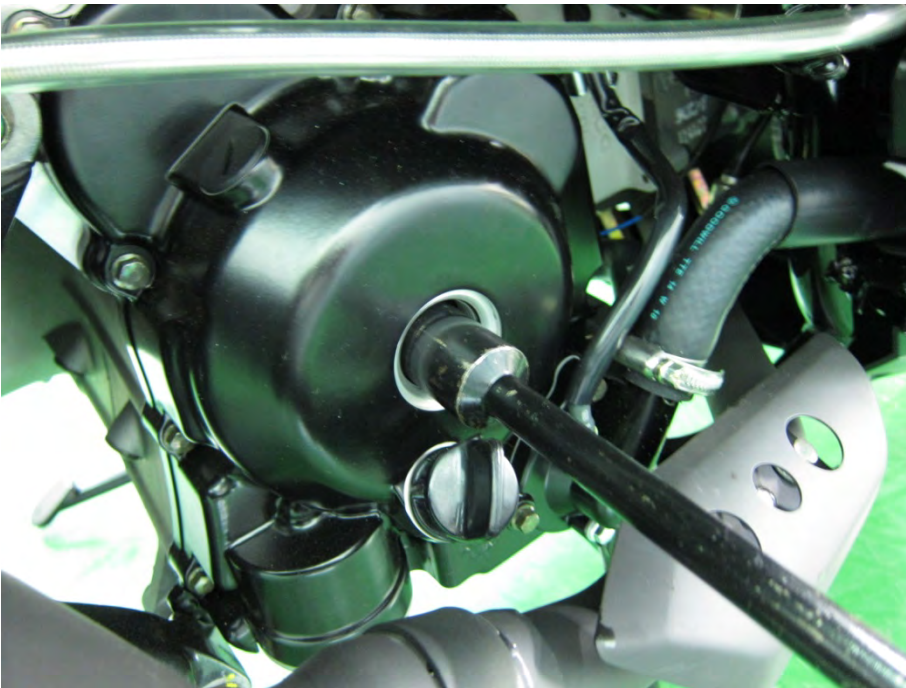

The crankshaft must be rotated (clockwise) until the piston is at top dead center (TDC) on the compression stroke.



Turn crankshaft clockwise until the "T" mark aligns with the index notch in the timing inspection hole.

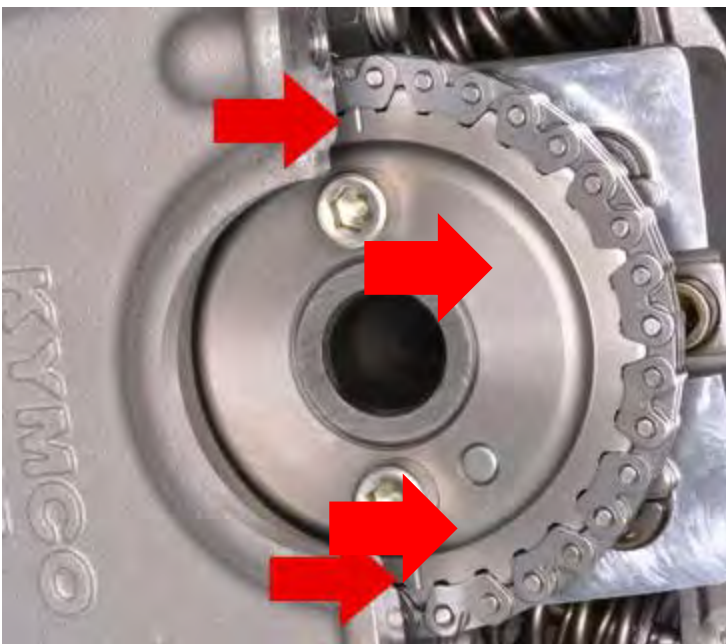

For correct engine timing the marks on the camshaft sprocket must be even with the cylinder head mating surface at the same time the "T" mark is lined up with the with the index notch in the timing inspection hole. Also the camshaft sprocket mounting boss should be visible above the cylinder head surface.

If this is not the case, rotate the crankshaft 360° clockwise until the "T" mark is once again aligned with the notch on the case cover.



Measure the valve clearance with a thickness feeler gauge. Insert the feeler gauge between the tappet adjusting screw and the valve stem. The clearance is correct when there is a light drag on the feeler gauge. The clearance is the same for the exhaust and intake valves. If the clearance is out of spec move on to the adjustment section.

Valve clearance	IN: 0.10 mm	EX: 0.10 mm
-----------------	-------------	-------------

Adjustment



Use a tappet adjuster tool to adjust the valves.

SPECIAL TOOLS		
ITEM	TOOL NO.	DESCRIPTION
TAPPET ADJUSTER	E012	Tappet adjustment



Place a 9 mm box end wrench over the locknut, and loosen the locknut. If the valve clearance is tight back out the valve tappet adjusting screw with the tappet adjustment tool. If the clearance is too loose turn in the adjusting screw until there is a light drag on the feeler gauge. Hold the adjusting screw locknut in place with the wrench to make sure it doesn't interfere with the adjustment.

Lubricate the tappet adjusting screw threads with fresh engine oil. Hold the adjuster in place and tighten the locknut. Always recheck the clearance after tightening the locknut. Also, recheck after turning the engine over and back to TDC on the compression stroke.

Item	Qty	Thread size (mm)	Torque		Remarks
			kgf-m	lb-ft	
Valve adjusting lock nut	4	5	0.7-1.1	5.06-7.96	Apply oil to thread



Make sure the O-rings on the crankshaft and timing plugs are in good condition. Replace them as needed. Install the timing inspection and crankshaft caps to the right side of the engine. Tighten the caps securely but not overly with a large flat blade screwdriver.

Install the cylinder head cover. See the [Cylinder Head Cover](#) topic for more information.

Install the luggage box. See the [Luggage Box](#) topic for more information.

Install the seat. See the [Seat](#) topic for more information.

3.External Components

This chapter covers the location and servicing of the external components for the KYMCO Downtown 350i model.

REAR PART

Seat3-3

Luggage Box3-7

Rear Carrier3-9

Rear Center Cover3-10

Body Cover3-11

Rear Inner Fender3-16

Rear Tire Fender3-17

Heat Shield3-18

Exhaust System3-20

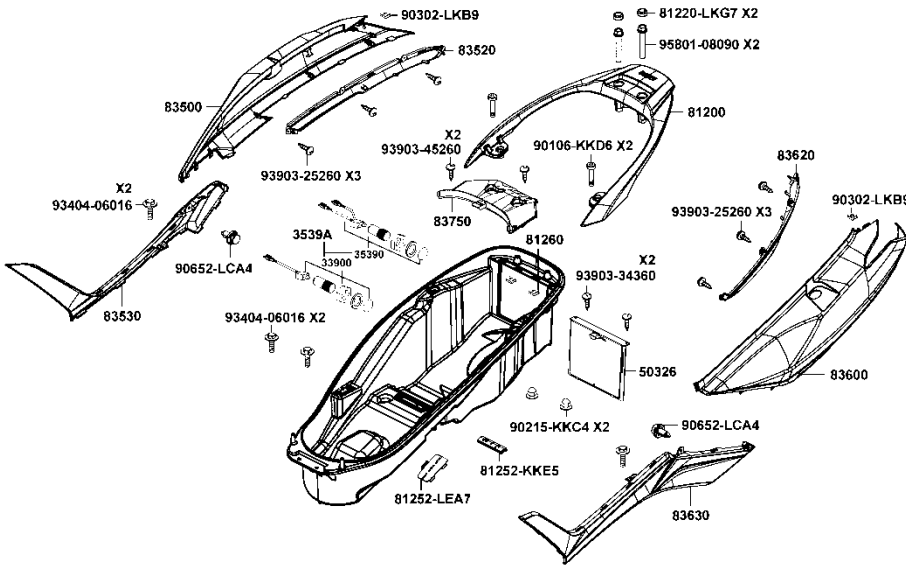

FRONT PART

Front Center Cover3-29

Front Cover3-30

Windshield3-31

Front Meter Cover3-32

Head Light Assembly3-33

Key Cover3-36

Dash Board.....3-38

Side Covers And Skirts3-40

Side Board A3-43

Side Board B3-45

Floor Panel3-47

Leg Shield.....3-49

Front Inner Fender3-51

Under Cover3-53

Front Tire Fender3-54

Handle Bar3-55

Handlebar Cover3-65

Stands.....3-69



General Instructions

- When removing frame covers, use care not to pull them by force because the cover joint claws may be damaged.
- Make sure to route cables and harnesses according to the Cable & Harness Routing.

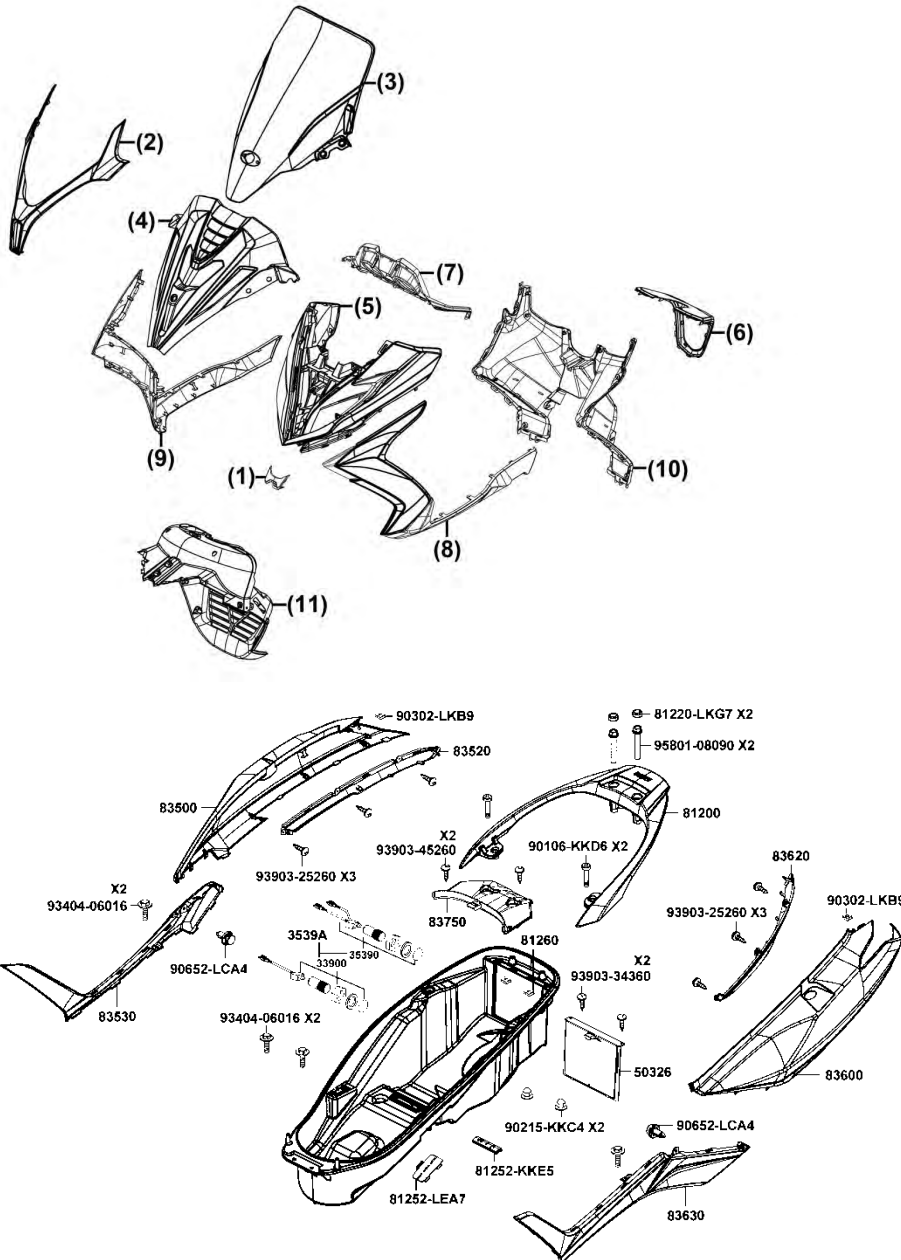

REAR PART

Seat

SAFETY FIRST: Protective gloves and eyewear are recommended at this point.

Removal



Insert the key and turn it counterclockwise .



Lift up the seat.



Remove the two piston pivot nuts with a 10 mm socket.



Lift off the piston pivot mounting plate.

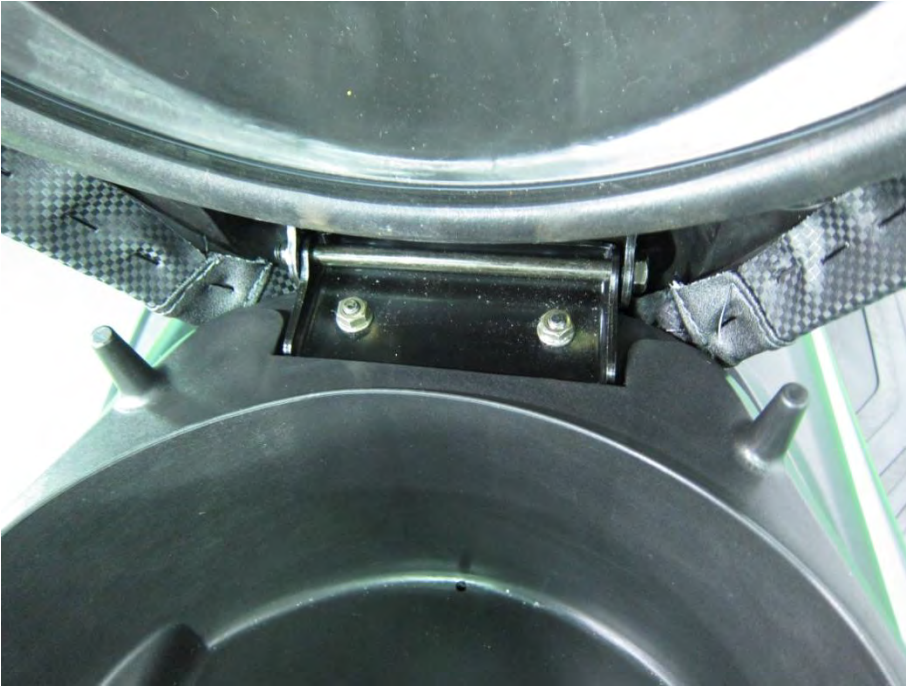

Remove the two seat hinge nuts with a 10 mm socket.



Remove the seat.

Seat Latch Cable



The seat latch cable runs from the ignition switch to the seat latches. The cable must be adjusted periodically so that the latches will open correctly. Open the seat.

Luggage Box

SAFETY FIRST: Protective gloves and eyewear are recommended at this point.

Removal

Remove the seat. See the [Seat](#) topic for more information.



Remove the two luggage bolts and nuts.

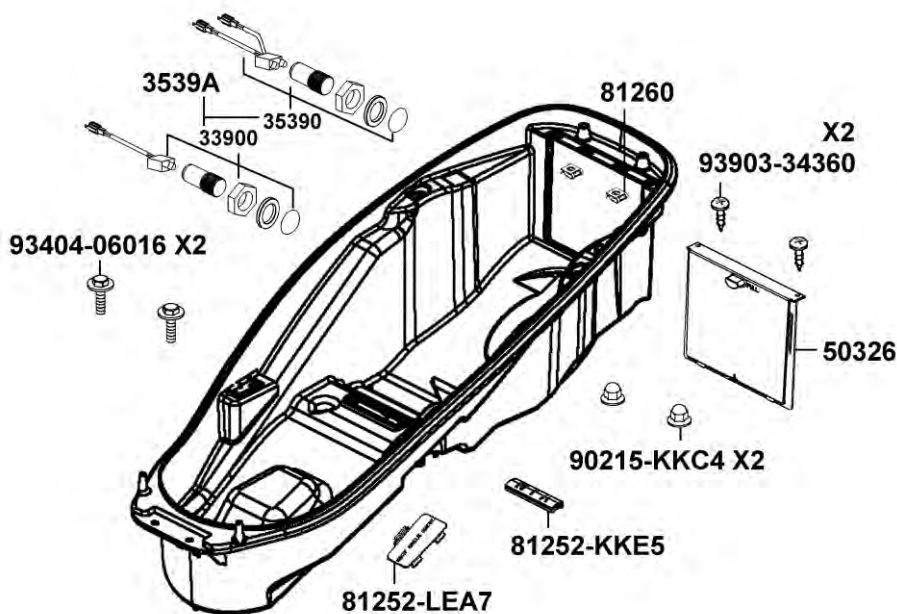



Remove the PDA panel located at the rear of the luggage box and free the PDA plug.



Lift up the luggage box to unplug the luggage box light connector. Remove the luggage box.

Rear Carrier

Removal

SAFETY FIRST: Protective gloves and eyewear are recommended at this point.

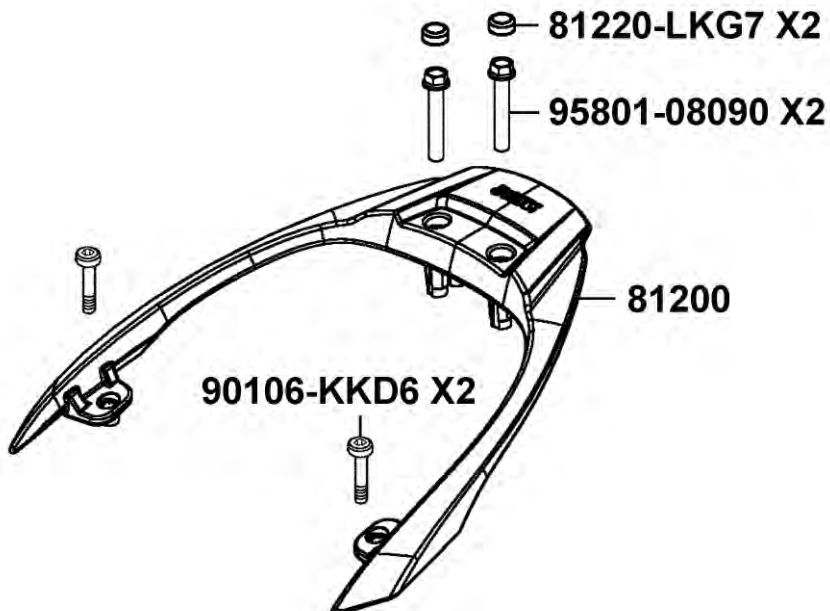

Pry off the carrier bolt covers with a small flat blade screwdriver, the arrow mark indicates the pry point.

Remove the four carrier bolts with a 6 mm Allen.
Remove the carrier.

Rear Center Cover

Removal

SAFETY FIRST: Protective gloves and eyewear are recommended at this point.

Remove the seat. See the [Seat](#) topic for more information.

Remove the luggage box. See the [Luggage Box](#) topic for more information.



Open the fueling protector cover.

Pull the center cover and fueling protector cover back and up to free the claws and free it from the scooter.

Note: Do not force the cover and damage the claws.

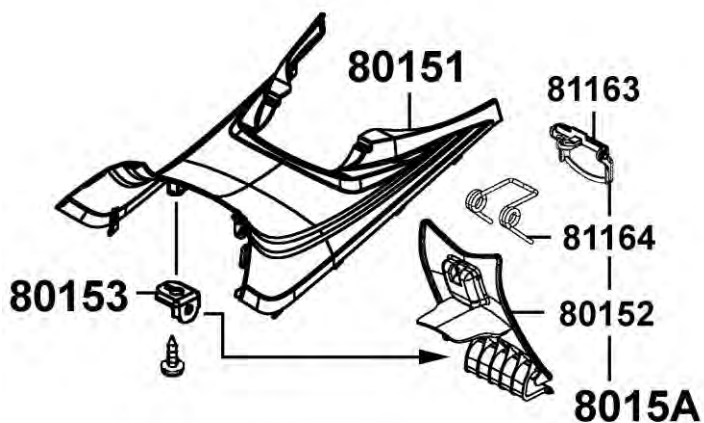

Body Cover

SAFETY FIRST: Protective gloves and eyewear are recommended at this point.

Removal

Remove the seat. See the [Seat](#) topic for more information.

Remove the luggage box. See the [Luggage Box](#) topic for more information.

Remove the rear carrier. See the [Rear Carrier](#) topic for more information.

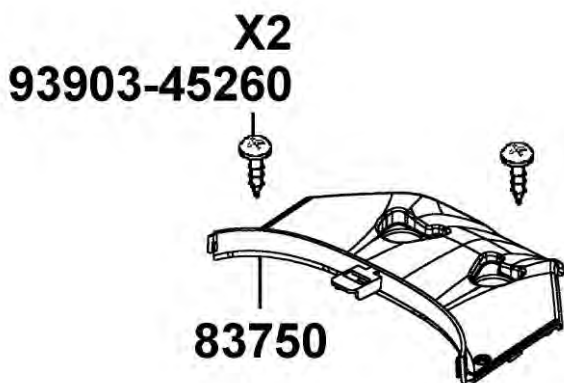

Remove the two rear center cover screws with a #2 Phillips.

Carefully unhook the tabs on both sides and remove the rear center cover.

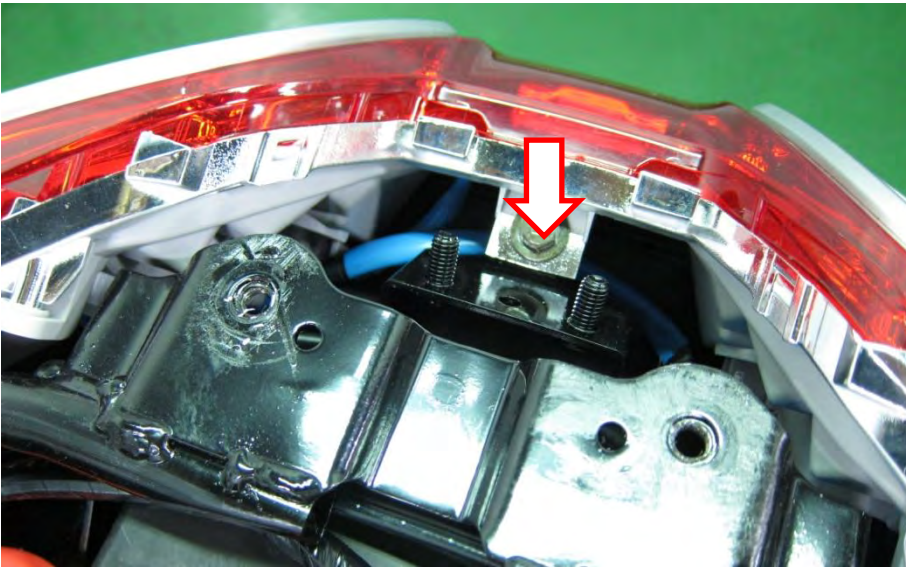

Remove the upper body cover bolt with a 10 mm socket.



Remove the two mounting nuts.



Remove the fasteners.

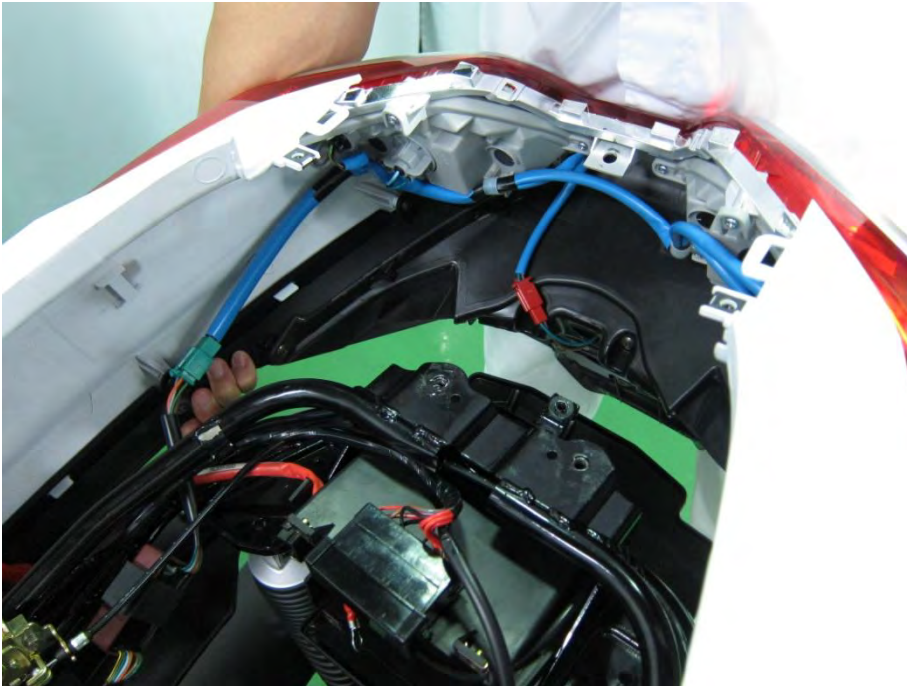

Unplug the taillight connector.
Unplug the tag light connector.

Remove the body cover.

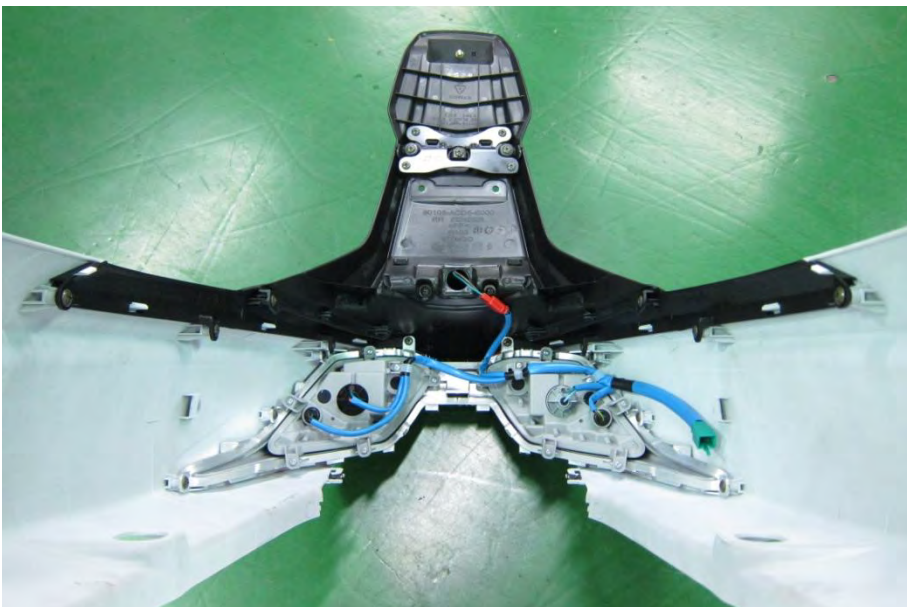

Disassembly

Taillight Assembly

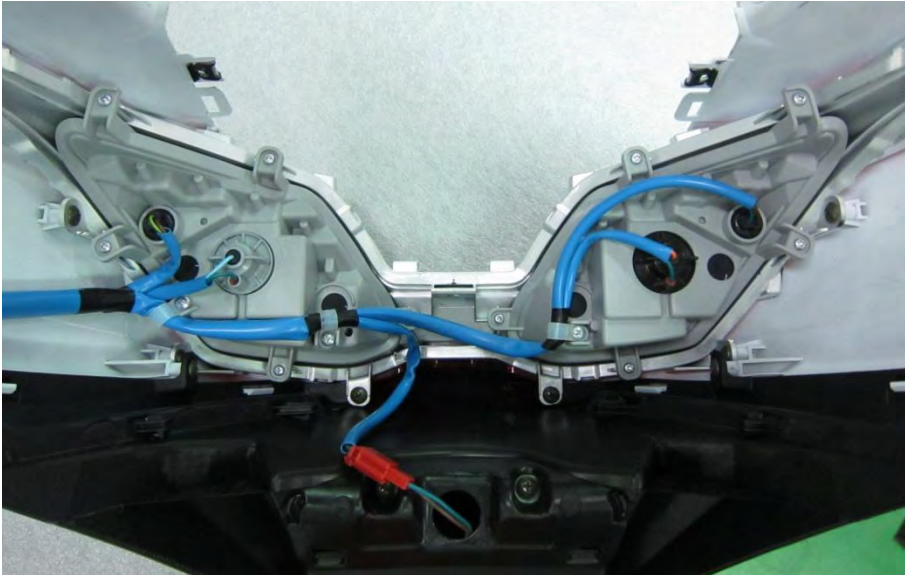

Remove the taillight assembly screws with a #2 Phillips.

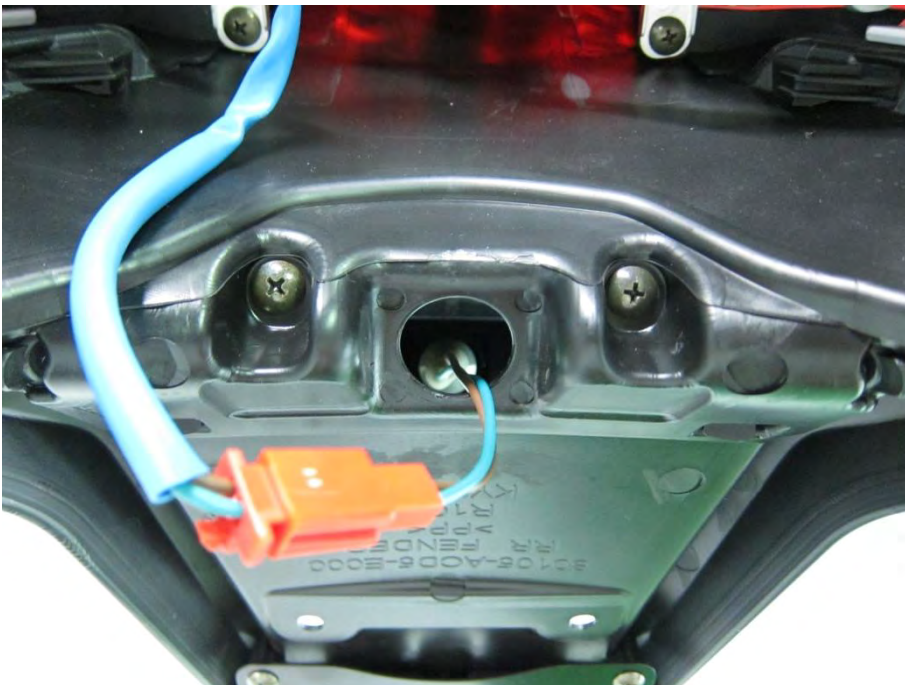

Unplug the connector of the license light.
Remove the screws.

Separate the mud flap and the taillight assembly.



Remove the license light assembly.

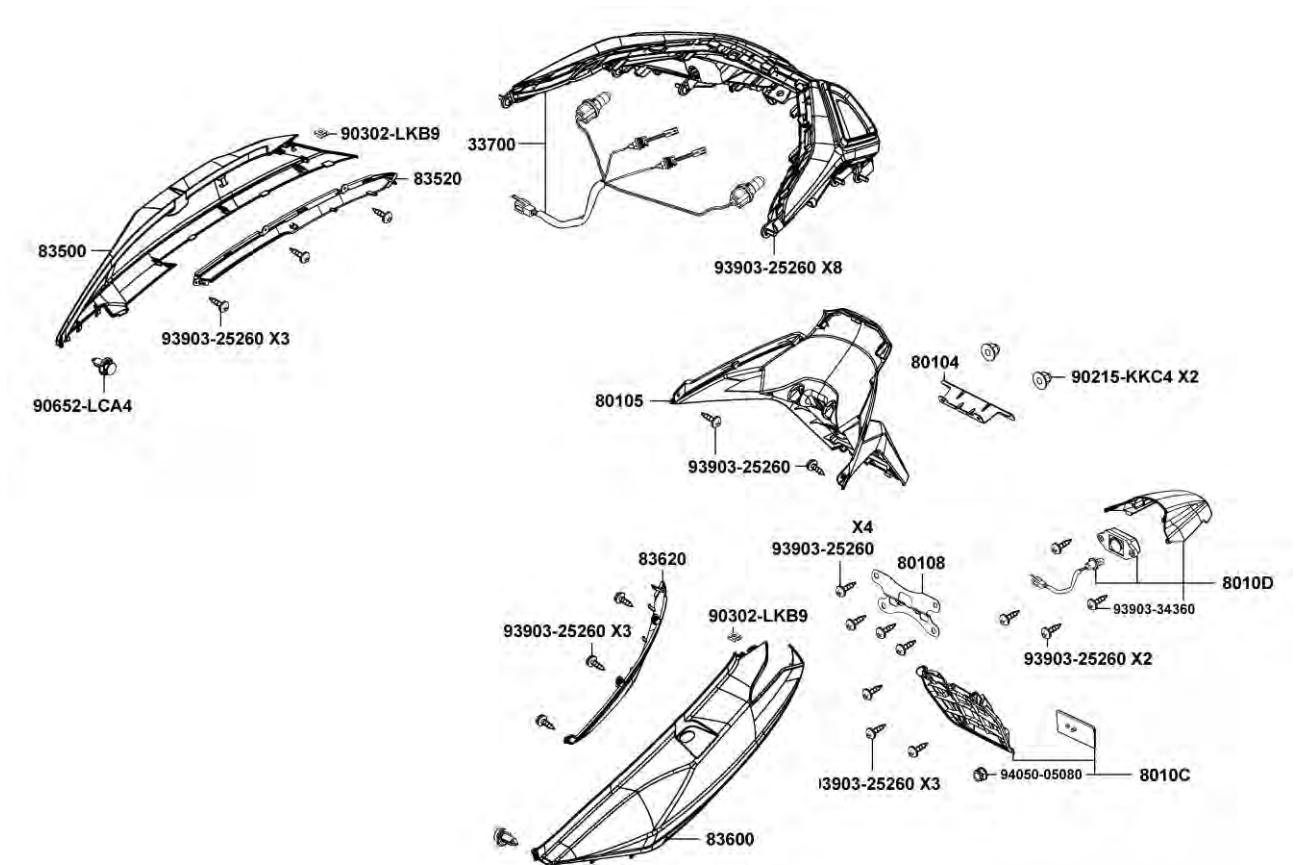

Rear Inner Fender Removal

Remove the seat. See the [Seat](#) topic for more information.

Remove the luggage box. See the [Luggage Box](#) topic for more information.

Remove the rear carrier. See the [Rear Carrier](#) topic for more information.

Remove the body cover.

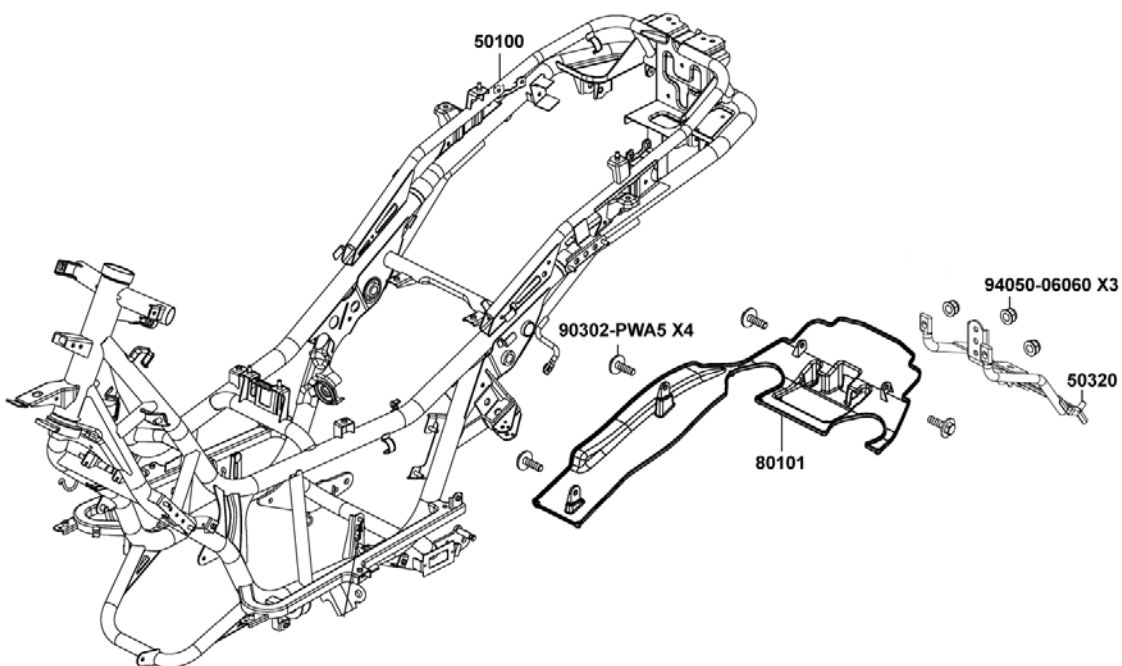

Remove the 3 nuts of plate and remove the plate.

Remove the bolts of rear inner fender.

Remove the rear inner fender.

Rear Tire Fender Removal

Remove the seat. See the [Seat](#) topic for more information.

Remove the luggage box. See the [Luggage Box](#) topic for more information.

Remove the rear carrier. See the [Rear Carrier](#) topic for more information.

Remove the body cover.

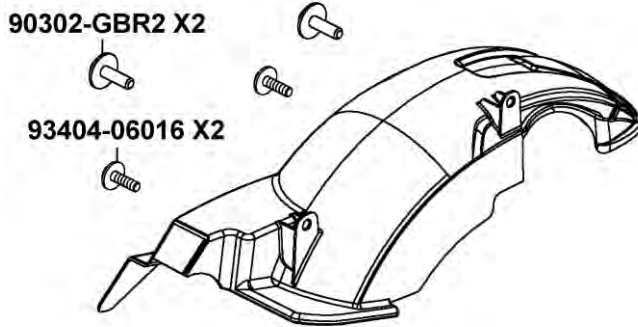

Remove the bolts of rear tire fender.

Remove the fender.



Heat Shield Removal

Remove the seat. See

Remove the two rear center cover screws with a #2 Phillips.
Carefully unhook the tabs on both sides and remove the rear center cover.

Heat Shields



Remove the muffer heat shield bolts with a 10 mm socket.



And remove the muffer heat shield.



To remove the heat shield on the exhaust pipe remove the two bolts with an 8 mm socket.

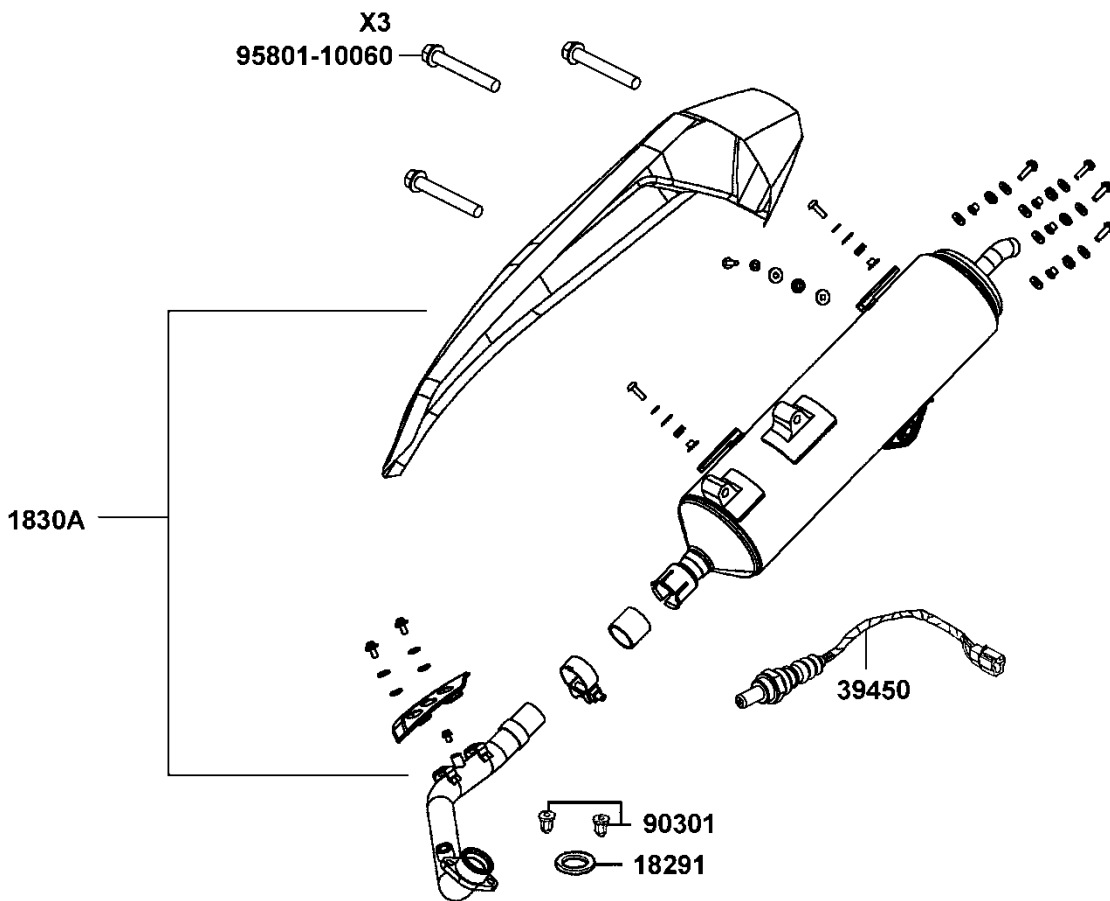

Exhaust System

SAFETY FIRST: Protective gloves and eyewear are recommended at this point.

General Instructions

- When removing frame covers, use care not to pull them by force because the cover joint claws may be damaged.
- Make sure to route cables and harnesses according to the Cable & Harness Routing.

Troubleshooting

Noisy exhaust muffler

- Damaged exhaust muffler
- Exhaust muffler joint air leaks

Lack of power

- Caved exhaust muffler
- Clogged exhaust muffler
- Exhaust muffler air leaks

Removal

Remove the seat. See the [Seat](#) topic for more information.

Remove the luggage box. See the [Luggage Box](#) topic for more information.

Remove the rear carrier. See the [Rear Carrier](#) topic for more information.

Remove the body cover. See the [Body Cover](#) topic for more information.

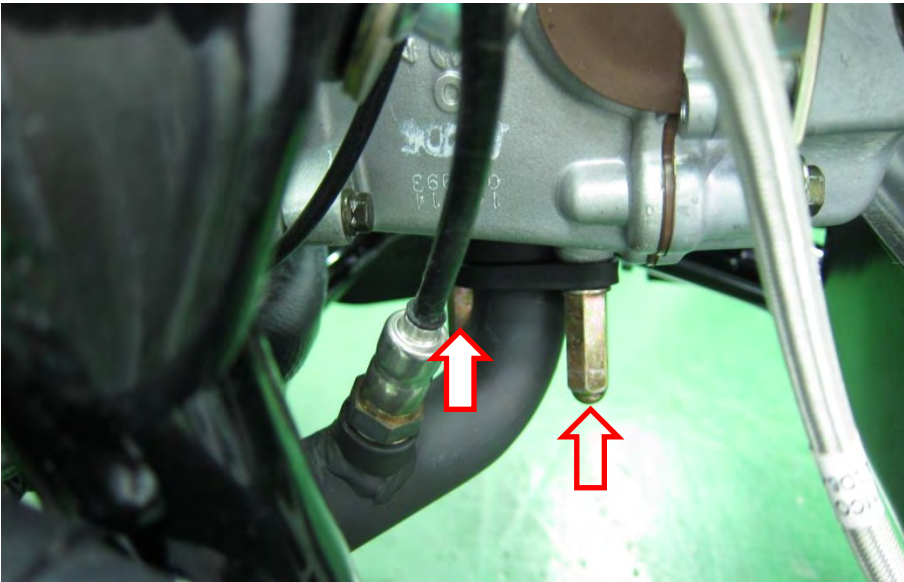

Remove the two exhaust pipe joint nuts with a 12 mm deep well socket.

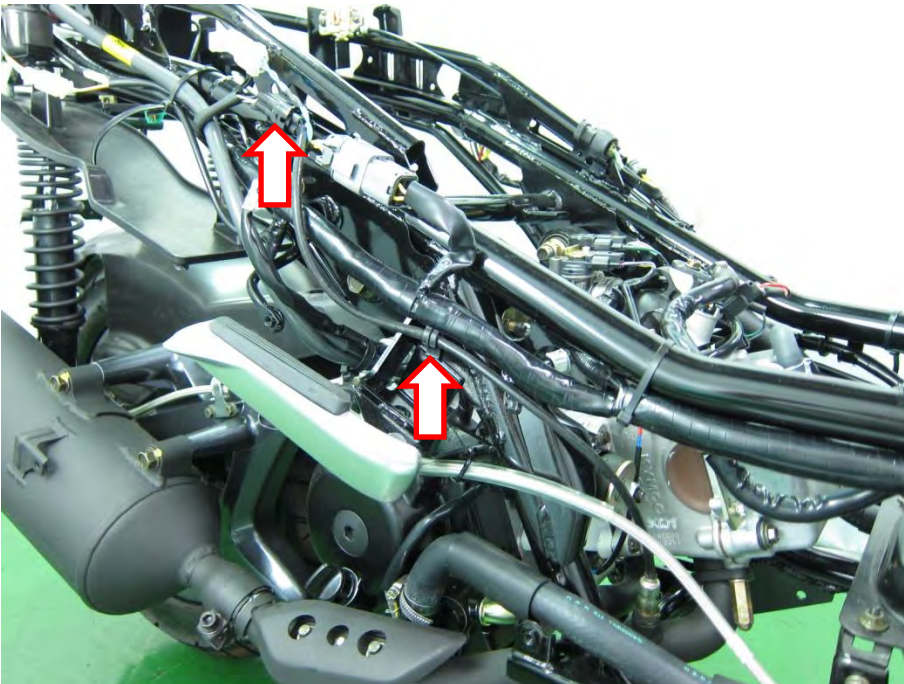

Remove the O² sensor wire band.
Unplug the O² sensor connector.

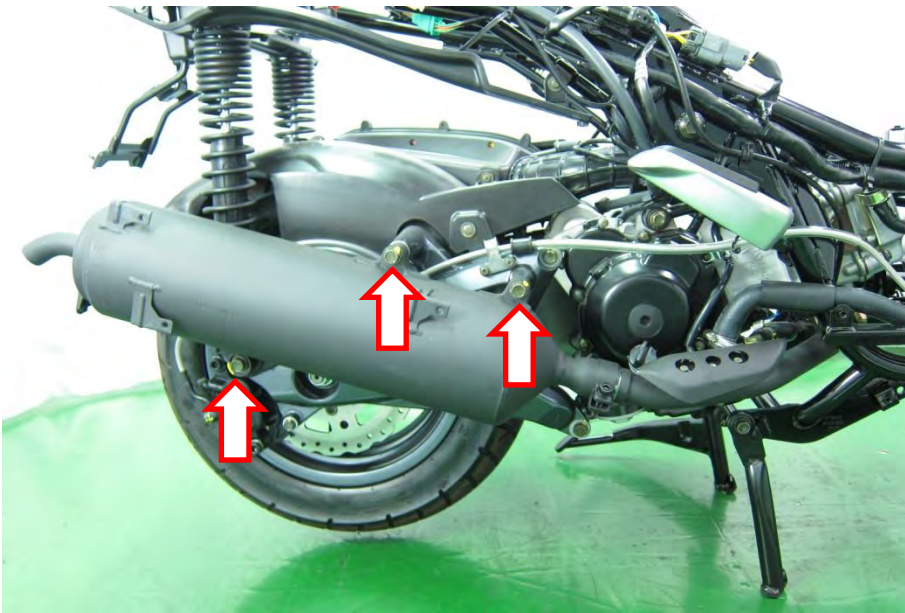

Remove the three muffler mounting bolts with a 14 mm socket.
And remove the exhaust system.



Remove the exhaust pipe gasket and discard it.

O² Sensor

Removal



Remove the O² sensor with a 17 mm wrench. Use care not to pinch the wires.

The O² sensor issues signal to ECU when the temperature is over 350°C while the engine is running.

Test the O² sensor at room temperature.

Use a digital multimeter set to ohms of resistance to inspect the O² sensor.

Measure the resistance between the white wire terminals of the O² sensor connector. Replace the O² sensor if the reading is out of specification.

ITEM	SPECIFICATIONS
O ² heater sensor resistance (at 20°C/68°F)	6.7 - 9.5 Ω (engine warming condition)

Exhaust System

Installation



Insert a new exhaust pipe gasket into the exhaust port.

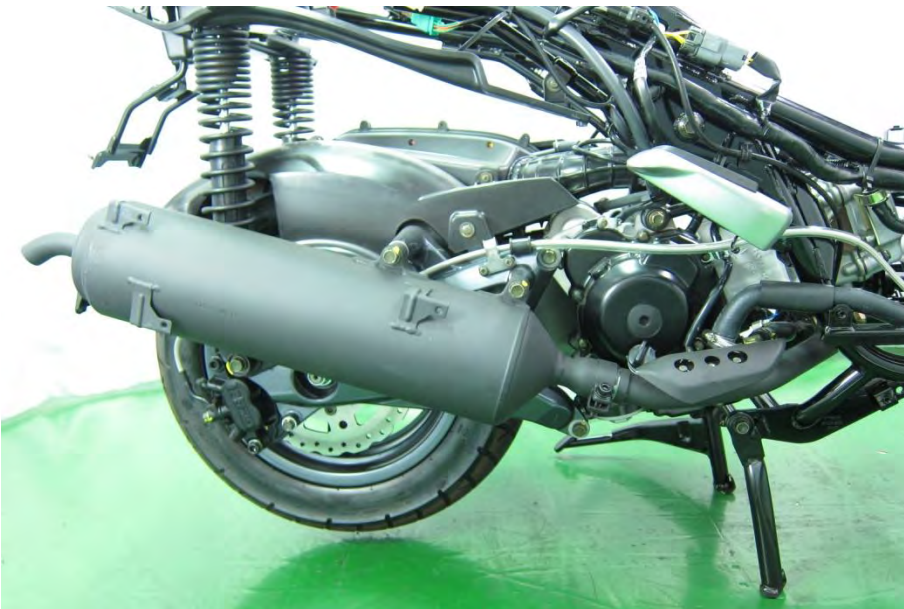

Fit the exhaust system into place

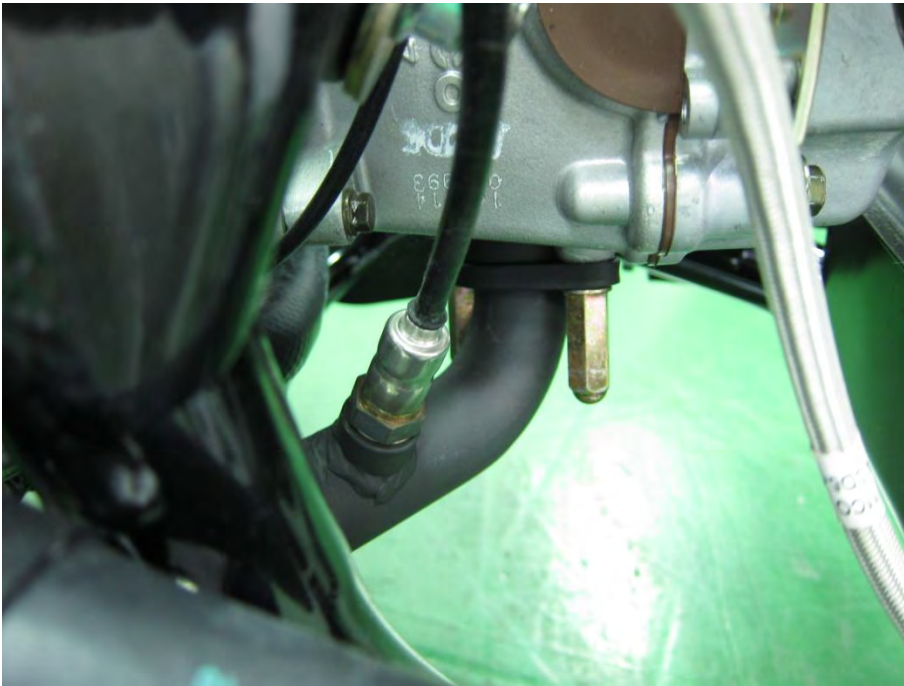

Install the two exhaust pipe joint nuts with a 12 mm deep well socket. Do not tighten.

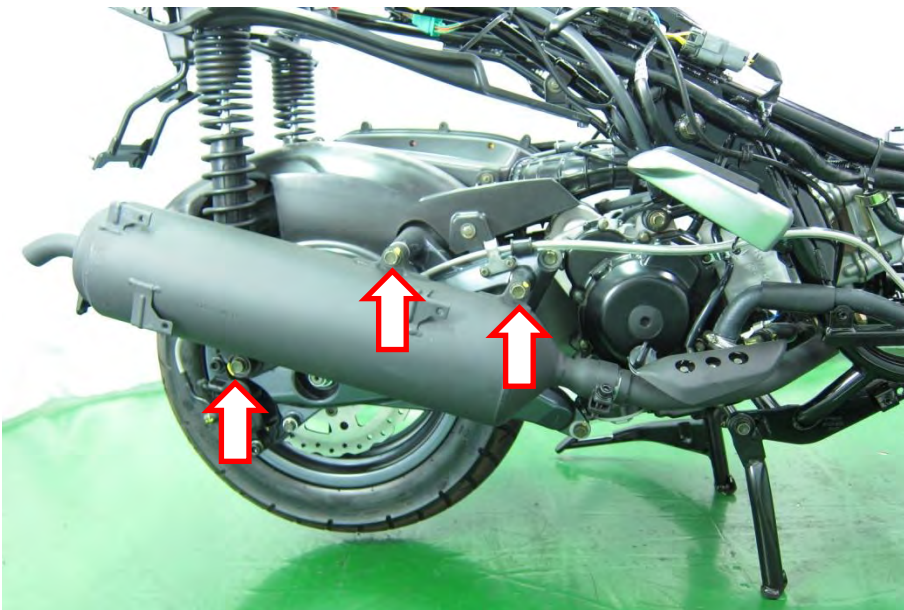

Install the three muffler mounting bolts and tighten to specification with a socket.

Item	Torque	
	N-m	kgf-m
Muffler Mounting Bolts	20	2



Tighten the two exhaust pipe joint nuts to specification with a 12 mm deep well socket.

Item	Torque	
	N-m	kgf-m
Exhaust Pipe Joint Nuts	35	3.5

If the exhaust pipe and muffler were separated tighten the muffler clamp securely.

Plug in the O² sensor connector.
Install the O² sensor clamp.

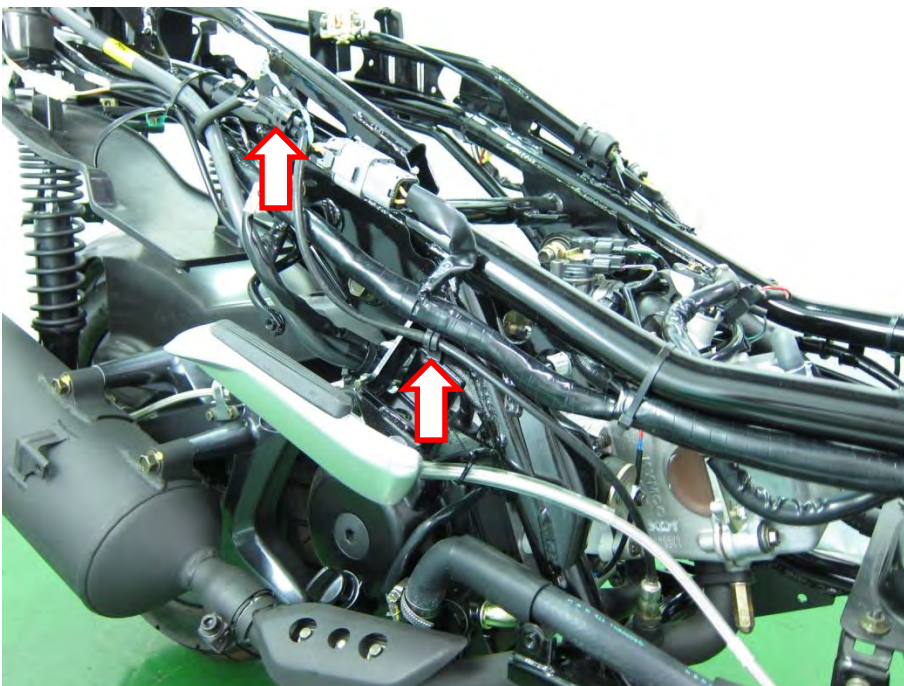

Installation

O² Sensor

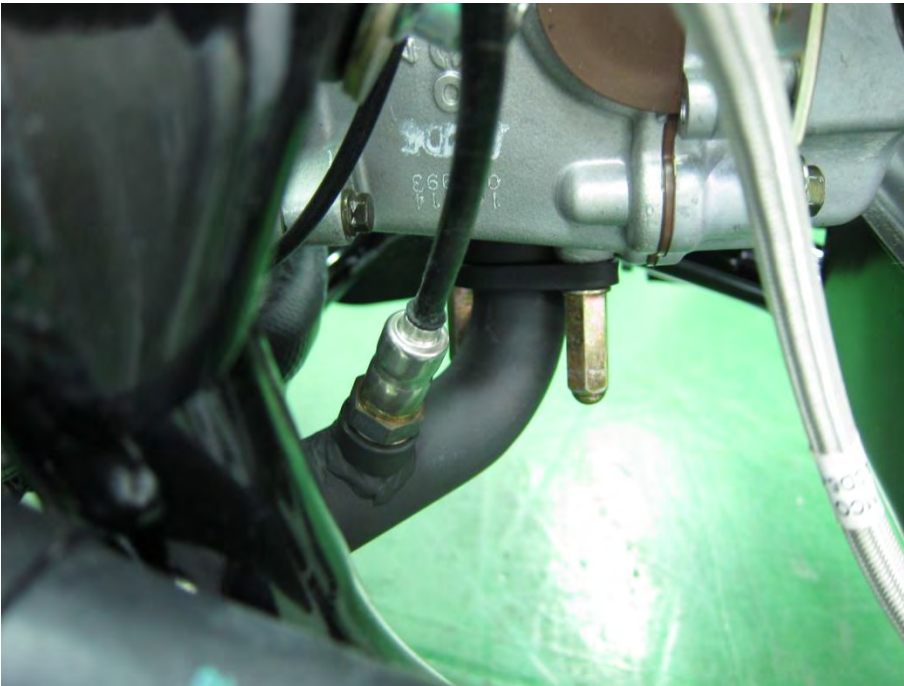

Apply anti-seize compound to the threads of the O² sensor. Install the O² sensor and tighten it to specification with a 17 mm wrench. Use care not to pinch the wires.

Item	Torque	
	N-m	lb-ft
O ² Sensor	25	18

FRONT PART

Follow the dismantled order as below illustration.

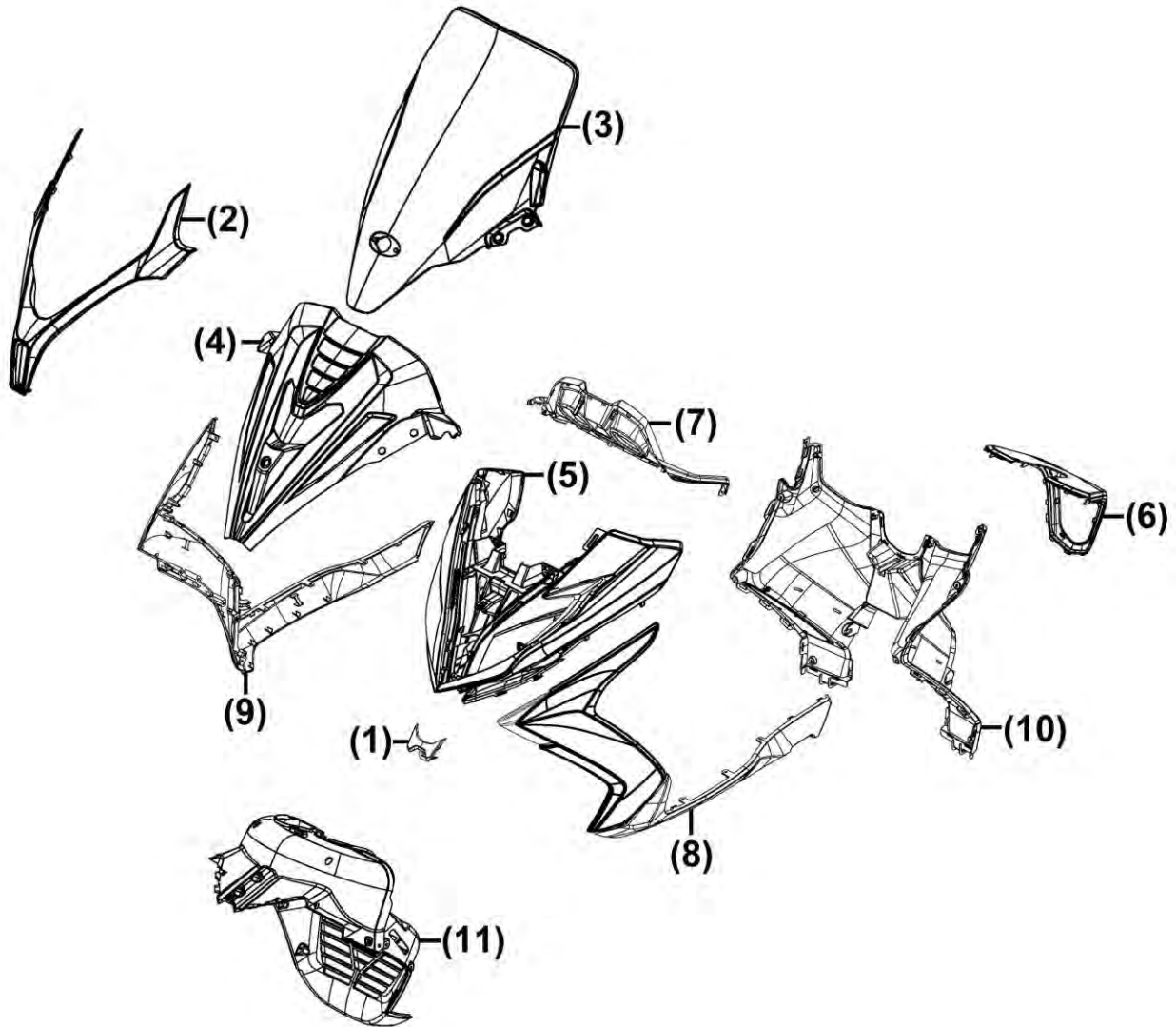

Front Center Cover Removal



Pull the front center cover with certain direction.

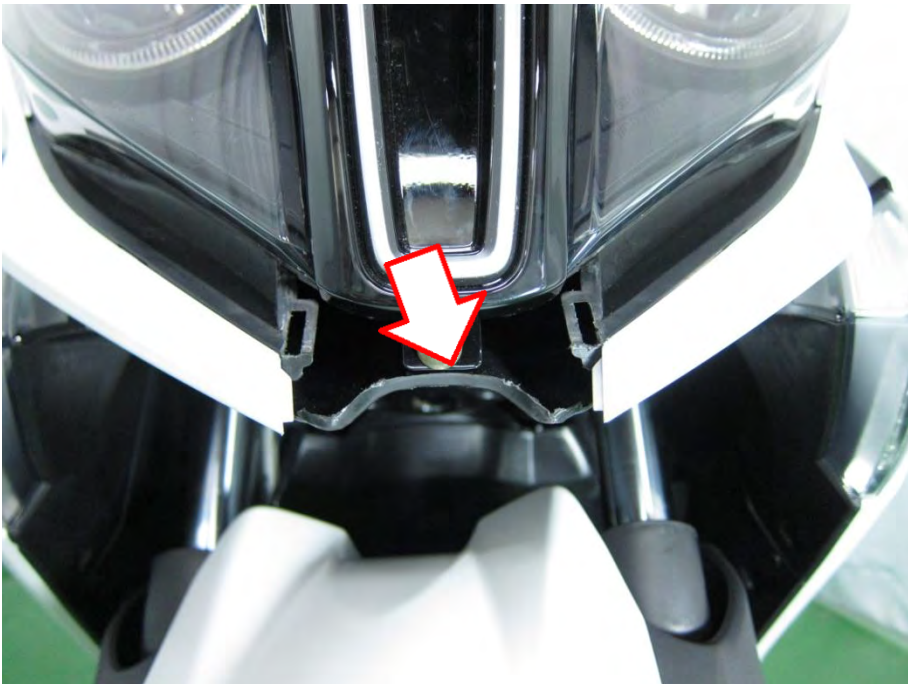

Remove the front center cover.

Front Cover Removal

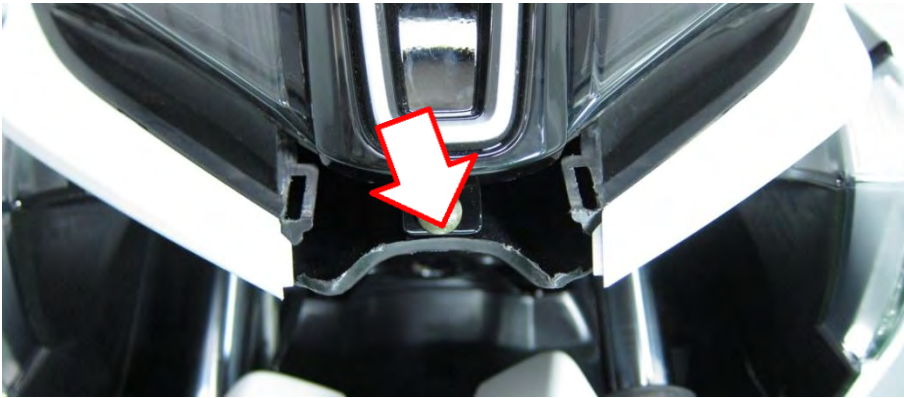

Remove the fastener.



Remove the screws. And remove the front cover.



Windshield Removal



Remove the 4 hex mounting bolts.



Rotate the KYMCO logo plate.
Remove the screw.
And remove the windshield.

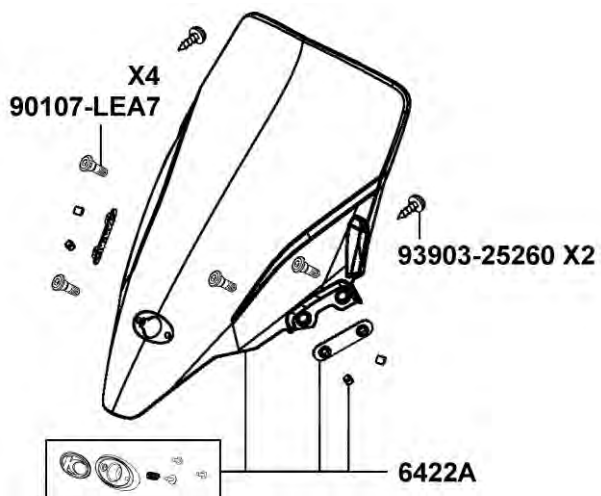

Front Meter Cover Removal



Remove the front meter cover.

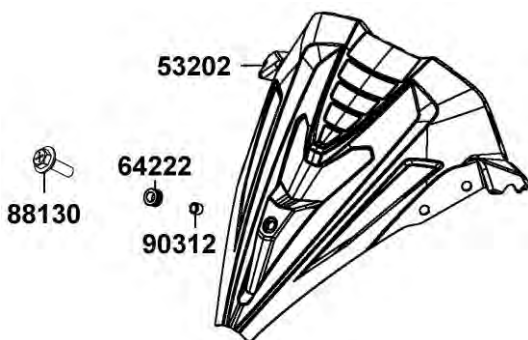

Head Light Assembly Removal

Remove the head light assembly and side moldings as a set.
Remove the two mounting nuts.

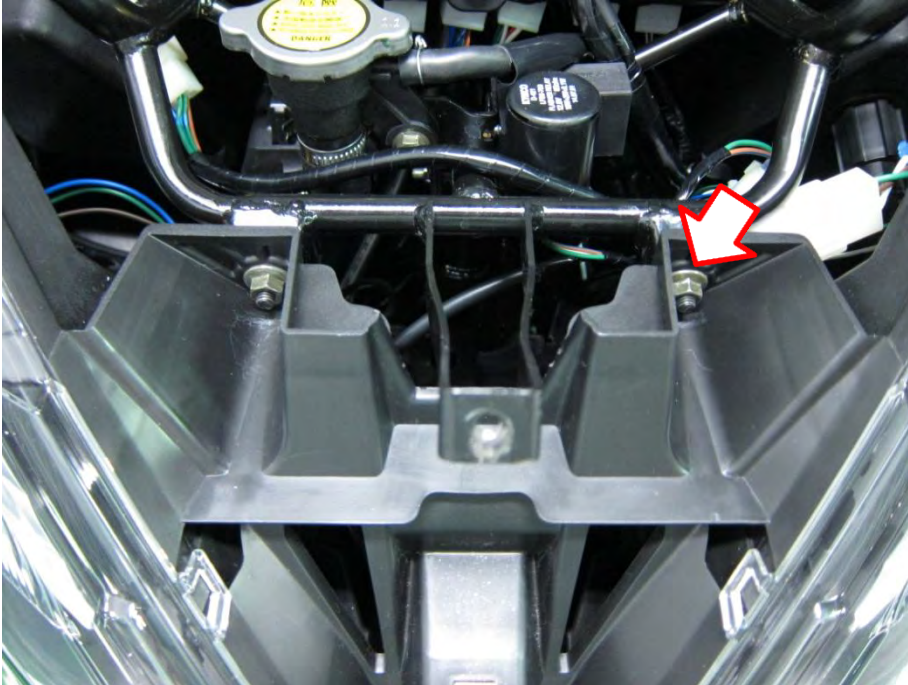

Push fender down to loosen the tabs.



Use pry tool to release the tabs.

Note: Be carefully not to damage the tabs and surfaces of the board.



Unplug the coupler of headlight.



Remove the head light assembly.

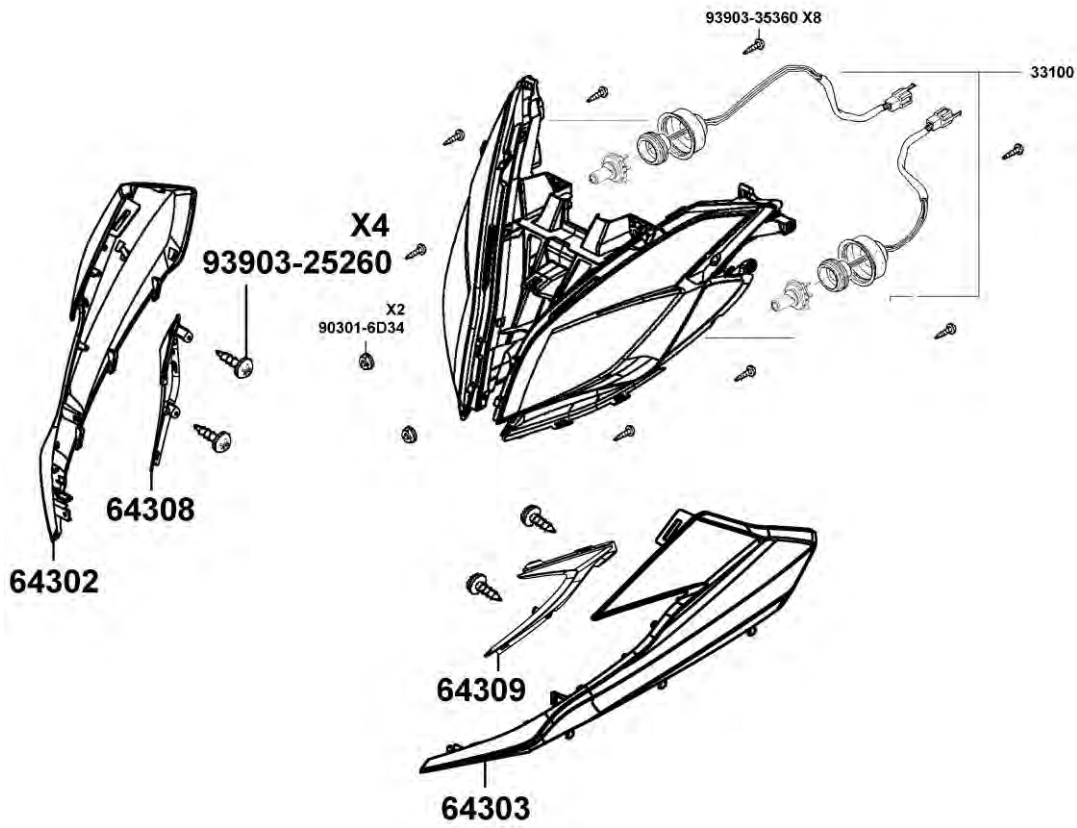

Key Cover Removal

Remove the front cover, windshield and meter cover first.



Loosen the mounting screw then turn and remove the ignition cover.

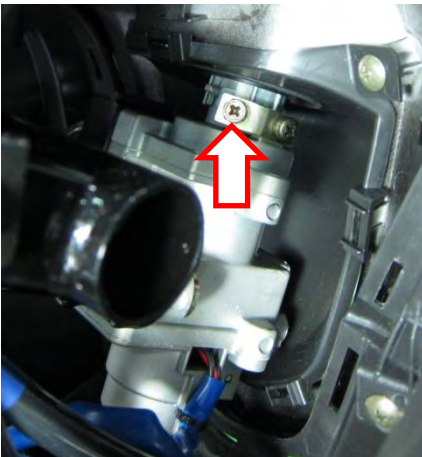

Remove the left and right fasteners.

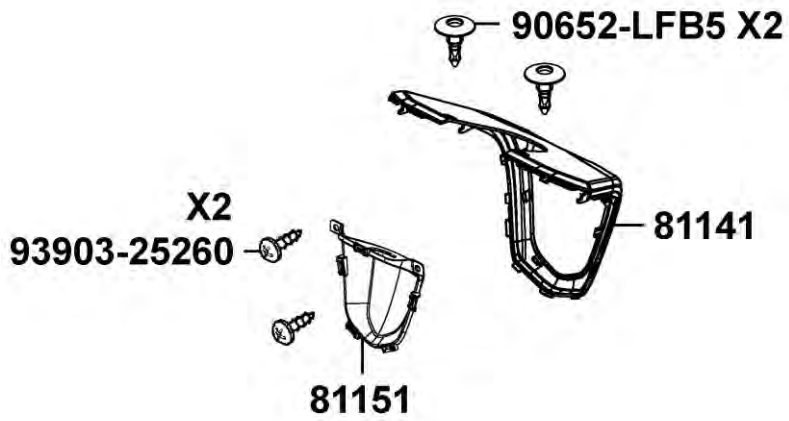

Dash Board Removal

Remove the dash board and cover as a set.



Remove the left and right bolts.



Remove the couplers.



Remove the dash board set.

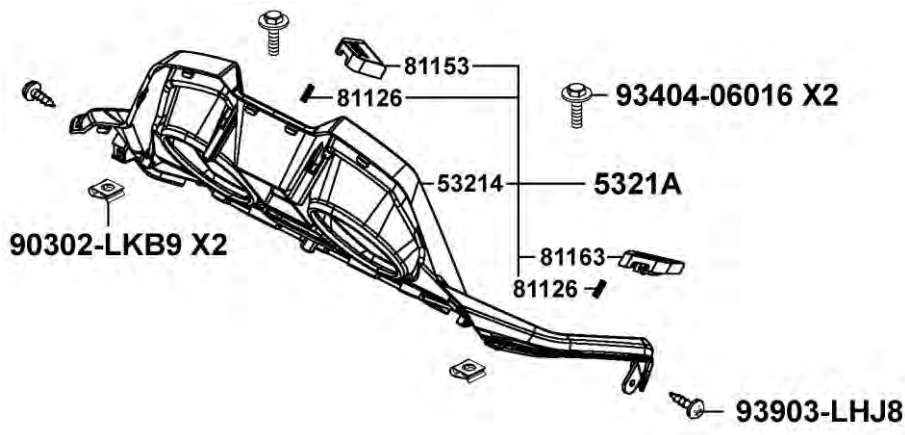

Side Covers And Skirts Removal



Remove the floor mat.

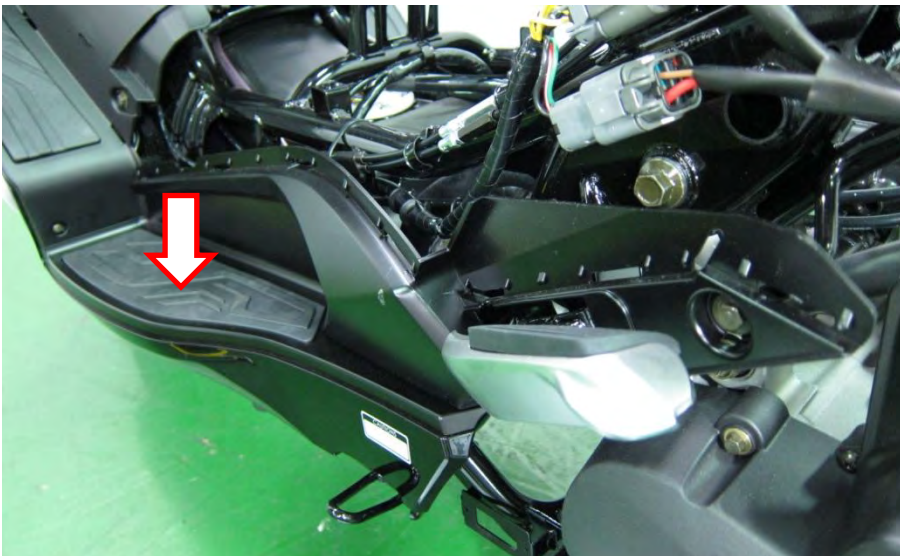

Remove the side cover, turn signal light and skirt as a set.

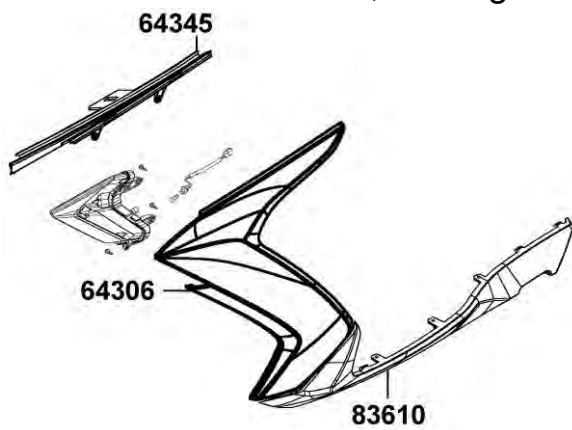

Remove the screws which are mounted on floor panels.



Remove the screws.



Remove the screws.



Remove the fasteners.



Remove the skirt set.

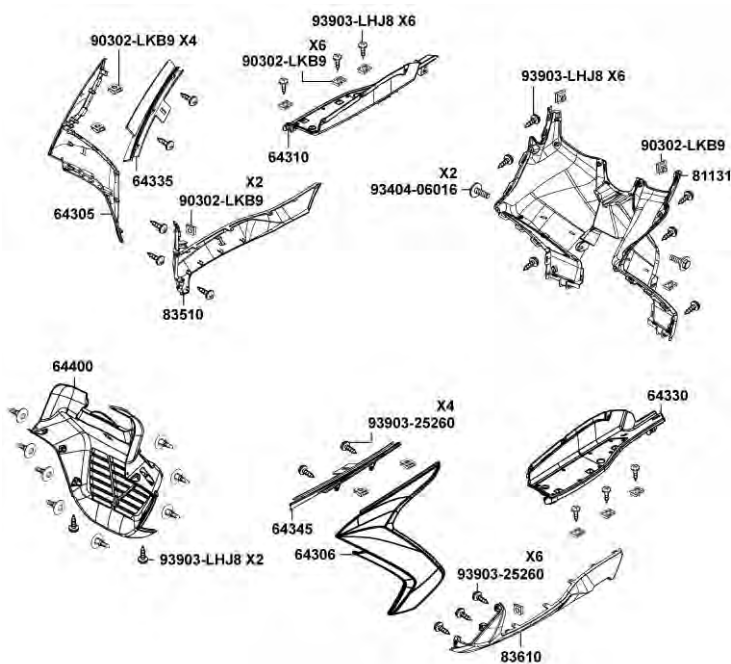

Side Board A Removal

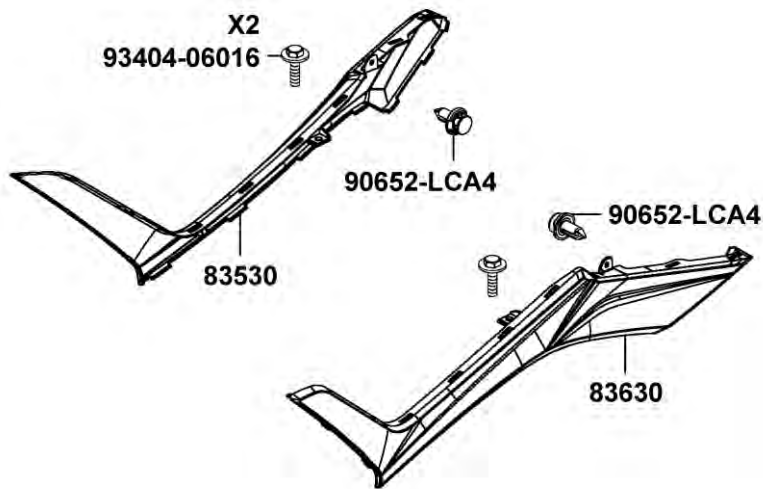

Note: 90652-LCA4 fasteners are mounted with body cover.



Remove the mounting bolts of side board A.



Use tool to pry the tabs. Be carefully not to damage the tabs and surfaces of the board.



Remove both the right and left side board A.

Side Board B Removal

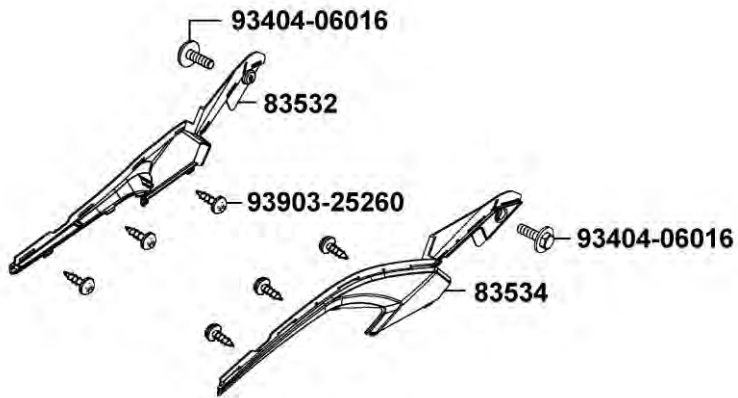

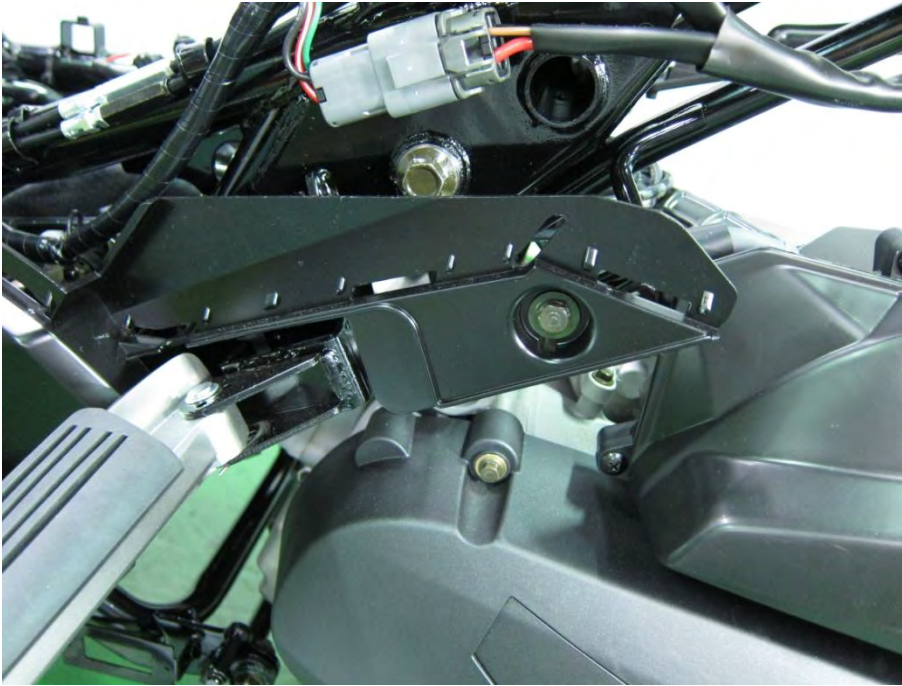

Remove the mounting bolts of side board B.



Remove the right and left side board B.

Floor Panel Removal

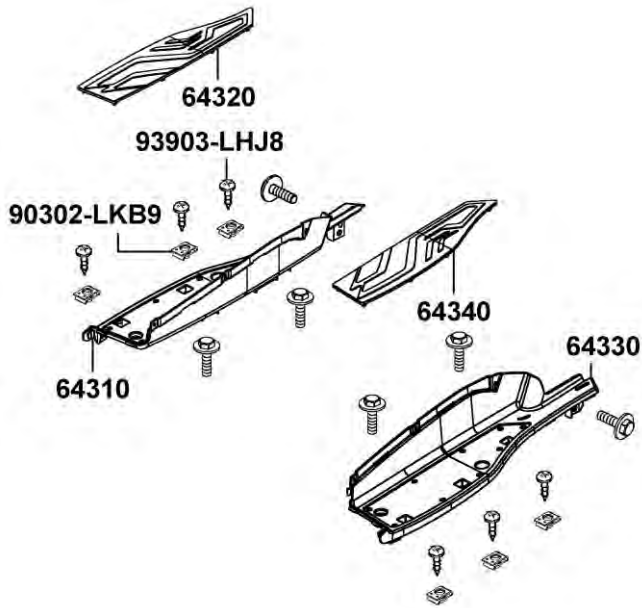

Remove the floor mat.



Remove the bolts and screws.



Remove the right and left floor panels.

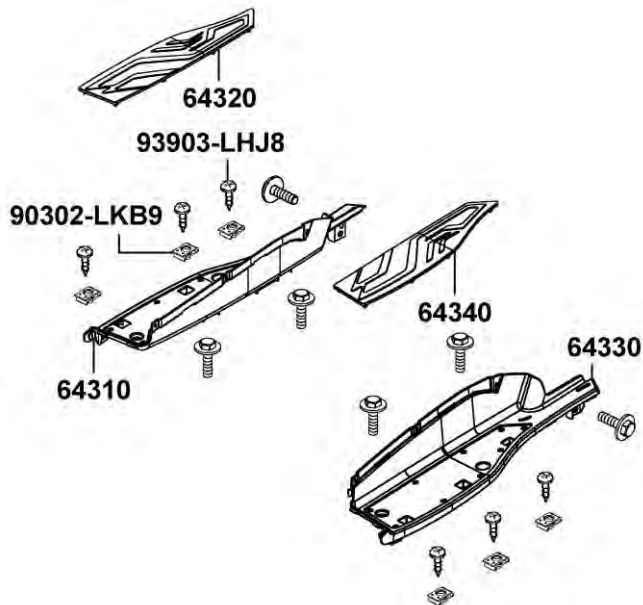

Leg Shield Set Removal



Use ignition key and remove the fueling cap.



Remove the left and right bolts.

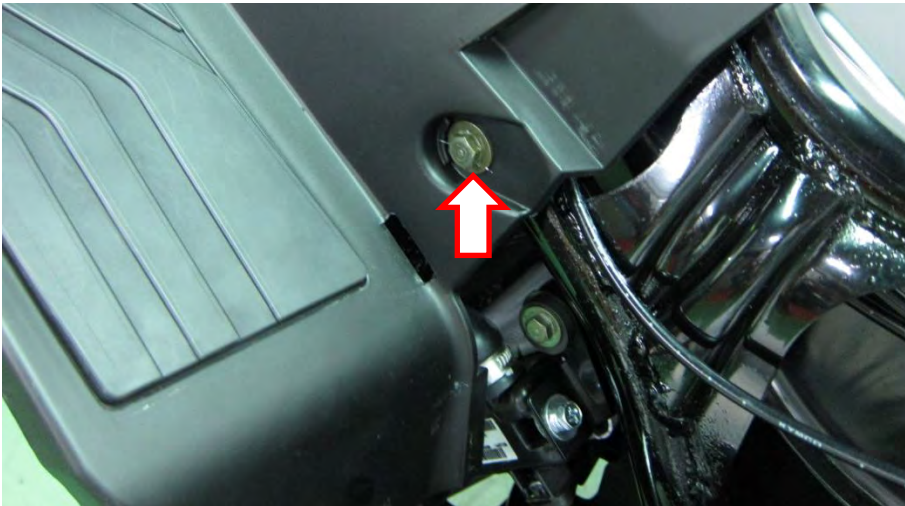

Remove the coupler.

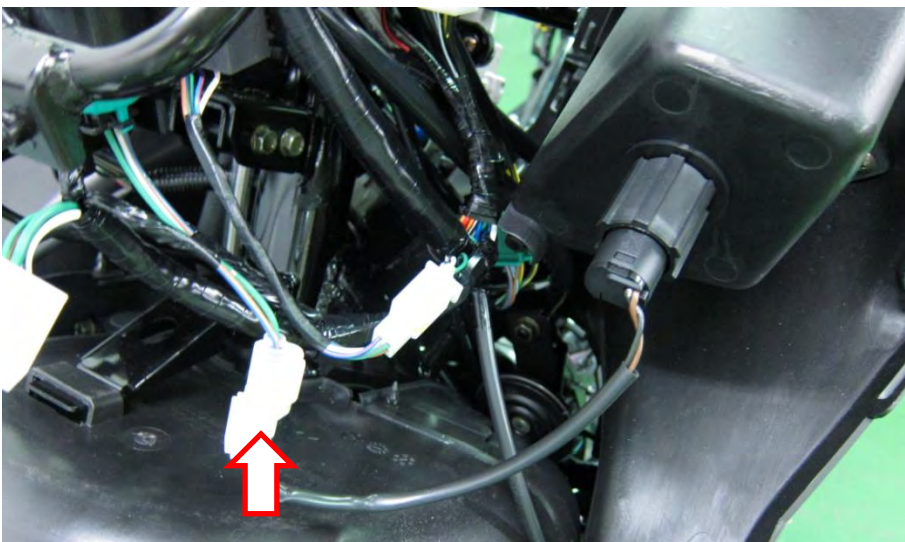

Remove the leg shield set.

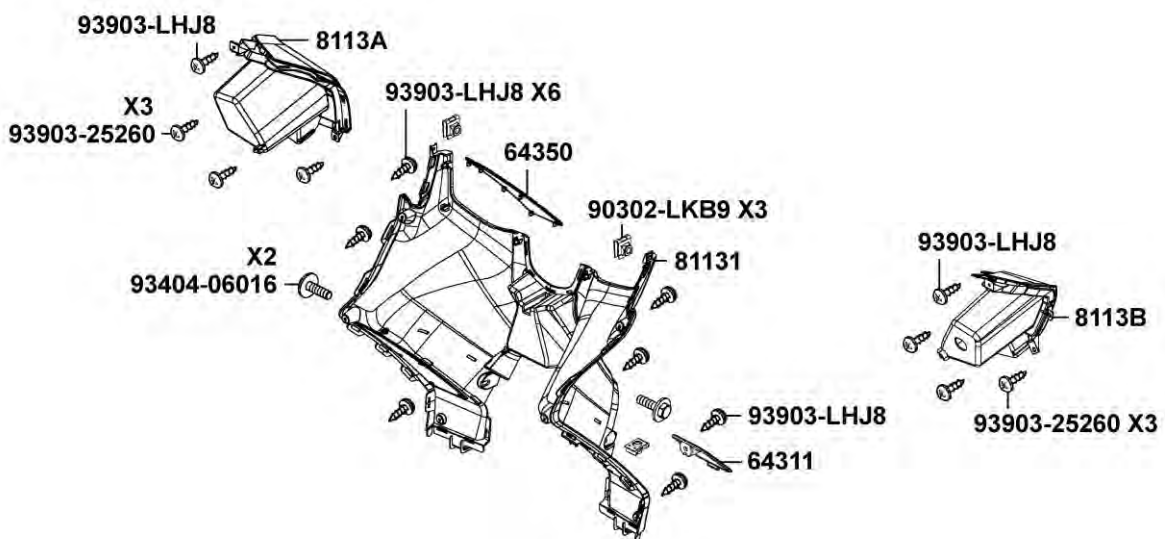

Inner Fender Removal



Remove the connector of the air temperature sensor.



Remove the left and right fasteners and remove front inner fender.

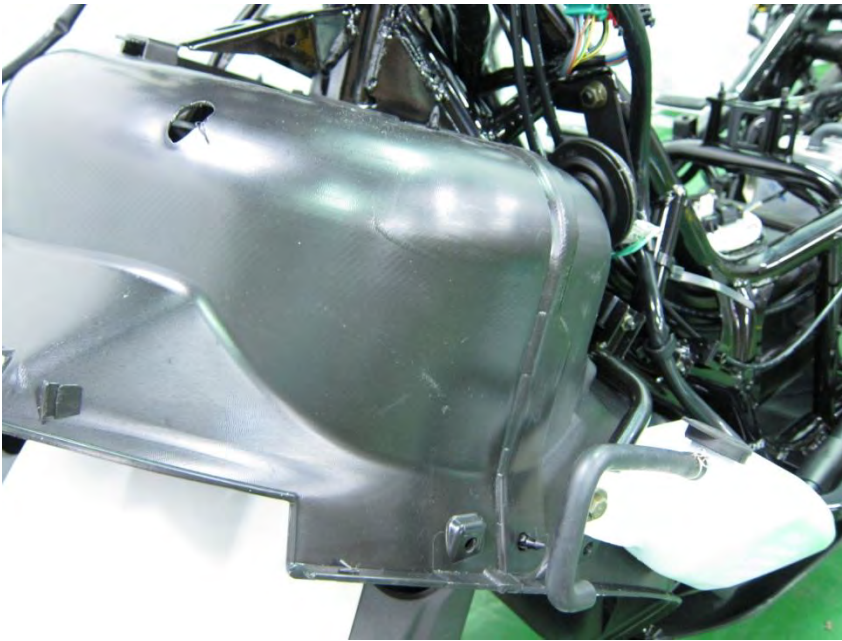

Remove the screw.



Remove the rear inner fender set.

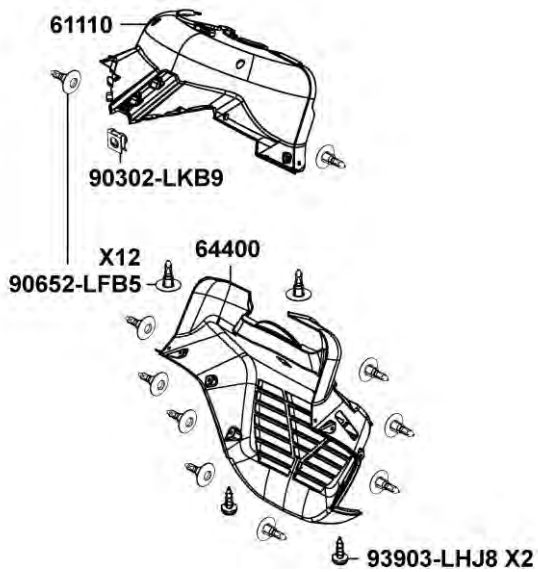

Under Cover Set Removal

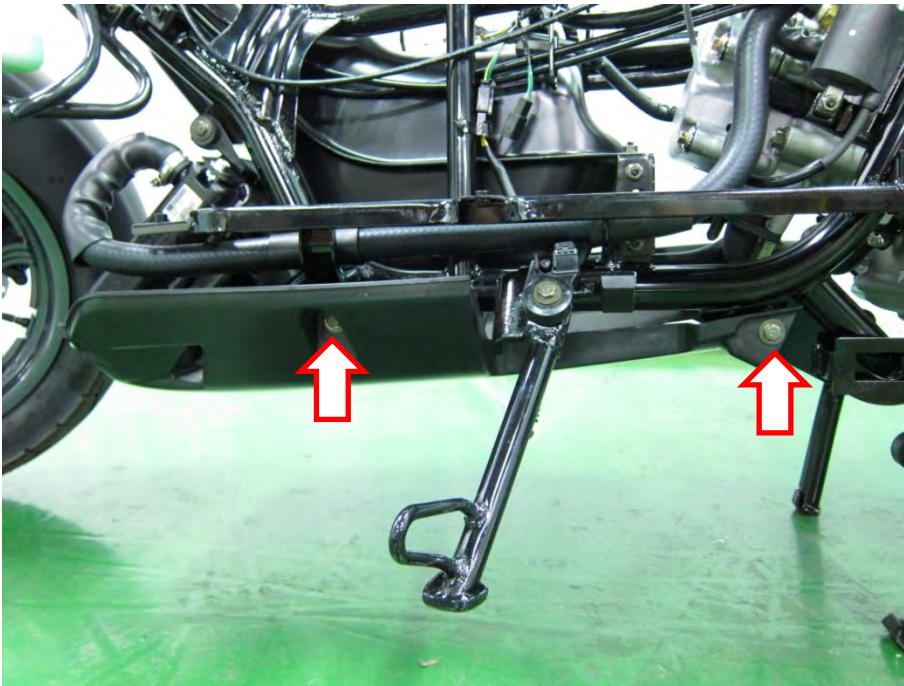

Remove the connector of the air temperature sensor.

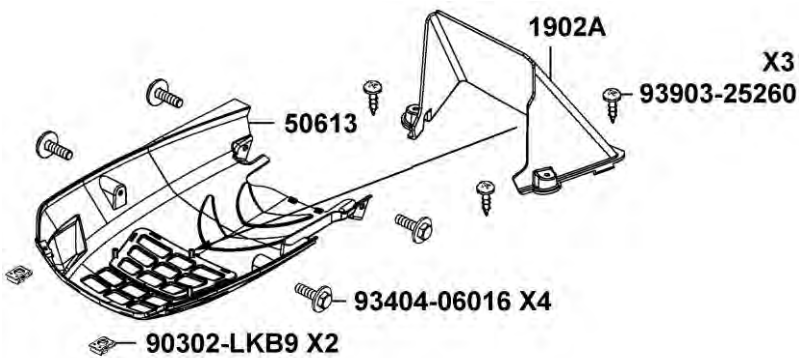

Remove the left and right fasteners and remove front inner fender.

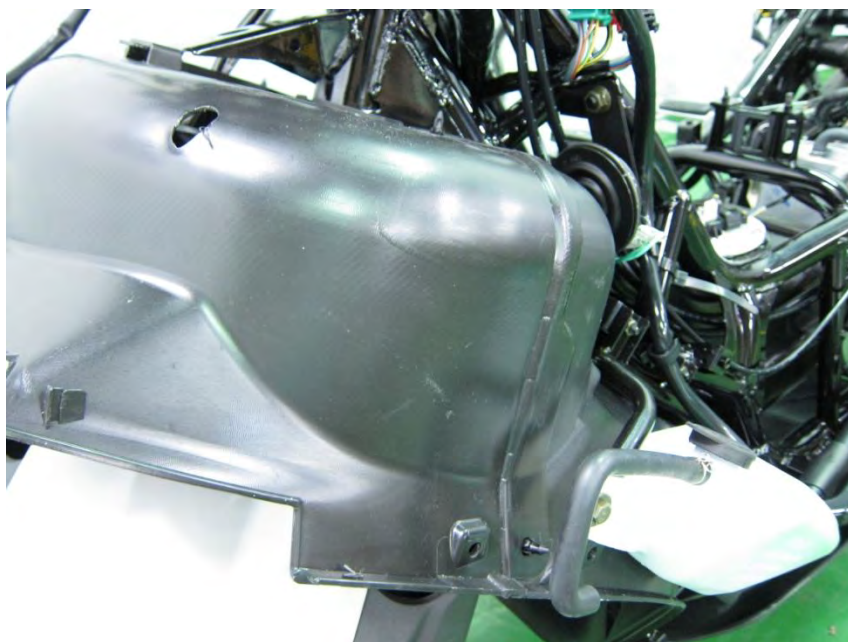

Remove the screw.



Remove the rear inner fender set.

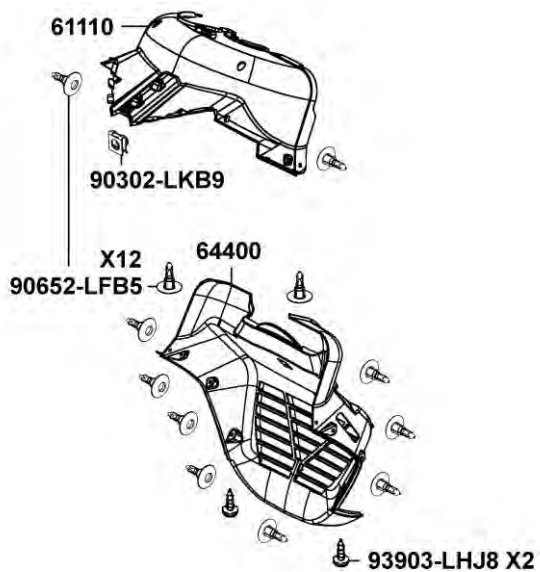

Front Fender

SAFETY FIRST: Protective gloves and eyewear are recommended at this point.

Removal



The front fender is held in place with four bolts, two on each side.

Remove the left forward front fender bolt with a 6 mm Allen.
And remove the left rear fender bolt with a 10 mm socket.



Remove the left rear fender bolt with a 10 mm socket.



Remove the right forward front fender bolt with a 6 mm Allen.
And remove the right rear fender bolt with a 10 mm socket.



Remove the front fender from the forks.

Handlebar

SAFETY FIRST: Protective gloves and eyewear are recommended at this point.

Removal

Remove the handlebar covers. See the [Handlebar Covers](#) topic for more information.

Remove the front cover. See the [Front Cover](#) topic for more information.

Bar Ends

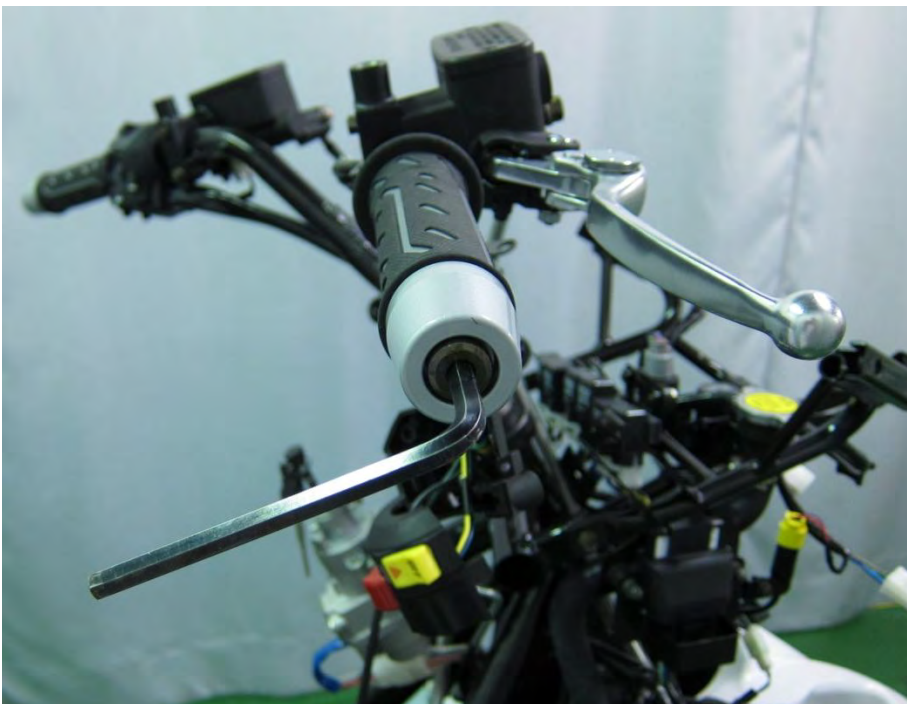

Remove the bar ends with a 6 mm Allen.

To remove the brake master cylinders see the. [Master Cylinders](#) topic.

Switch Housings and Throttle



Remove the two right switch housing mounting screws with a #2 Phillips screwdriver. Disconnect the switch.



Separate the switch housing from the handlebar.

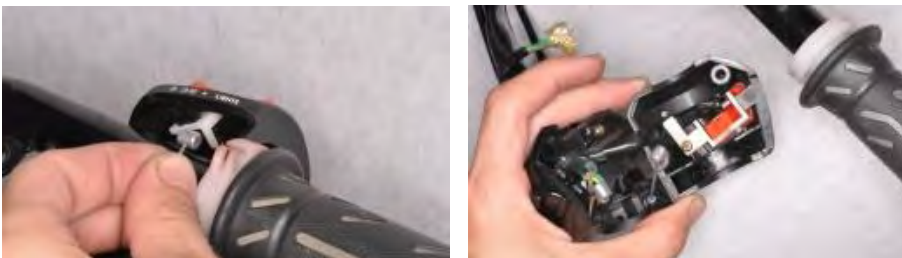

Disconnect the throttle cables and free the right switch housing from the handlebar.



Slide off the throttle grip.



Remove the two left switch housing mounting screws with a #2 Phillips screwdriver.



Disconnect the switch. Separate the left switch housing from the handlebar.

Handlebar



Route the cables and lines from the handlebar cable guide.



Hold the handlebar lock bolt with a 14 mm wrench and loosen the nut with a 17 mm socket.

Installation torque:

Item	Torque	
	N-m	lb-ft
Handlebar Lock Nut	45	32



Remove the handlebar lock nut and bolt.



Remove the handlebar.

Grips



If you plan to replace the grips you can slice them lengthwise with a razor blade and peel them off. To remove the grips without cutting them use a screwdriver to open a gap between the grip and the handlebar. Spray in contact cleaner to break up the grip cement. Use compressed air to expand the grip so it can be easily slid off the end of the handlebar. Note the relationship between the angle of the grip and the throttle tube so that the new grip can be installed with the correct angle.

NOTE: Always wear safety glasses when using compressed air and never point it directly at yourself or anyone else.

Before installing the grips to either the throttle tube or the handlebar, wipe down the area with a brake or parts cleaner that will dry without leaving a residue. When you are sure the area is dry apply grip cement to the bar or tube. Install the left grip at an angle of your preference. Install the throttle grip onto the tube with the same angle as the original grip.

When installation:

Switch Housings and Throttle



Align the left switch housing and install on the handlebar.



Insert the two housing screws and tighten them securely with a #2 Phillips screwdriver. Connect the switch.



Slide the throttle grip onto the right side of the handlebar.



Install the right switch and throttle housing. The post on the housing should fit into the hole in the bar.



Lubricate the end of the throttle in grease. Fit the ends of the throttle cables into the throttle tube.



Insert the two housing screws and tighten them securely with a #2 Phillips screwdriver. Tighten the front bolt before the rear.

Install the brake master cylinders. See the [Master Cylinders](#) topic for more information.

Bar Ends

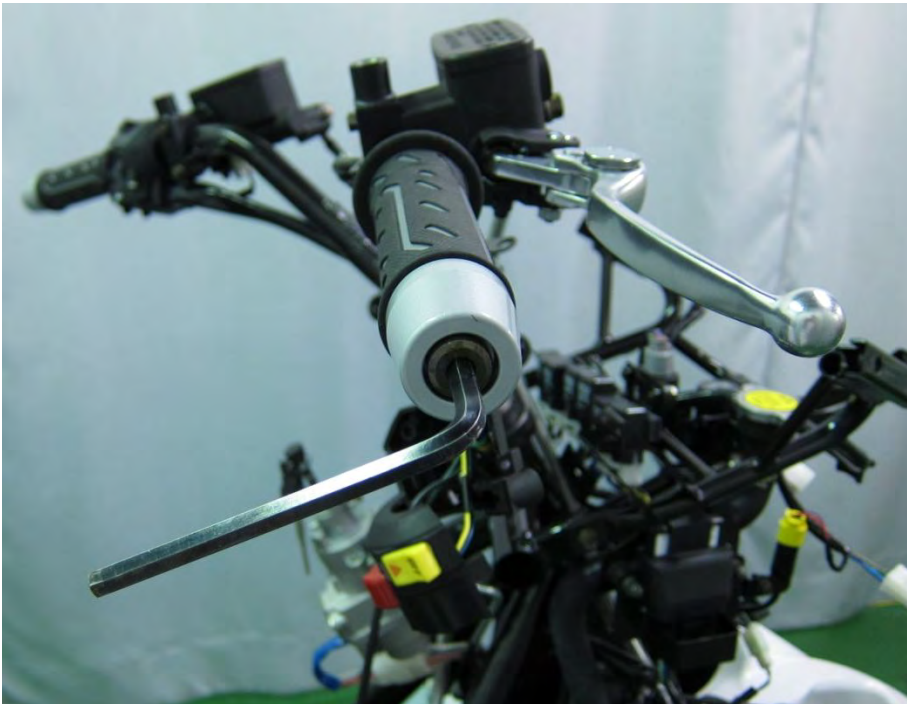

Install the bar ends with a 6 mm Allen.

Install the front cover. See the [Front Cover](#) topic for more information.

Install the handlebar covers. See the [Handlebar Covers](#) topic for more information.

Check the throttle free play. See the [Throttle Free Play](#) topic for more information.

Handlebar Covers

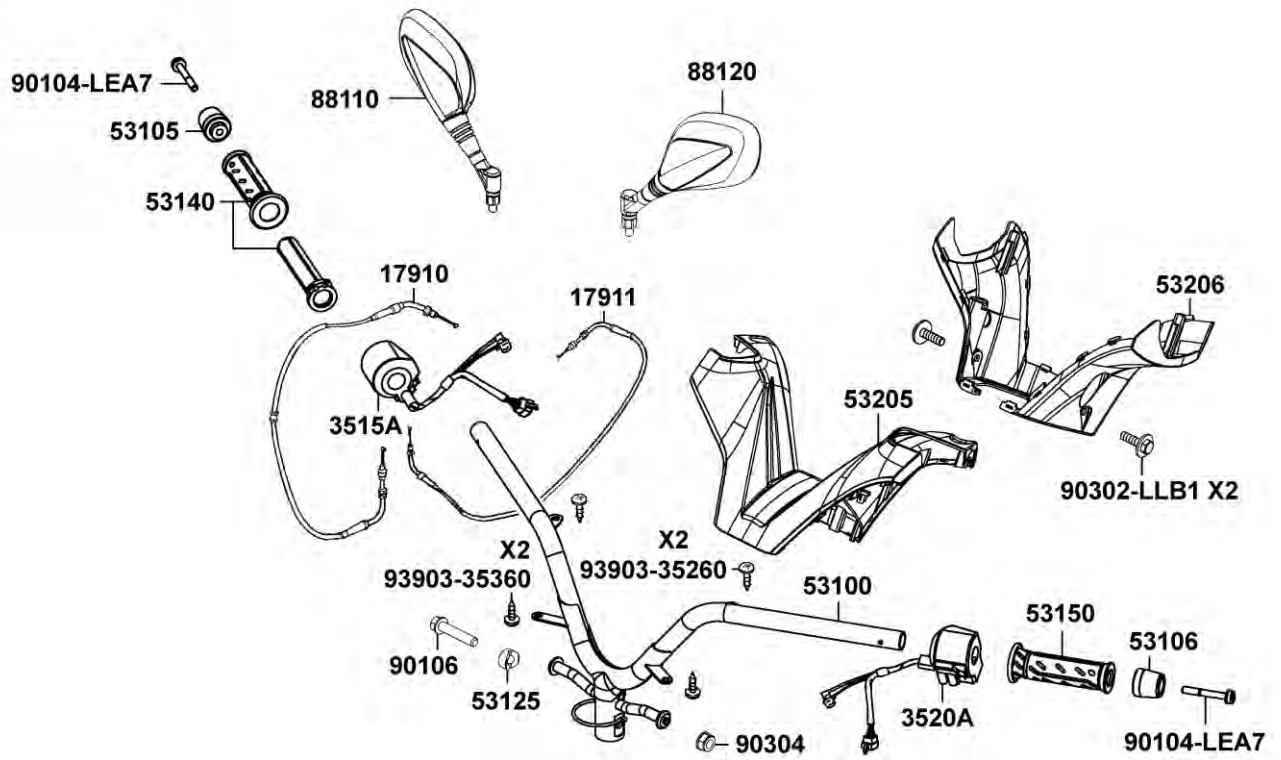

Removal

Upper Cover



Remove the four cover screws with a #2 Phillips.



Lift up the rubber cover and loosen the mirror with a 17 mm wrench.

Remove both mirrors in the same manner.

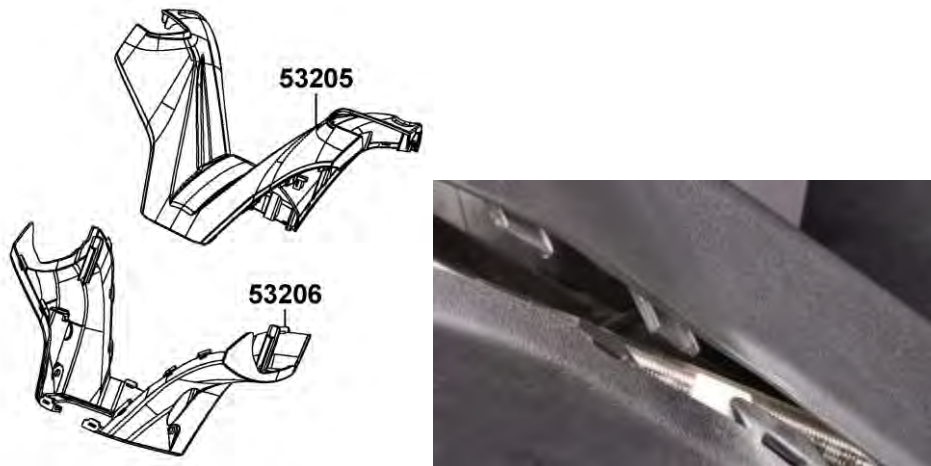

Carefully free the tabs and remove the upper handlebar cover.

Lower Cover

Remove the luggage box. See the [Seat](#) topic for more information.

Remove the throttle cables from the throttle body. See the [Throttle Body Removal and Installation](#) topic for more information.



Route the throttle cables out of the handlebar cover.



Remove the four cover bolts and screws.

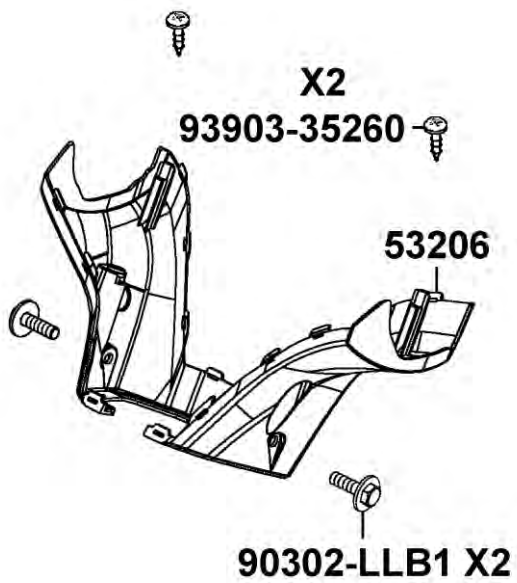

Remove the lower cover.

Stands

Side stand

Removal

Remove the luggage box. See the [Luggage Box](#) topic for more information.

Remove the foot skirt.

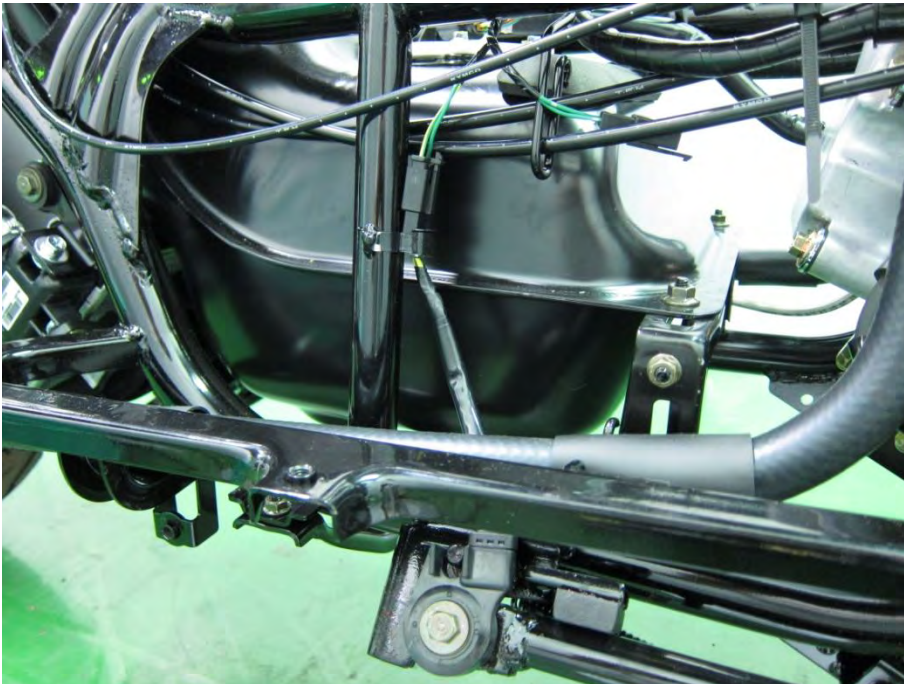

Unplug the three-pin side stand switch connector.



Remove the side stand spring with a spring puller.

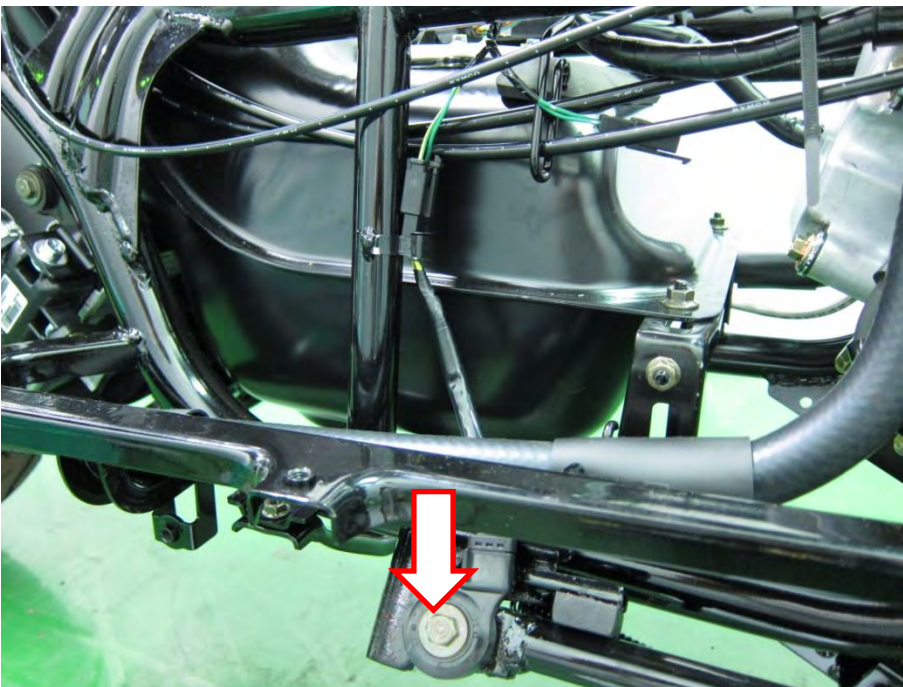

Remove the side stand bolt, switch, and side stand.

Center Stand

Removal



Remove the center stand spring with a spring puller.



Remove the two center stand nuts and bolts. Remove the center stand.

4.Engine

This chapter covers the location and servicing of the engine components for the KYMCO Downtown 350i model.

<u>Cylinder Head Cover</u>	4-5
<u>Camshaft</u>	4-8
<u>Cylinder Head</u>	4-23
<u>Valves</u>	4-31
<u>Cylinder and Piston</u>	4-37
<u>Starter Clutch</u>	4-62
<u>Generator</u>	4-69
<u>Oil Pump</u>	4-73
<u>Crankcase</u>	4-77
<u>Crankshaft</u>	4-87
<u>Engine Removal</u>	4-90

GENERAL INSTRUCTIONS

Lubrication System

The maintenance of lubrication system can be performed with the engine installed in the frame. Use care when removing and installing the oil pump not to allow dust and foreign matters to enter the engine and oil line.

Do not attempt to disassemble the oil pump.

After the oil pump is installed, check each part for oil leaks.

TROUBLESHOOTING**Oil level too low**

1. Natural oil consumption
2. Oil leaks
3. Worn or poorly installed piston rings
4. Worn valve guide or seal

Poor lubrication pressure

1. Oil level too low
2. Clogged filter or oil passages
3. No use the specified oil

Cylinder Head Camshaft and Valves

- The cylinder head can be serviced with the engine installed in the frame. Coolant in the radiator and water hoses must be drained.
- When assembling, apply molybdenum disulfide grease or engine oil to the valve guide movable parts and valve arm sliding surfaces for initial lubrication.
- The valve rocker arms are lubricated by engine oil through the engine oil passages. Clean and unclog the oil passages before assembling the cylinder head.
- After disassembly, clean the removed parts and dry them with compressed air before inspection.
- After removal, mark and arrange the removed parts in order. When assembling, install them in the reverse order of removal.

TROUBLESHOOTING

- The poor cylinder head operation can be diagnosed by a compression test or by tracing engine top-end noises.

Poor performance at idle speed

- Compression too low

Compression too low

- Incorrect valve clearance adjustment
- Burned or bent valves
- Incorrect valve timing
- Broken valve spring
- Poor valve and seat contact
- Leaking cylinder head gasket
- Warped or cracked cylinder head
- Poorly installed spark plug

Compression too high

- Excessive carbon build-up in combustion chamber

Abnormal noise

- Incorrect valve clearance adjustment
- Sticking valve or broken valve spring
- Damaged or worn camshaft
- Worn cam chain tensioner
- Worn camshaft and rocker arm

White smoke from exhaust muffler

- Worn valve stem or valve guide
- Damaged valve stem oil seal

Cylinder and Piston

- The cylinder and piston cannot be serviced with the engine installed in the frame.
- After disassembly, clean the removed parts and dry them with compressed air before inspection.
- If replacing the piston or cylinder, they must be changed as a pair.

TROUBLESHOOTING

Compression too low or uneven compression

- Worn, stuck or broken piston rings
- Worn or damaged cylinder and piston

Compression too high

- Excessive carbon build-up in combustion chamber or on piston head.

Excessive smoke from exhaust muffler

- Worn or damaged piston rings
- Worn or damaged cylinder and piston

Abnormal noisy piston

- Worn cylinder, piston and piston rings
- Worn piston pin hole and piston pin

Cylinder Head Cover

SAFETY FIRST: Protective gloves and eyewear are recommended at this point.

Removal

Remove the seat. See the [Seat](#) topic for more information.

Remove the luggage box. See the [Luggage Box](#) topic for more information.



Squeeze the breather hose clamp with needle nose pliers and slide it back. Remove the breather hose from the cylinder head cover.



Loosen the fuel hose stay bolt with an 8 mm socket. Free the fuel hose stay from the cylinder head cover.



Loosen the four cylinder head cover bolts with a 10 mm socket. Remove the cylinder head cover bolts with washers and grommets. Note the gold colored and longer bolts are on the left side.



Remove the cylinder head cover and gasket. Discard the gasket and replace it with a new item on installation.



Remove the dowel pin.

Camshaft

SAFETY FIRST: Protective gloves and eyewear are recommended at this point.

Removal

Remove the seat. See the [Seat](#) topic for more information.

Remove the luggage box. See the [Luggage Box](#) topic for more information.

Remove the spark plug. See the [Spark Plug](#) topic for more information.

Remove the cylinder head cover. See the [Cylinder Head Cover](#) topic for more information.

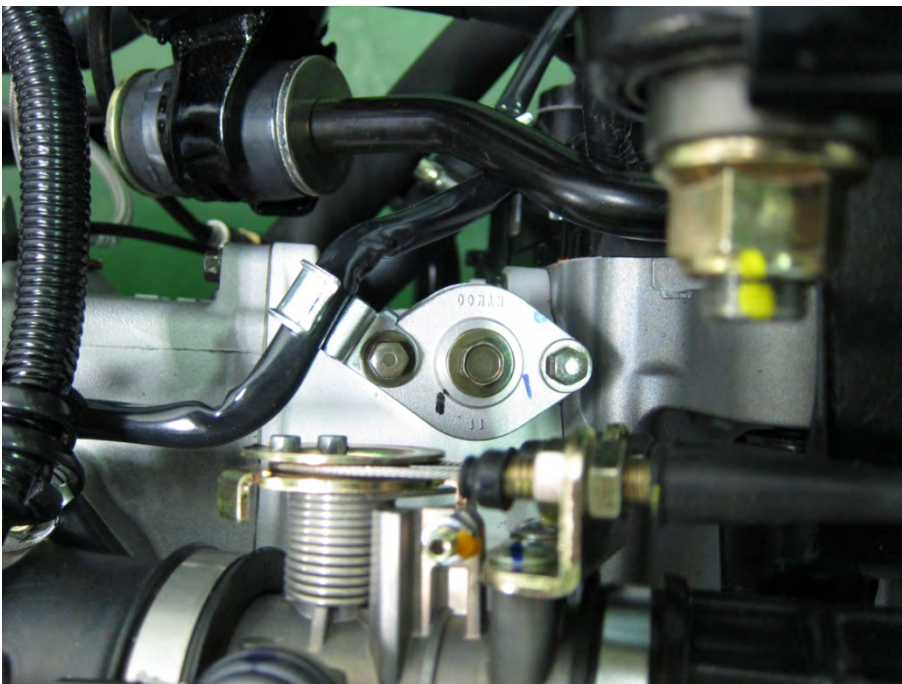

The cam chain tensioner is located on the back of the cylinder.



Remove the cam chain tensioner cap bolt with a 10 mm socket.



Loosen the cam chain tensioner mounting bolts evenly with an 8 mm socket.



Lift the cam chain tensioner out of the cylinder. Remove the cam chain tensioner gasket.



Use a 5 mm Allen wrench to remove the camshaft sprocket bolts.



Remove the camshaft sprocket as shown. Support the chain so it does not fall into the cylinder head.



Use a 5 mm Allen wrench to remove the set plate bolt.



Remove the set plate as shown.



Thread a bolt into the rocker arm shafts and pull the shafts out.



Lift out the rocker arms as the shafts are removed.



Remove the camshaft from the cylinder head.

Inspection

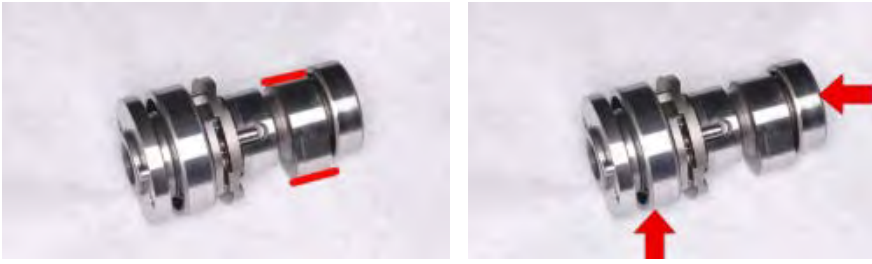

Inspect the camshaft cam heights for the intake and exhaust lobes. Inspect the camshaft bearings for excessive play or roughness. Replace the entire camshaft assembly if the bearings are rough or have excessive play.

Item		Standard (mm)
Camshaft cam height	IN	34.2987
	EX	34.1721

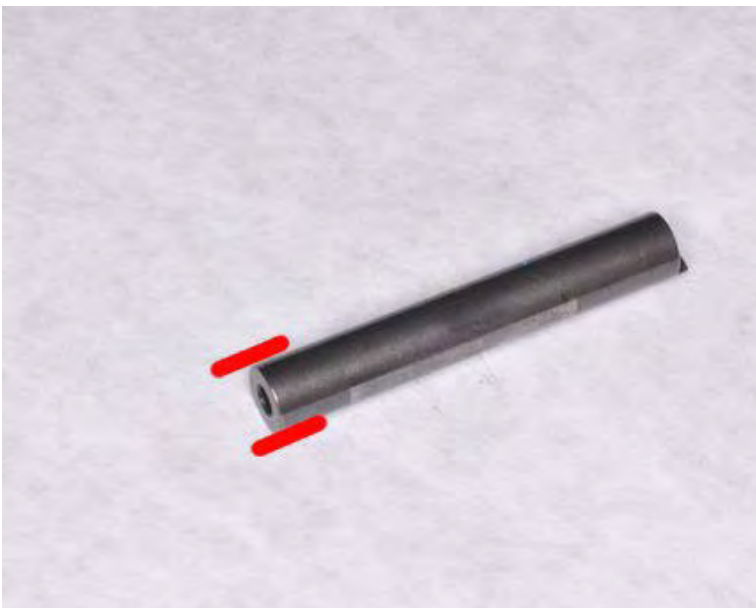

Inspect the rocker arm shaft outer diameter for the intake and exhaust valves.

Item		Standard (mm)
Valve rocker arm shaft O.D.	IN	9.972 - 9.987
	EX	9.972 - 9.987



Inspect the rocker arm inner diameter for the intake and exhaust valves.

Item		Standard (mm)
Valve rocker arm I.D.	IN	10.00 - 10.015
	EX	10.00 - 10.015



Inspect the camshaft bearing journals for scoring or scratches.



Inspect the camshaft sprocket for worn teeth or other signs of wear or damage.

Camshaft Installation

Clear out the cylinder head oil passages with compressed air. Make sure all cylinder head oil passages are free of clogs.

NOTE: Always wear safety glasses when using compressed air and never point it directly at yourself or anyone else.

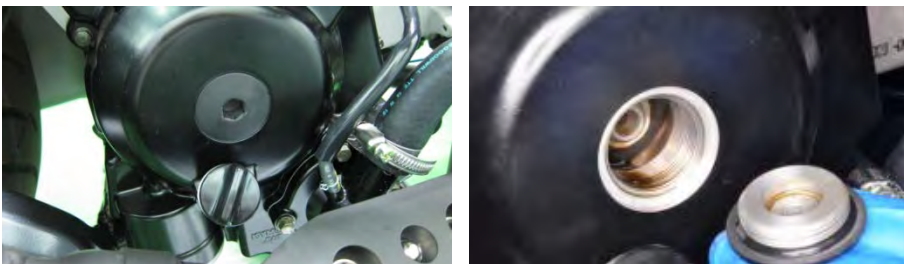

Remove the crankshaft cap on the right side of the engine with a large flat blade screwdriver. Inspect the O-ring on the cap and replace it as needed.



Remove the timing inspection cap from the right side of the engine with a large flat blade screwdriver. Inspect the O-ring on the cap and replace it as needed.



The crankshaft must be rotate (clockwise) until the piston is at top dead center (TDC) on the compression stroke.



Position the piston at top dead center as above. The "T" mark should be aligned with the index notch in the timing inspection hole. Support the cam chain if the crank must be turned to position the piston correctly.

Lubricate the camshaft lobes and bearings with fresh engine oil.



Insert the camshaft into the camshaft holders with the lobes facing down.



Lubricate the inside diameter of the rocker arms and the roller with fresh engine oil. Position the rocker arms to accept the rocker arm shafts.



Wipe the rocker arm shafts clean. Insert the rocker arm shafts through the camshaft holders and rocker arms. Install the rocker arm shafts so that the end sits as shown.



Install the camshaft set plate so it fits into the groove on the camshaft and between the projections on the rocker arm shafts.



Apply a small amount of blue Loctite (non-permanent) to the threads of the set plate bolt. Thread in the bolt and tighten it to specification with a 5 mm Allen socket.

Item	Qty	Thread size (mm)	Torque	
			kgf-m	lb-ft
Camshaft set plate bolt	1		1.2	2.0



Install the camshaft sprocket onto the camshaft so the camshaft sprocket boss fits into the appropriate hole on the camshaft sprocket. Make sure the camshaft sprocket boss is facing up so it is visible above the edge of the cylinder head as shown. Align the horizontal marks on the camshaft sprocket with the top edge of the cylinder head as shown. Fit the camchain over the camshaft sprocket.

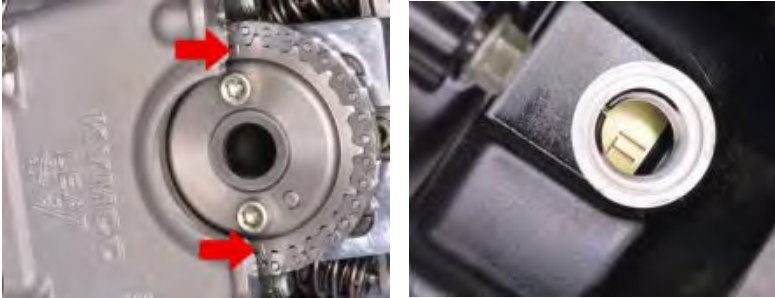

For correct engine timing the marks on the camshaft sprocket must be even with the cylinder head mating surface at the same time the "T" mark is lined up with the with the index notch in the timing inspection hole. The camshaft lobes should be facing down and their should be slack in the rocker arms.



Apply a small amount of blue Loctite (non-permanent) to the threads of the camshaft sprocket bolts. Thread in the camshaft sprocket bolts and tighten to specification using a 5 mm Allen socket.

Item	Qty	Thread size (mm)	Torque	
			kgf-m	lb-ft
Cam sprocket bolt	2	6	1.0-1.4	7.23-10.13

Double check the engine timing.



Use a small flat blade screwdriver bring in the cam chain tensioner rod. Turn the screwdriver counter clockwise to retract the rod. The rod must be held in with the screwdriver until the cam chain tensioner mounting bolts have been installed.



Install the camchain tensioner with a new gasket. Insert the mounting bolts and tighten them evenly to specification with an 8 mm socket. Remove the screwdriver and release the camchain tensioner rod.

Item	Qty	Thread size (mm)	Torque	
			kgf-m	lb-ft
Cam chain tensioner bolt	2	6	1.0-1.4	7.23-10.13



Rotate the crankshaft 360° clockwise and check the engine timing one more time.



Make sure the cam chain tensioner cap bolt O-ring is in good condition. Install the O-ring and cam chain tensioner cap bolt. Tighten the bolt to securely with a 10 mm socket.

Check the valve clearance. See the [Valve Clearance](#) topic for more information.



Make sure the O-rings on the crankshaft and timing plugs are in good condition. Replace them as needed. Install the timing inspection and crankshaft caps to the right side of the engine. Tighten the caps securely but not overly with a large flat blade screwdriver.

Install the cylinder head cover. See the [Cylinder Head Cover](#) topic for more information.

Install the spark plug. See the [Spark Plug](#) topic for more information.

Install the luggage box. See the [Luggage Box](#) topic for more information.

Install the seat. See the [Seat](#) topic for more information.

Cylinder Head

SAFETY FIRST: Protective gloves and eyewear are recommended at this point.

Removal

Remove the spark plug. See the [Spark Plug](#) topic for more information.

Remove the seat. See the [Seat](#) topic for more information.

Remove the luggage box. See the [Luggage Box](#) topic for more information.

Drain the coolant. See the [Coolant](#) topic for more information.

Remove the cylinder head cover. See the [Cylinder Head Cover](#) topic for more information.

Remove the camshaft sprocket. See the [Camshaft](#) topic for more information.

Remove the throttle body. See the [Throttle Body Removal and Installation](#) topic for more information.

Remove the exhaust system. See the [Exhaust System](#) topic.

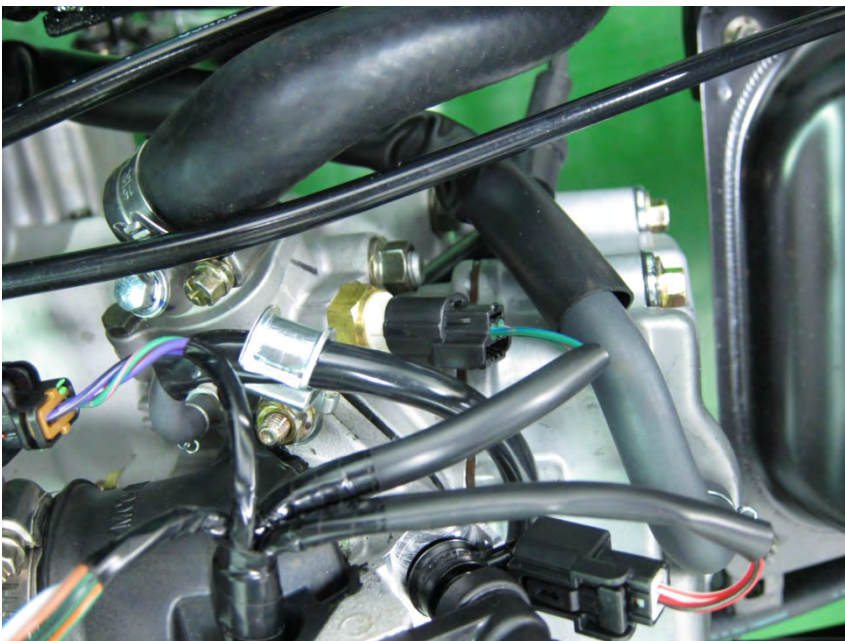

Unplug the water temperature sensor.

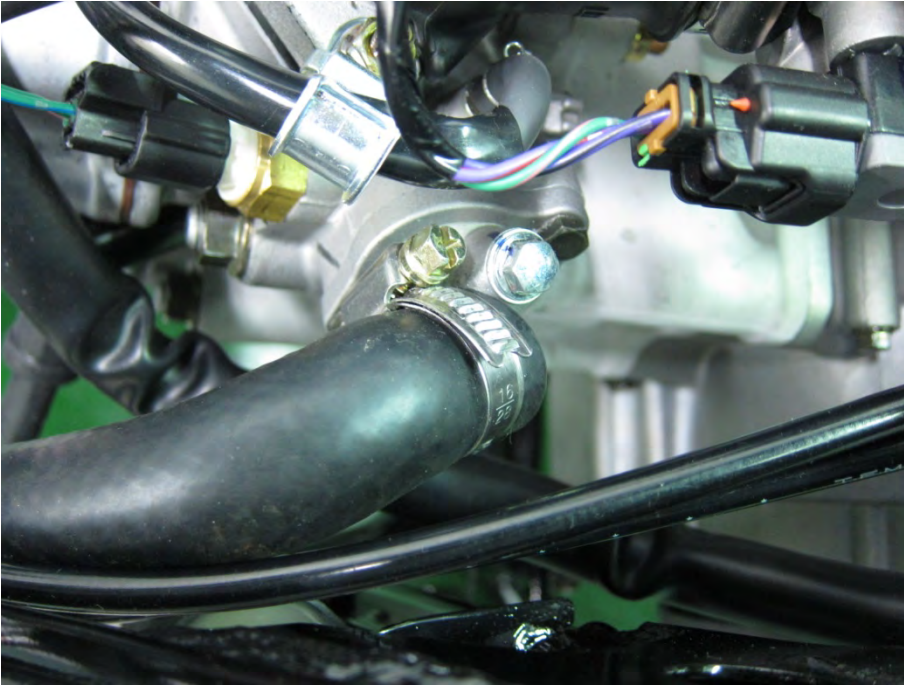

Loosen the thermostat hose clamp with a #2 Phillips screwdriver. Slide up the clamp and free the coolant hose from the thermostat. Allow any remaining coolant to drain into a suitable container.

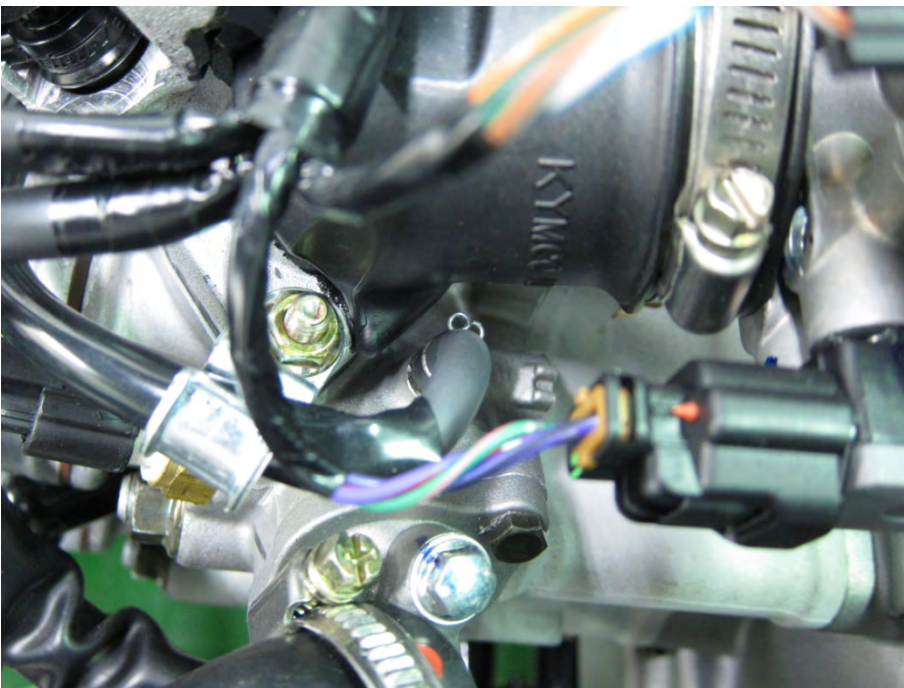

Squeeze the air bleed hose clamp with needle nose pliers and slide back the clamp. Free the air bleed hose from the thermostat.



Remove the two right side cylinder head bolts with an 8 mm socket. Also, loosen the two cylinder bolts below with an 8 mm socket.



There are two cylinder head mounting nuts; one below the intake port and one below the exhaust port.



Loosen the upper nut with a 10 mm socket and the lower nut with a 10 mm wrench. Remove the two cylinder head mounting nuts.

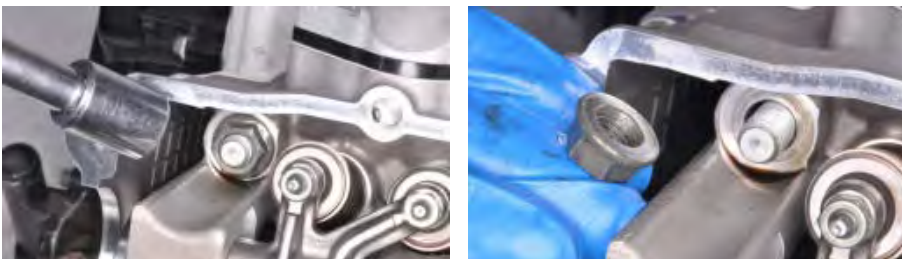
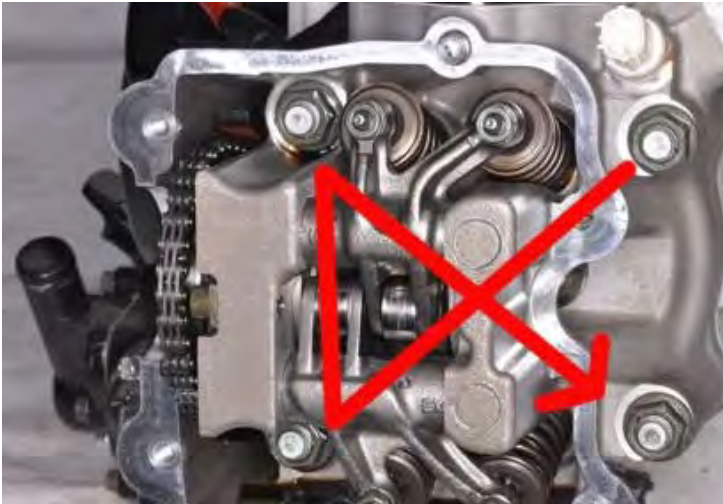

Remove the four camshaft holder nuts using a 14 mm socket. Loosen the camshaft holder nuts in a criss cross pattern over the course of 2-3 loosening sequences.

When installation:

Apply engine oil to the threads of the cylinder head nuts. Thread on the four cylinder head nuts and tighten to specification using a 14 mm socket. Tighten in criss cross pattern over the course of 2-3 rounds of tightening to reach specified torque.

Item	Qty	Thread size (mm)	Torque	
			kgf-m	lb-ft
Cylinder head stud nut	4	10	3.4-3.8	24.59-27.48

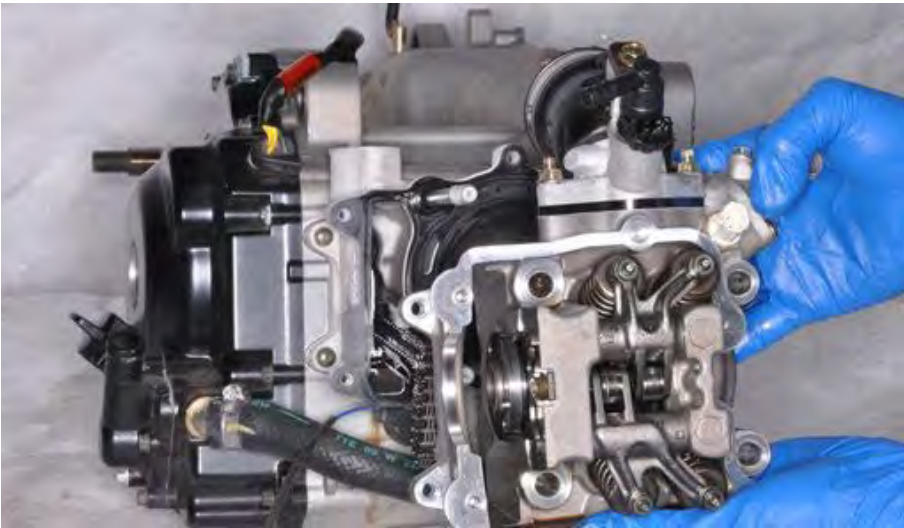

Lift the cylinder head off of the studs. Guide the cam chain through the opening in the cylinder head but do not allow the chain to fall into the crankcase.

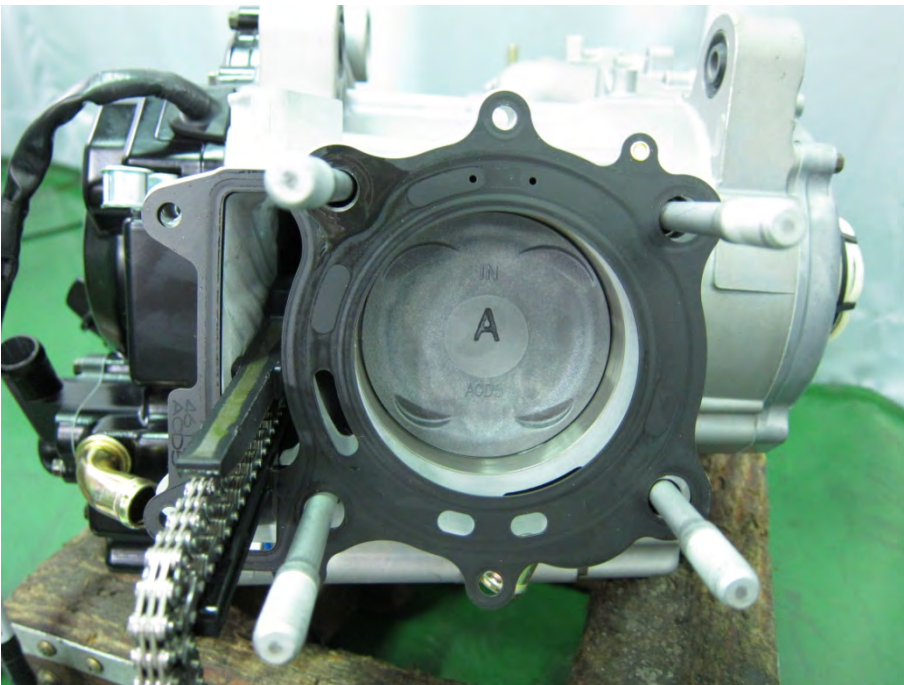

Remove the cylinder head gasket.



Remove the two dowel pins from the left side cylinder head studs.



Remove the two intake mounting nuts with a 10 mm socket.



Remove the intake from the cylinder head.



Inspect the intake O-ring and replace it as needed.



Remove the intake plate and gasket from the cylinder head.



Use a 17 mm wrench to remove the water temperature sensor if needed.



Clean the combustion chamber with contact cleaner, a plastic knife, brush and/or rag. Take care to only remove carbon and not scrape the head.

To to remove the valves see the [Valves](#) topic.



Place a straight edge across the bottom of the cylinder head and check for warp with a feeler gauge. You will need to check clearance readings from several places on the bottom of the cylinder head surface for warp.

Valves

SAFETY FIRST: Protective gloves and eyewear are recommended at this point.

Removal

Remove the camshaft. See the [Camshaft](#) topic for more information.

Remove the cylinder head. See the [Cylinder Head](#) topic for more information.

IMPORTANT: Record the position of all parts so they can be returned to their proper place during reassembly.



Push down the valve springs with a valve spring compressor.
Special Tool- Valve Spring Compressor: E040



Remove the split keepers. There are two per valve.



Remove the spring retainer.



Remove the valve springs.



Push the valve stem down and remove the valve from the combustion chamber side of the cylinder head. Rotate the valve as it is removed.



Remove the valve seal from the valve guide. The valve seals should be replaced if they are removed or you are going to install new valves.



Remove the spring seat.

Inspection



Inspect the valve springs for fatigue and damage. Replace the valve springs as needed or if the valve is also to be replaced.





Inspect the valves for damage and burning. Measure the valve stem diameter in several places where the valve makes contact with the guide. If the measurement is below specification replace the valve.

Item		Standard (mm)
Valve stem O.D.	IN	4.990 - 4.975
	EX	4.970 - 4.955

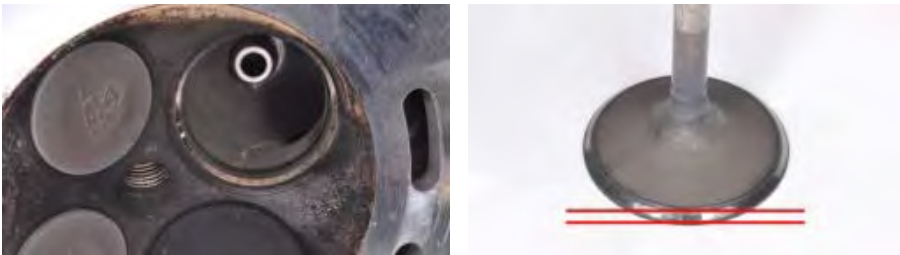

Inspect the valve seat and the valve seat width. The valve seat should be centered on the valve face. If the seat is pitted, worn out, or fits poorly on the valve face the valve seat must be resurfaced.

Item		Standard (mm)
Valve seat width	IN	1.2
	EX	1.2



Measure the inside diameter of the valve guides. Replace the guides if the measurement is out of specification. Calculate the valve stem-to-guide clearance. Replace the guide and valve if the clearance is out of specification.

Item		Standard (mm)
Valve guide I.D.	IN	5.00 - 5.012
	EX	5.00 - 5.012
Valve stem-to-guide clearance	IN	0.010 - 0.037
	EX	0.030 - 0.057

Cylinder and Piston

SAFETY FIRST: Protective gloves and eyewear are recommended at this point.

Cylinder Block Removal

Remove the engine from the frame. See the [Engine Removal](#) topic for more information.

Remove the cylinder head cover. See the [Cylinder Head Cover](#) topic for more information.

Remove the camshaft sprocket. See the [Camshaft](#) topic for more information.

Remove the cylinder head. See the [Cylinder Head](#) topic for more information.



Slide out the lower cam chain guide. Inspect the guide for excessive wear and damage. Replace the guide as needed.



Remove the two right side cylinder bolts with an 8 mm socket.



Loosen the cylinder coolant hose clamp with a #2 Phillips screwdriver. Free the coolant hose from the cylinder.



Slide the cylinder off of the studs and piston. Guide the cam chain through its opening and do not allow it to fall into the crankcase. Remove the cylinder.



Remove the base gasket.



Remove the two cylinder dowel pins from the left studs.

Place a clean shop towel under and around the base of the piston to prevent any parts or debris falling into the crankcase.

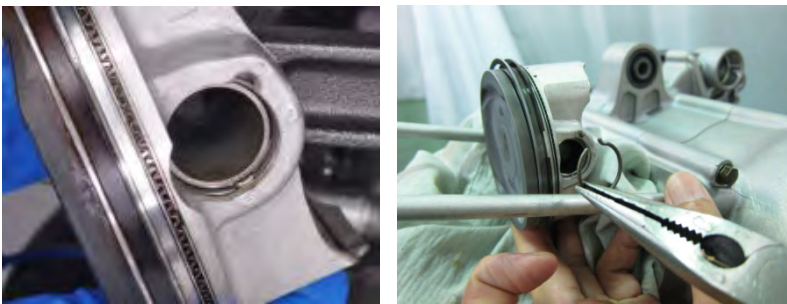

Remove the piston pin clips with a pick or needle nose pliers. Discard the piston pin clips.



Remove the piston pin and the piston.

Clean off the cylinder mating surface, but take care to keep debris from falling into the crankcase.



Spread the piston rings and lift them off opposite the gap. Spread the rings the minimum amount during removal. The rings can be easily damaged.

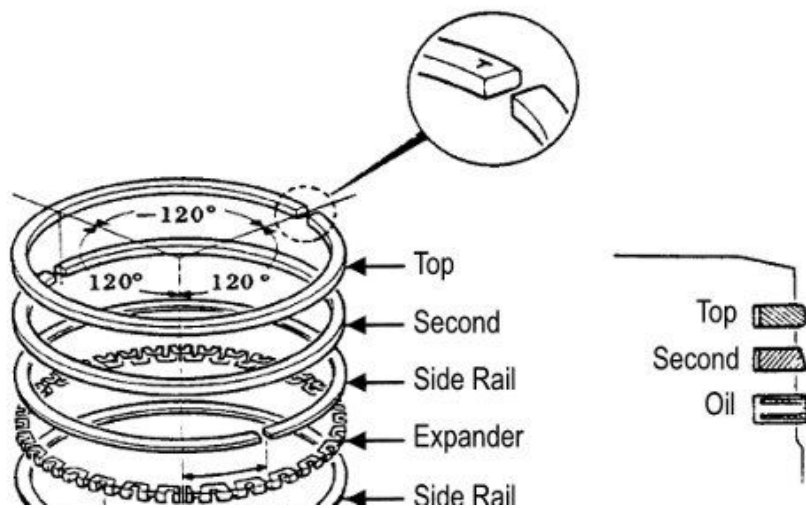

The two upper rings are each a single piece of metal. The oil ring consists of an expander ring and two side rails.



Clean the carbon build up off of the piston with a stiff bristled plastic brush or rag. Never use a wire brush to clean a piston.



Also clean out the ring grooves. You can use an old ring to scrape out any carbon build up in the grooves.

Inspection

The cylinder and piston must be replaced as a set. There are two sets of cylinder and piston combinations. Make sure to have a No.A cylinder with an "A" piston or a No.B cylinder with a "B" piston.

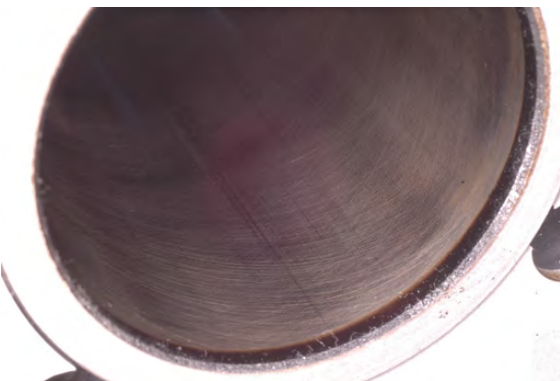

Inspect the cylinder bore for damage and abnormal wear.



Measure the cylinder diameter as described below with a telescoping gauge.

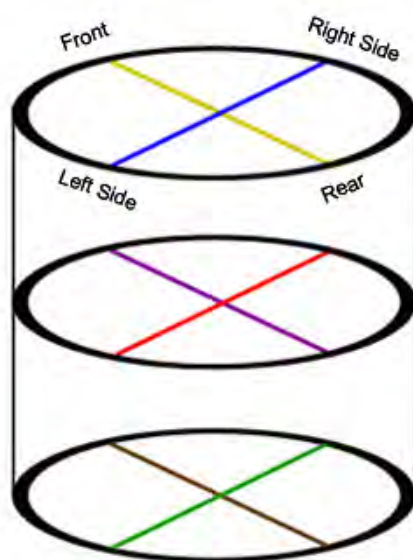

Inspect the cylinder front to back and side to side at three different height levels with a dial bore gauge. Replace the cylinder and piston as a set if the cylinder is out of specification.

Calculate the cylinder taper. The taper is the maximum difference between either yellow and brown or blue and green.

Calculate the cylinder out of round. The out of round is greatest out of yellow, purple, or brown minus the smallest of blue, red, or green.

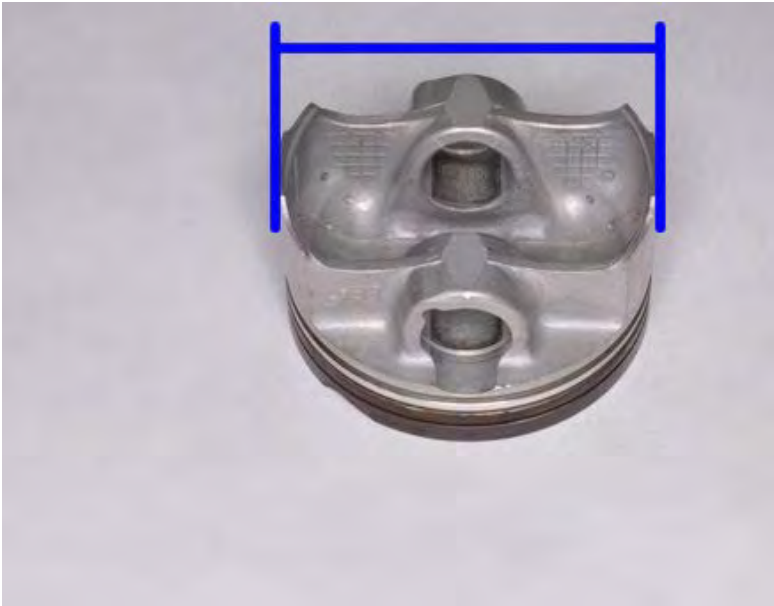

Measure the outside diameter of the piston at 9 mm up from the bottom of the skirt at a 90° angle to the piston pin. Measure the piston with vernier calipers or a micrometer. Check the piston for wear, damage, and extreme discoloration.

Subtract the diameter of the piston from the maximum front to rear diameter measurement of the cylinder to calculate the piston-to-cylinder clearance. Replace the piston and cylinder as needed to achieve a correct piston-to-cylinder clearance.

Item	Standard (mm)
Piston-to-cylinder clearance	0.010 - 0.030



Measure the piston pin diameter with a micrometer. Measure the piston pin bore diameter with vernier calipers or a small bore gauge. Measure at three different points for each. Replace the parts if any of the specifications are not met.

Item	Standard (mm)
Piston pin hole I.D.	15.002 - 15.008
Piston pin O.D.	14.994 - 15.000
Piston-to-piston pin clearance	0.002 - 0.014



Measure the inside diameter of the small end of the connecting rod with vernier calipers.

Item	Standard (mm)
Connecting rod small end I.D. Bore	15.016 - 15.034



Measure the ring groove width and the ring-to-groove clearance with feeler gauges.

Item		Standard mm
Piston ring-to-groove clearance	1st	0.015 - 0.055
	2nd	0.015 - 0.055



Insert the top ring into the cylinder. Push the top ring in the cylinder about an inch. Use the piston to push in the ring to keep it square with the cylinder.



Measure the ring gap with a feeler gauge. Repeat this procedure with second ring and the oil side rails.

Item		Standard mm
Ring end gap	Top	0.10 - 0.25
	Second	0.10 - 0.25
	Oil side rail	0.2 - 0.7



Check the oil jet for clogs.

Assembly



Clean the piston ring grooves and apply fresh engine oil to the piston rings. Spread the rings the minimum amount possible to install them. Do not try and force them on the piston.

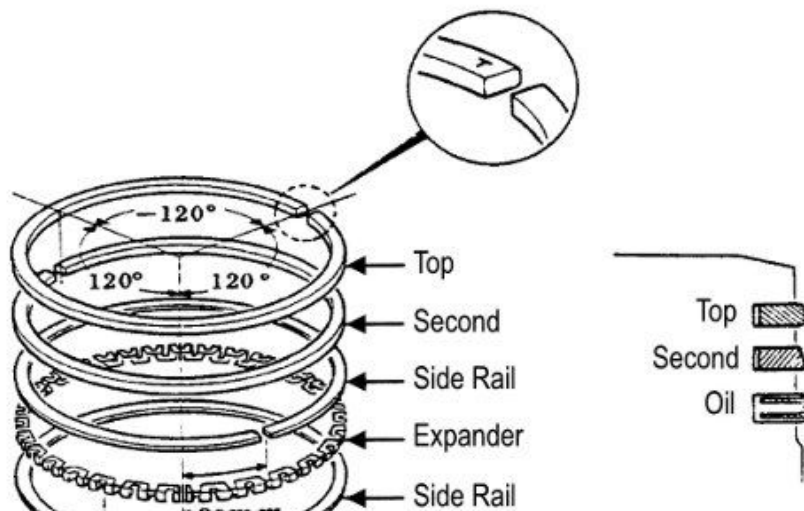

Install the top and second rings with their markings facing up. Install the rings to the piston as shown above so that no ring end gaps line up with the piston pin or perpendicular to the piston pin. The rings should turn easily on the piston without sticking or roughness.



Install the oil expander ring so that the ends are not overlapping. Install the steel rails above and below the oil ring.

Lubricate the piston pin and the small end of the connecting rod with fresh engine oil.

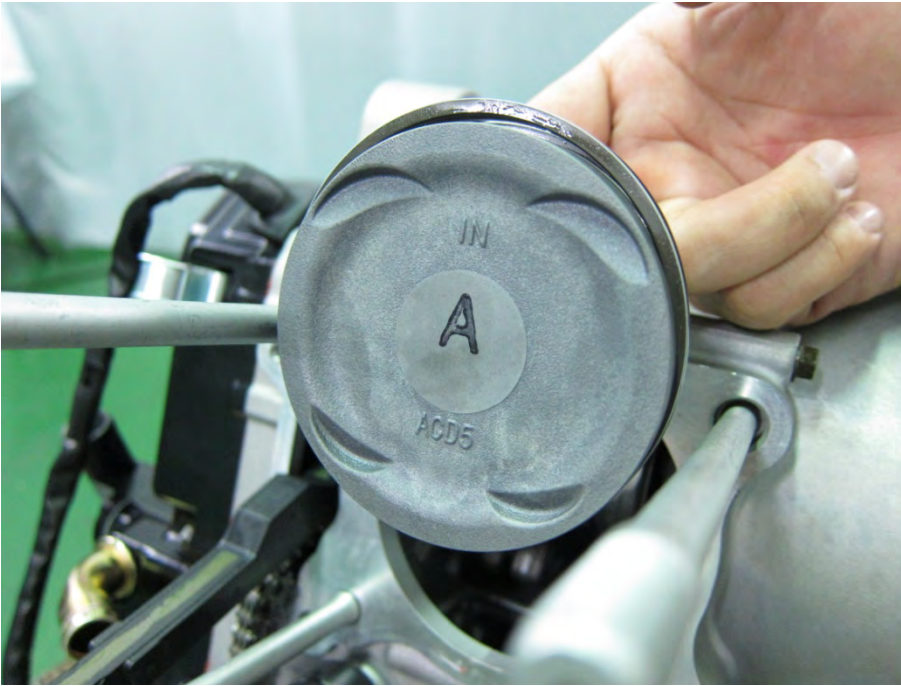

The "IN" mark should face the intake side (rear) of the engine.

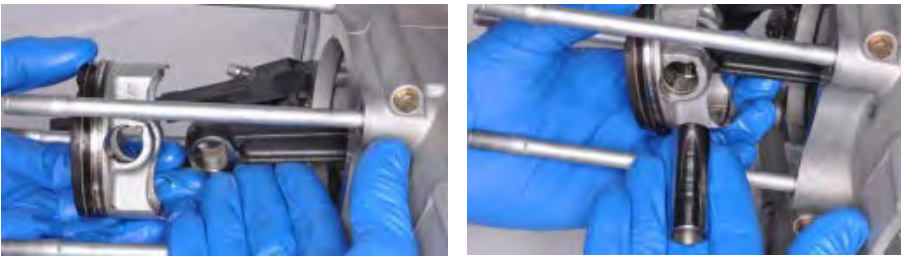

Place the piston over the connecting rod. Insert the piston pin into the piston and rod.



Install new piston pin clips securely into their grooves. Turn the gap in the clips away from the access gap.



Make sure the cylinder head mating surface is clean. Install the two dowel pins as shown.



Install the new base gasket onto the crankcase.



Coat the inside of the cylinder, piston rings, and piston in fresh engine oil. Lower the cylinder over the studs and guide the piston into the cylinder while you are compressing the rings with your fingers. Be careful to not damage the rings during this step. Bring the cam chain and guide through the opening.



Thread in the two cylinder bolts on the right side of the engine.



Fit the coolant hose to the cylinder. Tighten the cylinder coolant hose clamp to securely with a #2 Phillips screwdriver.



Insert the lower cam chain guide and make sure it is seated correctly.

Install the cylinder head. See the [Cylinder Head](#) topic.

Install the camshaft. See the [Camshaft](#) topic for more information.

Install the cylinder head cover. See the [Cylinder Head Cover](#) topic for more information.

Install the engine into the frame. See the [Engine Installation](#) topic for more information.

A.C. Generator and Starter clutch

SAFETY FIRST: Protective gloves and eyewear are recommended at this point.

Removal

Drain engine oil and remove the oil filter. See the [Engine Oil](#) topic for more information.

Drain the coolant. See the [Coolant](#) topic for more information.

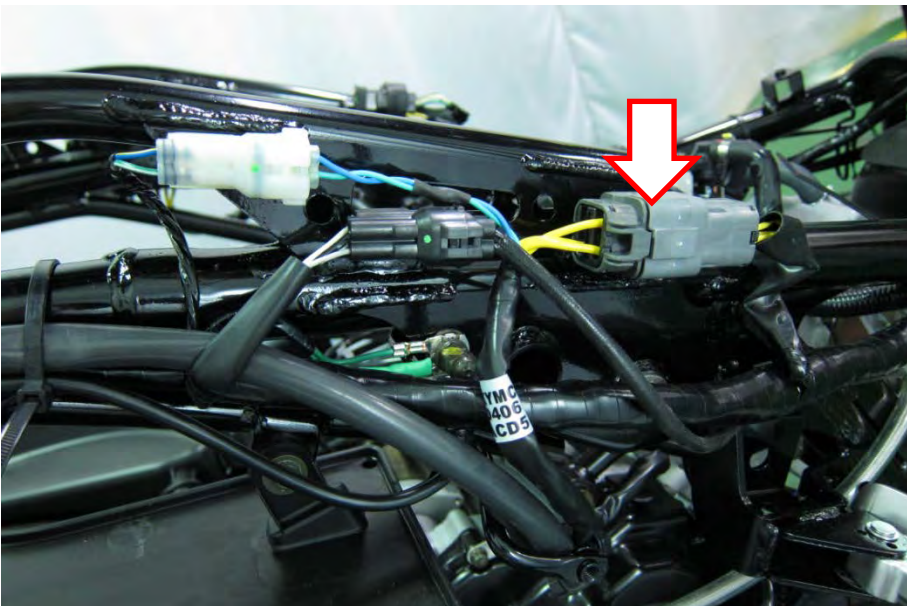

Disconnect the generator 3-pin connector.

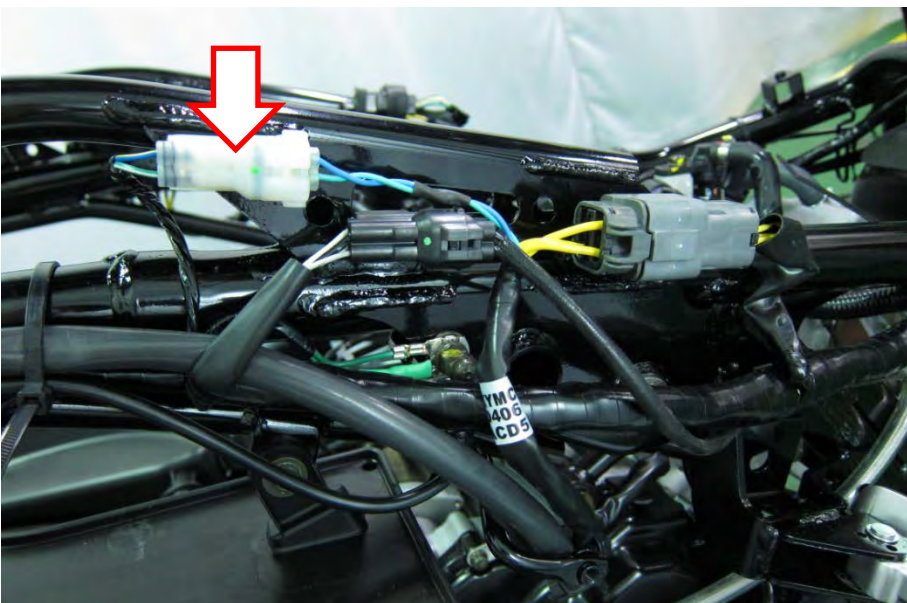

Disconnect the crank position sensor wire coupler.



Loosen the water pump hose clamp with a #2 Phillips screwdriver. Slide up the clamp and free the coolant hose from the water pump. Allow any remaining coolant to drain into a suitable container.



Loosen the right crankcase coolant hose clamp with a #2 Phillips screwdriver. Slide up the clamp and free the coolant hose from the right crankcase cover. Allow any remaining coolant to drain into a suitable container.





Remove the 12 generator cover bolts with an 8 mm socket.

Utilize the pry points and remove the generator cover.

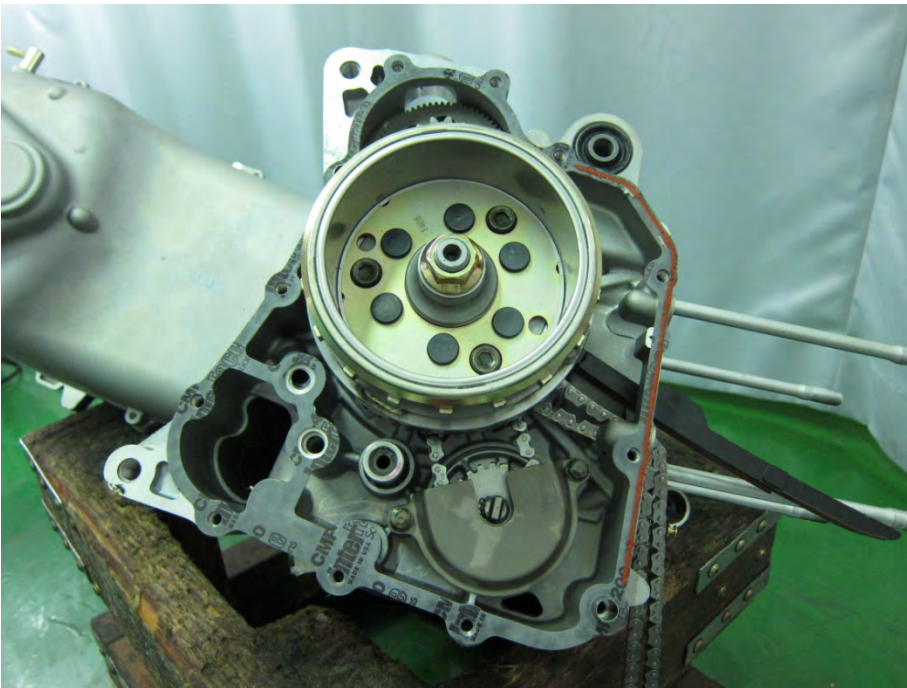

Remove the generator cover gasket.



Remove the two dowel pins.



Remove the two oil filter chamber O-rings. Inspect the O-rings and replace them as needed.

Stator and Pulsar Coil/Crank Position Sensor

To inspect the stator see the [Charging System](#) topic.

For crank position sensor inspection see the [Ignition System](#) topic.



Free the rubber wire grommet from the right crankcase cover.



Remove the three stator mounting bolts and the two crank position sensor bolts with an 8 mm socket. Remove the stator and the crank position sensor together.

Flywheel



To remove the fly wheel two special tools are needed.

ITEM	TOOL NO.
UNIVERSAL HOLDER	E021



ITEM	TOOL NO.
FLYWHEEL PULLER	E003

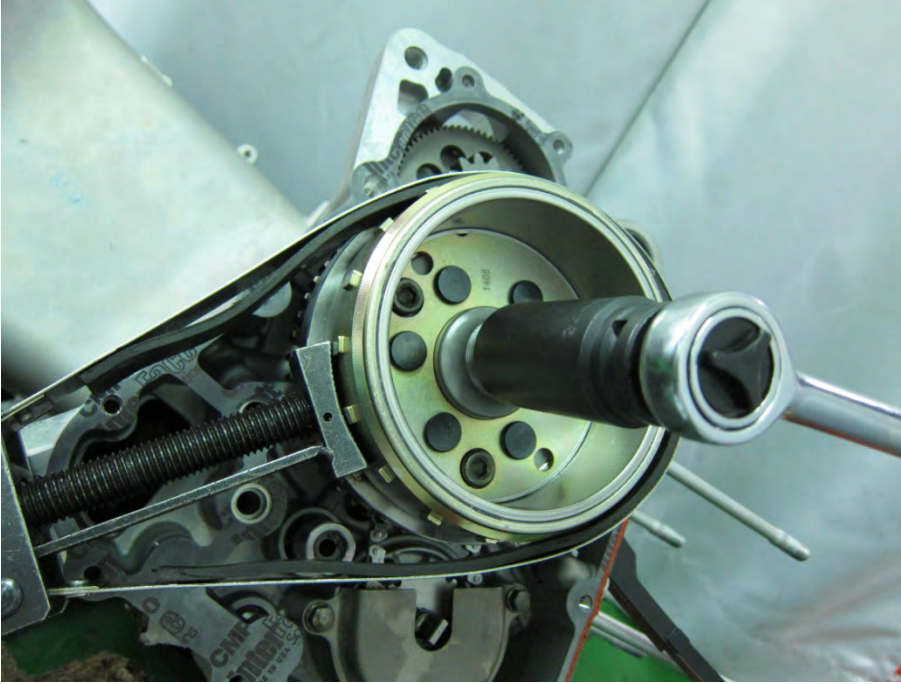

Hold the flywheel with the universal holder and loosen the nut with a 19 mm socket.

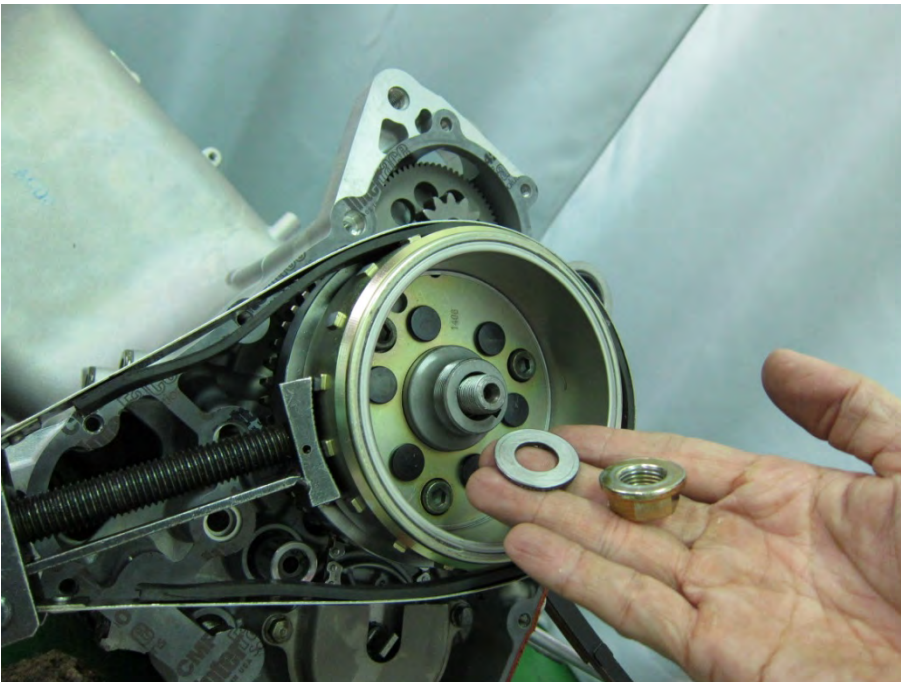

Remove the flywheel nut and washer.

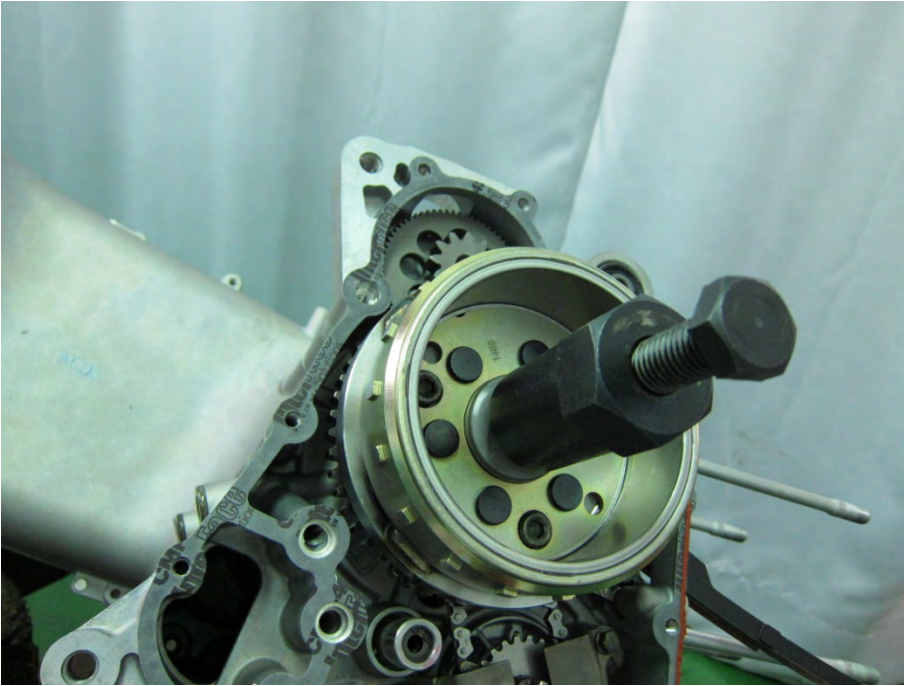

Apply grease to the threads of the flywheel puller tool before using it. Thread the puller onto the flywheel. Hold the tool with a large wrench and turn in the bolt until the pressure separates the flywheel from the crankshaft.



Remove the flywheel from the crankshaft.



Slide the starter driven gear off of the crankshaft.



Remove the woodruff key from the crankshaft.

Starter Clutch



Remove the starter idle gear and shaft from the crankcase.

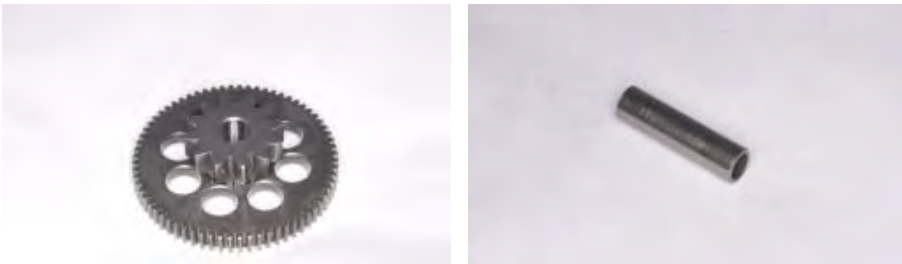

Inspect the starter idle gear and shaft for wear and damage. Replace the idle gear and shaft as needed.

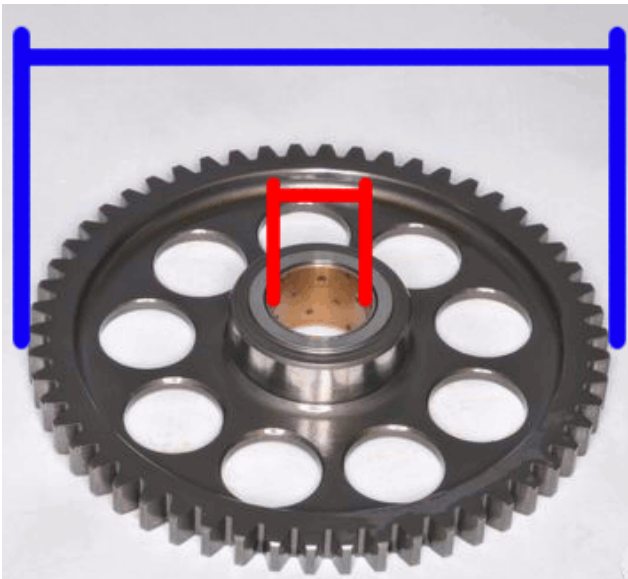

Inspect the starter driven gear for wear and damage. Measure the inside and outside diameter of the starter driven gear and replace it as needed.

Item	Service Limit (mm)
Starter drive gear I.D.	22.15
Starter drive gear O.D.	41.50



Fit the boss of the starter driven gear into the starter clutch. The starter clutch should only allow the driven gear to turn in one direction. If the starter clutch allows turning both ways or will not let the driven gear rotate smoothly in one direction the starter clutch must be replaced.



Remove the three starter clutch mounting bolts with a 6 mm Allen socket.

Installation

Starter Clutch



Fit the starter clutch to the back of the flywheel. Apply blue Loctite to the threads of the three starter clutch mounting bolts. Insert the three starter clutch mounting bolts.



Tighten the starter clutch mounting bolts to specification with a 6 mm Allen socket.

Item	Qty	Thread size (mm)	Torque	
			kgf-m	lb-ft
Oneway clutch bolt	3	8	1.8-2.2	13.02-15.91



Lubricate the starter idle gear shaft with fresh engine oil. Install the starter idle gear and shaft into the crankcase.

Flywheel



Install the woodruff key into its slot on the end of the crankshaft.



Lubricate the inside of the starter driven gear with fresh engine oil. Slide the starter driven gear onto the flywheel as shown.

Clean off the tapered end of the crankshaft where the flywheel will ride and make sure the inside of the flywheel is oil free where it will contact the crankshaft.



Line up the groove in the flywheel with the key and fit the flywheel onto the crankshaft. Guide the starter driven gear into the starter clutch on the back of the flywheel.

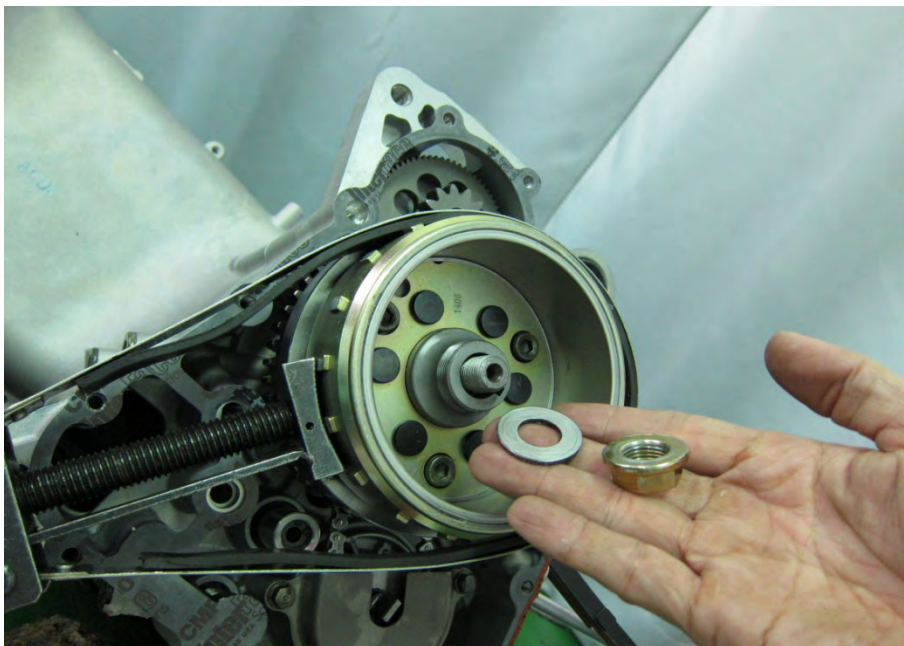

Install the washer and flywheel nut.



Hold the flywheel with the universal holder and torque the flywheel nut to specification with a 19 mm socket.

Item	Qty	Thread size (mm)	Torque	
			kgf-m	lb-ft
ACG flywheel nut	1	14	5.5-6.5	39.78-47.01

ITEM	TOOL NO.
UNIVERSAL HOLDER	E021

Stator and Crank Position Sensor



Fit the stator and the crankshaft position sensor into the generator cover together as shown. Insert the two crank position sensor mounting bolts and the three stator mounting bolts. Tighten the bolts securely with an 8 mm socket.



Coat the rubber grommet in silicone sealant where it contacts the generator cover. Fit the rubber wire grommet into its cutout in the crankcase cover.

Generator Cover



Make sure the generator cover mating surface is clean. Install the two dowel pins and a new generator cover gasket.

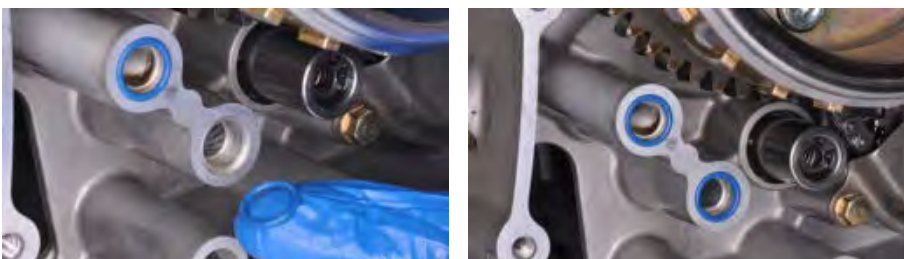

Make sure the oil filter chamber O-rings are in place and in good condition.



Fit the generator cover into place. Make sure the water pump shaft engages correctly with the oil pump shaft.

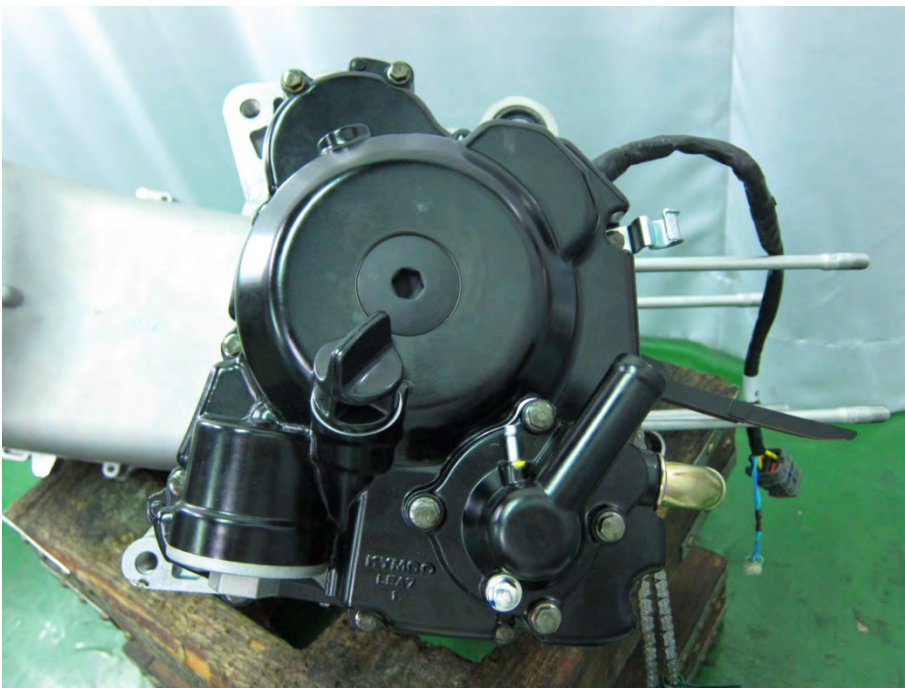

Insert the 12 generator cover bolts.
Tighten the bolts securely in a with an 8 mm socket.

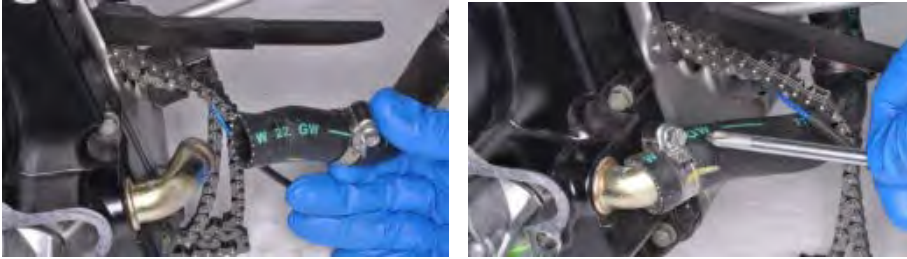

Fit the coolant hose to the right crankcase cover pipe. Secure the hose with the clamp and tighten the coolant hose clamp securely with a #2 Phillips screwdriver.

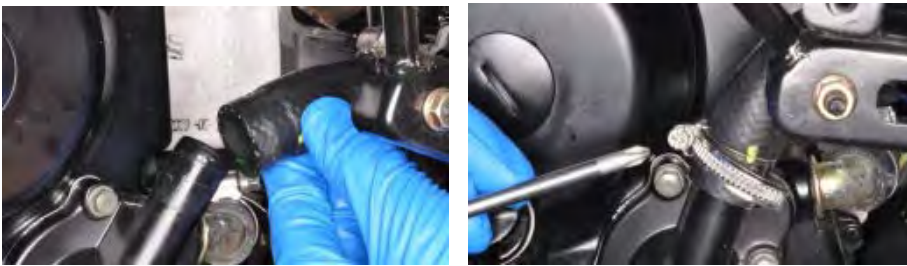

Connect the coolant hose to the water pump. Move the clamp into place and tighten it securely with a #2 Phillips screwdriver.

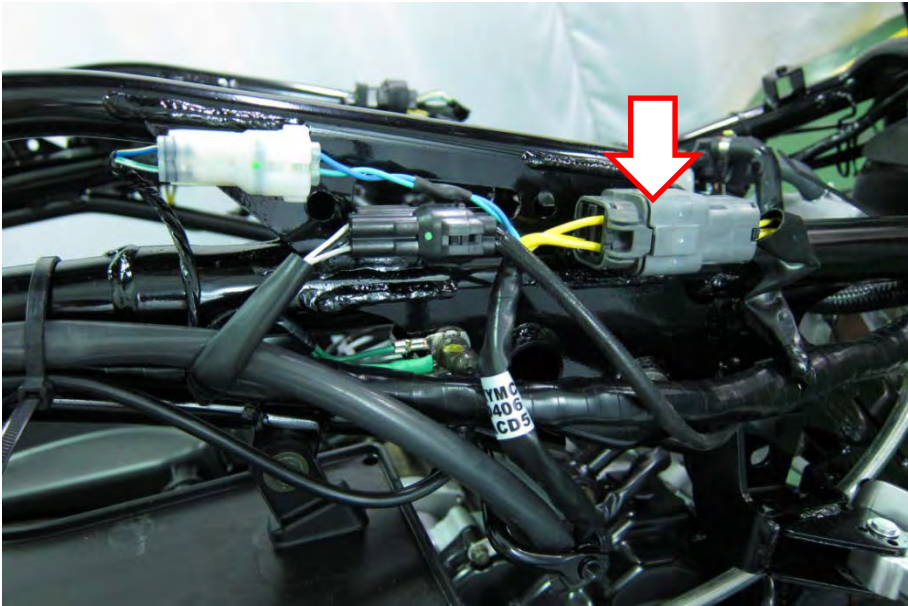

Plug in the regulator/rectifier 3-pin connector.

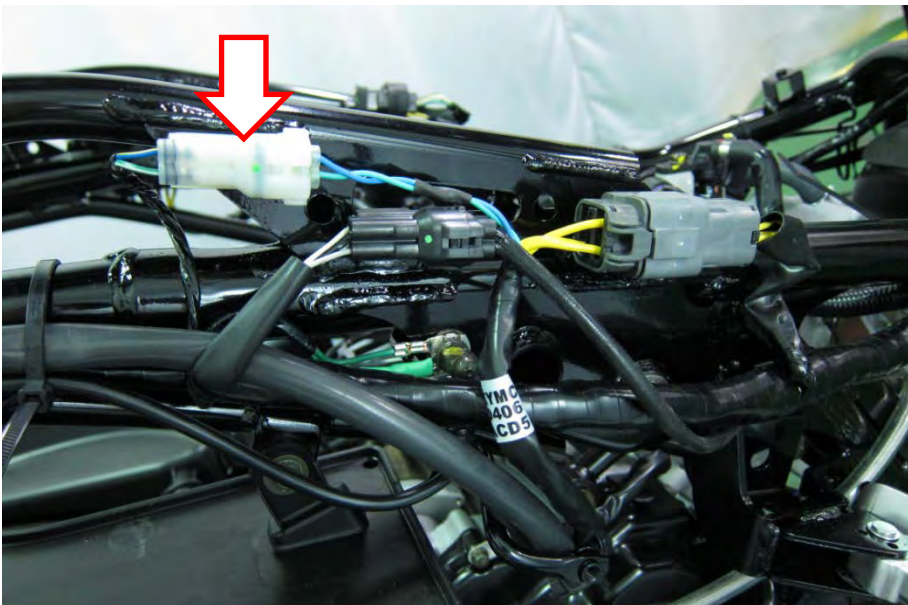

Plug in the crank position sensor wire coupler on the right side of the frame.
Fill the engine oil. See the [Engine Oil](#) topic for more information.
Install the exhaust system. See the [Exhaust System](#) topic for more information.
Fill the coolant and bleed the coolant. See the [Coolant](#) topic for more information.

Oil Pump

SAFETY FIRST: Protective gloves and eyewear are recommended at this point.

GENERAL INSTRUCTIONS

The maintenance of lubrication system can be performed with the engine installed in the frame. Use care when removing and installing the oil pump not to allow dust and foreign matters to enter the engine and oil line.

Do not attempt to disassemble the oil pump. The oil pump must be replaced as a set when it reaches its service limit.

After the oil pump is installed, check each part for oil leaks.

TROUBLESHOOTING

Oil level too low

1. Natural oil consumption
2. Oil leaks
3. Worn or poorly installed piston rings
4. Worn valve guide or seal

Poor lubrication pressure

1. Oil level too low
2. Clogged filter or oil passages
3. Not using the specified oil

Oil Pump Removal

Drain the engine oil. See the [Engine Oil](#) topic for more information.

Remove the generator cover, flywheel, starter idle gear and starter driven gear. See the [A.C. Generator and Starter clutch](#) topic.



The oil pump is driven by a chain off of the crankshaft.

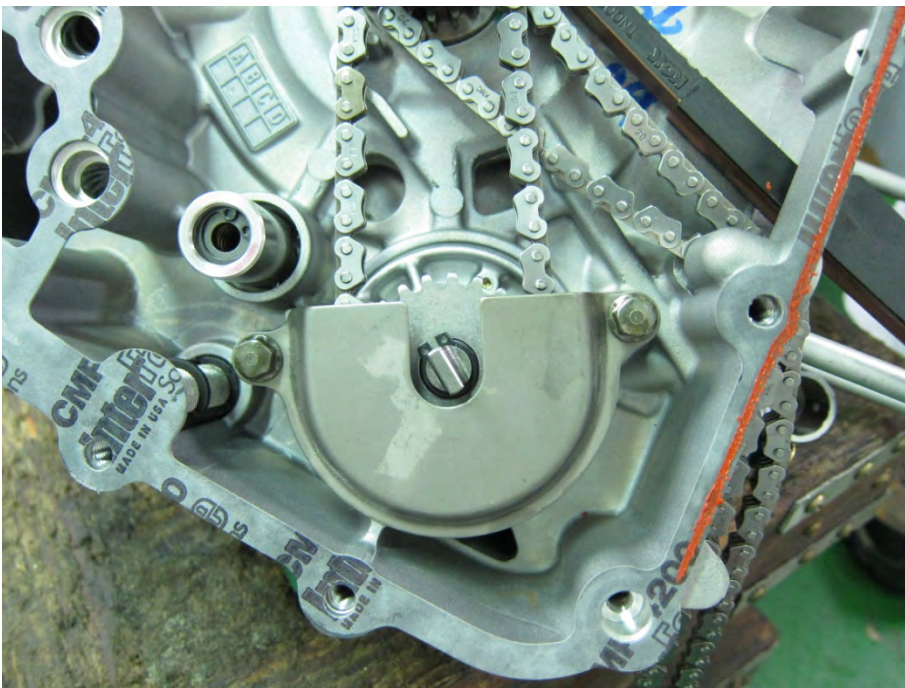

Loosen the two oil pump cover bolts with an 8 mm socket.

Remove the two oil pump cover bolts and the oil pump cover.

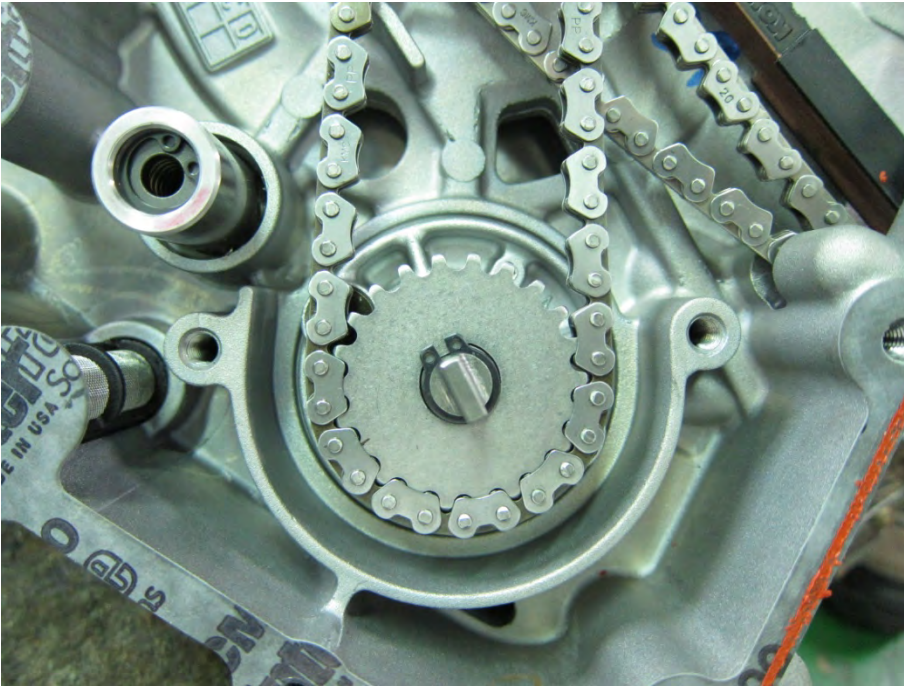

Remove the snap ring on the oil pump shaft with snap ring pliers.
Remove the oil pump drive chain and driven sprocket.



Inspect the oil pump drive chain and sprocket for signs of wear and damage.
Replace the parts as needed.

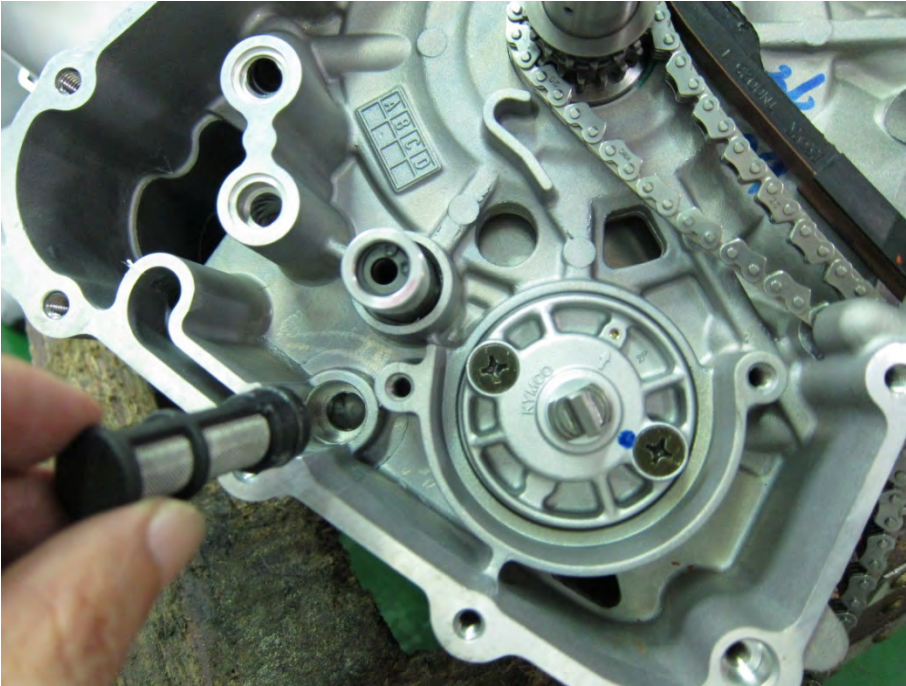

Remove the two oil pump screws with an impact #3 Phillips screwdriver.
Remove the filter.
Remove the oil pump.



Turn the oil pump shaft by hand and make sure it turns smoothly. If the oil pump shaft will not rotate smoothly the oil pump should be replaced with a new unit.

Crankcase

SAFETY FIRST: Protective gloves and eyewear are recommended at this point.

Splitting

Drain the engine oil and remove the strainer screen. See the [Engine Oil](#) topic for more information.

Remove the engine. See the [Engine Removal](#) topic for more information.

Remove the cylinder head cover. See the [Cylinder Head Cover](#) topic for more information.

Remove the camshaft sprocket. See the [Camshaft](#) topic for more information.

Remove the cylinder head. See the [Cylinder Head](#) topic for more information.

Remove the cylinder and piston. See the [Cylinder and Piston](#) topic for more information.

Remove the generator cover, flywheel, starter idle gear and starter driven gear. See the [A.C. Generator and Starter clutch](#) topic.

Remove the starter motor. See the [Starter Motor](#) topic for more information.

Remove the oil pump. See the [Oil Pump](#) topic for more information.

Remove the CVT pulleys and belt. See the [CVT Removal](#) topic for more information.

Remove the rear wheel. See the [Rear Wheel](#) topic for more information.



Remove the upper cam chain guide bolt with an 8 mm Allen.



Remove the upper cam chain guide.



Inspect the cam chain guides for damage and excessive wear. Replace the guides as needed.



Remove the cam chain from the crankshaft and crankcase. Inspect the cam chain for wear and damage. Replace the cam chain as needed.

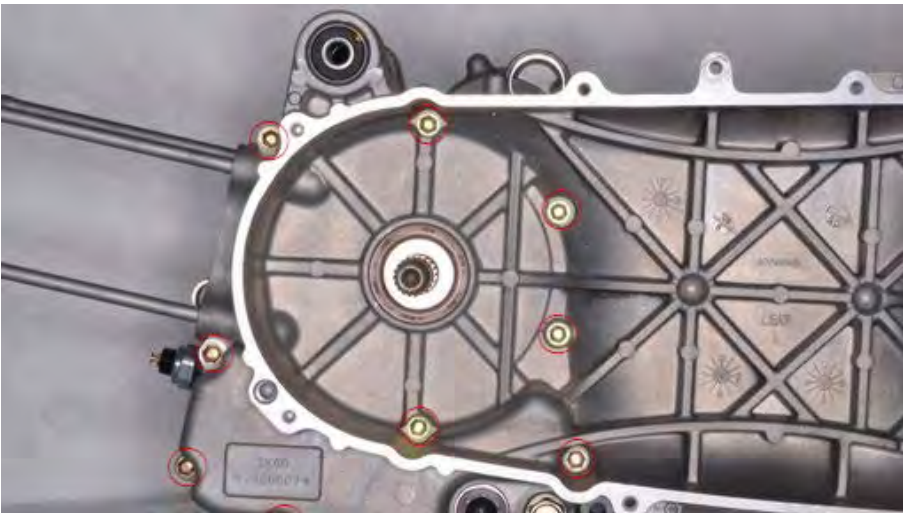

There are 11 crankcase bolts.

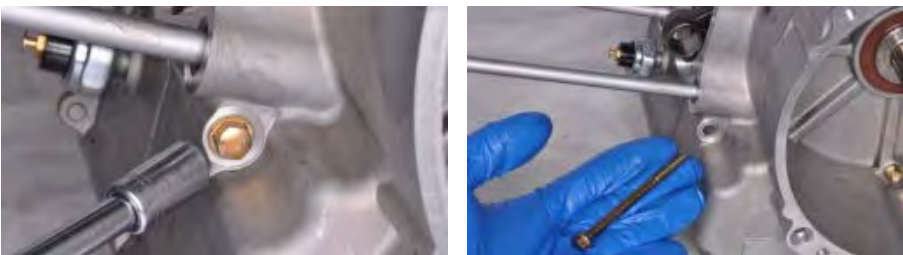

Loosen the 11 crankcase bolts in a crisscross pattern with an 8 mm socket. Remove the crankcase bolts from the left side of the engine.



Remove the plate with the bottom two crankcase bolts.



Set the crankcases on the right side.

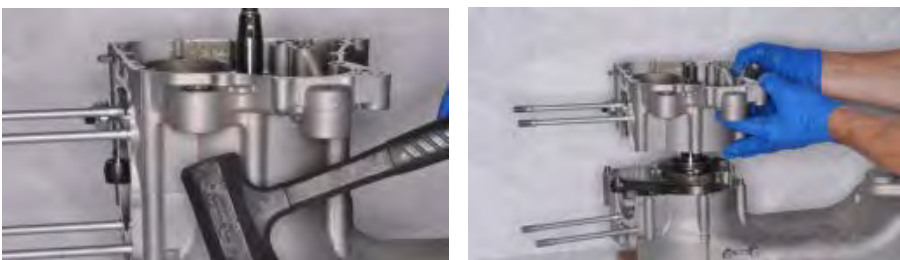

Separate the halves of the crankcase. If needed gently tap the reinforced areas of the right crankcase half with a rubber mallet. Lift the right crankcase off of the left.

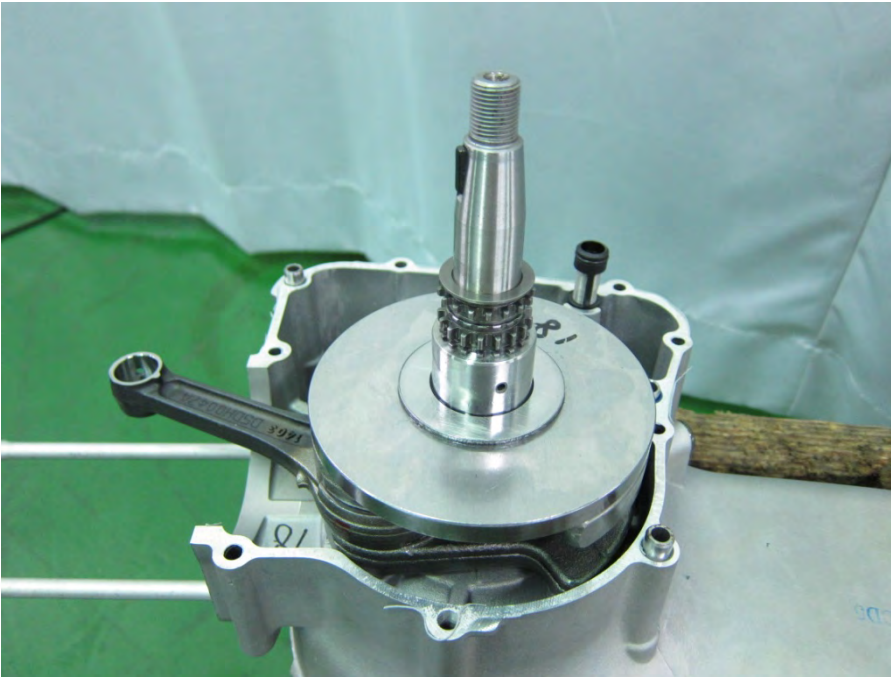

Remove the dowel pins from the crankcase. Inspect the O-ring and replace it as needed.

To remove the crankshaft see the [Crankshaft](#) topic.



Replace the left crankshaft seal if the crankcases are separated.



Remove the seal with a seal pick.



Drive the new seal into the left crankcase from the outside with a suitable driver. The driver should have the same outside diameter as the seal. Lubricate the new crankshaft seal lips with fresh engine oil.

Assembly

Thoroughly clean the crankcase mating surface.

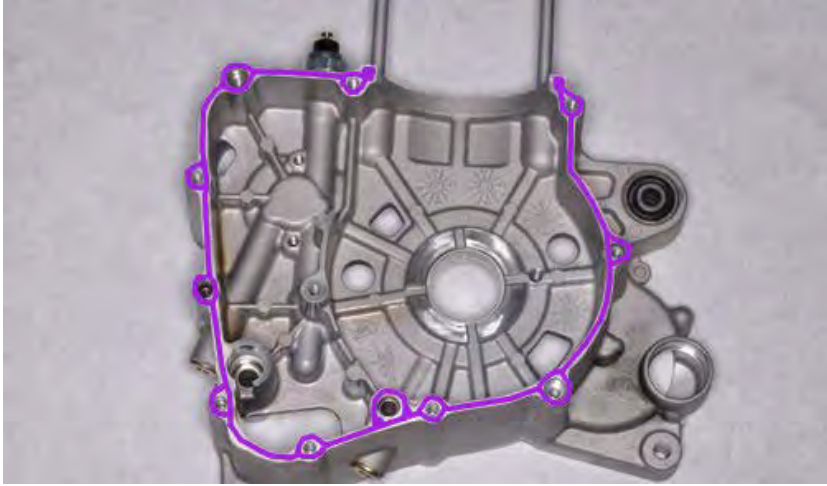

Apply sealant uniformly to the crankcase mating surface as indicated. Do not allow sealant to enter oil passages or get in bearings.



Set the right case half down on top of the left. Install the engine mount spacer.

Note: Make sure the Right/Left crankcases with the same number.





Insert the 11 crankcase bolts. The plate goes on with the bottom two bolts.



Tighten the bolts securely and evenly in a crisscross pattern with an 8 mm socket.



Install the cam chain around the timing sprocket teeth on the crankshaft.



Fit the upper cam chain guide into place.



Insert the upper cam chain guide mounting bolt and tighten it to specification with an 8 mm Allen socket.

Item	Qty	Thread size (mm)	Torque	
			kgf-m	lb-ft
Cam chain tensioner pivot	1	8	0.8-1.2	5.79 - 8.68

Install the oil pump. See the [Oil Pump](#) topic for more information.

Install the starter idle gear, driven gear, flywheel, and the generator cover. See the [A.C. Generator and Starter clutch](#) topic.

Install the starter motor. See the [Starter Motor](#) topic for more information.

Install the CVT pulleys and belt. See the [CVT Installation](#) topic for more information.

Install the cylinder and piston. See the [Cylinder and Piston](#) topic for more information.

Install the cylinder head. See the [Cylinder Head](#) topic.

Install the camshaft. See the [Camshaft](#) topic for more information.

Install the cylinder head cover. See the [Cylinder Head Cover](#) topic for more information.

Install the rear wheel. See the [Rear Wheel](#) topic for more information.

Install the engine into the frame. See the [Engine Installation](#) topic for more information.

Crankshaft

SAFETY FIRST: Protective gloves and eyewear are recommended at this point.

Removal

Split the crankcases. See the [Crankcase](#) topic for more information.



Lift the crankshaft out of the left crankcase half.

Crankshaft Inspection

Check the side clearance of the big end of the connecting rod with a feeler gauge.

Item		Standard (mm)	Service Limit (mm)
Crankshaft	Connecting rod big end side clearance	0.15 - 0.35	0.6



Grip the small end of the connecting rod and try and push the rod down towards the crank weights. If there is definite play between the connecting rod and crank the crankshaft should be replaced.

Crankshaft Bearings

Inspect the crankshaft bearings for signs of damage and wear. Replace the bearings if they show any kind of imperfection.

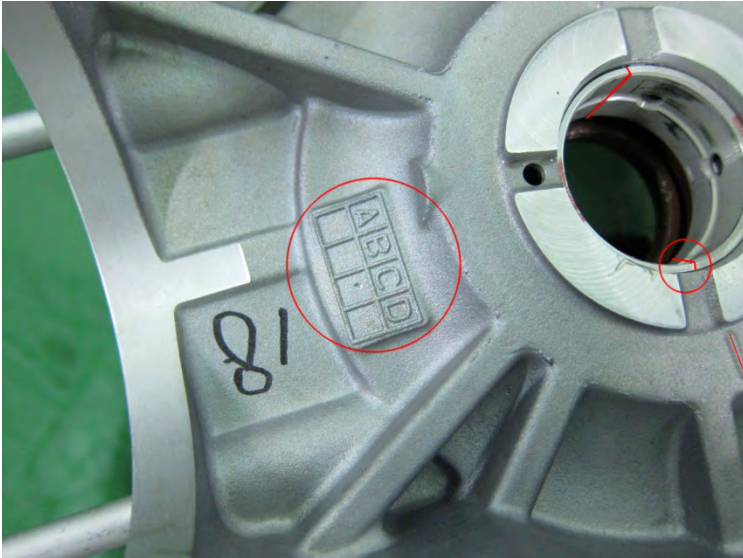

Note the bearing color code and crankcase code. The crank weights are also marked with a size code.



When the crankshaft and or crankcases must be replaced also replace both crank bearings according to the chart below.

–A,+A,A+ and A- all means A for both sides (CVT and stator sides)

–B,+B,B+ and B- all means B for both sides (CVT and stator sides)

And the gap between two bearings need to align the crankcase mark.

Bearing Color				
Crankshaft mark	Crankcase mark			
	A	B	C	D
A	black	green	green	red
B	green	green	red	---

Engine Removal

SAFETY FIRST: Protective gloves and eyewear are recommended at this point.

- A floor jack or other adjustable support is required to support and maneuver the engine. Be careful not to damage the scooter body, cables and wires during engine removal.
- Use shop towels to protect the scooter body during engine removal.

Place the scooter on the center stand.

Remove the following external components:

- [Seat](#)
- [Center Cover](#)
- [Front Cover](#)
- [Front Lower Cover](#)
- [Foot Skirt](#)
- [Rear Carrier](#)
- [Body Cover](#)
- [Under Cover](#)

Disconnect the cables from the battery terminals. See the [Battery](#) topic for more information.

Remove the spark plug cap. See the [Spark Plug](#) topic for more information.

Drain the coolant. See the [Coolant](#) topic for more information.

Drain the engine oil. See the [Engine Oil](#) topic for more information.

Remove the airbox. See the [Airbox](#) topic for more information.

Remove the rear brake caliper. See the [Rear Brake Caliper](#) topic for more information.

Remove the throttle body. See the [Throttle Body Removal and Installation](#) topic for more information.

Remove the exhaust system. See the [Exhaust System](#) topic for more information.



Disconnect the generator 3-pin connector.

And disconnect the crank position sensor wire coupler.



Unplug the water temperature sensor.

Pull back the rubber starter motor lead cover.

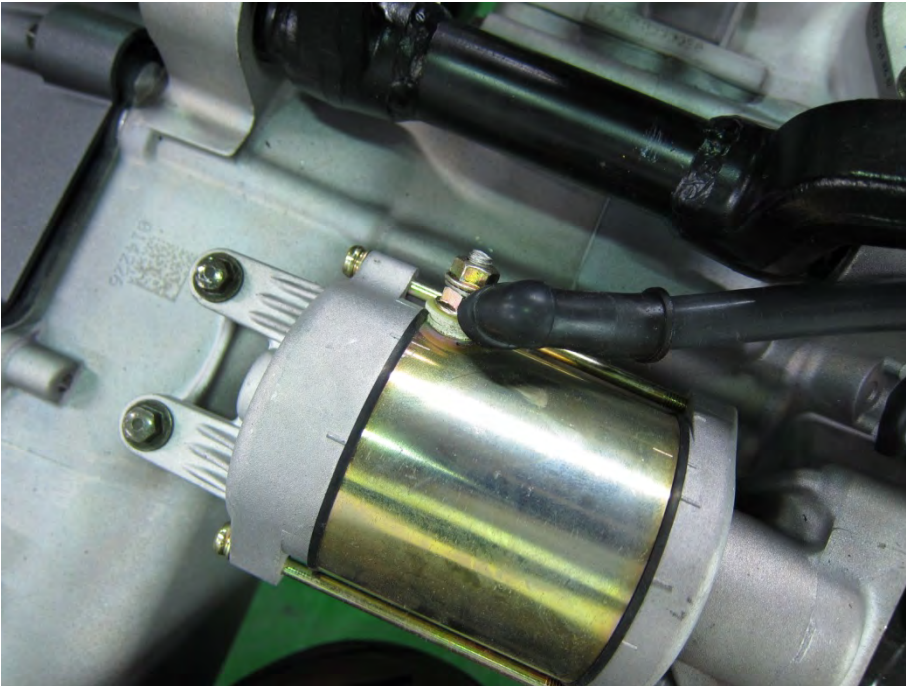

Remove the starter motor lead nut with a 10 mm wrench. Free the cable lead from the starter motor. Thread the nut back on to keep track of it.



Loosen the water pump hose clamp with a #2 Phillips screwdriver. Slide up the clamp and free the coolant hose from the water pump. Allow any remaining coolant to drain into a suitable container.



Loosen the thermostat hose clamp with a #2 Phillips screwdriver. Slide up the clamp and free the coolant hose from the thermostat. Allow any remaining coolant to drain into a suitable container.

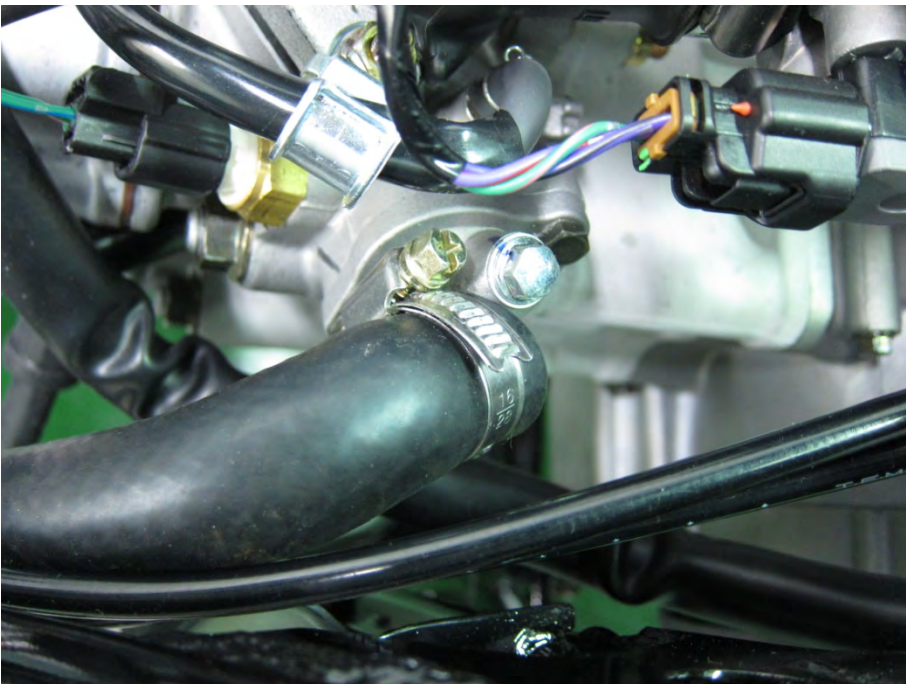

Squeeze the air bleed hose clamp with needle nose pliers and slide back the clamp. Free the air bleed hose from the thermostat.



Loosen the main engine ground bolt with an 8 mm socket. Remove the bolt and free the engine ground from the right side of the engine.



Unplug the oil pressure switch wire at the bullet connector. The oil pressure switch is located below the cylinder.



Free the wiring harness from its guide above the intake pipe.



Support the engine with a suitable jack or stand.
Remove the rear shock absorbers. See the [Shock Absorbers](#) topic for more information.

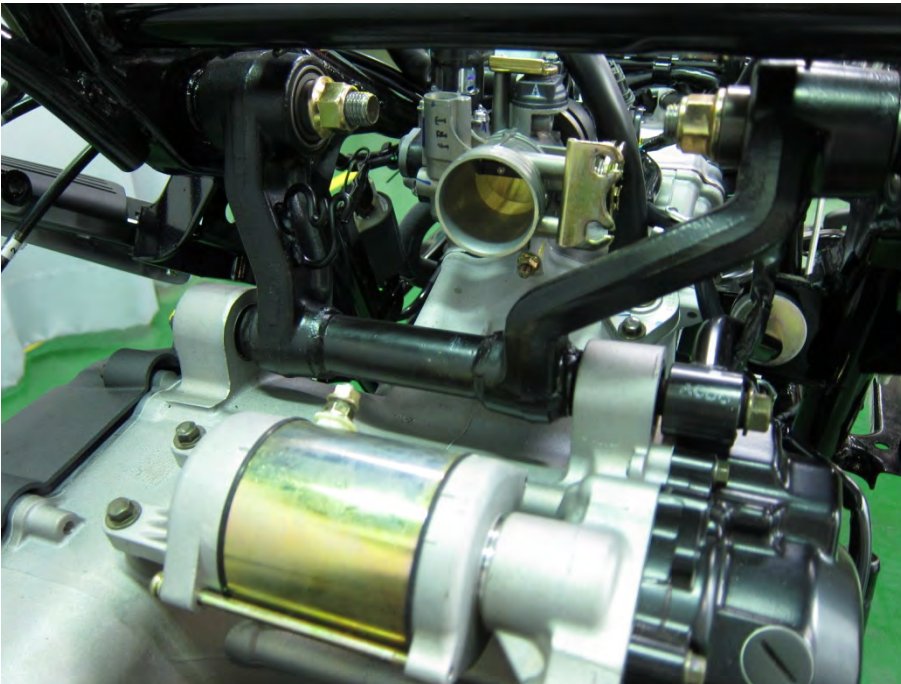

Hold the engine mounting bolts with a 14 mm wrench and loosen the nuts with a 19 mm socket.

Lift up the engine mounting bracket.



Carefully move the engine back and separate it from the chassis.



5. Cooling System

This chapter covers the location and servicing of the cooling system components for the KYMCO Downtown 350i model.

<u>Coolant</u>	5-3
<u>Radiator</u>	5-12
Water Temperature Sensor (WTS)	5-22
<u>Water Pump</u>	5-28

GENERAL INSTRUCTIONS

- The water pump must be serviced after removing the engine. Other cooling system service can be done with the engine installed in the frame.
- The engine must be cool before servicing the cooling system. When the coolant temperature is over 100°C, never remove the radiator cap to release the pressure because the boiling coolant may cause danger.
- Avoid spilling coolant on painted surfaces because the coolant will corrode the painted surfaces. Wash off any spilled coolant with fresh water as soon as possible.
- After servicing the system, check for leaks with a cooling system tester.

TROUBLESHOOTING

Engine temperature too high

- Faulty temperature gauge or sensor
- Faulty radiator cap
- Faulty thermostat
- Insufficient coolant
- Passages blocked in hoses or water jacket
- Clogged radiator fins
- Passages blocked in radiator
- Faulty water pump

Temperature gauge shows the wrong temperature

- Faulty temperature gauge or sensor
- Faulty thermostat

Coolant leaks

- Faulty pump mechanical (water) seal
- Deteriorated O-rings
- Damaged or deteriorated water hoses

Coolant

SAFETY FIRST: Protective gloves and eyewear are recommended at this point.

Warning: Allow the engine sufficient time to cool before handling or working on the cooling system components.

To check the coolant level see the [Coolant Level Check](#) topic for more information.

Draining

SAFETY FIRST: Antifreeze is highly toxic and can kill pets and animals if drank.

Do not leave coolant where animals (including children!) can get to it.

Remove the windshield. See the [Windshield](#) topic for more information.

Remove the front meter cover.





Remove the radiator cap in two stages. Allow any built up pressure to vent and then open the cap all the way and remove it.

The water pump is located on the right side of the engine. Ready a drain pan under the water pump drain bolt.



Loosen the coolant drain bolt with an 8 mm socket.



Remove the drain bolt and sealing washer and allow the coolant to drain into a suitable container.

The coolant reserve tank is under the left floorboard.



Remove the left floorboard.



Remove the engine coolant lid screw with a #2 Phillips. And remove the engine coolant lid.



Open the coolant reserve tank lid. Siphon the coolant out of the reserve tank with an appropriate suction device. If a suction device is unavailable remove the reserve tank and pour it out. See the [Radiator](#) topic for more information.

When the coolant has finished draining return the drain bolt to the water pump with a new sealing washer.



Tighten the drain bolt securely with an 8 mm socket.

Filling

Coolant capacity	Total 1719 cc	Radiator: 766 cc Reserve tank: 590 cc Hose: 363 cc
------------------	---------------	--

- Use coolant of specified mixing rate. (The mixing rate of 860cc KYMCO SIGMA coolant concentrate + 859cc distilled water is 50%.)
- Do not mix coolant concentrate of different brands.
- Do not drink the coolant, which is poisonous.
- The freezing point of coolant mixture shall be 5 °C lower than the freezing point of the riding area.



Fill the cooling system with a mix of distilled water and KYMCO SIGMA Coolant Concentrate. Continue filling until the coolant until it reaches the bottom of the filler neck as shown.



Add coolant to the reserve tank until it reaches the upper level mark.

Gently rock the vehicle side-to-side to release any air bubbles trapped in the cooling system.

Place the vehicle on its center stand and start the engine. Let it run for several minutes. This will purge any air out of the cooling system. Check for coolant leaks

When the air bubbles stop coming up turn off the engine and recheck the coolant level, add coolant if necessary. Check the reserve tank and add coolant if needed.



Wet the seal of the radiator cap and install.



Install the coolant reserve tank lid.



Install the engine coolant reserve tank cover. Insert the screw and tighten its securely with a #2 Phillips.



Install the left floorboard cover.

Install the front meter cover.



Install the windshield. See the [Windshield](#) topic for more information.

Radiator

SAFETY FIRST: Protective gloves and eyewear are recommended at this point.

Warning: Allow the engine sufficient time to cool before handling or working on the cooling system components.

Pressure Testing

Remove the windshield. See the [Windshield](#) topic for more information.
Remove the front meter cover.





Remove the radiator cap in two stages. Allow any built up pressure to vent and then open the cap all the way and remove it.

When checking the cooling system for leaks you will need a pressure tester. Remove the radiator cap, wet the tester seal, and install the end of the pressure tester onto the filler neck. Pump the tester up until the gauge reads 0.84 kg/cm^2 or 12 psi. The cooling system should hold this pressure for at least 6 seconds. If it does not you will need to inspect the entire system for leaks. Do not pressurize the cooling system more than 1.05 kg/cm^2 or 14.9 psi.

CAUTION: Never remove the radiator cap when the engine is hot.

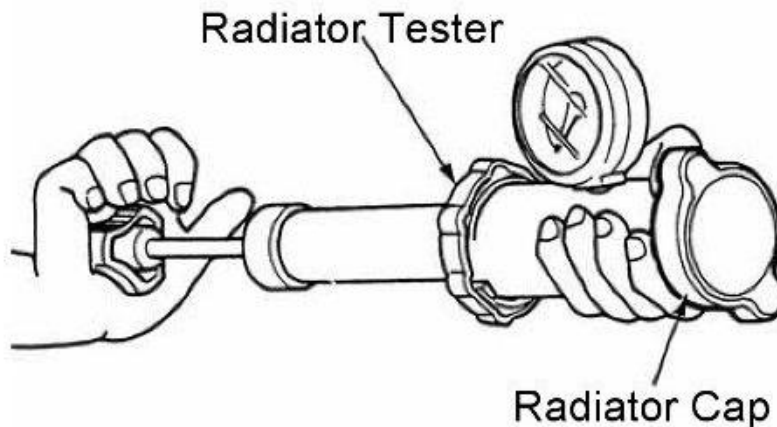

Wet the seal on the radiator cap and install it to the pressure tester. Replace the cap if it does not relieve the pressure as specified.

Radiator cap relief pressure	$0.9 \pm 0.15 \text{ kg/cm}^2$ ($12.8 \pm 2.1 \text{ psi}$)
------------------------------	---

Removal

Drain the coolant. See the [Coolant](#) topic for more information.



Unplug the cooling fan motor connector.



There are three coolant hoses that connect to the radiator. The top right hose runs to the filler neck and cap. The top left hose runs to the thermostat on the cylinder head. The bottom right hose runs to the water pump.



Loosen the coolant hose clamps with a #2 Phillips screwdriver.
Free the filler neck coolant hose from the stay and remove it from the radiator.



Remove the water pump and thermostat hoses in the same manner.



Remove the two radiator mounting bolts with a 10 mm socket.



Slide the radiator to the left and free the grommet from the post above the right side of the radiator.



Remove the radiator from the frame.

Coolant Reserve Tank

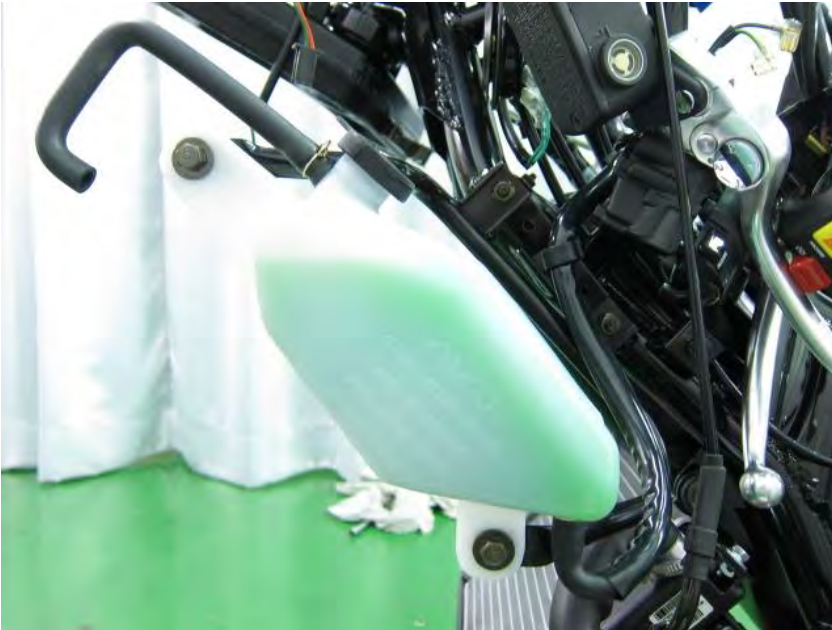

The coolant reserve tank is mounting to the frame with two bolts. There are two hoses that connect to the reserve tank. The top hose is a dump hose that hangs over the other side. The bottom hose is the overflow hose that runs to the filler neck.



Position a suitable container below the reserve tank.



Pull back the clamp and free the overflow hose from the bottom of the reserve tank. Allow the coolant in the reserve tank to drain into the container.



Remove the two reserve tank mounting bolts with a 10 mm socket.



Remove the reserve tank from the frame.



To remove the reserve tank bracket take off the mounting nuts with a 10 mm socket.



Remove the reserve tank bracket from the studs on the frame.

Inspection

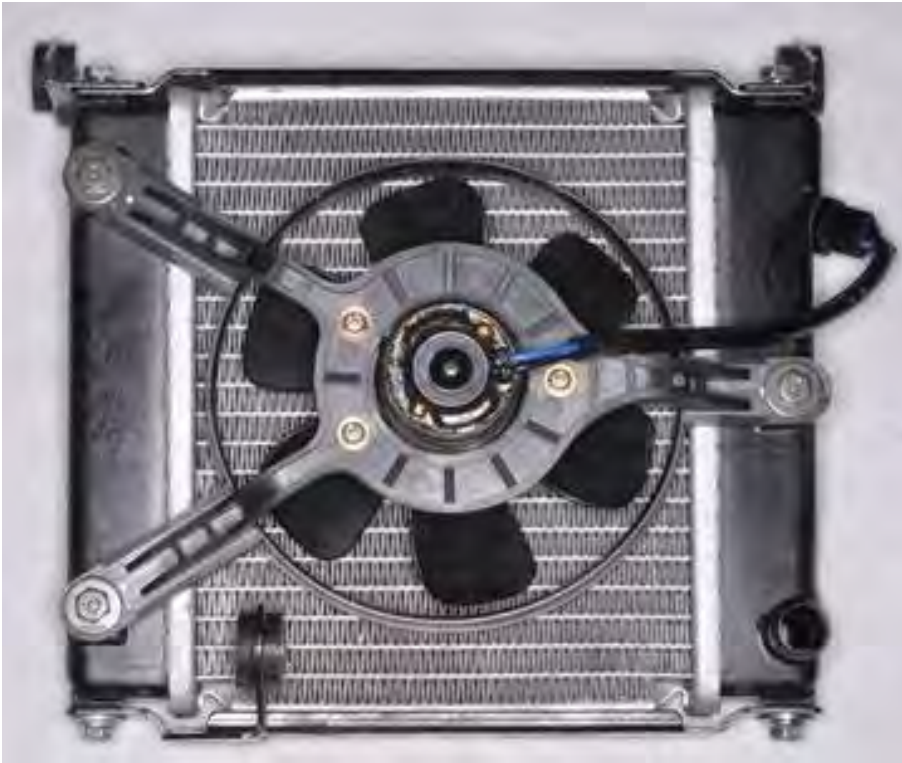

Inspect the radiator fins for damage and clogging. To remove the fan take out the three mounting bolts with a 10 mm socket.

Clean out the fins with low pressure compressed air and water.

NOTE: Always wear safety glasses when using compressed air and never point it directly at yourself or anyone else.



Check the radiator for any bent or damaged fins. Use a small flat blade screwdriver to straighten them out, but be careful not to puncture the radiator.



Jump a 12 volt battery to the fan connector and make sure the radiator fan operates.

Water Temperature Sensor (WTS)

Removal

Drain the coolant. See the [Coolant](#) topic for more information.

Remove the seat. See the [Seat](#) topic for more information.

Remove the luggage box. See the [Luggage Box](#) topic for more information.

Remove the rear carrier. See the [Rear Carrier](#) topic for more information.

Remove the body cover. See the [Body Cover](#) topic for more information.

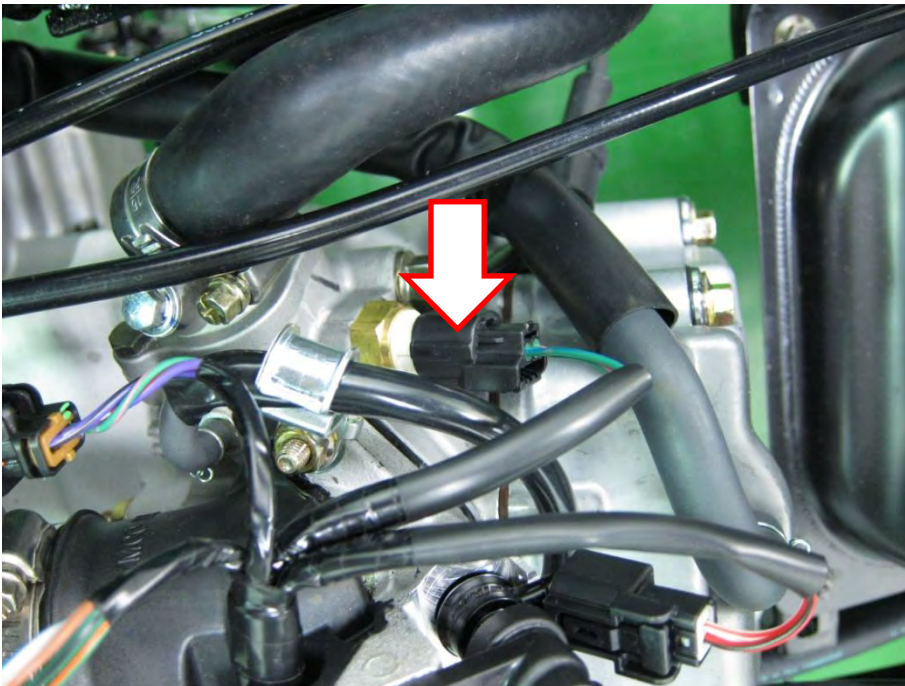

Unplug the water temperature sensor.



Use a 17 mm wrench to remove the water temperature sensor.

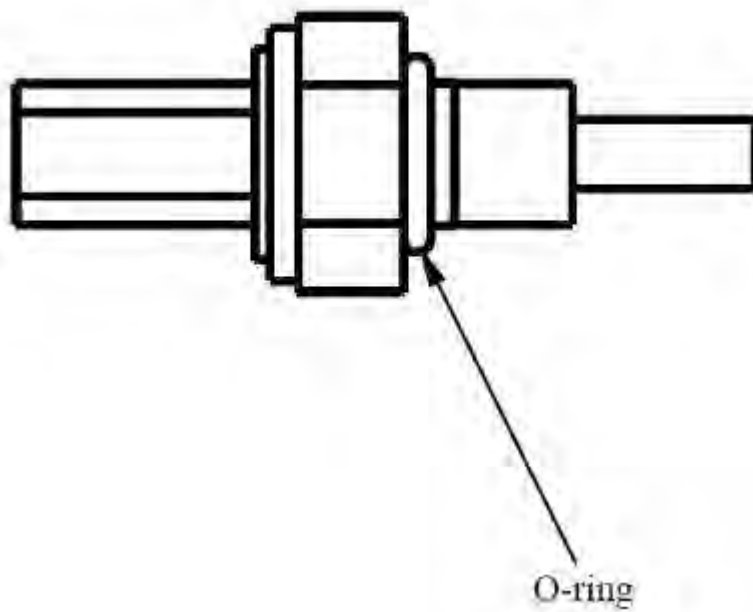

Discard the WTS O-ring and replace it with a new item.

Thermostat

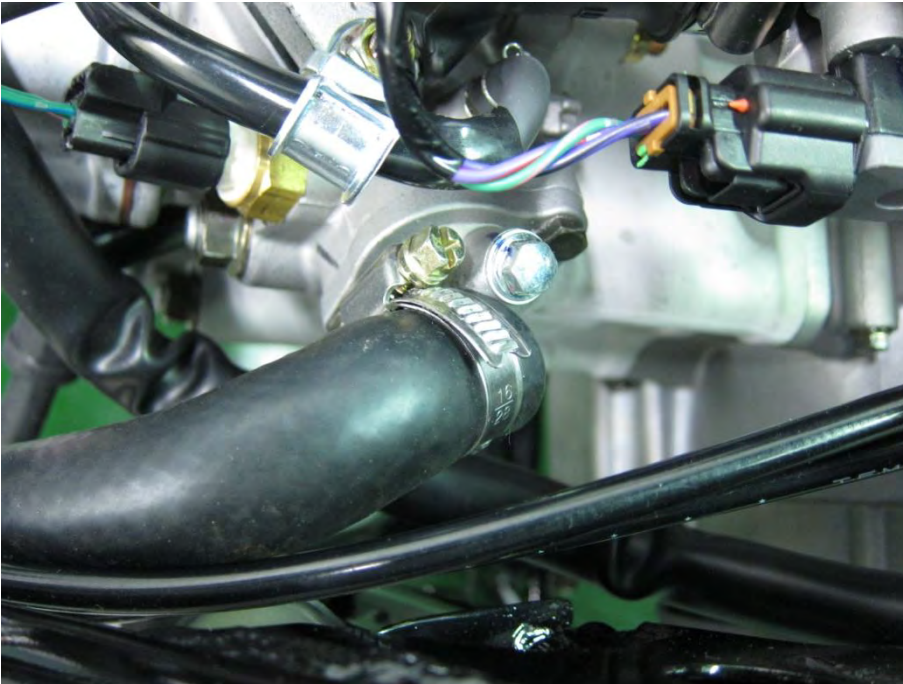

Loosen the thermostat hose clamp with a #2 Phillips screwdriver. Slide up the clamp and free the coolant hose from the thermostat.

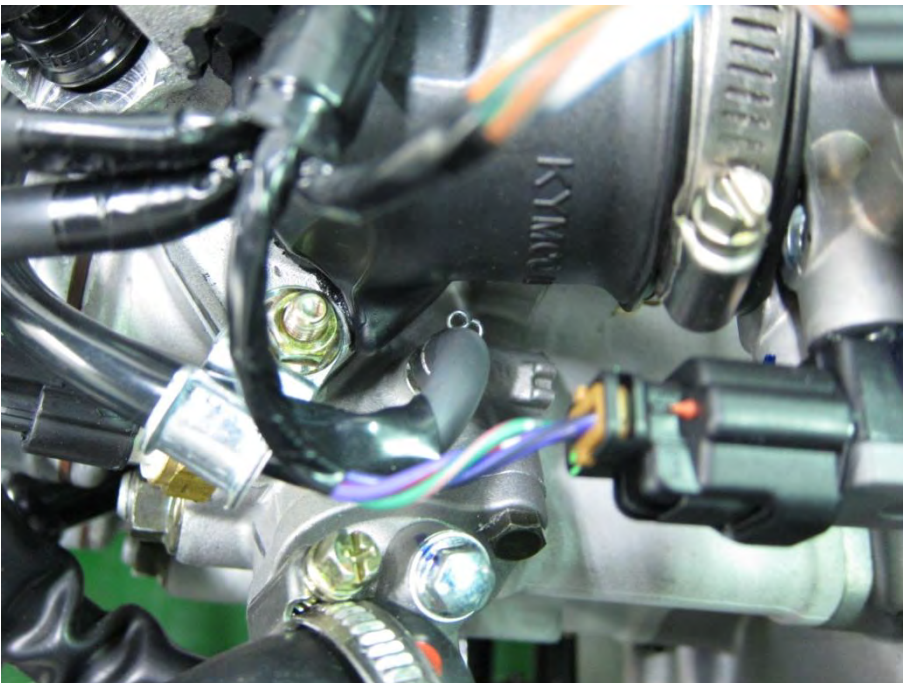

Squeeze the air bleed hose clamp with needle nose pliers and slide back the clamp. Free the air bleed hose from the thermostat.



Remove the two thermostat mounting bolts with an impact #3 Phillips screwdriver.



Lift off the thermostat cover.



Lift out the thermostat. Remove the thermostat O-ring and discard it.

Inspection

Water Temperature Sensor

Inspect the WTS in a similar manner as the thermosensor. Measure the resistance between the WTS terminals and compare this to the specifications.

WTS resistance	At -20 °C/-4 °F	18.8 kΩ
	At 40 °C/104 °F	1.136 kΩ
	At 100 °C/212 °F	0.1553 kΩ

Thermostat

The thermostat should be closed at room temperature.

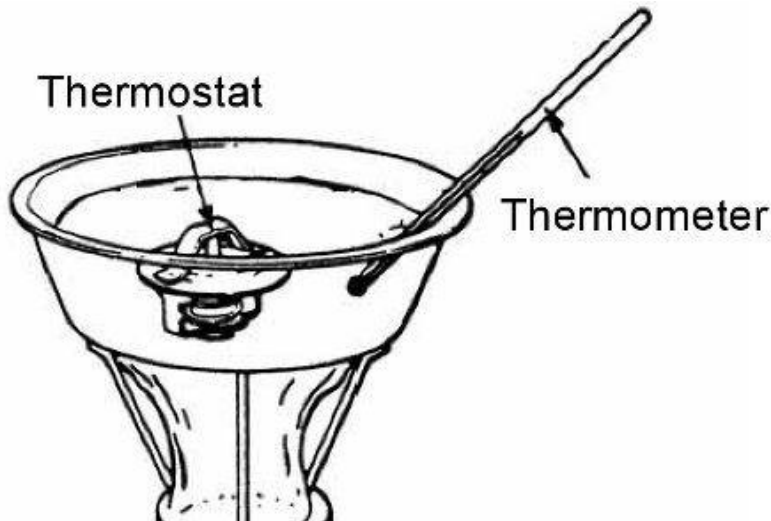

Suspend the thermostat and a thermometer in a pot of water with string. Make sure the thermostat and the thermometer are not touching the pot. Bring the temperature up to the specification slowly and check the operation of the thermostat.

The valve should begin to open around 71° C (160° F). The valve should lift 3.5 - 4.5 mm (0.14 - 0.18 in) at 80° C (176° F).

After the thermostat has been open for around 5 min. allow the thermostat to cool. The thermostat should close at 70° C (158° F).

Replace the thermostat with a new unit if it fails to function properly.

Water Pump

SAFETY FIRST: Protective gloves and eyewear are recommended at this point.

Mechanical Seal Inspection

Inspect the telltale hole in the generator cover below the water pump for signs of coolant leaking. If there is coolant coming from this hole the mechanical seal is compromised and must be replaced.

Removal

Water Pump Cover

Drain the coolant. See the [Coolant](#) topic for more information.



Loosen the water pump hose clamp with a #2 Phillips screwdriver. Slide up the clamp and free the coolant hose from the water pump. Allow any remaining coolant to drain into a suitable container.



Loosen the four water pump cover bolts with an 8 mm socket.



Remove the bolts and the water pump cover.



Remove the two dowel pins and the water pump cover gasket.

Impeller and Shaft

Remove the generator cover. See the [A.C. Generator and Starter clutch](#) topic for more information.



Hold the water pump shaft and loosen the impeller with a 12 mm socket. The impeller has left hand threads.



Remove the impeller.



Remove the seal washer from the back of the impeller. Inspect the impeller blades and seal. Replace the seal washer if the mechanical seal is to be replaced.

When assembly



Install the impeller to the water pump shaft. Note: Left hand threads.



Hold the water pump shaft and tighten the impeller to specification with a 12 mm socket. Remember the impeller has left hand threads.

Item	Qty	Thread size (mm)	Torque	
			kgf-m	lb-ft
Water pump impeller	1	7	1.0-1.4	7.23-10.13

Make sure the water pump cover mating surface is clean.

6.Fuel Injection System

This chapter covers the location and servicing of the fuel system components for the KYMCO Downtown 350i model.

<u>Airbox</u>	6-4
<u>Fuel Tank</u>	6-8
<u>Fuel Pump</u>	6-13
<u>Throttle Body Removal</u>	6-21
<u>Throttle Cable</u>	6-32
<u>Throttle Body</u>	6-35
<u>Fuel Injector</u>	6-41
<u>TPS ISC Reset Procedure</u>	6-46
<u>Self-Diagnosis</u>	6-47
<u>F.I. Diagnostic Tool</u>	6-54

SERVICE INFORMATION

GENERAL INSTRUCTIONS

- Scooter services can be done with the engine installed in the frame.
- Be sure to relieve the fuel pressure before fuel pump or fuel hose removal.
- Bending or twisting the control cables will affect operation and could cause the cables to stick or bind, resulting in loss of vehicle control.
- Work in a fully ventilated area. Smoking or allowing flames or sparks in the work area or where gasoline is stored can cause a fire or explosion.
- Do not apply the Carburetor Cleaners to the inside of the throttle body, which is coated with molybdenum.

- Do not snap the throttle valve from fully open to fully close after the throttle cable has been removed; it may cause incorrect idle speed.
- Do not loosen or tighten the painted bolts and screws of the throttle body. Loosening or tighten them can cause throttle and idle valve synchronization failure.
- Seal the cylinder head intake ports with tape or a clean towel to prevent dirt and debris from entering the intake ports after the throttle body has been removed.
- Do not damage the throttle body. It may cause incorrect throttle and idle valve synchronization.
- Do not take the fuel pump on the ground downward.
- Always replace the packing when the fuel pump is removed.
- The electronic fuel injection system is equipped with the self-diagnostic system. If the Check Engine Lamp “CELP” illuminate while riding, follow the self-diagnostic procedures to solve the problem.
- A faulty AFI problem is often related to poorly connected or corroded connectors. Check those connections before proceeding.
- When disassembling the fuel injection parts, note the location of the O-rings. Replace them with new ones upon reassembly.
- Do not disconnect the battery negative (-) or positive (+) cable while engine is running, it may cause ECU damage.
- **Do not disconnect or connect the ECU connector during the ignition switch “ON”; it may cause the ECU damage.**

TROUBLESHOOTING

Engine fail to start

- Intake manifold air leak
- Fuel contaminated/deteriorated
- Pinched or clogged fuel hose
- Faulty fuel pump
- Clogged fuel filter, throttle body
- Sticking fuel injector needle
- Faulty fuel pump operating system
- Carbon deposit stayed on the fuel injector
- Spark plug dirty
- Fuel pressure incorrect

Backfiring or misfiring during acceleration

- Ignition system malfunction

Engine stall, hard to start, rough idling

- Intake air leak
- Fuel contaminated/deteriorated
- Pinched or clogged fuel hose
- Idle speed fail to adjust
- Fail to perform TPS/ISC reset

Poor performance (drive ability) and poor fuel economy

- Pinched or clogged fuel hose
- Faulty injector

Airbox

SAFETY FIRST: Protective gloves and eyewear are recommended at this point.

Removal

Remove the air filter see the [Air Filter Servicing](#) topic for more information.

Remove the seat. See the [Seat](#) topic for more information.

Remove the luggage box. See the [Luggage Box](#) topic for more information.

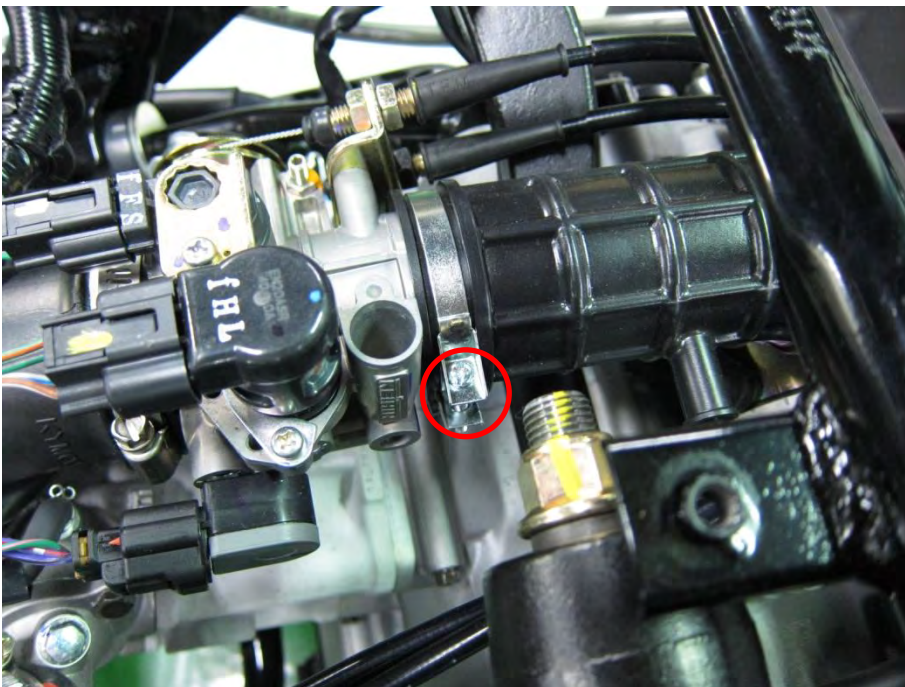

Loosen the airbox connecting hose clamp screw at the throttle body with a #2 Phillips.



Remove the breather hose from the airbox.

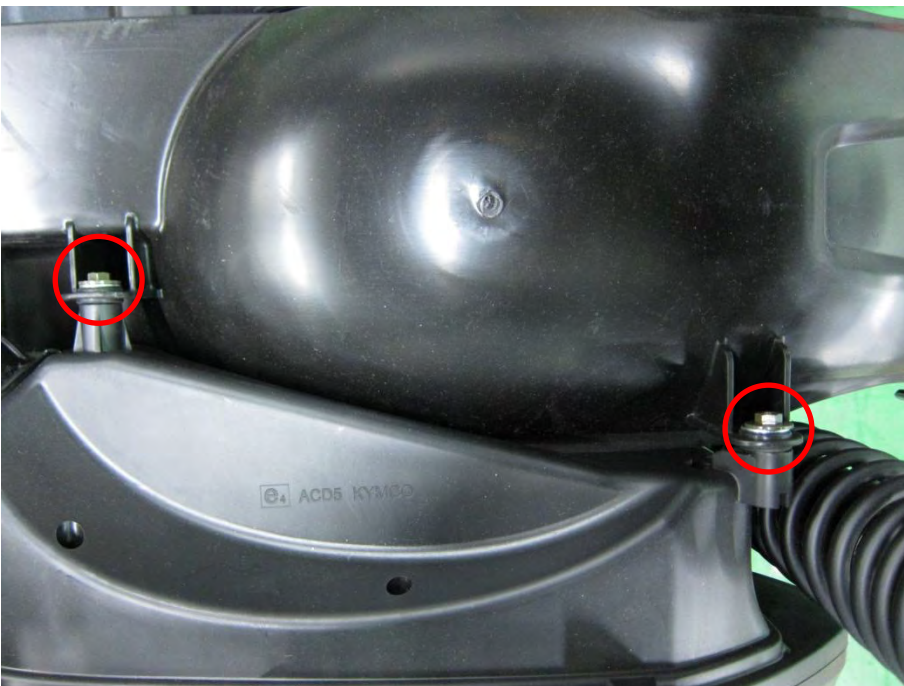

Remove the two rear airbox bolts and washers.

Remove the breather hose connecting of the gear box and airbox.

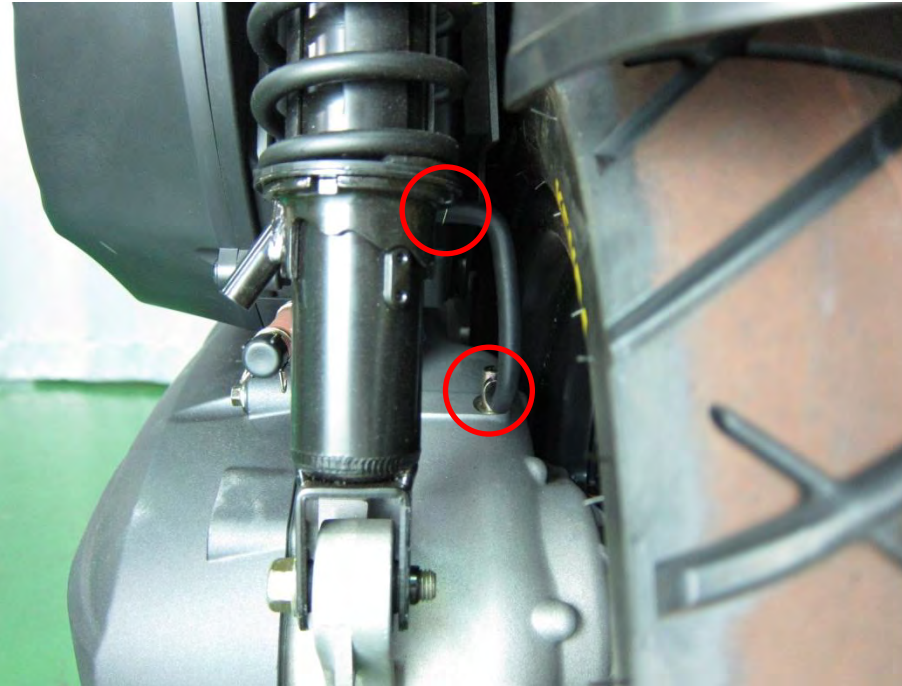

Remove the two front airbox bolts with an 8 mm socket.
And remove the airbox.

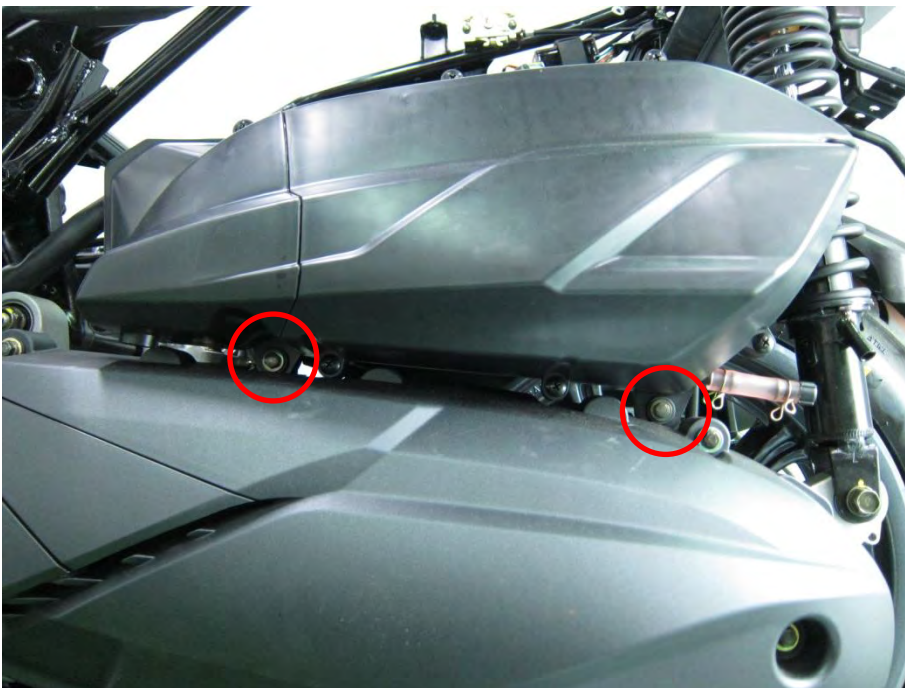

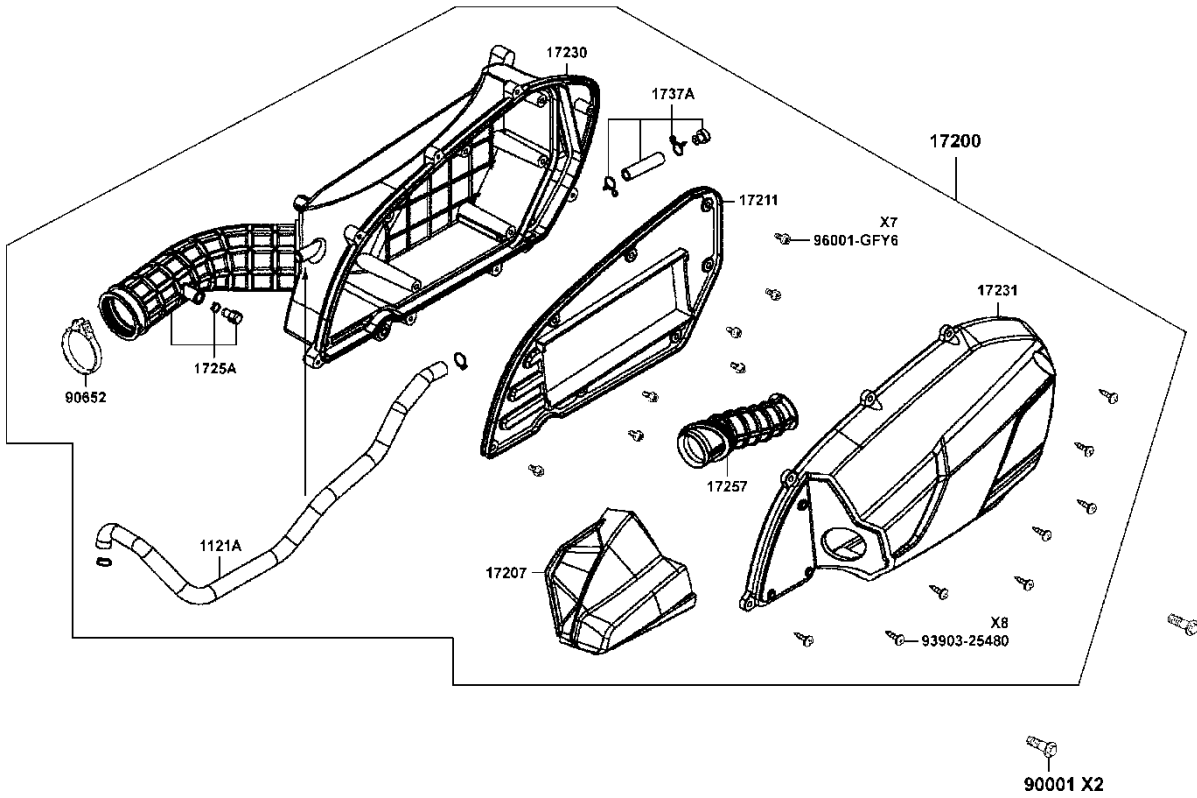

Fuel Tank

SAFETY FIRST: Protective gloves and eyewear are recommended at this point.

Warning: Gas is extremely flammable! Do not work around an open flame or a source of sparks.

Removal

- [Seat](#)
- [Windshield](#)
- [Front Cover](#)
- [Front Center Cover](#)
- [Handlebar Covers](#)
- [Center Cover](#)
- [Foot Skirt](#)
- [Front Lower Cover](#)
- [Inner Cover](#)

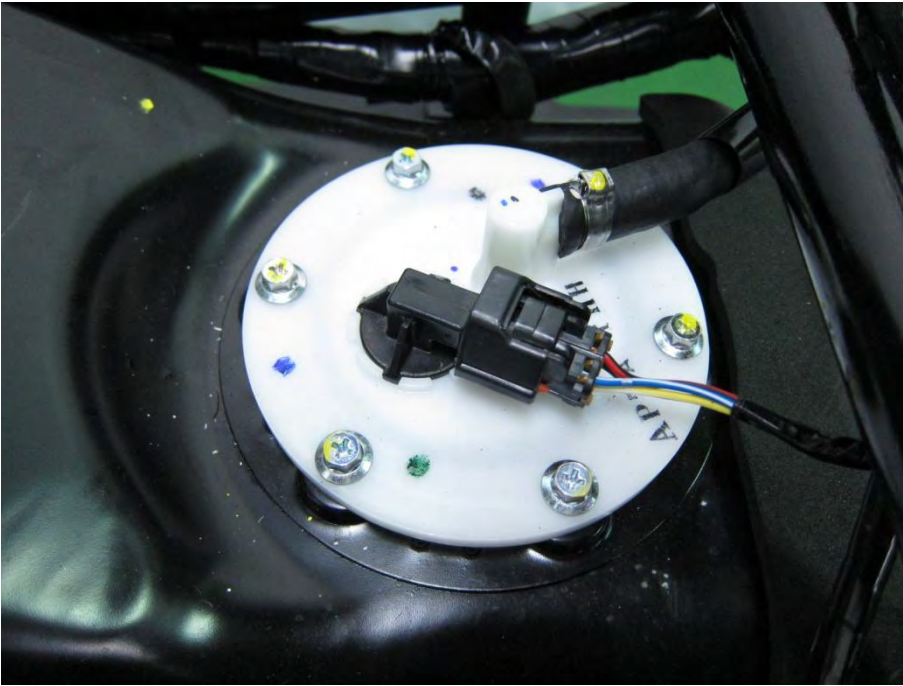

In order to drain the fuel from the fuel pipe and release the fuel pressure unplug the fuel pump connector. Start the engine and let it run until it dies of fuel starvation. Turn the ignition switch off.



Loosen the fuel hose clamp. Slide back the clamp and free the injector fuel hose from the fuel pump pipe. Clean up any remaining fuel immediately.



Note: When slide back the fuel hose carefully not to damage the fuel pump pipe, and replace the clamp with a new one when installation.

Remove the fuel tank mounting nuts.



Remove the fuel tank mounting nuts.

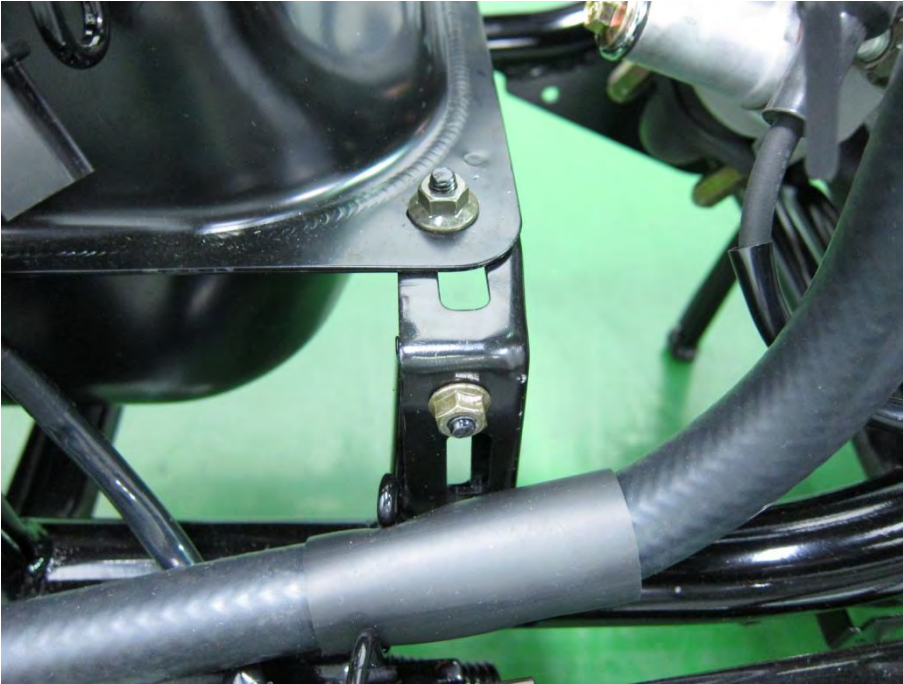

Remove the fuel tank mounting nuts and brackets. Remove the fuel tank from the bottom of the frame.



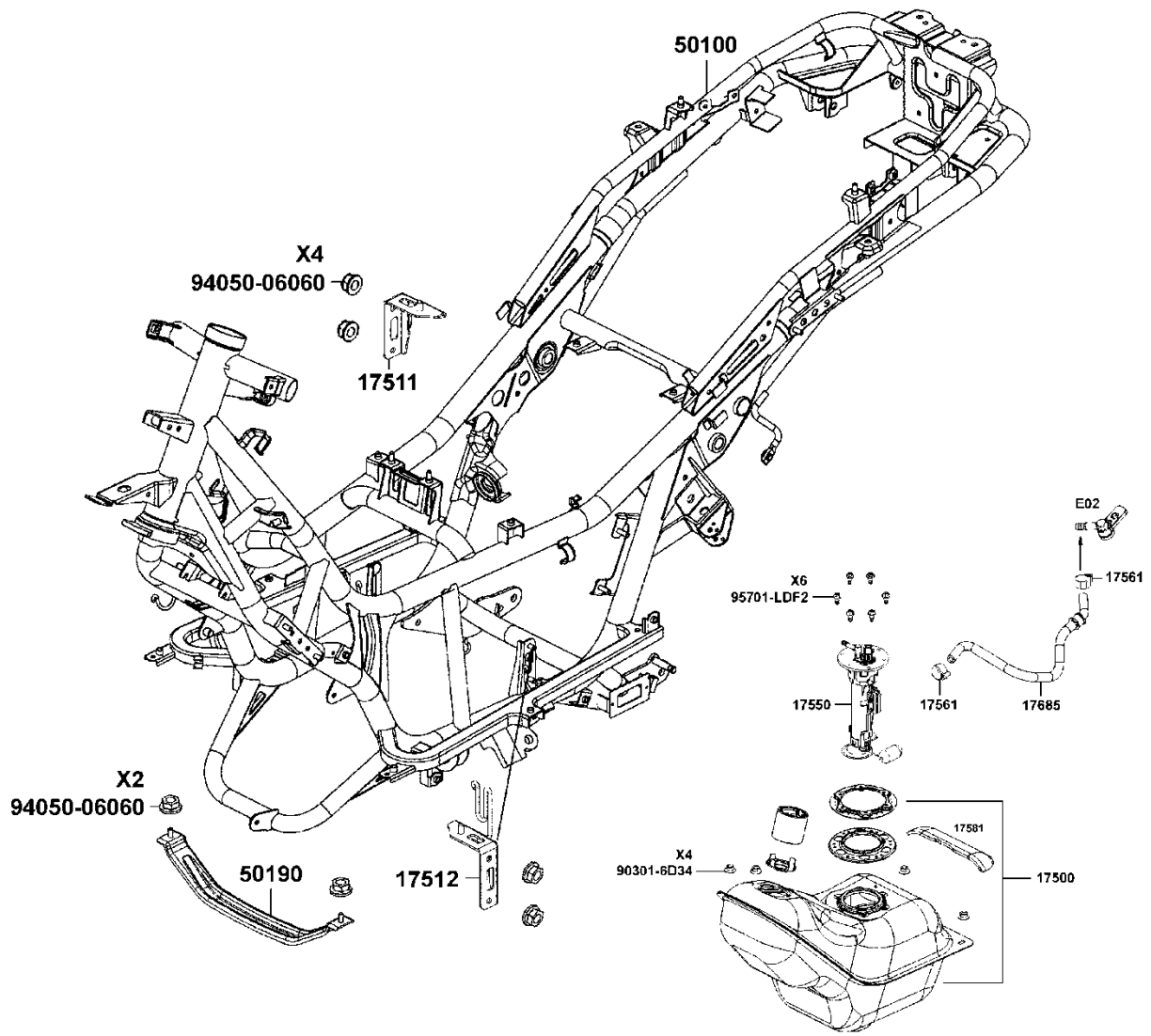

Fuel Pump

SAFETY FIRST: Protective gloves and eyewear are recommended at this point.

Warning: Gas is extremely flammable! Do not work around an open flame or a source of sparks.

Input Voltage Inspection

Remove the seat. See the [Seat](#) topic for more information.

Remove the luggage box. See the [Seat](#) topic for more information.

Remove the center cover. See the [Center Cover](#) topic for more information.

Turn the ignition switch off.



Place the scooter on its main stand and put the side stand up.



Set the engine stop switch to the “RUN” position.



Unplug the fuel pump connector.
Set the multi meter to read battery voltage.

Touch the multi meter leads to the harness side of the fuel pump connector, with the positive lead touching the red/black wire terminal and the negative lead touching the green wire terminal.

Turn the ignition switch on. The battery voltage should show for a few seconds. Replace the fuel pump if it is not functioning and the input voltage is correct.

If the battery voltage is not present check the following:

- Fuse B (10 A)
- Fuel cut-off relay
- ECU

Removal



In order to drain the fuel from the fuel pipe and release the fuel pressure unplug the fuel pump connector. Start the engine and let it run until it dies of fuel starvation. Turn the ignition switch off.

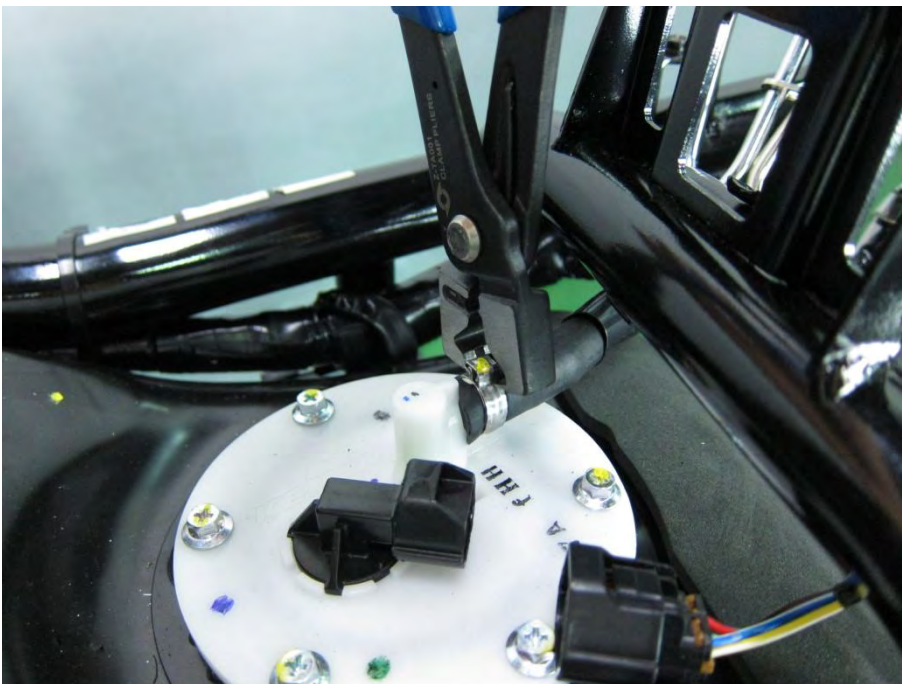

Loosen the fuel hose clamp. Slide back the clamp and free the injector fuel hose from the fuel pump pipe. Clean up any remaining fuel immediately.

Loosen the fuel hose clamp with a #2 Phillips screwdriver. Slide back the clamp and free the injector fuel hose from the fuel pump pipe. Clean up any remaining fuel immediately.



Remove the 6 fuel pump bolts with a 7 mm socket or #2 Phillips screwdriver.



Lift the fuel pump out of the tank.



Discard the fuel pump O-ring, and replace it with a new item on assembly.

Fuel Level Gauge Inspection



Using a digital multi meter set to ohms of resistance (Ω), measure the resistance between the fuel pump/level gauge connector terminals (green and yellow/white) with the float raised to the positions indicted below.

When installation, replace the O-ring with new item and apply a small amount of fresh engine oil to the new O-ring.

Insert the 6 fuel pump mounting bolts. Tighten the bolts to specification with a 7 mm socket or #2 Phillips screwdriver.

Item	Qty	Torque	
		kgf-m	lb-ft
Fuel Pump Bolts	6	0.35	2.5

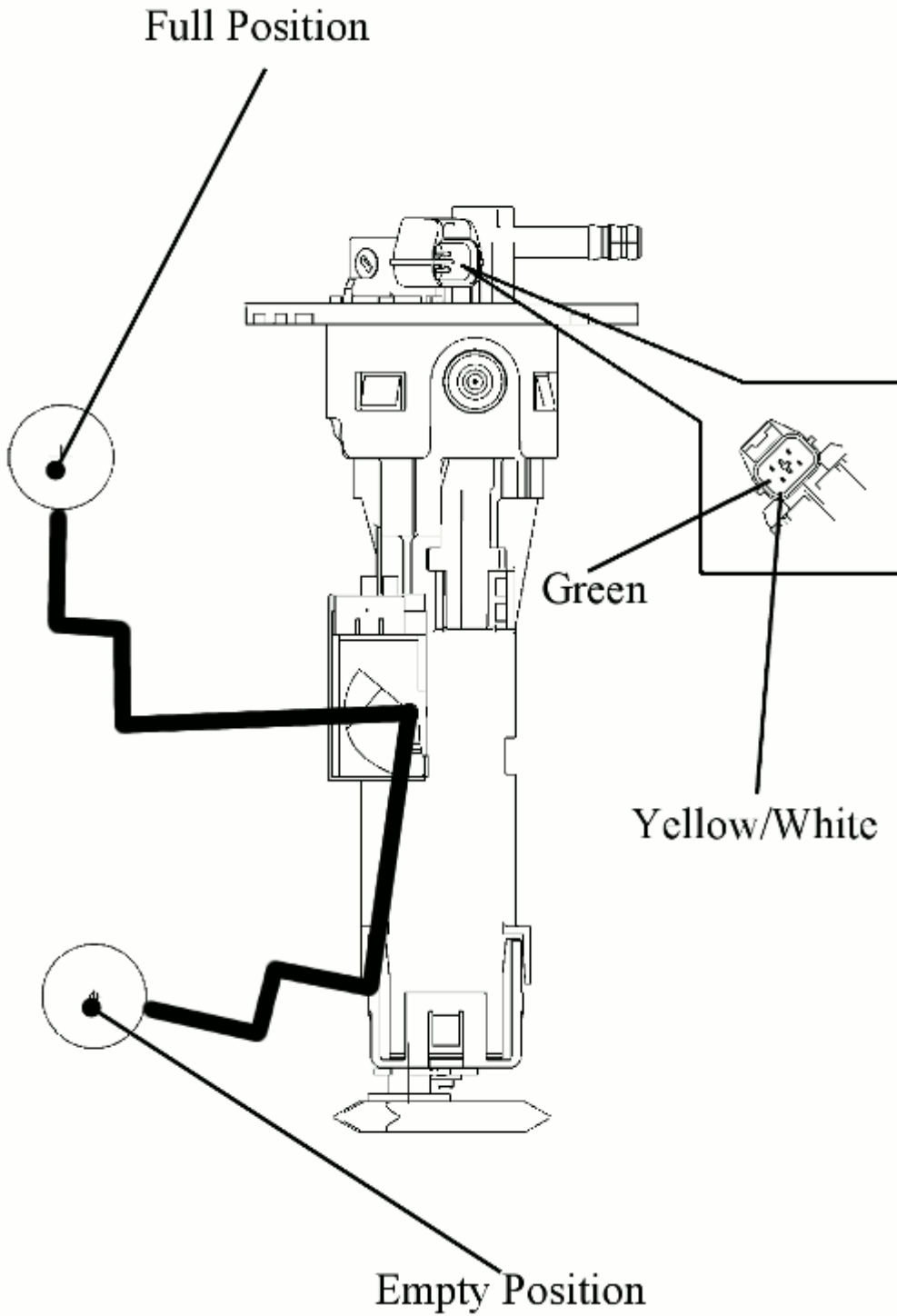

Fuel Level Float Position	Resistance
Full	1100 ± 33 Ω
Empty	100 ± 3 Ω

Replace the fuel level float unit with a new part if the resistance is out of specification.

Fuel Output Pressure

Turn the key to the OFF position.



Use a fuel hose clamp as shown.



Disconnect the fuel hose from the fuel injector. Connect the fuel pressure gauge. Remove the fuel hose clamp. Turn the key to the ON position. Check the fuel pressure.

If the fuel output pressure is less than 3.0 bar, may fail to start the engine or in trouble in case of riding.

Turn the key to the OFF position and use the fuel hose clamp to block the fuel hose. Return the fuel line to the injector.

To inspect the fuel pump relay see the [Relays](#) topic.

Fuel Pump Relay

See the [Relays](#) topic.

Throttle Body Removal and Installation

SAFETY FIRST: Protective gloves and eyewear are recommended at this point.

Inspection

Remove the seat. See the [Seat](#) topic for more information.

Remove the luggage box. See the [Seat](#) topic for more information.

Throttle Body /MAP/ISC/TPS

- Turn off the ignition switch during removal/installation.
- Check and confirm if the voltage is over 12V with a voltmeter after replacement.
- Check and confirm if the other connectors are installed correctly after replacement.
- Do not damage the throttle body, it may cause the throttle and idle valve to fail synchronization.
- The throttle body is preset in KYMCO factory, do not disassemble it incorrectly.
- Do not loosen or tighten the painted bolts and screws for the throttle body. Loosening or tightening them can cause the throttle and idle valve synchronization to fail.
- TPS and ISC have to be reset after the throttle body MAP, TPS, ISC or ECU has been reinstalled.

MAP Inspection

Support the scooter on a level surface.

Put the side stand up and engine stop switch is at “RUN”.

Turn the ignition switch to “ON” position.

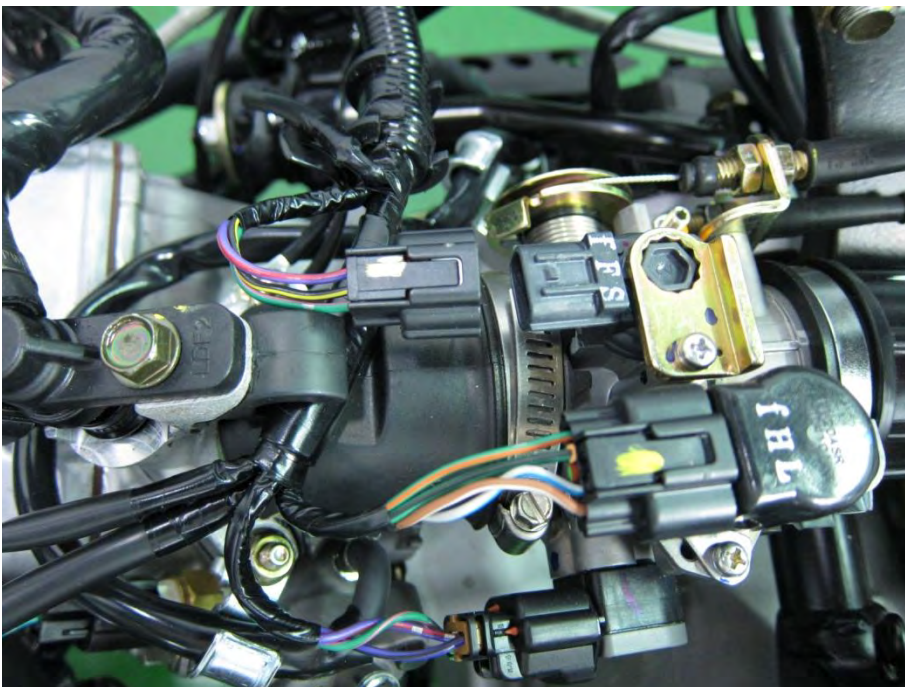

Measure if the ECU voltage outputs to the MAP between the following terminals of the MAP connector.

Terminal	Normal
Violet/Red (+) – Green/Pink (-)	5 V

TPS Inspection

Support the scooter on a level surface.

Put the side stand up and engine stop switch is at "RUN".

Turn the ignition switch to "ON".



Measure if the ECU voltage outputs to TPS between the following terminals of the TPS connector.

Terminal	Normal
Violet/Red (+) – Green/Pink (-)	5 V

Throttle Position Sensor (TPS) resistance (at 20°C/68°F)	3500 - 6500 Ω
---	----------------------

Removal

Remove the seat. See the [Seat](#) topic for more information.

Remove the luggage box. See the [Seat](#) topic for more information.

Adjust the throttle cables for maximum free play at the throttle body. See the [Throttle Free Play](#) topic for more information.

Throttle Cables

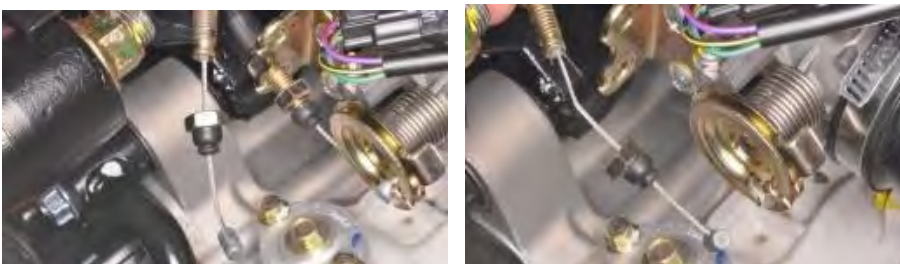

Free the throttle cables from the throttle drum.

Fuel Injector

SAFETY FIRST: Protective gloves and eyewear are recommended at this point.

Warning: Gas is extremely flammable! Do not work around an open flame or a source of sparks.

Disconnect the [Component Location](#) or [Fuel Pump](#).



In order to release fuel pressure from the fuel pipe when removing the fuel injector, unplug the fuel pump connector. Start the engine and let it run until it dies of fuel starvation. Turn the ignition switch off.

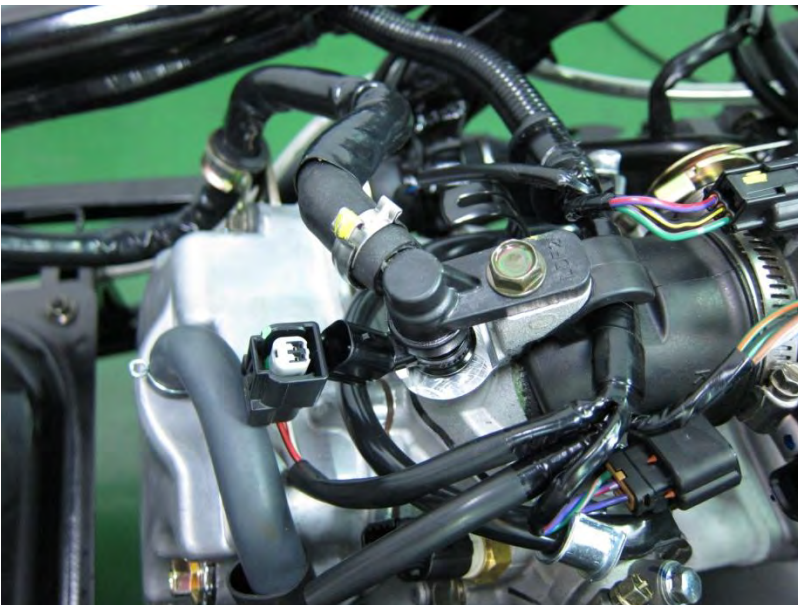

Inspect the fuel hose for signs of deterioration or damaged. Replace the fuel hose as needed.

Remove the fuel injector mounting bolt with a 10 mm socket.
Unplug the fuel injector connector.

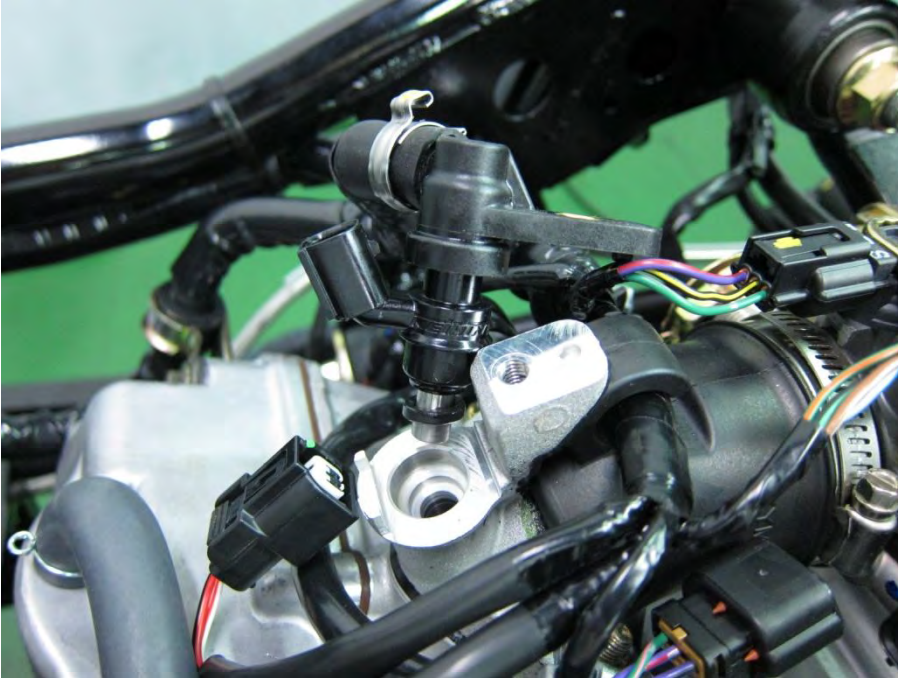

Lift the fuel injector out of the intake pipe.



Loosen the fuel hose clamp with a #2 Phillips screwdriver. Slide back the clamp and free the injector fuel pipe from the fuel hose.



Lift the fuel pipe off the top of the injector.

Sensors

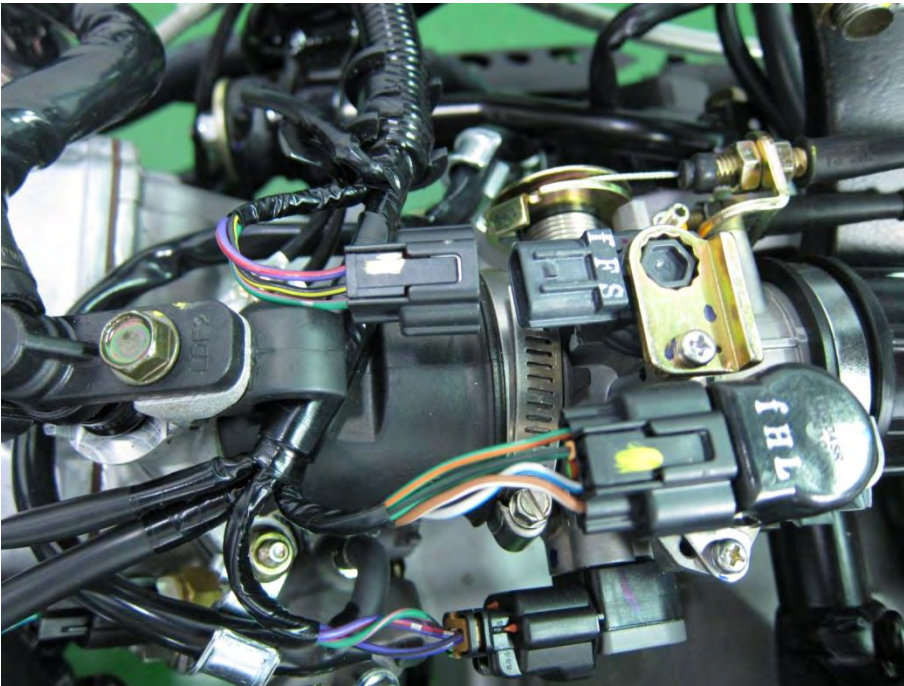

Unplug the MAP sensor.

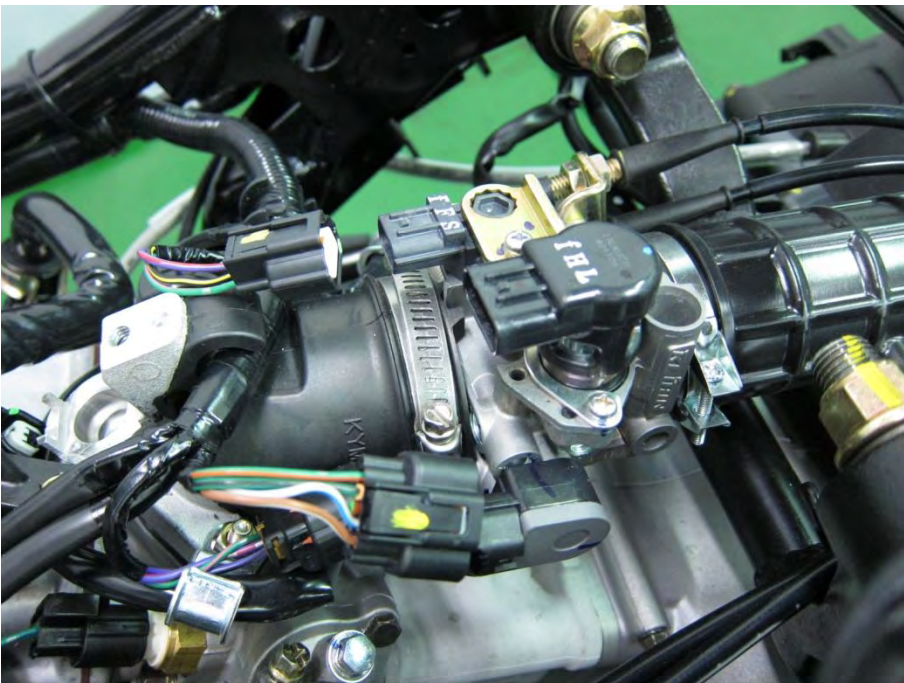

Unplug the ISC connector.

Throttle Body

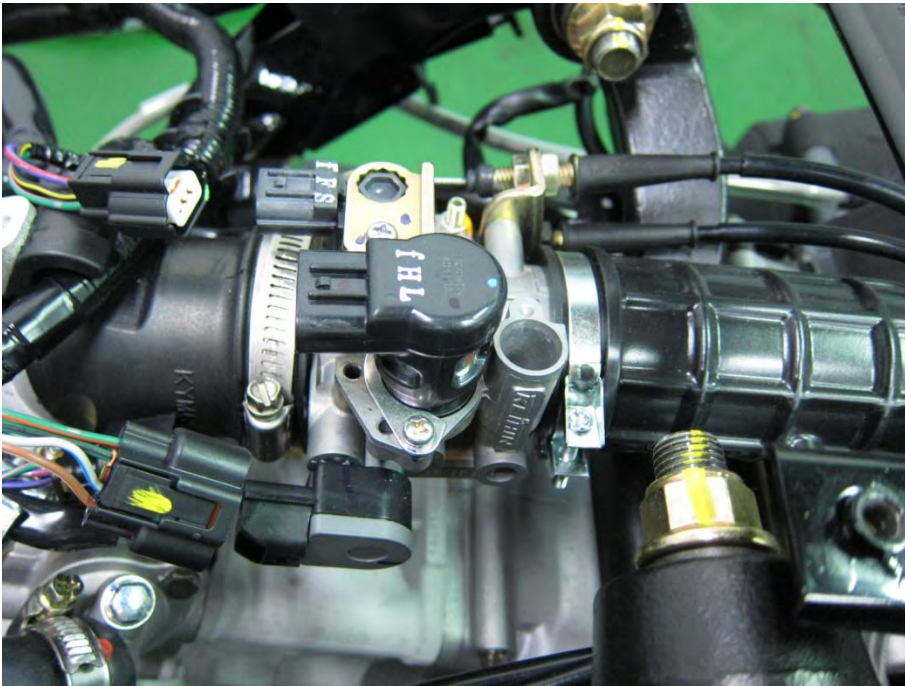

Unplug the throttle position sensor (TPS) connector.

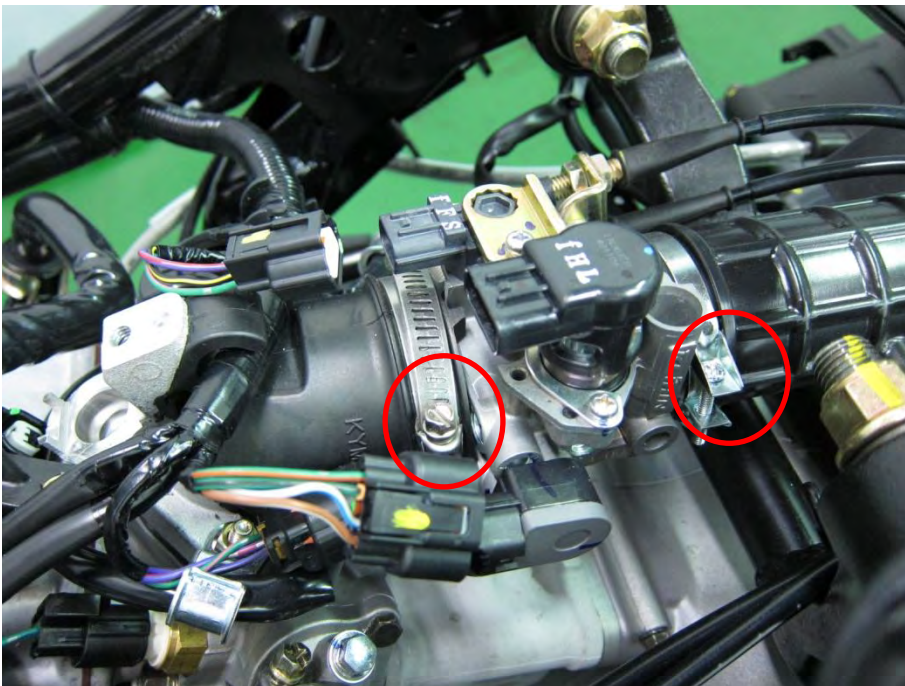

Loosen the airbox hose clamp screw at the throttle body with a #2 Phillips.
Loosen the intake hose clamp screw at the throttle body with a flat blade screwdriver.



Remove the throttle out of the airbox and intake boots.

To disassemble the throttle body see the [Throttle Body](#) topic for more information.

When installation:

The throttle position sensor (TPS) and idle air bypass valve (ISC) have to be reset when the throttle body MAP, TPS, ISC or ECU have been reinstalled. See the [TPS ISC Reset Procedure](#) for more information.



Apply a light coat of fresh engine oil to a new fuel injector O-ring.



Fit the fuel injector pipe onto the top of the injector. The tab on the injector must fit into the pipe.

Throttle Cable

SAFETY FIRST: Protective gloves and eyewear are recommended at this point.

Removal

Remove the seat. See the [Seat](#) topic for more information.

Remove the luggage box. See the [Luggage Box](#) topic for more information.

Remove the handlebar covers. See the [Handlebar Covers](#) topic for more information.

Adjust the throttle cables for maximum free play at the throttle body. See the [Throttle Free Play](#) topic for more information.

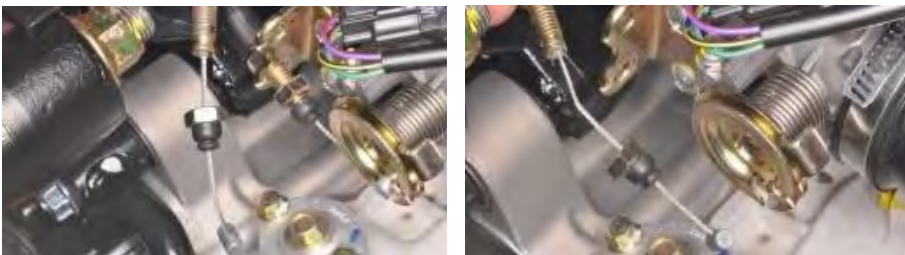

Free the throttle cables from the throttle drum.



Remove the two right switch housing mounting screws with a #2 Phillips screwdriver. Disconnect the switch.



Separate the switch housing from the handlebar.

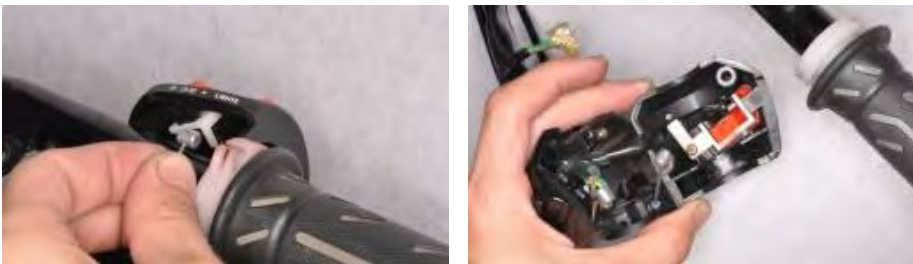

Disconnect the throttle cables and free the right switch housing from the handlebar.



Guide the throttle cables out towards the handlebar side.

Notes of installation

Route the throttle body end of the cables through the opening in the lower handlebar cover.



Route the cables through the guide.

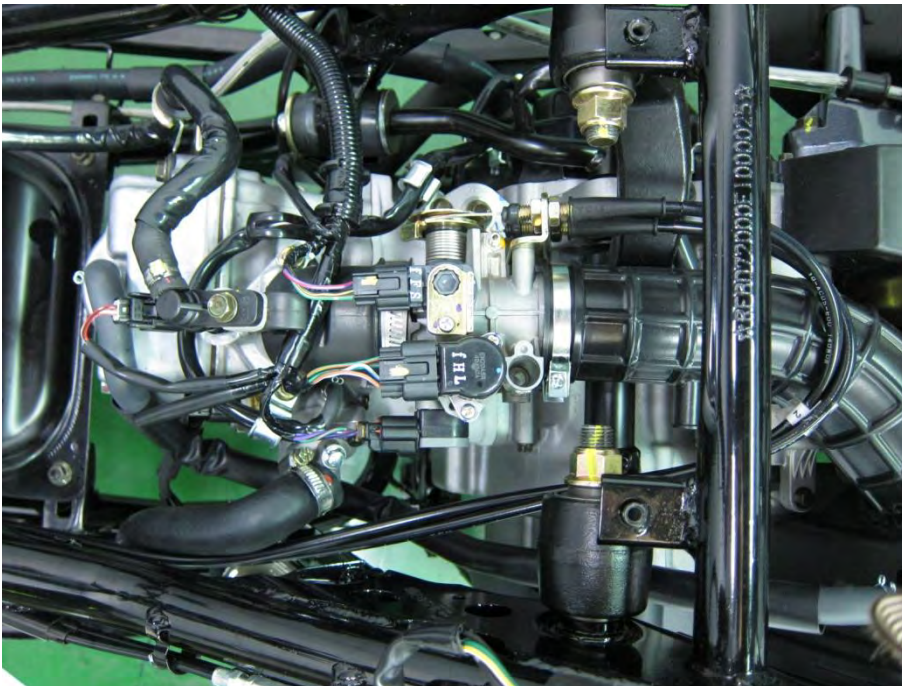

Route the cables to the throttle body as shown.



Slide the throttle grip onto the right side of the handlebar.

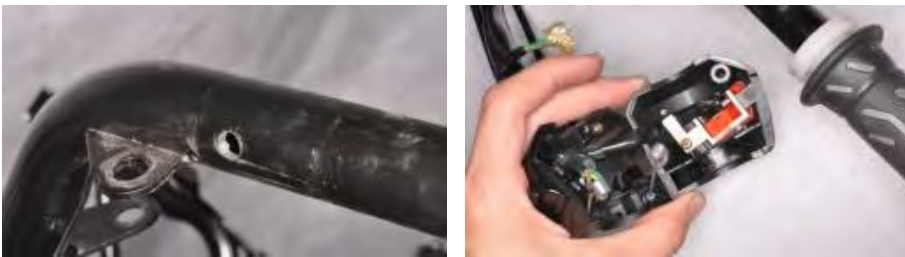

Install the right switch and throttle housing. The post on the housing should fit into the hole in the bar.



Lubricate the end of the throttle in grease. Fit the ends of the throttle cables into the throttle tube.

Adjust the throttle cable free play with 12 mm wrenches. See the [Throttle Free Play](#) topic for more information.

Install the handlebar covers. See the [Handlebar Covers](#) topic for more information.

Install the luggage box. See the [Luggage Box](#) topic for more information.

Install the seat. See the [Seat](#) topic for more information.

Throttle Body

SAFETY FIRST: Protective gloves and eyewear are recommended at this point.

Remove the throttle body. See the [Throttle Body Removal and Installation](#) topic for more information.

Disassembly

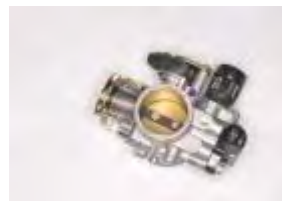

The throttle position sensor (TPS) and idle air bypass valve (ISC) have to be reset when the throttle body MAP, TPS, ISC or ECU have been reinstalled. See the [TPS ISC Reset Procedure](#) for more information.

MAP Sensor



Remove the MAP sensor set plate screw with a #2 Phillips.



Remove the set plate and MAP sensor.

ISC (Air Bypass Valve)



Remove the ISC screw with a #2 Phillips.



Remove the ISC.

TPS Sensor



Remove the TPS sensor with a T-25 Torx.

Assembly

TPS Sensor



Apply oil onto a new O-ring. Install the TPS onto the throttle body, being careful not to damage the O-ring. Install and tighten the screw securely with a T-25 Torx.

ISC (Air Bypass Valve)

Apply oil onto a new O-ring. Install the ISC and set plate onto the throttle body, being careful not to damage the O-ring.



Install the ISC screw and tighten securely with a #2 Phillips.

MAP Sensor



Apply oil onto a new O-ring. Install the MAP onto the throttle body, being careful not to damage the O-ring.



Install the MAP sensor set plate screw and tighten securely with a #2 Phillips.

Install the throttle body. See the [Throttle Body Removal and Installation](#) topic for more information.

Fuel Injector

SAFETY FIRST: Protective gloves and eyewear are recommended at this point.

Warning: Gas is extremely flammable! Do not work around an open flame or a source of sparks.

Removal

Remove the seat. See the [Seat](#) topic for more information.

Remove the luggage box. See the [Luggage Box](#) topic for more information.

SAFETY FIRST: Protective gloves and eyewear are recommended at this point.

Warning: Gas is extremely flammable! Do not work around an open flame or a source of sparks.



In order to release fuel pressure from the fuel pipe when removing the fuel injector, unplug the fuel pump connector. Start the engine and let it run until it dies of fuel starvation. Turn the ignition switch off.

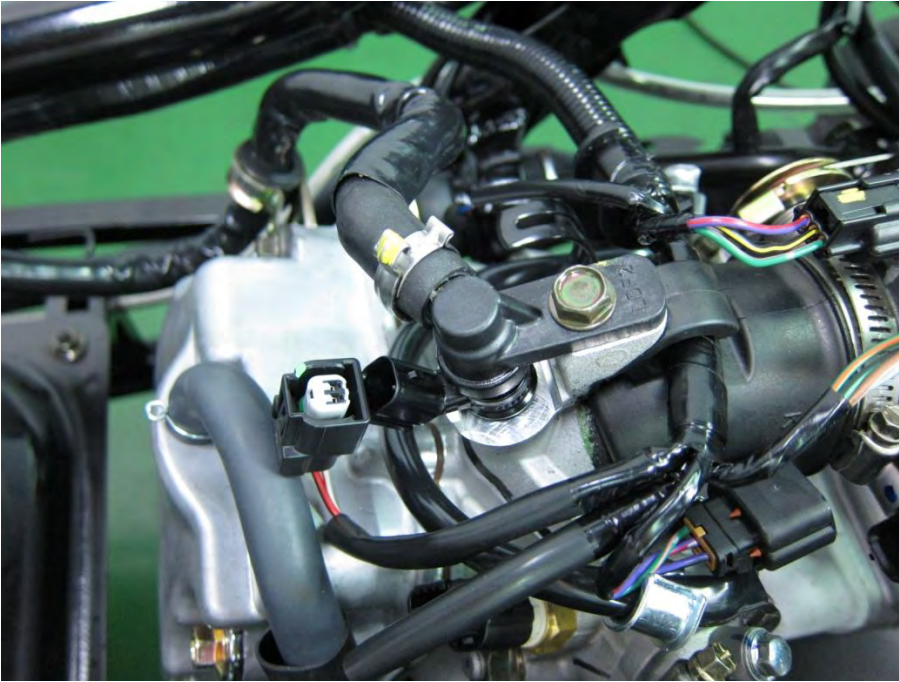

Inspect the fuel hose for signs of deterioration or damaged. Replace the fuel hose as needed.

Unplug the fuel injector connector.

Remove the fuel injector mounting bolt with a 10 mm socket.

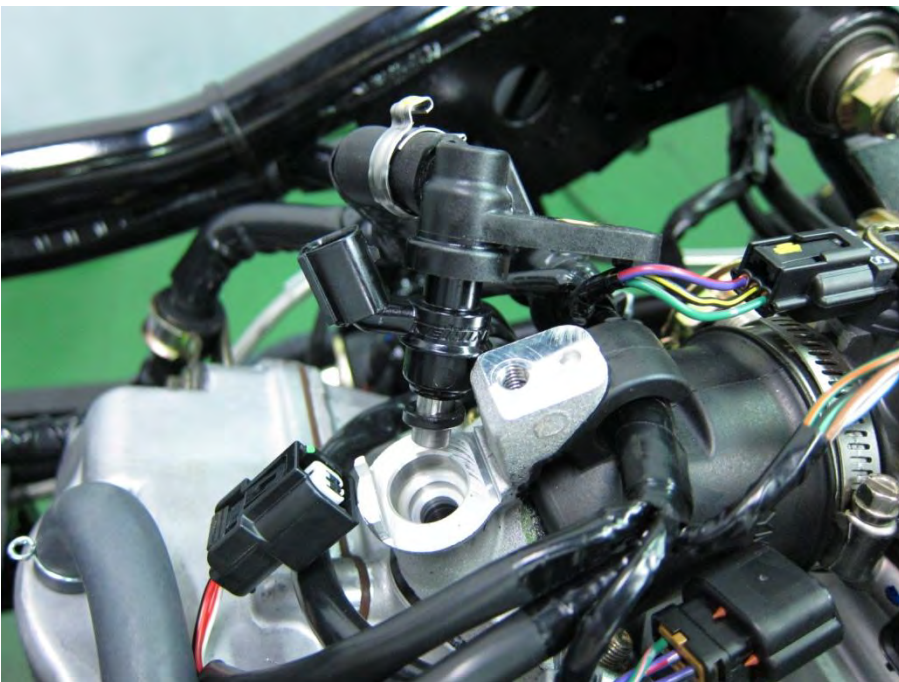

Lift the fuel injector out of the intake pipe.

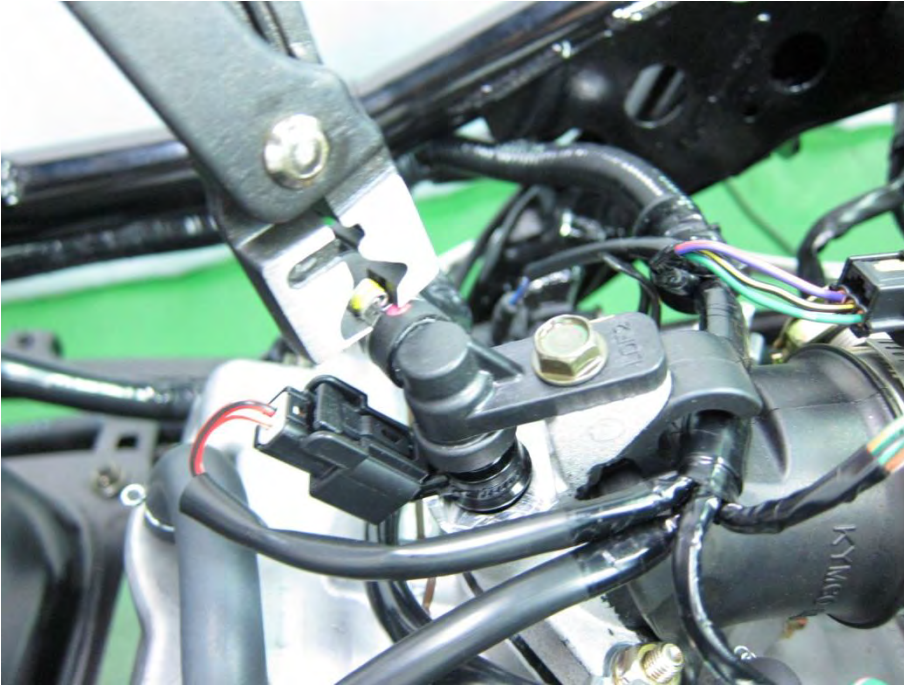

Loosen the fuel hose clamp. Slide back the clamp and free the injector fuel pipe from the fuel hose.



Lift the fuel pipe off the top of the injector.

Inspection

A digital multi meter is needed to test the fuel injector.

Measure the resistance between the fuel injector terminals.

ITEM	SPECIFICATIONS
Fuel injector resistance (at 20°C/68°F)	9.9 - 13.5 Ω



Inspect the seals on both sides of the fuel injector. Replace the injector if the seals are in poor condition.

Check for signs of clogging.

Set the multi meter to read ohms of resistance (Ω).

Cleaning

PROBLEM

1. Fuel Injector cannot output the fuel.
2. The Injector injection time (ms) is shorter or longer.
Standard: < 1.6ms

ANALYSIS

Injector block (With some carbons).

TROUBLESHOOTING

1. Use the specified injector cleaner.
2. Pouring the liquid of carburetor cleaner until half container.
3. Connect the battery as picture.
4. The injector cleaner with the flash relay.
5. Keeping the fuel Injector operation.
6. Waiting for 20-30 minutes.
7. Cleaning the carbons completely.

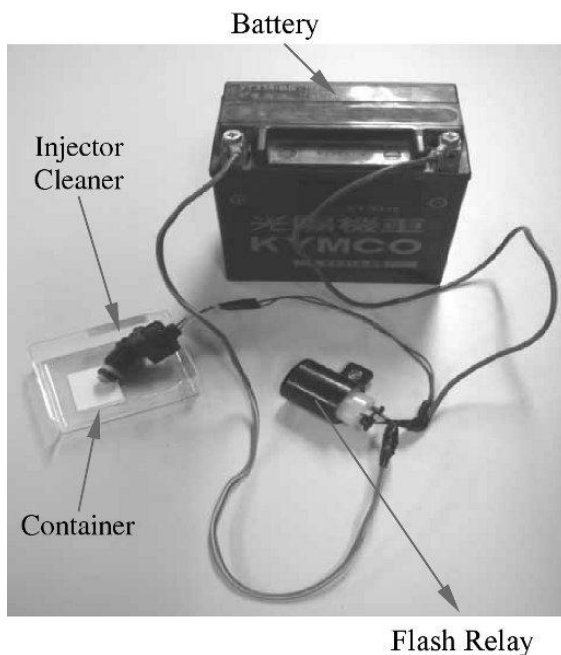

TPS ISC Reset Procedure

SAFETY FIRST: Protective gloves and eyewear are recommended at this point.

- When opening and closing the throttle grip randomly, the ECU may record the incorrect TPS reading when the ECU or the throttle body has been reinstalled. It can cause hard to start engine or idling speed is not smooth when engine installation.
- ISC has a motor inside, which controls the ISC valve to obtain a smooth idling speed. The ECU may record the incorrect ISC position when the engine is running because the ECU or the throttle body has been reinstalled. It can cause engine to stop, hard to start engine or rough idling speed.

The throttle position sensor (TPS) and idle air bypass valve (ISC) have to be reset when throttle body, MAP, TPS, ISC or ECU have been reinstalled.

TPS/ISC RESET PROCEDURE

1. Put the side stand up and engine stop switch is at "RUN".
2. Turn the key to the "OFF" position.
3. Fully open the throttle.
4. Turn the key to the "ON" position.
5. Release the throttle after waiting for eight seconds.
6. Turn the key to the "OFF" position.
7. Turn the key to the "ON" position.
8. TPS and ISC have been reset successfully.

If the procedure fails, repeat the steps from 1 to 8.

Self-Diagnosis

SAFETY FIRST: Protective gloves and eyewear are recommended at this point.

Note: No matter when the CELP illuminated while riding condition, should find out the cause of the problem as soon as possible.

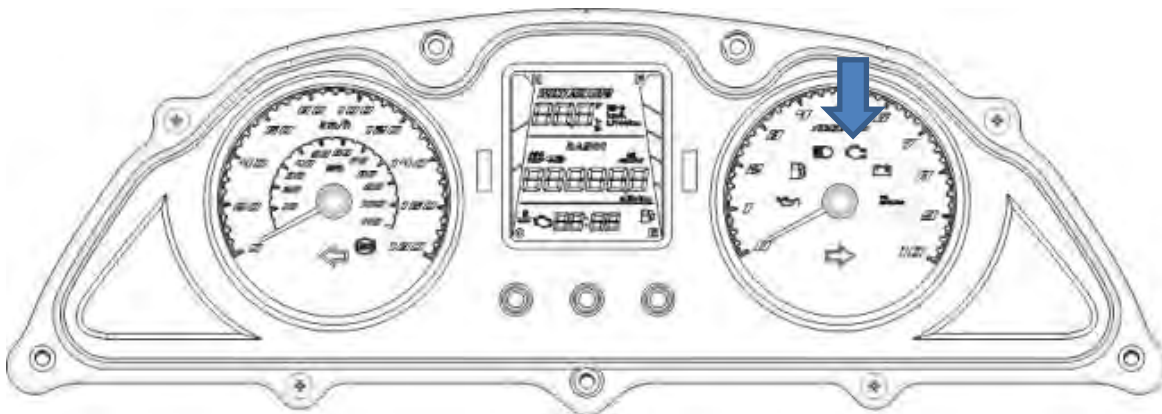

The check engine lamp (CELP) or Fi indicator is located next to the battery warning indicator.

If the ECM connectors, or battery leads are disconnected the stored malfunction codes will be lost.

Without Diagnostic Special Tool

SELF-DIAGNOSTIC PROCEDURES



Place the scooter on its main stand and put the side stand up.



Set the engine stop switch to the "RUN" position.

- Turn key to On position.
- The CELP will be lighting for two seconds and then off.
- If the engine has problem, the CELP will blink to show the failure codes.
- There're 11 failure codes for the KEHIN system.

If the vehicle gets more failure codes, the CELP will be blinking from a lower number, then show the higher number after three seconds. All failure codes would be appeared repeatedly. It can be performed without diagnostics program.

EFI SELF-DIAGNOSIS FAILURE CODES

The CELP denotes the failure codes. When the indicator lights for one second that is equal to ten.

For example: one longer blink illumination and two shorter blinks (0.5 second x 2) of the indicator is equal to 12 blinks. Follow code 12.

If more than a damaged part has occurred, the CELP begins blinking in order.

For example: If the indicator blinks six times, then shows one second illumination and two blinks, so there are two failures have occurred. Follow code 6 and 12.

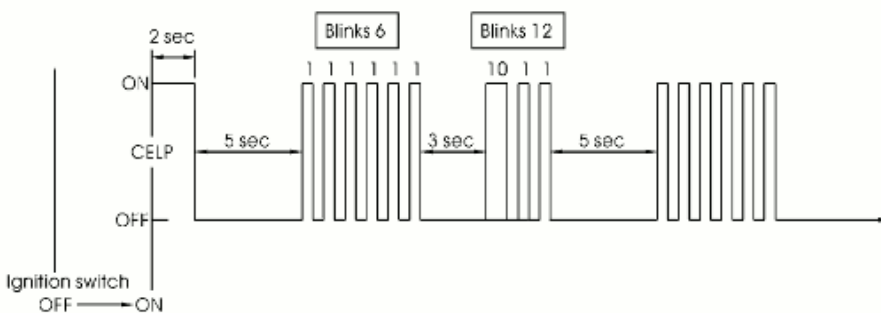

CELP FAILURE CODES LIST				
Blinks	Failure Codes	Contents	Causes	Symptoms
06	P0120	Faulty TPS	<ul style="list-style-type: none"> Faulty TPS voltage range (0.3 - 4.5 V) Loose or poor connection on TPS Sensor Open or short circuit on the TPS wire Faulty TPS itself. 	Engine operates normally
09	P0105	Faulty MAP	<ul style="list-style-type: none"> Faulty MAP voltage range (1 - 4.2 V) Loose or poor connection on MAP Sensor Open or short circuit on MAP wire Faulty MAP itself 	Engine operates normally
12	P0115	Faulty WTS (watertemp.)	<ul style="list-style-type: none"> Faulty ECT Ω range (-20°C: 18.8 Ω/40°C: 1.136 Ω/100°C: 0.1553 Ω) Loose or poor connection on ECT Open or short circuit on ECT wire Faulty ECT 	Engine operates normally
15	P1630	Faulty Tilt switch (Roll)	<ul style="list-style-type: none"> Faulty Tilt switch voltage range (inclined angle <65°: 0.4 - 1.4 V/ Inclined angle >65°: 3.7 - 4.4 V) Loose or poor connection on Tilt switch Open or short circuit in Tilt switch wire Faulty tilt switch 	Engine operates normally
17	P0130	Faulty O ² sensor	<ul style="list-style-type: none"> Faulty O² sensor voltage range (A/F below 14.7: > 0.7V/ A/F over 14.7: < 0.18 V) Loose or poor connection on O² sensor Open or short circuit on O² sensor wire Faulty O² sensor 	Engine operates normally
33	P0201	Faulty injector (Nozzle)	<ul style="list-style-type: none"> Faulty Fuel injector Ω range (9.945 - 13.5 Ω) Loose or poor connection on injector Open or short circuit on injector wire Faulty fuel injector 	Engine fails to be operated
37	P0351	Faulty inductive ignition coil	<ul style="list-style-type: none"> Faulty Inductive ignition coil Ω range (4.2 Ω \pm 15%) Loose or poor connection on inductive ignition coil Open or short circuit on inductive ignition coil wire Faulty inductive ignition coil 	Engine fails to be operated

41	P0230	Faulty fuel pump	<ul style="list-style-type: none"> • Faulty Fuel pump fl range (F: $1100 \pm 33 \Omega$ E: $100 + 3 \Omega$) • Loose or poor connection on fuel pump • Open or short circuit on fuel pump wire • Faulty fuel pump 	Engine fails to be operated
45	P0135	Faulty O ² sensor heater	<ul style="list-style-type: none"> • Faulty O² sensor heater Ω range (6.7 -9.5 Ω) • Loose or poor connection on O² sensor heater • Open or short circuit on O² sensor heater wire • Faulty O² sensor heater 	Engine starts normally but not smooth
49	P1505	Faulty ISC	<ul style="list-style-type: none"> • Loose or poor contacts on ISC • Open or short circuit in ISC wire • Faulty ISC 	Engine operates normally
66	P0335	Faulty CPS	<ul style="list-style-type: none"> • Loose or poor connection on CPS sensor • Open or short circuit on CPS wire • Faulty CPS sensor 	Engine starts normally but not smooth

Self-Diagnosis Reset Procedure

Note: The self-diagnosis memory cannot be reset when there is still a problem inside the system.

1. Put the side stand up and engine stop switch is at "RUN".
2. Turn the key to the ON position and wait for ten seconds.

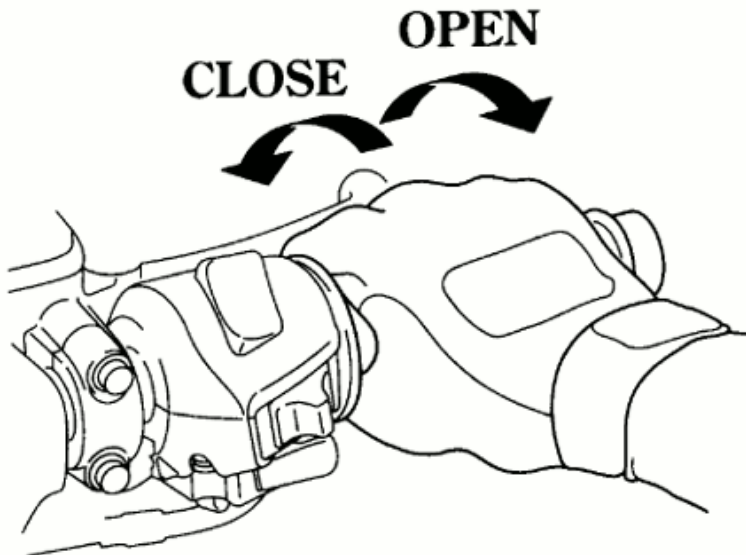

3. Fully open the throttle and wait for ten seconds.
4. Release the throttle.

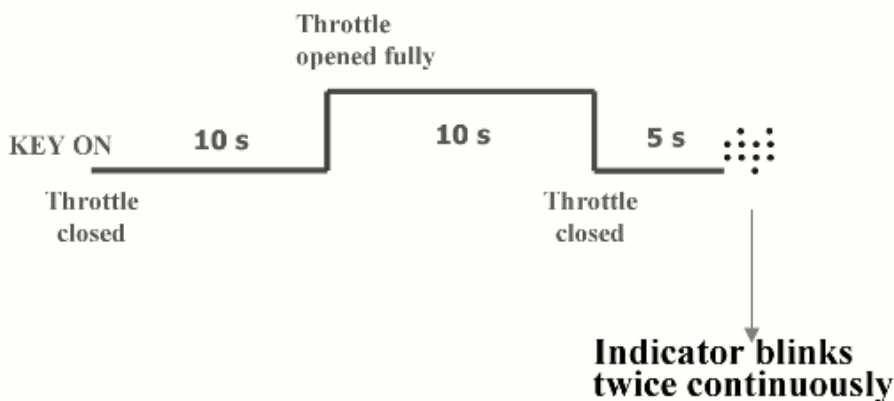

5. After 5 seconds the indicator will blink twice.
6. After the CELP goes out the self-diagnosis memory of the ECU is cleared. If the CELP remains lit a trouble code is still present.

Spark Plug Anti-Flood

When no failure code occurs and pressing starter switch repeatedly can still not start the engine the spark plug maybe fouled and there may be a flooded engine. Perform the spark plug anti-flood to purge the fuel in the engine.

Make sure the battery voltage is greater than 12 V.

1. Close the throttle, turn the ignition switch to ON.
2. Open and hold the throttle fully, pressing starter switch more than 3 seconds.

TPS/ISC Reset

- If the throttle is being moved when the throttle body or TPS is installed it can cause a hard to start engine or incorrect idling speed.
 - ISC has a motor inside, which controls air bypass valve to obtain a smooth idling speed. The ECU may record the incorrect ISC position when the ECU or the throttle body has been reinstalled. It can cause engine stop, hard to start engine or rough idling speed.
- The throttle position sensor (TPS) and idle air bypass valve (ISC) have to be reset when throttle body, MAP, TPS, ISC or ECU have been reinstalled.

TPS/ISC RESET PROCEDURE

1. Put the side stand up and engine stop switch is at "RUN".
2. Turn the key to the OFF position.
3. Fully open the throttle.
4. Turn the key to the ON position.
5. Release the throttle after waiting for eight seconds.
6. Turn the key to the OFF position.
7. Turn the key to the ON position.
8. TPS and ISC have been reset successfully. If fail to reset, repeat the steps from 1 to 8.

Fuel Injection Diagnostic Tool

SAFETY FIRST: Protective gloves and eyewear are recommended at this point.

OPERATION INSTRUCTIONS



Diagnostic tool Part Number: 3620A-LEB2-E00

This tool has been developed by KYMCO and for KYMCO vehicles only.

The tool software can be updated for new models with a computer via the USB cable.

Please refer to the specifications when serving this vehicle.

This tool does not have an internal battery. The power for the tool is provided by the vehicle when connected. The vehicle should have a fully charged battery when using the diagnostic tool.

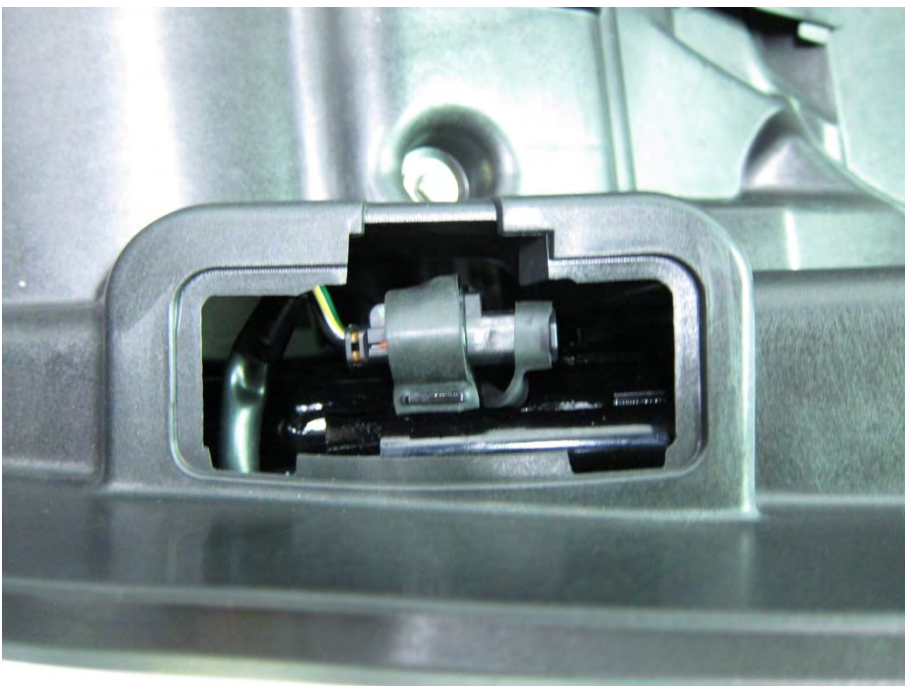

Remove the PDA panel located at the rear of the luggage box and free the PDA plug.



Plug in the tool to the ECU connector and turn on the ignition switch to send power to the tool.

Place the scooter on its main stand and put the side stand up prior to using the diagnostic tool.



□ The functions of the diagnostic tool include ECU version, model name, data analysis and reset.

ECU version: includes model name, ECU number, identifications number and software version.

Failure codes: DTC reading, DTC clearing, and troubleshooting.

Data analysis: For ECU's software inspection.

Reset: For the setting function adjustment.

ECU Version



The four functions will display when the tool is powered on. The model name will show LEA7 for the Downtown 300i.



Pressing the enter button on the ECU version will show model name, ECU number, identifications number and software version.

Press the down button (right) to return to the first page.

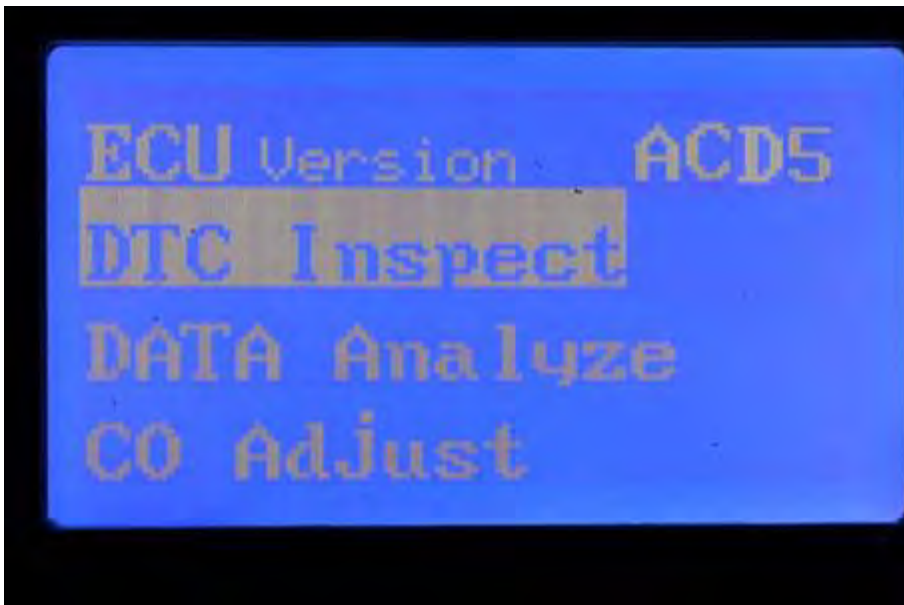
DTC (Diagnostic Trouble Code) INSPECTION PROCEDURE

Press the down button (right) to move the item selector down to the DTC Inspect item.



Pressing the enter button on the DTC Inspect item will bring up the options shown above.



Press the down button to select the load DTC option. Press the enter button on the Load DTC item to display the DTC options.

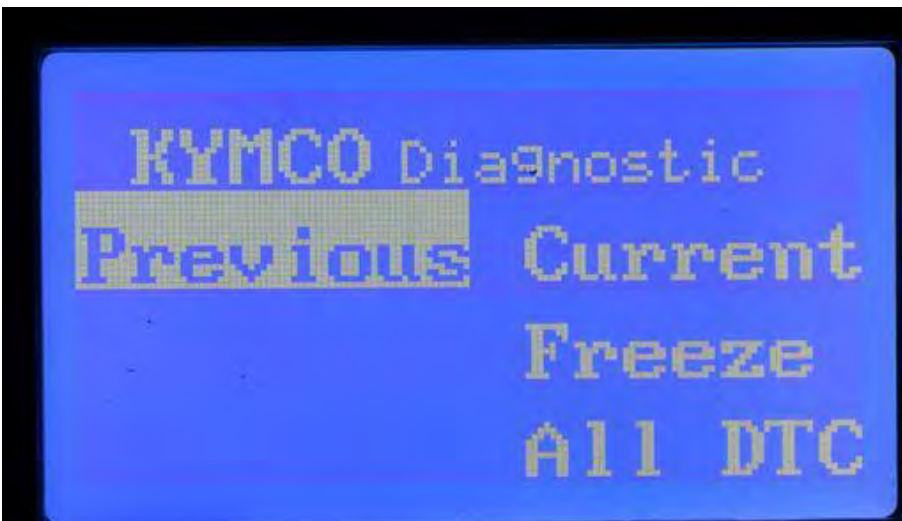

Move the selector to the Current option and press enter to display current DTC.



The diagnostic tool will display all current DTC.

CELP FAILURE CODES LIST				
Blinks	Failure Codes	Contents	Causes	Symptoms
06	P0120	Faulty TPS	<ul style="list-style-type: none"> Faulty TPS voltage range (0.3 - 4.5 V) Loose or poor connection on TPS Sensor Open or short circuit on the TPS wire Faulty TPS itself. 	Engine operates normally
09	P0105	Faulty MAP	<ul style="list-style-type: none"> Faulty MAP voltage range (1 - 4.2 V) Loose or poor connection on MAP Sensor Open or short circuit on MAP wire Faulty MAP itself 	Engine operates normally
12	P0115	Faulty WTS (watertemp.)	<ul style="list-style-type: none"> Faulty ECT Ω range (-20°C: 18.8 Ω/40°C: 1.136 Ω/100°C: 0.1553 Ω) Loose or poor connection on ECT Open or short circuit on ECT wire Faulty ECT 	Engine operates normally
15	P1630	Faulty Tilt switch (Roll)	<ul style="list-style-type: none"> Faulty Tilt switch voltage range (inclined angle <65°: 0.4 - 1.4 V/ Inclined angle >65°: 3.7 - 4.4 V) Loose or poor connection on Tilt switch Open or short circuit in Tilt switch wire Faulty tilt switch 	Engine operates normally
17	P0130	Faulty O ² sensor	<ul style="list-style-type: none"> Faulty O² sensor voltage range (A/F below 14.7: > 0.7V/ A/F over 14.7: < 0.18 V) Loose or poor connection on O² sensor Open or short circuit on O² sensor wire Faulty O² sensor 	Engine operates normally
33	P0201	Faulty injector (Nozzle)	<ul style="list-style-type: none"> Faulty Fuel injector Ω range (9.945 - 13.5 Ω) Loose or poor connection on injector Open or short circuit on injector wire Faulty fuel injector 	Engine fails to be operated
37	P0351	Faulty inductive ignition coil	<ul style="list-style-type: none"> Faulty Inductive ignition coil Ω range (4.2 Ω \pm 15%) Loose or poor connection on inductive ignition coil Open or short circuit on inductive ignition coil wire Faulty inductive ignition coil 	Engine fails to be operated

41	P0230	Faulty fuel pump	<ul style="list-style-type: none"> • Faulty Fuel pump fl range (F: $1100 \pm 33 \Omega$ E: $100 + 3 \Omega$) • Loose or poor connection on fuel pump • Open or short circuit on fuel pump wire • Faulty fuel pump 	Engine fails to be operated
45	P0135	Faulty O ² sensor heater	<ul style="list-style-type: none"> • Faulty O² sensor heater Ω range (6.7 -9.5 Ω) • Loose or poor connection on O² sensor heater • Open or short circuit on O² sensor heater wire • Faulty O² sensor heater 	Engine starts normally but not smooth
49	P1505	Faulty ISC	<ul style="list-style-type: none"> • Loose or poor contacts on ISC • Open or short circuit in ISC wire • Faulty ISC 	Engine operates normally
66	P0335	Faulty CPS	<ul style="list-style-type: none"> • Loose or poor connection on CPS sensor • Open or short circuit on CPS wire • Faulty CPS sensor 	Engine starts normally but not smooth

Select the previous options to return to the original screen.

DTC Clear Procedure

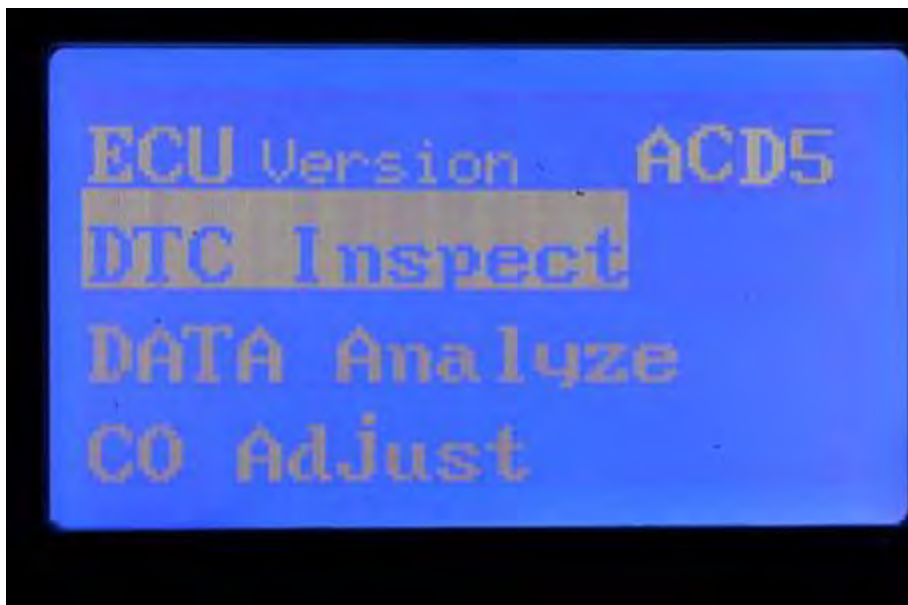

Press the down button (right) to move the item selector down to the DTC Inspect item.



Pressing the enter button on the DTC Inspect item will bring up the options shown above.



Move the selector down to the Clear DTC option and press enter.



The diagnostic tool will show when the DTC in memory are cleared. Also, the DTC indicator light between the center and right buttons will be off.

Data Analysis Procedure

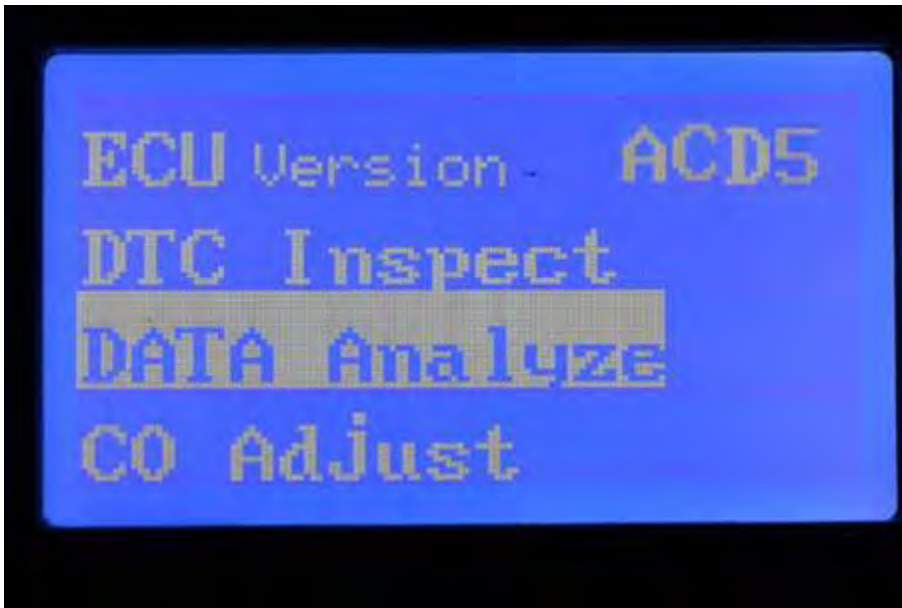

Press the down button (right) to move the item selector down to the DATA Analyze item. Press enter to bring up the DATA Analyze page 01 shown below. Press the down button to continue through the seven DATA Analyze pages.

Page 01



The 01 page shows engine speed, battery voltage, and DTC number.

Page 02

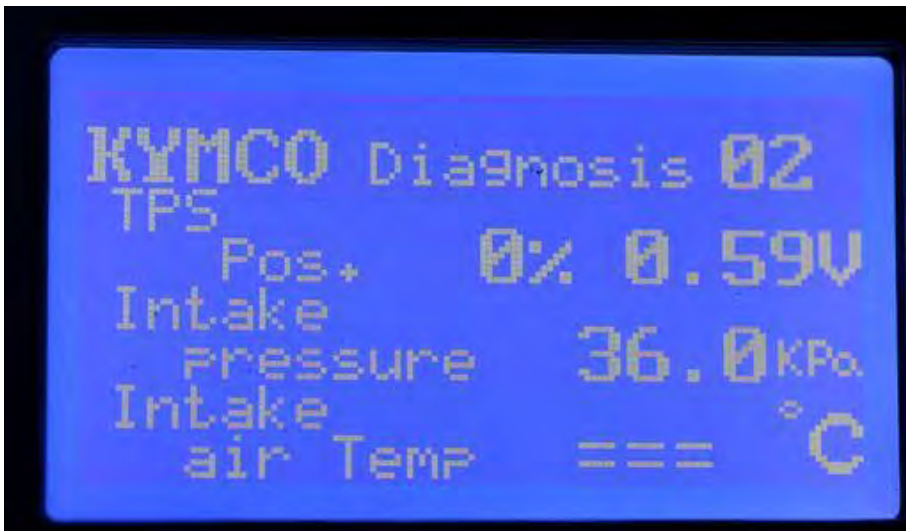

The 02 page shows TPS position, intake pressure, and intake air temperature if available.

Page 03

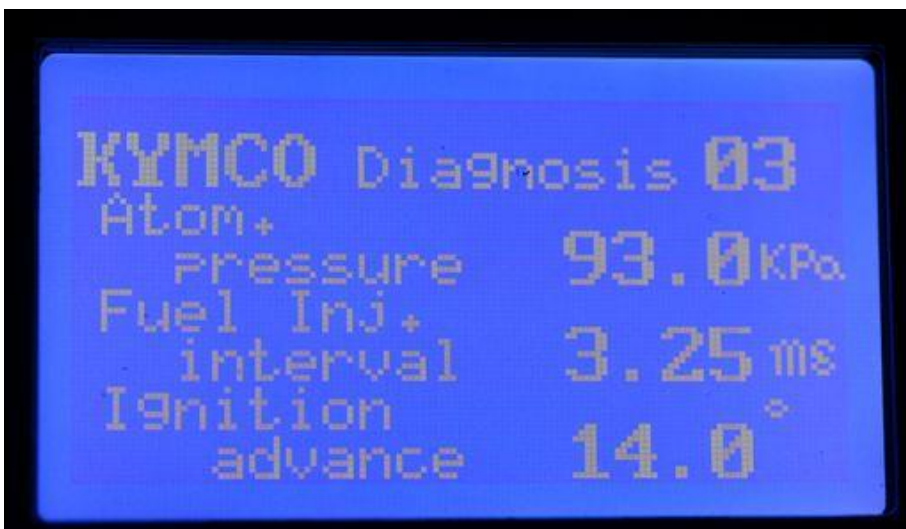

The 03 page shows atmosphere pressure, fuel injector interval, and ignition advance timing.

Page 04



The 04 page shows engine temperature, O2 sensor voltage, and O2 heater activation.

Page 05

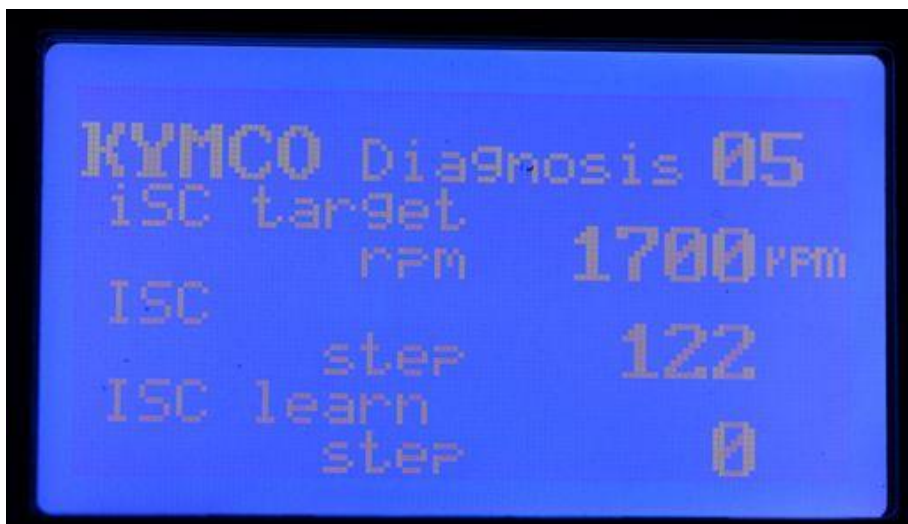

The 05 page shows the ISC target, ISC step, and ISC learn step.

Page 06

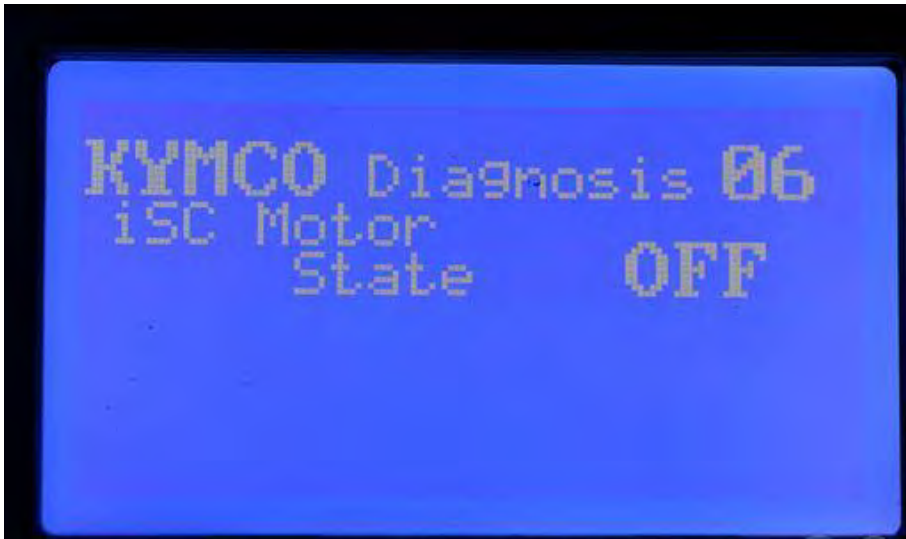

The 06 page shows the ISC motor stage.

Page 07

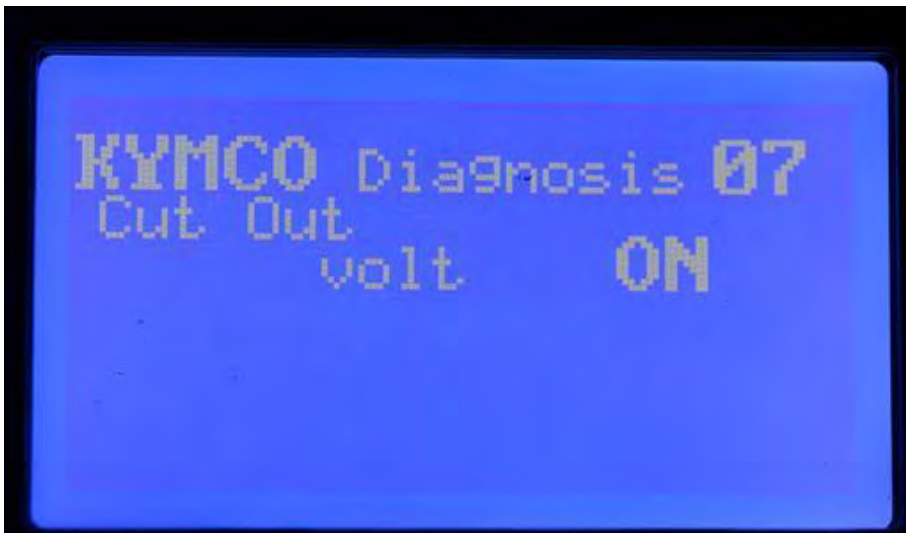

The 07 page shows the Cut Out voltage.

7.CVT Continuously Variable Transmission

This chapter covers the location and servicing of the CVT components for the KYMCO Downtown 350i model.

<u>Belt Case</u>	7-2
<u>CVT Removal</u>	7-7
<u>CVT Installation</u>	7-26

GENERAL INSTRUCTIONS

- The drive pulley, clutch and driven pulley can be serviced with the engine installed.
- Avoid getting grease and oil on the drive belt and pulley faces. Remove any oil or grease from them to minimize the slipping of drive belt and drive pulley.

TROUBLESHOOTING

Engine starts but motorcycle won't move

- Worn drive belt
- Broken ramp plate
- Worn or damaged clutch lining
- Broken driven face spring

Engine stalls or motorcycle creeps

- Broken clutch weight spring

Lack of power

- Worn drive belt
- Weak driven face spring
- Worn weight roller
- Faulty driven face

Belt Case

SAFETY FIRST: Protective gloves and eyewear are recommended at this point.

Removal

Remove the mounting bolts of belt case cover.



Remove the belt case cover.



Remove the bolts of belt case and remove the belt case.



Remove the bolts of filter and remove the filter.

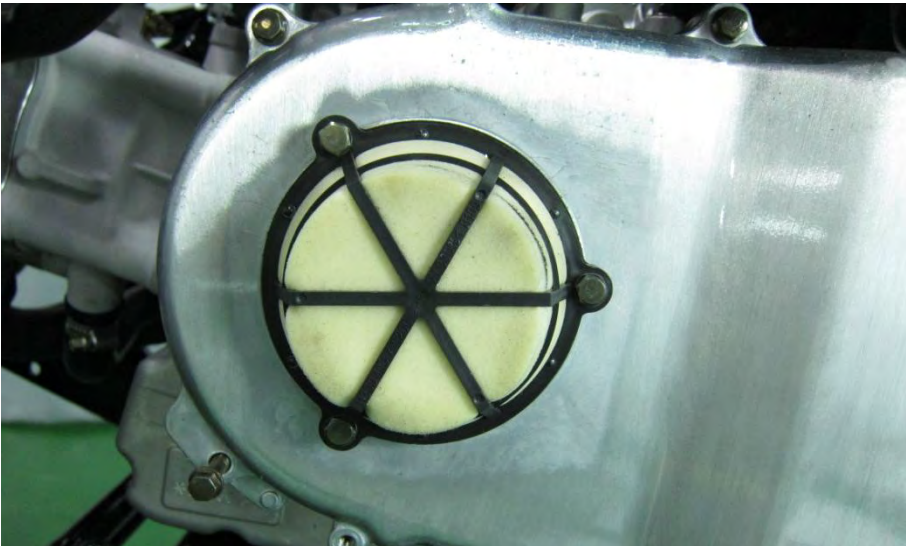

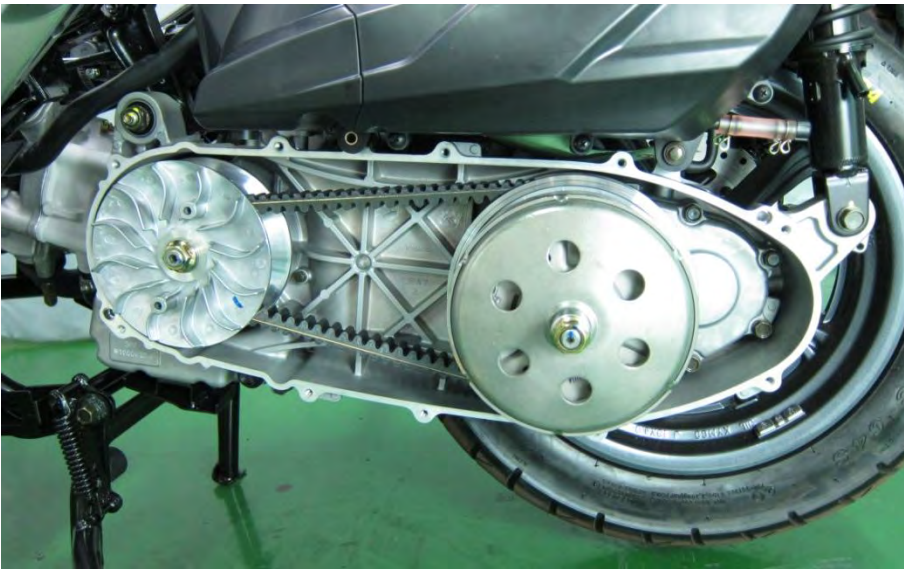

Remove the belt case cover and gasket.



Remove the two dowel pins.

Inspection

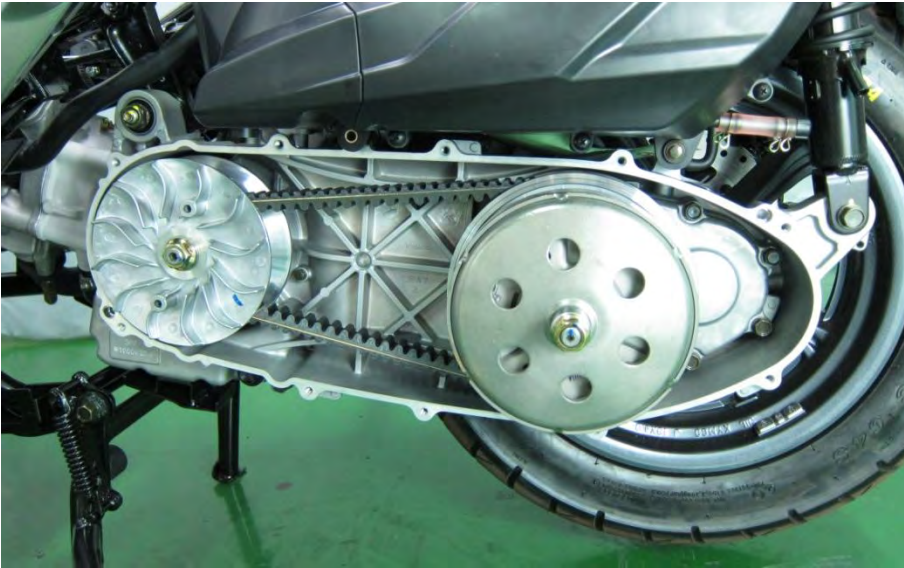

Inspect the drive belt for cracks or excessive wear.



Inspect the belt case bearing by turning it with a finger. Replace the bearing if it is rough or noisy.



Remove the bearing snap ring with snap ring pliers.



Remove the bearing with a suitable bearing puller.



Drive in a new bearing with a suitable bearing driver that has the same outside diameter as the bearing.



Install a new snap ring with snap ring pliers.

CVT Removal

SAFETY FIRST: Protective gloves and eyewear are recommended at this point.

Remove the belt case. See the [Belt Case](#) topic for more information.

Pulleys and Belt



Hold the drive pulley with a universal holder tool and loosen the nut with a 19 mm socket.



Remove the drive pulley nut and washer from the crankshaft.



Remove the left face of the drive pulley.



Loosen the driven pulley nut with a 19 mm socket.



Remove the driven pulley nut and bushing.



Slide the driven pulley off of the shaft.



Remove the belt from the driven pulley.



Inspect the drive belt for cracks or excessive wear.



Remove the right (movable) face of the drive pulley from the crankshaft. Slide the bushing out of the movable drive face.



Remove the washer from the crankshaft.

Drive Pulley Disassembly



Inspect the faces of the drive pulley. Clean away any grease from the faces.



Lift the ramp plate out of the back of the movable drive pulley face.



Remove the rubber damper pieces from the ramp.



There are eight weight rollers in the back of the movable face of the drive pulley.



Remove the rollers and check them for excessive or uneven wear. Measure the outside diameter of the rollers. Replace the weight rollers as needed.

Item	Standard (mm)	Service Limit (mm)
Weight roller O.D (Drive Pulley)	19.92 - 20.08	20.08



Inspect the movable drive face and bushing for wear and damage. Replace the parts as needed.

Clutch Disassembly



Lift the clutch outer off of the centrifugal clutch.



Inspect the inside of the clutch outer for excessive wear and damage. Measure the inside diameter of the clutch outer and replace the part as needed.

Item	Standard (mm)	Service Limit (mm)
Clutch outer I.D.	152.1 - 152.2	152.2

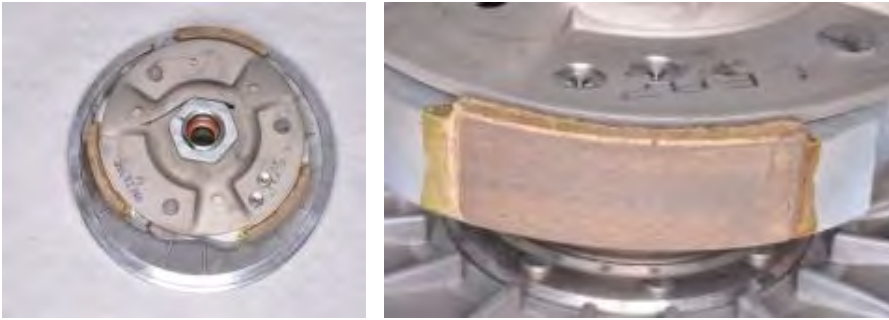

Inspect the clutch shoe lining thickness. Replace the shoes if the wear is below the service limit.

Item	Standard (mm)	Service Limit (mm)
Clutch lining thickness	4.0	2.0



To disassemble the clutch and driven pulley set the clutch fitting tool to onto the clutch.

ITEM	TOOL NO.	DESCRIPTION
#41 NUT AND FITTING TOOL	A120E00028	Clutch disassembly



Fit the clutch and fitting tool into the clutch spring compressor tool.



Use the clutch spring compressor tool to compress the spring in the driven pulley assembly.



Secure the spring compressor tool in a vise. Loosen the clutch drive plate nut with the special socket that comes with the fitting tool.



Remove the clutch drive plate nut.



Inspect the left side bearing by turning it with a finger. If the bearing is rough turning or noisy it should be replaced.

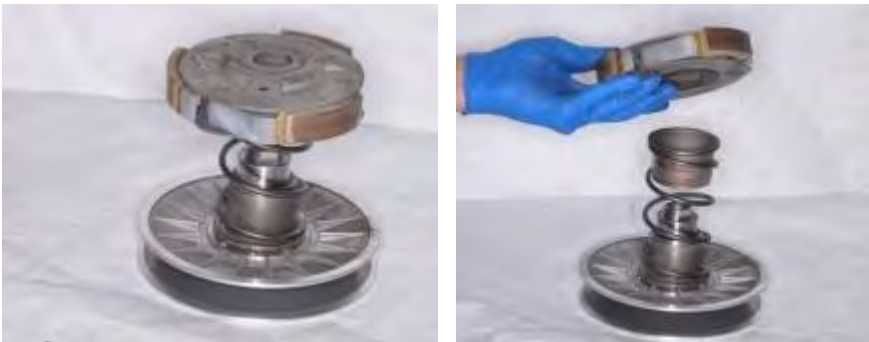

Remove the clutch spring compressor tool. Lift off the centrifugal clutch.





Remove the collars and spring.



Measure the free length of the clutch spring. Replace the spring if the measurement fails to meet the service limit.





Remove the three circlips from the clutch pivot pins with a small flat blade screwdriver.

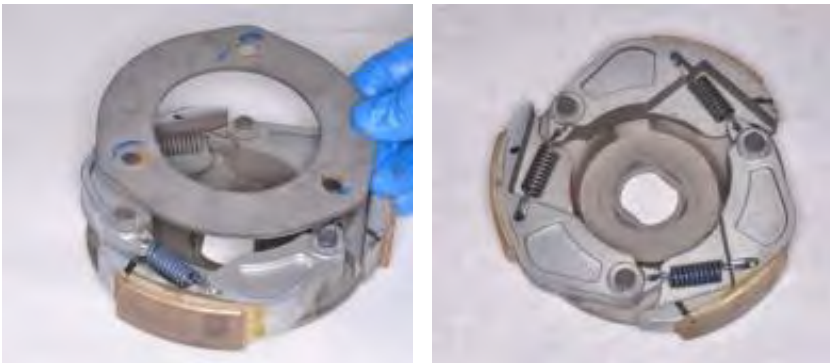

Lift off the plate.



Slide the clutch shoes off of the pivots on the drive plate.



Inspect the clutch shoe bumpers and replace them as needed.

Driven Pulley Disassembly

Remove the clutch as shown above.



Remove the four guide rollers with guide roller pins.

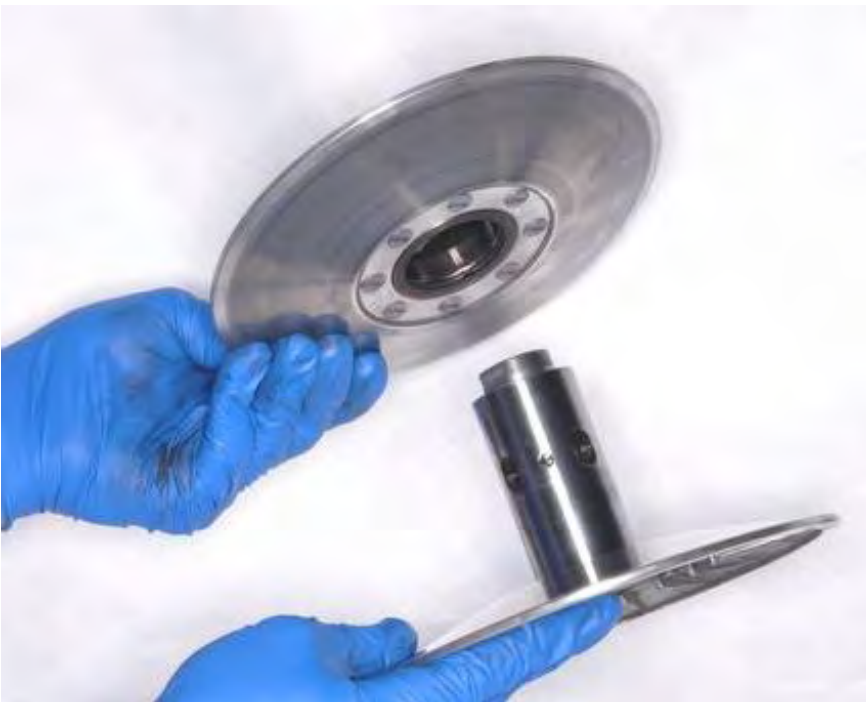

Separate the left and right faces of the driven pulley.



Inspect the faces of the driven pulley. Clean away any grease from the faces where the belt rides.



Remove the seals from the left face of the driven pulley.



Drive in the new seals with a suitable driver with the same outside diameter as the seal.



Remove the O-rings on the left face.

Clean the left face and roller pins with a high flash point solvent and compressed air.

NOTE: Always wear safety glasses when using compressed air and never point it directly at yourself or anyone else.

Bearing Replacement



Inspect the bearings in the right face of the driven pulley.



Remove the needle bearing with a suitable puller.



Remove the collar, snap ring, and bearing from the right face of the driven pulley.

Clean the right face with a high flash point solvent and compressed air.

NOTE: Always wear safety glasses when using compressed air and never point it directly at yourself or anyone else.



Drive in the new bearing so the sealed side face out towards the clutch. Install the snap ring into the groove. Install the collar and drive in the new needle bearing so that its markings face out. Drive in the bearings with a suitable driver with the same outside diameter as the bearing.



Lubricate the bearings in the right face of the driven pulley with grease.

CVT Installation

SAFETY FIRST: Protective gloves and eyewear are recommended at this point.

Driven Pulley



Lubricate the bearings in the right face of the driven pulley with grease.



Drive in the new seals with a suitable driver with the same outside diameter as the seal.



Install the O-rings to the left face of the driven pulley. Coat the O-rings seals, and inside of the left face where it rides on the right face with grease.



Fit the left face onto the right face. Wipe away any grease that gets on the faces where the belt will ride.



Lubricate the guide pins and rollers with grease. Place the rollers on the pins and insert the pins into driven pulley as shown.

Clutch



Apply a light coat of grease to the brake shoe pivot pins on the drive plate. Install the three rubber bumpers. Take care to keep the grease away from the clutch shoe linings.



Connect the clutch shoes with the springs as shown. Slide the clutch shoes onto the drive plate pivots.



Fit the plate onto the clutch shoe pivots.





Install the three clutch shoe pivot circlips.



Install the seal collar and spring.



Install the spring collar into the spring and set the centrifugal clutch on top of the spring collar.



Set the clutch fitting tool to onto the clutch.

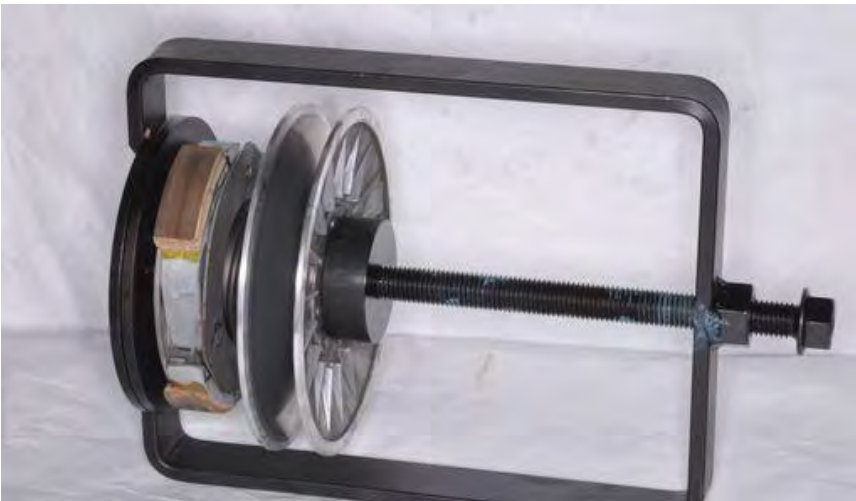

Use the clutch spring compressor tool to compress the spring in the driven pulley assembly.



Thread on the clutch drive plate nut.



Tighten the clutch drive plate nut to specification with the special socket that comes with the fitting tool.

Item	Qty	Torque	
		kgf-m	lb-ft
Clutch drive plate nut	1	7.5	55.32

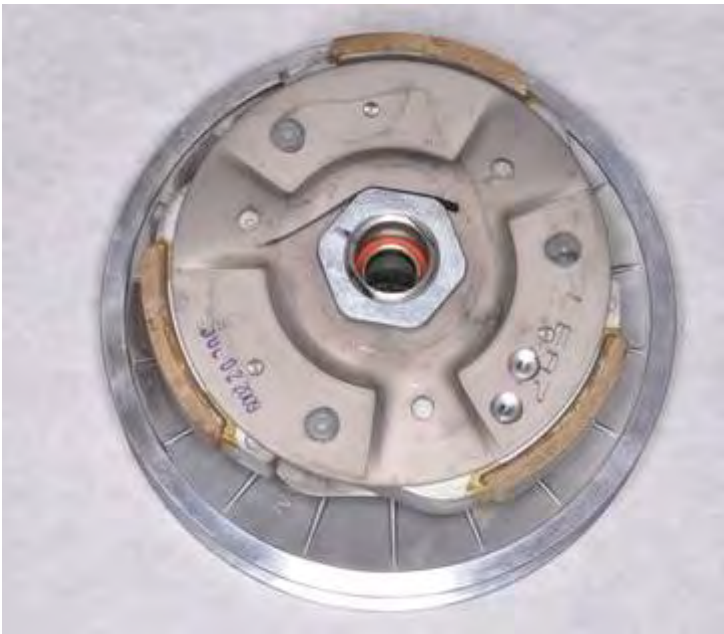

Wipe away any excess grease. Do not allow grease to contact the clutch shoe linings or the driven faces where the belt will ride.



Place the clutch outer over the centrifugal clutch assembly.

Drive Pulley



Install the rollers into the back of the movable drive face of the driven pulley. Position the rollers so that their colored sides are clockwise.



Insert the four rubber damper pieces into the ramp.



Fit the ramp into the back of the movable drive face of the drive pulley. Make sure the rubber dampers fit onto the ridges as shown.

Pulleys and Belt



Slide the drive pulley washer onto the crankshaft.



Insert the bushing into movable drive face of the drive pulley. Slide the movable face of the drive pulley onto the crankshaft.

Make sure the drive face are clean and grease free where they will contact the belt.



Fit the Belt in between the faces of the driven pulley. Spread the faces by hand if needed in get the belt to fit.



Slide the driven pulley and clutch assembly onto the final drive shaft. Position the front end of the belt around the crankshaft.



Install the driven pulley bushing and nut.



Torque the driven pulley nut to specification with a 19 mm socket.

Item	Qty	Thread size (mm)	Torque	
			kgf-m	lb-ft
Clutch outer nut (driven pulley)	1	12	5.0-6.0	36.17-43.40



Slide the left face of the drive pulley onto the crankshaft.



Lubricate the threads of the drive pulley nut with engine oil. Install the drive pulley washer and nut.



Hold the drive pulley with a universal holder tool and torque the nut to specification with a 19 mm socket.

Item	Qty	Thread size (mm)	Torque	
			kgf-m	lb-ft
Drive face nut	1	14	9.0-10.0	65.10-72.33

Install the belt case. See the [Belt Case](#) topic for more information.

8.Final Drive

This chapter covers the location and servicing of the final drive components for the KYMCO Downtown 350i model.

Final Drive Oil8-3

Final Reduction8-8

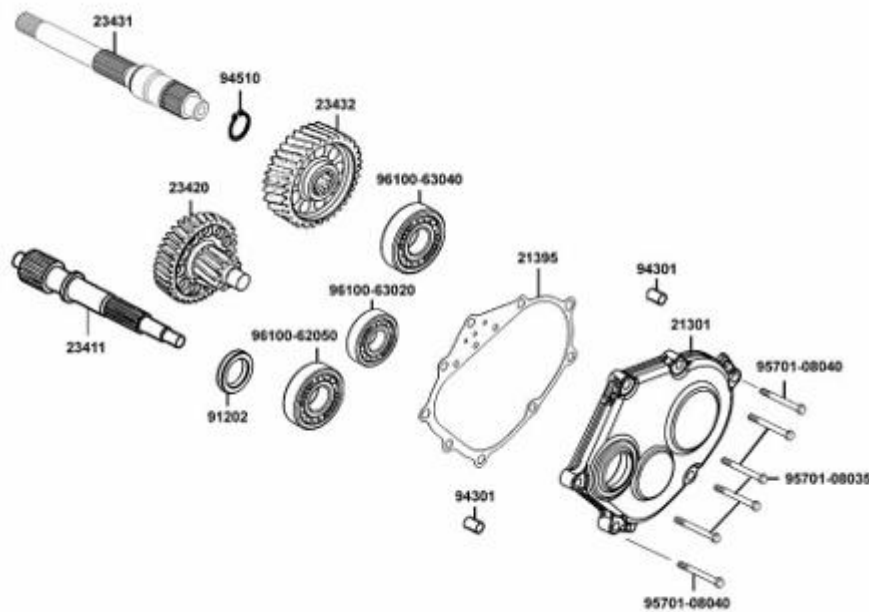

Downtown 350i parts diagram.

GENERAL INSTRUCTIONS

- The servicing operations of this section can be made with the engine installed.
- When replacing the drive shaft, use a special tool to hold the bearing inner race for this operation.

TROUBLESHOOTING

Engine starts but motorcycle won't move

- Damaged transmission
- Seized or burnt transmission

Abnormal noise

- Worn, seized or chipped gears
- Worn bearing

Oil leaks

- Oil level too high
- Worn or damaged oil seal

Final Drive Oil

SAFETY FIRST: Protective gloves and eyewear are recommended at this point.

Place the scooter on level ground and up on its center stand.

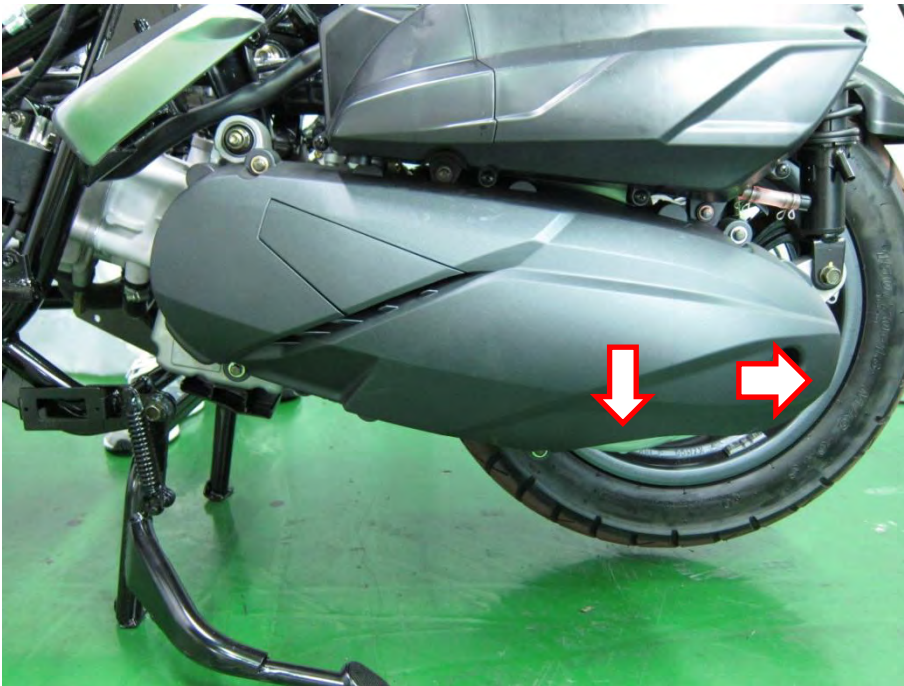

The oil drain bolt and oil filler bolt are located on the transmission.

Gear oil type:	SAE 90
Gear oil capacity:	
At disassembly	0.23 Liter
At change	0.21 Liter

Draining

Place the vehicle on its center stand on level ground. Place a suitable oil drain pan under the transmission oil drain plug.



Remove the transmission oil level filler bolt with a 12 mm socket.



Place a suitable container under the drain plug to capture the final drive oil. Loosen the oil drain plug with a 12 mm socket. Remove the drain plug and slowly rotate the rear wheel to drain the transmission oil.

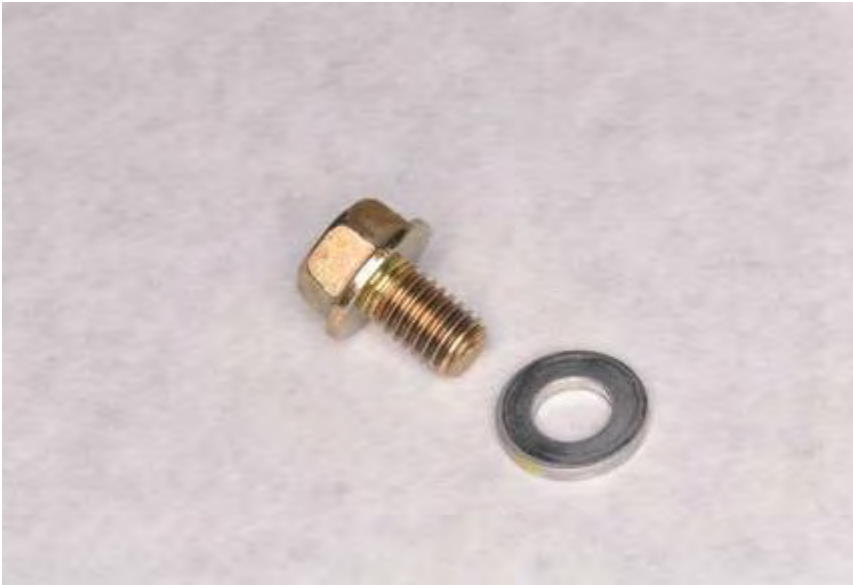

Inspect the drain plug and washer.



Install the oil drain plug and washer with a 12 mm socket. Tighten to specification.

Item	Qty	Thread size (mm)	Torque	
			kgf-m	lb-ft
Final drive oil drain bolt	1	8	0.8 - 1.2	5.79 - 8.68

Filling



Fill the final drive with the specified quantity of oil with a syringe.

Gear oil type:	SAE 90
Gear oil capacity:	
At disassembly	0.23 Liter
At change	0.21 Liter



Thread in the final drive oil level filler bolt.



Install the oil filler plug and torque it to specification with a 12 mm socket.

Item	Qty	Thread size (mm)	Torque	
			kgf-m	lb-ft
Final drive oil filler bolt	1	8	0.8 - 1.2	5.79 - 8.68

Final Reduction

SAFETY FIRST: Protective gloves and eyewear are recommended at this point.

Disassembly

Note: Do not remove the transmission case cover except for necessary part replacement. If the drive shaft is replaced, make sure to also replace the bearing and oil seal.

Remove the belt case. See the [Belt Case](#) topic for more information.

Remove the CVT belt and pulleys. See the [CVT Removal](#) topic for more information.

Drain the final drive oil. See the [Final Drive Oil](#) topic for more information.

Remove the rear wheel. See the [Rear Wheel](#) topic for more information.



There are 9 transmission case cover bolts.



Remove the 9 transmission case cover bolts using a 12 mm socket.



Utilize the reinforced pry points and remove the case cover.



Use a press to remove the drive shaft. Thread a nut onto the drive shaft to protect the threads. If the drive shaft is to be replaced also replace the seal.



Remove the two dowel pins and the gasket.



Remove the final shaft gear.



Remove the countershaft.



Remove the final shaft.

Inspection



Inspect the countershaft gear for wear or damage.



Inspect the final gear and final shaft for wear, damage or seizure. If the final shaft snap ring is removed replace it with a new item.



Check the left crankcase bearings for excessive play. Inspect the oil seal for wear or damage.

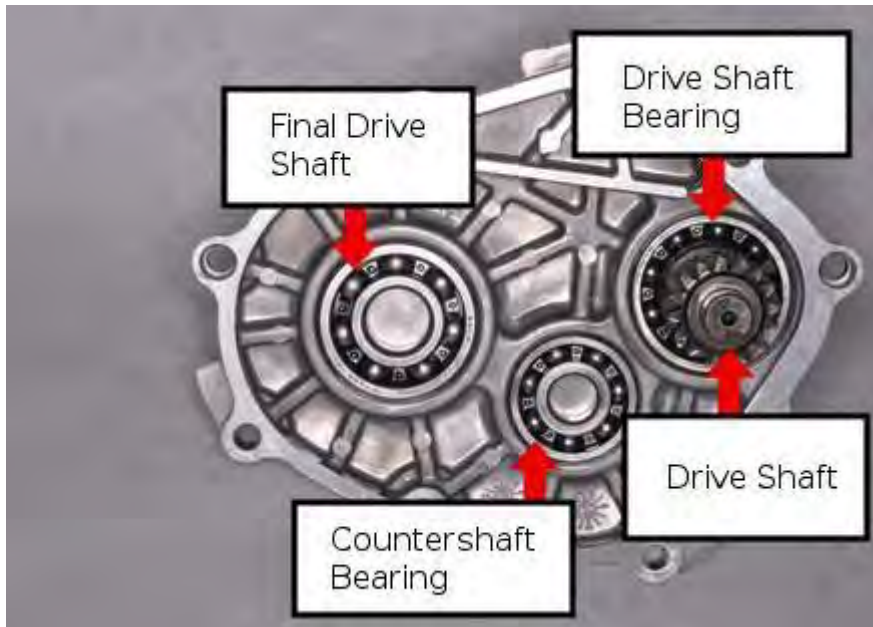

Check the transmission case cover bearings for excessive play. Inspect the drive shaft, drive shaft bearing and oil seal for wear or damage.



Use a bearing puller to remove the crankcase or transmission case covers.



Use a seal pick to remove the oil seals.



Use a bearing driver to install any new bearings into the crankcase and transmission case cover. The driver should have the same outside diameter as the bearings. The bearings should go in square and have their markings facing out. Drive in a new seals in the same manner if needed.

Installation

Lubricate the final drive bearings with fresh final drive oil. Coat the lips of the seals in fresh final drive oil.



Press the drive shaft back into the transmission case cover as shown.



Insert the final shaft through the oil seal and bearing.



Install the countershaft into its bearing as shown.



Install the final gear onto the final shaft as shown.



Install the dowel pins. Install a new gasket onto the transmission case.

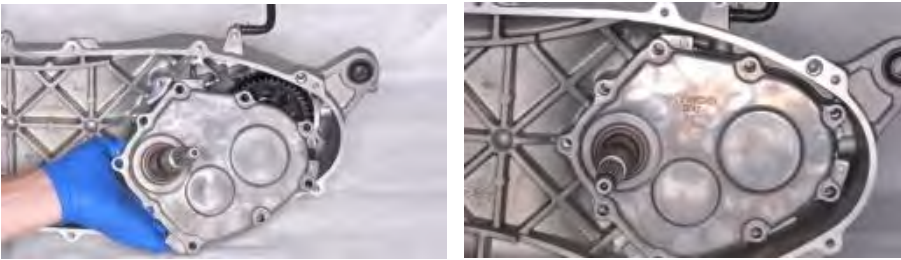

Install the transmission case cover onto the transmission. Fit the drive into its bearing in the case and make sure it gear engages correctly with the countershaft gear.

Turn the drive shaft and make sure the final shaft turns.



Insert the 9 transmission case cover bolts. Tighten the bolts to specification using a 12 mm socket.

Item	Qty	Thread size (mm)	Torque	
			kgf-m	lb-ft
Transmission case bolts	9	8	0.8-1.2	1.7-2.6

Install the rear wheel. See the [Rear Wheel](#) topic for more information.

Fill the final drive oil. See the [Final Drive Oil](#) topic for more information.

Install the CVT belt and pulleys. See the [CVT Installation](#) topic for more information.

Install the belt case. See the [Belt Case](#) topic for more information.

9.Electrical Systems

This chapter covers the location and servicing of the electrical systems for the KYMCO Downtown 350i model.

<u>Electrical Specifications</u>	9-8
<u>Fuses</u>	9-10
<u>ECU Removal</u>	9-11
<u>Ignition System</u>	9-15
<u>Charging System</u>	9-22
<u>Battery</u>	9-24
<u>Relays</u>	9-28
<u>Starting System</u>	9-30
<u>Starter Motor</u>	9-34
<u>Switches</u>	9-36
<u>Lights</u>	9-48
<u>Horn</u>	9-56

[Charging System](#) AND [Battery](#)

GENERAL INSTRUCTIONS

- The battery can be charged and discharged repeatedly. If a discharged battery is not used for a long time, its service life will be shortened. Generally, the capacity of a battery will decrease after it is used for 2~3 years. A capacity-decreased battery will resume its voltage after it is recharged but its voltage decreases suddenly and then increases when a load is added.
- When a battery is overcharged, some symptoms can be found. If there is a short circuit inside the battery, no voltage is produced on the battery terminals. If the rectifier won't operate, the voltage will become too high and shorten the battery service life.

- If a battery is not used for a long time, it will discharge by itself and should be recharged every 3 months.
- A new battery filled with electrolyte will generate voltage within a certain time and it should be recharged when the capacity is insufficient. Recharging a new battery will prolong its service life.
- Inspect the charging system according to the sequence specified in the Troubleshooting.
- Do not disconnect and soon reconnect the power of any electrical equipment because the electronic parts in the regulator/rectifier will be damaged. Turn off the ignition switch before operation.
- It is not necessary to check the MF battery electrolyte or fill with distilled water.
- Check the load of the whole charging system.
- Do not quick charge the battery. Quick charging should only be done in an emergency.
- Remove the battery from the motorcycle for charging.
- When replacing the battery, do not use a traditional battery.
- When charging, check the voltage with an electric tester.

TROUBLESHOOTING

No power

- Dead battery
- Disconnected battery cable
- Fuse burned out
- Faulty ignition switch

Intermittent power

- Loose battery cable connection
- Loose charging system connection
- Loose connection or short circuit in the ignition system

Low power

- Weak battery
- Loose battery connection
- Charging system failure
- Faulty regulator/rectifier

Charging system failure

- Loose, broken or shorted wire or connector
- Faulty regulator/rectifier
- Faulty A.C. generator

Ignition System

GENERAL INSTRUCTIONS

- Some electrical components may be damaged if terminals or connectors are connected or disconnected while the ignition switch is “ON” and current is present.
- When servicing the ignition system, always follow the steps in the troubleshooting on page above.
- The ignition timing cannot be adjusted since the ignition control module is already adjusted in factory.
- The ignition control module or ECU maybe damaged if dropped or the connector is disconnected when the key is "ON", the excessive voltage may damage the ignition control module or ECU. Always turn off the ignition switch before servicing.
- A faulty ignition system is often related to poor connections. Check those connections before proceeding.
- Make sure the battery is adequately charged. Using the starter motor with weak battery results in a slower engine cranking speed as well as no spark at the spark plug.
- Use a spark plug of the correct heat range. Using spark plug with an incorrect heat range can damage the engine.

TROUBLESHOOTING

No peak voltage

- Short circuit in engine stop switch or ignition switch wire.
- Faulty engine stop switch or ignition switch.
- Loose or poorly connected ignition control module connectors.
- Open circuit or poor connection in ground wire of the ignition control module.
- Faulty crank position sensor.
- Faulty ignition control module.

Peak voltage is normal, but no spark jumps at the plug

- Faulty spark plug or leaking ignition coil secondary current.
- Faulty ignition coil.

Starting System

GENERAL INSTRUCTIONS

- The removal of starter motor can be accomplished with the engine installed.
- After the starter clutch is installed, be sure to add the engine oil and coolant and then bleed air from the cooling system.

TROUBLESHOOTING

Starter motor will not turn

- Fuse burned out
- Weak battery
- Faulty ignition switch
- Faulty starter clutch or gear
- Faulty front or rear stop switch
- Faulty starter relay
- Poorly connected, broken or shorted wire
- Faulty starter motor

Lack of power

- Weak battery
- Loosed wire or connection
- Foreign matter stuck in starter motor

Starter motor rotates but engine does not start

- Faulty starter pinion
- Starter motor rotates in reverse
- Weak battery

[Lights](#), [Switches](#), AND [Fuel Pump](#)

GENERAL INSTRUCTIONS

- Note the following when replacing the halogen headlight bulb
 1. Wear clean gloves while replacing the bulb. Do not put finger prints on the headlight bulb, as they may create hot spots on the bulb and cause it to fail.
 2. If you touch the bulb with your bare hands, clean it with a cloth moistened with alcohol to prevent its early failure.
 3. Be sure to install the dust cover after replacing the bulb.

- Check the battery condition before performing any inspection that requires proper battery voltage.
- A continuity test can be made with the switches installed on the scooter.
- Route the wires and cables properly after servicing each component.

TROUBLESHOOTING

Lights do not come on when ignition switch is “ON”

- Burned bulb
- Faulty switch
- Poorly connected, broken or shorted wire

Temperature gauge does not register correctly

- Faulty temperature gauge
- Faulty thermosensor
- Broken or shorted wire between the temperature gauge and thermosensor

Fuel gauge does not work or shows wrong figures

- Faulty fuel gauge
- Faulty fuel unit
- Poorly connected wire between fuel gauge and fuel unit
- Fuse burned out

Electrical

Item		Standard	
Battery	Capacity	12V 10AH	
	Voltage (20°C)	Fully charged	13.2V
		Insufficient charged	< 12.3V
	Charging current	1.2A* 5 - 10H	

Item		Standard
Spark plug	Standard type	NGKCR7E
Spark plug gap		0.6 - 0.7 mm
Inductive Ignition Coil	Primary coil	3.57 - 4.83 Ω
	Secondary coil without plug cap	10.42 - 14.49 K Ω
Throttle Position Sensor		3500 - 6500 Ω
Fuel Pump		1.9 Ω approx.
Fuel Injector		11.7 \pm 0.6 Ω
Water Temperature Sensor		2.076 K Ω \pm 10% (25°C)
Oxygen Sensor (engine warming condition)		6.7 Ω - 9.5 Ω
Crank Position Sensor		115 Ω \pm 15 Ω
Tilt Switch		0.4V - 1.4V(normal) 3.7V - 4.4V (fall down)

Water temperature sensor resistance	At -20°C/-4°F	18.8 KΩ
	At 40°C/104°F	1.136 KΩ
	At 100°C/212°F	0.1553 KΩ

Item	Standard	Service Limit
Starter motor brush length	12.5 mm	8.5 mm
Fuse	10A,15A,30A,40A(ABS Model)	
Headlight bulb	12V 55W/55W *2	
Front position LED	12V LED *2	
Turn signal light bulb	12V 21 W(Front) / 10W(Rear)	
License light	12V5W	
Stoplight/taillight	12V LED	

Fuses

SAFETY FIRST: Protective gloves and eyewear are recommended at this point.

Fuse Box

Remove the seat and the luggage box. See the [Seat](#) topic for more information.



The fuse box is located on top of the battery.



Open the covers to access the fuses.

ECU Removal

SAFETY FIRST: Protective gloves and eyewear are recommended at this point.

Remove the front cover. See the [Front Cover](#) topic for more information.

Note: The ignition control module or ECU maybe damaged if dropped or the connector is disconnected when the key is "ON". The excessive voltage may damage the ignition control module or ECU. Always turn off the ignition switch before servicing.

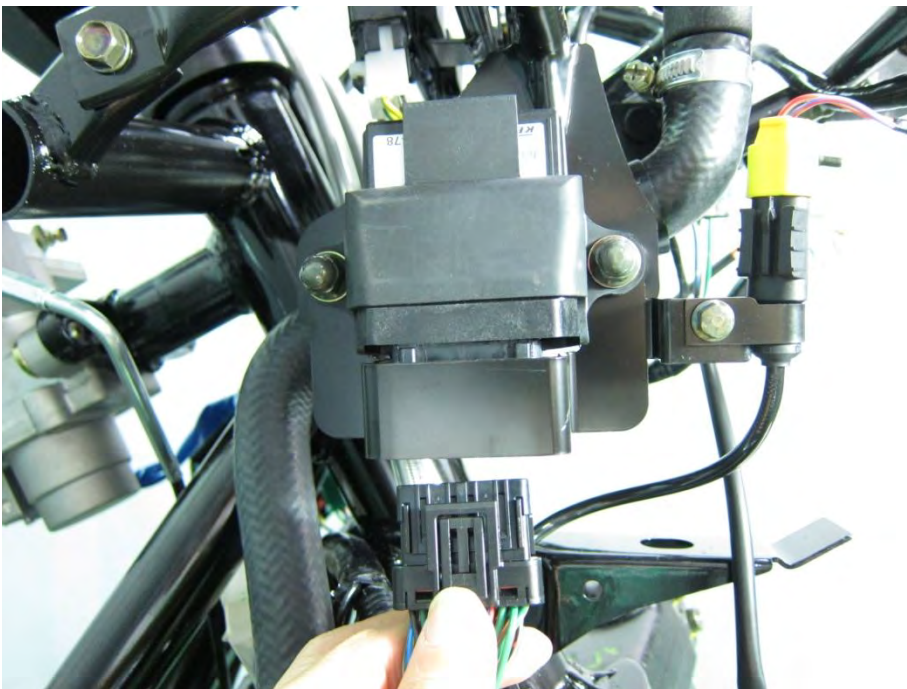

Disconnect the ECU harness.

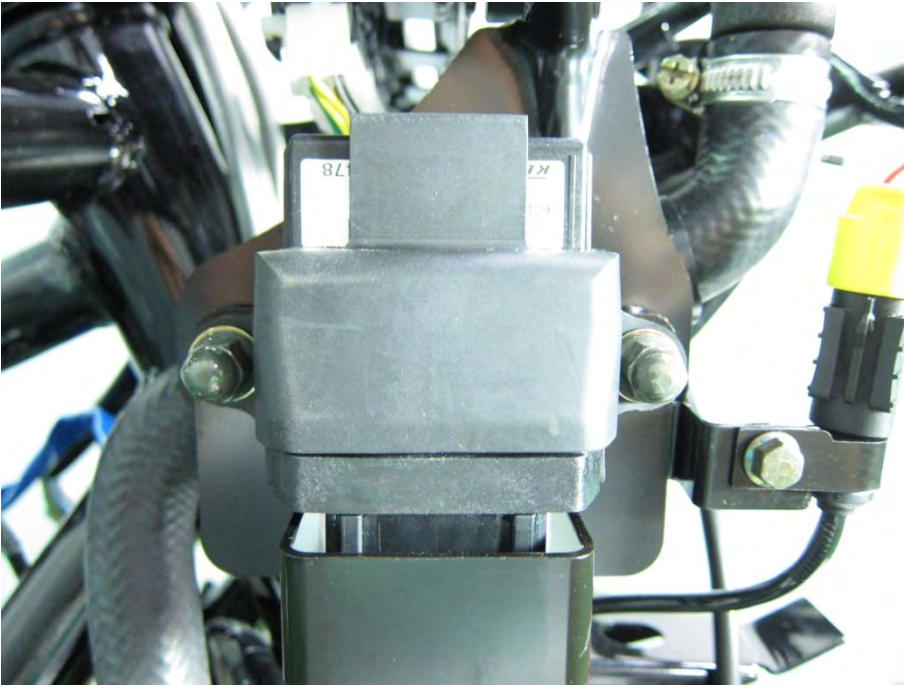

Remove the two mounting nuts with a socket.

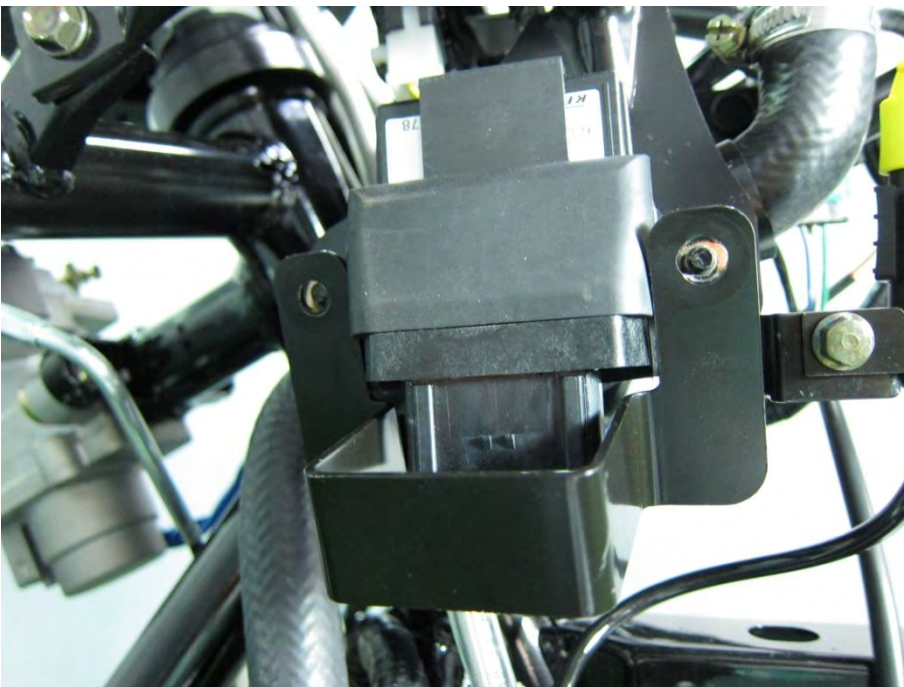

Remove the bracket and remove the ECU.

Inspection

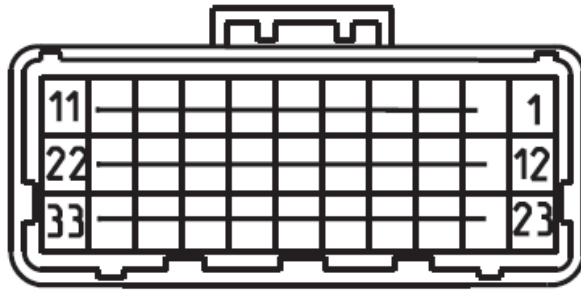

Check for continuity between pin 9 and 10 of the ECU side connector.

There should be continuity at all times.

Check for continuity between each pins 2, 4 and 23 of the ECU side connector.

There should be continuity at all times.

Check for continuity between pin 24 and 10 of the ECU side connector.

PIN NO.	NAME	FUNCTION	PIN NO.	NAME	FUNCTION
01	IGP	IGNITION POWER	19	FLPR	FUEL PUMP RELAY
02	LGI	LOGIC GROUND 1	20	ISCBP	IDEL SPEED CONTROL B
03	HEGO	HEGO SENSOR	21	ISCAP	IDEL SPEED CONTROL A
04	SG	SENSOR GROUND	22	HEGO HT	HEGO SENSOR HTATER
05	TH	THROTTLE POSITION SENSOR	23	CRK-M	CRANK PULSE SENSOR GND
06	VCC	SENSOR POWER OUTPUT(+5V)	24	TW	WATER TEMP. SENSOR
07	BATT	BATTERY	25	-	-
08	FAN	FAN RELAY	26	ROLL	ROLL SENSOR
09	PG1	POWER GROUND 1	27	PM	MANIFOLD PRESSURE SENSOR
10	PG2	POWER GROUND 2	28	SOL	-
11	IG	IGNITION COIL	29	-	-
12	CRK-P	CRANK PULSE SENSOR	30	K-LINE	DIAGNOSTIC TOOL
13	-	-	31	ISCBN	IDEL SPEED CONTROL / B
14	-	-	32	ISCAN	IDLE SPEED CONTROL / A
15	TEST	-	33	NE	METER
16	INJ	INJECTION			
17	-	-			
18	MIL	MULTI INDICATOR LAMP			

Ignition System

SAFETY FIRST: Protective gloves and eyewear are recommended at this point.

The ignition timing is set at the factory and is not adjustable. Perform the following checks. Before performing any tests make sure the electrical connections are not loose or corroded.

Spark Plug Inspection

Check the spark plug to see if it is the correct type and gapped properly. If the spark plug is black and fouled, replace it. See the [Spark Plug](#) topic for more information.



If the spark plug center electrode or side electrode are corroded or damaged, or if the insulator is cracked, replace the plug.

Measure the gap with a wire-type thickness gauge. If the gap is incorrect, replace the spark plug.

Ignition Coil

Removal

Remove the two ignition coil leads.

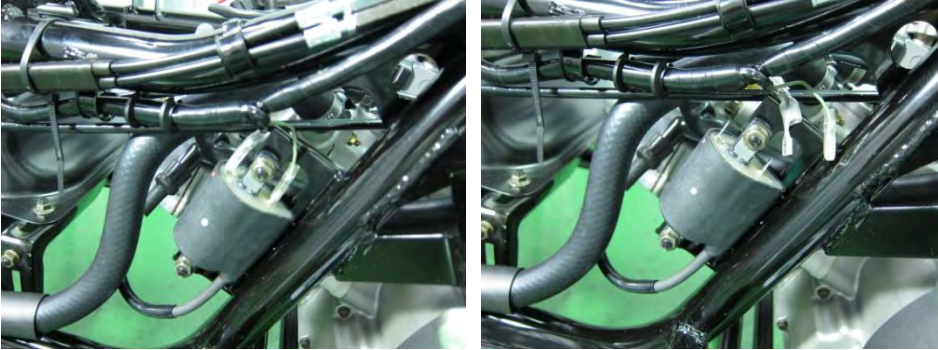

Remove the two ignition coil mounting bolts with an 8 mm socket.
Remove the ignition coil.

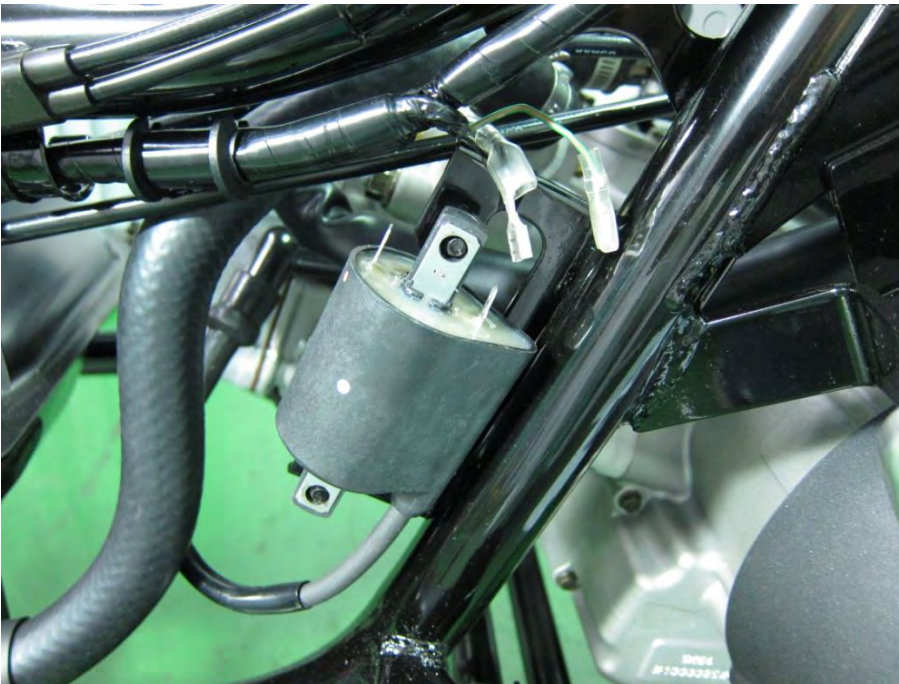

Ignition Coil Resistance

Primary

Set the multimeter to read ohms of resistance (Ω).



Touch the positive and negative meter leads to the ignition coil terminals as shown. Measure the resistance.

Ignition Coil Primary Resistance	3.57 - 4.83 Ω
----------------------------------	----------------------

Secondary With Plug Cap



Check the secondary resistance between the ignition coil terminal and the spark plug cap. Touch the negative meter lead to the terminal and the positive meter lead to the spark plug cap as shown.

Secondary Resistance With Plug Cap	15 - 19 k Ω
------------------------------------	--------------------

Secondary Without Plug Cap



Check the secondary resistance between the ignition coil terminal and the spark plug wire without the cap. Touch the negative meter lead to the terminal and the positive meter lead to the spark plug wire as shown.

Secondary Resistance Without Plug Cap	10.42 - 14.49 k Ω
---------------------------------------	--------------------------

AC Generator Inspection

Crank Position Sensor Inspection

Note: This test is performed with the stator installed in the engine.

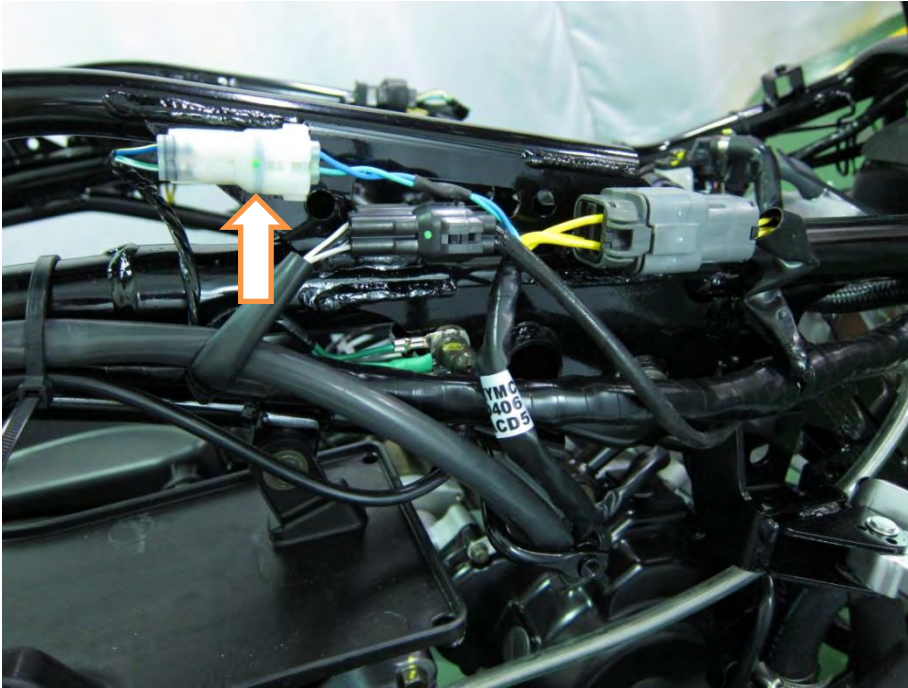

Disconnect the crank position sensor wire coupler. Measure the resistance between the and green/white and blue/yellow wire terminals.

Resistance	
Blue/White - Green/White	115 Ω \pm 15 Ω

To replace the crank position sensor see the [A.C. Generator and Starter clutch](#) topic.

Charging System

SAFETY FIRST: Protective gloves and eyewear are recommended at this point.

You will need a digital multimeter to inspect the charging system.

To replace the stator/charging coil see the [A.C. Generator and Starter clutch](#) topic.

Charging Voltage Inspection

Remove the battery cover. See the [Battery](#) topic for more information.

Note: The battery should be fully charged prior to making charging system checks.

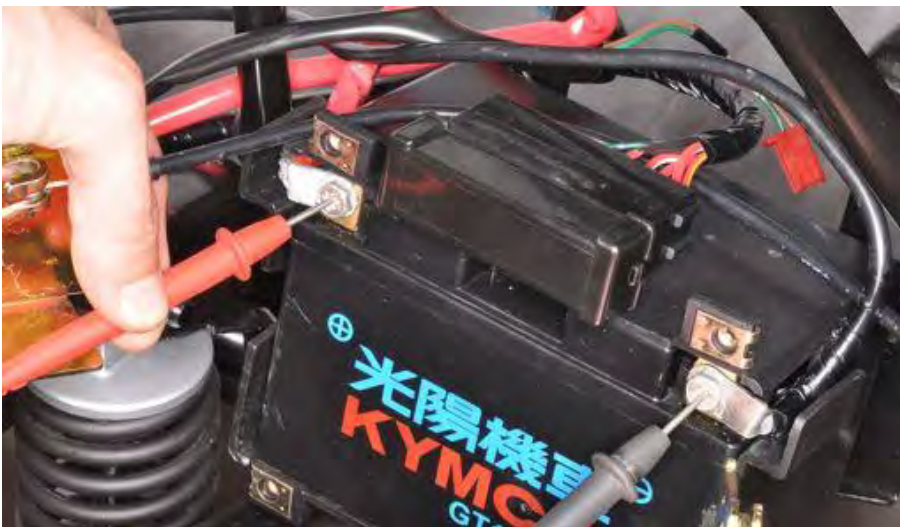

Start the engine and warm it up to the operating temperature; stop the engine. Connect the multimeter between the positive (+) and negative (-) terminals of the battery. To prevent short, make absolutely certain which are the positive (+) and negative (-) terminals or cable.

With the headlight on and turned to the high beam position, restart the engine. Measure the voltage on the multimeter when the engine runs at 5000 rpm.

Battery charging voltage@ 5000 rpm	14 ~ 15V
------------------------------------	----------

Regulator/Rectifier

Remove the seat. See the [Seat](#) topic for more information.

Remove the luggage box. See the [Luggage Box](#) topic for more information.



The regulator/rectifier is located on the left side of the vehicle.

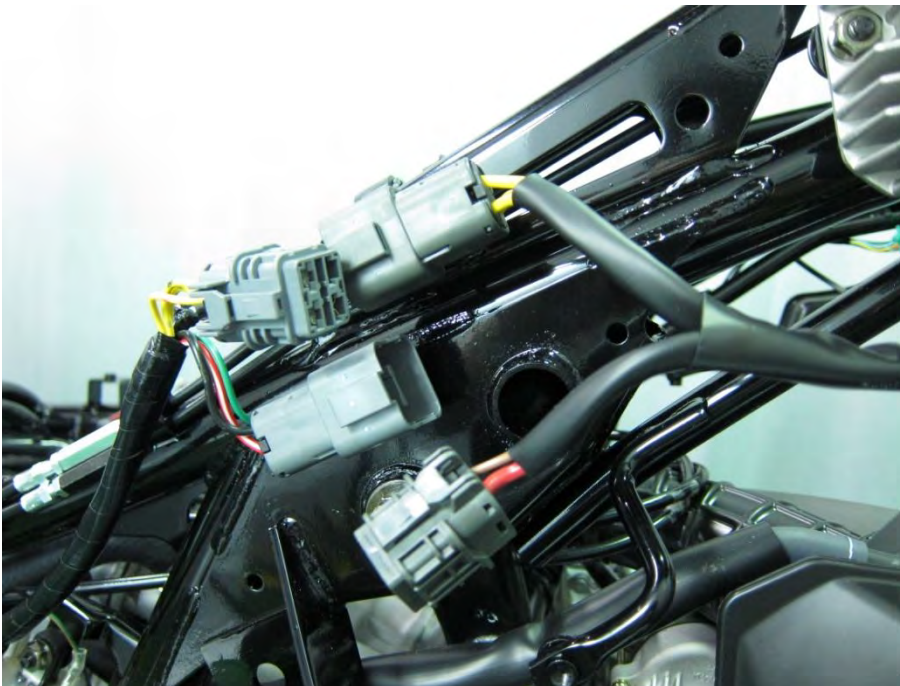

Disconnect the regulator/rectifier connector. Check the connectors for loose contacts or corroded terminals.

Battery Wire

Measure the voltage between the Red/White wire terminal and ground. There should be battery voltage at all times.

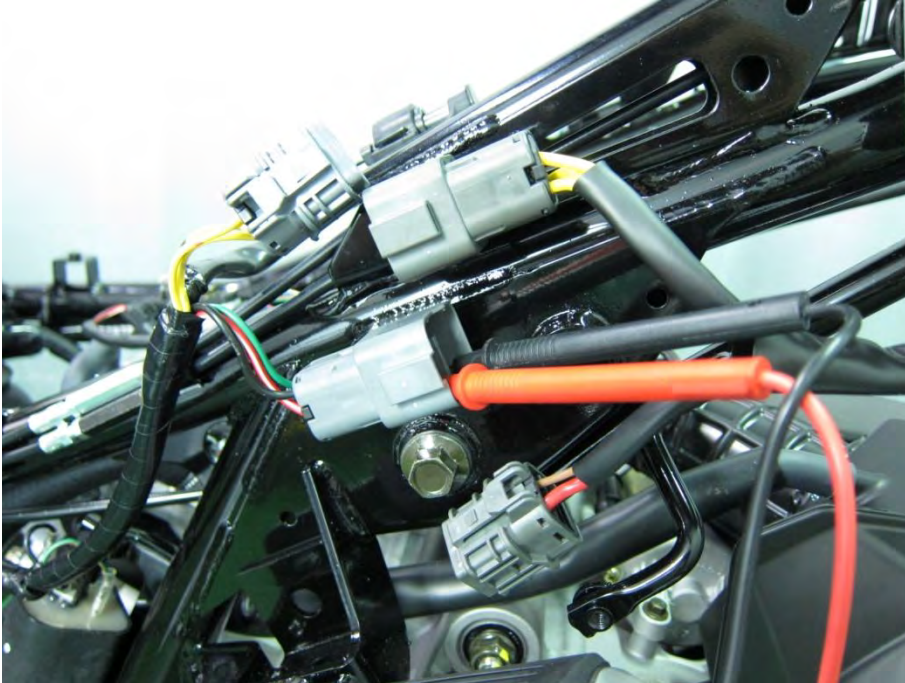

Ground Wire

Check the continuity between the Green wire terminal and ground. There should be continuity at all times.

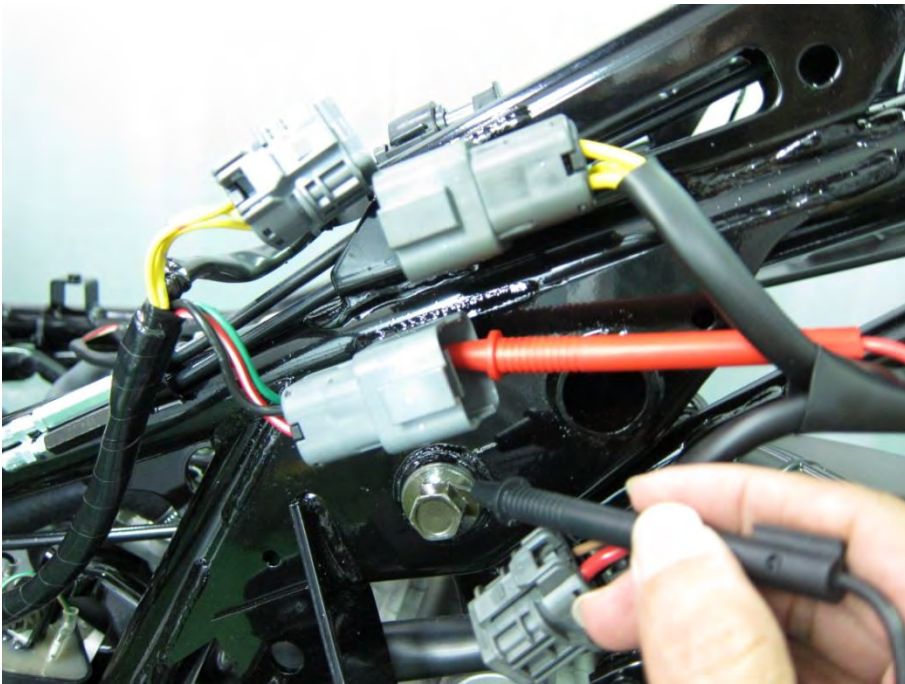

Charging Coil Wire

Disconnect the generator 3-pin connector. Check the connectors for loose contacts or corroded terminals.



Measure the resistance between each Yellow wire terminals.

Check for continuity between each yellow wire terminal regulator/rectifier side and ground. There should be no continuity.

Removal

Disconnect the two regulator/rectifier connectors.

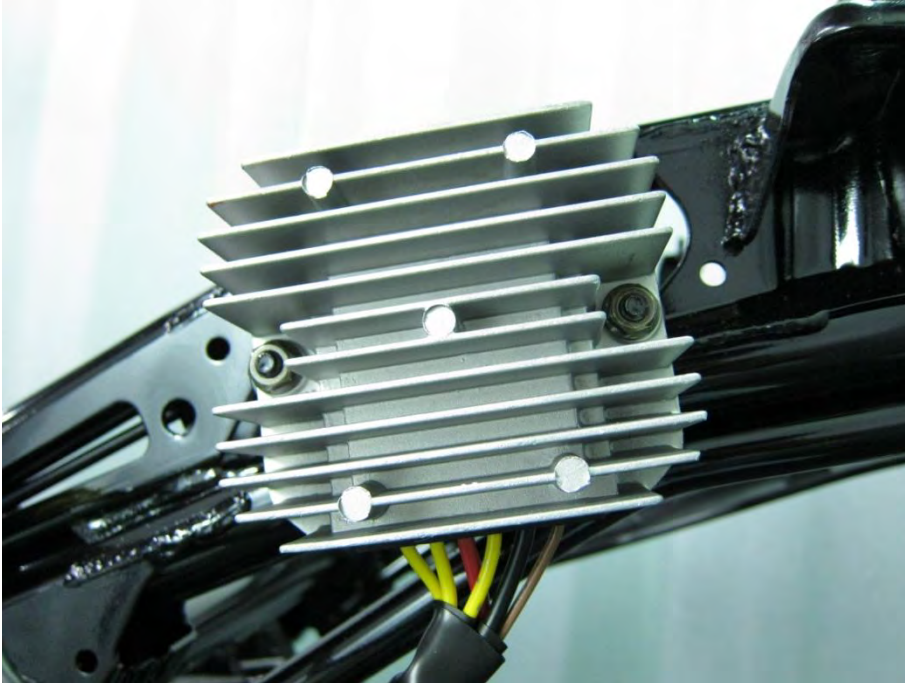

Remove the two mounting nuts with a 10 mm socket.



Remove the regulator/rectifier.

Battery

SAFETY FIRST: Protective gloves and eyewear are recommended at this point.

Warning: The battery electrolyte (sulfuric acid) is poisonous and may seriously damage the skin and eyes. Avoid contact with skin, eyes, or clothing. In case of contact, flush with water and get prompt medical attention.

Removal

Remove the seat. See the [Seat](#) topic for more information.

Remove the luggage box. See the [Luggage Box](#) topic for more information.

Screws

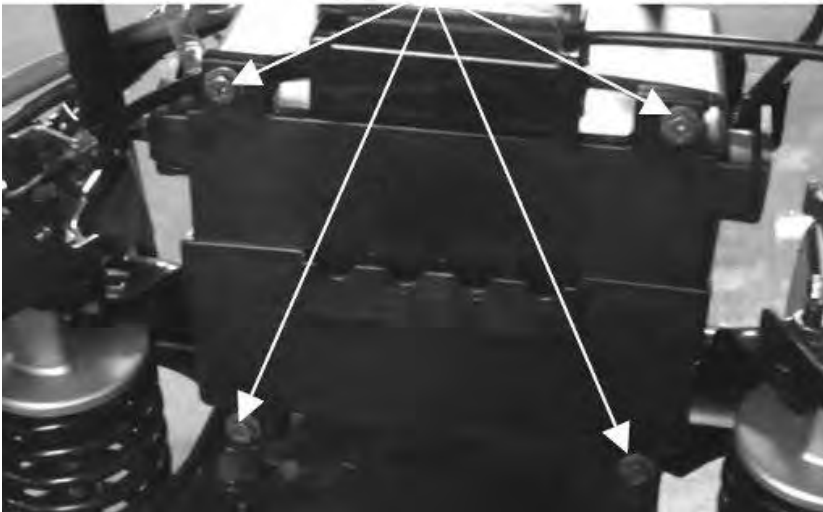

Remove the four battery cover screws. Remove the battery cover.



The battery is located in the back of the vehicle.

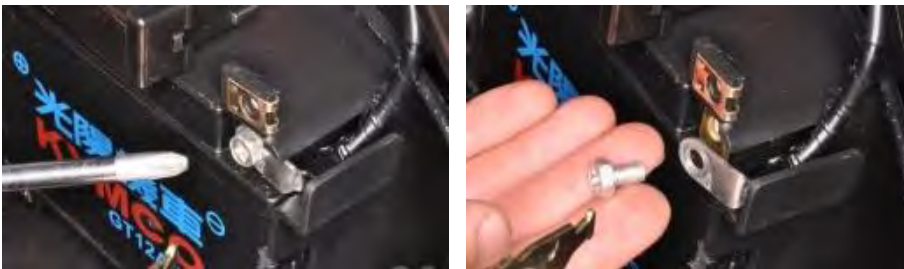

Remove the negative battery cable bolt with a 10 mm socket or #3 Phillips screwdriver. Free the negative cable from the battery.



Remove the positive battery cable bolt with a 10 mm socket or #3 Phillips screwdriver. Free the positive cable from the battery.



Lift the battery out of the battery tray.

Testing



Check the battery voltage with a multi-meter. Place the positive probe onto the positive battery terminal and the negative probe to the negative battery terminal. If the battery reads under 12.3 V it is undercharged.

Battery Voltage (20°C/68°F)	
Fully Charged	13.0 - 13.2 V

Battery Charging

Charge the battery with a motorcycle specific battery charger at the specified rate. Connect the charger leads to their appropriate battery terminals. Keep open flames away from a charging battery.

Standard Charge	
1.2 Amps	5 - 10 Hours

Note: For battery charging, do not exceed the charging current and time specified on the battery. Using excessive current or extending the charging time may damage the battery.

Install the luggage box. See the [Luggage Box](#) topic for more information.

Install the seat. See the [Seat](#) topic for more information.

Relays

SAFETY FIRST: Protective gloves and eyewear are recommended at this point.

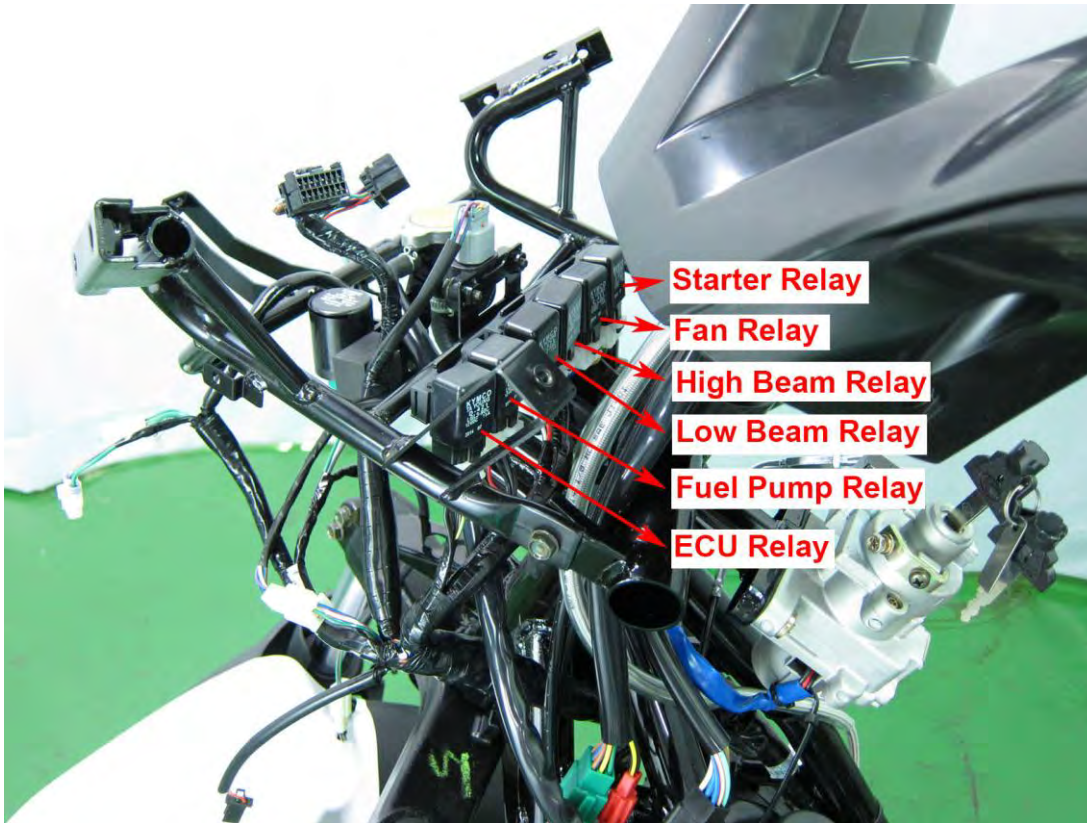

Inspection

Use a digital multimeter to inspect the fuel cut-off relay (Fuel Pump Relay).
Set the multimeter to read ohms of resistance.

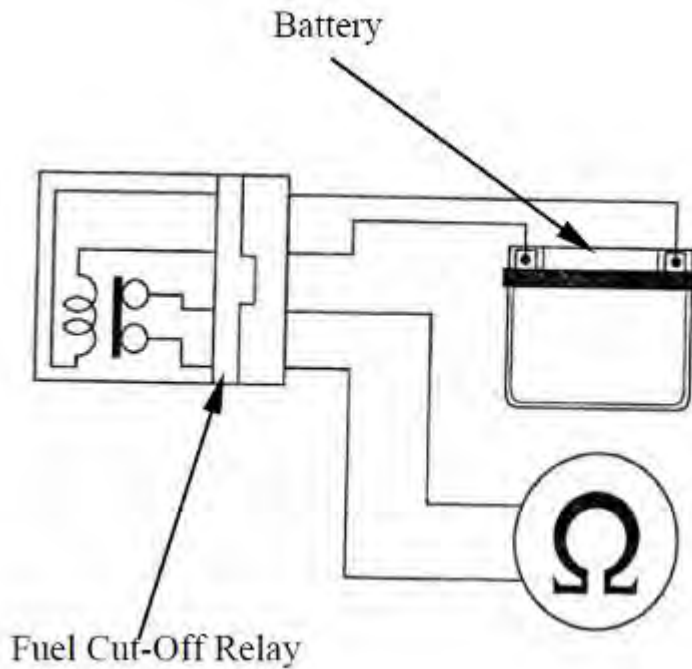

Connect the multimeter to the fuel cut-off relay connector terminals.
Connection: Black - Red/Black

Connect 12 V battery with the fuel cut-off relay connector.
Connection: Blue/Black - Black

There should be continuity only when 12 V battery connected.
If there is not continuity when the 12 V battery is connected, replace the fuel cut-off relay.

Starting System

SAFETY FIRST: Protective gloves and eyewear are recommended at this point.

You will need a digital multimeter to inspect the starting system.

Starter Relay

Inspection

Remove the body cover. See the [Body Cover](#) topic for more information.



The starter relay is located on the right side of the vehicle.

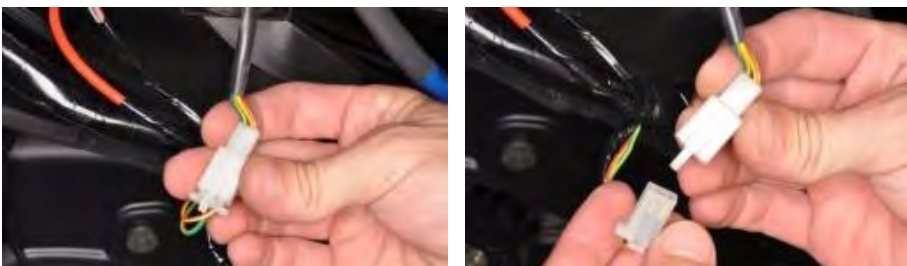

Disconnect the starter relay wire connector.



Check for continuity between the yellow/red wire and green/yellow wire. There should be continuity when the starter button is depressed. If there is no continuity, check the starter button for continuity and inspect the wire.

Operation Test

Remove the battery cover. See the [Battery](#) topic for more information. Turn the ignition switch to "OFF".



Remove the negative battery cable bolt with a 10 mm socket or #3 Phillips screwdriver. Free the negative cable from the battery.

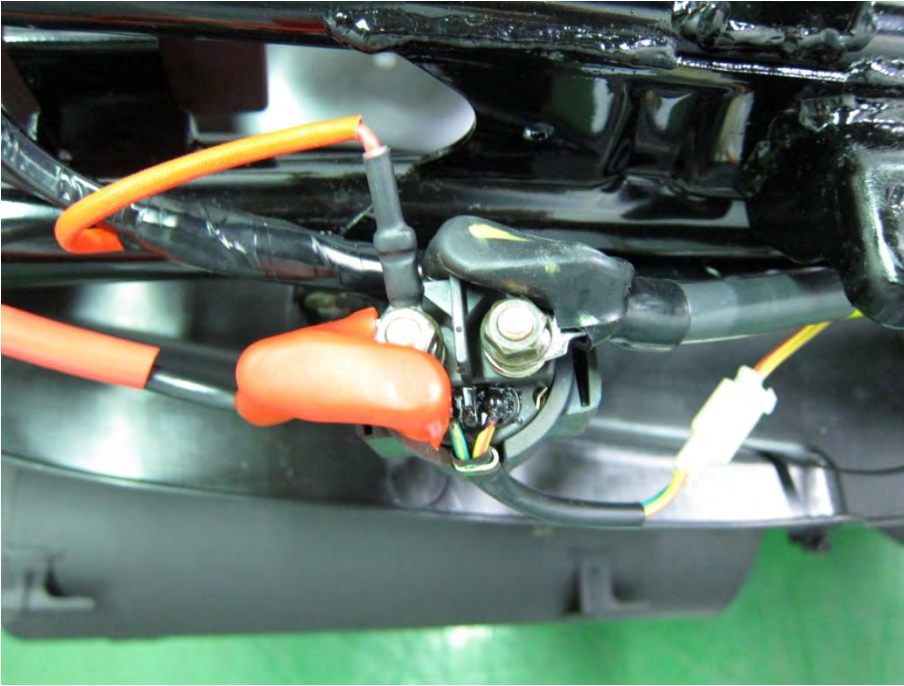

Remove the two terminal covers.



Remove the nuts that hold the starter motor lead and battery lead wires to the starter relay with a 10 mm socket.



Disconnect the starter relay wire connector.
And remove the starter relay.

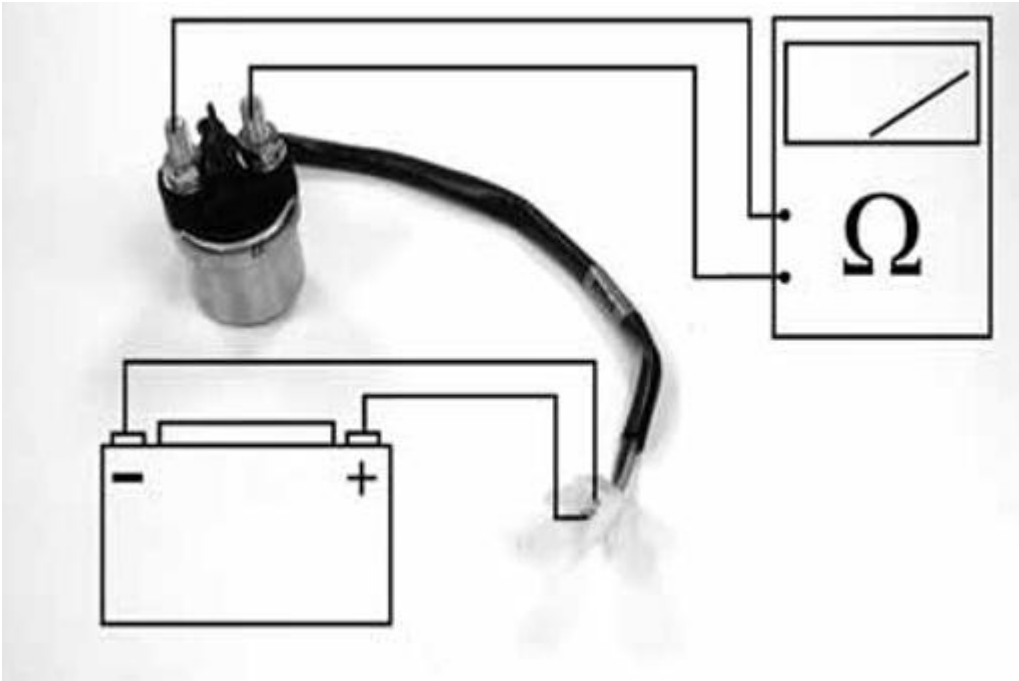

Connect the electric meter to the starter relay terminals that connect to the battery positive cable and the starter motor cable. Connect a fully charged battery across the starter relay yellow/red and green/yellow wire terminals. Check for continuity between the starter relay large terminals. The relay is normal if there is continuity and hear sounds.

Warning: Do not apply the battery voltage jump for more than five seconds or the relay may be damaged.

Starter Motor

SAFETY FIRST: Protective gloves and eyewear are recommended at this point.

Removal

Remove the battery cover. See the [Battery](#) topic for more information. Turn the ignition switch to "OFF".



Remove the negative battery cable bolt with a 10 mm socket or #3 Phillips screwdriver. Free the negative cable from the battery. Remove the airbox. See the [Airbox](#) topic for more information.



Pull back the rubber starter motor lead cover.

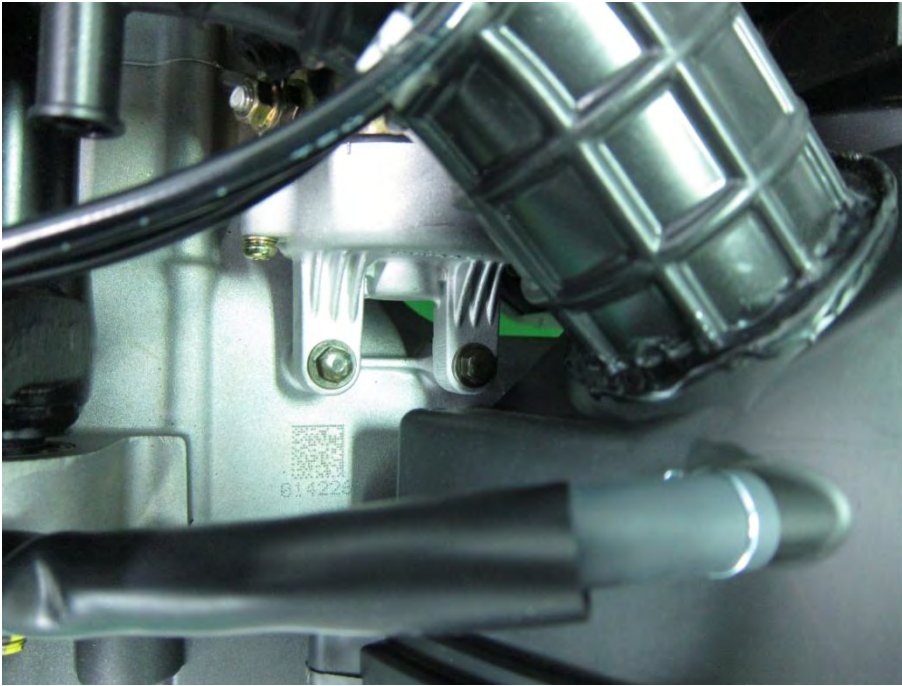

Remove the starter motor lead nut with a 10 mm wrench. Free the cable lead from the starter motor. Thread the nut back on to keep track of it.



Remove the two starter motor mounting bolts with an 8 mm socket.



Inspect the starter motor O-ring and replace it as needed.

Switches

SAFETY FIRST: Protective gloves and eyewear are recommended at this point.

You will need a digital multimeter to inspect the switches.

Ignition Switch

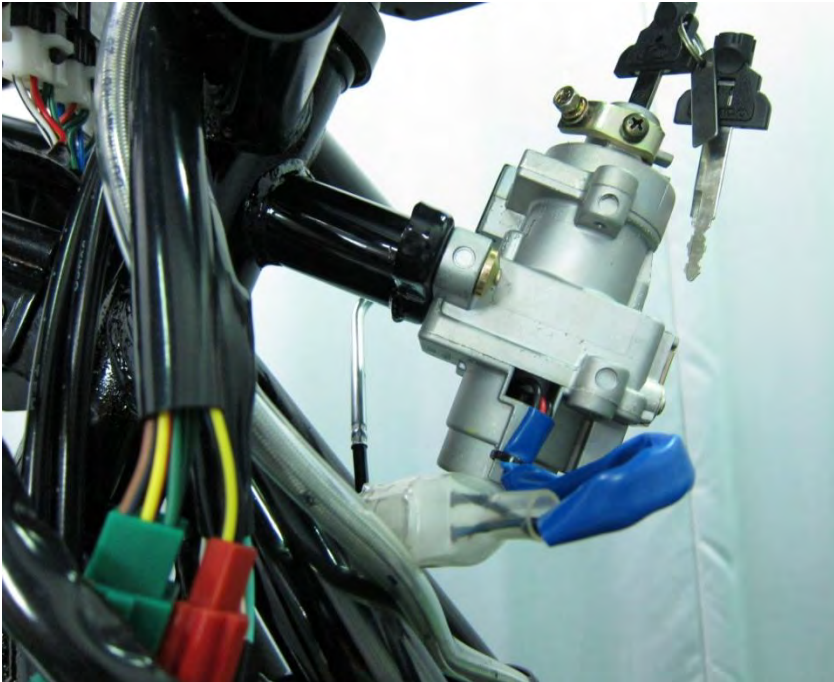

Unplug the white six-pin ignition switch connector.



Use a digital multimeter to check for continuity to inspect the ignition switches. Continuity should exist between the wires as indicated.

Ignition Switch

	BAT2	IG	E	BAT1	HA
LOCK		○—○			
OFF		○—○		○—○	
ON	○—			○—○	
COLOR	B	B/W	G	R	B/L

Removal

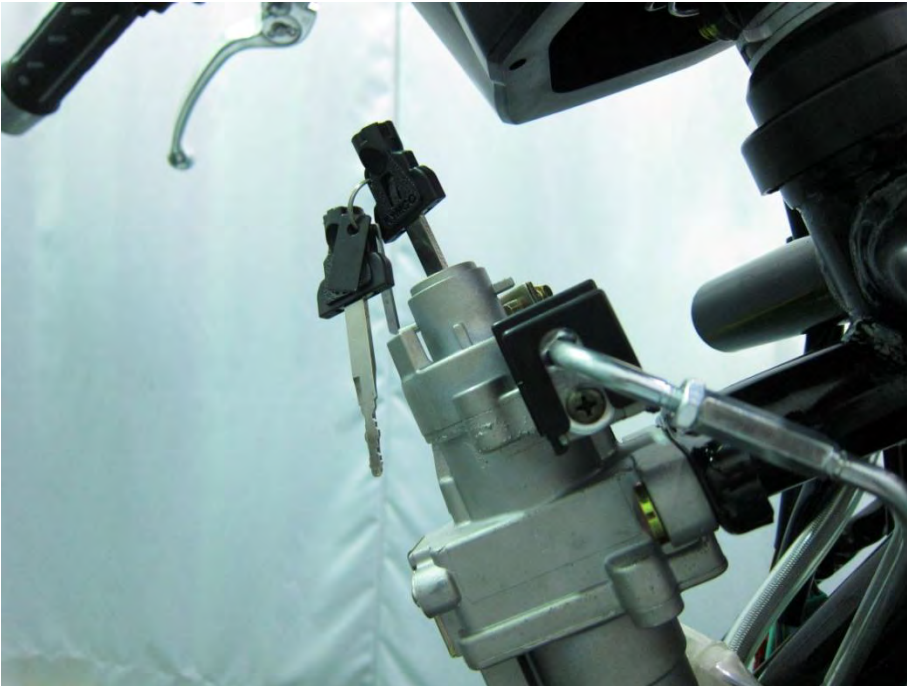

Remove the seat latch cable cover.

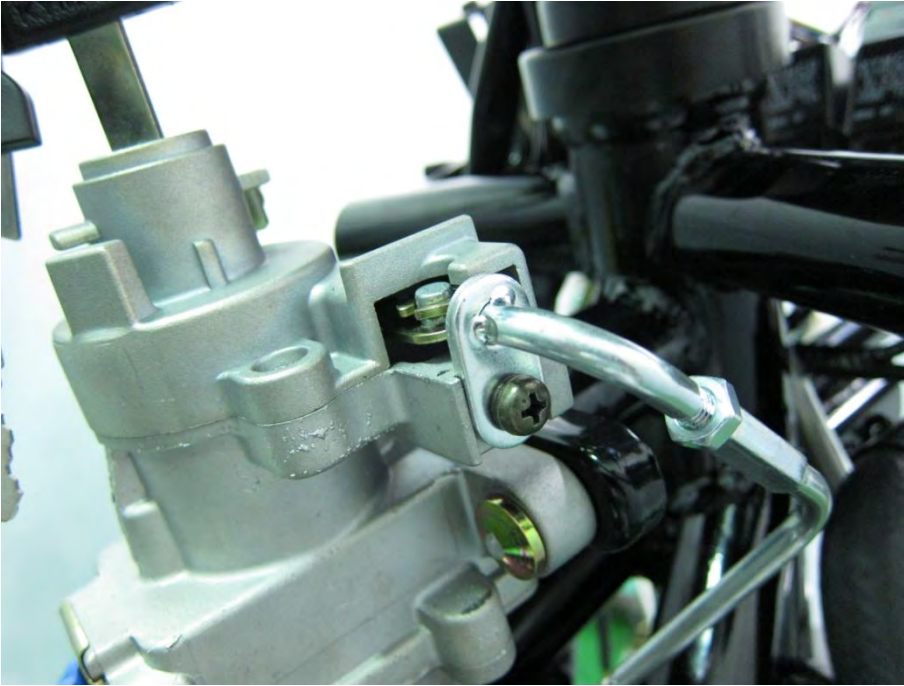

Loosen the seat latch cable screw with a #2 Phillips screwdriver. Remove the seat latch cable screw and free the seat latch cable from the ignition switch.

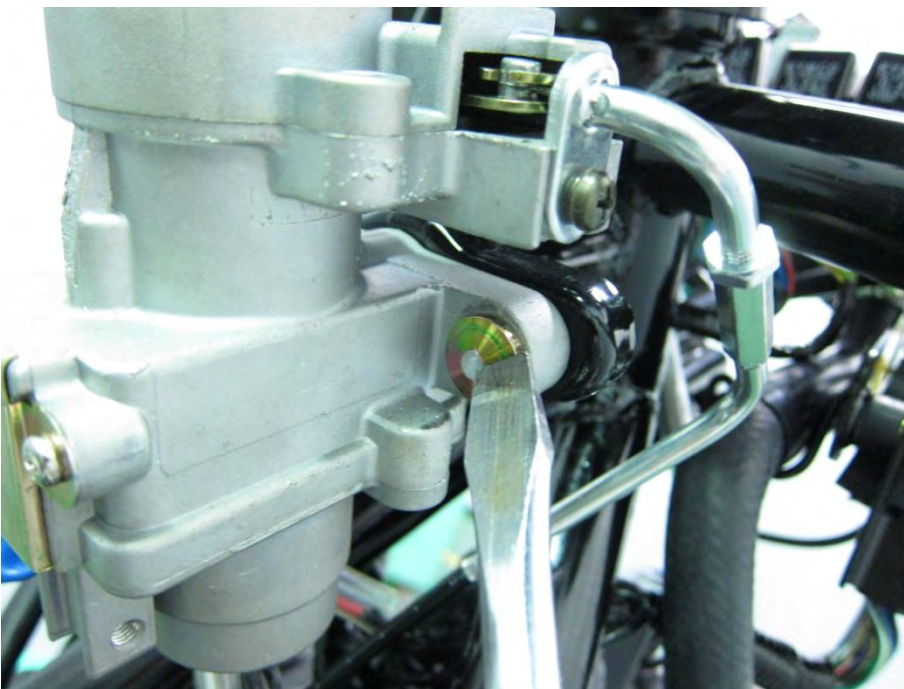

To remove the anti-tamper bolts use a punch and a hammer to strike the bolts so that they rotate loose. Turn the bolts clockwise to loosen them.

Tilt Switch

Remove the front cover. See the [Front Cover](#) topic for more information.

Support the scooter level surface.

Put the side stand up and engine stop switch on “RUN”. Turn the ignition switch to “OFF”.

Note: Do not disconnect the tilt switch connector during inspection. The capacity of battery must be fully charged.

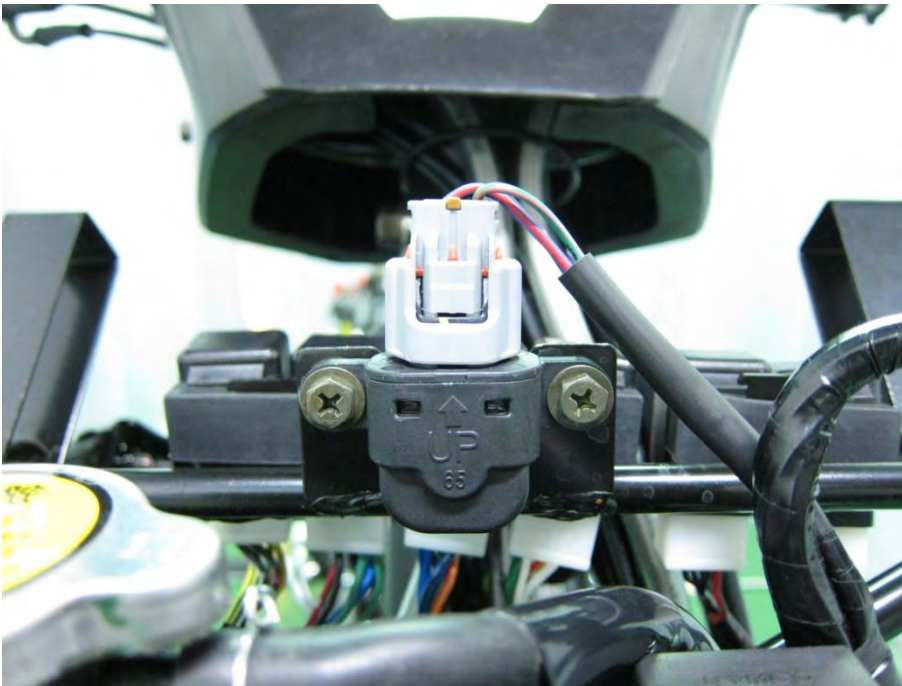

The tilt switch is located in the front near the radiator cap. Remove the two tilt switch screws and washers with a #2 Phillips.

Place the tilt switch vertical as shown and the ignition switch “ON”. Measure the voltage as below.

Terminal	Standard
Violet/Red (+) ~ Green/Pink (-)	5 V (ECU voltage)
Black/Blue (+) ~ Green/Pink (-)	0.4 - 1.4 V less

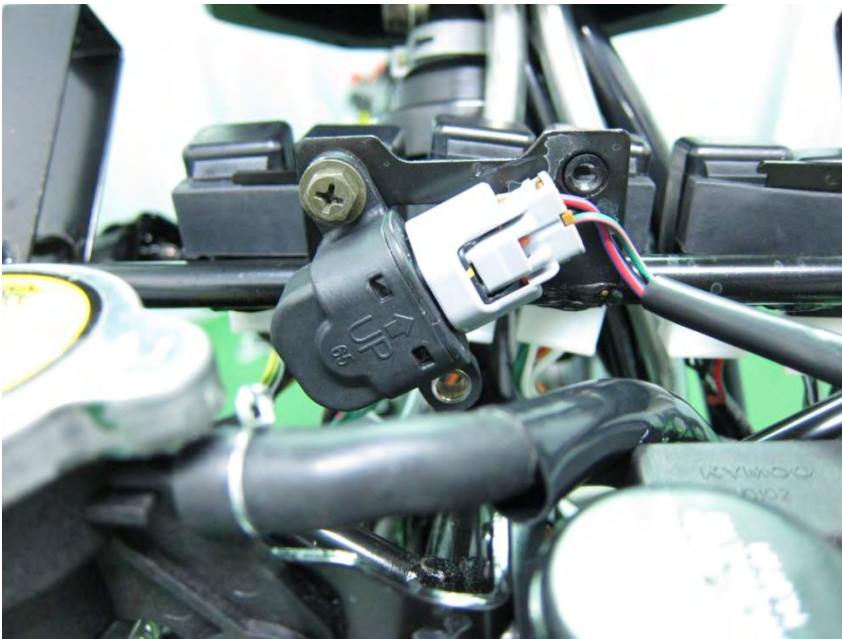

Incline the tilt switch 65 ± 10 degrees to the left or right at the ignition switch “ON”. Measure the voltage as below.

Terminal	Standard
Violet/Red (+) ~ Green/Pink (-)	5 V (ECU voltage)
Black/Blue (+) ~ Green/Pink (-)	3.7 - 4.4 V

Note: Repeat this test, first turn the ignition switch to “OFF”, then turn the ignition switch to “ON”.



Disconnect the connector to remove the tilt switch.

Note: Install the tilt switch with its “up” mark facing up and tighten the two screws securely.

Handlebar Switches

Remove the front cover. See the [Front Cover](#) topic for more information.

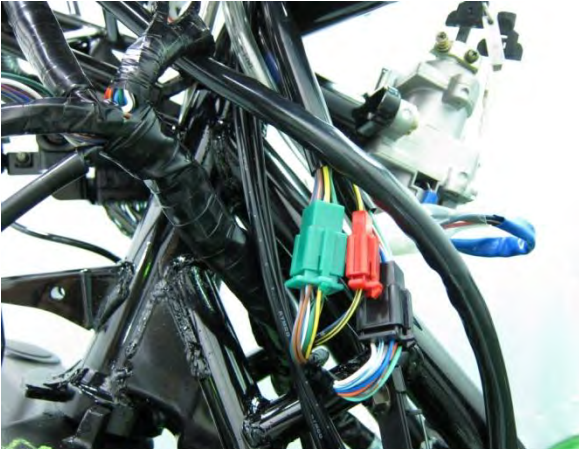

To remove the handle bar switches see the [Handlebar](#) topic.

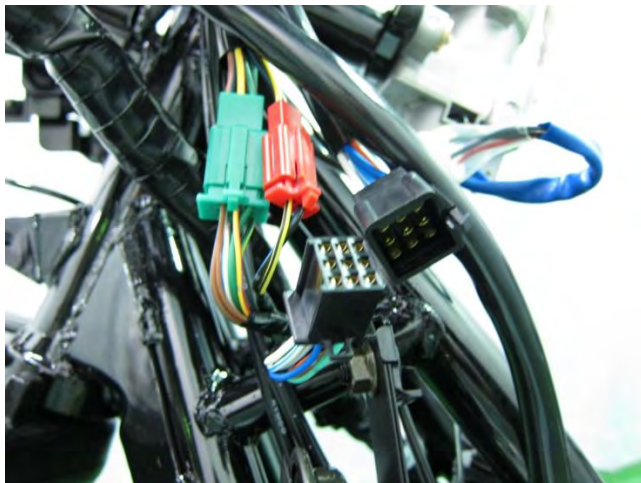

Unplug the black connector for the left handlebar switches.



Unplug the green connector for the right handlebar switches.

Right Handlebar Switches



Use a digital multimeter to check for continuity to inspect the handlebar switches. Continuity should exist between the wires as indicated.

Lighting Switch

	BAT3	PO	TL	HL
•				
(N)				
P	○—○	○—○	○	
(N)	○—○	○—○	○—○	○
H	○—○		○—○	○
COLOR	BR/L	BR/W	BR	W/L

Starter Switch

	E	ST
FREE		
PUSH	○—○	○—○
COLOR	G	Y/R

Engine Stop Switch

	IG	BAT3
OFF		
RUN	○—○	○—○
COLOR	B/W	B/G

Left Handlebar Switches



Use a digital multimeter to check for continuity to inspect the handlebar switches. Continuity should exist between the wires as indicated.

Passing Switch

Horn Switch

	BAT4	HI
FREE		
PUSH	○—○	
COLOR	BR/L	L

	BAT4	HO
FREE		
PUSH	○—○	
COLOR	BR/L	LG

Turn Signal Switch

Dimmer Switch

	WR	R	L
R	○—○		
N			
L	○—○		
COLOR	GR	SB	O

	HL	HI	LO
LO	○—○	○—○	
(N)	○—○	○—○	
HI	○—○		
COLOR	W/L	L	W

Luggage Box Switch

Remove the luggage box. See the [Luggage Box](#) topic for more information.

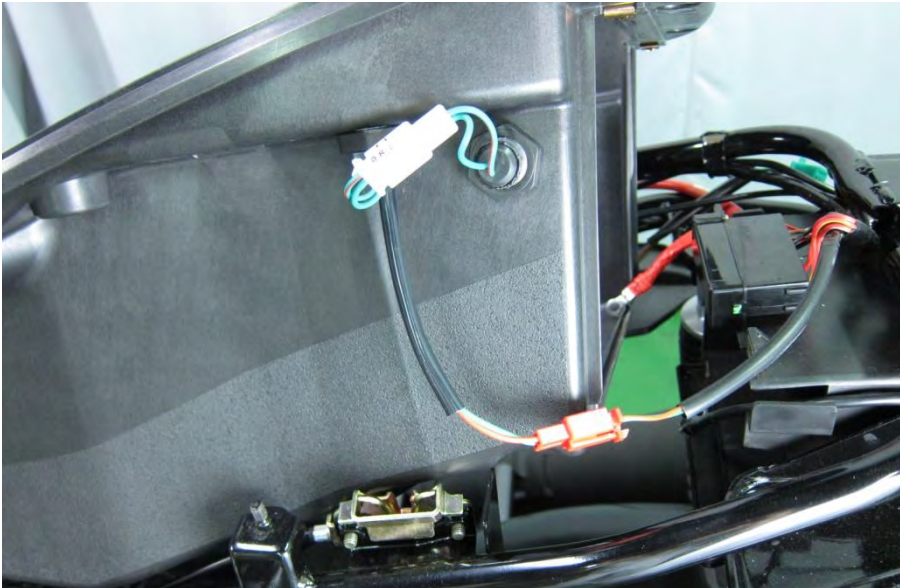

Unplug the two-pin luggage box light switch connector with red/white and green/red wires.



Remove the luggage box light and switch.

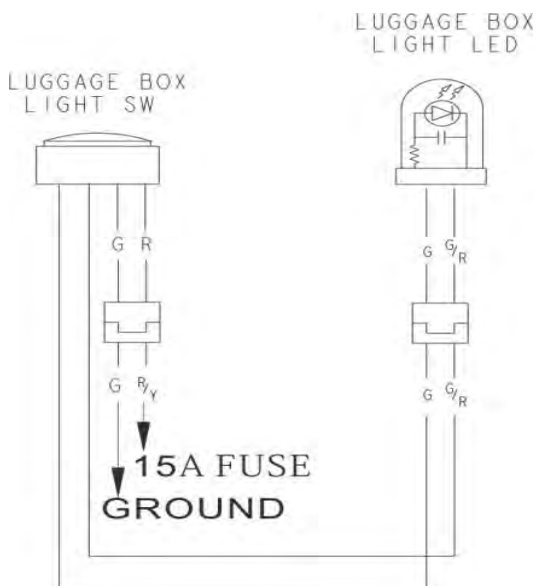

Side Stand Switch

Remove the luggage box. See the [Luggage Box](#) topic for more information.

Place the vehicle on the center stand.

Unplug the three-pin side stand switch connector.



Use a digital multimeter to check for continuity.



With the side stand retracted there should be continuity between the yellow/green wire and the green wire terminals.



With the side stand extended there should be continuity between the yellow/black wire and the green wire terminals.

To remove the side stand switch see the [Stands](#) topic.

Brake Light Switches

Test the front and rear brake light switches in the same manner. Use a digital multimeter to check for continuity.

Remove the upper handlebar cover. See the [Handlebar Covers](#) topic for more information.



Unplug the brake light switch connectors.



Check for continuity between the brake light switch connectors. There should be continuity when the lever is pulled and none when released.

To remove the brake light switch see the [Master Cylinders](#) topic.

Remove the dash. See the [Dash](#) topic for more information.

Lights

SAFETY FIRST: Protective gloves and eyewear are recommended at this point.

For general information and troubleshooting for the lights see the [Electrical Systems](#) chapter landing page.

Headlight

Bulb Replacement

Make sure the machine has been off for several minutes before removing the headlight bulb. Remove the front cover.



Slide back the rubber headlight covers.



Remove the front position LED connector.

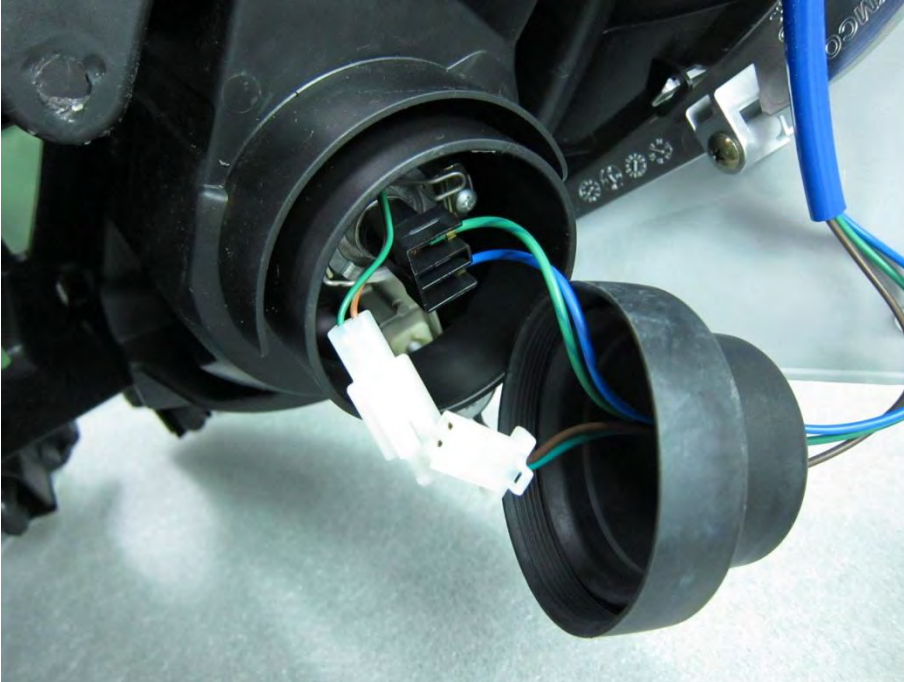

Slide back the head light bulb connector.

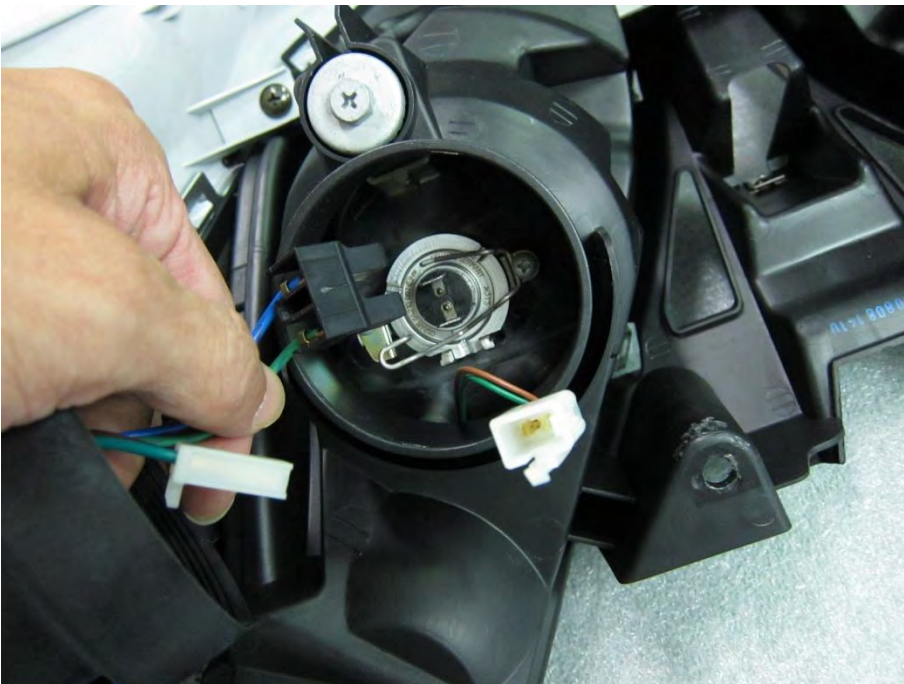

Loosen the screw and spring.

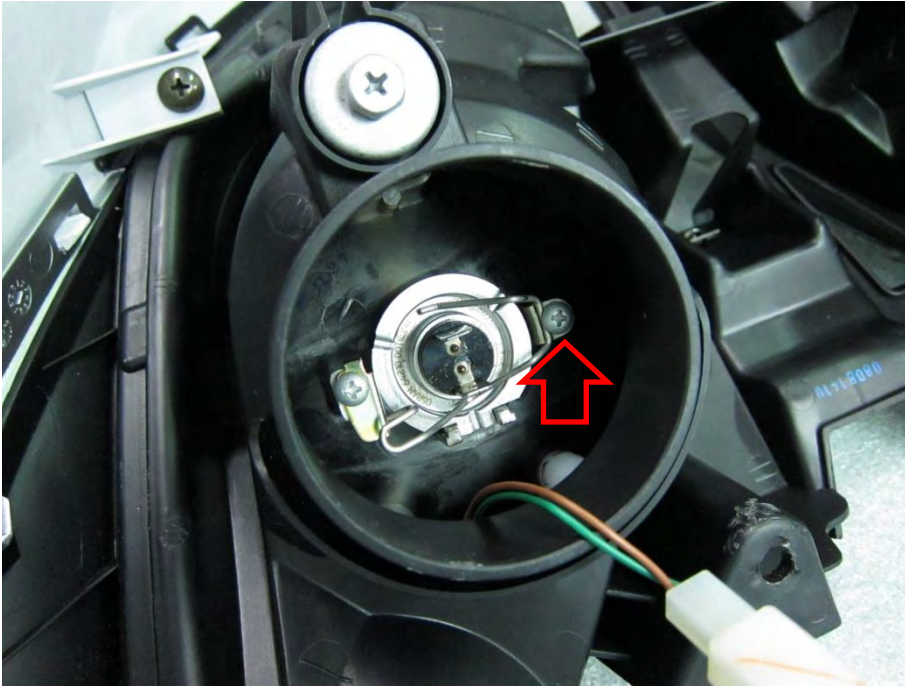

Unplug the bulb from its connector. Do not touch the bulb with your bare hands if you plan to reuse it.



Do not touch your new bulb with your bare hand. The oils on your hand can cause an early failure of the headlight bulb. If you do touch the bulb with your bare hand wipe off the bulb with a clean shop towel and alcohol.

Note: If the front position LED failure, replace the whole module with new one.

Aim



Turn the screws to adjust the head light aim as needed.

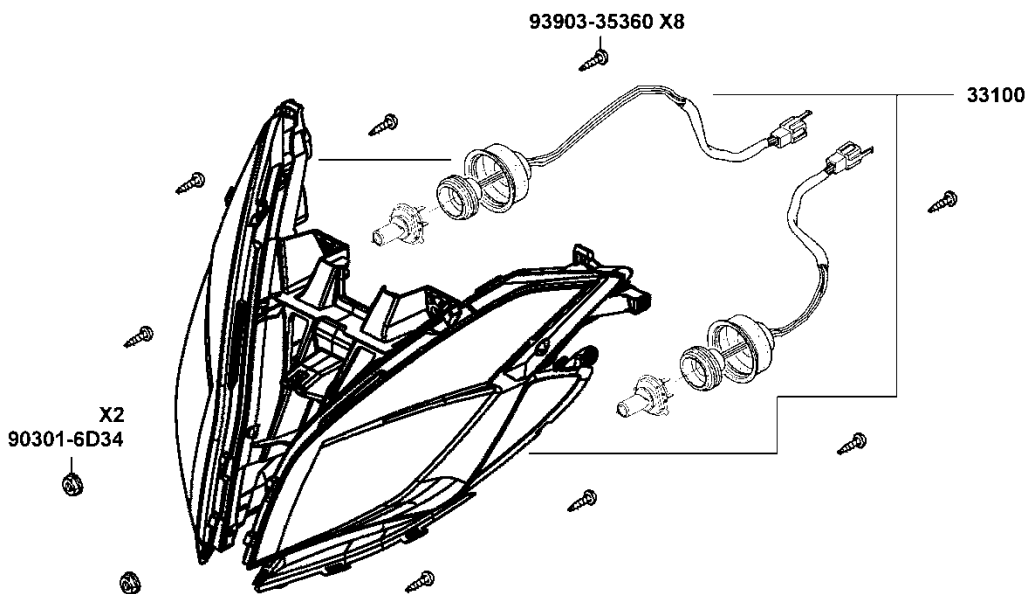

Front Turn Signals

Remove 3 screws of the turn signal light set.



And remove the turn signal light set.



Replace the turn signal light bulb if needed.

Rear turn signal lights

Bulb Replacement

Lift the seat. See the [Seat](#) topic for more information.

Remove the turn signal sockets with bulbs from the turn signal lamps.

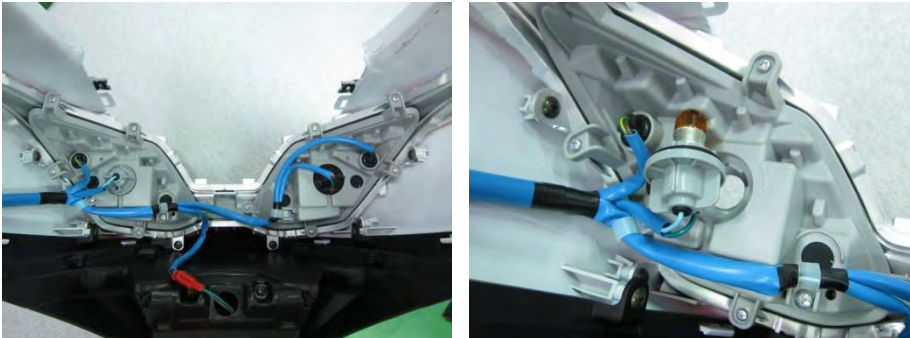

Remove the bulbs from the tail light housing by turning it counterclockwise.



Replace the bulbs as needed. Push in and turn the bulbs counterclockwise to remove the and clockwise to install them.

Tail/Stop light(LED)

Remove the rear cover. See the [Body Cover](#) topic for more information.

Repalce

Check the tail/stop light (LED), if the LED fail to light replace the whole module with a new one.

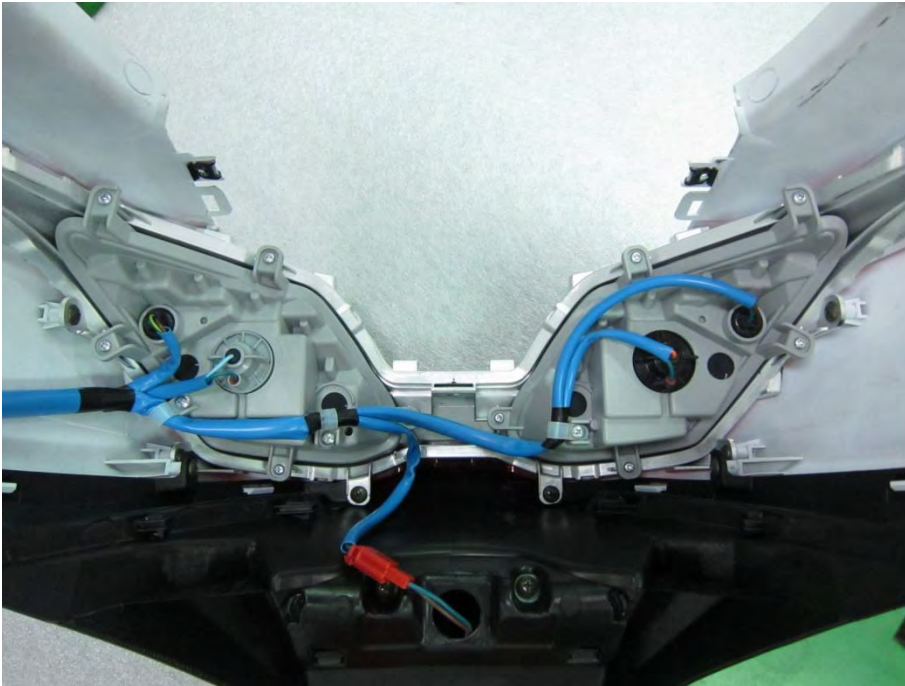

Change the whole set if the rear turn signal LED fail to light.

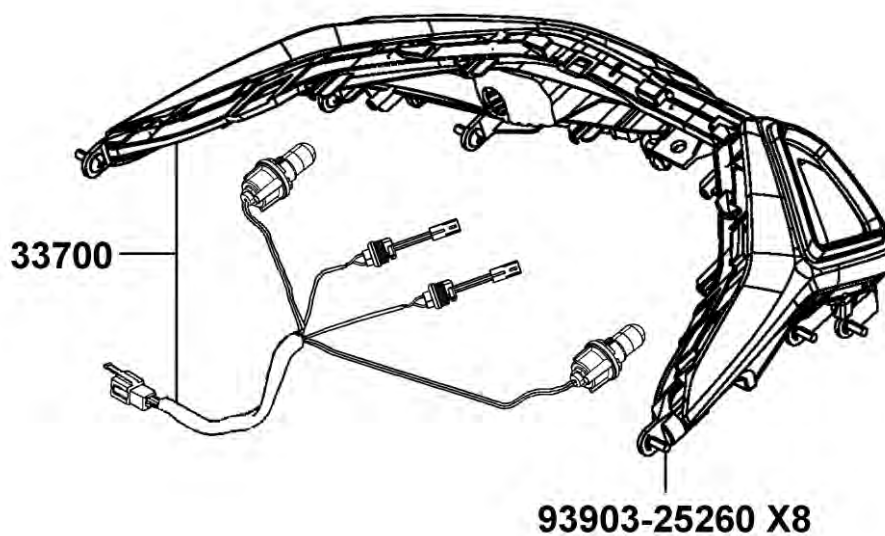

License Tag Light

Remove the license tag light from the mud flap. See the [Body Cover](#) topic for more information.

Remove the screws.



Pull the rubber tag light socket out of its housing. Pull the bulb straight out and insert a new one.

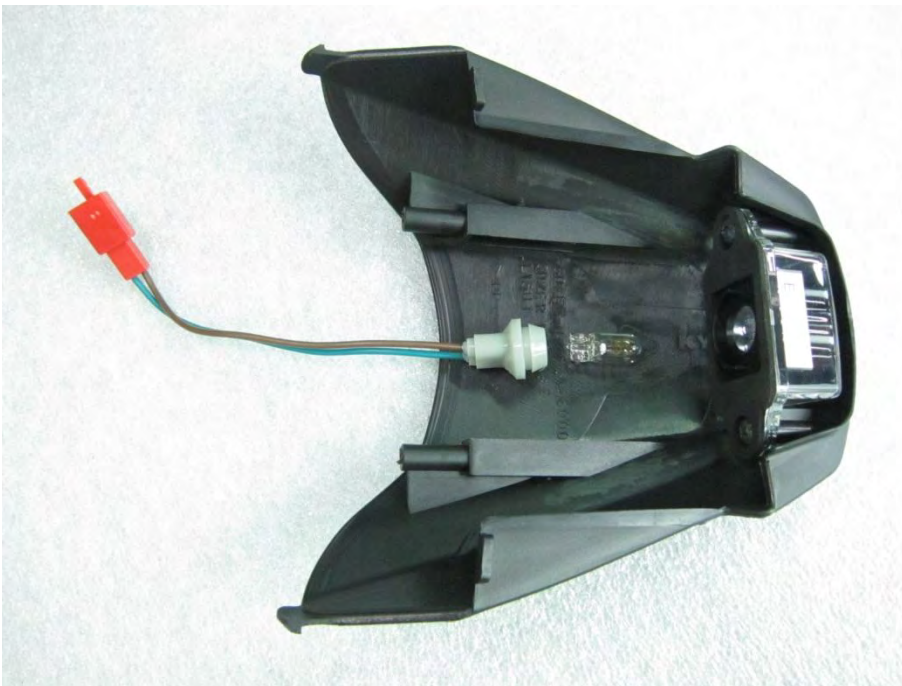

Insert the rubber socket into the housing.

Horn

SAFETY FIRST: Protective gloves and eyewear are recommended at this point.

Remove the front cover. See the [Front Cover](#) for more information.

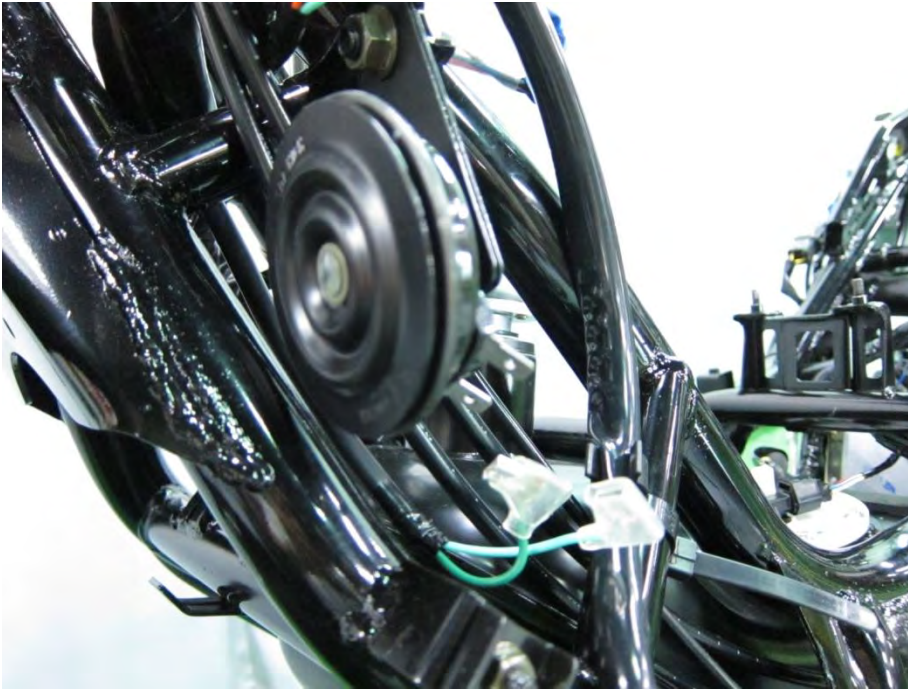

Disconnect the horn connectors from the horn. Connect a 12 V battery to the horn terminals. The horn is normal if it sounds when the 12 V battery is connected across the horn terminals.

To test the horn switch see the [Switches](#) topic.

10.Brakes

This chapter covers the location and servicing of the brake system components for the KYMCO Downtown 350i model.

<u>Brake Pad Replacement</u>	10-2
<u>Master Cylinders</u>	10-13
<u>Master Cylinders</u>	10-22
<u>Front Brake Caliper</u>	10-26
<u>Rear Brake Caliper</u>	10-31
<u>Brake Disc</u>	10-37
ABS	10-42

GENERAL INSTRUCTIONS

- During servicing, keep oil or grease off the brake pads and brake disk.

TROUBLESHOOTING

Poor brake performance

- Worn brake pads
- Contaminated brake pad surface
- Deformed brake disk
- Air in brake system
- Deteriorated brake fluid
- Worn brake master cylinder piston oil seal
- Clogged brake fluid line
- Unevenly worn brake caliper

Brake Pad Replacement

SAFETY FIRST: Protective gloves and eyewear are recommended at this point.



Replace the pads if the brake wear exceeds the wear indicator lines or if the wear is uneven.

Front

Remove the screw and loosen the brake pad pin with a 5 mm Allen.



Remove the two caliper mounting bolts with a 12 mm socket.
And remove the front caliper.



Remove the speedometer sensor mounting bolt with an 8 mm socket. And remove the speedometer sensor.



Remove the brake pad pin.

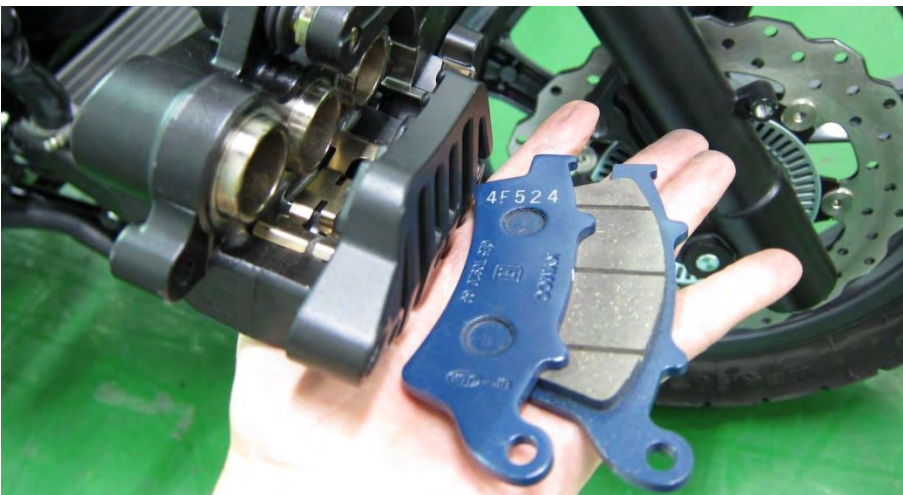

Remove the brake pads. Replace the pads if the brake wear exceeds the wear indicator lines or if the wear is uneven. Insert new brake pads as needed.

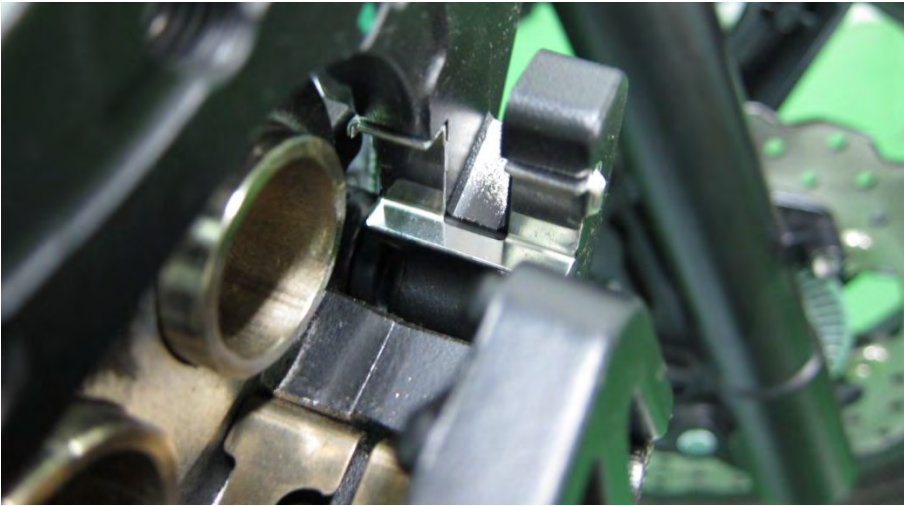

Fit the ends of the pads into the pad retainer as shown.



Apply a light coat of waterproof grease to the brake pad pin. Push the pads against the pad spring and insert the brake pad pin.

It may be necessary to spread the pads and force the pistons back into the caliper in order to allow room for the brake disc to fit between the new pads.



Install the front caliper. Guide the brake disc between the pads. Line up the caliper bracket mounts with the fork.

Install the two caliper bracket mounting bolts. Tighten the mounting bolts to specification.



Item	Torque	
	N-m	lb-ft
Front/Rear caliper bolt	35	25.8

Install the speedometer sensor.



Install the speedometer sensor mounting bolt with an 8 mm socket.

Item	Torque	
	N-m	lb-ft
Speed sensor cable	9.80 - 13.73	7.23 - 10.13



Tighten the brake pad pin securely with a 5 mm Allen.

Pump the brake lever to seat the caliper pistons against the pads. Check the operation on the brakes before returning the vehicle to service.

Rear

Remove the muffler. See the [Exhaust System](#) topic for more information.
Remove the rear fender. See the [Rear Fender](#) topic for more information.

If the caliper is to be disassembled the brake hose must be removed. Drain the rear brake fluid. See the [Brake Fluid](#) topic for more information.



Remove the two rear brake hose clamp bolts with a socket.

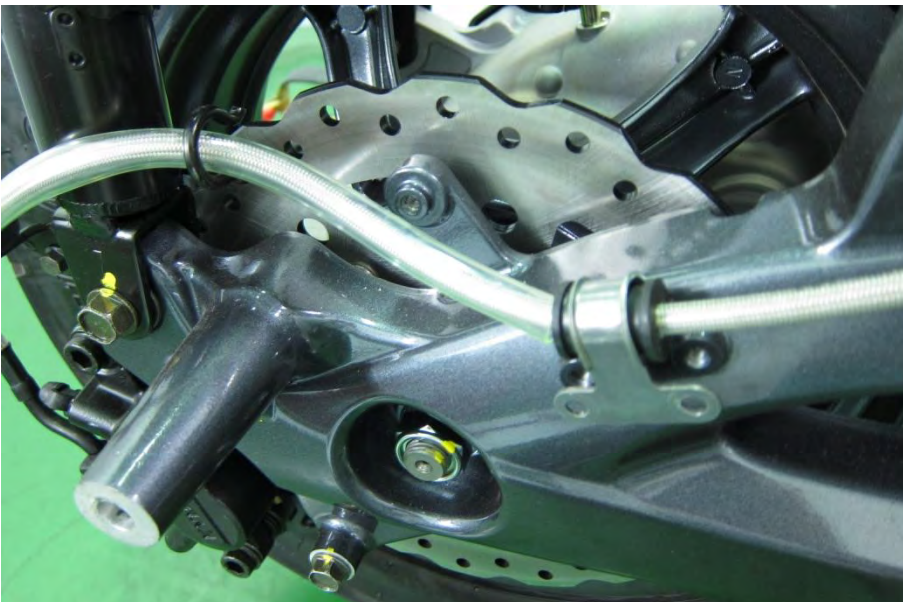

Remove the rear brake hose clamp.



Remove the two rear caliper mounting bolts with a 12 mm socket.



Remove the rear caliper from the swingarm.



One at a time, move the brake pads to the center gap in the pad retainers and lift the pad out. If needed, use the piston side pad to push the pistons in to allow for more room.



Replace the pads if the brake wear exceeds the wear indicator lines or if the wear is uneven.

One at a time, fit the brake pads into the center gap in the pad retainers and then move the pad into the retainer. If needed, use the piston side pad to push the pistons in to allow for more room.



Install the rear caliper onto the swingarm.



Install the two caliper bracket mounting bolts. Tighten the mounting bolts to specification.

Item	Torque	
	N-m	lb-ft
Front/Rear caliper bolt	35	25.8

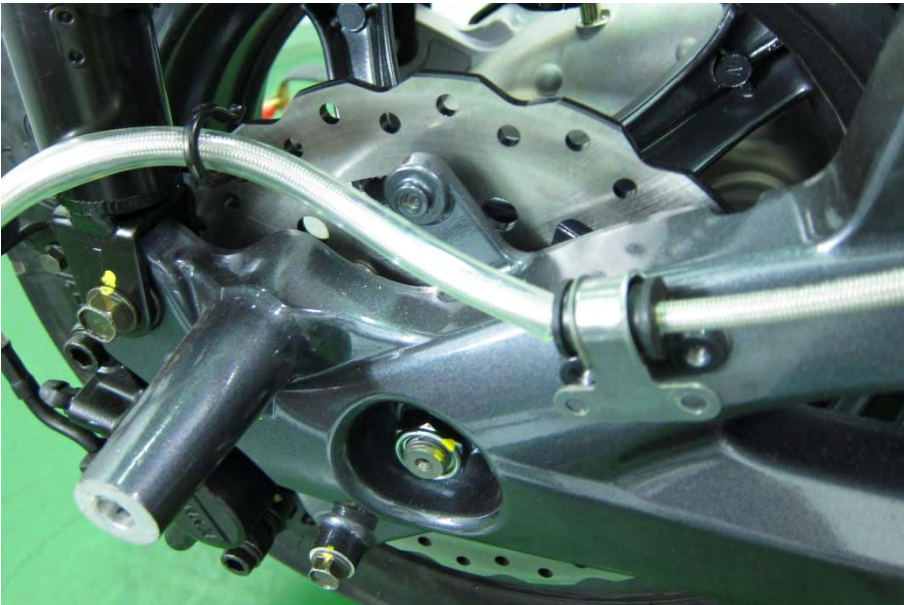

Fit the rear brake hose guide into place.

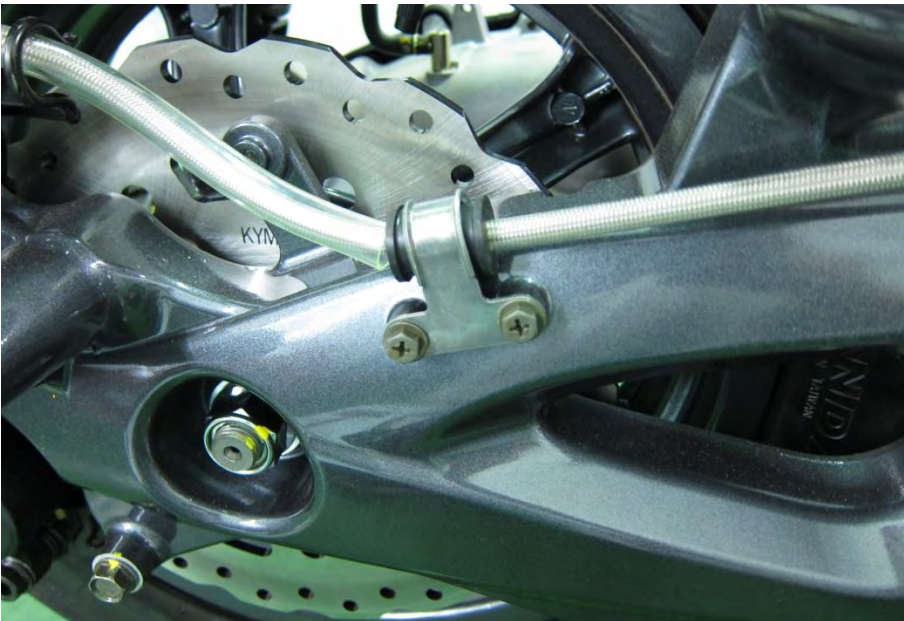

Insert the two rear brake hose clamp bolts and tighten them securely with a socket.

Fill the rear brake system with fresh brake fluid and bleed out the air. See the [Brake Fluid](#) topic for more information.

Pump the brake lever to seat the caliper pistons against the pads. Check the operation on the brakes before returning the vehicle to service.

Install the rear fender. See the [Rear Fender](#) topic for more information.

Install the muffler. See the [Exhaust System](#) topic for more information.

Master Cylinders

SAFETY FIRST: Protective gloves and eyewear are recommended at this point.

NOTE: Brake fluid is a corrosive chemical and can damage paints and some plastics. Avoid contact with skin.

Removal

The master cylinders for the front and rear brakes are essentially the same.

Remove the handlebar covers. See the [Handlebar](#) topic for more information.

Drain the brake fluid. See the [Brake Fluid](#) topic for more information.



Remove the brake hose banjo bolt from the master cylinder using a 12 mm socket. Discard the sealing washers.



Unplug the brake light switch connector.
Remove the two master cylinder mounting bolts with an 8 mm socket.



Remove the master cylinder clamp.



Remove the master cylinder.



Remove the two master cylinder cover screws with a #2 Phillips head screwdriver.



Remove the master cylinder cover, plastic piece and rubber accordion diaphragm. Pour out any remaining brake fluid.

Disassembly

Brake Levers



Loosen the brake lever pivot nut with a 10 mm socket and the pivot bolt with a flat blade screwdriver.



Remove the pivot nut and bolt.



Remove the brake lever.

Brake Light Switch



Remove the brake light switch mounting bolt with a #2 Phillips screwdriver. Remove the brake light switch.

Piston



Remove the rubber piston cover.



Remove the snap ring using a pair of internal snap ring pliers. Use a suitable tool to hold back the piston as it can spring out.



Remove the piston, spring and cups.



Remove the spring from the piston and

Inspection

Clean the master cylinder components with fresh brake fluid. Inspect the master cylinder components for wear and damage. Replace the parts as needed



Inspect the piston and cups for wear and damage. Measure the outside diameter of the piston.

Item	Standard mm (in)
Brake master cylinder piston O.D.	12.65 - 12.68 (0.506 - 0.5072)



Inspect the master cylinder bore for wear and damage. Measure the inside diameter of the brake master cylinder.

Item	Standard mm (in)
Brake master cylinder I.D.	12.7 - 12.74 (0.508 - 0.5096)

Assembly

Piston



Place a film of clean DOT 4 brake fluid on the piston, spring and master cylinder bore.



Install the master cylinder piston and spring into the master cylinder bore.



Compress the snap ring with internal snap ring pliers and Install the snap ring.



Install the rubber boot over the end of the master cylinder piston.

Brake Light Switch

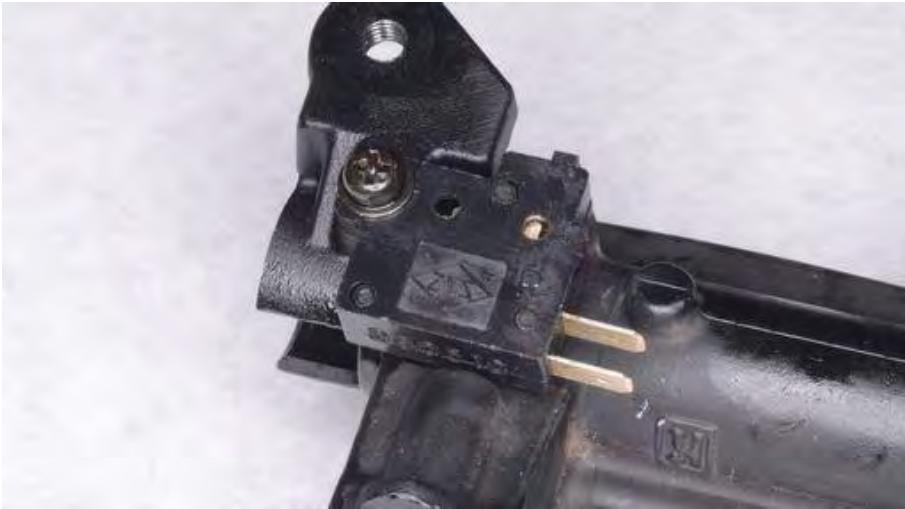

Install the brake light switch. Tighten the mounting screw securely with a #2 Phillips screwdriver.

Brake Levers



Install the brake lever.



Apply a light coat of grease to brake lever pivot bolt. Insert the pivot bolt from above and thread on the nut.



Tighten the brake lever bolt with a flat blade screwdriver and then tighten the nut with a 10 mm socket.

Installation



Position the master cylinder on the handlebar.



Install the master cylinder clamp. Be sure to insert the pin on the clamp into the hole on the handlebar.



Install the two master cylinder mounting bolts and tighten them securely with an 8 mm socket.



Plug in the brake light switch connector.



Install the brake hose to the master cylinder with the banjo bolt. Use new sealing washers. Tighten the banjo bolt to specification with a 12 mm socket.

Item	Torque	
	N-m	lb-ft
Banjo bolt	35	25.8

Fill the master cylinder reservoir/s with brake fluid and bleed the system. See the [Brake Fluid](#) topic for more information.

Install the handlebar covers. See the [Handlebar](#) topic for more information.

Front Caliper

SAFETY FIRST: Protective gloves and eyewear are recommended at this point.

Removal



Remove the screw and loosen the brake pad pin with a 5 mm Allen.



Remove the two caliper mounting bolts with a 12 mm socket.
And remove the front caliper.



Remove the speedometer sensor mounting bolt with an 8 mm socket. And remove the speedometer sensor.



Remove the brake pad pin.

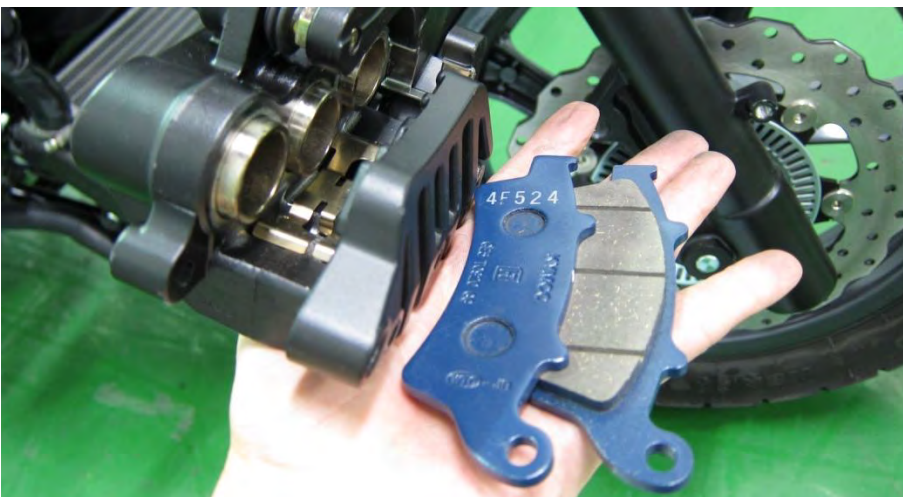

Remove the brake pads. Replace the pads if the brake wear exceeds the wear indicator lines or if the wear is uneven. Insert new brake pads as needed.



Fit the ends of the pads into the pad retainer as shown.



Apply a light coat of waterproof grease to the brake pad pin. Push the pads against the pad spring and insert the brake pad pin.

It may be necessary to spread the pads and force the pistons back into the caliper in order to allow room for the brake disc to fit between the new pads.

Inspection



Inspect the pistons for wear and damage.



Measure the outside diameter of the piston with a micrometer and compare the measurement with the specification. Replace the pistons as needed.

Item	Standard mm (in)
Brake caliper piston O.D.	26.93 - 26.96 (1.0602 - 1.0614)

Inspect the piston bores for wear and damage.



Inspect the piston bores for wear and damage. Measure the inside diameter of the piston bore with a telescoping gauge and micrometer. Replace the caliper as needed.

Item	Standard mm (in)
Brake caliper cylinder I.D.	27 - 27.05 (1.063 - 1.065)

Rear

Remove the muffler. See the [Exhaust System](#) topic for more information.
Remove the rear fender. See the [Rear Fender](#) topic for more information.

If the caliper is to be disassembled the brake hose must be removed. Drain the rear brake fluid. See the [Brake Fluid](#) topic for more information.

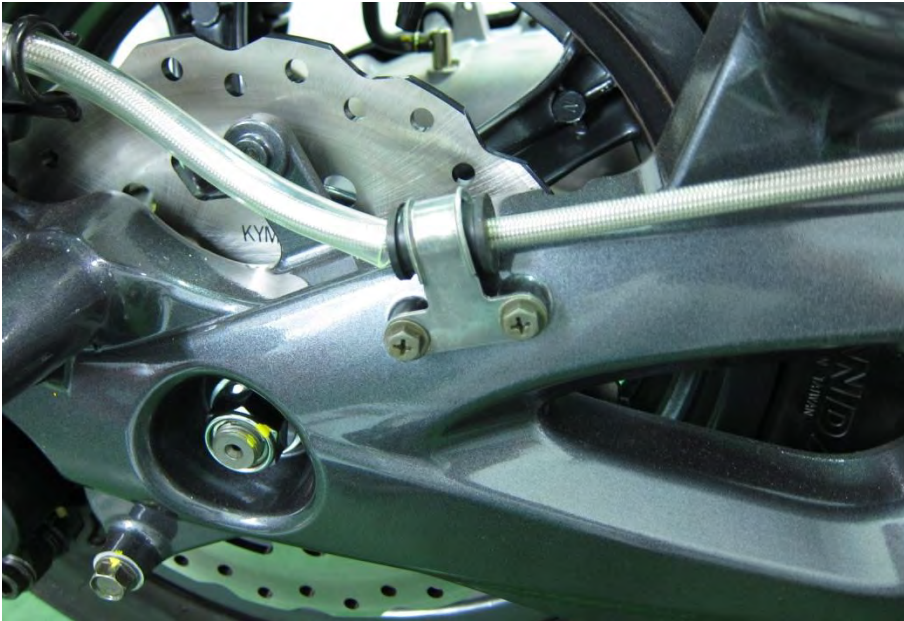

Remove the two rear brake hose clamp bolts with a socket.

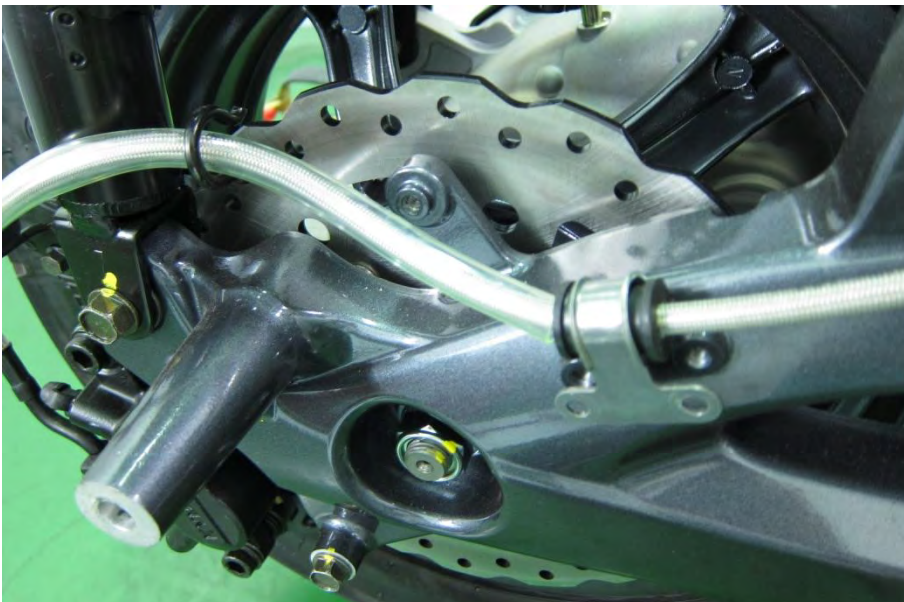

Remove the rear brake hose clamp.



Remove the two rear caliper mounting bolts with a 12 mm socket.



Remove the rear caliper from the swingarm.



Place a suitable container under the banjo bolt to catch any remaining brake fluid. Remove the banjo bolt that holds the brake hose to the caliper using a 12 mm socket. Discard the two sealing washers.



Replace the brake hose banjo bolt sealing washers with new items on assembly.

Installation



Install the rear caliper onto the swingarm.



Install the two caliper bracket mounting bolts. Tighten the mounting bolts to specification.

Item	Torque	
	N-m	lb-ft
Front/Rear caliper bolt	35	25.8



Install the banjo bolt with new sealing washers and tighten to specification with a 12 mm socket.

Item	Torque	
	N-m	lb-ft
Banjo bolt	35	25.8

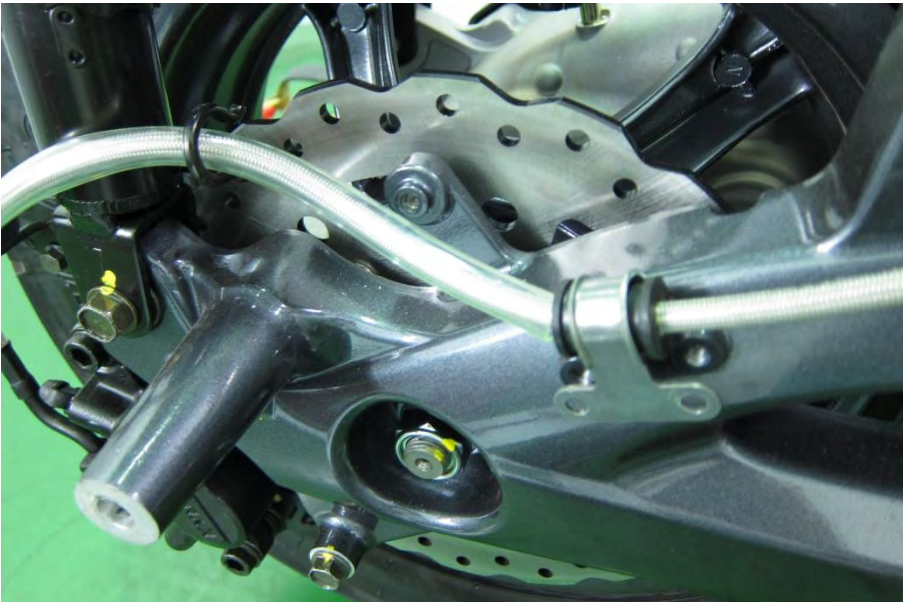

Fit the rear brake hose guide into place.

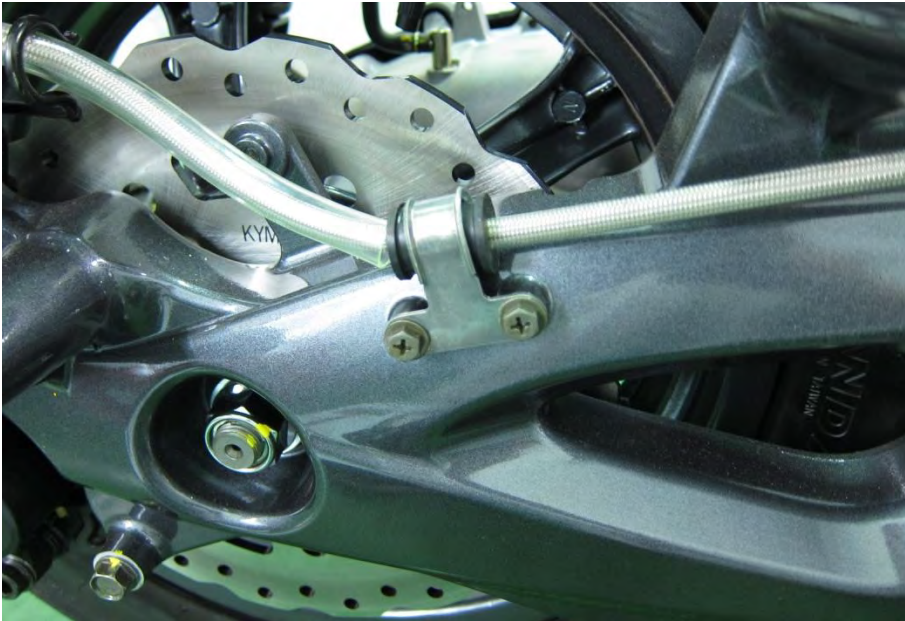

Insert the two rear brake hose clamp bolts and tighten them securely with a 10 mm socket.

Fill the rear brake system with fresh brake fluid and bleed out the air. See the [Brake Fluid](#) topic for more information.

Pump the brake lever to seat the caliper pistons against the pads. Check the operation on the brakes before returning the vehicle to service.

Install the rear fender. See the [Rear Fender](#) topic for more information.

Install the muffler. See the [Exhaust System](#) topic for more information.

Disc Brake

Inspection



Measure the thickness of the brake rotor with a Vernire caliper or micrometer.

ITEM		STANDARD
Brake disc thickness	Front	3.8 - 4.2 mm (0.15 - 0.165 in)
	Rear	5.0 mm (0.2 in)



Check if the brake rotor runout is within service limit.

Measure the runout of the brake disc with a dial gauge. If the reading is out of specification remove the disc from the wheel and recheck.

Item	Standard (mm)
Rear brake disk runout	max 0.4

Front

Removal

Remove the front wheel. See the [Front Wheel](#) topic for more information.

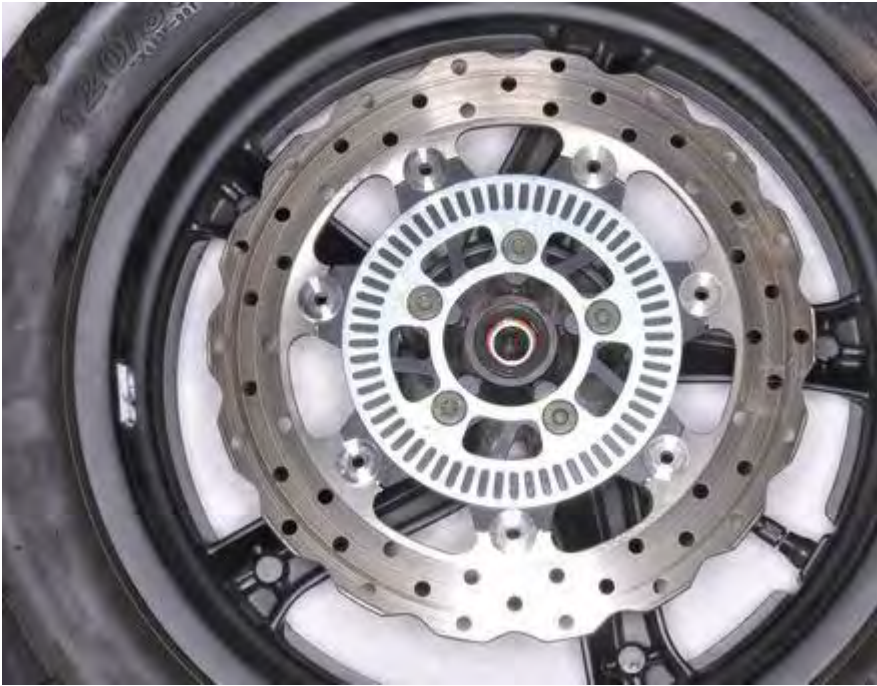

Remove the five brake disc mounting bolts with an Allen wrench.



Remove the front brake disc and front wheel speed sensor rotor.



Separate the wheel speed sensor rotor from the brake disc.

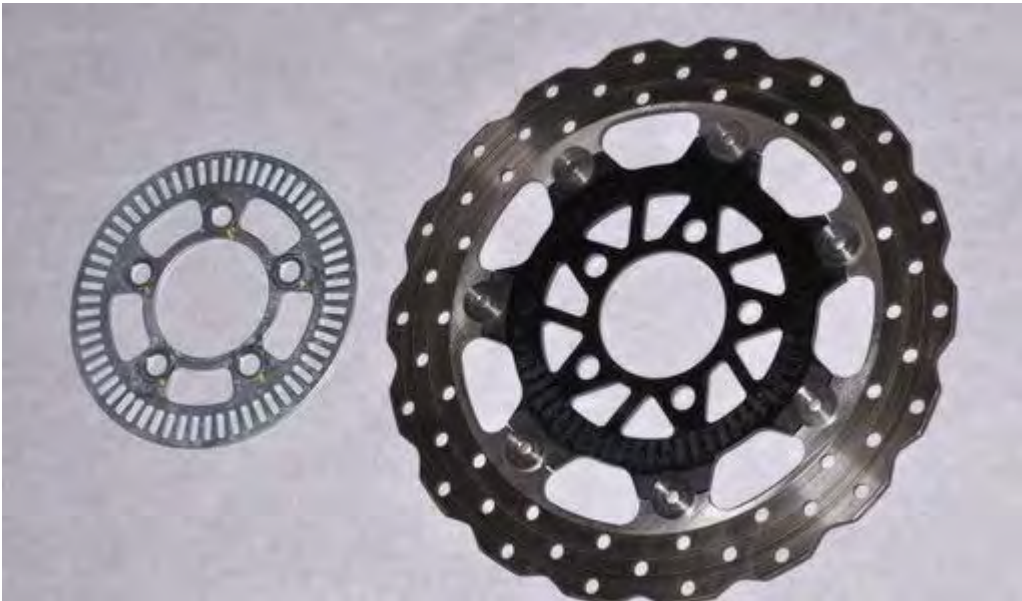

Inspect the wheel speed sensor and brake disc for wear and damage. Replace the parts as needed.



Set the front brake disc and speed sensor rotor in place on the front wheel.

Installation

Coat the threads of the disc bolts in a non-permanent thread locking agent. Thread in the bolts and torque them to specification with an Allen socket.



Set the speed sensor rotor on the front brake disc. Position the rotor so that its sharp side sits against the brake disc.



Insert the front brake disc mounting bolts. Tighten the bolts to specification with an Allen socket.

Item	Qty	Thread size (mm)	Torque	
			kgf-m	lb-ft
Disk bolt	5	8	3.2-3.8	23.15-27.48

Install the front wheel. See the [Front Wheel](#) topic for more information.

ABS

SAFETY FIRST: Protective gloves and eyewear are recommended at this point.

ABS Component Location

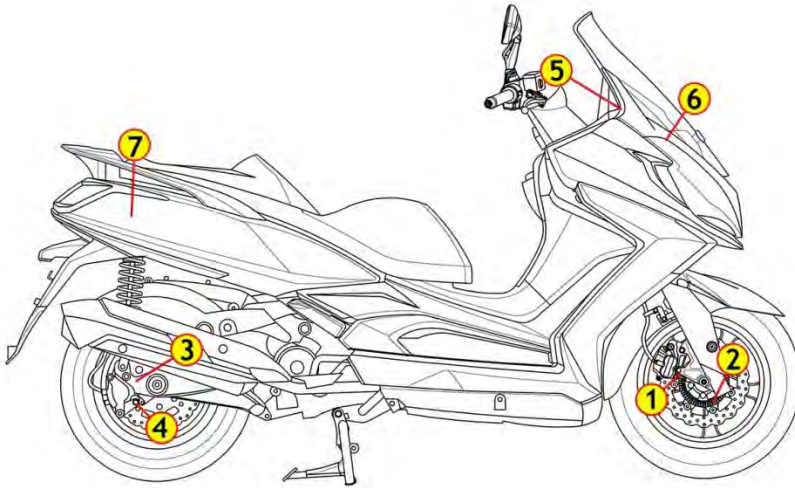

1. Front Wheel speed Sensor
2. Front Wheel speed Sensor Rotor
3. Rear Wheel speed Sensor
4. Rear Wheel speed Sensor Rotor
5. ABS Indicator Light
6. ABS Hydraulic Unit
7. ABS diagnosis tool Connector (Near battery position)

Introduction to KYMCO Anti-Lock Brake

System

ABS is designed to help prevent the wheels from locking up when the brakes are applied hard while running straight. The ABS automatically regulates brake force.

Intermittently gaining gripping force and braking force helps prevent wheel lock-up and allows stable steering control while stopping.

Brake control function is identical to that of conventional vehicle. The brake lever is used for the front brake and rear brake.

Although the ABS provides stability while stopping by preventing wheel lock-up, remember the following characteristics:

- ABS can not compensate for adverse road conditions, misjudgment or improper application of brakes. You must take the same care as with vehicle not equipped with ABS.
- ABS isn't designed to shorten the braking distance. On loose, uneven or downhill surfaces, the stopping distance of a vehicle with ABS may be longer than that of an equivalent vehicle without ABS. Use special caution in such areas.
- ABS will help prevent wheel lock-up when braking in straight line but it cannot control wheel slip which may be caused by braking during cornering. When turning a corner, it is better to limit braking to a light application of both brakes or not to brake at all. Reduce your speed before you get into the corner.
- The computers integrated in the ABS compare vehicle speed with wheel speed. Since non-recommended tires can affect wheel speed, they may confuse the sensors resulting in extended braking distance.

Caution: Use of non-recommended tires may cause malfunctioning of ABS and lead to extended braking distance. The rider could have an accident as a result. Always use the standard tires for this vehicle.

Notice:

- When the ABS is functioning, you may feel a pulsing in the brake lever. This is normal - you need not suspend applying the brakes.
- ABS does not function below speeds of approximately 10 kph or 7 mph.
- ABS does not function if battery is discharged or there is a battery power supply malfunction (ABS light will come on).

ABS Servicing Precautions

There are a number of important precautions that should be followed servicing the ABS system.

- This ABS system is designed to be used with a 12V sealed battery as its power source. Do not use any other battery except for a 12V sealed battery as a power source.
- Do not reverse the battery cable connections. This will damage the ABS hydraulic unit.
- To prevent damage to the ABS parts, do not disconnect the battery cables or any other electrical connections when the ignition switch is ON or while the engine is running.
- Take care not to short the leads that are directly connected to the battery positive (+) terminal to the chassis ground.
- Do not turn the ignition switch is ON while any of the ABS electrical connectors are disconnected. The ABS hydraulic unit memorizes service codes.
- Do not spray water on the electrical parts, ABS parts, connectors, leads and wiring.
- Whenever the ABS electrical connections are to be disconnected, first turn off the ignition switch.
- The ABS parts should never be struck sharply, as with a hammer, or allowed to fall on a hard surface. Such a shock to the parts can damage them.
- The ABS parts cannot be disassembled. Even if a fault is found, do not try to disassemble and repair the ABS parts, replace the ABS unit with a new component.
- The ABS has many brake lines, pipes, and leads. And the ABS cannot detect problems with the conventional braking system (brake disk wear, unevenly worn brake pads and other mechanical faults). To prevent trouble, check the brake lines and pipes for correct routing and connection, the wiring for correct routing, and the brakes for proper braking power. Be sure to check for fluid leaking, and bleed the brake line thoroughly.

Caution

If any of the brake line fittings, including the ABS hydraulic unit joint nuts, or the bleed valve are opened at any time, the air must be bled completely from the brake line.

Do not ride the scooter with air in the brake line, or the ABS could malfunction.

- The ABS indicator light may light if the tire pressure is incorrect, a non-recommended tire is installed, or the wheel is deformed. If the indicator light lights, remedy the problem and clear the service code.

- When the ABS operates, the ABS makes noise and the rider feels the reaction force on the brake lever and brake pedal. This is a normal condition. It informs the rider that the ABS is operating normally.

- Service codes detected once by the ABS hydraulic unit will be memorized in the ABS hydraulic unit. Therefore, after maintenance work is finished, be sure to erase the service codes. Do not erase the service codes during troubleshooting. Wait until all the checks and repair work is finished to prevent duplication of previous service codes and unnecessary maintenance work.

- Before delivering the scooter to the customer, be sure to erase any service codes which might be stored in the ABS hydraulic unit. Test run the scooter at a speed of more than 6 kph (4 mph) to see that the ABS indicator light does not come on. Finally, test run the scooter at a speed of more than 30 km/h (20 mph) and brake suddenly to see that the scooter stops without loss of steering control and the ABS operates normally. (The reaction force generated is felt in the brake lever and pedal.) This completes the final inspection.

ABS Troubleshooting Outline

The ABS indicator light lights up to alert the rider when an abnormality is detected by the system. The service codes are stored in the ABS unit memory. The codes will not be erased unless manually cleared. After the fault has been corrected erase the service codes.

Even when the ABS is operating normally, the ABS indicator light may light up under the conditions listed below. Turn the ignition switch OFF to stop the indicator light. If the scooter runs without erasing the service codes, the light may light up again.

- After continuous riding on a rough road.
- When the ABS has been subjected to strong electrical interference.
- When tire pressure is abnormal. Adjust tire pressure.
- When a tire different in size from the standard size is being used. Replace with standard size.
- When the wheel is deformed. Replace the wheel.

Much of the ABS troubleshooting work consists of confirming continuity of the wiring. The ABS parts are assembled and adjusted by the manufacturer, so there is no need to disassemble or repair them. Replace the ABS hydraulic unit if needed.

The basic troubleshooting procedures are listed below.

- Carry out pre-diagnosis inspections as a preliminary inspection.
- Check wiring and connections from the ABS hydraulic unit connector to the suspected ABS part, using the diagnosis tool.

Special tool - Diagnosis tester: 3620A-LEB2-E00

- Visually inspect the wiring for signs of burning or fraying. If any wiring is poor, replace the damaged wiring.
- Pull each connector apart and inspect it for corrosion, dirt and damage. If the connector is corroded or dirty, clean it carefully. If it is damaged, replace it.
- Check the wiring for continuity.

Pre-diagnosis Inspection Chart 1

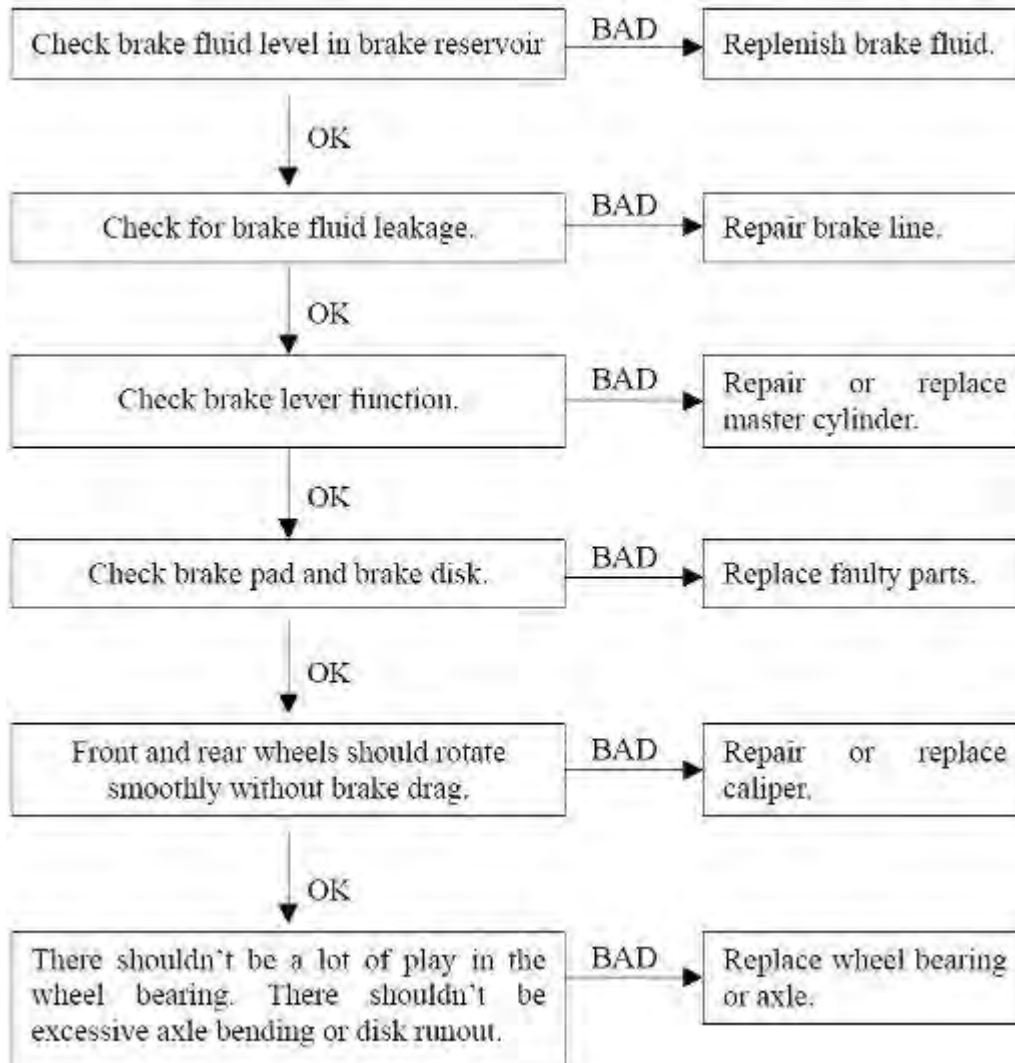

Pre-diagnosis Inspection Chart 2

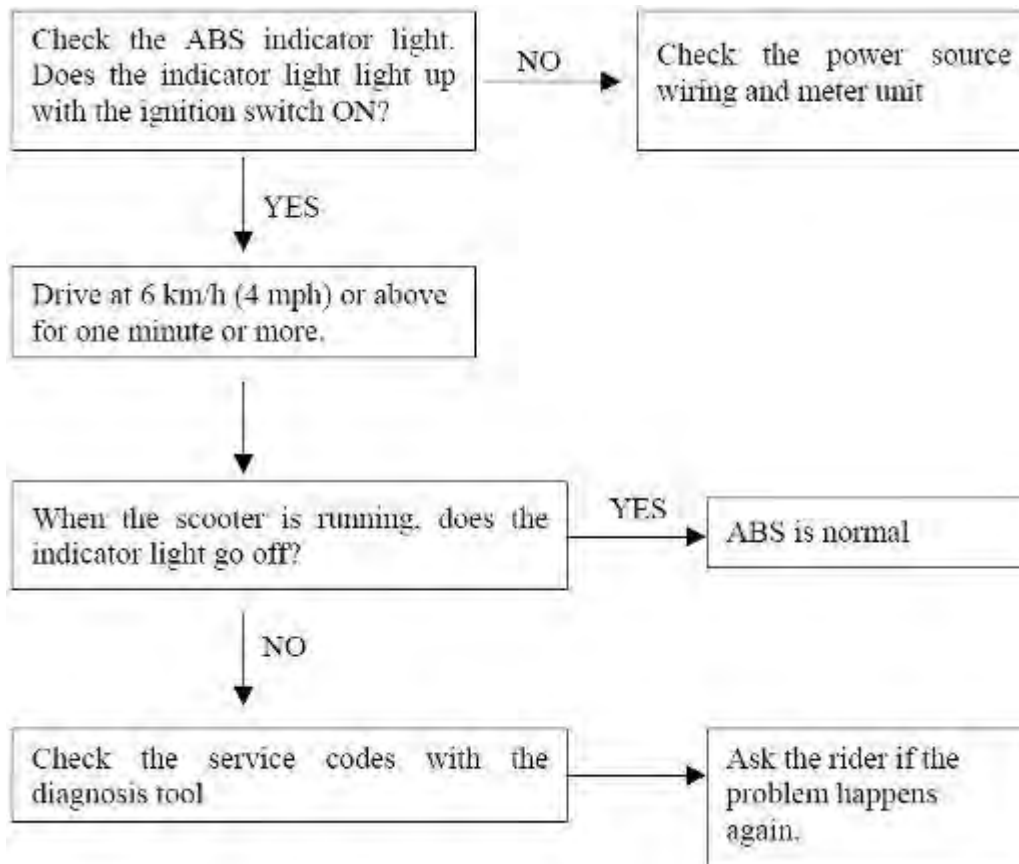

Meter Instruments (For models equipped with ABS)

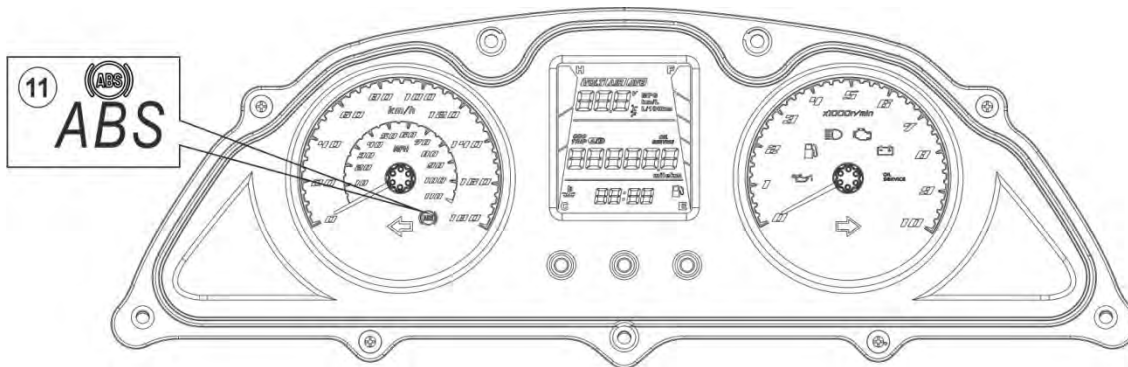

The ABS indicator light is on the right side of the meter. This light will come on when the ignition switch is turned on and goes off shortly after the vehicle starts moving. The light stays off as long as the system is ok.

If something is wrong with the ABS the indicator comes on and remains on. When the indicator light is on the ABS doesn't function, but the conventional brake system will still work normally.

ABS Indicator Light Is Unlit (When The Ignition Switch Turned To ON)

1st step test.



Disconnect the meter connector.

Check the terminal voltage between the ABS signal wire (Pink lead) terminal of the meter connector and ground. Turn the ignition switch ON.

Terminal Voltage

Standard: About 8V

If the terminal voltage correct, replace the meter assembly.

2nd step test.

Disconnect the meter connector.

Check for continuity between the ABS signal wire (Pink lead) terminal of the main harness side connector and ground.

If there is the continuity in the lead, replace or repair the main harness.

3rd step test.

Disconnect the ABS hydraulic unit connector.

Check for continuity between the ABS signal wire (Pink lead) terminal of the meter side connector and the ABS signal wire (Pink lead) terminal of the ABS unit side connector. If there is the continuity in the lead, replace the ABS hydraulic unit. If there is not the continuity in the lead, replace or repair the main harness.

ABS Indicator Light lights (When the scooter is running, - no service code)

1st step test.

Disconnect the ABS hydraulic unit connector and meter connector.

Check for continuity between the ABS signal wire (Pink lead) terminal of the meter side connector and the ABS signal wire (Pink lead) terminal of the ABS unit side connector.

If there is the continuity in the lead, replace the ABS hydraulic unit.

If there is not the continuity in the lead, replace or repair the main harness.

Solenoid Valve Inspection (Service Code 13,14,17,18)

1st step test.

Recheck the service code indication: erase the service code, perform the pre-diagnosis inspection 1 and 2. and retrieve the service code.

If the ABS indicator light lit, faulty solenoid valve in the ABS hydraulic unit. Replace the ABS hydraulic unit.

If the ABS indicator light unlit. ABS system is normal.

ABS solenoid valve relay inspection (service code 19)

1st step test.

Check the ABS solenoid valve relay fuse (25A).

Front, Rear Wheel Rotation Difference Abnormal (service code 25)

1st step test.

Check the following and correct the faulty part.

1. Incorrect the tire pressure
2. Tire not recommended for the scooter were installed (incorrect tire size).
3. Deformation of the wheel or tire.
4. Sensor rotor for missing teeth and clogging with foreign matter.

If the all parts are correct move on to the 2nd step.

2nd step test.

Recheck the service code indication: erase the service code, perform the pre-diagnosis inspection 1 and 2, and retrieve the service code.

If the ABS indicator light lit, faulty ECU in the ABS hydraulic unit. Replace the ABS hydraulic unit.

If the ABS indicator light unlit. ABS system is normal.

ABS Motor Relay Inspection (service code 35)

1st step test.

Check the ABS motor relay fuse (25A).

Front Wheel Rotation Sensor Signal Abnormal (service code 42)

1st step test.

Measure the clearance between the front wheel rotation sensor and sensor rotor.

Standard: 1 mm (0.04 in.)

If the measurement is over standard, check each part for deformation and looseness and correct accordingly. Recheck the clearance.

Check that there is iron or other magnetic deposits between the sensor and sensor rotor, and the sensor rotor slots for obstructions.

Check the installation condition of the sensor for looseness.

Check the sensor and sensor rotor tip for deformation or damage (example chipped sensor rotor teeth).

Front Wheel Rotation Sensor Wiring Inspection (service code 43)

1st step test.

Disconnect the ABS hydraulic unit connector and front wheel sensor connector.

Short the white/brown and red-green lead terminals of the main harness side connector with a jumper lead, and check for continuity between the white/brown and red green lead terminals of the main harness side connector.

If there is not the continuity in the lead, replace the rear wheel rotation sensor.

Rear Wheel Rotation Sensor Wiring Inspection (service code 44)

1st step test.

Measure the clearance between the rear wheel rotation sensor and sensor rotor.

Standard: 1 mm (0.04 in.)

If the measurement is over standard, check each part for deformation and looseness and correct accordingly. Recheck the clearance.

Check that there is iron or other magnetic deposits between the sensor and sensor rotor, and the sensor rotor slots for obstructions.

Check the installation condition of the sensor for looseness.

Check the sensor and sensor rotor tip for deformation or damage (example chipped sensor rotor teeth).

Rear Wheel Rotation Sensor Wiring Inspection (service code 45)

1st step test.

Disconnect the ABS hydraulic unit connector and rear wheel sensor connector.

Short the light-blue/brown and black/red lead terminals of the main harness side connector with a jumper lead, and check for continuity between the light-blue brown and black/red lead terminals of the main harness side connector.

If there is not the continuity in the lead, replace the rear wheel rotation sensor.

Power Supply Voltage Abnormal (under-voltage) (service code 52)

1st step test.

Disconnect the ABS diagnosis connector and ABS hydraulic unit connector.

Check for continuity for the black lead terminal of the main harness side connector.

2nd step test.

Connect the ABS diagnosis connector and ABS hydraulic unit connector.

Check the battery terminal voltage, connect the diagnosis tool to the ABS diagnosis connector.

Turn the ignition switch ON.

Battery terminal voltage
Standard: 9.6V or more

3rd step test.

Inspect the following parts.

Battery, ignition switch, main harness and main fuse 10A.

4th step test.

Recheck the service code indication: erase the service code, perform the pre-diagnosis inspection 1 and 2, and retrieve the service code.

If the ABS indicator light lit, faulty ECU in the ABS hydraulic unit. Replace the ABS hydraulic unit.

If the ABS indicator light unlit, ABS system is normal.

Power Supply Voltage Abnormal (over-voltage) (service code 53)

1st step test.

Disconnect the ABS diagnosis connector and ABS hydraulic unit connector.

Check for continuity for the black lead terminal of the main harness side connector.

2nd step test.

Connect the ABS diagnosis connector and ABS hydraulic unit connector.

Check the battery terminal voltage, connect the diagnosis tool to the ABS diagnosis connector.

Turn the ignition switch ON.

Battery terminal voltage

Standard: 16.6V or less

3rd step test.

Inspect the following parts.

Battery, ignition switch, main harness and main fuse 10A

4th step test.

Recheck the service code indication; erase the service code, perform the pre-diagnosis inspection 1 and 2, and retrieve the service code.

If the ABS indicator light lit, faulty ECU in the ABS hydraulic unit. Replace the ABS hydraulic unit.

If the ABS indicator light unlit. ABS system is normal.

ECU Inspection (service code 55)

1st step test.

Recheck the service code indication; erase the service code, perform the pre-diagnosis inspection 1 and 2, and retrieve the service code.

If the ABS indicator light lit, faulty ECU in the ABS hydraulic unit. Replace the ABS hydraulic unit.

If the ABS indicator light unlit, ABS system is normal.

ABS Diagnostic Tool



Connect the diagnostic tool and set the ECU to the ABS. See the [Diagnostic Tool](#) topic for more information.



Check and clear the ABS DTCs in the same manner as the fuel injection DTCs.

Bosch ABS9m DTC LIST		
Code NO (Diagnostic Tool 3620A-LEB2-E00)	DTC (PDA)	description
01	5013	Rear Inlet Valve malfunction (EV)
02	5014	Rear Outlet Valve malfunction (AV)
03	5017	Front Inlet Valve malfunction (EV)
04	5018	Front Outlet Valve malfunction (AV)
05	5019	Valve Relay malfunction (Failsafe relay)
06	5025	Deviation between Wheel speeds (WSS_GENERIC)
07	5035	Pump Motor Malfunction
08	5042	Front wheel speed sensor malfunction-Plausibility
09	5043	Front wheel speed sensor Disconnection/gnd Short/Battery Voltage Short
10	5044	Rear wheel speed sensor malfunction - Plausibility
11	5045	Rear wheel speed sensor Disconnection/gnd Short/Battery Voltage Short
12	5052	Power Supply Malfunction (Under Voltage)
13	5053	Power Supply Malfunction (Over Voltage)
14	5055	ECU malfunction



When using the DATA Analyze feature of the diagnostic tool with the ABS system the front and rear wheel speed sensors should show speed when the wheels are rotated.



Inspect the wheel speed sensors, rotors, wires, and connectors if the speed doesn't show correctly.



Check the speed sensor to rotor clearance with a feeler gauge and make sure that it is 0.3 - 1.2 mm (0.0012 - 0.048 in).

ABS Unit

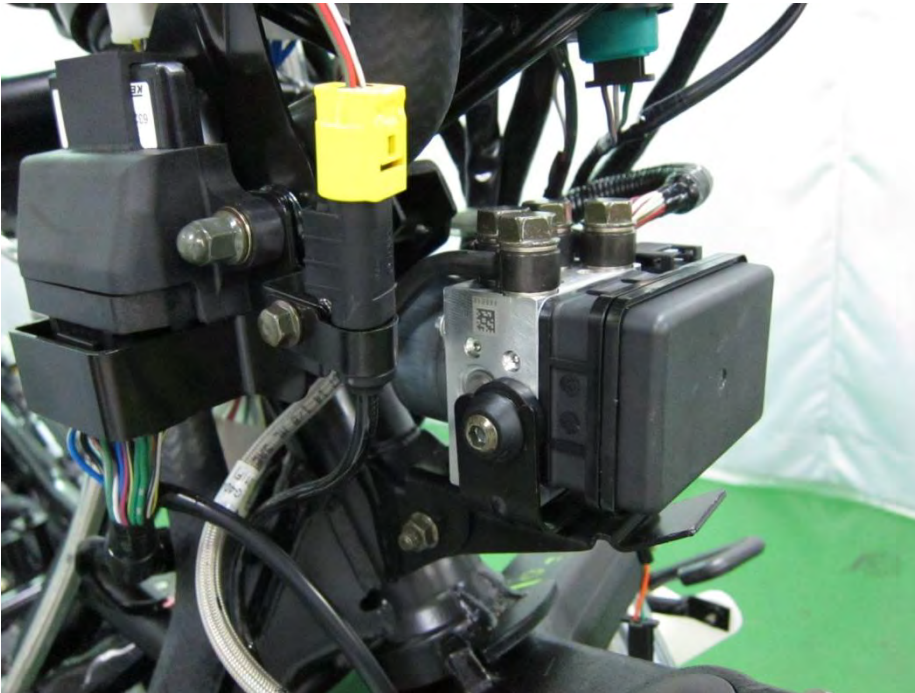

Note the markings on the ABS unit for the brake Front (F) and Rear (R) brake hose positions.

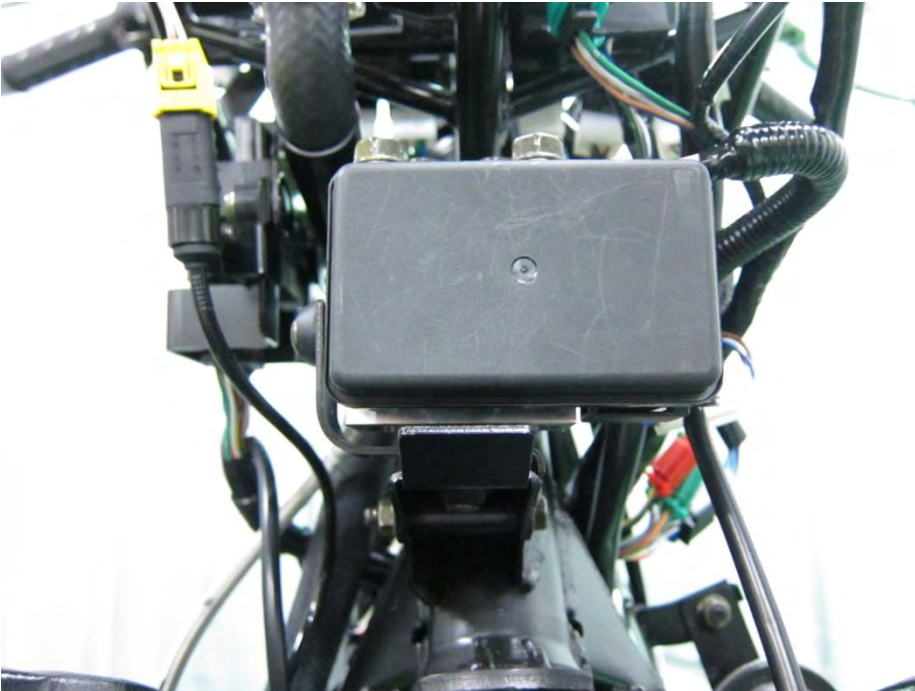

Do not attempt to disassemble the ABS unit.

If the ABS unit must be replaced the new unit should come filled with brake fluid. Install the new component immediately so that the brake fluid doesn't drain out.

11.Steering

This chapter covers the location and servicing of the steering components for the KYMCO Downtown 350i model.

Handlebar	11-2
Grips	11-8
Steering stem	11-8

TROUBLESHOOTING

Hard steering (heavy)

- Excessively tightened steering stem top cone race
- Broken steering balls
- Insufficient tire pressure

Steers to one side or does not track straight

- Uneven front shock absorbers
- Bent front fork
- Bent front axle or uneven tire

Handlebar

SAFETY FIRST: Protective gloves and eyewear are recommended at this point.

Removal

Remove the handlebar covers. See the [Handlebar Covers](#) topic for more information.

Remove the front cover. See the [Front Cover](#) topic for more information.

Bar Ends

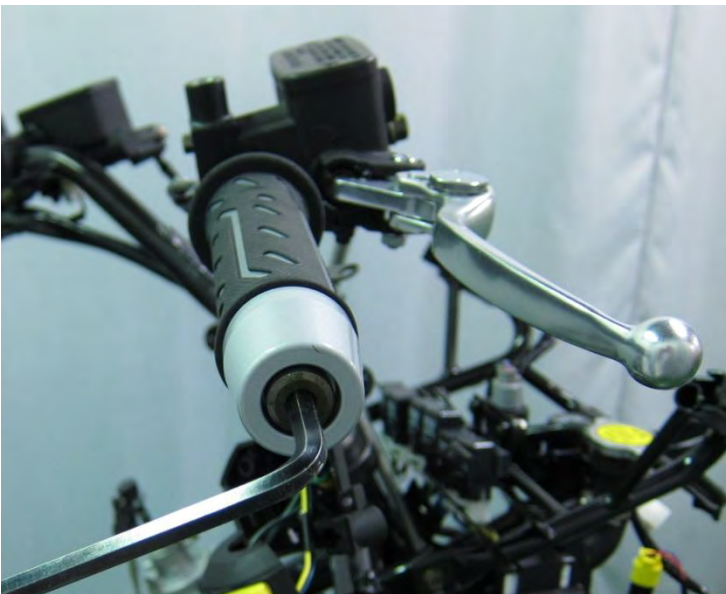

Remove the bar ends with a 6 mm Allen.

To remove the brake master cylinders see the [Master Cylinders](#) topic.

Switch Housings and Throttle



Remove the two right switch housing mounting screws with a #2 Phillips screwdriver. Disconnect the switch.

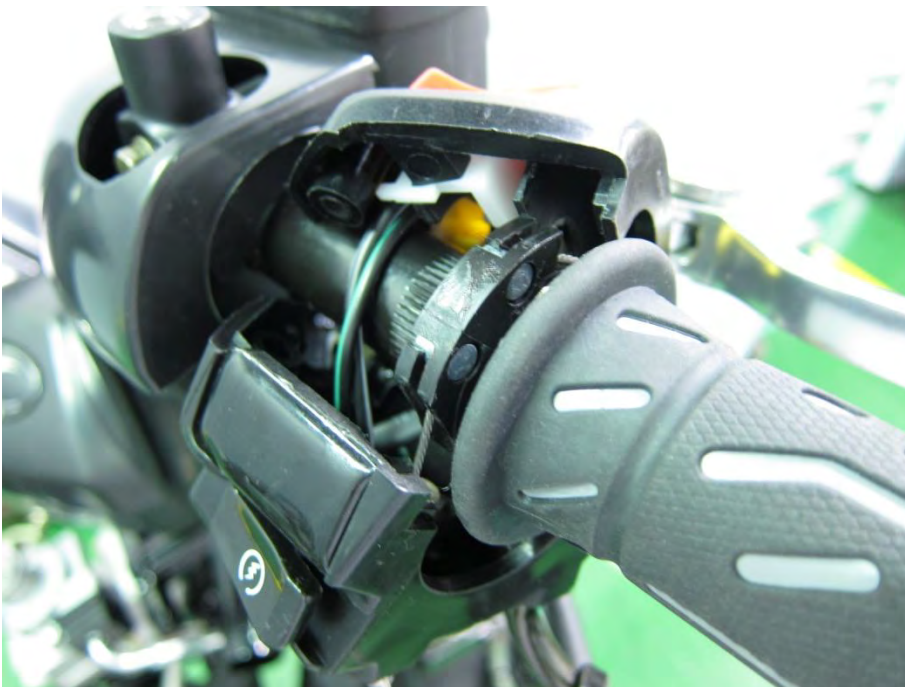

Separate the switch housing from the handlebar.

Disconnect the throttle cables and free the right switch housing from the handlebar.



Slide off the throttle grip.



Remove the two left switch housing mounting screws with a #2 Phillips screwdriver.



Disconnect the switch. Separate the left switch housing from the handlebar.

Handlebar



Route the cables and lines from the handlebar cable guide.



Hold the handlebar lock bolt with a 14 mm wrench and loosen the nut with a 17 mm socket.



Remove the handlebar lock nut and bolt.



Remove the handlebar.
The torque of installation.

Item	Torque	
	N-m	lb-ft
Handlebar Lock Nut	45	32

Grips



If you plan to replace the grips you can slice them lengthwise with a razor blade and peel them off. To remove the grips without cutting them use a screwdriver to open a gap between the grip and the handlebar. Spray in contact cleaner to break up the grip cement. Use compressed air to expand the grip so it can be easily slid off the end of the handlebar. Note the relationship between the angle of the grip and the throttle tube so that the new grip can be installed with the correct angle.

NOTE: Always wear safety glasses when using compressed air and never point it directly at yourself or anyone else.

Before installing the grips to either the throttle tube or the handlebar, wipe down the area with a brake or parts cleaner that will dry without leaving a residue. When you are sure the area is dry apply grip cement to the bar or tube. Install the left grip at an angle of your preference. Install the throttle grip onto the tube with the same angle as the original grip.

Steering Stem Removal

SAFETY FIRST: Protective gloves and eyewear are recommended at this point.



Support the vehicle with a suitable stand or jack so that the front wheel is off the ground. Grip the bottom of the fork legs and turn the front end side-to-side. If the movement is rough the bearings should be greased or replaced. If the movement is too tight or loose the steering stem adjusting nut may need to be adjusted.

The KYMCO Downtown 350i uses ball bearings in the steering. Always replace the races at the same time as the bearings.

Remove the handlebar covers. See the [Handlebar Covers](#) topic for more information.

Remove the front cover. See the [Front Cover](#) topic for more information.
Remove the handlebar. See the [Handlebar](#) topic for more information.

Remove the front fender. See the [Front Fender](#) topic for more information.

Remove the front wheel. See the [Front Wheel](#) topic for more information.

Remove the front fork. See the [Front Fork Removal and Installation](#) topic for more information.

A special lock nut wrench is needed to loosen the steering stem lock nut.
 Special Tool - Lock Nut Wrench: F00002



Slide the special tool over the steering stem and loosen the lock nut.

Installation torque

Item	Qty	Thread size (mm)	Torque	
			kgf-m	lb-ft
Steering Stem lock nut	1	BC1	6.0-8.0	43.40-57.86



Remove the steering stem lock nut.
Slide off the lock washer.



Support the steering stem and loosen the steering stem adjusting nut.



Remove the steering stem adjusting nut.

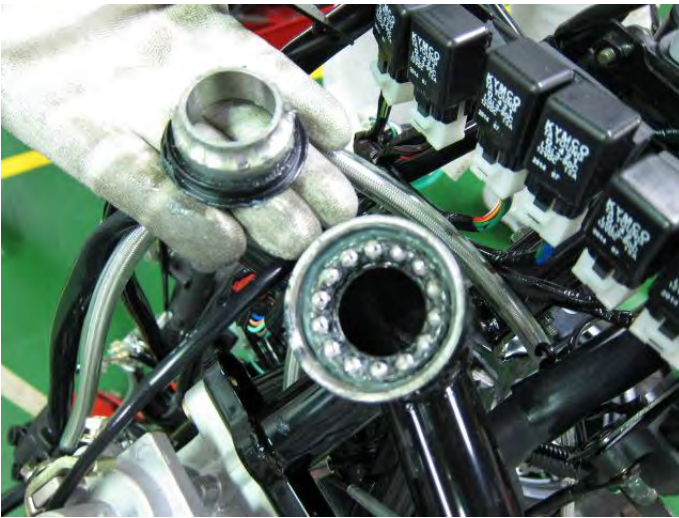
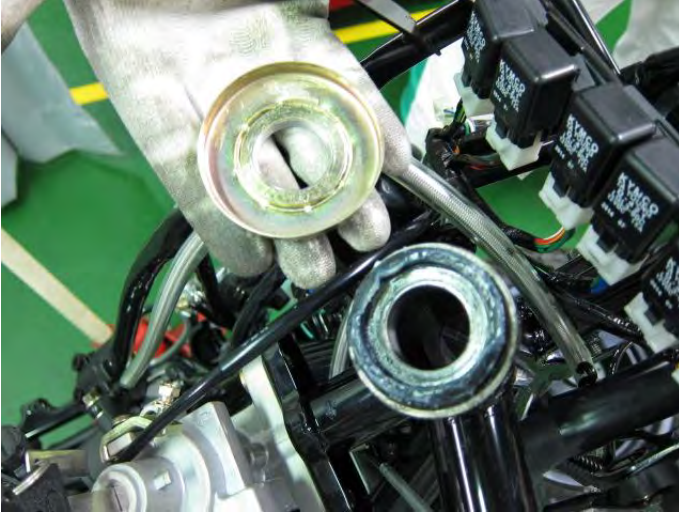

Remove the dust cover and grease seal.



Lower the steering stem out of the frame.

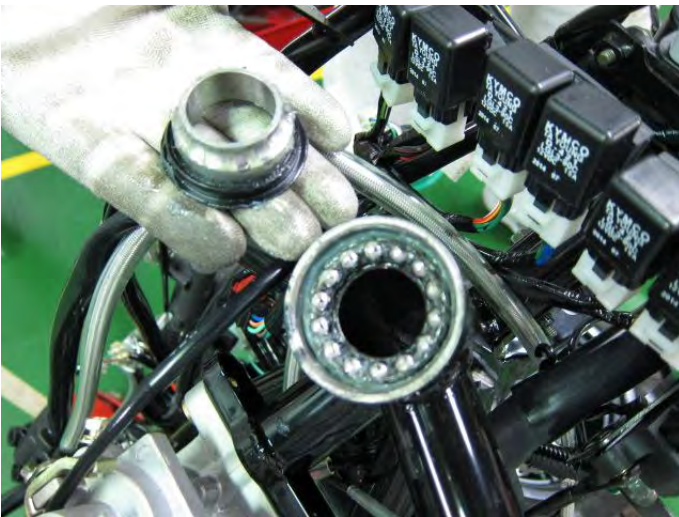

Lift out the upper ball bearings.



Slide the lower ball bearings up and off of the steering stem. Inspect the bearings and races for wear and damage. Replace them as needed.



Use a chisel to remove the bottom bearing inner race and dust seal. Do not damage the steering stem.



Use the special tools or a drift and hammer to drive out the bearing races in the steering head.



Have the drift set against the lip of the race, and work around the race evenly to drive it out. Repeat the process with the remaining bearing race.

To install the steering stem bearings and stem see the [Steering Stem Installation](#) topic.

12.Front Suspension

This chapter covers the location and servicing of the front fork components for the KYMCO Downtown 350i model.

<u>Front Fork Removal</u>	12-2
<u>Front Fork Installation</u>	12-6
<u>Fork Disassembly</u>	12-8
<u>Fork Assembly</u>	12-17

TROUBLESHOOTING

Soft front shock absorber

- Weak shock springs
- Insufficient damper oil

Front shock absorber noise

- Slider bending
- Loose fork fasteners
- Lack of lubrication

Front Fork Removal and Installation

SAFETY FIRST: Protective gloves and eyewear are recommended at this point.

Removal

Remove the front cover. See the [Front Cover](#) topic for more information.

Remove the front fender. See the [Front Fender](#) topic for more information.



Remove the screw and loosen the brake pad pin with a 5 mm Allen.



Remove the two caliper mounting bolts with a 12 mm socket.
And remove the front caliper.



Remove the speedometer sensor mounting bolt with an 8 mm socket.
And remove the speedometer sensor.



Remove the front wheel speed sensor from the bottom of the right fork leg. Remove the front brake caliper. See the [Front Caliper](#) topic for more information. Remove the front wheel. See the [Front Wheel](#) topic for more information.



Remove the speed sensor wire and front brake hose guide mounting bolt with an 8 mm socket. Free the guide from the fork clamp.



Loosen the fork clamp pinch bolts with a 12 mm socket. The top bolts must be removed.



Slide the forks legs down and out of the fork clamp using a twisting motion. To disassemble the forks see the [Fork Disassembly](#) topic for more information.

Installation



Slide the fork legs up into fork clamp using a twisting motion.



Install the fork legs so that the upper fork clamp bolt hole lines up with the groove on the inner fork tube. Insert the fork clamp upper bolt.

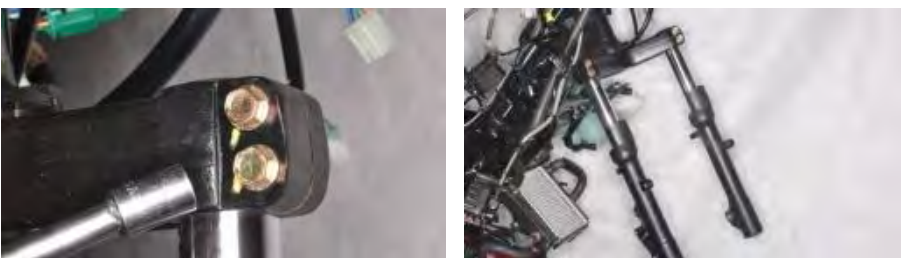

Tighten the fork clamp bolts securely and evenly with a 12 mm socket.



Install the speed sensor wire and front brake hose guide to the fork clamp. Insert the guide mounting bolt and tighten it to specification with an 8 mm socket.

Item	Qty	Thread size (mm)	Torque	
			kgf-m	lb-ft
Speed sensor cable	1	6	1.0-1.4	7.23-10.13

Install the front wheel. See the [Front Wheel](#) topic for more information.

Install the front brake caliper. See the [Front Caliper](#) topic for more information.



Fit the front wheel speed sensor into place on the right fork leg. Insert the bolt and tighten it to specification with an 8 mm socket.

Install the front fender. See the [Front Fender](#) topic for more information.

Install the front cover. See the [Front Cover](#) topic for more information.

Fork Disassembly

SAFETY FIRST: Protective gloves and eyewear are recommended at this point.

Remove the front forks. See the [Front Fork Removal and Installation](#) topic for more information.



Clean the outside of the forks before disassembly and inspect them for any cracks, dents or other damage.



Slide off the fork protectors.



Remove the rubber fork cap.



Place the fork leg in a soft jawed vice.

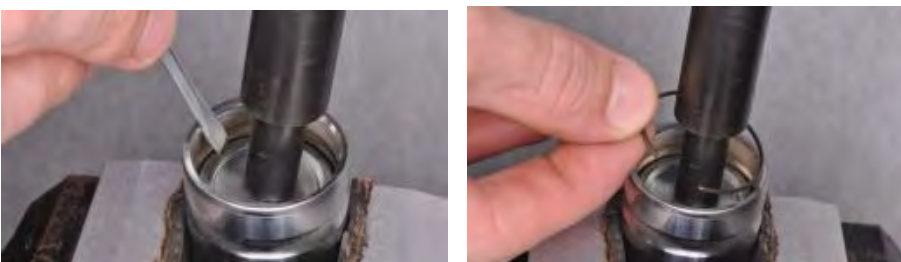

Push down on the top plug and remove the snap ring.



Remove the top plug.

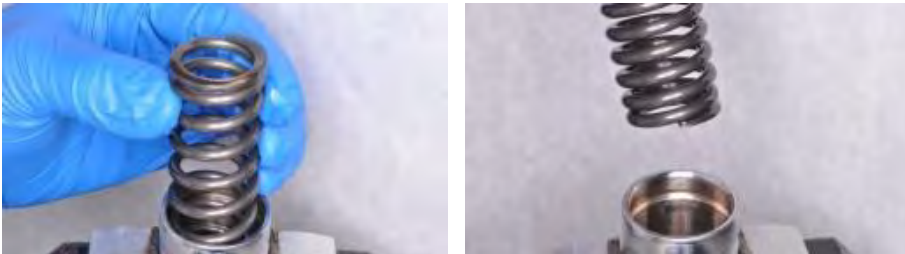

Lift out the fork spring.

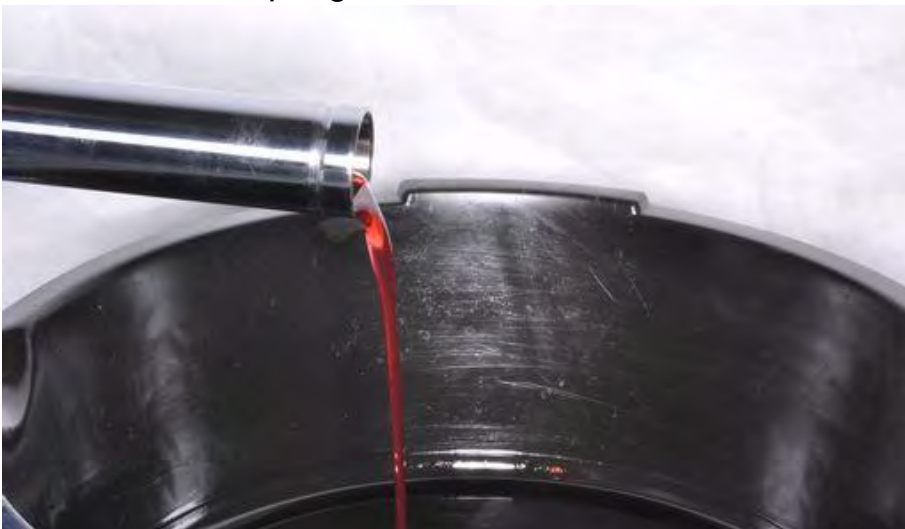

Dump the fork oil into a suitable container. Pump the fork through its stroke several times to free as much oil as possible. Hold the fork inverted for several minutes to let the oil drain completely.



Use a flat blade screwdriver to pop the dust seal out of the fork slider. Take care to avoid scratching the fork tube.



Use a small flat blade screwdriver to pry out the fork oil seal stopper ring. Take care to avoid scratching the fork tube.



Slide off the stopper ring.



Place the axle holder of the outer fork tube in a soft jawed vise.



Insert an 8 mm Allen socket into the damper rod. Hold the damper rod and loosen the fork bottom bolt with an 8 mm Allen wrench.



Remove the fork bottom bolt from the bottom of the fork slider. Discard the sealing washer.



Separate the inner and outer fork tubes by pulling them apart using a slide hammer motion.



Remove the oil lock piece. The oil lock piece may come out with the damper rod in the inner fork tube or it may be left in the slider.



Remove the damper rod and rebound spring.



Inspect the oil seal and the bushing in the fork slider.



Place a rag across the top of the fork slider and pry out the oil seal as shown.



Remove the oil seal and spacer from the fork slider.

Inspection



Inspect the top plug O-ring and replace it if needed.



Inspect the slider bushing and replace it as needed.



Inspect the fork springs for signs of fatigue. Replace the fork springs if they vary dramatically in length.



Inspect the damper rod and seal. Replace the components as needed.



Inspect the inner fork tube for bends and damage. Replace it as needed. For assembly see the [Fork Assembly](#) topic.

Fork Assembly

SAFETY FIRST: Protective gloves and eyewear are recommended at this point.

Clean all of the fork components with aerosol brake cleaner and a lint free cloth. Coat the bushing and seals with fork oil before installation.



Drive the fork slider bushing into the slider with a suitable driver with the same outside diameter as the bushing.



Insert the damper rod with rebound spring into the inner fork tube. Place the fork oil lock piece on the end of the damper rod.

Slide the dust seal, oil seal stopper ring and oil seal onto the bottom of the inner fork tube.

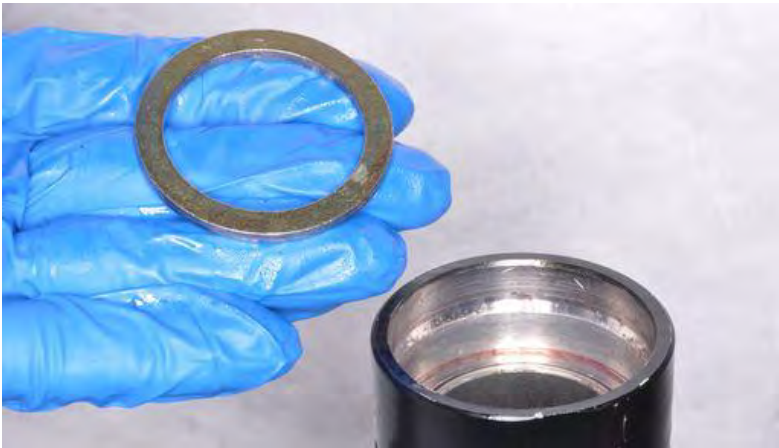

Place the spacer into the fork slider.



Insert the inner fork tube into the outer fork tube.



Place a new sealing washer on the fork bottom bolt. Insert the fork bottom bolt into the bottom the fork slider and thread it into the damper rod.



Place the axle holder of the outer fork tube in a soft jawed vise.



Insert an 8 mm Allen socket into the damper rod. Hold the damper rod and tighten the fork bottom bolt securely with an 8 mm Allen wrench.



Drive in the fork oil seal with the fork seal driver.



Insert the stopper ring into its groove.

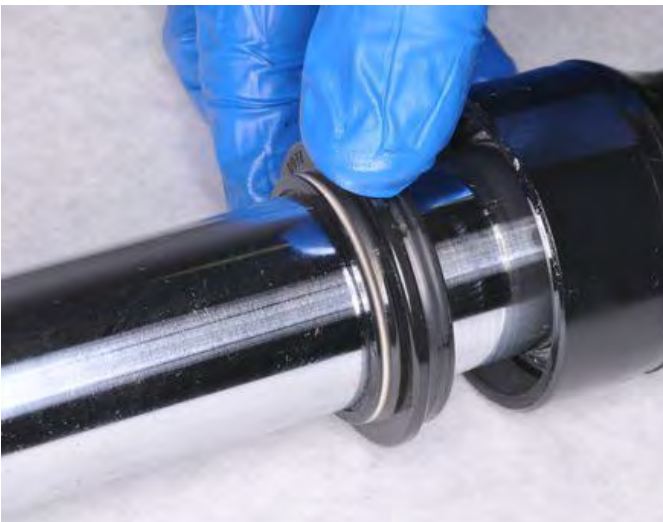

Install the dust seal securely into the outer fork tube.



Compress the fork tube all the way. Fill the fork tube with the specified quantity of fork oil 185 cc or 6.26 US oz. Use fork oil type SS#8 (10W).

Pump the fork slowly through its stroke several times to release any trapped air.



Fully extend the fork and insert the fork spring with its tightly coiled end facing down towards the axle.



Lubricate the top plug O-ring with fresh fork oil and insert the plug into the top of the inner fork tube as shown.



Push the top plug down against the spring and install the stopper ring into its groove. Release the pressure on the top plug and make sure the plug seats against the ring.



Install the rubber fork cap.



Fit the fork protectors into place so that they face forward.

Install the front fork. See the [Front Fork Removal and Installation](#) topic for more information.

13.Rear Suspension

This chapter provides information on the rear suspension components of the KYMCO Downtown 350i model.

<u>Shock Absorbers</u>	13-2
Rear Fork	13-8

TROUBLESHOOTING

Soft rear shock absorber

- Weak shock absorber spring
- Damper oil leaks

Shock Absorbers

SAFETY FIRST: Protective gloves and eyewear are recommended at this point.

Pre-Load Setting



Each shock absorber on the scooter has 5 spring preload adjustment positions for different load or riding conditions.

Position 1 is for light loads and smooth road conditions. Position 3 to 5 increase spring preload for stiffer rear suspension and can be used when the scooters heavily loaded. Be certain to adjust both shock absorbers to the same spring preload positions.

Use a pin spanner to adjust the rear shock spring preload. The shock absorbers are adjustable for pre-load. There are 5 settings. Position 1 is the softest and 5 is the stiffest.

Caution: Always adjust the shock absorber pre-load position in sequence (1-2-3-4-5 or 5-4-3-2-1). Attempting to adjust directly from 1 to 5 or 5 to 1 may damage the shock absorber.

(Pre-Load Standard Setting: Position 3)

Removal

Place the vehicle on its center stand.

Remove the seat. See the [Seat](#) topic for more information.

Remove the luggage box. See the [Luggage Box](#) topic for more information.

Remove the rear carrier. See the [Rear Carrier](#) topic for more information.

Remove the body cover to access the upper shock absorber mounts. See the [Body Cover](#) topic for more information.



Remove the right side rear shock mounting bolt with a 14 mm socket.

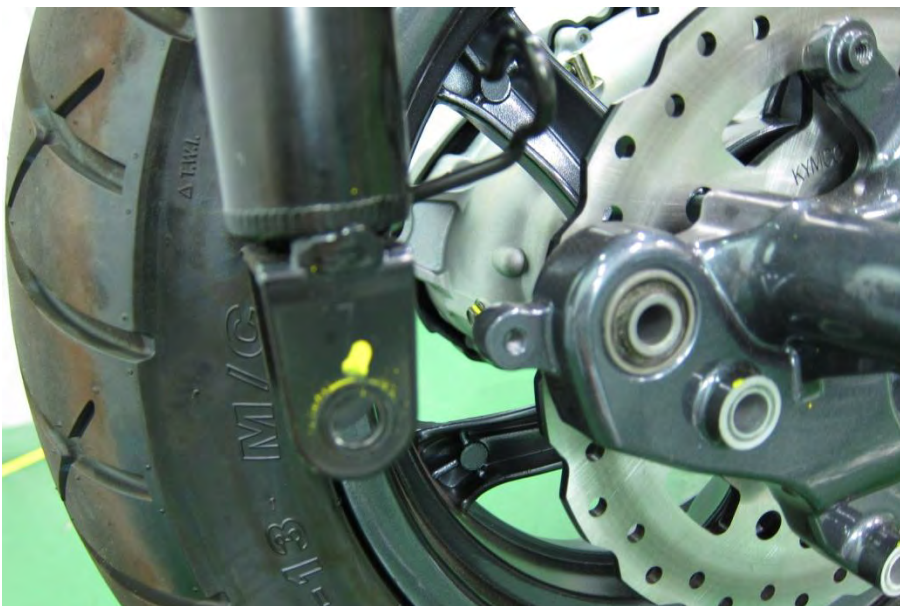

Free the lower mount of the rear shock.

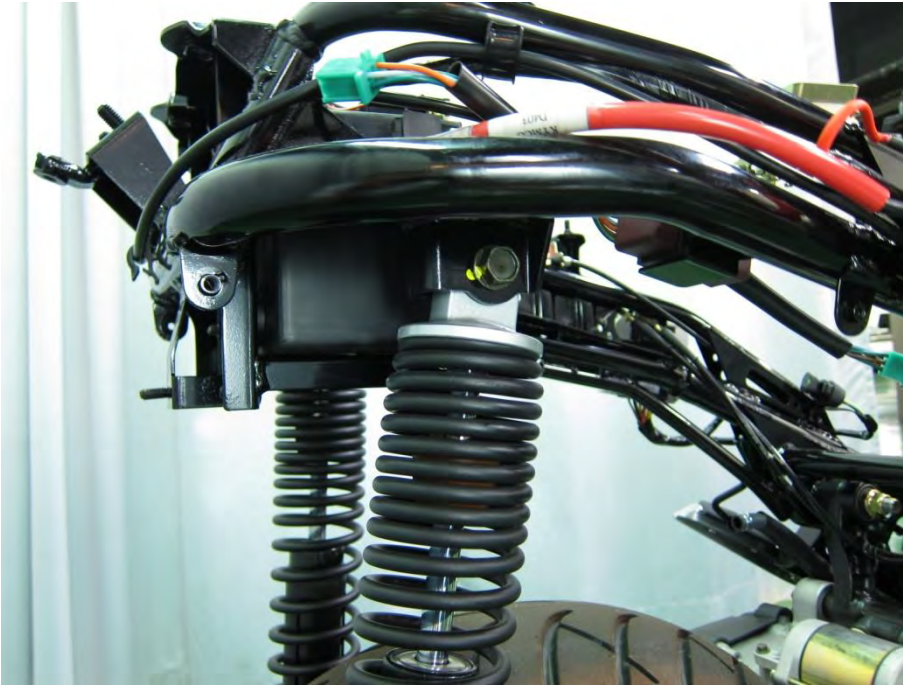

Remove the upper shock absorber mounting bolt with a 12 mm socket. Free the shock absorber from the frame.

Remove the left shock absorber in the same manner as the right.

Inspect the shock absorbers for wear and damage. Replace the shock absorbers as needed.

Check over the shock absorber for damage and oil leaks. Replace the shock absorber if needed. Do not attempt to disassemble the shock absorber.

Installation

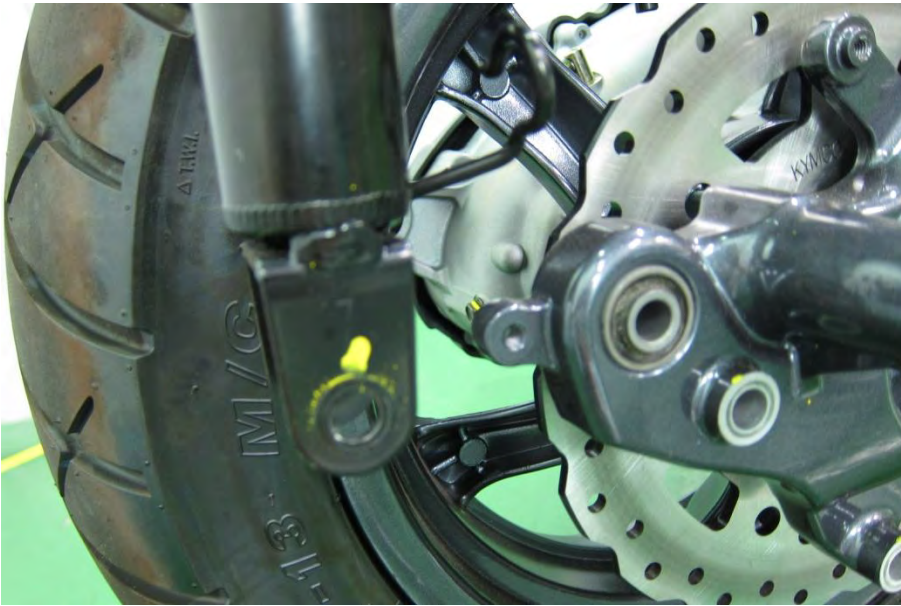

Fit the shock absorber into place. Make sure the preload arrow indicator faces out from the lower mount.



Install the upper shock absorber mounting bolt and torque it to specification with a 12 mm socket.

Item	Torque	
	kgf-m	lb-ft
Shock absorber mounting bolt	4	28.93



Install the lower shock absorber mounting bolt and torque it to specification with a 12 mm socket.

Item	Torque	
	kgf-m	lb-ft
Shock absorber mounting bolt	4	28.93

Install the other shock absorber in the same manner.

Install the rear carrier. See the [Rear Carrier](#) topic for more information.

Install the luggage box. See the [Luggage Box](#) topic for more information.

Install the seat. See the [Seat](#) topic for more information.

Rear Fork

SAFETY FIRST: Protective gloves and eyewear are recommended at this point.

Removal

Place the vehicle on its center stand.

Remove the muffler. See the [Exhaust System](#) topic for more information.

Remove the rear fender. See the [Rear Fender](#) topic for more information.



Remove the right side rear shock mounting bolt with a 14 mm socket.



Hold the rear brake to keep the rear wheel from turning. Remove the rear axle nut with a 24 mm socket.



Remove the rear brake caliper. See the [Rear Brake Caliper](#) topic for more information.

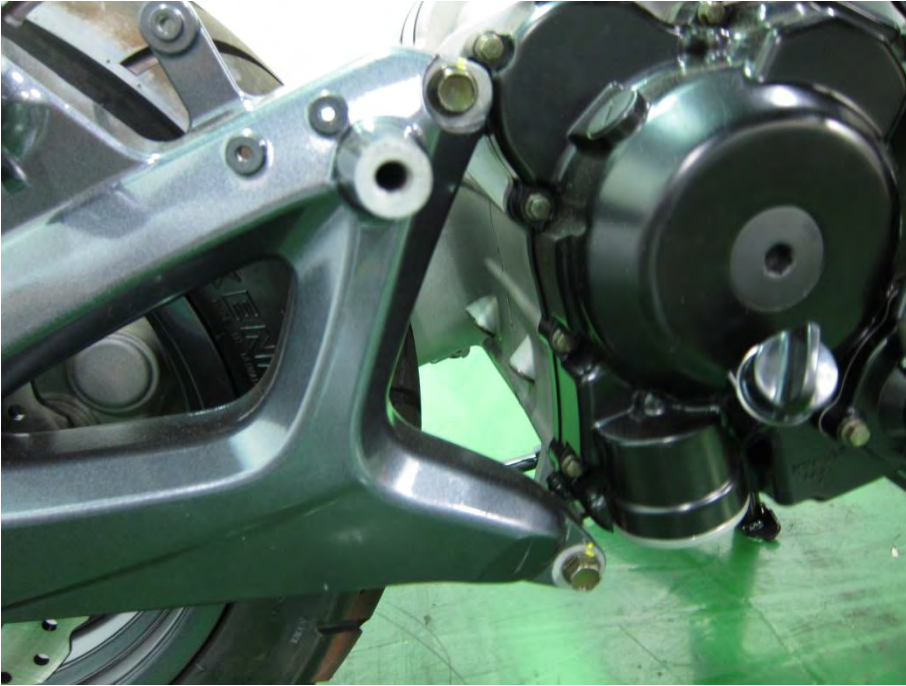

Remove the two rear fork bolts with a 14 mm socket.



Slide the rear fork out and remove it from the right side of the vehicle.

Inspect the rear fork for damage and replace it as needed.

Installation



Fit the rear fork into place.

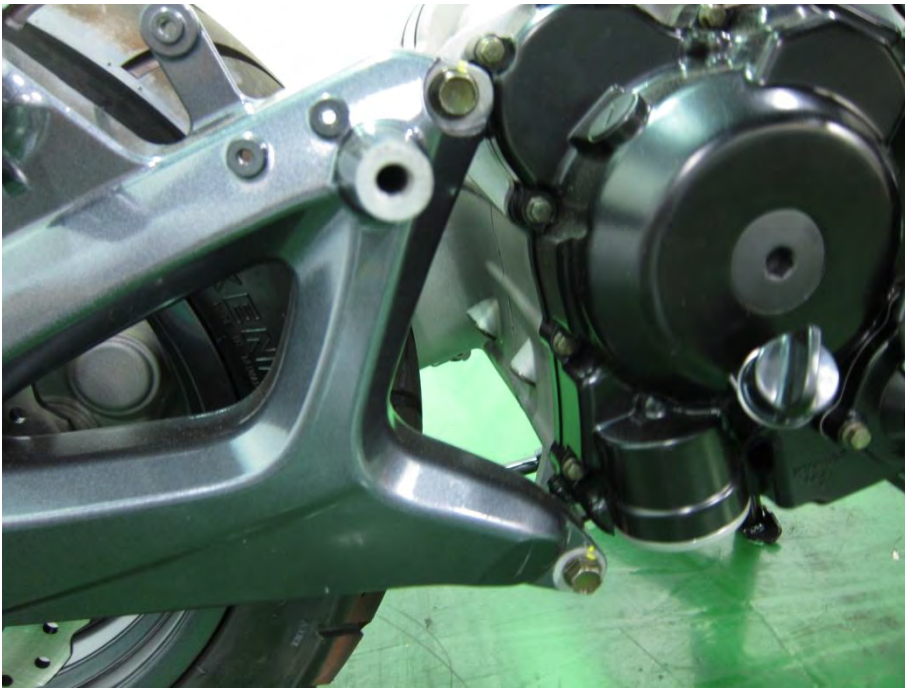

Install the two rear fork mounting bolts and tighten them securely with a 14 mm socket.



Install the rear axle nut and tighten it to specification with a 24 mm socket.

Item	Qty	Thread size (mm)	Torque		Remarks
			kgf-m	lb-ft	
Rear axle nut	1	16	11-13	79.56-94.03	U-nut

Install the rear brake caliper. See the [Rear Brake Caliper](#) topic for more information.

Install the rear fender. See the [Rear Fender](#) topic for more information.



Install the lower shock absorber mounting bolt and torque it to specification with a 12 mm socket.

Item	Torque	
	kgf-m	lb-ft
Shock absorber mounting bolt	4	28.93

Install the muffler. See the [Exhaust System](#) topic for more information.

14.Wheels

This chapter covers the location and servicing of the wheels for the KYMCO Downtown 350i model.

<u>Bearing Replacement</u>	14-2
<u>Front Wheel</u>	14-6
<u>Rear Wheel</u>	14-11
<u>Wheel Inspection</u>	14-19
<u>Wheel Specifications</u>	14-21

Troubleshooting

Front wheel wobbling

- Bent rim
- Loose front axle
- Bent spoke plate
- Faulty tire
- Improperly tightened axle nut

Rear wheel wobbling

- Bent rim
- Faulty tire
- Axle not tightened properly

Rear wheel noise

- Worn rear wheel axle bearings
- Worn rear fork bearings
- Deformed rear fork

Wheel Bearing Replacement

SAFETY FIRST: Protective gloves and eyewear are recommended at this point.

Replace bearings as a set, and do not reuse old bearings.

Place the new bearings in the freezer about an hour before you plan to install them.

Do not let the wheel rest on its brake disc. To remove the Brake discs see the [Disc Brake](#) topic.

Front Wheel



Remove the dust seal from the right side of the front wheel using a seal pick or large flat blade screwdriver. Discard the dust seal, it should be replaced by a new item.



Inspect the wheel bearings by turning them in the hub. If the bearings have excessive play in them or are rough replace all the bearings for that wheel.



Remove one of the bearings with a bearing puller.

Special Tools- Bearing Puller: E00037



Remove the distance collar.



Repeat the procedure and remove the other bearing and seal. The seal should be replaced with a new item.



Heat the bearing area of the wheel with a heat gun, take the bearing out of the freezer and install it. You can use a bearing installer tool or a socket with the same outside diameter as the bearing. Make sure the bearing is fully seated and the marked side is facing out.

Special Tools-Bearing Installer: E00014



Insert the distance collar into the hub.



Drive in the other bearing. The bearing should fit against the distance collar. Do not continue to force the bearing in or the distance collar will begin to push the right bearing back out.



Apply grease to the lips of the dust seals. Drive in new dust seals.

Front Wheel

SAFETY FIRST: Protective gloves and eyewear are recommended at this point.

Removal



Loosen the front axle pinch bolt with a 6 mm Allen.



Loosen the front axle with an 8 mm Allen socket.



Lift the front end of the vehicle with a suitable stand or jack so that the front wheel comes off of the ground.



Support the front wheel and slide the front axle out from the left side.



Guide the front wheel out from the fork legs and the brake disc out from between the pads. Do not squeeze the brake lever while the disc is not present between the pads.

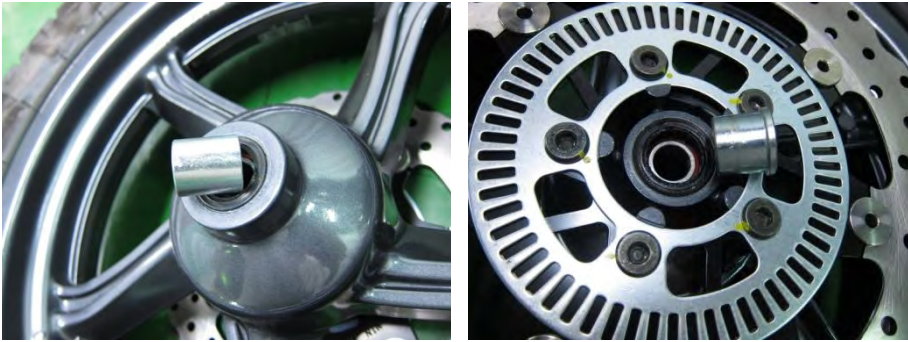

Remove the collars from each side of the wheel. Inspect the bearing seals and the O-rings seals on the collars. Replace the seals if they are in poor condition.

Inspect the wheels and axle. See the [Wheel Inspection](#) topic for more information.

Inspect the wheel bearings by turning them in the hub. If the bearings have play in them or are rough replace all the bearings for that wheel. See the [Wheel Bearing Replacement](#) topic for more information.

To remove the wheel speed sensor rotor loosen the three bolts with an Allen wrench.

To remove the brake disc see the [Disc Brake](#) topic.

Installation

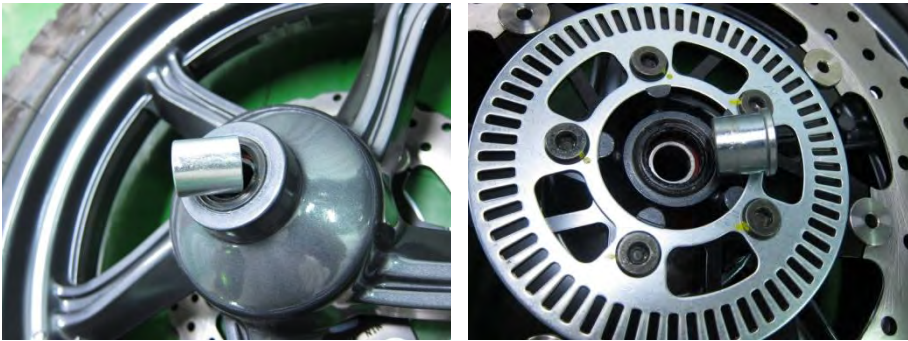

Apply grease to the lips of the dust seals and collar O-rings. Insert the collars into the hub as shown.



Make sure the tire direction of rotation marker is correct. Slide the front wheel into the fork. Fit the brake disc between the brake pads in the front caliper.



Apply a light coat of grease to the front axle. Insert the axle from the left side.

Set the front wheel on the ground. Pump the front suspension up and down several times to seat the front axle



Torque the axle to specification with an 8 mm Allen.

Item	Qty	Thread size (mm)	Torque	
			kgf-m	lb-ft
Front axle	1	14	1.5-2.5	10.84-18.08



Tighten the front axle pinch bolt securely with a 6 mm Allen.

Pump the front brake lever to establish pressure and to seat the pads against the disc. If the Brakes do not pump up correctly check the brake fluid. See the [Brake Fluid](#) topic for more information.

Rear Wheel

SAFETY FIRST: Protective gloves and eyewear are recommended at this point.

- When performing the services stated in this section, the engine and exhaust muffler must be cold to avoid scalding.
- During servicing, keep oil or grease off the brake pads and brake disk.

Removal

Remove the muffler. See the [Exhaust System](#) topic for more information.

Remove the airbox. See the [Airbox](#) topic for more information.

Remove the rear fender. See the [Rear Fender](#) topic for more information.



Remove the right side rear shock mounting bolt with a 14 mm socket.

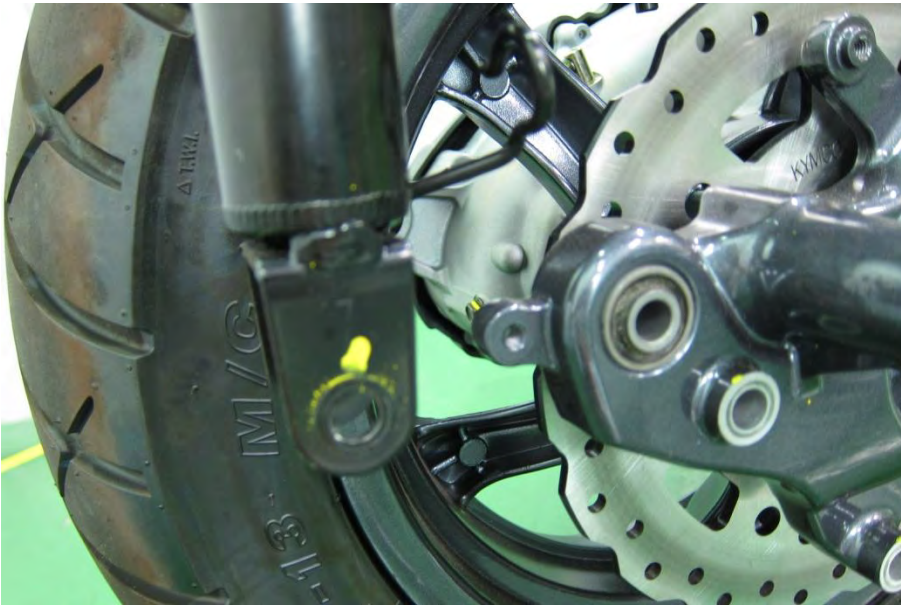

Free the lower mount of the rear shock.

Hold the rear brake to keep the rear wheel from turning. Remove the rear axle nut with a 24 mm socket.

Remove the rear brake caliper. See the [Rear Brake Caliper](#) topic for more information.



Hold the rear brake to keep the rear wheel from turning. Remove the rear axle nut with a 24 mm socket.



Remove the rear brake caliper. See the [Rear Brake Caliper](#) topic for more information.

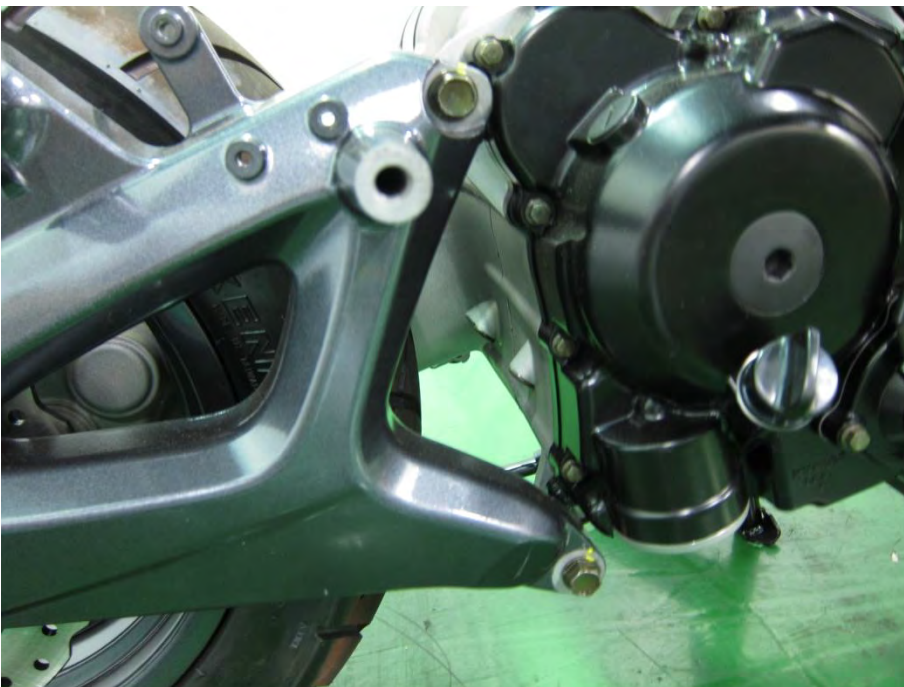

Remove the two rear fork bolts with a 14 mm socket.



Slide the rear fork out and remove it from the right side of the vehicle.



To remove the rear wheel support the right rear shock absorber so that it is out of the way or remove it.

Remove the upper shock absorber mounting bolt with a 12 mm socket. Free the right shock absorber from the frame.

Slide the rear wheel to the right and off of the rear axle.

Inspect the wheel bearings by turning them with a finger. If the bearings have play in them or are rough replace all the bearings for that wheel. See the [Wheel Bearing Replacement](#) topic for more information.

Inspect the rear wheel. See the [Wheel Inspection](#) topic for more information.

Installation



Line up the splines on the rear wheel with those of the rear axle. Slide the rear wheel on to the axle so that the brake disc sits on the right side.

Install the right shock absorber if it was removed. Install the upper mounting bolt and tighten it to specification with a 12 mm socket.

Item	Torque	
	kgf-m	lb-ft
Shock absorber mounting bolt	4	28.93



Slide on the rear axle collar.

Fit the rear fork into place.



Install the two rear fork mounting bolts and tighten them securely with a 14 mm socket.





Install the rear axle nut and tighten it to specification with a 24 mm socket.

Item	Qty	Thread size (mm)	Torque		Remarks
			kgf-m	lb-ft	
Rear axle nut	1	16	11-13	79.56-94.03	U-nut



Fit the shock absorber into place. Make sure the preload arrow indicator faces out from the lower mount.

Install the upper shock absorber mounting bolt and torque it to specification with a 12 mm socket.

Item	Torque	
	kgf-m	lb-ft
Shock absorber mounting bolt	4	28.93



Install the lower shock absorber mounting bolt and torque it to specification with a 12 mm socket.

Item	Torque	
	kgf-m	lb-ft
Shock absorber mounting bolt	4	28.93

Install the rear brake caliper. See the [Rear Brake Caliper](#) topic for more information.

Install the rear fender. See the [Rear Fender](#) topic for more information.

Install the airbox. See the [Airbox](#) topic for more information.

Install the muffler. See the [Exhaust System](#) topic for more information.

Wheel Inspection

SAFETY FIRST: Protective gloves and eyewear are recommended at this point.

Turn the inner race of each bearing with your finger to see if they turn smoothly and quietly. Also check if the outer race fits tightly in the hub.

Replace the bearings if the races do not turn smoothly, quietly, or if they fit loosely in the hub. See the [Wheel Bearing Replacement](#) topic for more information.



Place the wheel on a truing stand and use a dial indicator to check if the rim is out of true. The specifications for the front and rear wheels are the same. Check for lateral wobble. The service limit is 2.0 mm (0.08 in) or less.



Check for radial hop. The service limit is 2.0 mm (0.08 in) or less.



Check the front axle runout. The axle runout specification is half of the total indicator reading.

Replace the axle if the measurement exceeds 0.2 mm or 0.008 in.

Inspect the dust seals and replace them as needed.

Axle/Brakes/Wheels

Item	Standard mm (in)	Service Limit
Axle shaft runout	—	0.2 mm (0.008 in)
Brake disk thickness (front)	3.8 - 4.2 (0.15 - 0.165)	0.3 mm (0.012 in)
Brake disk thickness (rear)	5.0 (0.2)	—
Brake disk runout	—	0.4 mm
Brake master cylinder I.D.	12.7 - 12.74 (0.508 - 0.5096)	—
Brake master cylinder piston O.D.	12.65 - 12.68 (0.506 - 0.5072)	—
Front brake caliper piston O.D.	26.93 - 26.96 (1.0602 - 1.0614)	—
Front brake caliper cylinder I.D.	27 - 27.05 (1.063 - 1.065)	—

Item	Standard (mm)
Wheel rim runout service limit	max 5
Rear brake disk thickness	5.0
Rear brake disk runout	max 0.4
Rear brake caliper piston O.D.	25.33 - 25.36
Rear brake caliper cylinder I.D.	25.40 - 25.45