

SECTION 2 - PERIODIC MAINTENANCE

TABLE OF CONTENTS

Periodic Maintenance Chart	2-2
Periodic Maintenance	2-3
Lubrication Points	2-3
Battery	2-3
Fuses	2-4
Air Filter	2-4
Valve/Tappet Clearance (Feeler Gauge Procedure)	2-6
Valve/Tappet Clearance (Valve Adjuster Procedure)	2-6
Testing Engine Compression	2-7
Spark Plug	2-8
Muffler/Spark Arrester	2-8
Adjusting Throttle Cable	2-9
Engine/Transmission Oil - Filter - Strainer	2-9
Front Differential/Rear Drive Lubricant	2-11
Tires	2-12
Steering Components	2-12
Driveshaft/Coupling	2-12
Suspension/Shock Absorbers/Bushings	2-12
Nuts/Bolts/Cap Screws	2-12
Lights	2-13
Shift Lever	2-15
Frame/Welds/Racks	2-15
Electrical Connections	2-15
Hydraulic Brake Systems	2-15
Burnishing Brake Pads	2-17
Checking/Replacing V-Belt	2-17

Periodic Maintenance Chart

A = Adjust I = Inspect
 C = Clean L = Lubricate
 D = Drain R = Replace
 T = Tighten

Item	Initial Service After Break-In (First Mo or 100 Mi)	Every Day	Every Month or Every 100 Miles	Every 3 Months or Every 300 Miles	Every 6 Months or Every 500 Miles	Every Year or Every 1500 Miles	As Needed
Battery	I		I				C
Fuses				I			R
Air Filter/Drain Tube	I	I	C*				R
Valve/Tappet Clearance	I				I		A
Engine Compression						I	
Spark Plug	I			I			R (4000 Mi or 18 Mo)
Muffler/Spark Arrester					C		R
Gas/Vent Hoses	I	I					R (2 Yrs)
Throttle Cable	I	I			C-L		A-R
Coolant / Cooling System	I		I				R (2 Yrs)
Engine-Transmission Oil Level		I					A
Engine-Transmission Oil/Filter	R			R*			R
Oil Strainer	I				I		C
Front Differential/Rear Drive Lubricant	I		I				R (4 Yrs)
Tires/Air Pressure	I	I					R
Steering Components	I	I		I			R
V-Belt	I				I		R
Suspension (Ball joint boots, drive axle boots front and rear, tie rods, differential and rear drive bellows)	I	I					R
Nuts/Cap Screws/Screws	I		T				A
Throttle Body/EMS Sensor	I				I		C
Lights	I	I					R
Switches	I	I					R
Shift Lever					I		A-L
Handlebar Grips		I					R
Handlebars	I	I					R
Gauges/Indicators	I	I					R
Frame/Welds/Racks	I				I		
Electrical Connections	I				I		C
Complete Brake System (Hydraulic & Auxiliary)	I	I		C			L-R
Brake Pads	I			I*			R
Brake Fluid	I			I			R (2 Yrs)
Brake Hoses	I			I			R (4 Yrs)

* Service/Inspect more frequently when operating in adverse conditions.

Periodic Maintenance

This section has been organized into sub-sections which show common maintenance procedures for the KYMCO ATV.

- **NOTE:** KYMCO recommends the use of new gaskets, lock nuts, and seals and lubricating all internal components when servicing the engine/transmission.
- **NOTE:** Some photographs and illustrations used in this section are used for clarity purposes only and are not designed to depict actual conditions.
- **NOTE:** Critical torque specifications are located in Section 1.

SPECIAL TOOLS

A number of special tools must be available to the technician when performing service procedures in this section.

Description	p/n
Compression Tester Kit	
Oil Filter Wrench	E052
Tachometer	
Valve Clearance Adjuster	E012

- **NOTE:** Special tools are available from the KYMCO Spare Parts Department.

Lubrication Points

It is advisable to lubricate certain components periodically to ensure free movement. Apply light oil to the components using the following list as reference.

- A. Throttle Lever Pivot/Cable Ends
- B. Brake Lever Pivot/Cable Ends
- C. Auxiliary Brake Cable Ends
- D. Shift Lever Cable End

Battery

After being in service, batteries require regular cleaning and recharging in order to deliver peak performance and maximum service life. The following procedure is recommended for cleaning and maintaining lead-acid batteries. Always read and follow instructions provided with battery chargers and battery products.

WARNING

Anytime service is performed on a battery, the following must be observed: keep sparks, open flame, cigarettes, or any other flame away. Always wear safety glasses. Protect skin and clothing when handling a battery. When servicing battery in enclosed space, keep the area well-ventilated.

1. Remove the battery hold-down; then disconnect the battery cables (negative cable first).
2. Remove the battery from the battery compartment;
3. then thoroughly wash the battery and battery compartment with soap and water.

- **NOTE:** If battery posts, cable ends, or the battery case has a build-up of white/green powder residue, apply water and baking soda to neutralize acid; then flush off with warm soapy water.

4. Using a wire brush, clean the battery posts and cable ends removing all corrosive buildup. Replace damaged cables or cable ends.

WARNING

Battery acid is harmful if it contacts eyes, skin, or clothing. Care must be taken whenever handling a battery.

CAUTION

Never use electrolyte (sulfuric acid) to "top off" the battery. Use only distilled water or severe battery damage may occur.

5. Using a multimeter, test the battery voltage. The meter must read 12.5 or more DC Volts for a fully charged battery.
- **NOTE:** At this point, if the meter reads as specified, the battery may be returned to service (see step 10).
6. If the meter reads less than specified voltage, charge the battery using the following guidelines.

A. When using an automatic battery charger, always follow the charger manufacturer's instructions.

B. When using a constant-current battery charger, use the following Battery Charging Chart.

⚠ CAUTION		
Never exceed the standard charging rate.		
⚠ WARNING		
An overheated battery could explode causing severe injury or death. Always monitor charging times and charge rates carefully. Stop charging if the battery becomes very warm to the touch. Allow it to cool before resuming charging.		
Battery Charging Chart (Constant-Current Charger)		
Battery Voltage (DC)	Charge State	Charge Time Required (at 1.5-2.0 Amps)
12.5 or more	100%	None
12.2-12.4	75%-99%	3-6 hours
12.0-12.2	50%-74%	5-11 hours
11.0-11.9	25%-49%	13 hours (minimum)
11.5 or less	0-24%	20 hours (minimum)

■NOTE: If the battery voltage is 11.5 DC Volts or less, some chargers may “cut off” and fail to charge. If this occurs, connect a fully charged booster battery in parallel (positive to positive and negative to negative) for a short period of time with the charger connected. After 10-15 minutes, disconnect the booster battery leaving the charger connected and the charger should continue to charge. If the charger “cuts off,” replace the battery.

8. After charging the battery for the specified time, remove the battery charger and allow the battery to sit for 1-2 hours.

9. Connect the multimeter and test the battery voltage. The meter should read 12.5 or more DC Volts. If the voltage is as specified, the battery is ready for service.

■NOTE: If voltage in step 9 is below specifications, charge the battery an additional 1-5 hours; then retest.

10. Place the battery in the battery compartment; then coat the battery posts and cable ends with a light coat of multi-purpose grease.

⚠ CAUTION
Before installing the battery, make sure the ignition switch is in the OFF position.

11. Connect the battery cables (positive cable first); then install the battery hold-down.

⚠ CAUTION
Connecting cables in reverse (positive to negative and negative to positive) can cause serious damage to the electrical system.

Fuses

The fuses are located in a power distribution module in front of the steering post. In addition, there is a 30 amp fuse on the starter relay under the seat next to the battery.

If there is any type of electrical system failure, always check the fuses first.

■NOTE: To remove a fuse, compress the locking tabs on either side of the fuse case and lift out.

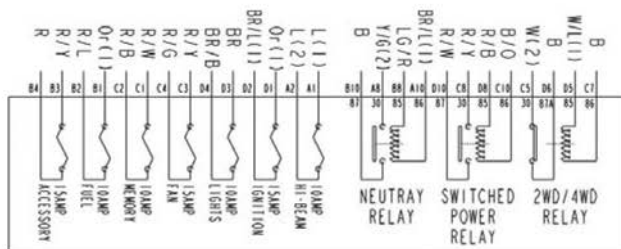

⚠ CAUTION
Always replace a blown fuse with a fuse of the same type and rating.

Air Filter

Use the following procedure to remove the filter and inspect and/or clean it.

CLEANING AND INSPECTING FILTER

1. Rotate the three locking tabs free of the lugs on the air filter cover; then rotate the cover forward and away from the filter housing.

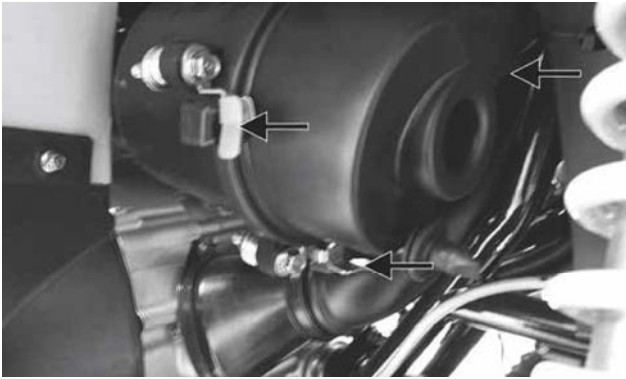

KC0056A



KC147

2. Remove the foam filter element from the air filter housing and separate the foam element from the spring.



KC148

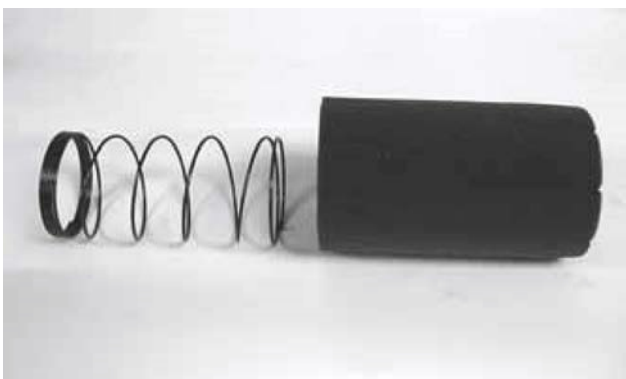

KC143

3. Fill a wash pan larger than the element with a non-flammable cleaning solvent; then dip the element in the solvent and wash it.

4. Dry the element.

5. Put the element in a plastic bag; then pour in air filter oil and work the oil into the element. Insert the forming spring into the element with the closely wrapped end of the spring toward the open end of the element.

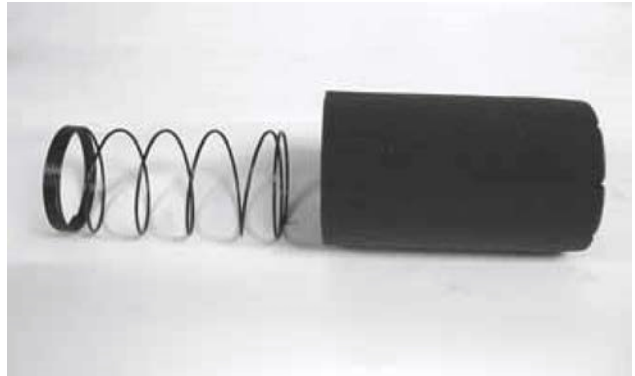

KC143

CAUTION

A torn air filter element can cause damage to the ATV engine. Dirt and dust may get inside the engine if the element is torn. Carefully examine the element for tears before and after cleaning it. Replace the element with a new one if it is torn.

6. Clean any dirt or debris from inside the air cleaner. Be sure no dirt enters the carburetor (if equipped).

7. Place the filter assembly in the air filter housing making sure it is properly positioned and properly seated with the filter element straight in the housing.



KC147

CAUTION

Failure to properly seat and align the filter element may cause severe engine damage.

8. Install the air filter housing cover and secure with the locking tabs.



KC123

CHECKING AND CLEANING DRAIN

1. Inspect the drain on the filter housing cover and clean out any dirt or debris.



KC0056C

2. Replace any drain that is cracked or shows any signs of hardening or deterioration.
3. Wipe any accumulation of oil or gas from the filter housing and drain.

Valve/Tappet Clearance (Feeler Gauge Procedure)

To check and adjust valve/tappet clearance, use the following procedure.

■NOTE: The seat, left-side and right-side engine covers, and gas tank must be removed for this procedure.

1. Remove the timing inspection plug and spark plug; then remove the tappet covers (for more detailed information, see Section 3 - Servicing Top-Side Components).
2. Rotate the crankshaft to the TDC position on the compression stroke.

■NOTE: At this point, the rocker arms and adjuster screws must not have pressure on them.

3. Using a feeler gauge, check each valve/tappet clearance. If clearance is not within specifications, loosen the jam nut and rotate the tappet adjuster screw until the clearance is within specifications. Tighten each jam nut securely after completing the adjustment.

⚠ CAUTION

The feeler gauge must be positioned at the same angle as the valve and valve adjuster for an accurate measurement of clearance. Failure to measure the valve clearance accurately could cause valve component damage.

VALVE/TAPPET CLEARANCE

Intake	0.10 mm
Exhaust	0.17 mm

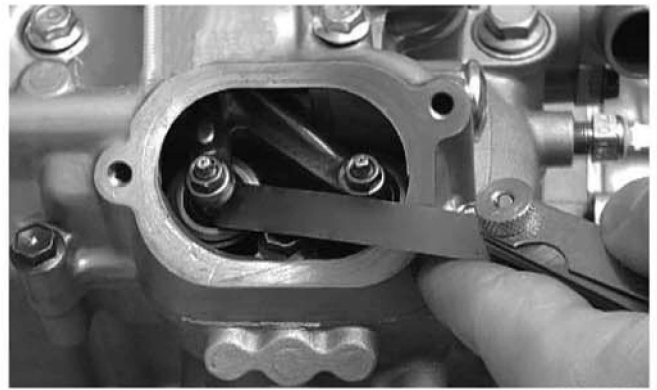

CC007DC

4. Install the timing inspection plug.
5. Place the two tappet covers with O-rings into position; then tighten the covers securely.
6. Install the spark plug; then install the timing inspection plug.

Valve/Tappet Clearance (Valve Adjuster Procedure)

To check and adjust valve/tappet clearance, use the following procedure.

■NOTE: The seat, left-side and right-side engine covers, and gas tank must be removed for this procedure.

1. Remove the timing inspection plug and spark plug; then remove the tappet covers (for more detailed information, see Section 3 - Servicing Top-Side Components).

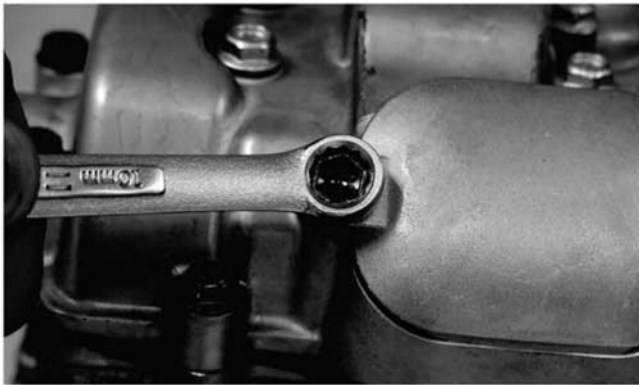

CF005

2. Rotate the crankshaft to the TDC position on the compression stroke.

■NOTE: At this point, the rocker arms and adjuster screws must not have pressure on them.

■NOTE: Use Valve Clearance Adjuster for this procedure.

3. Place the valve adjuster onto the jam nut securing the tappet adjuster screw; then rotate the valve adjuster dial clockwise until the end is seated in the tappet adjuster screw.
4. While holding the valve adjuster dial in place, use the valve adjuster handle and loosen the jam nut; then rotate the tappet adjuster screw clockwise until friction is felt.
5. Align the valve adjuster handle with one of the marks on the valve adjuster dial.
6. While holding the valve adjuster handle in place, rotate the valve adjuster dial counterclockwise until proper valve/tappet clearance is attained.

■NOTE: Refer to the appropriate specifications in Feeler Gauge Procedure sub-section for the proper valve/tappet clearance.

■NOTE: Rotating the valve adjuster dial counterclockwise will open the valve/tappet clearance by 0.05 mm (0.002 in.) per mark.

7. While holding the adjuster dial at the proper clearance setting, tighten the jam nut securely with the valve adjuster handle.
8. Place the two tappet covers with O-rings into position; then tighten the covers securely.
9. Install the spark plug; then install the timing inspection plug.

Testing Engine Compression

To test engine compression, use the following procedure.

1. Remove the high tension lead from the spark plug.
2. Using compressed air, blow any debris from around the spark plug.

WARNING

Always wear safety glasses when using compressed air.

3. Remove the spark plug; then attach the high tension lead to the plug and ground the plug on the cylinder head well away from the spark plug hole.

4. Attach the Compression Tester Kit.

■NOTE: The engine must be warm and the battery must be fully charged for this test.

5. While holding the throttle lever in the full-open position, crank the engine over with the electric starter until the gauge shows a peak reading of **170-227** psi (five to 10 compression strokes).
6. If compression is abnormally low, inspect the following items.
 - A. Verify starter cranks engine over at normal speed (approximately 400 RPM).
 - B. Gauge functioning properly.
 - C. Throttle lever in the full-open position.
 - D. Valve/tappet clearance correct.
 - E. Valve not bent or burned.
 - F. Valve seat not burned.

■NOTE: To service valves, see Section 3.

7. Pour 29.5 ml (1 fl oz) of oil into the spark plug hole, reattach the gauge, and retest compression.
8. If compression is now evident, service the piston rings (see Section 3).

Spark Plug

A light brown insulator indicates that a plug is correct. A white or dark insulator indicates that the engine may need to be serviced or the carburetor may need to be adjusted. To maintain a hot, strong spark, keep the plug free of carbon.

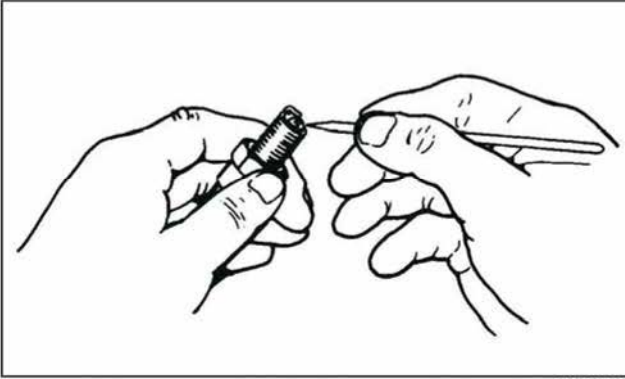

ATV-0051

CAUTION

Before removing a spark plug, be sure to clean the area around the spark plug. Dirt could enter engine when removing or installing the spark plug.

Adjust the gap to 0.7-0.8 mm (0.028-0.032 in.) for proper ignition. Use a feeler gauge to check the gap.

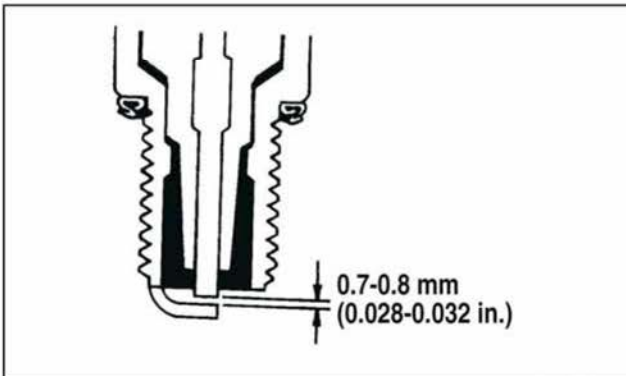

ATV0052C

When installing the spark plug, be sure to tighten it securely. A new spark plug should be tightened 1/2 turn once the washer contacts the cylinder head. A used spark plug should be tightened 1/8 - 1/4 turn once the washer contacts the cylinder head.

Muffler/Spark Arrester

At the intervals shown in the Periodic Maintenance Chart, clean the spark arrester using the following procedure.

WARNING

Wait until the muffler cools to avoid burns.

1. Remove the cap screws securing the spark arrester assembly to the muffler; then loosen and remove the arrester.

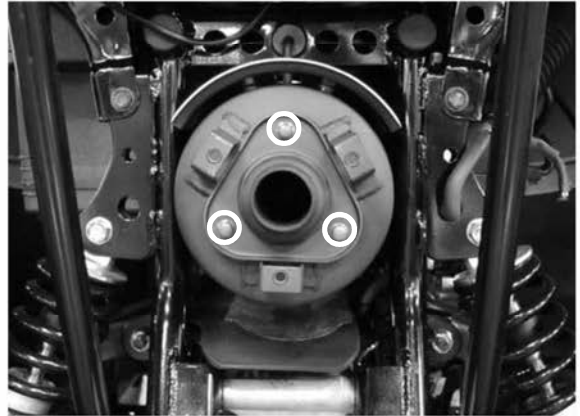

2. Using a suitable brush, clean the carbon deposits from the screen taking care not to damage the screen.

■NOTE: If the screen or gasket is damaged in any way, it must be replaced.

3. Install the spark arrester assembly with gasket; then secure with the cap screws. Tighten to 48 in.-lb.



KC145

Adjusting Throttle Cable

To adjust the throttle cable free-play, follow this procedure.

1. Slide the rubber boot away; then loosen the jam nut from the throttle cable adjuster.



AL611D

2. Turn the adjuster until the throttle cable has proper free-play of 3-6 mm (1/8-1/4 in.) at the lever.

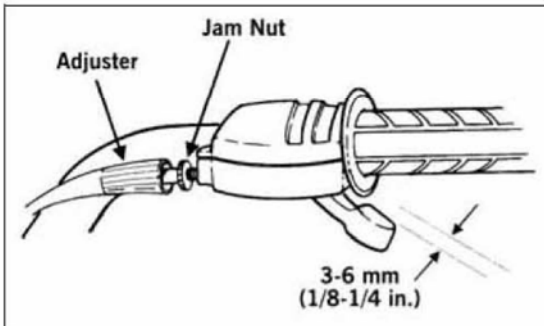

ATV-0047

3. Tighten the jam nut against the throttle cable adjuster securely; then slide the rubber boot over the adjuster.

Engine/Transmission Oil - Filter - Strainer

OIL - FILTER

The engine should always be warm when the oil is changed so the oil will drain easily and completely.

1. Park the ATV on level ground.
2. Remove the seat and left-side engine cover.
3. Remove the oil level stick/filler plug.

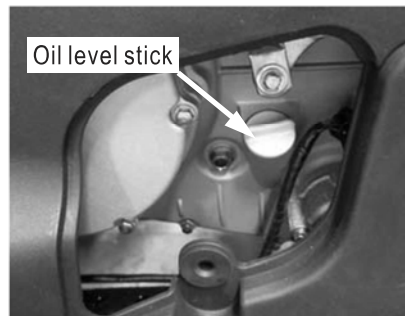

2

4. Remove the drain plug from the bottom of the engine and drain the oil into a drain pan.

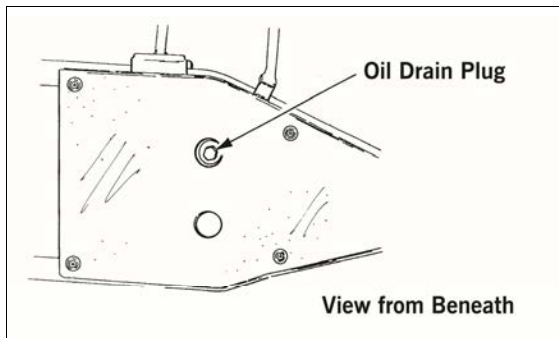

733-441A

5. Remove the oil filter plug from the filter mounting boss (located on the front side of the transmission case) and allow the filter to drain completely. Install the plug and tighten securely.

6. Using the adjustable Oil Filter Wrench and a suitable wrench, remove the old oil filter.

■NOTE: Clean up any excess oil after removing the filter.

7. Apply oil to a new filter seal ring and check to make sure it is positioned correctly; then install the new oil filter. Tighten securely.

8. Install the engine drain plug and tighten to 20 ft-lb. Pour the specified amount of the recommended oil in the filler hole. Install the oil level stick/filler plug.

⚠ CAUTION

Any oil used in place of the recommended oil could cause serious engine damage. Do not use oils which contain graphite or molybdenum additives. These oils can adversely affect clutch operation. Also, not recommended are racing, vegetable, non-detergent, and castor-based oils.

9. Start the engine (while the ATV is outside on level ground) and allow it to idle for a few minutes.

10. Turn the engine off and wait approximately one minute.

11. Remove the oil level stick and wipe it with a clean cloth.

12. Install the oil level into engine case.

■NOTE: The oil level stick should be threaded into the case for checking purposes.

13. Remove the oil level stick; the engine oil level should be above the illustrated “L” mark but not higher than the illustrated “F” mark.

⚠ CAUTION

Do not over-fill the engine with oil. Always make sure that the oil level is above the “L” mark but not higher than the “F” mark.

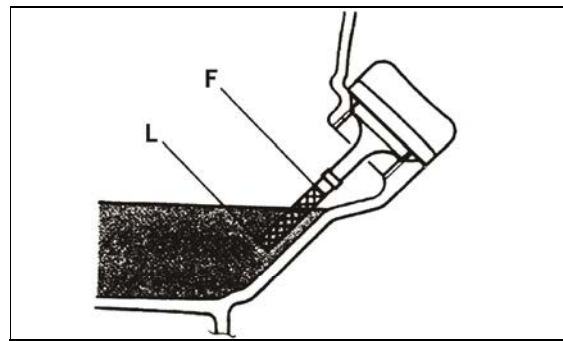

ATV-0100AA

14. Inspect the area around the drain plug and oil filter for leaks.

15. Install the left-side engine cover and the seat.

STRAINER

1. Remove the belly panel.

2. Remove the cap screws securing the oil strainer cap; then remove the cap. Account for the O-ring.



CC091D

3. Remove the two cap screws securing the strainer; then remove the strainer.

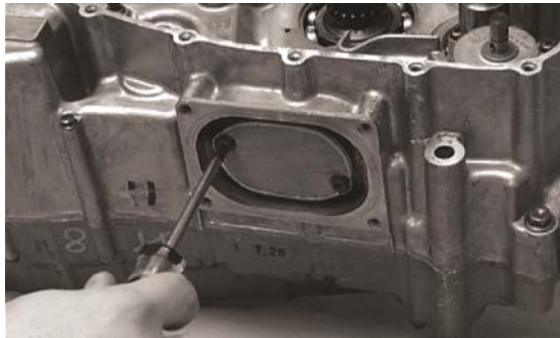

CC163D

AT THIS POINT

To check/service oil strainer, see Section 3.

4. Place the oil strainer into position beneath the crankcase and secure with the cap screws. Tighten securely.
5. Place the strainer cap into position on the strainer making sure the O-ring is properly installed; then secure with the cap screws. Tighten securely.



CC091D

6. Install the belly panel.

Front Differential/Rear Drive Lubricant

When changing the lubricant, use approved SAE 80W-90 hypoid gear lube.

To check lubricant, remove the rear drive filler plug; the lubricant level should be 1 in. below the threads of the plug. If low, add SAE approved 80W-90 hypoid gear lubricant as necessary.

To change the lubricant, use the following procedure.

1. Place the ATV on level ground.
2. Remove each oil fill plug.

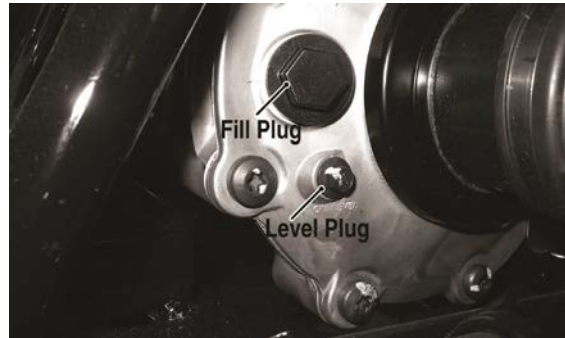

KC0077A

3. Drain the oil into a drain pan by removing the drain plug from each.

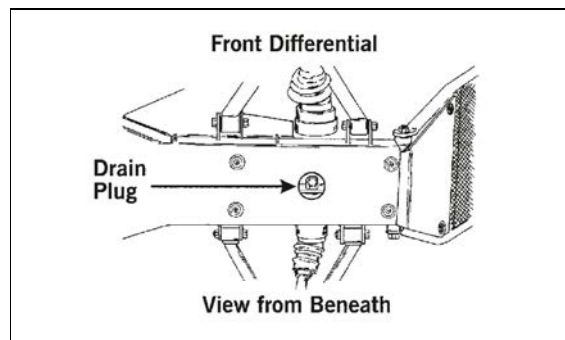

ATV0082A

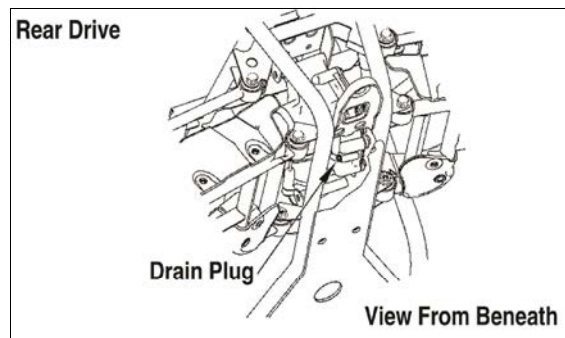

737-651B

4. After all the oil has been drained, install the drain plugs and tighten to 45 in.-lb.
5. Pour the appropriate amount of approved SAE 80W-90 hypoid gear lubricant into the filler hole.
6. Install the fill plugs.

NOTE: If the differential/rear drive oil is contaminated with water, inspect the drain plug, filler plug, and/or bladder.

CAUTION

Water entering the outer end of the axle will not be able to enter the rear drive unless the seals are damaged.

Tires

TIRE SIZES

The ATV is equipped with low-pressure tubeless tires of the size and type listed (see Section 1). Do not under any circumstances substitute tires of a different type or size.

WARNING

**Always use the size and type of tires specified.
Always maintain proper tire inflation pressure.**

TIRE INFLATION PRESSURE

Front and rear tire inflation pressure should be 0.28 kg-cm² (4.0 psi).

Steering Components

The following steering components should be inspected periodically to ensure safe and proper operation.

- A. Handlebar grips not worn, broken, or loose.
- B. Handlebar not bent, cracked, and has equal and complete full-left and full-right capability.
- C. Steering post bearing assembly/bearing housing not broken, worn, or binding.
- D. Ball joints not worn, cracked, or damaged.
- E. Tie rods not bent or cracked.
- F. Knuckles not worn, cracked, or damaged.
- G. Cotter pins not damaged or missing.

Driveshaft/Coupling

The following drive system components should be inspected periodically to ensure proper operation.

- A. Spline lateral movement (slop).
- B. Coupling cracked, damaged, or worn.

Suspension/Shock Absorbers/Bushings

The following suspension system components should be inspected periodically to ensure proper operation.

- A. Shock absorber rods not bent, pitted, or damaged.
- B. Rubber damper not cracked, broken, or missing.
- C. Shock absorber body not damaged, punctured, or leaking.
- D. Shock absorber eyelets not broken, bent, or cracked.
- E. Shock absorber eyelet bushings not worn, deteriorated, cracked, or missing.
- F. Shock absorber spring not broken or sagging.

Nuts/Bolts/Cap Screws

Tighten all nuts, bolts, and cap screws. Make sure rivets holding components together are tight. Replace all loose rivets. Care must be taken that all calibrated nuts, bolts, and cap screws are tightened to specifications.

Lights

Rotate the ignition switch to the lights position; the headlights and taillights should illuminate. Test the brakelights by compressing the brake lever. The brakelights should illuminate.

HEADLIGHTS

■NOTE: The bulb portion of a headlight is fragile. HANDLE WITH CARE. When replacing a headlight bulb, do not touch the glass portion of the bulb. If the glass is touched, it must be cleaned with a dry cloth before installing. Skin oil residue on the bulb will shorten the life of the bulb.

⚠ WARNING

Do not attempt to remove a bulb when it is hot. Severe burns may result.

To replace the headlight bulb, use the following procedure.

1. Remove the protective rubber boot from the rear of the headlight housing; then remove the wiring harness connector from the back of the headlight bulb.



2. Press in and release the spring retainer and pull rearward clear of the bulb assembly.

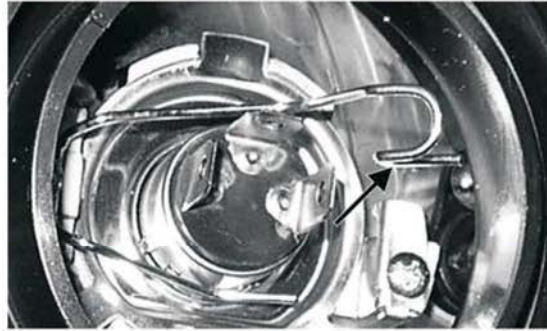

KC163A

3. Remove the headlight bulb assembly from the headlight housing.
4. Install the new headlight bulb into the headlight housing being careful not to get fingerprints or other contaminants on the glass; then secure with the spring.

2

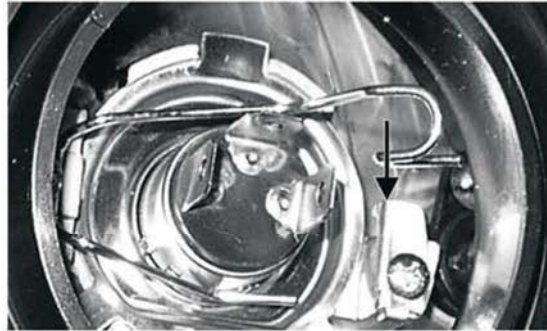

KC163B

5. Connect the wiring harness connector to the bulb; then install the protective rubber boot making sure it seals completely on the headlight harness.



TAILLIGHTS-BRAKELIGHTS

To replace a taillight-brakelight bulb, use the following procedure.

1. Turn the bulb socket assembly counterclockwise and remove from the housing.



2. Press in and turn the bulb counterclockwise to remove. Press in and turn clockwise to install the bulb.
3. Insert the bulb socket assembly into the housing and turn it clockwise to secure.

RUNNING LIGHTS/BACK-UP LIGHTS

The running lights are located outboard of the headlights, and the back-up lights are outboard of the tail-lights/brakelights. To replace the bulbs, use the following procedure.

1. Rotate the bulb socket counterclockwise to release from light housing; then press in on the bulb and turn counterclockwise to release from the socket.

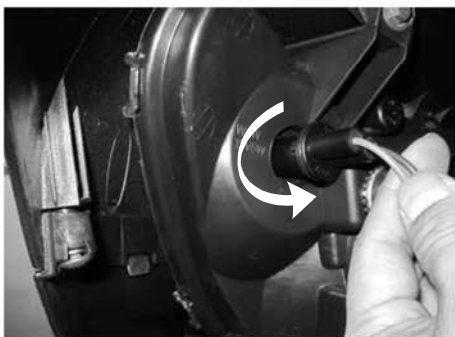

2. Install a new bulb and press in rotating clockwise to secure; then place the socket into the light housing and turn clockwise to secure.



CHECKING/ADJUSTING HEADLIGHT AIM

The headlights can be adjusted vertically and horizontally. The geometric center of the HIGH beam light zone is to be used for vertical and horizontal aiming.

1. Position the ATV on a level floor so the headlights are approximately 6.1 m (20 ft) from an aiming surface (wall or similar aiming surface).

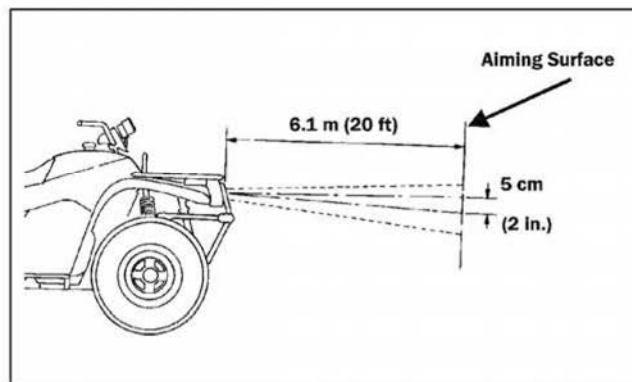

ATV-0070C

■NOTE: There should be an average operating load on the ATV when adjusting the headlight aim.

2. Measure the distance from the floor to the mid-point of each headlight.
3. Using the measurements obtained in step 2, make horizontal marks on the aiming surface.
4. Make vertical marks which intersect the horizontal marks on the aiming surface directly in front of the headlights.
5. Switch on the lights. Make sure the HIGH beam is on. DO NOT USE LOW BEAM.
6. Observe each headlight beam aim. Proper aim is when the most intense beam is centered on the vertical mark 5 cm (2 in.) below the horizontal mark on the aiming surface.
7. To **raise** a headlight beam, turn the adjusting bolt in direction (a).
To **lower** a headlight beam, turn the adjusting bolt in direction (b).
To **inner** a headlight beam, turn the adjusting bolt in direction (c).
To **outer** a headlight beam, turn the adjusting bolt in direction (d).

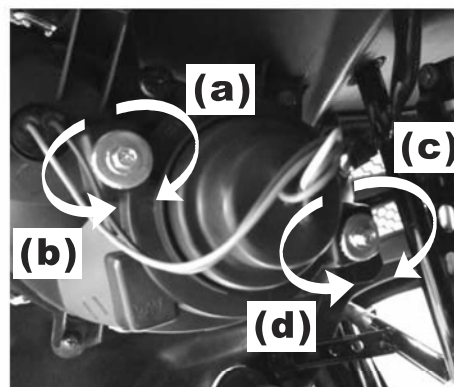

Shift Lever

CHECKING ADJUSTMENT



Low range High range Neutral Reverse

With the engine stopped and the brake lever lock engaged, turn the ignition switch to the ON position; then shift the transmission into each of the gear positions and note that the gear position indicated on the LCD corresponds to the gear position selected by the lever.

If the indicator does not correspond to the selected gear, it will be necessary to test drive the ATV to determine if the gear shift position switch is faulty or the shift lever needs adjustment.

If the ATV functions in the gear selected by the shift lever, troubleshoot the gear shift position switch (see Section 5).

If the ATV functions but the shift lever does not correspond with the gear indicated on the LCD, adjust the shift linkage. To adjust, proceed to ADJUSTING.

ADJUSTING

1. Remove the seat; then remove the left-side engine cover.
2. With the ignition switch in the ON position, loosen jam nut (A) (left-hand threads); then loosen jam nut (C) and with the shift lever in the reverse position, adjust the coupler (B) until the transmission is in reverse and the "R" icon appears on the LCD.

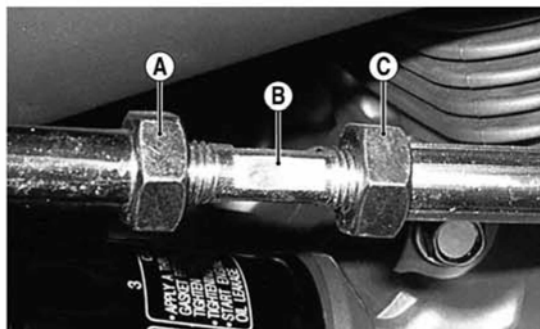

KC194A

3. Tighten the jam nuts securely; then shift the transmission to each position and verify correct adjustment.
4. Install the left-side engine cover and seat making sure the seat locks securely in place.

2

Frame/Welds/Racks

The frame, welds, and racks should be checked periodically for damage, bends, cracks, deterioration, broken components, and missing components. If replacement or repair constitutes removal, see Section 8.

Electrical Connections

The electrical connections should be checked periodically for proper function. In case of an electrical failure, check fuses, connections (for tightness, corrosion, damage), and/or bulbs. If an electrical component needs to be tested for proper function, see Section 5.

Hydraulic Brake Systems

CHECKING/BLEEDING

The hydraulic brake systems have been filled and bled at the factory. To check and/or bleed a hydraulic brake system, use the following procedure.

1. With the master cylinder in a level position, check the fluid level in the reservoir. On the hand brake if the level in the reservoir is adequate, the sight glass will appear dark. If the level is low, the sight glass will appear clear. On the auxiliary brake the level must be between the MIN and MAX lines on the reservoir.

Brake Fluid Sight Window

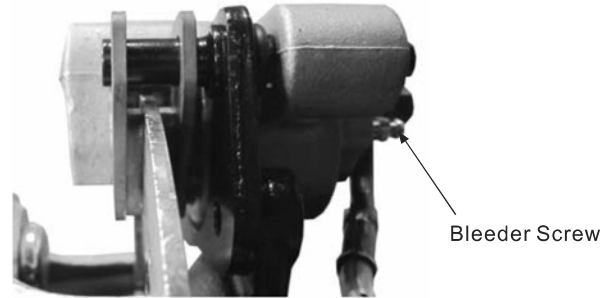

2. Compress the brake lever/pedal several times to check for a firm brake. If the brake is not firm, the system must be bled.
3. To bleed the brake system, use the following procedure.
 - A. Remove the cover and fill the reservoir with DOT 4 Brake Fluid.
 - B. Install and secure the cover; then slowly compress the brake lever several times.
 - C. Remove the protective cap, install one end of a clear hose onto one FRONT bleeder screw, and direct the other end into a container; then while holding slight pressure on the brake lever, open the bleeder screw and watch for air bubbles. Close the bleeder screw before releasing the brake lever. Repeat this procedure until no air bubbles are present.



AF637D

■NOTE: During the bleeding procedure, watch the reservoir sight glass very closely to make sure there is always a sufficient amount of brake fluid. When the sight glass changes from dark to light, refill the reservoir before the bleeding procedure is continued. Failure to maintain a sufficient amount of fluid in the reservoir will result in air in the system.

- D. Repeat step C until the brake lever is firm.
 - E. At this point, perform step B, C, and D on the other FRONT bleeder screw; then move to the REAR bleeder screw and follow the same procedure.
4. Carefully check the entire hydraulic brake system that all hose connections are tight, the bleed screws are tight, the protective caps are installed, and no leakage is present.

CAUTION

Brake fluid that has been drained or bled from the brake system must NEVER be re-used or severe brake system corrosion and damage may occur. Always discard used brake fluid in an appropriate manner.

CAUTION

This hydraulic brake system is designed to use DOT 4 brake fluid only. If brake fluid must be added, care must be taken as brake fluid is very corrosive to painted surfaces.

INSPECTING HOSES

Carefully inspect the hydraulic brake hoses for cracks or other damage. If found, the brake hoses must be replaced.

CHECKING/REPLACING PADS

The clearance between the brake pads and brake discs is adjusted automatically as the brake pads wear. The only maintenance that is required is replacement of the brake pads when they show excessive wear. Check the thickness of each of the brake pads as follows.

1. Remove a front wheel.
2. Measure the thickness of each brake pad.
3. If thickness of either brake pad is less than 1.0 mm (0.039 in.), the brake pads must be replaced.

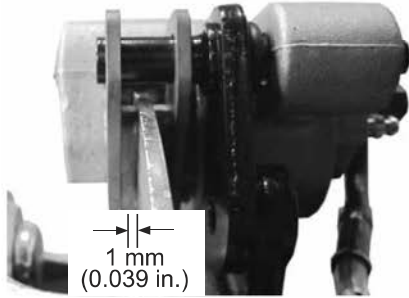

■NOTE: The brake pads should be replaced as a set.

4. To replace the brake pads, use the following procedure.
 - A. Remove the wheel.
 - B. Remove the cap screws securing the caliper holder to the knuckle; then remove the pads.



- C. Install the new brake pads.
- D. Secure the caliper to the knuckle and/or axle housing with the cap screws. Tighten to 20 ft-lb.

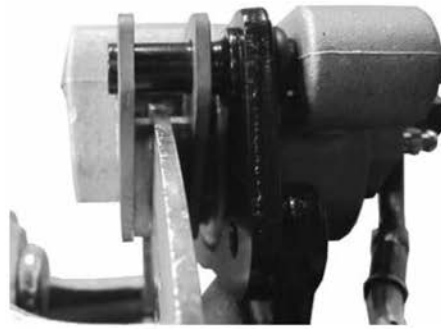

- E. Install the wheel. Tighten to 40 ft-lb.
5. Burnish the brake pads (see Burnishing Brake Pads in this section).

2

Burnishing Brake Pads

Brake pads (both main and auxiliary) must be burnished to achieve full braking effectiveness. Braking distance will be extended until brake pads are properly burnished. To properly burnish the brake pads, use the following procedure.

⚠ WARNING

Failure to properly burnish the brake pads could lead to premature brake pad wear or brake loss. Brake loss can result in severe injury.

1. Choose an area large enough to safely accelerate the ATV to 30 mph and to brake to a stop.
2. Accelerate to 30 mph; then compress brake lever or apply the auxiliary brake to decelerate to 0-5 mph.
3. Repeat procedure on each brake system five times.
4. Adjust the auxiliary brake (if necessary).
5. Verify that the brakelight illuminates when the hand lever is compressed or the brake pedal is depressed.

Checking/Replacing V-Belt

REMOVING

1. Remove the seat and right-side engine cover; then remove the cap screw securing the auxiliary brake pedal to the frame. Account for a flat washer.



KC149A

- Slide the auxiliary brake pedal part way off the pivot stud but do not remove; then remove the cap screws from the V-belt housing and remove the cover. Account for two alignment pins and a gasket.

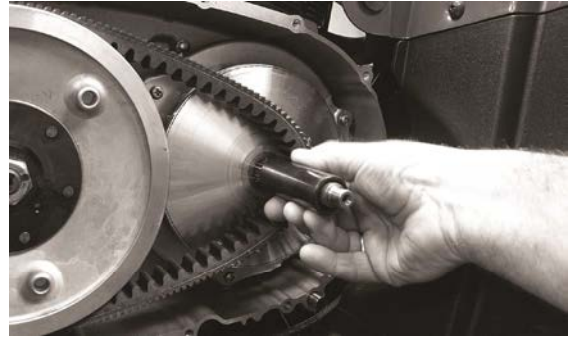

KC128

- Thread a cap screw from the V-belt cover into the driven pulley fixed face and push the movable face open allowing the V-belt to drop down between the pulley faces approximately 3/4 in.

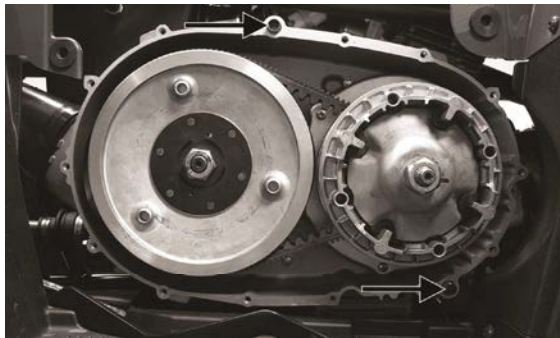

KC142A

- Remove the nut securing the movable drive face to the clutch shaft; then remove the movable drive face assembly being careful not to let the roller fall out. Account for a bushing.



KC137

- Pinching the V-belt together in front of the driven pulley, pull it forward and outward off the clutch shaft; then remove it from the driven pulley.

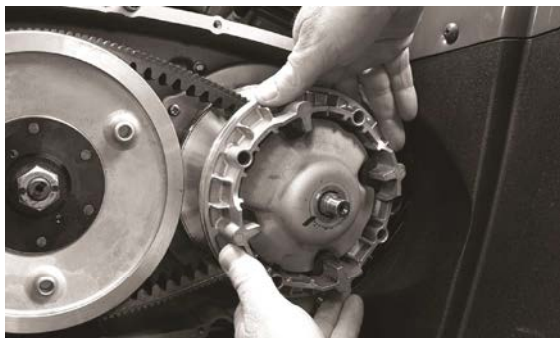

KC127



KC136

- Inspect the faces of the drive and driven pulleys for scoring, pitting, cracks, or grooving; then clean any dirt and debris from the V-belt housing and cover.

INSTALLING

- Place the V-belt onto the driven pulley making sure the arrows point in the direction of rotation; then pinch the belt together in front of the driven pulley and place it over the clutch shaft.

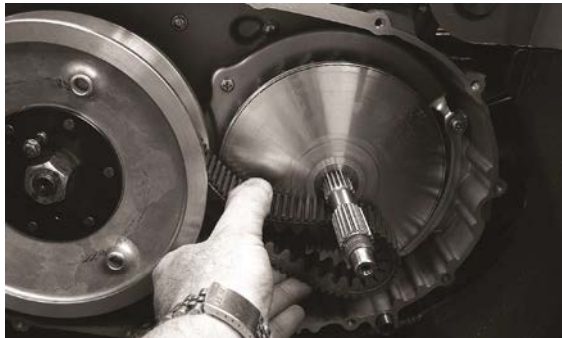

KC135

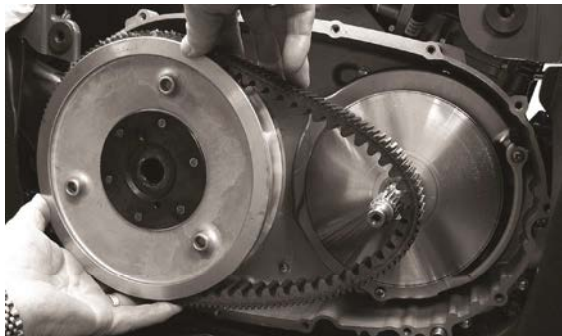

KC131

2. Install the bushing over the clutch shaft; then install the movable drive face assembly on the clutch shaft.

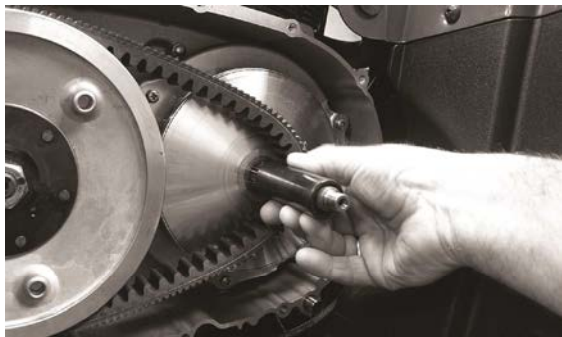

KC128



KC138

3. With two drops of red Loctite #271 on the threads and with the splines of the clutch shaft protruding through the movable drive face, install the nut and tighten to 147 ft-lb.

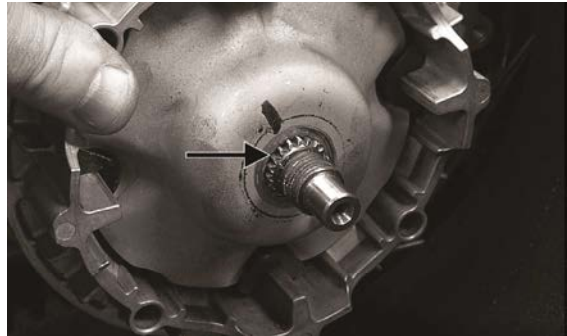

KC152A



KC141

4. Remove the cap screw from the fixed driven face; then rotate the pulleys counterclockwise until the driven pulley faces are together.

5. With the two alignment pins installed in the V-belt housing and a new V-belt cover gasket in place, install the V-belt cover. Using the pattern shown, secure with the cap screws tightened to 8 ft-lb.

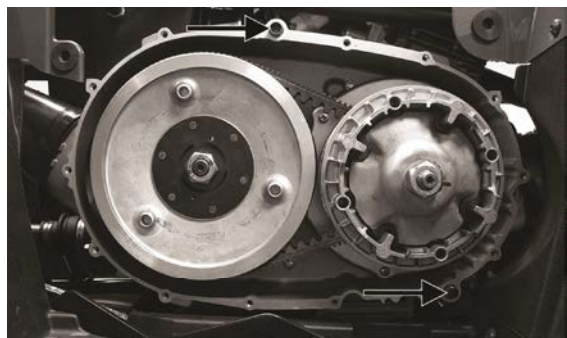

KC142A

2



KC149A

6. Slide the auxiliary brake pedal fully onto the pivot stud engaging the master cylinder; then secure with the flat washer and cap screw and tighten to 20 ft-lb.