

3. INSPECTION/ADJUSTMENT

INSPECTION/ADJUSTMENT

SERVICE INFORMATION-----	3-1
MAINTENANCE SCHEDULE-----	3-2
FUEL LINE-----	3-3
THROTTLE OPERATION-----	3-3
ENGINE OIL-----	3-4
TRANSMISSION OIL-----	3-4
AIR CLEANER-----	3-5
SPARK PLUG-----	3-5
VALVE CLEARANCE-----	3-6
CYLINDER COMPRESSION-----	3-7
DRIVE BELT-----	3-7
CLUTCH SHOE WEAR-----	3-7
HEADLIGHT AIM-----	3-8
BRAKE FLUID-----	3-8
BRAKE PAD WEAR-----	3-8

3. INSPECTION/ADJUSTMENT

SERVICE INFORMATION

GENERAL

 WARNING
--

- Before running the engine, make sure that the working area is well-ventilated. Never run the engine in a closed area. The exhaust contains poisonous carbon monoxide gas which may cause death to people.
- Gasoline is extremely flammable and is explosive under some conditions. The working area must be well-ventilated and do not smoke or allow flames or sparks near the working area or fuel storage area.

SPECIFICATIONS

Throttle grip free play_p 2 ~6mm
 Spark plug_p NGK_p CR8E
 Spark plug gap_p 0.7 ~0.8 mm
 Valve clearance_p IN: 0.12mm EX: 0.12mm
 Idle speed_p 1800±100 rpm

Engine oil capacity:

At disassembly_p 0.9 Liter
 At change _p 0.8 Liter

Ignition timing_p 9° --- 33°
 Coolant type_p air-cooled

Gear oil capacity_p

At disassembly_p 0.12 Liter
 At change_p 0.11 Liter

TIRE

	1Rider	2Riders
Front	1.75 kg/cm ²	1.75 kg/cm ²
Rear	2.0 kg/cm ²	2.25 kg/cm ²

TIRE SPECIFICATION:

Front : 100/80-16
 Rear : 120/80-14

TORQUE VALUES

Front axle nut : 65 N-m
 Rear axle nut : 120 N-m

3. INSPECTION/ADJUSTMENT

MAINTENANCE SCHEDULE

In order to have a safe riding, maintain good performance, prolong the scooter service life and reduce pollution, make sure to perform the periodic inspection and maintenance.

I: Inspect and clean, lubricate, refill, repair or replace if necessary.

A: Adjust C: Clean R: Replace T: Tighten D: Inspect with Diagnosis Instrument

M : Mintenance

ITEM	FREQUENCY	WHICHEVER COMES FIRST	ODOMETER READING (NOTE1)							
		→	1	3	5	7	9	11	13	REFER TO PAGE
		X 1000 km	0.6	2	3	4	5	6	7	
		↓	X 1000 mi	3	6	9	12	15	18	
		MONTH								
*	AIR CLEANER			R	I	R	I	R	I	
	SPARK PLUG				I		R		I	
*	THROTTLE OPERATION			I	I	I	I	I	I	
*	VALVE CLEARANCE		A				A			
*	FUEL LINE						I			
	CRANKCASE BREATHER		C	C	C	C	C	C	C	
	ENGINE OIL		R	R	R	R	R	R	R	
*	ENGINE OIL SCREEN		C	C	C	R	C	C	R	
*	ENGINE IDLE SPEED				I		I		I	
*	TRANSMISSION OIL		R		R		R		R	
*	DRIVE BELT		Inspect every 5000km,replace every 20000km							

**	CLUTCH SHOE WEAR				I		I		I	
	BRAKE FLUID		Replace at every 10000km or every year							
	BRAKE PAD WEAR			I	I	I	I	I	I	
	BRAKE SYSTEM			I	I	I	I	I	I	
*	BRAKE LIGHT SWITCH			I	I	I	I	I	I	
**	STEERING BEARINGS			I	I	I	I	I	I	
*	HEADLIGHT AIM			I	I	I	I	I	I	
*	NUTS,BOLTS,FASTENER			I	I	I	I	I	I	
**	WHEEL/TIRES			I	I	I	I	I	I	
*	CVT FILTER				C		C		C	
**	INJECTOR			D	D	C	D	D	C	

The above items are applicable to different models. Perform suitable items for each model. When exceeding the listed mileages, perform maintenance according to the listed intervals.

The air cleaner requires more frequent cleaning or replacing when ridden in unusually dusty areas.

3. INSPECTION/ADJUSTMENT

FUEL LINE

Check the fuel lines and replace any parts, which show signs of deterioration, damage or leakage.

Check for dirty or clogged fuel injector and replace with a new one if it is clogged.

P Do not smoke or allow flames or sparks in your working area.

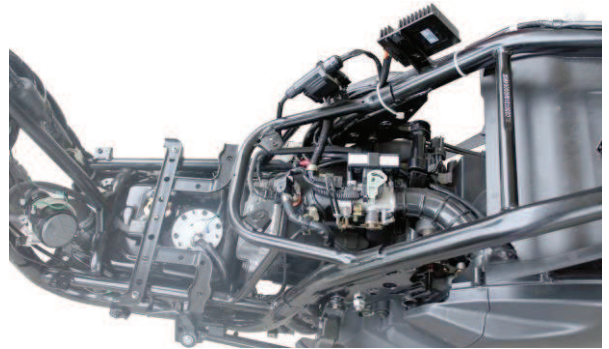

THROTTLE OPERATION

Check the throttle grip for smooth movement. Measure the throttle grip free play.

Free Play: 2~6 mm

Major adjustment of the throttle grip free play is made with the adjusting nut at the intake manifold side. Adjust by loosening the lock nut and turning the adjusting nut.

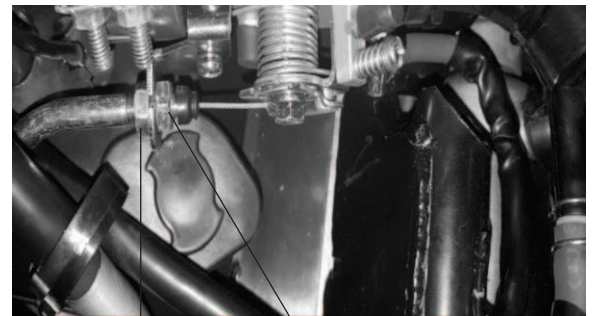

Lock Nut

Adjusting Nut

Minor adjustment is made with the adjusting nut at the throttle grip side.

Slide the rubber cover out and adjust by loosening the lock nut and turning the adjusting nut .



Lock Nut

Adjusting Nut

3. INSPECTION/ADJUSTMENT

ENGINE OIL

Engine oil recommendation

Use a premium quality 4-stroke motor oil to ensure longer service life of your scooter.

Use only oils which are rated, SL under the API service classification. The recommended viscosity is SAE 10W-40.

If SAE 10W-40 motor oil is not available, select an alternative according to the right chart.

Engine oil capacity:

At disassembly: 0.9 L

At change: 0.8 L

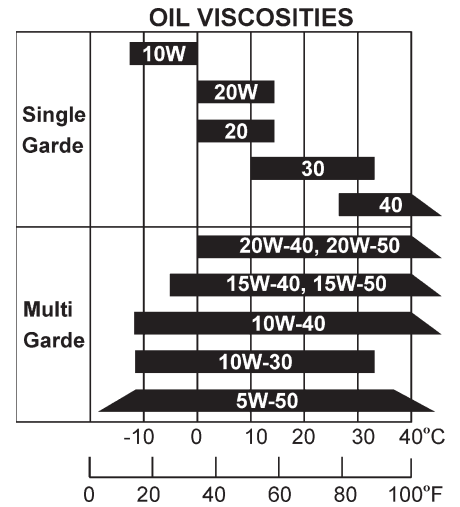

Oil strainer screen clean

Clean the oil strainer screen.

Check that the oil strainer screen, sealing rubber and drain plug O-ring are in good condition.



Oil strainer screen

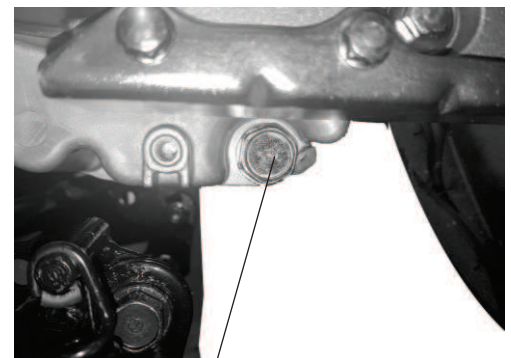

Oil drain bolt

TRANSMISSION OIL

Oil change

Fill the transmission case with recommended oil.

Recommended transmission oil: SAE 90

Oil capacity (at draining): 0.11L

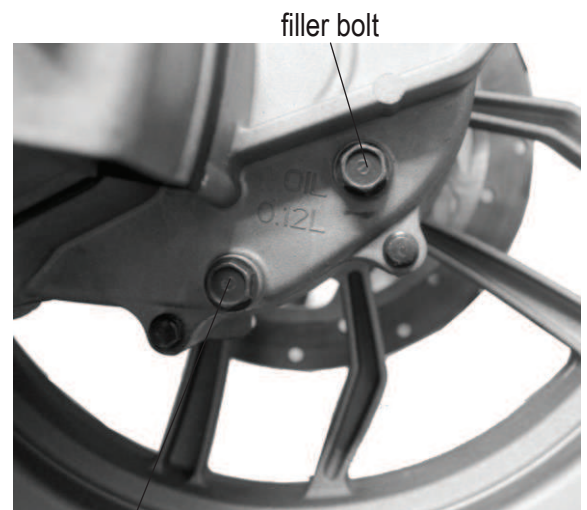

filler bolt

fluid drain bolt

3. INSPECTION/ADJUSTMENT

AIR CLEANER

Air cleaner element replacement

1. Remove 8 screws from the air cleaner cover.
2. Remove the screws from the right side of the scooter.
3. Remove the air cleaner cap.
4. Replace the element with a new one

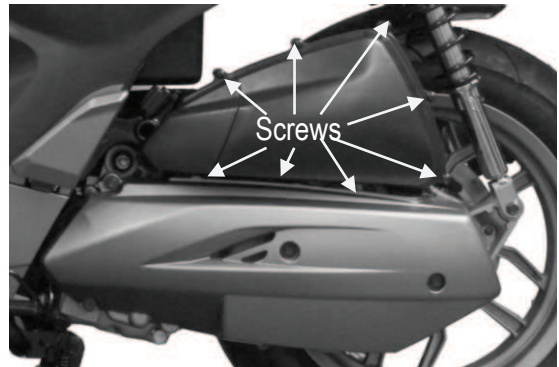

SPARK PLUG

Remove the spark plug cap and spark plug.
 Check the spark plug for wear and fouling deposits.
 Clean any fouling deposits with a spark plug cleaner or a wire brush.
 Specified Spark Plug: CR8E (NGK)
 Measure the spark plug gap.
 Spark Plug Gap: 0.7 – 0.8mm

***** When installing, first screw in the spark plug by hand and then tighten it with a spark plug wrench.

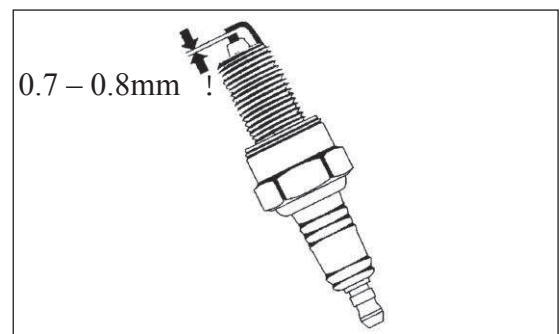

Torque: 0.9 kgf-m

3. INSPECTION/ADJUSTMENT

VALVE CLEARANCE

- * • Inspect and adjust valve clearance while the engine is cold (below 35°C).

Remove the four bolts on the cylinder head cover.
Remove the cylinder head cover.

Remove the fan cover.

Turn the A.C. generator flywheel clockwise to the top dead center (TDC) on the compression stroke so that the "T" mark on the flywheel aligns with the index mark on the right crankcase cover.

The punch mark on the camshaft should face Upward. If the punch mark on the camshaft are facing downward, turn the crankshaft clockwise one full turn (360°) and the punch mark are facing upward.

Adjust by loosening the valve adjusting screw lock-nut and turning the adjusting screw until there is a slight drag on the thickness gauge.

Valve Clearance: IN: 0.12 mm
EX: 0.12 mm

Apply oil to the valve adjusting screw lock-nut threads and seating surface.

Hold the adjusting screw and tighten the lock nut to the specified torque.

Torque: 0.9 kgf-m

Special tool:

Valve adjuster A120E00036

After tightening the lock-nut, recheck the valve clearance.

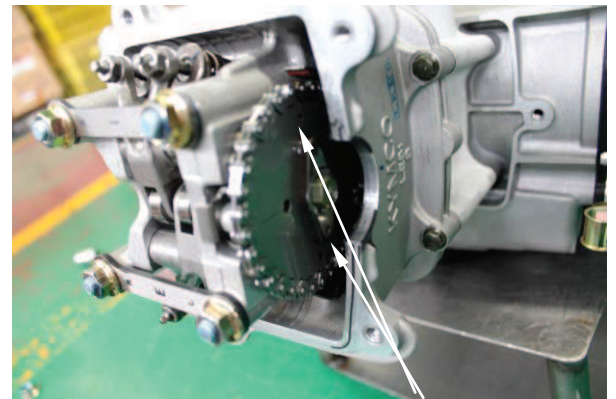

Round Hole

Valve adjuster

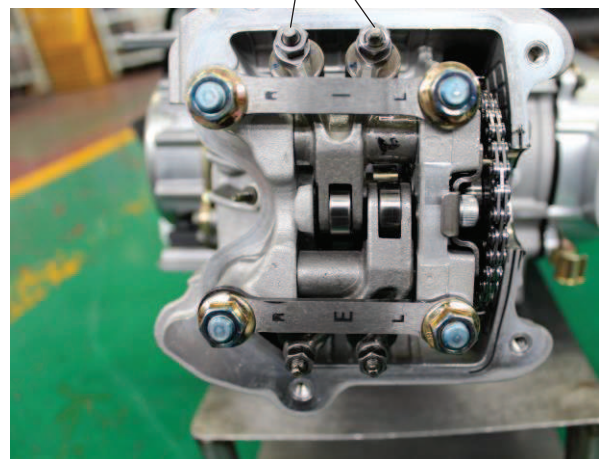

3. INSPECTION/ADJUSTMENT

CYLINDER COMPRESSION

Warm up the engine before compression test.
 Remove the center cover and spark plug cap.
 Remove the spark plug .
 Insert a compression gauge.
 Open the throttle valve fully and push the starter button to test the compression.

Compression: 25 kgf/cm²

If the compression is low, check for the following:

- Leaky valves
- Valve clearance too small
- Leaking cylinder head gasket
- Worn pistons
- Worn piston/cylinder

If the compression is high, it indicates that carbon deposits have accumulated on the combustion chamber and the piston head.



DRIVE BELT

Remove the left crankcase cover.
 Inspect the drive belt for cracks or excessive wear.
 Replace the drive belt with a new one if necessary and in accordance with the Maintenance Schedule.

!

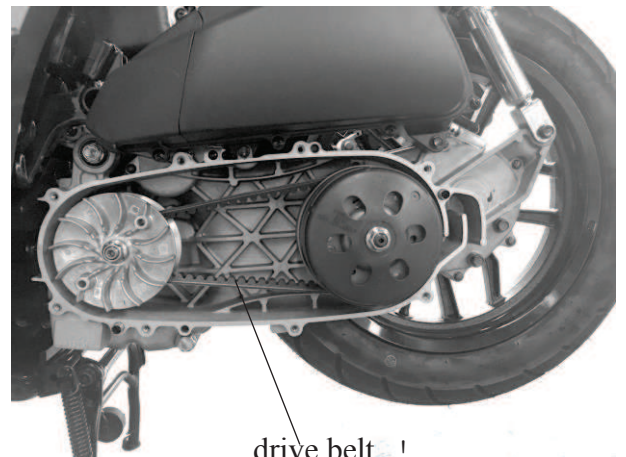

drive belt !

CLUTCH SHOE WEAR

Start the engine and check the clutch operation by increasing the engine speed gradually.
 If the scooter tends to creep, or the engine stalls, check the clutch shoes for wear and replace if necessary.

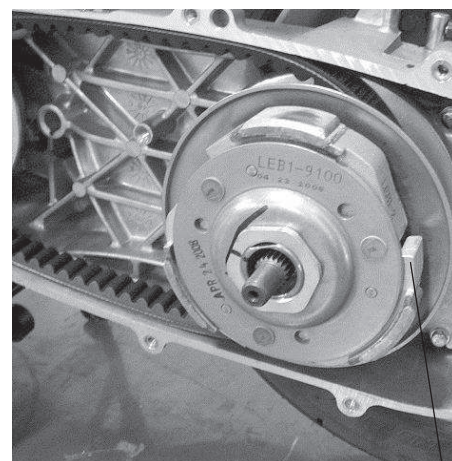

Clutch Shoes !

3. INSPECTION/ADJUSTMENT

HEADLIGHT ADJUSTMENT

Headlight aim can be made by turning the screw in or out as necessary.



Adjustment Screw

BRAKE FLUID

Brake fluid level:

With the scooter in an upright position, check the front and rear fluid level. It should be above the lower level mark. If the level is at or below the lower level mark "L", check the brake pads for wear.

Worn pads should be replaced. If the pads are not worn, have your brake system inspected for leaks.

The recommended brake fluid is **DOT 4** brake fluid from a sealed container, or an equivalent.

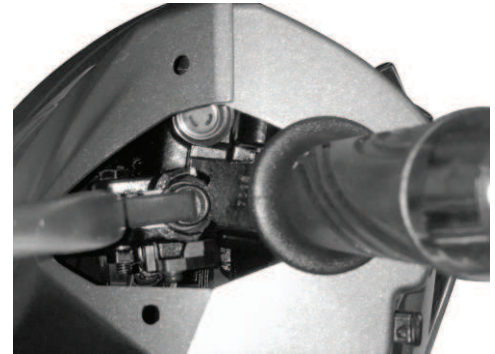

Front brake

BRAKE PAD WEAR

Brake pad wear depends upon the severity of usage, the type of riding, and road conditions. (Generally, the pads will wear faster on wet and dirty roads.)

Check the cutout in each pad.

If either pad is worn to the cutout, replace both pads as a set.

Rear brake

Check the cutout in each pad.

If either pad is worn to the cutout, replace both pads as a set.

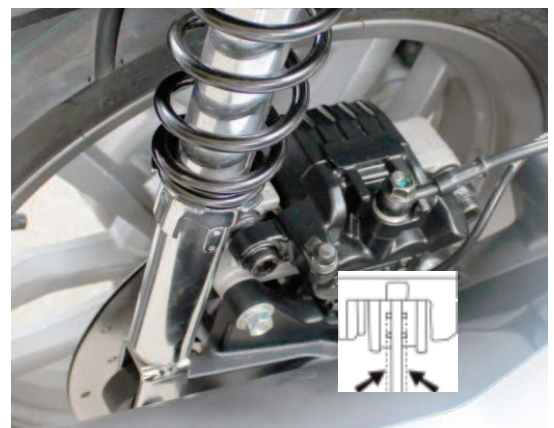

Rear brake

3. INSPECTION/ADJUSTMENT

Charging function detection instructions:

1. If the voltage display value is $\leq 12.25V$, the positive power is off and the USB symbol is not display
2. If the voltage display value $\geq 12.75V$, then the positive open, the instrument will determine whether there is a device in the charge:
 - 2.1 If no device is charging, the USB symbol is not displayed.
 - 2.2.1 If the device is charging and the battery voltage is $> 12.75V$, the USB symbol is displayed.
 - 2.2.2 If the device is charging and $12.75V > \text{battery voltage} > 12.25V$, the USB symbol is flashing.
 - 2.2.3 If the device is charging and the battery voltage is $\leq 12.25V$, the positive power is off and the USB symbol is not displayed.

