

# PREFACE

This Service Manual describes the technical features and servicing procedures for the KYMCO *AGILITY CITY 125/150*

Section 1 contains the precautions for all operations stated in this manual. Read them carefully before starting any operation.

Section 2 is the removal/installation procedures for the frame covers which are subject to higher removal/installation frequency during maintenance and servicing operations.

Section 3 describes the inspection/adjustment procedures, safety rules and service information for each part, starting from periodic maintenance.

Sections 6 through 17 give instructions for disassembly, assembly and inspection of engine, chassis frame and electrical equipment.

Most sections start with an assembly or system illustration and troubleshooting for the section. The subsequent pages give detailed procedures for the section.

Our company reserves the right to make any alteration in the design. The information and contents included in this manual may be different from the motorcycle in case specifications are changed.

## TABLE OF CONTENTS

ENGINE	GENERAL INFORMATION	1
	FRAME COVERS/EXHAUST MUFFLER	2
	INSPECTION/ADJUSTMENT	3
	LUBRICATION SYSTEM	4
	FUEL SYSTEM	5
	ENGINE REMOVAL/INSTALLATION	6
	CYLINDER HEAD/VALVES	7
	CYLINDER/PISTON	8
	DRIVE AND DRIVEN PULLEYS/KICK STARTER	9
	FINAL REDUCTION	10
	CRANKCASE/CRANKSHAFT	11
CHASSIS	FRONT WHEEL/FRONT BRAKE/FRONT SUSPENSION	12
	REAR WHEEL /REAR BRAKE /REAR SUSPENSION	13
ELECTRICAL EQUIPMENT	BATTERY/CHARGING SYSTEM/A.C. GENERATOR	14
	IGNITION SYSTEM	15
	STARTING SYSTEM	16
	LIGHTS/INSTRUMENTS/SWITCHES	17

# 1. GENERAL INFORMATION

## AGILITY CITY 125/150

ENGINE SERIAL NUMBER .....	1- 1	LUBRICATION POINTS .....	1-13
SPECIFICATIONS .....	1- 2	CABLE & HARNESS ROUTING .....	1-15
SERVICE PRECAUTIONS .....	1- 3	WIRING DIAGRAM.....	1-20
TORQUE VALUES .....	1-11	TROUBLESHOOTUNG .....	1-21
SPECIAL TOOLS .....	1-12		

### ENGINE SERIAL NUMBER

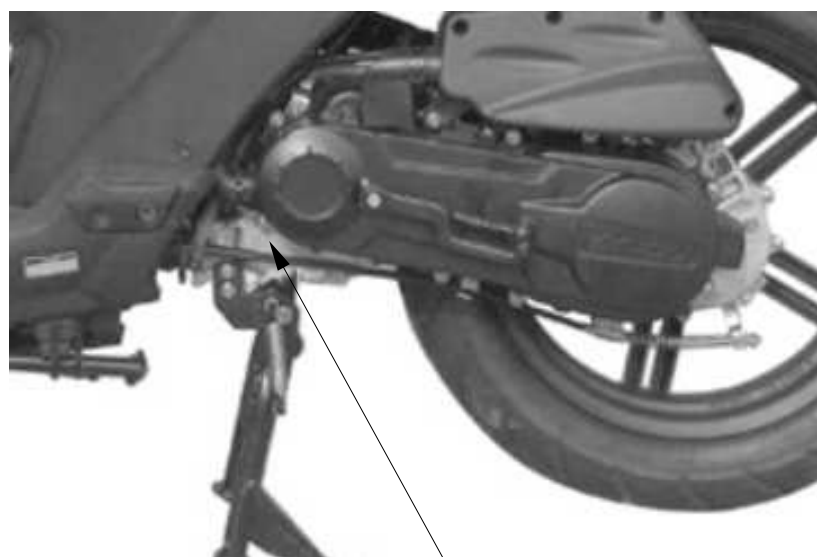

# 1. GENERAL INFORMATION

## SPECIFICATIONS

Name & Model No.		LFC3/4		
Overall length (mm)		2040		
Overall width (mm)		740		
Overall height (mm)		1240		
Wheel base (mm)		1340		
Engine type		O.H.C.		
Displacement		125cc		
Fuel Used		92# unleaded gasoline		
Net weight (kg)	Front wheel	44		
	Rear wheel	56		
	Total	110		
Gross weight(kg)	Front wheel	45		
	Rear wheel	67		
	Total	144		
Tires	Front wheel	100/80 -16 56J		
	Rear wheel	120/80 -16 56J		
Ground clearance (mm)		112		
Performance	Braking distance (m)	7 (Initial speed 30km/h)		
	Min. turning radius (m)	1.99		
Engine	Starting system		Starting motor & kick starter	
	Type		Gasoline, 4-stroke	
	Cylinder arrangement		Single cylinder	
	Combustion chamber type		Semi-sphere	
	Valve arrangement		O.H.C.	
	Bore x stroke (mm)		$\phi 52.4 \times 57.8 / \phi 57.4 \times 57.8$	
	Compression ratio		9.6/10.3 $\pm$ 0.2	
	Compression pressure (kg/cm <sup>2</sup> -rpm)		13/15 $\pm$ 2	
	Max. output		6.9/7500kw/(r/min)/ 7.8/7000kw(r/min)	
	Max. torque		9.1/6500N.m/rpm/ 11.5/5500N.m(r/min)	
	Port timing	Intake	Open	-2.5°
			Close	32°
		Exhaust	Open	-3°
			Close	33°
	Valve clearance (cold) (mm)	Intake	0.12	
		Exhaust	0.12	
	Idle speed (rpm)		1700 $\pm$ 100rpm	
	Lubrication System	Lubrication type		Forced pressure & wet sump
		Oil pump type		Inner/outer rotor type
		Oil filter type		Full-flow filtration
Oil capacity		0.9 liter		
Cooling Type		Forced air cooling		

Fuel System	Air cleaner type & No		Paper element, wet		
	Fuel capacity		6.0 liter		
	Carburetor	Type		CVK	
		Piston dia. (mm)		$\phi 22$	
Venturi dia.(mm)		$\phi 26/24$ equivalent			
Throttle type		Butterfly type			
Electrical Equipment	Ignition System	Type		CDI	
		Ignition timing		BTDC27° $\pm$ 2° /4000rpm	
		Contact breaker		Non-contact point type	
		Spark plug		CHAMP ION-P-RZ9HC NGK CR7HSA	
		Spark plug gap		0.6~0.7mm	
Battery	Capacity		12V7AH		
Power Drive System	Clutch	Type		Dry multi-disc clutch	
		Transmission Gear	Type		Non-stage transmission
	Operation		Automatic centrifugal type		
	Reduction Gear	Type		Two-stage reduction	
Reduction ratio		1st	1.0-2.8		
	2nd	46/16*46/15			
Moving Device	Front Axle	Caster angle		27°	
		Trail length		—	
	Tire pressure (kg/cm <sup>2</sup> )	Front		1.75	
		Rear		2.25	
	Turning angle	Left		45°	
Right		45°			
Brake system type		Front	DISK (180mm) brake		
		Rear	Drum (110mm) brake/ DISK (180mm) brake		
Damping Device	Suspension type	Front		TELESCOPE	
		Rear		Unit Swing	
	Shock absorber distance	Front		80	
		Rear		82	
Frame type		Under Bone			

### SERVICE PRECAUTIONS

- Make sure to install new gaskets, O-rings, circlips, cotter pins, etc. when reassembling.

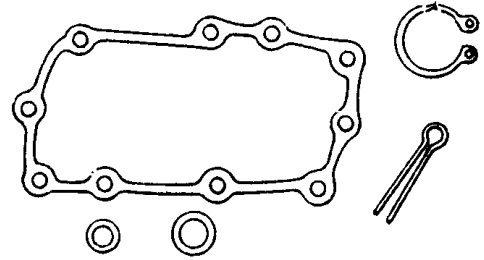

- When tightening bolts or nuts, begin with larger-diameter to smaller ones at several times, and tighten to the specified torque diagonally.

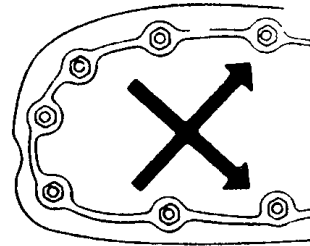

- Use genuine parts and lubricants

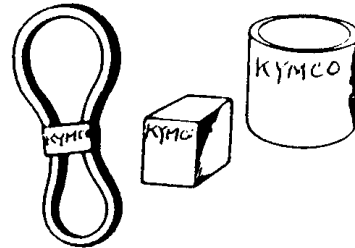

- When servicing the motorcycle, be sure to use special tools for removal and installation.



- After disassembly, clean removed parts. Lubricate sliding surfaces with engine oil before reassembly.

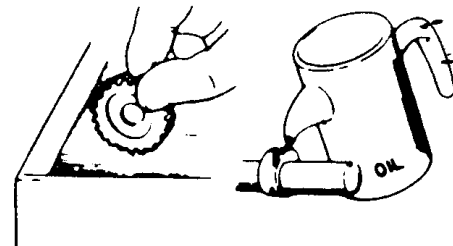

# 1. GENERAL INFORMATION

- Apply or add designated greases and lubricants to the specified lubrication points.

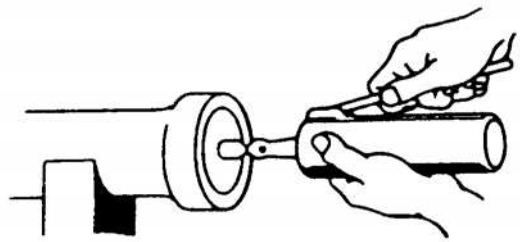

- After reassembly, check all parts for proper tightening and operation.



- When two persons work together, pay attention to the mutual working safety.

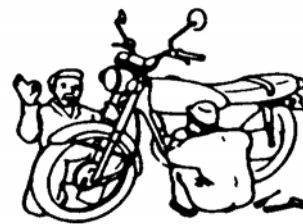

- Disconnect the battery negative (-) terminal before operation.
- When using a spanner or other tools, make sure not to damage the motorcycle surface.

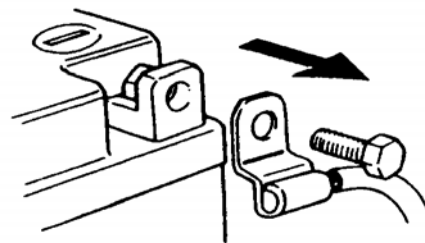

- After operation, check all connecting points, fasteners, and lines for proper connection and installation.
- When connecting the battery, the positive (+) terminal must be connected first.
- After connection, apply grease to the battery terminals.
- Terminal caps shall be installed securely.

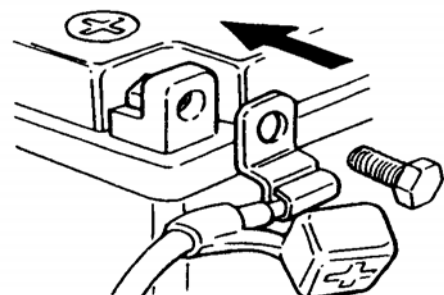

# 1. GENERAL INFORMATION

- If the fuse is burned out, find the cause and repair it. Replace it with a new one according to the specified capacity.

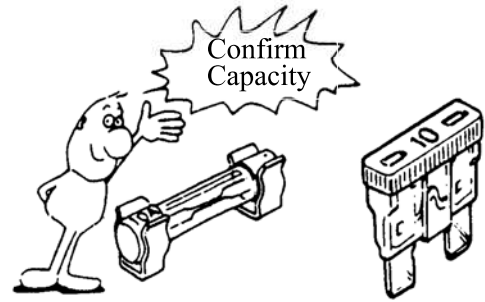

- After operation, terminal caps shall be installed securely.



- When taking out the connector, the lock on the connector shall be released before operation.

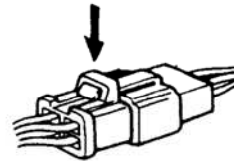

- Hold the connector body when connecting or disconnecting it.
- Do not pull the connector wire.



- Check if any connector terminal is bending, protruding or loose.

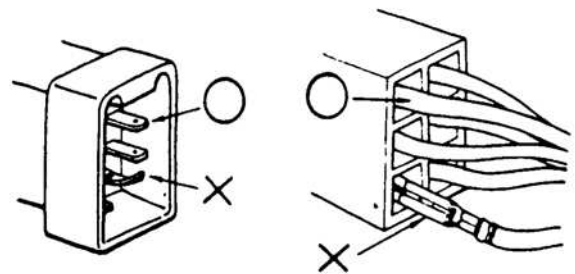

# 1. GENERAL INFORMATION

- The connector shall be inserted completely.
- If the double connector has a lock, lock it at the correct position.
- Check if there is any loose wire.

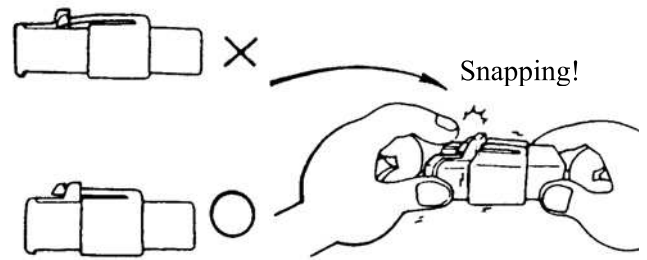

- Before connecting a terminal, check for damaged terminal cover or loose negative terminal.

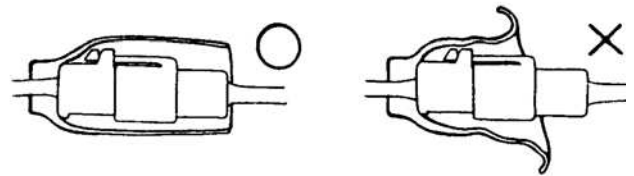

- Check the double connector cover for proper coverage and installation.

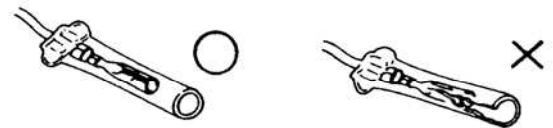

- Insert the terminal completely.
- Check the terminal cover for proper coverage.
- Do not make the terminal cover opening face up.



- Secure wire harnesses to the frame with their respective wire bands at the designated locations. Tighten the bands so that only the insulated surfaces contact the wire harnesses.

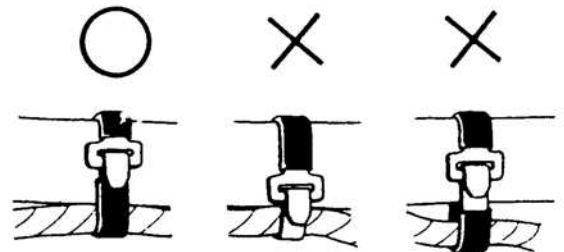

# 1. GENERAL INFORMATION

- After clamping, check each wire to make sure it is secure.

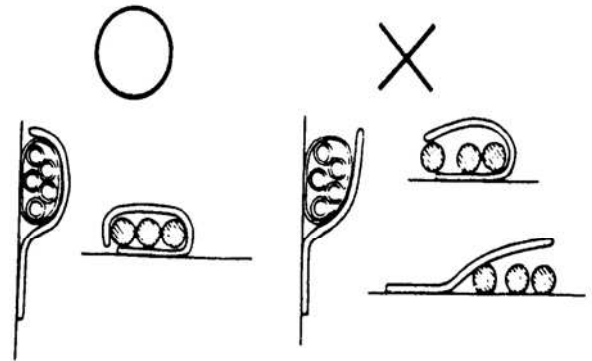

- Do not squeeze wires against the weld or its clamp

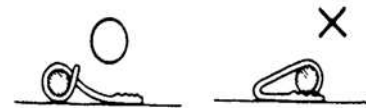

- After clamping, check each harness to make sure that it is not interfering with any moving or sliding parts.

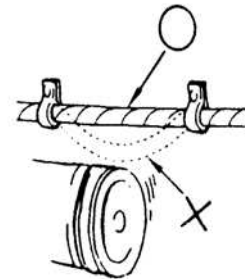

- When fixing the wire harnesses, do not make it contact the parts which will generate high heat.

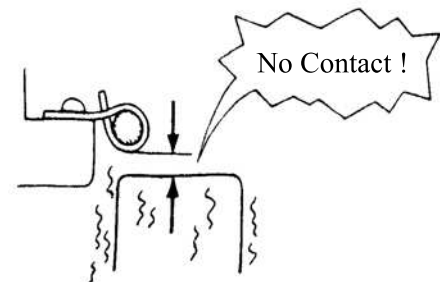

- Route wire harnesses to avoid sharp edges or corners. Avoid the projected ends of bolts and screws.
- Route wire harnesses passing through the side of bolts and screws. Avoid the projected ends of bolts and screws.

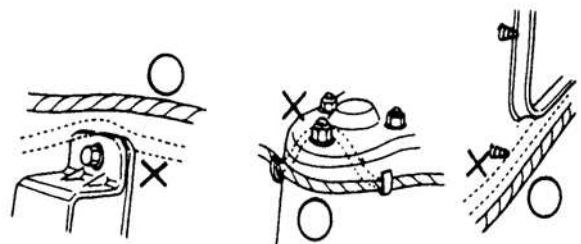



# 1. GENERAL INFORMATION

- Route harnesses so they are neither pulled tight nor have excessive slack.

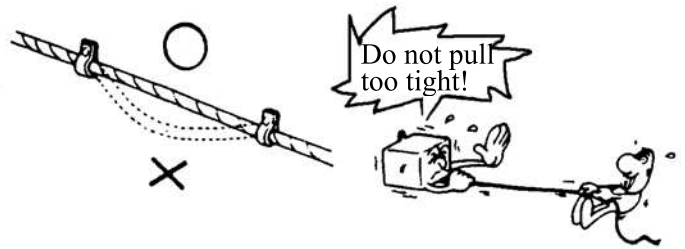

- Protect wires and harnesses with electrical tape or tube if they contact a sharp edge or corner

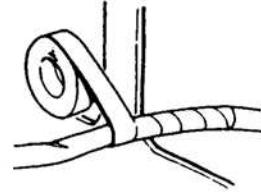

- When rubber protecting cover is used to protect the wire harnesses, it shall be installed securely.

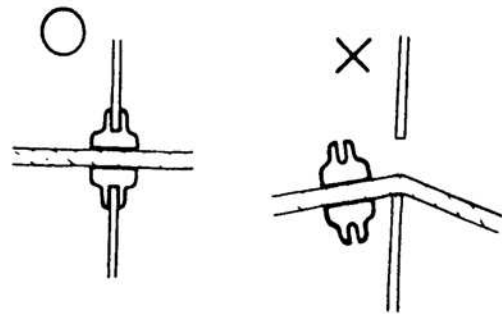

- Do not break the sheath of wire.
- If a wire or harness is with a broken sheath, repair by wrapping it with protective tape or replace it.

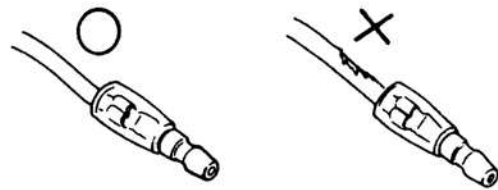

- When installing other parts, do not press or squeeze the wires.



# 1. GENERAL INFORMATION

- After routing, check that the wire harnesses are not twisted or kinked.

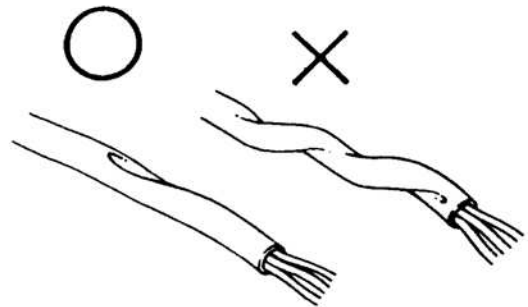

- Wire harnesses routed along with handlebar should not be pulled tight, have excessive slack or interfere with adjacent or surrounding parts in all steering positions.



- When a testing device is used, make sure to understand the operating methods thoroughly and operate according to the operating instructions.

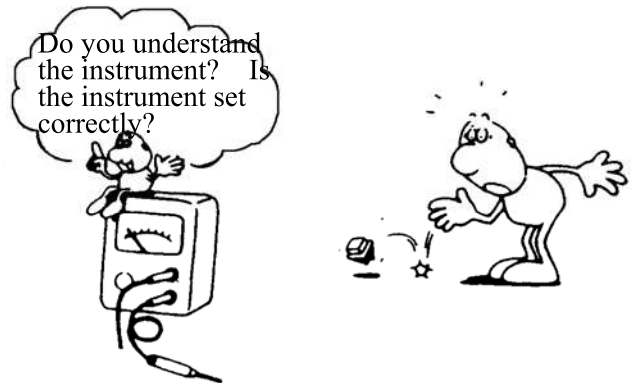

- Be careful not to drop any parts.

- When rust is found on a terminal, remove the rust with sand paper or equivalent before connecting.

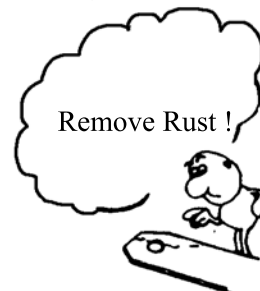

- Do not bend or twist control cables. Damaged control cables will not operate smoothly and may stick or bind.

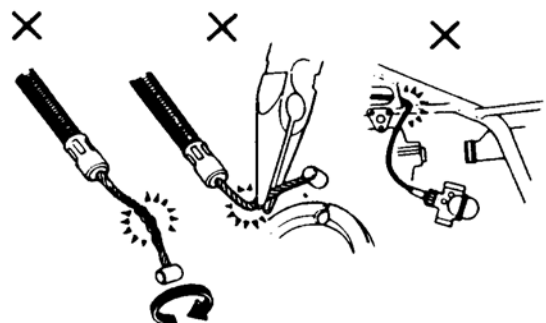

# 1. GENERAL INFORMATION

---

## ■ Symbols:

The following symbols represent the servicing methods and cautions included in this service manual.



Engine Oil

: Apply engine oil to the specified points. (Use designated engine oil for lubrication.)



Grease

: Apply grease for lubrication.



Gear Oil

: Transmission Gear Oil (90#)



Special

: Use special tool.



: Caution



: Warning

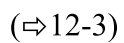

(⇒12-3) : Refer to page 12-3.

# 1. GENERAL INFORMATION

**AGILITY CITY 125/150**

## TORQUE VALUES

### STANDARD TORQUE VALUES

Item	Torque (kg-m)	Item	Torque (kg-m)
5mm bolt, nut	0.45-0.6	5mm screw	0.35-0.5
6mm bolt, nut	0.6-1.2	6mm screw, SH bolt	0.7-1.1
8mm bolt, nut	1.8-2.5	6mm flange bolt, nut	1.0-1.4
10mm bolt, nut	3.0-4.0	8mm flange bolt, nut	2.4-3.0
12mm bolt, nut	5.0-6.0	10mm flange bolt, nut	3.5-4.5

Torque specifications listed below are for important fasteners.

### ENGINE

Item	Q'ty	Thread dia.(mm)	Torque (kg-m)	Remarks
Cylinder head bolt A	2	6	0.7-1.1	Double end bolt
Cylinder head bolt B	4	6	0.7-1.1	
Oil filter screen cap	1	30	1.0-2.0	Double end bolt Apply oil to threads
Exhaust muffler lock bolt	2	6	0.7-1.1	
Cylinder head flange nut	4	7	1.2-1.6	
Valve adjusting lock nut	2	3	0.07-0.09	
Cam chain tensioner slipper bolt	1	8	0.4-0.7	
Oil bolt	1	8	1.1-1.5	
Clutch outer nut	1	10	3.5-4.5	
Clutch drive plate nut	1	28	5.0-6.0	
Starter motor mounting bolt	2	6	0.8-1.2	
Oil pump bolt	3	4	0.1-0.3	
Drive face nut	1	10	5.5-6.5	
Spark plug	1	10	1.0-1.4	
A.C. generator stator bolt	2	6	0.8-1.2	
Cam chain tensioner bolt	1	6	0.8-1.2	

### FRAME

Item	Q'ty	Thread dia.(mm)	Torque (kg-m)	Remarks
Steering stem lock nut	1	25.4	8.0-12.0	U-nut
Front axle nut	1	10	5.0-7.0	U-nut
Rear axle nut	1	14	11.0-13.0	U-nut
Rear shock absorber upper bolt	1	10	4.0-5.0	Apply locking agent
Rear shock absorber lower bolt	1	8	2.0-3.0	
Speedometer cable set screw	1	5	0.45-0.6	
Rear shock absorber lock nut	1	8	3.0-3.6	

# 1. GENERAL INFORMATION

**AGILITY CITY 125/150**

## SPECIAL TOOLS

Tool Name	Tool No.	Remarks	Ref. Page
Bearing puller 10.12.15.18 mm	E037	10.12.15.18mm bearing	10-3 10-4 12-6
Bushing remover L	E032	11102 bush engine hanger rubber	
Bushing remover S	EO19	11203 bush rear cushion under rubber	
Crankshaft bearing puller	E030	91005 radial bearing	
Crankshaft protector	E029	13000 crankshaft comp 12mm.14mm	
Clutch spring compressor	E027	2301a driven pully assy	9-9 9-12
Cushion assemble & disassemble tool	F004	52400 cushion assy	13-4
Flywheel holder	E017	31110 flywheel comp.2310a pully assy driven	9-5 9-9 9-13 14-7 14-9
Flywheel puller	E002	Left hand thread 27mm	14-7
Long socket wrench 32mm 8angle	F002	50306 steering stem	12-21 12-22
Oil seal & bearing installer	E014	Oil seal & bearing install	
Tool boox	E033	Special tools storage	
Tappet adjuster	E036	90012 screw tappet	3-5
Valve spring compressor	E038	Valve spring	7-7 7-8

# 1. GENERAL INFORMATION

## LUBRICATION POINTS

### ENGINE

Lubrication Points	Lubricant
Valve guide/valve stem movable part Cam lobes Valve rocker arm friction surface Cam chain Cylinder lock bolt and nut Piston surroundings and piston ring grooves Piston pin surroundings Cylinder inside wall Connecting rod/piston pin hole Connecting rod big end Crankshaft R/L side oil seal Starter reduction gear engaging part Countershaft gear engaging part Final gear engaging part Bearing movable part O-ring face Oil seal lip	<ul style="list-style-type: none"> <li>•Genuine KYMCO Engine Oil (SAE15W-40)</li> <li>•API-SG Engine Oil</li> </ul>
Starter idle gear Friction spring movable part/shaft movable part Shaft movable grooved part Kick starter spindle movable part	High-temperature resistant grease
A.C. generator connector Transmission case breather tube	Adhesive

# 1. GENERAL INFORMATION

AGILITY CITY 125/150

## FRAME

The following is the lubrication points for the frame.

Use general purpose grease for parts not listed.

Apply clean engine oil or grease to cables and movable parts not specified.

This will avoid abnormal noise and rise the durability of the motorcycle.

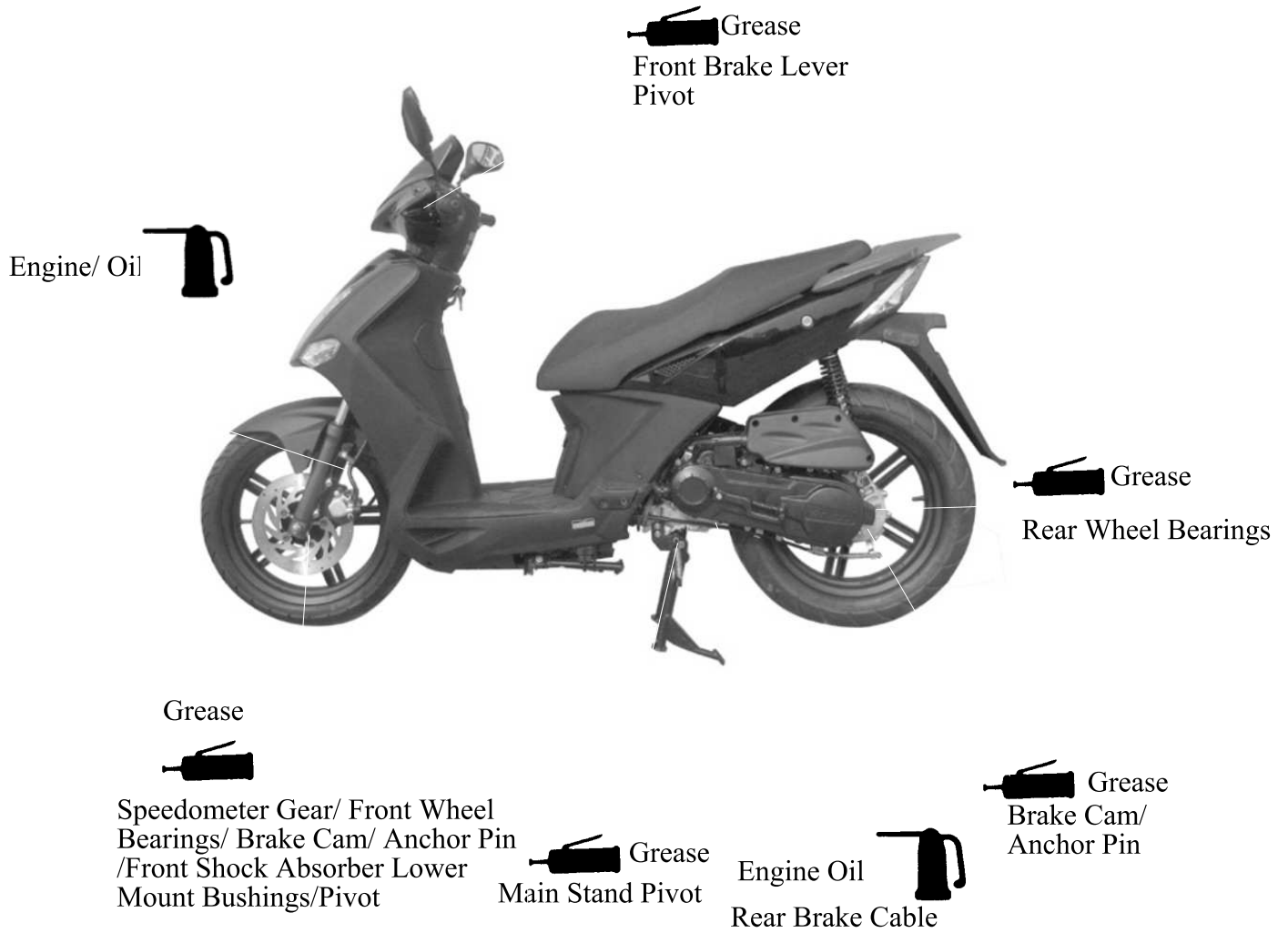

# 1. GENERAL INFORMATION

AGILITY CITY 125/150

## CABLE & HARNESS ROUTING

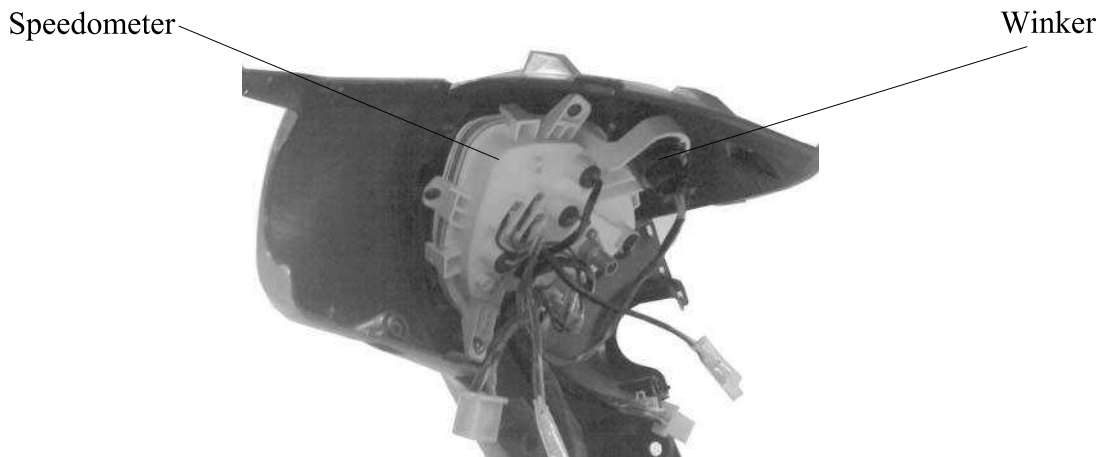
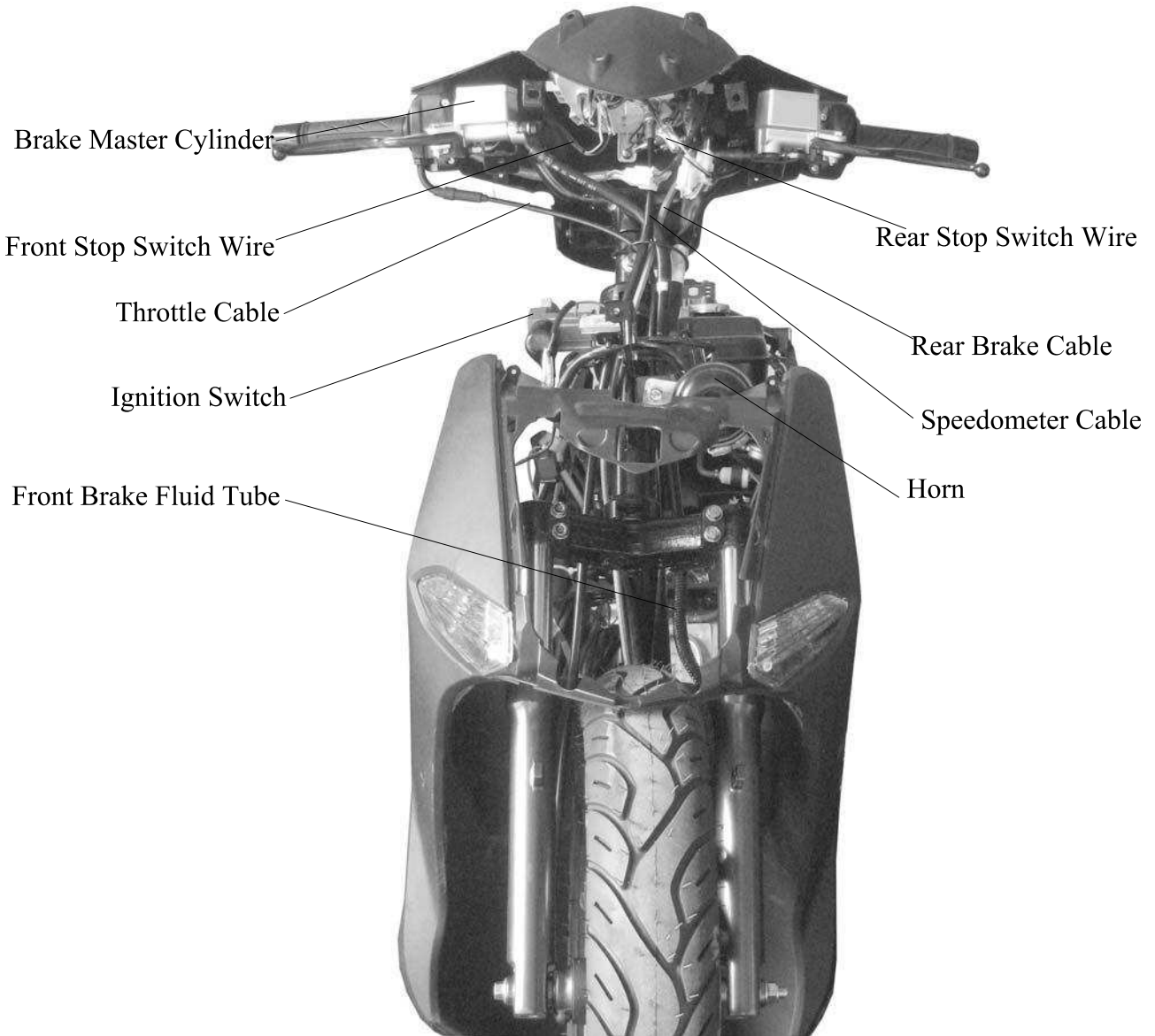



# 1. GENERAL INFORMATION

AGILITY CITY 125/150

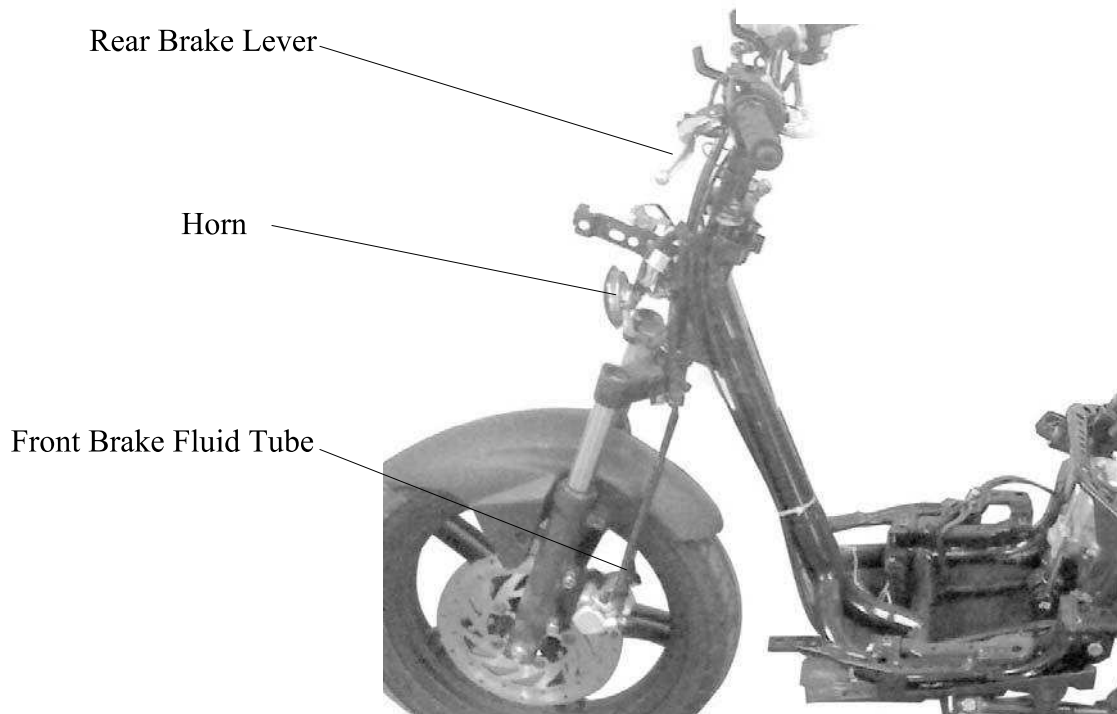
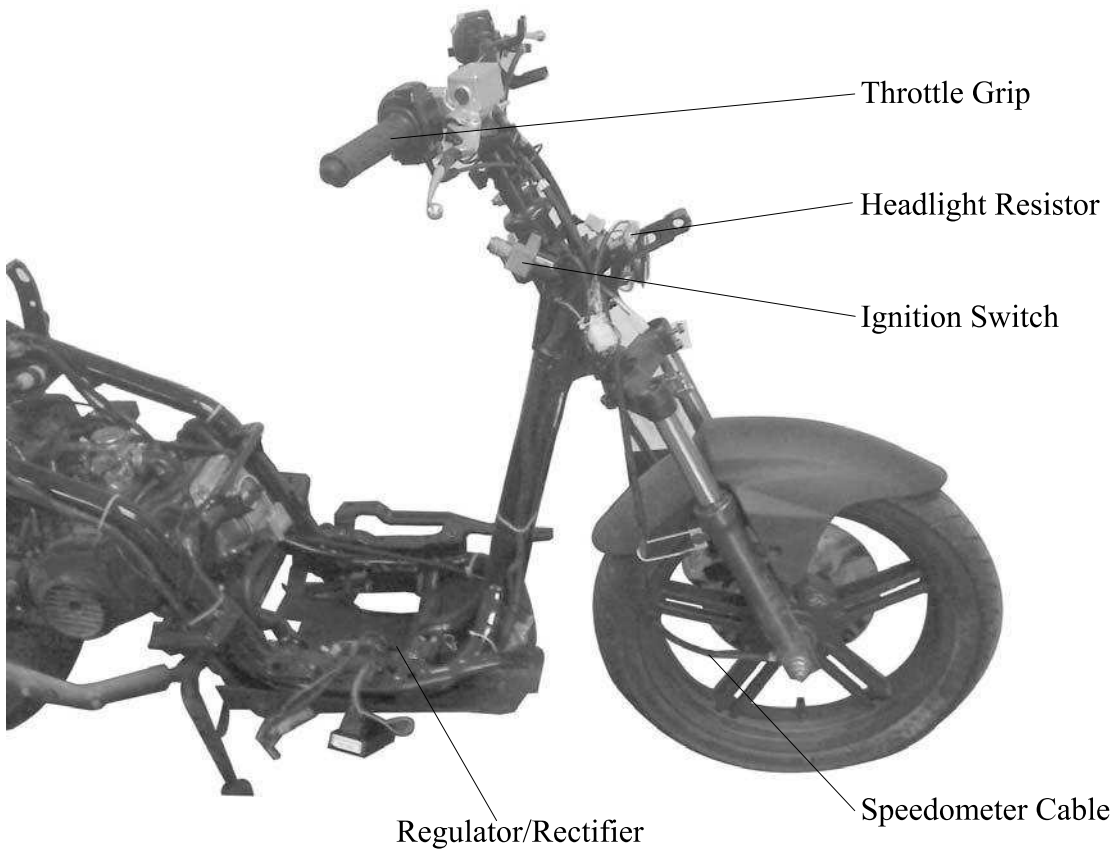

# 1. GENERAL INFORMATION

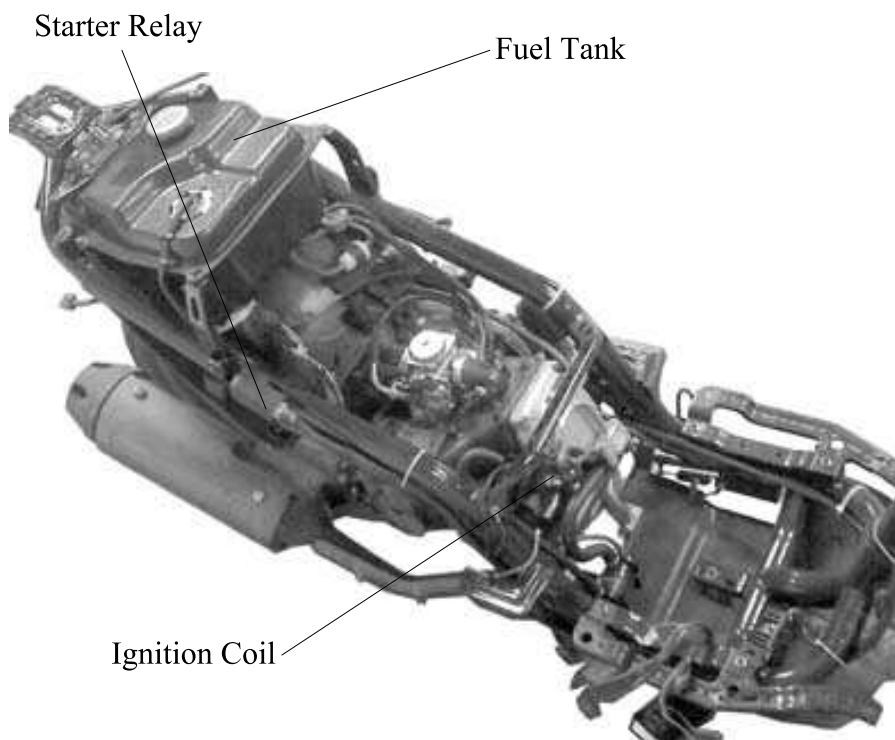
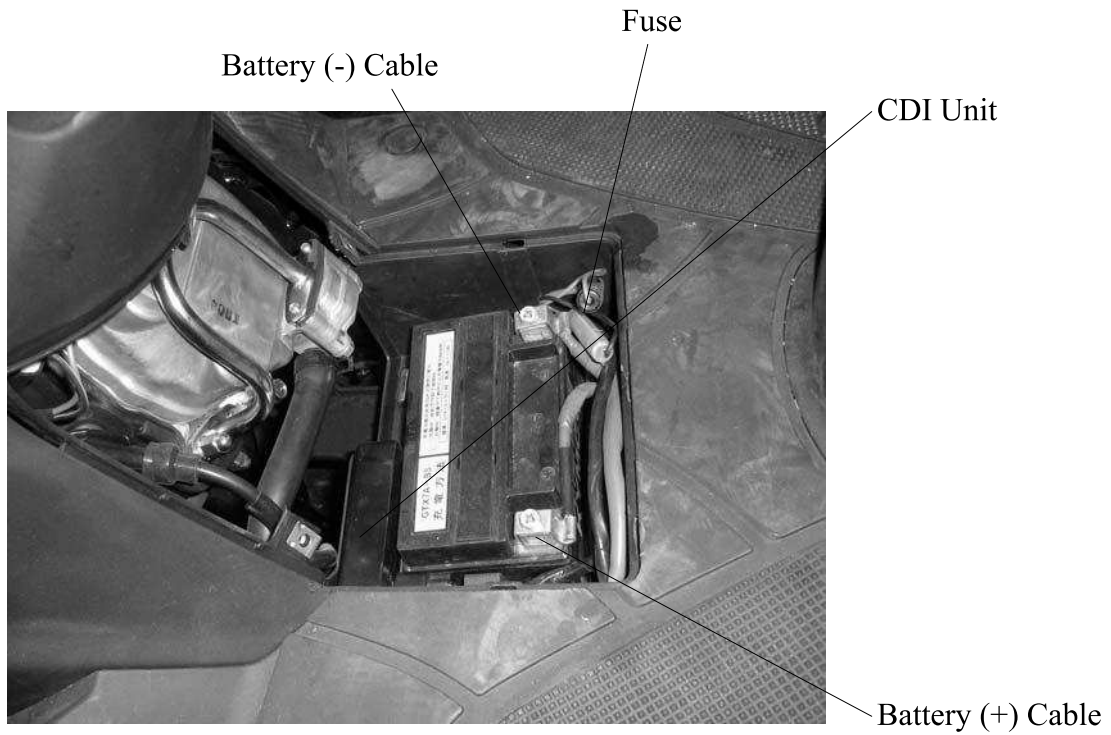

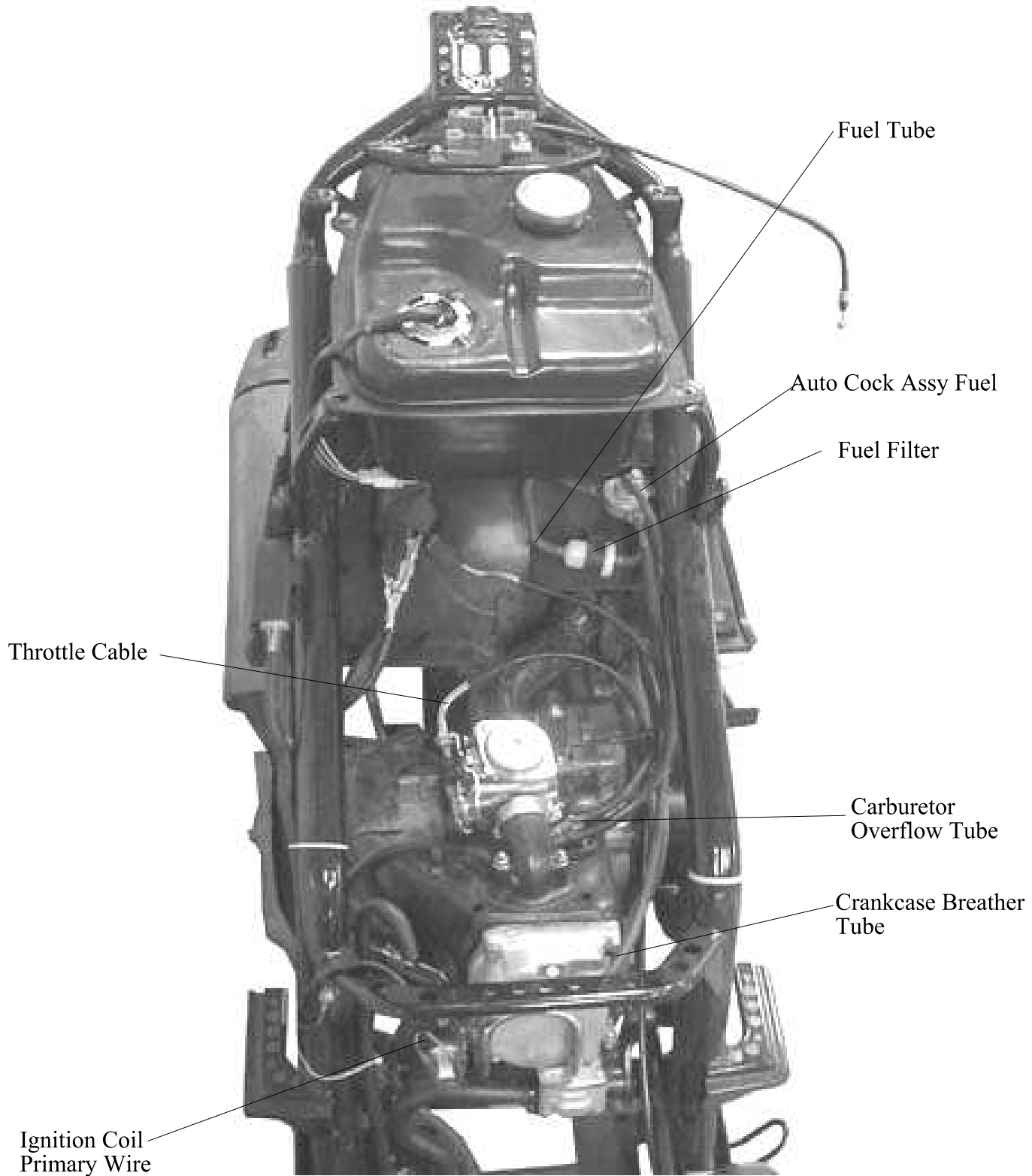

# 1. GENERAL INFORMATION

AGILITY CITY 125/150

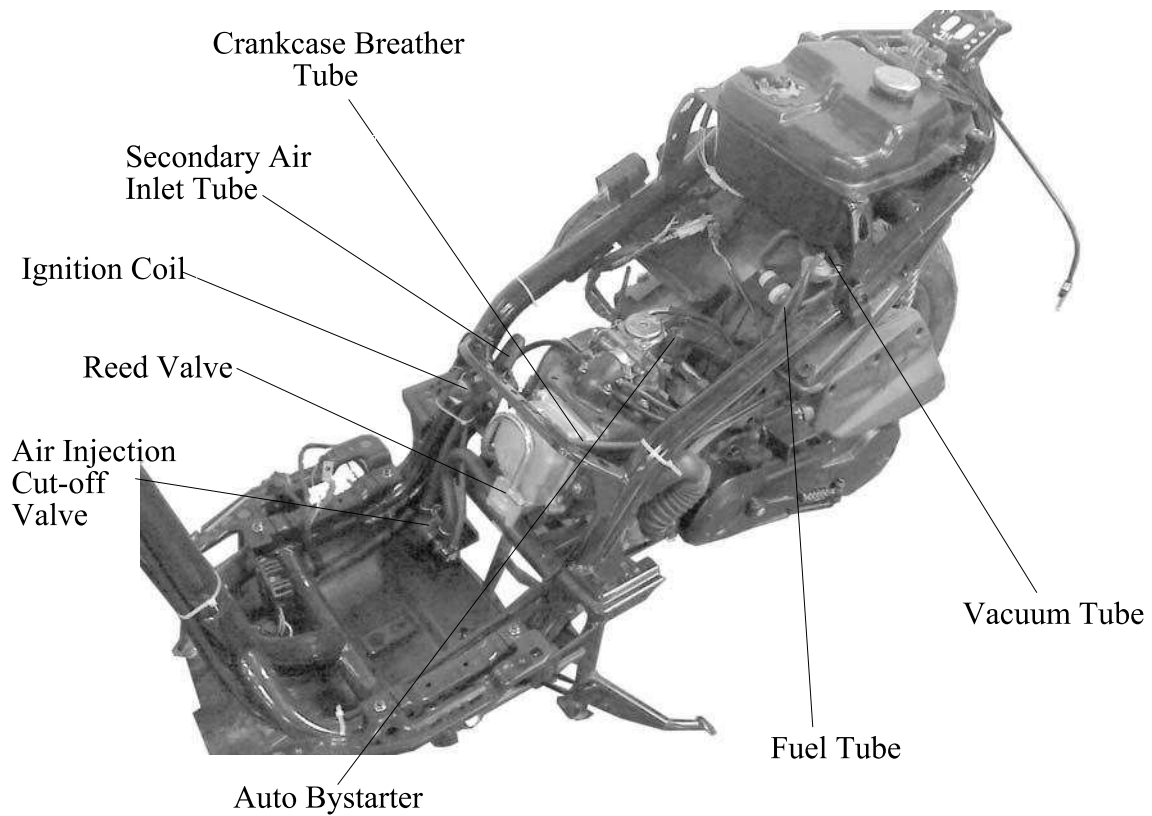
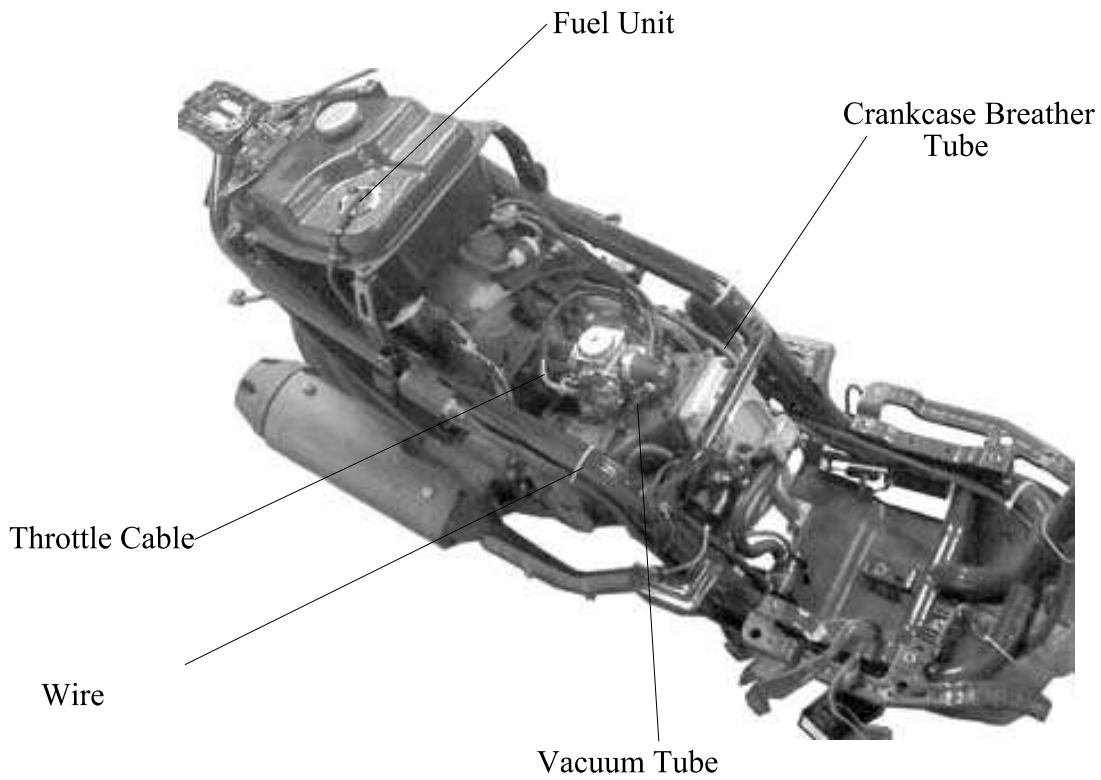

# 1. GENERAL INFORMATION

## AGILITY CITY 125/150

### WIRING DIAGRAM

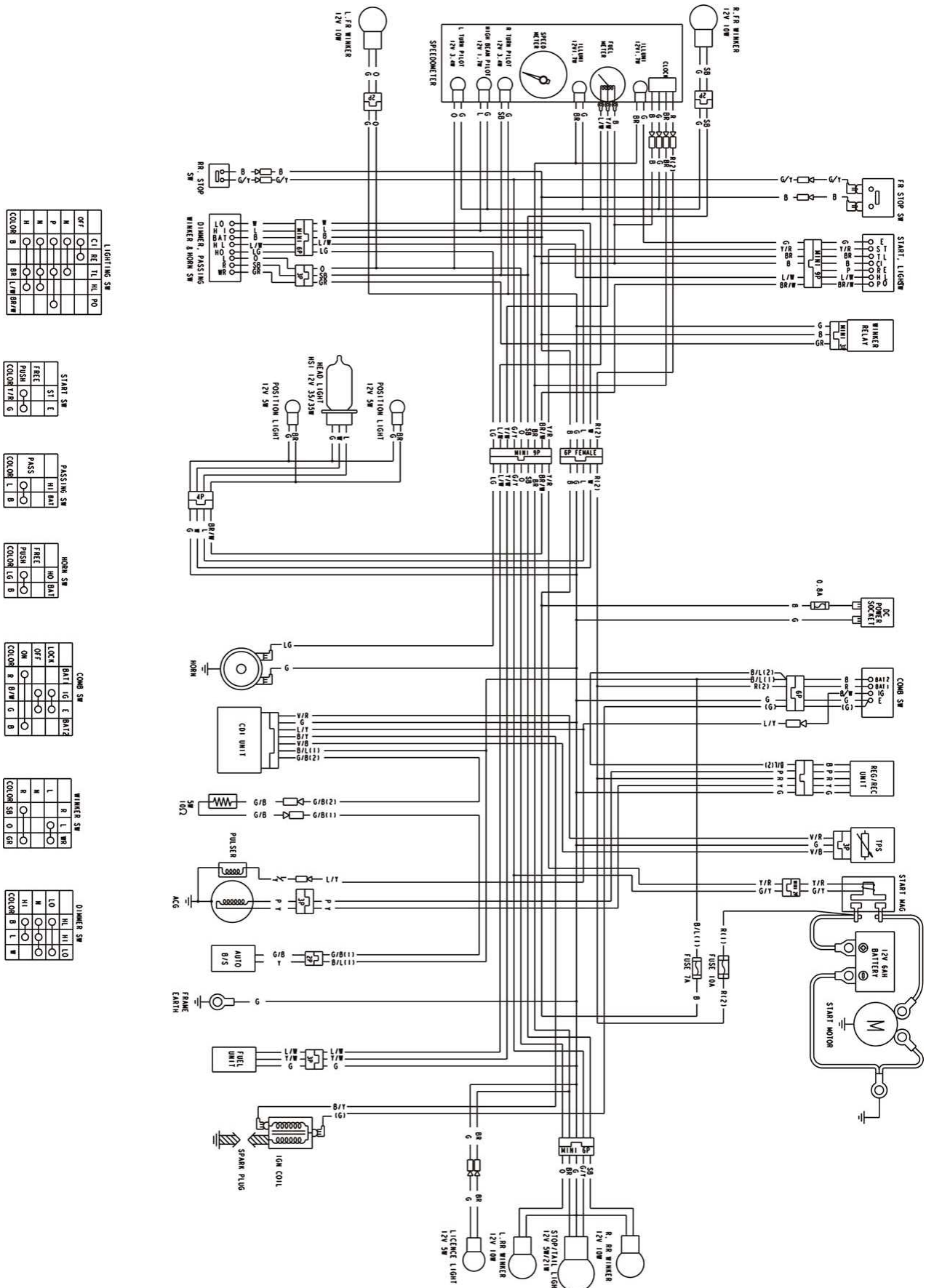

LIGHTING SW

C	L	RE	TL	HL	PO
OFF	○	○	○	○	○
N	○	○	○	○	○
P	○	○	○	○	○
N	○	○	○	○	○
H	○	○	○	○	○
COLOUR	B				

START SW

FREE	○	○	○	○
PUSH	○	○	○	○
COLOUR	V/R	G		

PASSING SW

HI	○	○	○
PASS	○	○	○
COLOUR	L	B	

HOON SW

HO	○	○	○
FREE	○	○	○
PUSH	○	○	○
COLOUR	G	B	

COMB SW

BAT1	IG	E	BAT2
LOCK	○	○	○
OFF	○	○	○
ON	○	○	○
COLOUR	R	B/W	G

WINNER SW

R	○	○	○
L	○	○	○
OFF	○	○	○
COLOUR	SB	O	GR

DIMMER SW

HL	○	○	○
HI	○	○	○
LO	○	○	○
OFF	○	○	○
N	○	○	○
HI	○	○	○
LO	○	○	○
COLOUR	B	L	W

# 1. GENERAL INFORMATION

AGILITY CITY 125/150

## TROUBLESHOOTING

### ENGINE WILL NOT START OR IS HARD TO START

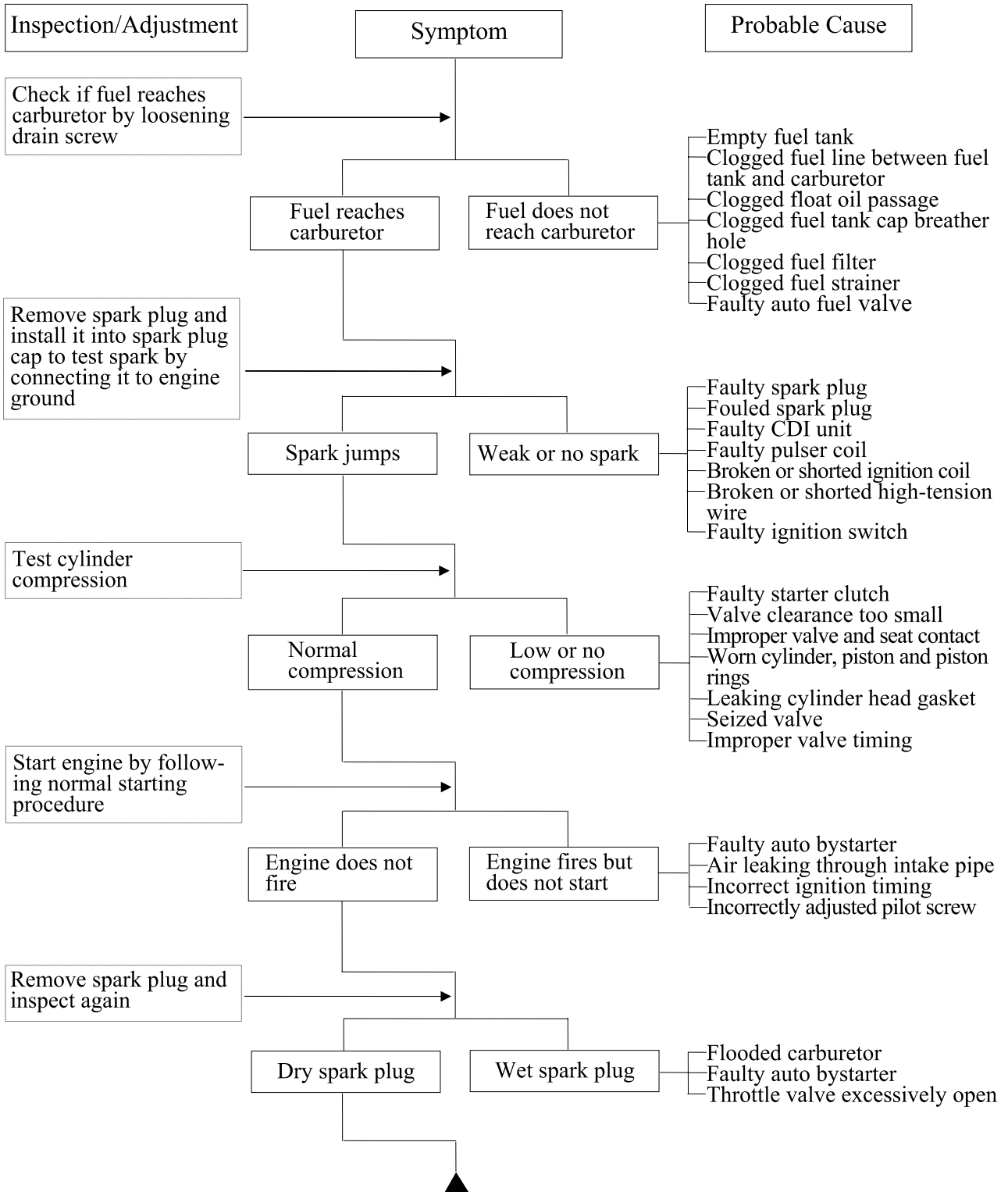

# 1. GENERAL INFORMATION

AGILITY CITY 125/150

## ENGINE LACKS POWER

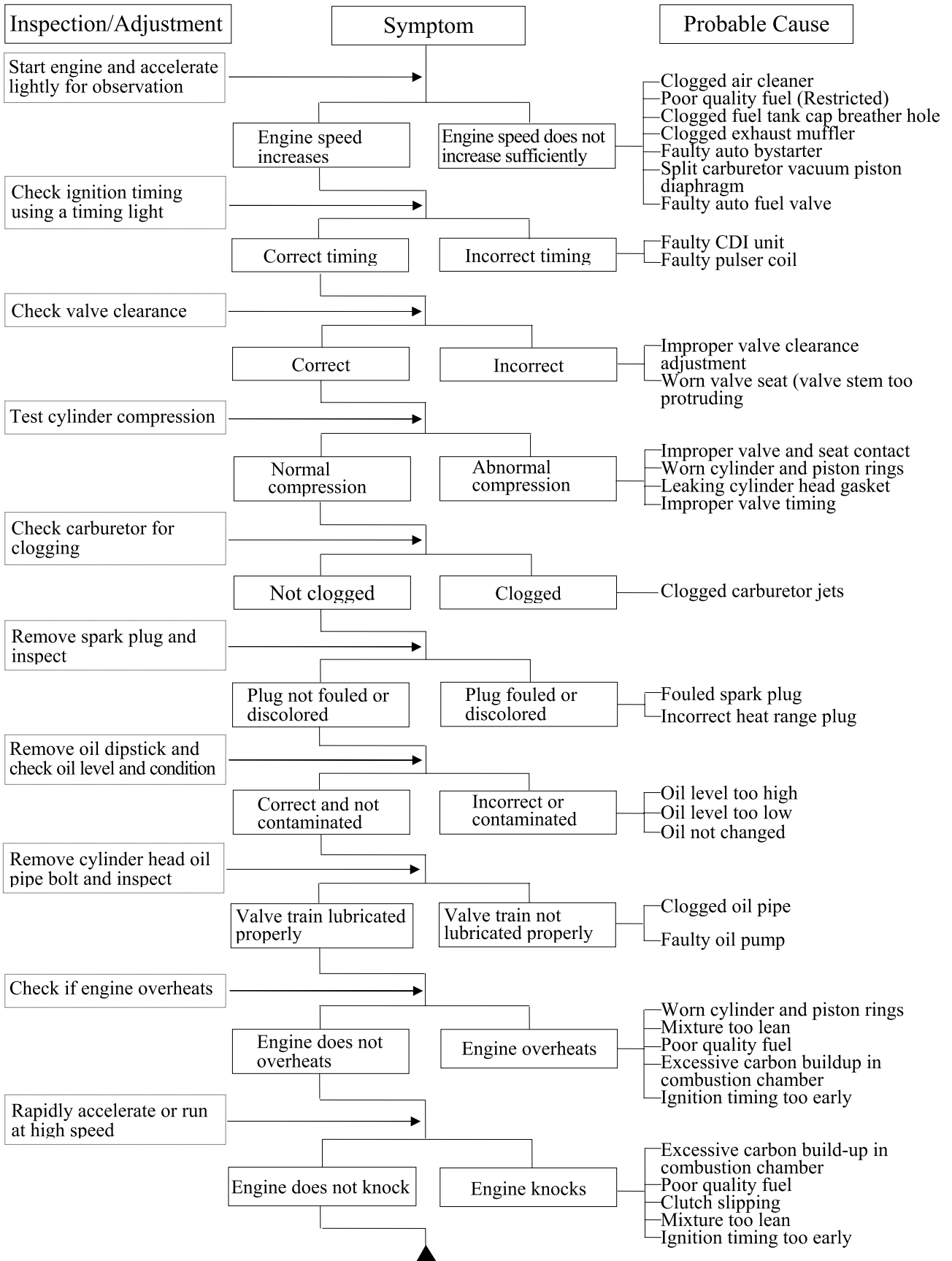

### POOR PERFORMANCE (ESPECIALLY AT IDLE AND LOW SPEEDS)

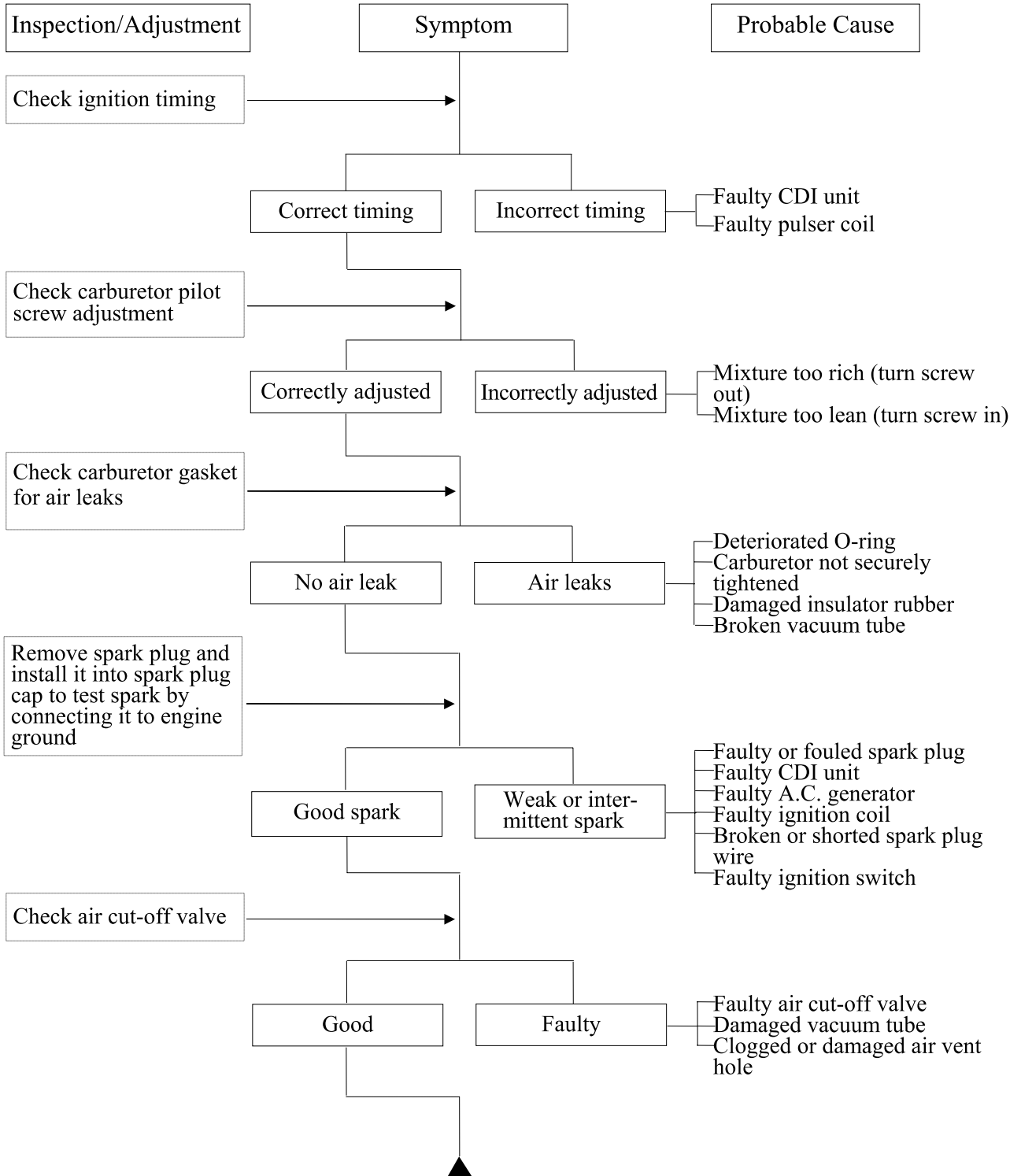



### POOR PERFORMANCE (AT HIGH SPEED)

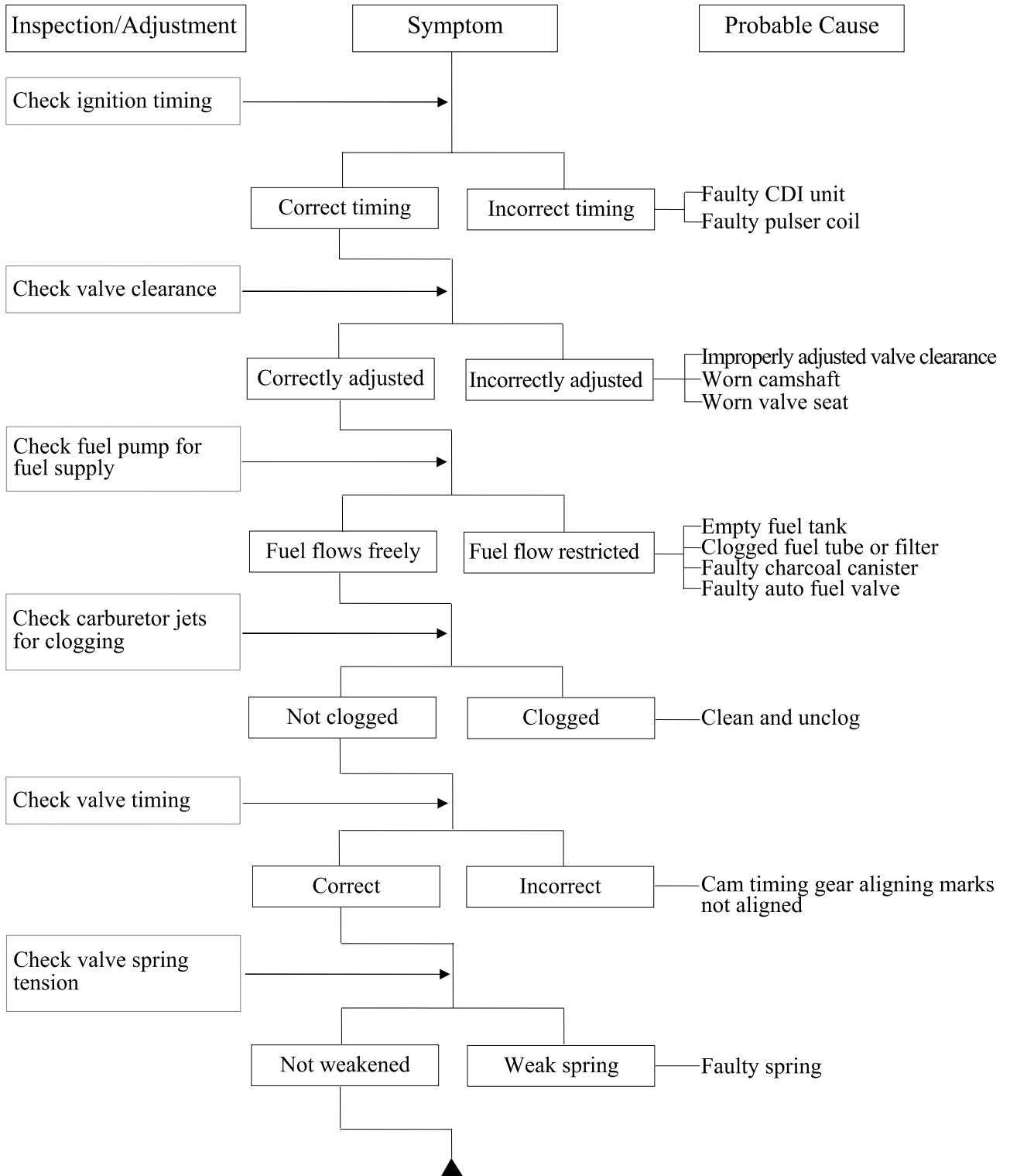

### POOR CHARGING (BATTERY OVER DISCHARGING OR OVERCHARGING)

#### Undercharging

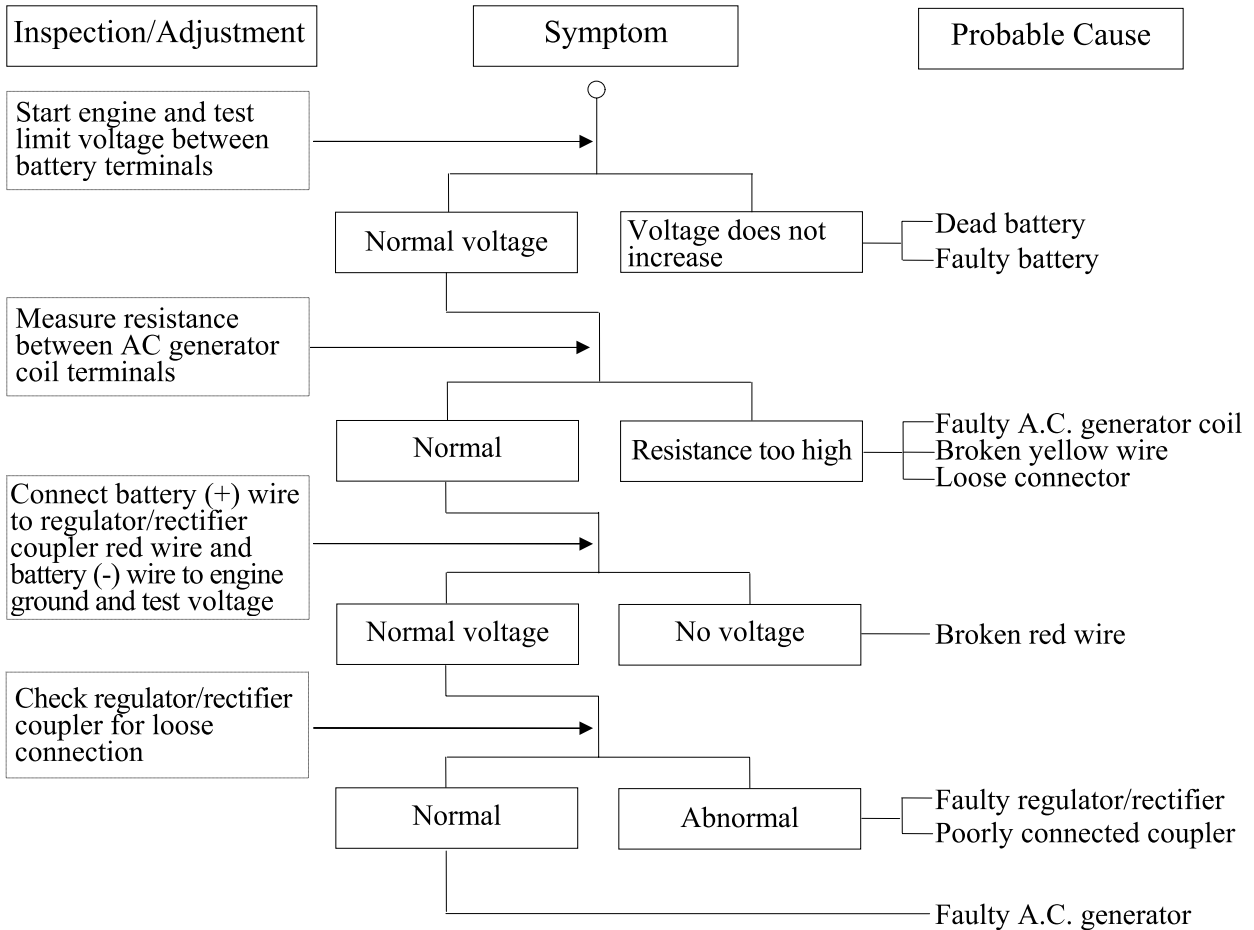

#### Overcharging

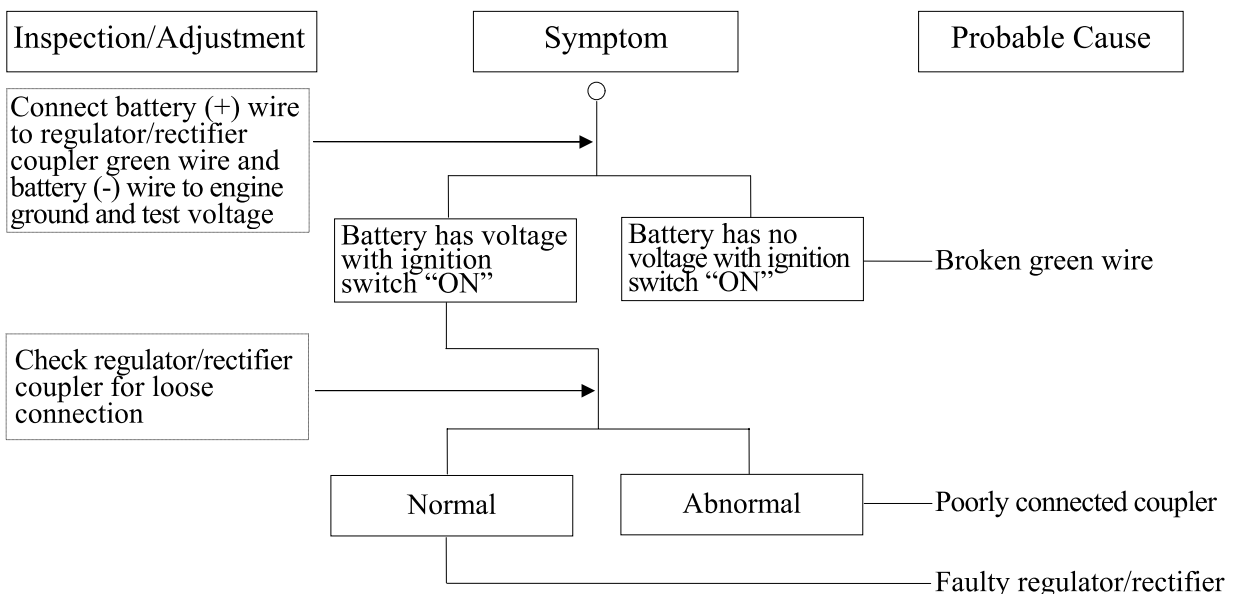

# 1. GENERAL INFORMATION

AGILITY CITY 125/150

## NO SPARK AT SPARK PLUG

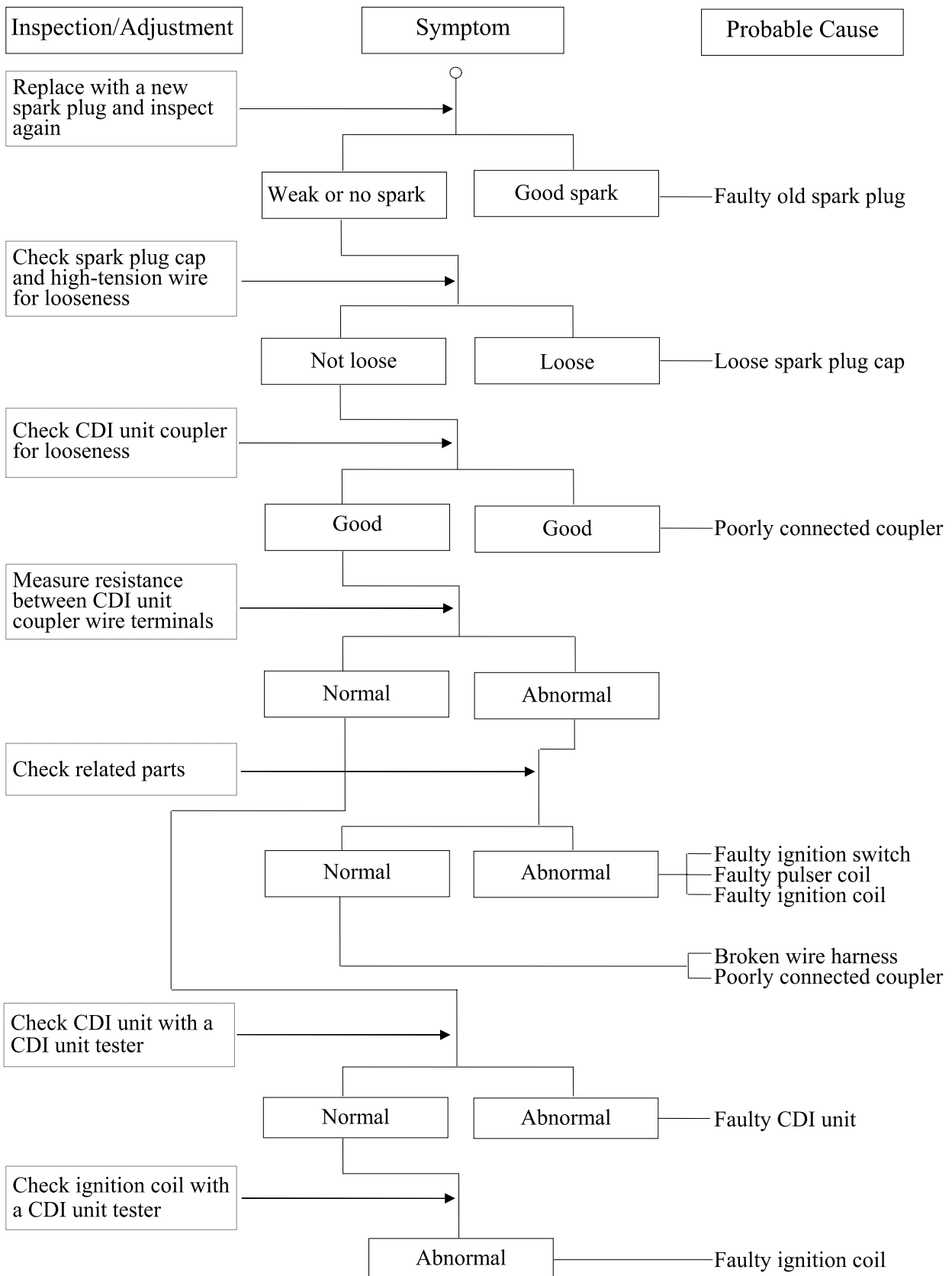

**2. FRAME COVERS/EXHAUST MUFFLER**

**SCHEMATIC DRAWING**

**2**

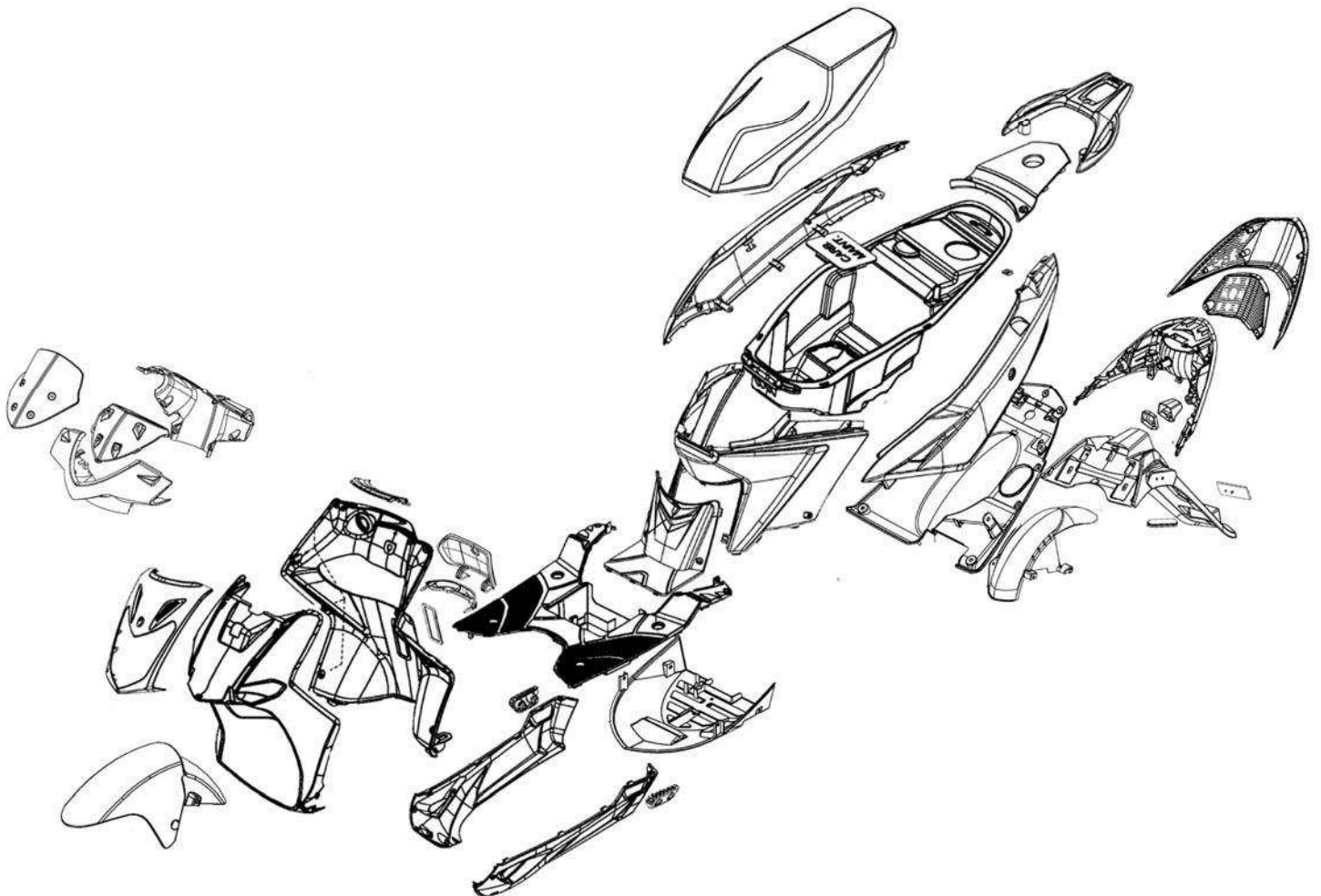

## 2. FRAME COVERS/EXHAUST MUFFLER

SERVICE INFORMATION .....	2-1	EXHAUST MUFFLER REMOVAL .....	2-5
FRAME COVERS .....	2-2		

### SERVICE INFORMATION

#### GENERAL INSTRUCTIONS

- When removing frame covers, use special care not to pull them by force because the cover joint claws may be damaged.

#### Items Related for Removal

- Handlebar front cover ——— Handlebar rear cover  
Headlight wire connector
- Handlebar rear cover ——— Speedometer cable and instrument light  
wire connectors, etc.
- Frame body cover ——— Met-in box, rear grip, rear turn signal  
lights, floor board
- Floor board ——— Frame body cover  
Battery and wire connectors
- Leg Shield ——— Front cover, floor board

#### TORQUE VALUES

- |                                |              |
|--------------------------------|--------------|
| Exhaust muffler joint lock nut | 1.0~1.4kgf-m |
| Exhaust muffler lock bolt      | 3.0~3.6kgf-m |

## 2. FRAME COVERS/EXHAUST MUFFLER

### FRAME COVERS

#### FRONT COVER REMOVAL

Remove the screw on the front cover and remove the front cover.  
 Remove the screws on the back of the mole assy front.  
 Remove the front brake fluid tube and speedometer cable  
 Remove the four bolt attaching the R/L front fork and remove the front fork.  
 Remove the mole assy  
 The installation sequence is the reverse of removal.

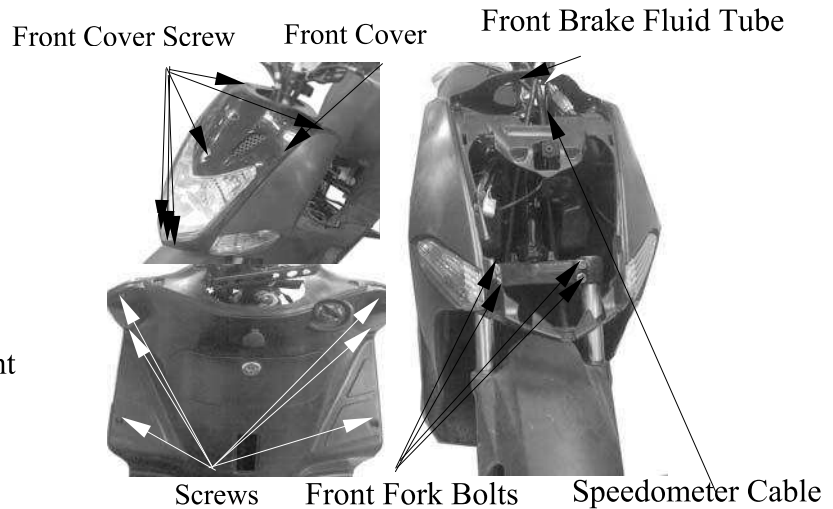

#### HANDLEBAR REAR COVER REMOVAL

Remove the handlebar rear cover screw.  
 Remove the clip mudguard attaching the sponge risor and sponge risor.  
 Disconnect the speedometer cable, right and left handlebar switch couplers, and the stop switch wire connectors.  
 Remove four screws inside the handlebar rear cover and remove the handlebar rear cover.  
 The installation sequence is the reverse of removal.

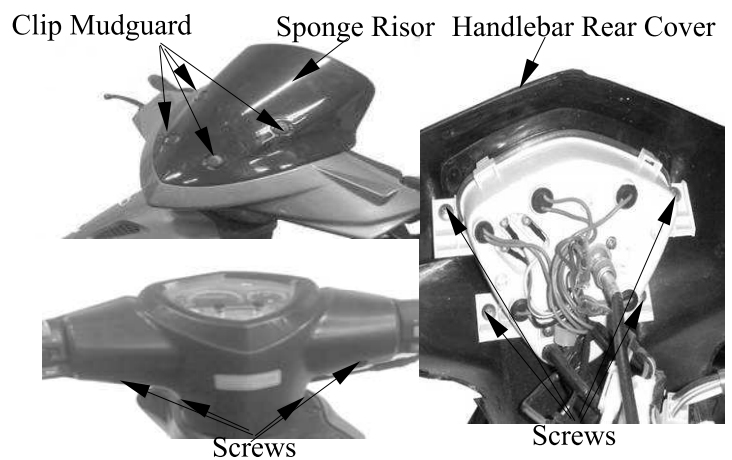

#### HANDLEBAR FRONT COVER REMOVAL

Remove the bolt attaching the handlebar front cover.  
 Remove the handlebar front cover.

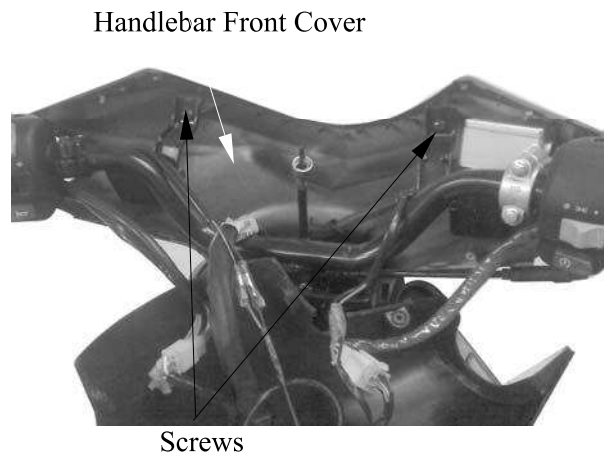

#### MET-IN BOX REMOVAL

Open the seat and remove the six bolt and two screws attaching the met-in box.  
 Remove the met-in box .

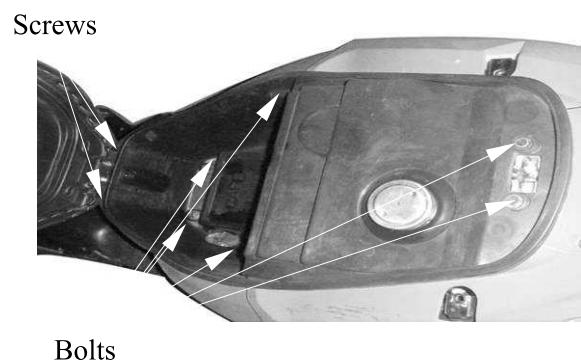

## 2. FRAME COVERS/EXHAUST MUFFLER

### FRAME BODY COVER REMOVAL

- Remove the two screws on the battery cover.
- Remove the battery cover
- Remove the six screws on the center cover
- Remove the center cover

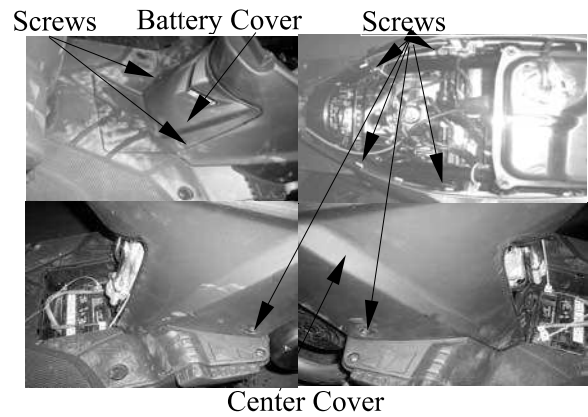

- Remove the three bolts attaching the rear carrier.
- Remove the rear carrier.

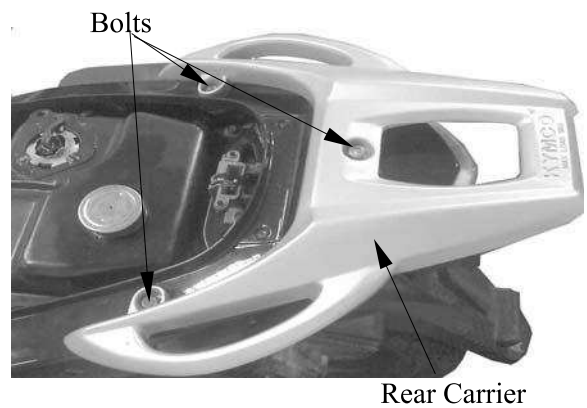

- Remove the two bolts attaching the left and right rear step.
- Remove the rear step

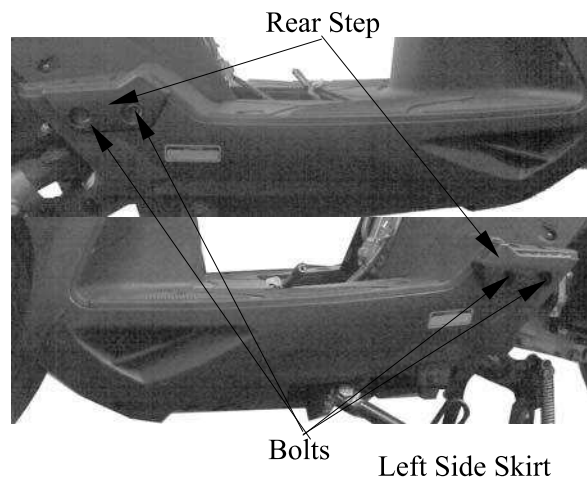

- Remove the six screws attaching the left side and right side skirt
- Remove the left side and right side skirt

\* During removal, do not pull the joint claws forcibly to avoid damage.  
When installing, be sure to connect the seat lock wire.

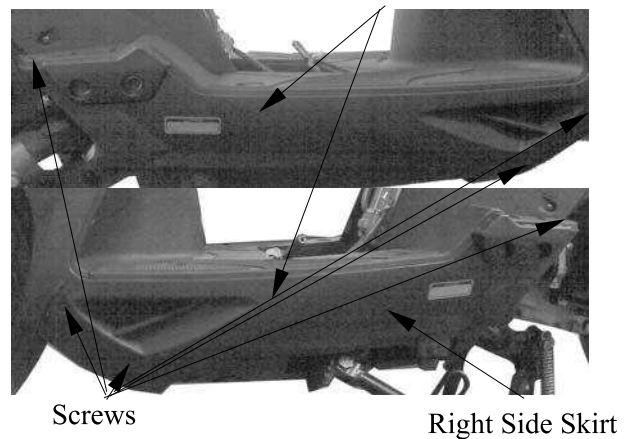

## 2. FRAME COVERS/EXHAUST MUFFLER

Remove the two screws on the center rear cover.

Remove the center rear cover.

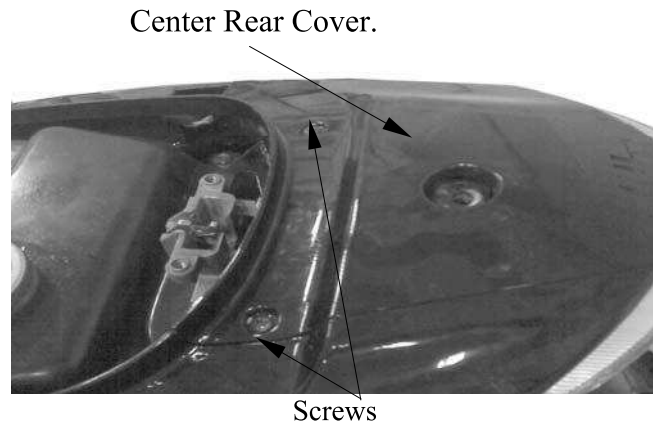

Remove the two bolts attaching the frame body cover.

Remove the three screws attaching the frame body cover.

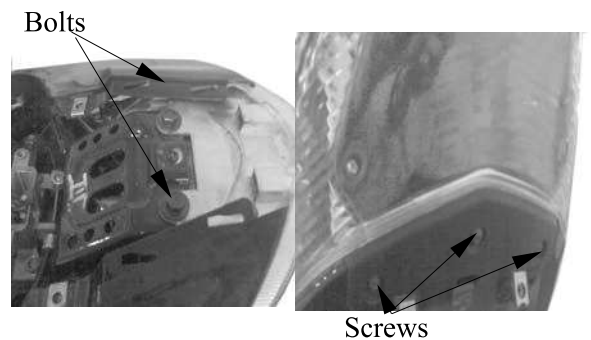

Remove the six screws attaching the frame body cover.

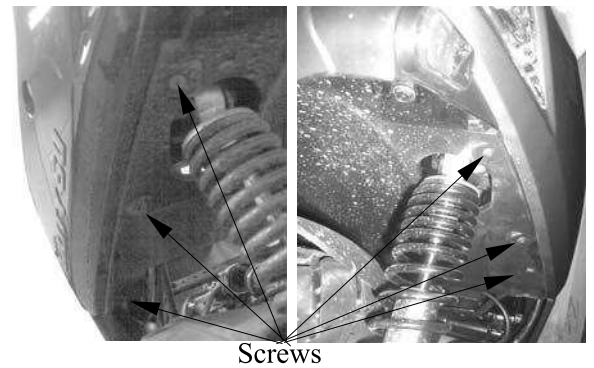

Remove the two bolts attaching the rear fender.

Disconnect the taillight wire connector

Remove the rear fender.

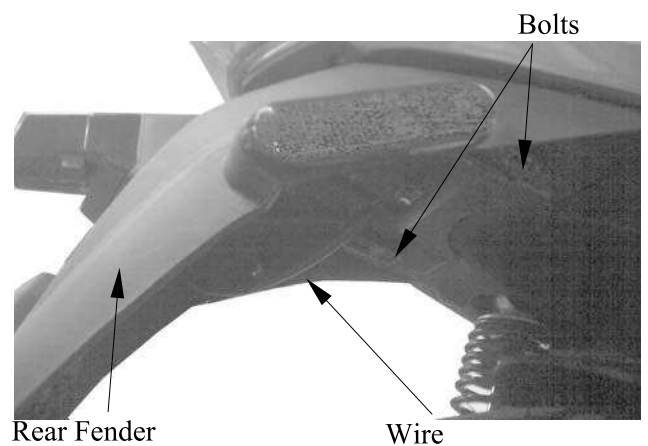



## 2. FRAME COVERS/EXHAUST MUFFLER

Discornnect the seat lock wire.  
 Discornnect the rear light wire connectors  
 Remove the left / right body cover and rear light.

The installation sequence is the reverse of remove

\* During removal, do not pull the joint claws forcedly to avoid damage.  
 When installing, be sure to connect the seat lock wire.

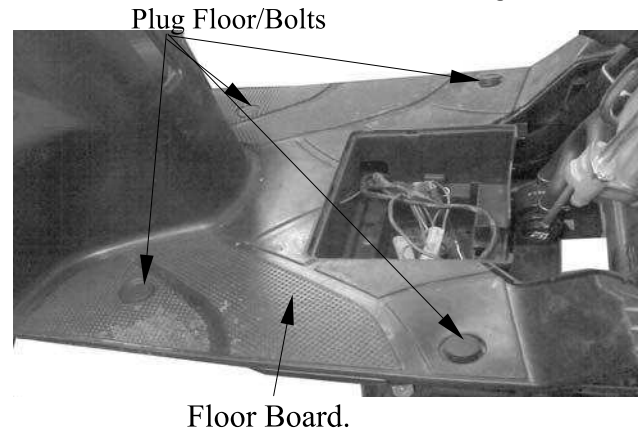
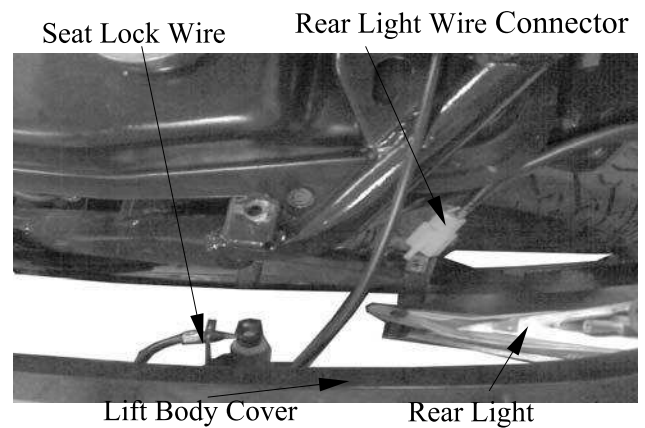

### FLOOR BOARD REMOVAL

Remove the rear carrier. (⇒2-3)  
 Remove the met-in box. (⇒2-3)  
 Remove the frame body cover. (⇒2-4)  
 Remove the four bolts attaching the floor board.  
 Remove the floor board.

### FRONT FENDER REMOVAL

Remove the L/R side bolts attaching the front fender and front fender.

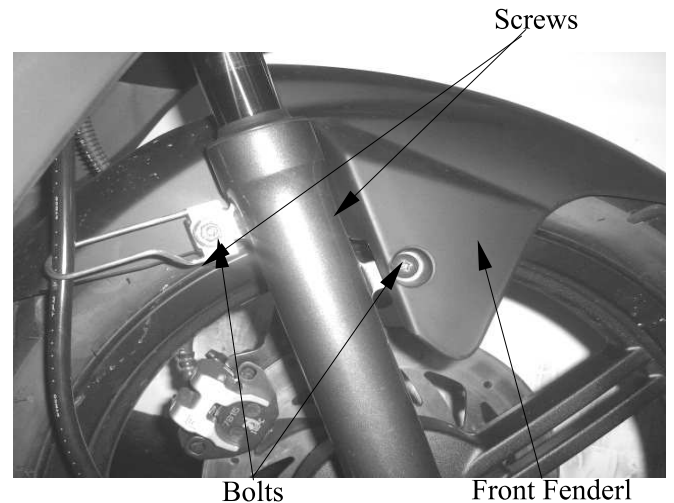

### LEG SHIELD REMOVAL

Remove the two clip body on the lid leg shield  
 Remove the lid leg shield.  
 The installation sequence is the reverse of remove

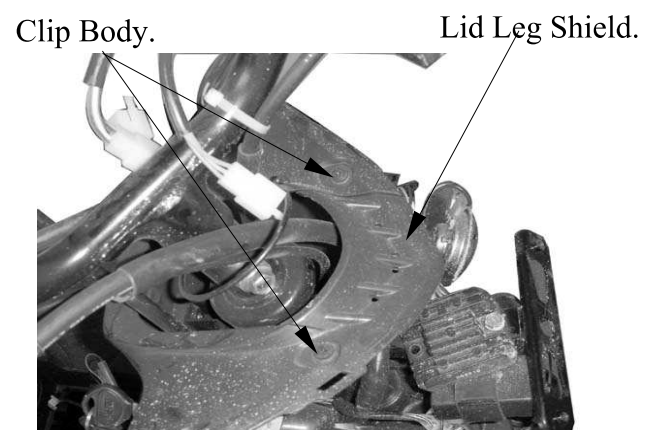

## 2. FRAME COVERS/EXHAUST MUFFLER

Remove the decorative ring.  
 Remove the leg shield.  
 Remove the bolt attaching the hook luggage.  
 Remove the hook luggage.  
 Remove the leg shield.  
 The installation sequence is the reverse of remove

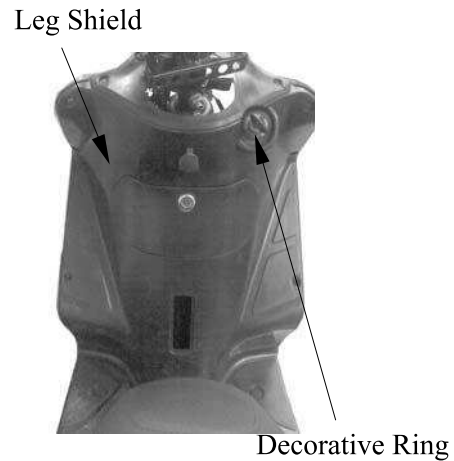

### EXHAUST MUFFLER REMOVAL

Remove the two exhaust muffler joint lock nuts.  
 Remove the three exhaust muffler lock bolts.  
 Remove the exhaust muffler.  
 Remove the exhaust muffler joint packing collar.

When installing, first install the exhaust muffler packing collar and then install the exhaust muffler.  
 First install and tighten the exhaust muffler joint lock nuts. Then, install and tighten the exhaust muffler lock bolts.

#### Torques:

Exhaust muffler lock bolt: 3.0~3.6kgf-m  
 Exhaust muffler joint lock nut: 1.0~1.4kgf-m

\* Be sure to install a new exhaust muffler packing collar.

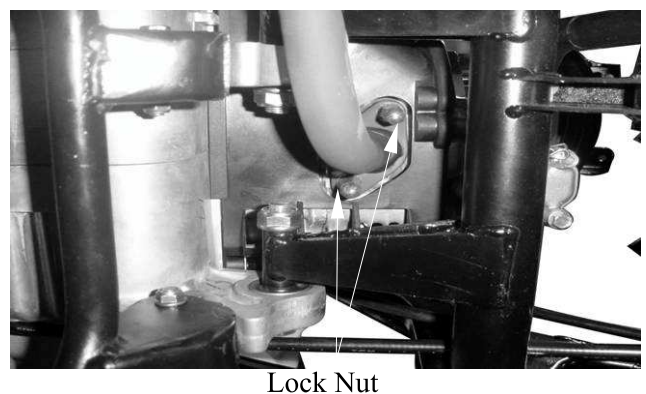
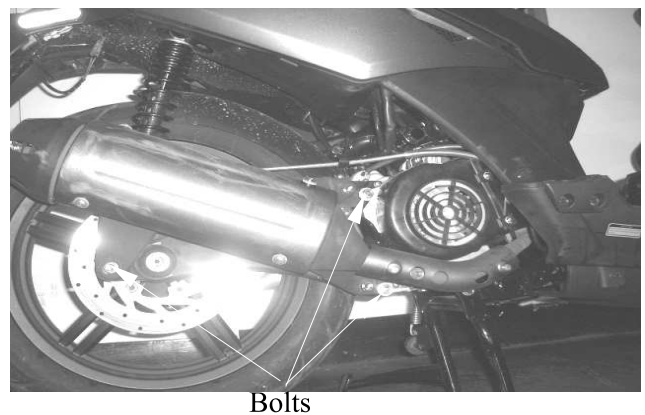

### 3. INSPECTION/ADJUSTMENT

**3**

SERVICE INFORMATION.....3-0	FINAL REDUCTION GEAR OIL.....3- 7
MAINTENANCE SCHEDULE.....3-2	DRIVE BELT.....3- 7
FUEL FILTER.....3-3	BRAKE SHOE .....3- 8
THROTTLE OPERATION.....3-3	BRAKE ADJUSTING NUT.....3- 8
AIR CLEANER .....3-4	HEADLIGHT AIM .....3- 9
SPARK PLUG .....3-4	CLUTCH SHOE WEAR.....3- 9
VALVE CLEARANCE .....3-5	SUSPENSION .....3- 9
CARBURETOR IDLE SPEED .....3-5	NUTS/BOLTS/FASTENERS.....3-10
IGNITION TIMING .....3-6	WHEELS/TIRES.....3-10
CYLINDER COMPRESSION .....3-6	STEERING HANDLEBAR .....3-11

#### SERVICE INFORMATION

##### GENERAL

##### WARNING

- Before running the engine, make sure that the working area is well-ventilated. Never run the engine in a closed area. The exhaust contains poisonous carbon monoxide gas which may cause death to people.
- Gasoline is extremely flammable and is explosive under some conditions. The working area must be well-ventilated and do not smoke or allow flames or sparks near the working area or fuel storage area.

##### SPECIFICATIONS

###### ENGINE

Throttle grip free play : 2~6mm  
 Spark plug gap : 0.6~0.7mm  
 Spark plug : NGK CR7HSA

Valve clearance : IN: 0.12mm  
 : EX: 0.12mm

Idle speed : 1700 ±100rpm

###### Engine oil capacity:

At disassembly : 0.9 liter

At change : 0.8 liter

###### Gear oil capacity :

At disassembly : 0.2 liter

At change : 0.18 liter

### 3. INSPECTION/ADJUSTMENT

---

Cylinder compression : 13/15±2

Ignition timing: BTDC 28°/4000rpm

#### CHASSIS

Front brake free play: 10~20mm

Rear brake free play : 10~20mm

#### TIRE PRESSURE

	1 Rider	2 Riders
Front	1.5kg/cm <sup>2</sup>	1.75kg/cm <sup>2</sup>
Rear	2.0kg/cm <sup>2</sup>	2.25kg/cm <sup>2</sup>

#### TIRE SIZE:

Front : 100/80-16

Rear : 120/80-16

#### TORQUE VALUES

Front axle nut 5.0~7.0kgf-m

Rear axle nut 11~13kgf-m

### 3. INSPECTION/ADJUSTMENT

#### MAINTENANCE SCHEDULE

Perform the periodic maintenance at each scheduled maintenance period.

I: Inspect, and Clean, Adjust, Lubricate or Replace if necessary.

A: Adjust C: Clean R: Replace T: Tighten

Item	Frequency	Whichever comes first ⇄ ↓	Regular Service Mileage (km)											
			1000	2000	3000	4000	5000	6000	7000	8000	9000	10000	11000	12000
Engine oil			R New Motorcycle 300km	R		R		R		R		R		R
Engine oil filter screen						C				C				
Fuel filter screen												R		
Gear oil	Note 3		R New motorcycle 300km				R					R		
Valve clearance				A		A				A				A
Carburetor						I				I				C
Air Cleaner	Note 2,3		Replace at every 2000km											
Spark plug			Clean at every 3000km and replace if necessary											
Brake system			I	I	I	I	I	I	I	I	I	I	I	I
Drive belt										I				
Suspension						I				I				I
Nut, bolt, fastener										I				
Tire						I				I				I
Steering head bearing			I						I					I

- In the interest of safety, we recommend these items should be serviced only by an authorized KYMCO motorcycle dealer.

Note: 1. For higher odometer readings, repeat at the frequency interval established here.

2. Service more frequently when riding in dusty or rainy areas.

3. Service more frequently when riding in rain or at full throttle.

### 3. INSPECTION/ADJUSTMENT

#### FUEL FILTER

Remove the met-in box. (⇒2-3)  
 Check the fuel lines and replace any parts which show signs of deterioration, damage or leakage.

Do not smoke or allow flames or sparks in your working area.

Fuel Filter



Fuel Line

#### THROTTLE OPERATION

Check the throttle grip for smooth movement.  
 Measure the throttle grip free play.

**Free Play:** 2~6mm

2~6mm



Major adjustment of the throttle grip free play is made at the carburetor side.  
 Adjust by loosening the lock nut and turning the adjusting nut.



Lock Nut

Adjusting Nut

Minor adjustment is made with the adjusting nut at the throttle grip side.  
 Slide the rubber cover out and adjust by loosening the lock nut and turning the adjusting nut.



### 3. INSPECTION/ADJUSTMENT

Adjusting Nut

Lock Nut

#### AIR CLEANER

##### AIR CLEANER REPLACEMENT

Remove the air cleaner case cover screws and the cover by removing the six screws.

Remove the air cleaner element by removing the four screws.

Check the element and replace it if it is excessively dirty or damaged.

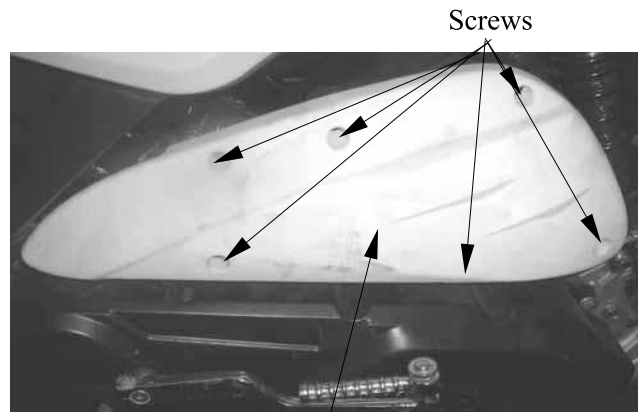

Air Cleaner Case Cover

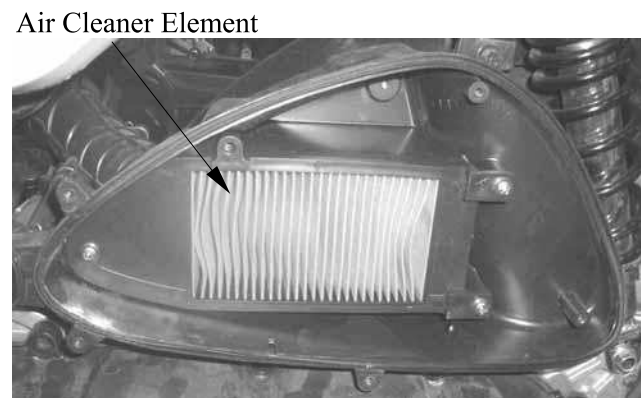

#### CHANGE INTERVAL

More frequent replacement is required when riding in unusually dusty or rainy areas.

- The air cleaner element has a viscous type paper element. Do not clean it with any fluid.
- Be sure to install the air cleaner element and cover securely.

#### SPARK PLUG

Remove the spark plug.

Check the spark plug for wear and fouling deposits.

Clean any fouling deposits with a spark plug cleaner or a wire brush.

##### Specified Spark Plug:

CHAMPION-P-RZ9HC

NGK CR7HSA

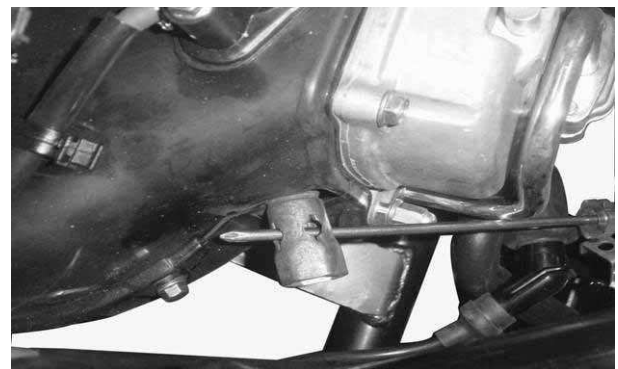

Measure the spark plug gap.

**Spark Plug Gap:** 0.6~0.7mm

When installing, first screw in the spark plug by hand and then tighten it with a spark plug wrench.

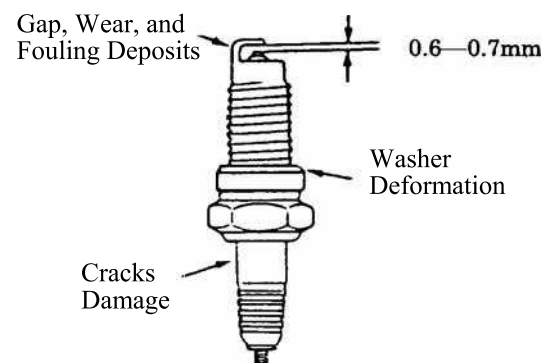

### 3. INSPECTION/ADJUSTMENT

#### VALVE CLEARANCE

Inspect and adjust valve clearance while the engine is cold (below 35°C).

- Remove the frame cover. (⇒2-3)
- Remove the six bolts on the cylinder head cover.
- Remove the cylinder head cover. (⇒7-3)
- Remove the cylinder head cover..

Cylinder Head Cover



Bolts

Turn the flywheel counterclockwise so that the "T" mark on the flywheel aligns with the index mark on the crankcase to bring the round hole on the camshaft gear facing up to the top dead center on the compression stroke.

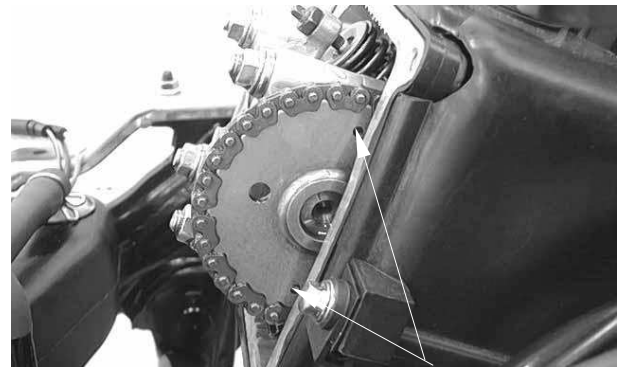

Round Hole

Inspect and adjust the valve clearance.

**Valve Clearance:** IN : 0.12mm  
EX: 0.12mm

Loosen the lock nut and adjust by turning the adjusting nut

Special

Tappet Adjuster

- Check the valve clearance again after the lock nut is tightened.

Tappet Adjuster

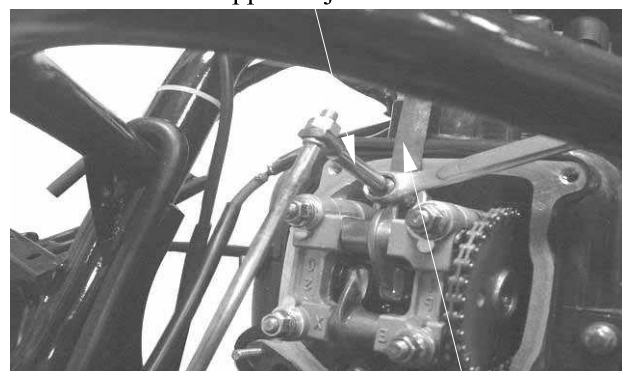

Feeler Gauge

#### CARBURETOR IDLE SPEED

- The engine must be warm for accurate idle speed inspection and adjustment.

Remove the inspection cover.  
Warm up the engine before this operation.  
Start the engine and connect a tachometer.  
Turn the throttle stop screw to obtain the specified idle speed.

**Idle Speed:** 1700±100rpm

When the engine misses or run erratic, adjust the pilot screw.





### 3. INSPECTION/ADJUSTMENT

**SUPER8 50**

Throttle Stop Screw

combustion chamber and the piston head.

#### IGNITION TIMING

The CDI unit is not adjustable. If the ignition timing is incorrect, check the ignition system. (⇒15-5)

Remove the right of the fan cover.

Timing Hole Cap



Check the ignition timing with a timing light. When the engine is running at idle speed, the ignition timing is correct if the "F" mark on the flywheel aligns with the index mark on the crankcase.

Timing Light



Also use a timing light to check the advance. Raise the engine speed to 4,000rpm and the index mark on the crankcase cover should be aligned with the advance mark on the flywheel.

#### CYLINDER COMPRESSION

Warm up the engine before compression test. Remove the met-in box and center cover. (⇒2-3)

Remove the spark plug.

Insert a compression gauge.

Open the throttle valve fully and push the starter button to test the compression.

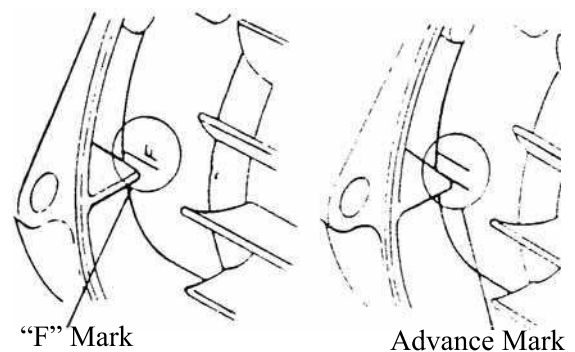

"F" Mark

Advance Mark

**Compression:** 13/15kg/cm<sup>2</sup>rpm

If the compression is low, check for the following:

- Leaky valves
- Valve clearance too small
- Leaking cylinder head gasket
- Worn piston rings
- Worn piston/cylinder

If the compression is high, it indicates that carbon deposits have accumulated on the

Compression Gauge



### 3. INSPECTION/ADJUSTMENT

#### FINAL REDUCTION GEAR OIL OIL LEVEL CHECK

Place the motorcycle on its main stand on level ground for oil level check.

Stop the engine and remove the oil check bolt. The oil level shall be at the oil check bolt hole.

If the oil level is low, add the recommended oil to the proper level.

**Recommended Oil: SAE90#**

Install the oil check bolt.

Make sure that the sealing washer is in good condition.

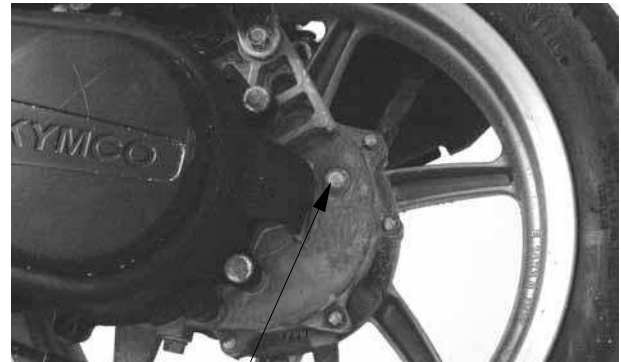

Oil Check Bolt/Sealing Washer

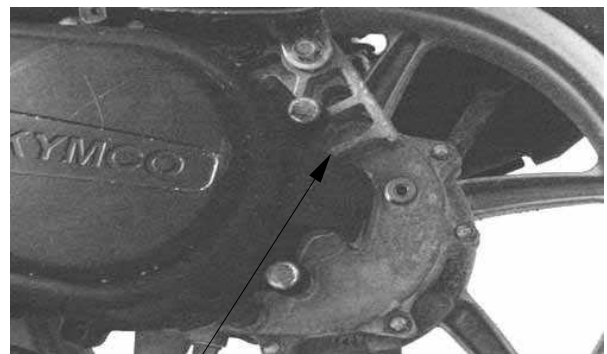

Oil Check Bolt Hole

#### OIL CHANGE

Remove the oil check bolt.

Remove the oil drain bolt and drain the oil thoroughly.

Install the oil drain bolt.

**Torque: 0.8~1.2kgf-m**

Make sure that the sealing washer is in good condition.

Fill with the recommended oil.

**Oil Capacity:** At disassembly : 0.20 liter  
At change : 0.18 liter

Reinstall the oil check bolt and check for oil leaks.

**Torque: 0.8~1.2kgf-m**

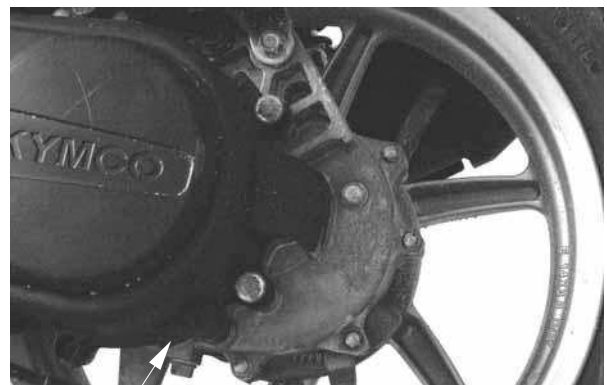

Oil Drain Bolt/ Sealing Washer

#### DRIVE BELT

Remove the left crankcase cover. (⇨9-2)

Inspect the drive belt for cracks or excessive wear.

Replace the drive belt with a new one if necessary and in accordance with the Maintenance Schedule.

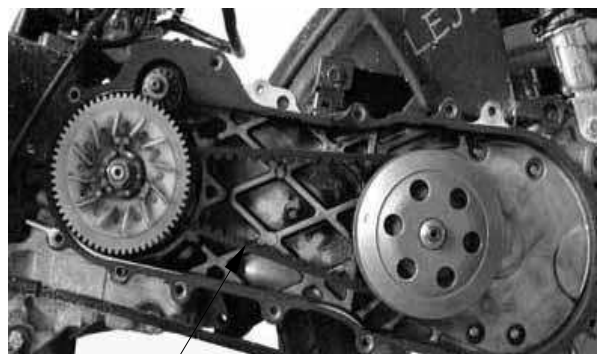

### 3. INSPECTION/ADJUSTMENT

Drive Belt

#### BRAKE SHOE

Replace the brake shoes if the arrow on the wear indicator plate aligns with the punch mark on the brake panel when the brake is fully applied.

Refer to page 12-7 and 13-3 for brake shoe replacement.

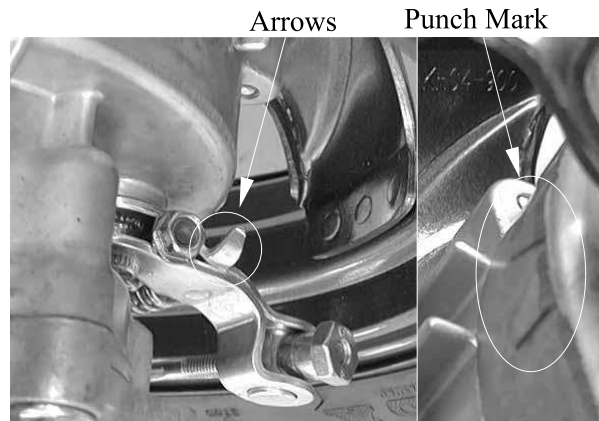

#### REAR BRAKE

Measure the rear brake lever free play.

**Free Play:** 10~20mm



#### BRAKE ADJUSTING NUT

If the free play do not fall within the limit, adjust by turning the adjusting nut.

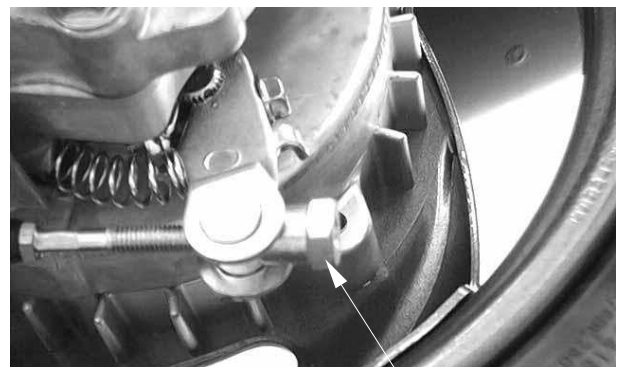

Adjusting Nut

#### FRONT/REAR BRAKE FLUID

Turn the steering handlebar upright and check if the rear brake fluid level should be between the upper and lower level lines.

**Specified Brake Fluid:** DOT-4 ◦

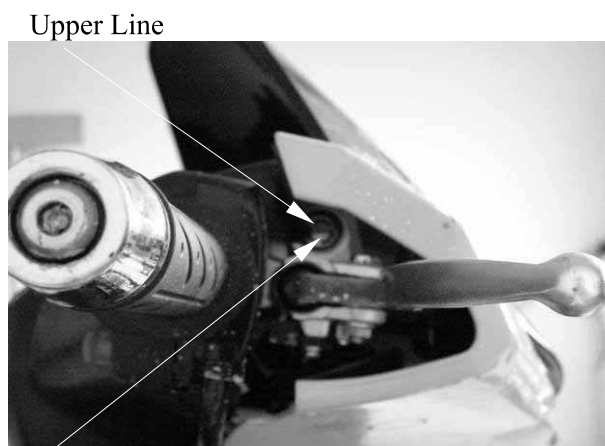

Lower Line

### 3. INSPECTION/ADJUSTMENT

If the free play do not fall within the limit, adjust by turning the adjusting nut.



Adjusting Nut

#### HEADLIGHT AIM

Turn the ignition switch ON and start the engine.

Turn on the headlight switch.

Adjust the headlight aim by turning the headlight aim adjusting screw.

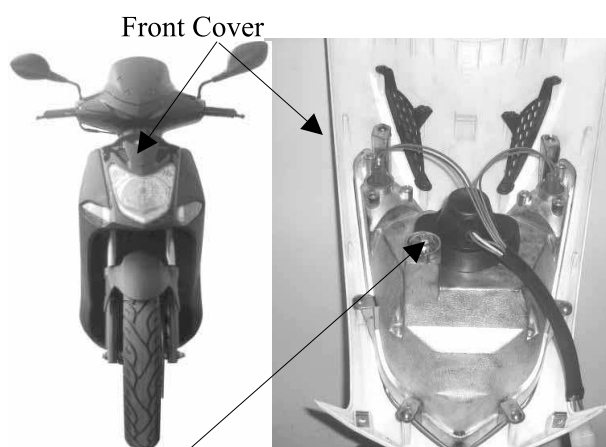

Adjusting Screw

#### CLUTCH SHOE WEAR

Start the engine and check the clutch operation by increasing the engine speed gradually.

If the motorcycle tends to creep, or the engine stalls, check the clutch shoes for wear and replace if necessary. (⇒9-11)



Clutch

#### SUSPENSION

##### FRONT

Fully apply the front brake lever and check the action of the front shock absorbers by compressing them several times.

Check the entire shock absorber assembly for oil leaks, looseness or damage.



### 3. INSPECTION/ADJUSTMENT

#### REAR

Check the action of the rear shock absorber by compressing it several times.  
 Check the entire shock absorber assembly for oil leaks, looseness or damage.  
 Jack the rear wheel off the ground and move the rear wheel sideways with force to see if the engine hanger bushings are worn.



#### NUTS/BOLTS/FASTENERS

Check all important chassis nuts and bolts for looseness.  
 Tighten them to their specified torque values if any looseness is found. (⇒ 1-11)

#### WHEELS/TIRES

Check the tires for cuts, imbedded nails or other damages.

Check the tire pressure.

Tire pressure should be checked when tires are cold.



#### TIRE PRESSURE

	1 Rider	2 Riders
Front	1.5kg/cm <sup>2</sup>	1.75kg/cm <sup>2</sup>
Rear	2.00kg/cm <sup>2</sup>	2.25kg/cm <sup>2</sup>

#### TIRE SIZE

**Front:** 100/80-16

**Rear :** 120/80-16

Check the front axle nut for looseness.  
 Check the rear axle nut for looseness.  
 If the axle nuts are loose, tighten them to the specified torques.

**Torques: Front :** 5.0~7.0kgf-m

**Rear :** 11~13kgf-m

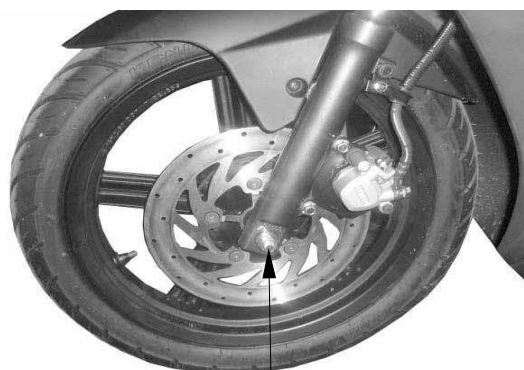

Front Axle Nut

### 3. INSPECTION/ADJUSTMENT

---

#### STEERING HANDLEBAR

Check that the control cables do not interfere with handlebar rotation.

Raise the front wheel off the ground and check that the steering handlebar rotates freely.

If the handlebar moves unevenly, binds, or has vertical movement, adjust the steering head bearing.

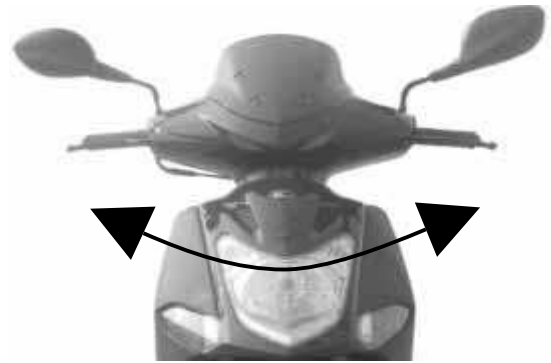

## 4. LUBRICATION SYSTEM

---

---

---

---

---

---

---

---

---

---

**4**

### LUBRICATION SYSTEM

---

SERVICE INFORMATION-----	4- 1
TROUBLESHOOTING-----	4- 1
ENGINE OIL/OIL FILTER -----	4- 2
OIL PUMP-----	4- 2

## 4. LUBRICATION SYSTEM

---

### SERVICE INFORMATION

#### GENERAL INSTRUCTIONS

- The maintenance of lubrication system can be performed with the engine installed in the frame.
- Use care when removing and installing the oil pump not to allow dust and foreign matters to enter the engine and oil line.
- Do not attempt to disassemble the oil pump. The oil pump must be replaced as a set when it reaches its service limit.
- After the oil pump is installed, check each part for oil leaks.

#### SPECIFICATIONS

Item		Standard (mm)	Service Limit (mm)
Oil pump	Inner rotor-to-outer rotor clearance	—	0.12
	Outer rotor-to-pump body clearance	—	0.12
	Rotor end-to-pump body clearance	0.05~0.10	0.2

#### TROUBLESHOOTING

##### Oil level too low

- Natural oil consumption
- Oil leaks
- Worn or poorly installed piston rings
- Worn valve guide or seal

##### Poor lubrication pressure

- Oil level too low
- Clogged oil filter or oil passages
- Not use the specified oil



# 4. LUBRICATION SYSTEM

## ENGINE OIL/OIL FILTER

### OIL LEVEL

- \* Place the motorcycle upright on level ground for engine oil level check.
- \* Run the engine for 2~3 minutes and check the oil level after the engine is stopped for 2~3 minutes.

Remove the oil dipstick and check the oil level with the oil dipstick.  
If the level is near the lower level, fill to the upper level with the specified engine oil.

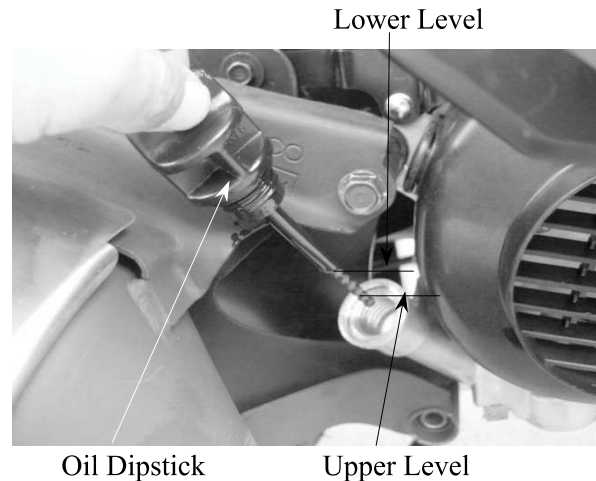

### OIL CHANGE

- \* The engine oil will drain more easily while the engine is warm.

Remove the oil filter screen cap located on the bottom of the engine to drain the engine oil thoroughly.



After the oil has been completely drained, check the filter screen O-ring for damage and replace if necessary.  
Install the oil filter screen, spring and filter screen cap.

**Torque:** 1.5kg-m

Fill with the specified SAE15W40#, API: SG engine oil to the proper level.

Oil Capacity: At disassembly : 0.90 liter  
At change : 0.80 liter

Check for oil leaks and then start the engine and let it idle for few minutes.  
Recheck the oil level.



## OIL PUMP

### REMOVAL

Remove the A.C. generator flywheel.  
Remove the nine right crankcase cover bolts and the right crankcase cover.

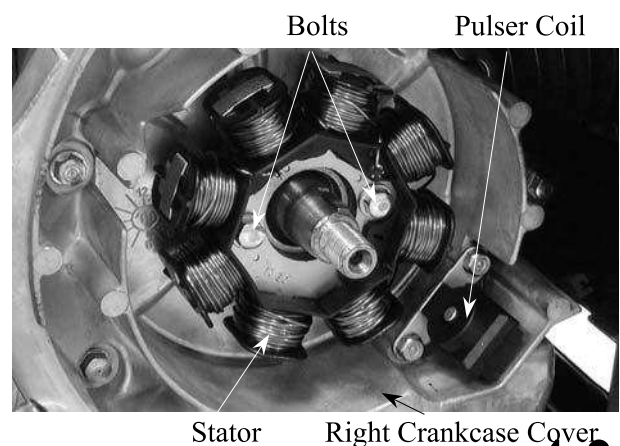

## 4. LUBRICATION SYSTEM

Remove the gasket and dowel pins.  
Remove the starter idle gear and starter clutch.



Gasket

Remove the two bolts and oil separator cover.

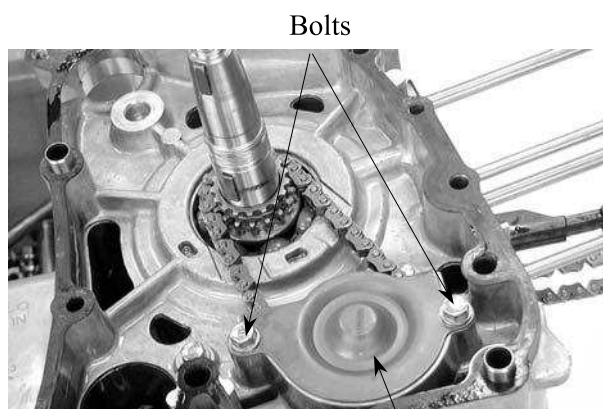

Bolts

Oil Separator Cover

Remove the oil pump driven gear nut to  
remove the oil pump driven gear and drive  
chain.

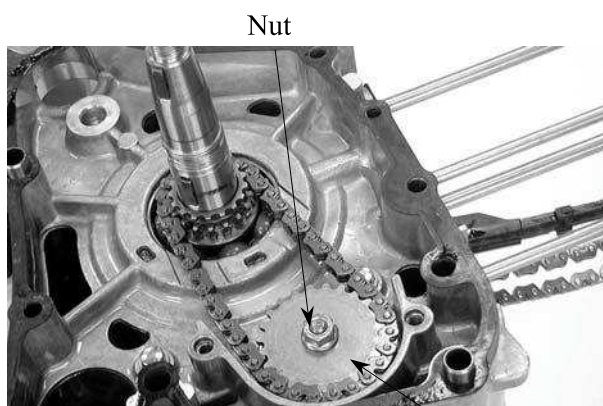

Nut

Oil Pump Driven Gear

Remove the two oil pump mounting bolts  
and the oil pump.

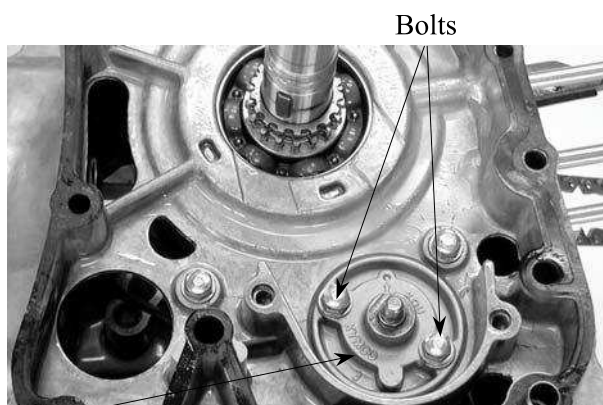

Bolts

Oil Pump

## 4. LUBRICATION SYSTEM

### DISASSEMBLY

Remove the screw and disassemble the oil pump.

Screw

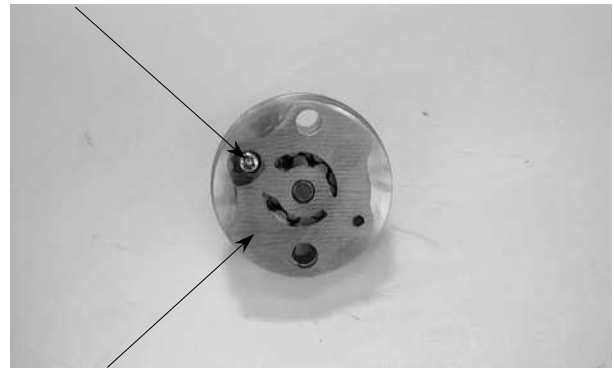

Pump Body

### INSPECTION

Measure the pump body-to-outer rotor clearance.

**Service Limit:** 0.12mm

Outer Rotor

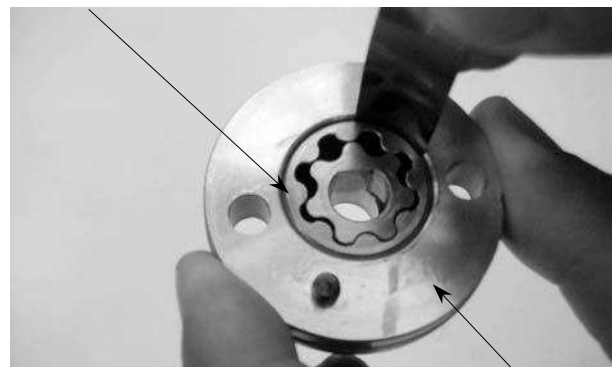

Pump Body

Measure the inner rotor-to-outer rotor clearance.

**Service Limit:** 0.12mm

Outer Rotor

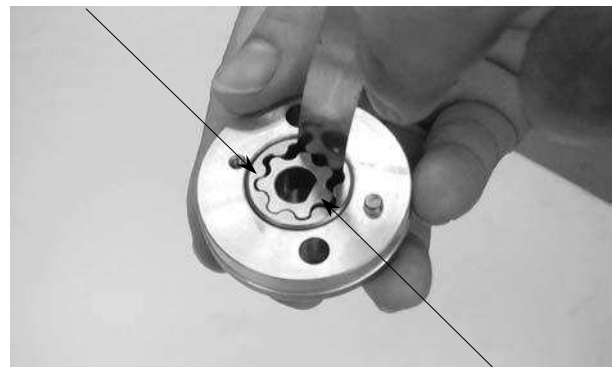

Inner Rotor

Measure the rotor end-to-pump body clearance.

**Service Limit:** 0.2mm

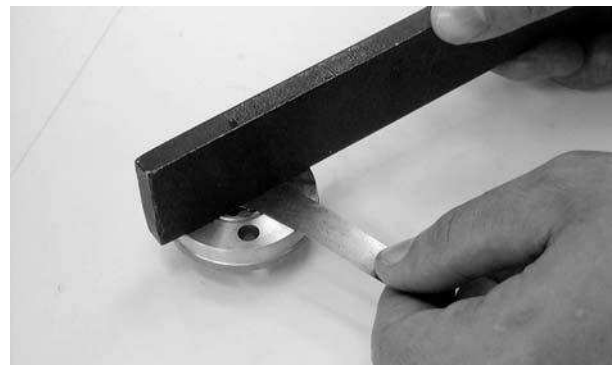

## 4. LUBRICATION SYSTEM

### ASSEMBLY

Install the outer rotor, inner rotor and pump shaft into the pump body.

- \* Insert the pump shaft by aligning the flat on the shaft with the flat in the inner rotor.

Install the dowel pin.

Install the pump cover by aligning the hole in the cover with the dowel pin.

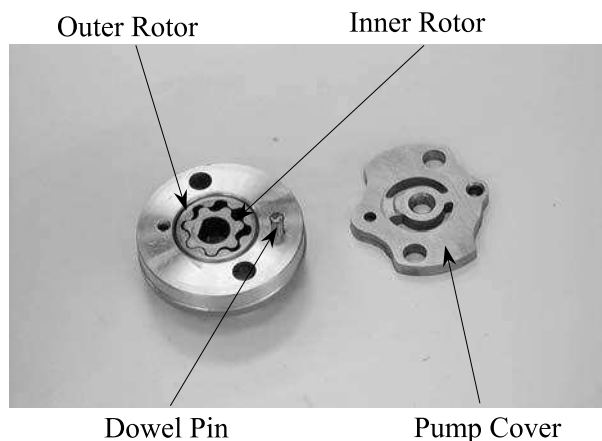

Tighten the screw to secure the pump cover. Make sure that the pump shaft rotates freely without binding.

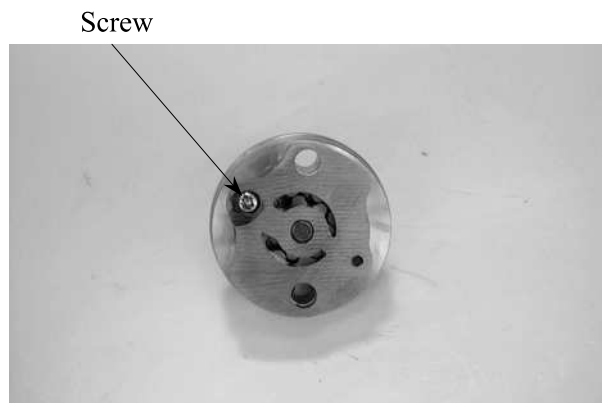

### INSTALLATION

Install the oil pump into the crankcase.

- \* Install the oil pump with the arrow on the pump body facing up and fill the oil pump with engine oil before installation.

After the oil pump is installed, tighten the two mounting bolts.

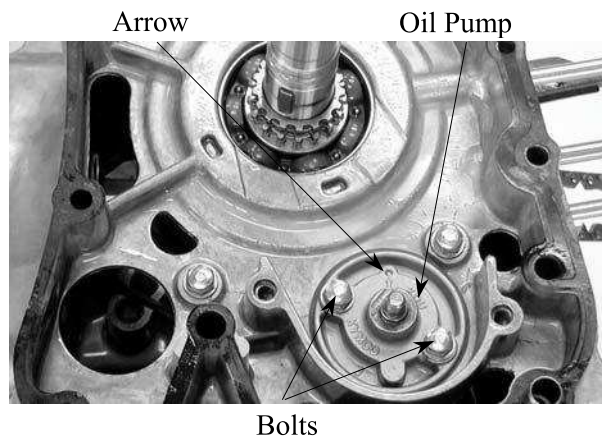

Install the pump driven gear and drive chain by aligning the pump driven gear with the cutout in the pump shaft. Install and tighten the pump driven gear nut.

**Torque:** 1.0kg-m

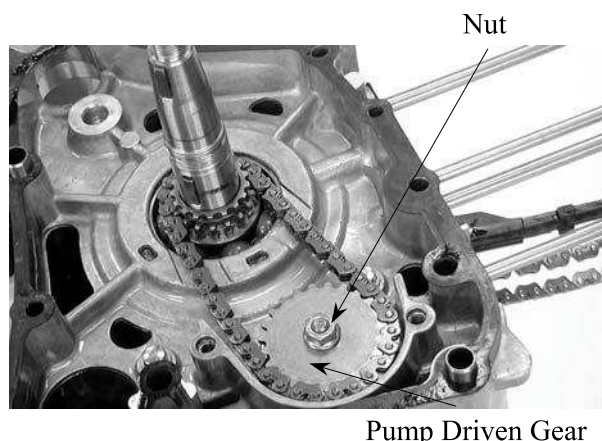

## 4. LUBRICATION SYSTEM

Install the oil separator cover and tighten the bolts.

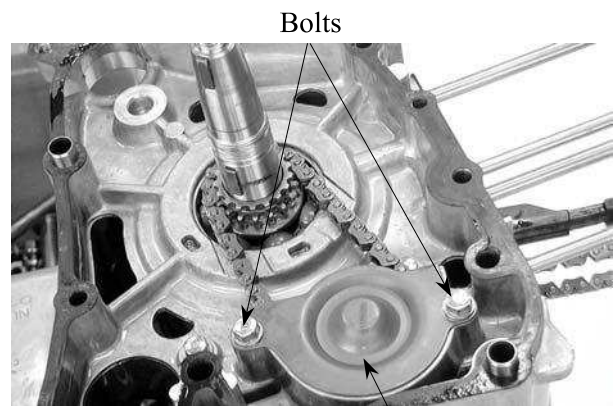

**Bolts**  
Oil Separator Cover

Install the starter idle gear and starter clutch.  
Install the gasket and dowel pins.

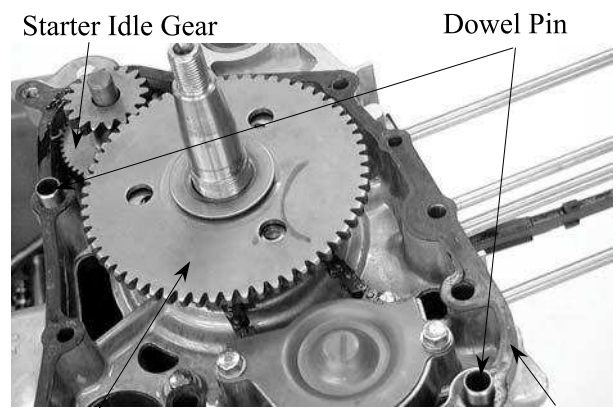

**Starter Idle Gear** **Dowel Pin**  
**Starter Clutch** **Gasket**

Install the right crankcase cover and tighten the nine bolts.

**Torque: 0.9kg-m**

\* Diagonally tighten the bolts in 2~3 times.



**Right Crankcase Cover**  
**Stator** **Bolts** **Pulser Coil**

## 5. FUEL SYSTEM

---

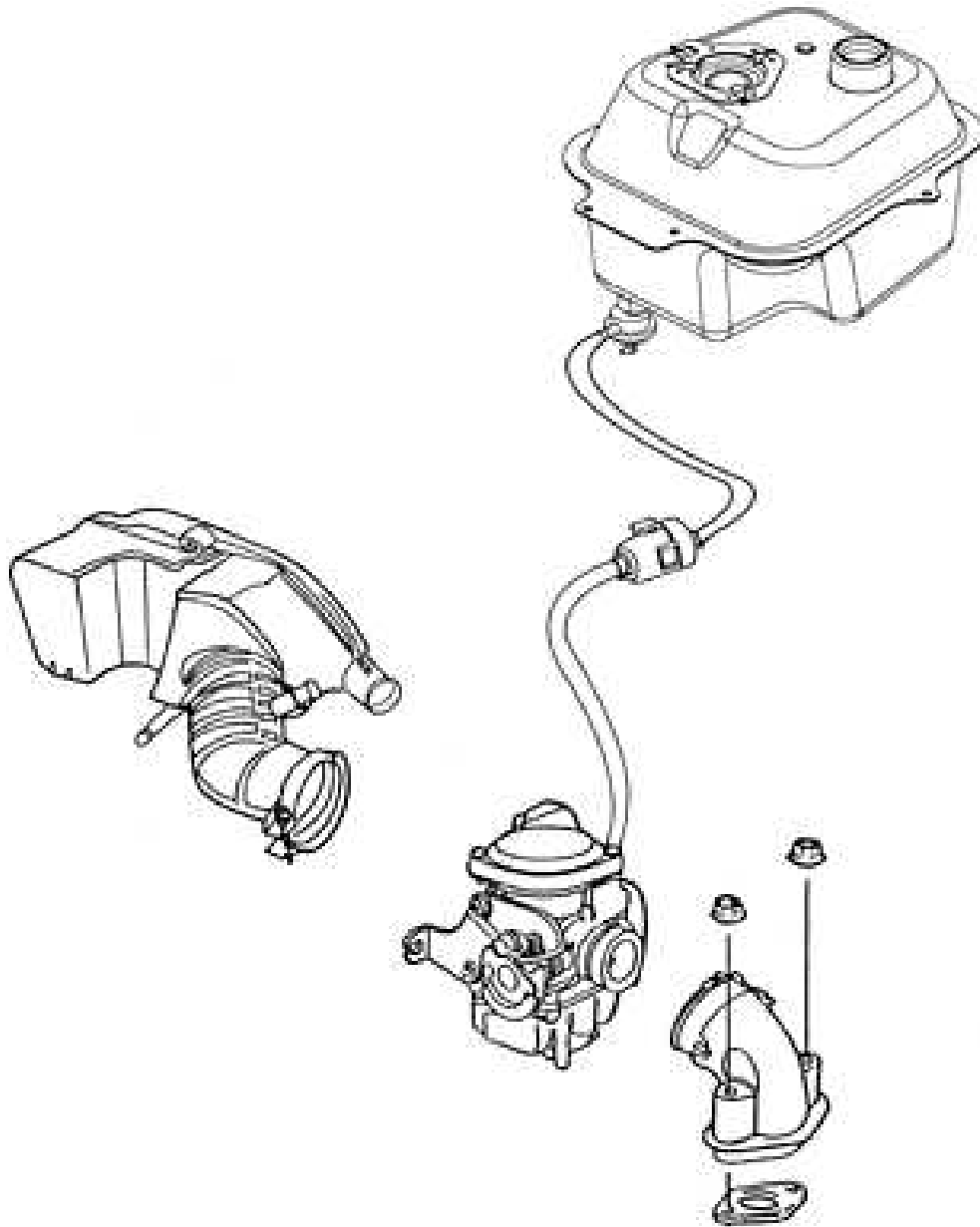

# 5. FUEL SYSTEM

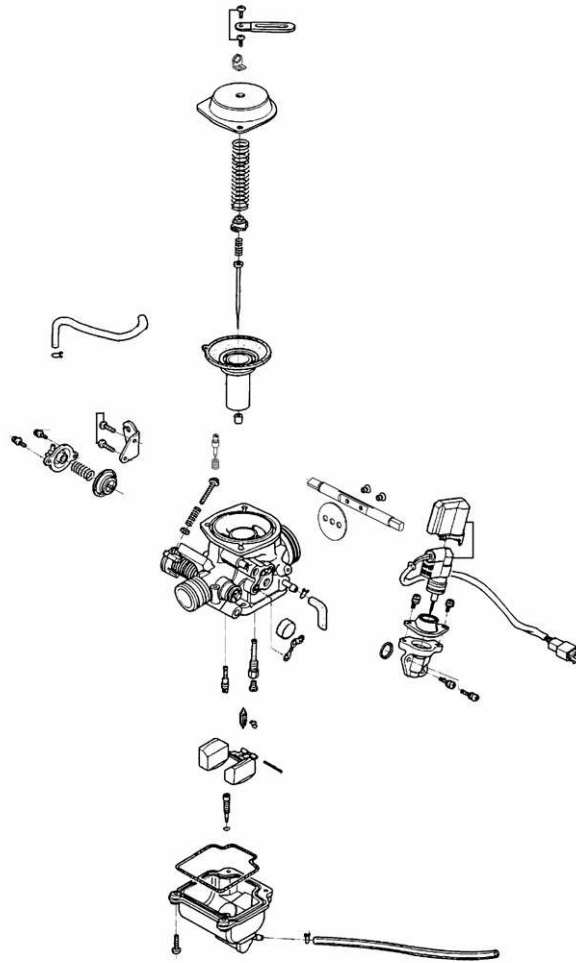

AGILITY CITE 125

AGILITY CITE 150

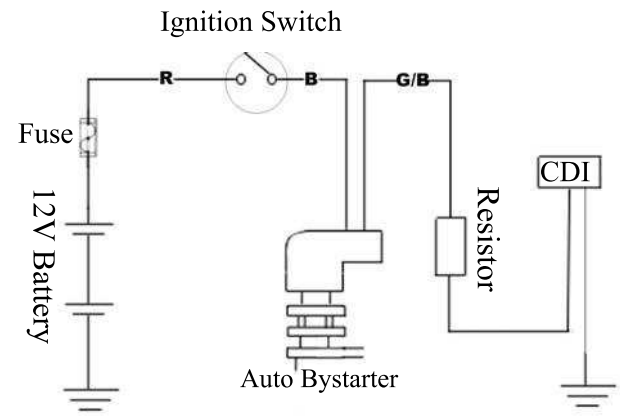
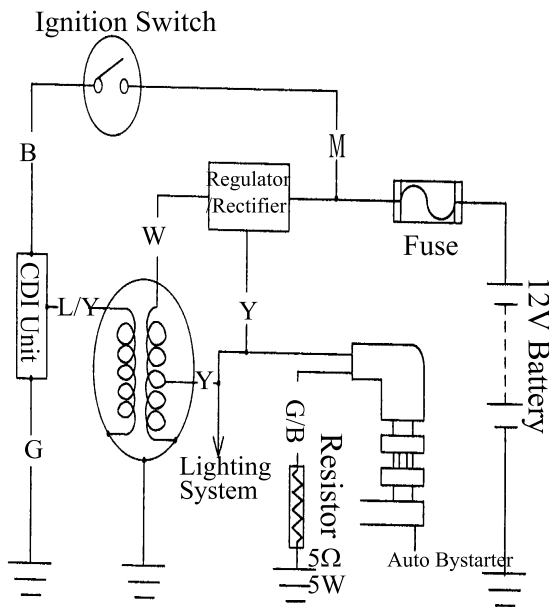

## 5. FUEL SYSTEM

SERVICE INFORMATION.....	5-2	CARBURETOR INSTALLATION.....	5-10
TROUBLESHOOTING.....	5-3	PILOT SCREW ADJUSTMENT .....	5-11
CARBURETOR REMOVAL.....	5-4	FUEL TANK.....	5-12
AUTO BYSTARTER .....	5-4	FUEL UNIT .....	5-13
AIR CUT-OFF VALVE .....	5-6	AIR CLEANER .....	5-13
VACUUM CHAMBER.....	5-6		
FLOAT CHAMBER.....	5-8		

### SERVICE INFORMATION

#### GENERAL INSTRUCTIONS



Gasoline is very dangerous. When working with gasoline, keep sparks and flames away from the working area.  
Gasoline is extremely flammable and is explosive under certain conditions. Be sure to work in a well-ventilated area.

- When disassembling the carburetor, be sure to service the vacuum piston and float chamber.
- Do not bend or twist control cables. Damaged control cables will not operate smoothly.
- When disassembling fuel system parts, note the locations of O-rings. Replace them with new ones during assembly.
- Before float chamber disassembly, loosen the drain screw to drain the residual gasoline into a clean container.
- After the carburetor is removed, plug the intake manifold side with a clean shop towel to prevent foreign matters from entering.
- Remove the vacuum diaphragm before cleaning the carburetor air and fuel passages with compressed air to avoid damaging the vacuum diaphragm.
- When the motorcycle is not used for over one month, drain the residual gasoline from the float chamber to avoid erratic idling and clogged slow jet due to deteriorated fuel.

#### SPECIFICATIONS

Item	Standard	
	125cc	150cc
Venturi dia. (mm)	φ26	φ22
Type	VE	VE
Float level (mm)	17	31.5
Main jet	#104	#98
Slow jet	#35	#35
Idle speed	1700rpm ± 100	1700rpm ± 100
Throttle grip free play	2 ~ 6mm	2 ~ 6mm
Pilot screw opening	3 ± 1/2	2 ± 1/2



## 5. FUEL SYSTEM

---

### TROUBLESHOOTING

#### Engine is hard to start

- No spark at plug (⇒Section 15)
- Compression too low
- No fuel to carburetor
  - Clogged fuel filter
  - Restricted fuel line
  - Faulty float valve
  - Incorrectly adjusted float level
- Engine flooded with fuel
  - Clogged air cleaner
  - Fuel overflowing
- Intake air leak
- Contaminated fuel
- Faulty auto bystarter
- Clogged idle system or auto bystarter passages

#### Rich mixture

- Faulty auto bystarter
- Faulty float valve
- Float level too high
- Clogged air jets
- Dirty air cleaner
- Flooded carburetor

#### Backfiring at deceleration

- Lean mixture in idle system
- Improper air cut-off valve operation

#### Misfiring during acceleration

- Faulty ignition system
- Lean mixture
- Faulty accelerating pump

#### Engine idles roughly, stalls or runs poorly

- Clogged fuel system
- Ignition malfunction
- Rich or lean mixture
- Contaminated fuel
- Intake air leak
- Incorrect idle speed
- Incorrectly adjusted pilot screw
- Clogged idle system or auto bystarter passages
- Incorrectly adjusted float level

#### Lean mixture

- Clogged fuel jets
- Faulty float valve
- Float level too low
- Clogged fuel system
- Intake air leak
- Improper vacuum piston operation
- Improper throttle operation

## 5. FUEL SYSTEM

### CARBURETOR REMOVAL

Remove the frame right side cover. (⇒2-4)  
 Disconnect the auto bystarter wire connector.  
 Remove the met-in box. (⇒2-3)

Auto Bystarter

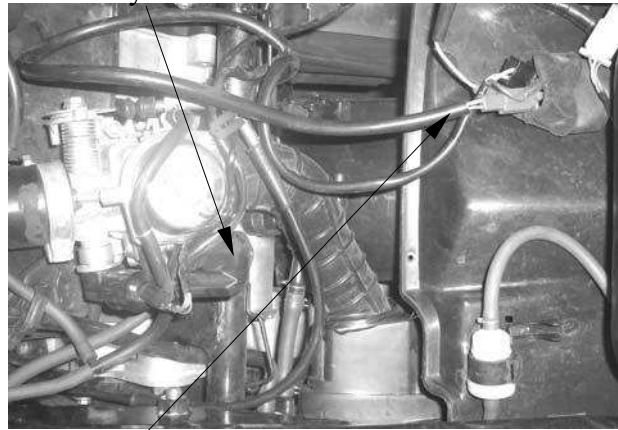

Auto Bystarter Wire

Loosen the drain screw and drain the fuel from the float chamber.  
 Disconnect the fuel tube and vacuum tube at the carburetor.  
 Disconnect the TPS coupler and remove the TPS unit



TPS Unit

Fuel Tube

Loosen the throttle cable adjusting nut and lock nut, and disconnect the throttle cable from the carburetor.  
 Loosen the carburetor intake manifold band and air cleaner connecting tube band screws and then remove the carburetor.

Air Cleaner Connecting Tube Band    Vacuum Tube    Intake Manifold Band



Throttle Cable

Adjusting Nut

Lock Nut

### AUTO BYSTARTER

#### OPERATION INSPECTION

Measure the resistance between the auto bystarter wire terminals.

**Resistance:** 10Ω max. (10 minutes minimum after stopping the engine)

If the reading is not within the limit, replace the auto bystarter with a new one.

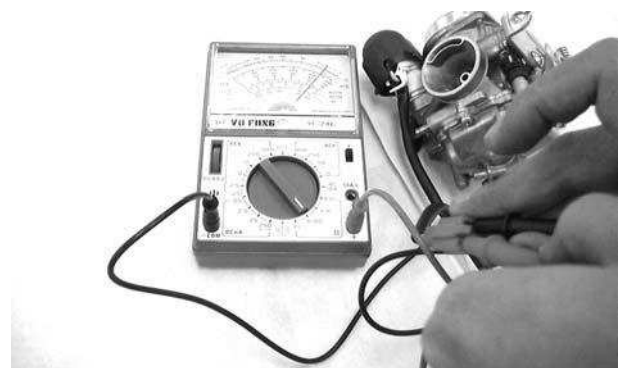

# 5. FUEL SYSTEM

Vacuum Pump

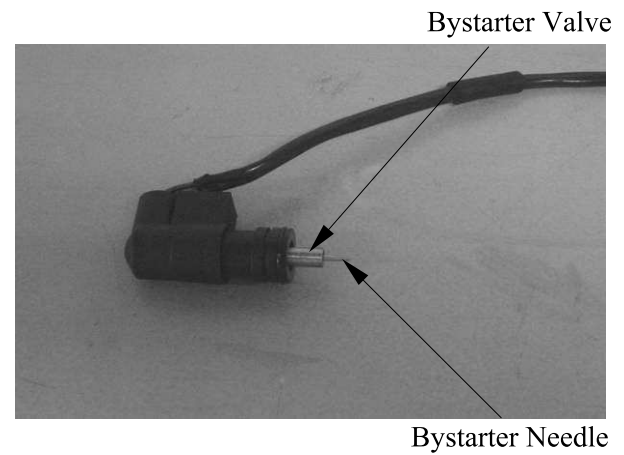
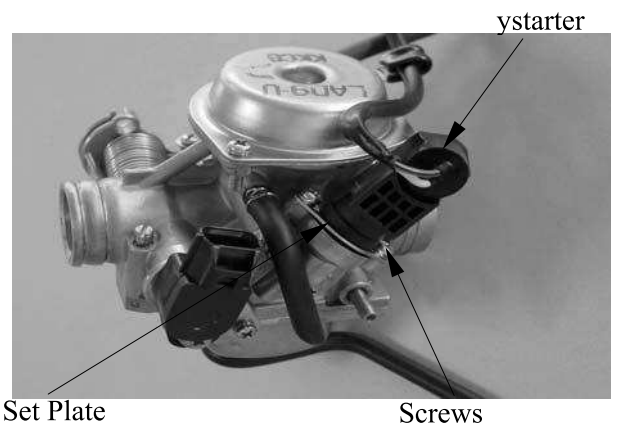
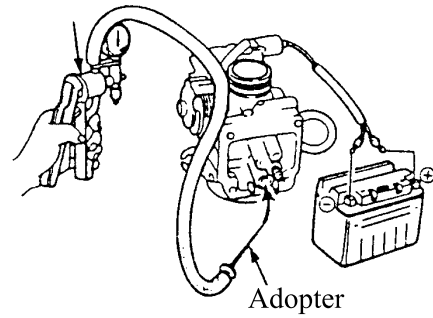

Auto Bystarter

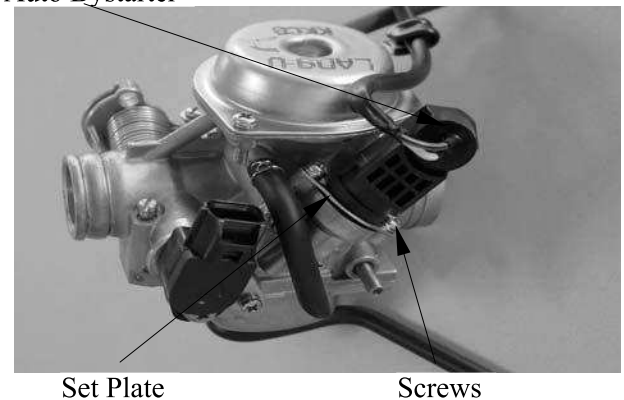

- \* • Be sure to install the auto bystarter and set plate properly.  
 • Install the set plate with its bottom face facing down.

## 5. FUEL SYSTEM

### AIR CUT-OFF VALVE

#### DISASSEMBLY

Remove the two screws attaching the air cut-off valve. Remove the spring and vacuum diaphragm. Check the vacuum diaphragm for cracks or damage and check each passage for clogging.

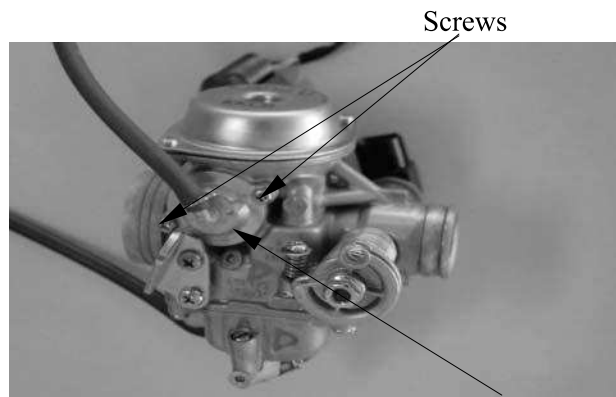

Screws  
Air Cut-off Valve Cover

#### ASSEMBLY

Install the vacuum diaphragm onto the carburetor. Install the spring and air cut-off valve cover. Install the throttle cable set plate and tighten the two screws.

- \* • Be sure to set the vacuum diaphragm lip into the groove on the carburetor.
- When installing the air cut-off valve cover, make sure that the vacuum diaphragm is properly installed.

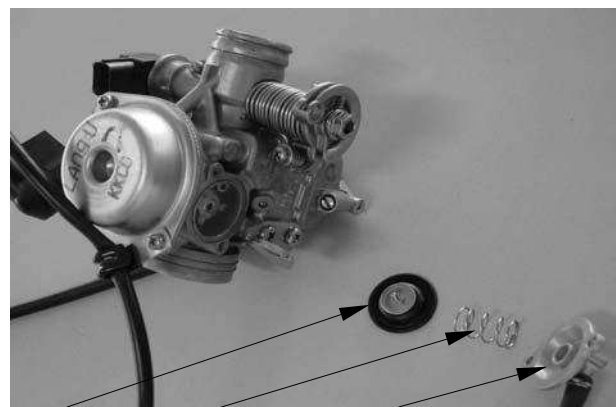

Diaphragm Spring Cover Screws

### VACUUM CHAMBER

#### DISASSEMBLY

Remove the two vacuum chamber cover screws and the cover.



Vacuum Chamber Cover  
Spring Vacuum Diaphragm/Piston

Remove the spring and vacuum diaphragm/piston.



## 5. FUEL SYSTEM

Remove the needle holder and jet needle.

\* Be careful not to damage the vacuum diaphragm.



### INSPECTION

Inspect the needle for stepped wear.  
Inspect the vacuum piston for wear or damage.  
Inspect the diaphragm for deterioration and tears.

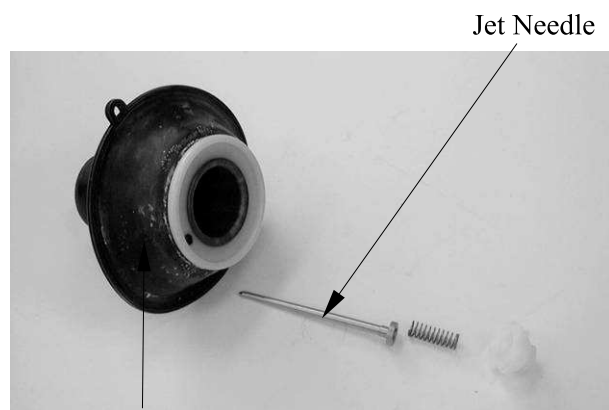

Vacuum Diaphragm

Vacuum Diaphragm Vacuum Chamber Cover

### ASSEMBLY

Install the vacuum piston/diaphragm in the carburetor body.  
Install the spring and then install the vacuum chamber cover.  
Tighten the two screws.

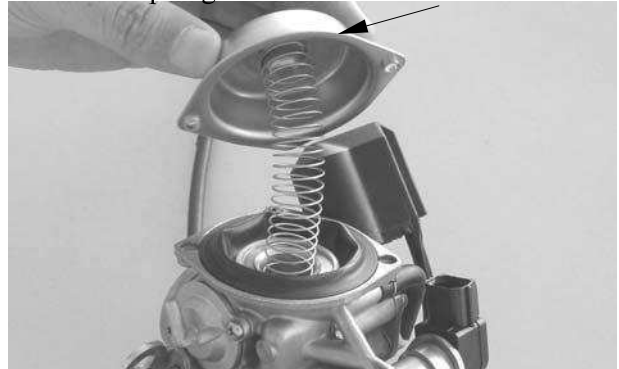

## 5. FUEL SYSTEM

### FLOAT CHAMBER

#### DISASSEMBLY

Remove the three float chamber screws and the float chamber.

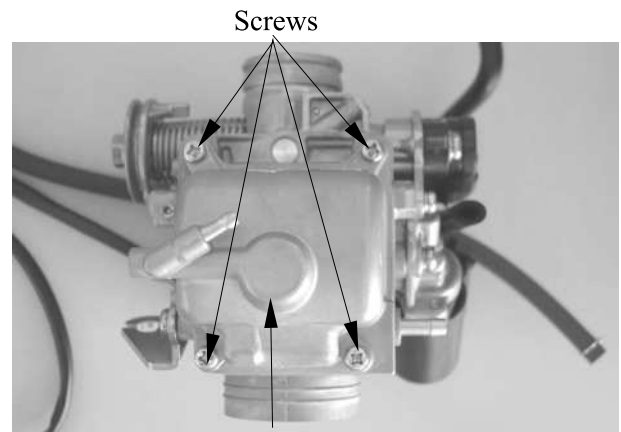

Float Chamber

Loosen the float pin screw.  
Remove the float pin, float and float valve.

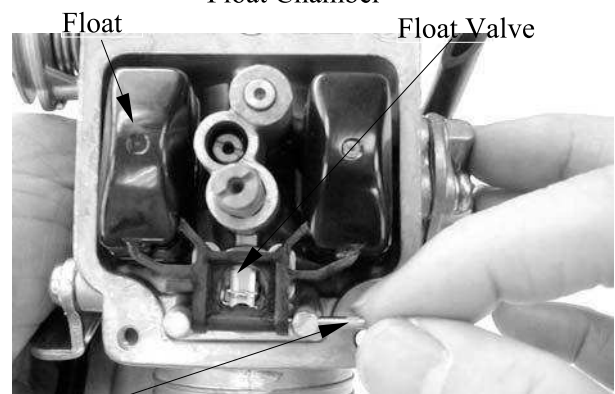

Float Pin

Needle Jet Holder

Slow Jet

Remove the main jet, needle jet holder, needle jet, slow jet and pilot screw.

- \*
- Be careful not to damage the fuel jets and pilot screw.
  - Before removing, turn the pilot screw in and carefully count the number of turns until it seats lightly and then make a note of this.
  - Do not force the pilot screw against its seat to avoid seat damage.

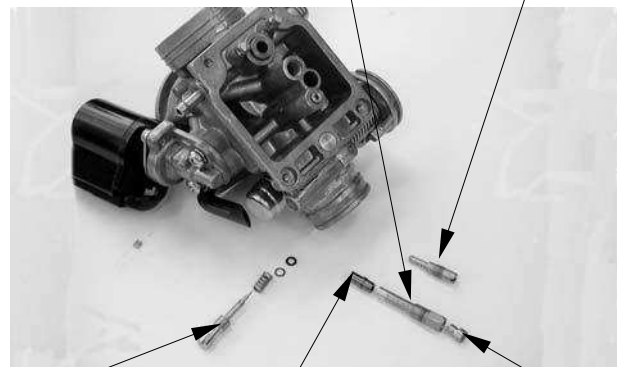

Pilot Screw

Needle Jet

Main Jet

Clean the removed fuel jets with detergent oil and blow them open with compressed air.  
Blow compressed air through all passages of the carburetor body.



## 5. FUEL SYSTEM

### INSPECTION

Inspect the float valve and valve seat for damage or clogging.  
Inspect the float valve and valve seat contact area for stepped wear or contamination.

- \* Worn or contaminated float valve and valve seat must be replaced because it will result in float level too high due to incomplete airtightness.

### ASSEMBLY

Install the slow jet, needle jet, needle jet holder, main jet and pilot screw.

- \* Return the pilot screw to the original position as noted during removal.

**Standard Opening:**  $3 \pm 1/2$  turns

Install the float valve, float and float pin.

### FLOAT LEVEL INSPECTION

- \* • Check the operation of the float valve and float before this inspection.
- Measure the float level by placing the float level gauge on the float chamber face parallel with the main jet.

Measure the float level.

**Float Level:** 17.0mm

This installation sequence is the reverse of removal.

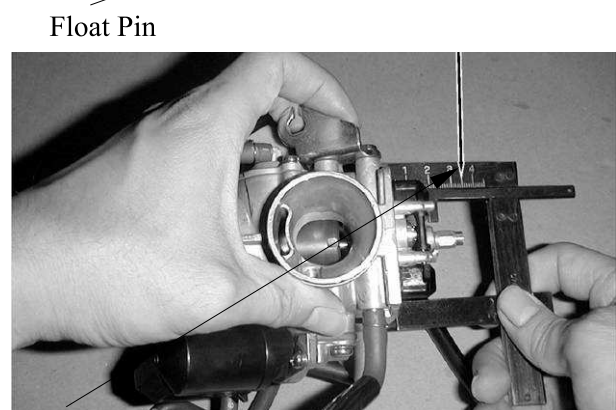
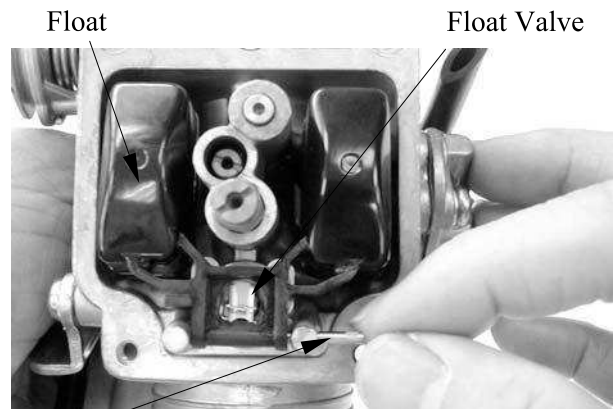
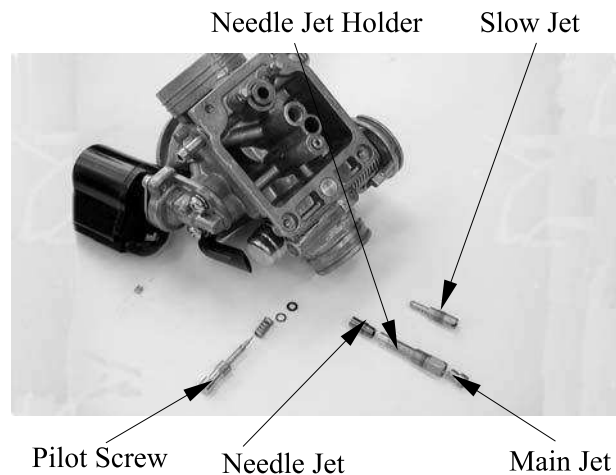
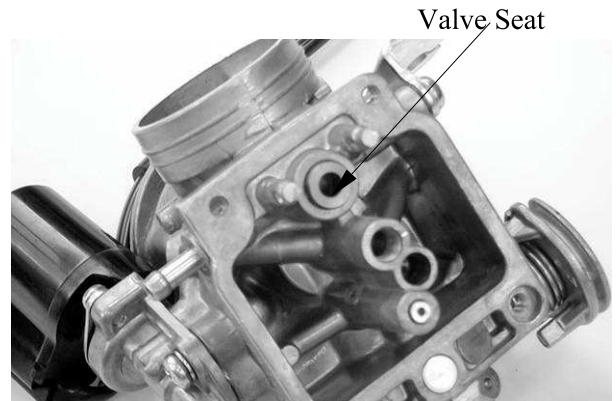

## 5. FUEL SYSTEM

### CARBURETOR INSTALLATION

Tighten the drain screw.  
 Install the carburetor onto the intake manifold, aligning the tab on the carburetor with the cutout in the intake manifold.  
 Tighten the intake manifold band screw.  
 Install the air cleaner connecting tube and tighten the band screw.  
 Connect the throttle cable to the throttle wheel on the carburetor.  
 Tighten the lock nut.

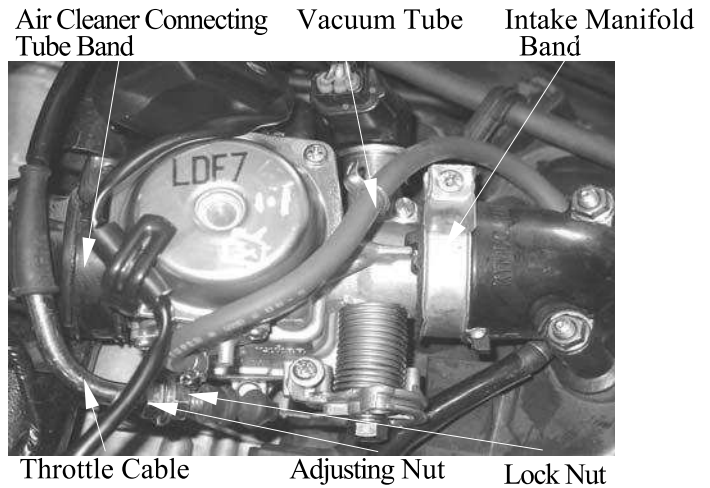

Connect the fuel tube and vacuum tube to the carburetor.

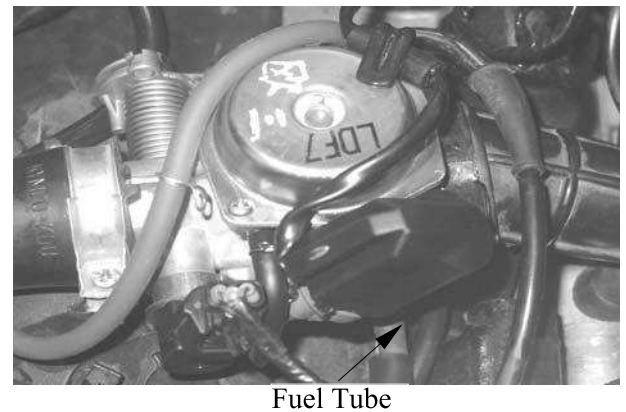

Connect the auto bystarter wire connector.  
 Perform the following inspections and adjustments:

- Throttle grip free play (⇒3-3)
- Carburetor idle speed (⇒3-5)

Connect the auto TPS unit wire connector.

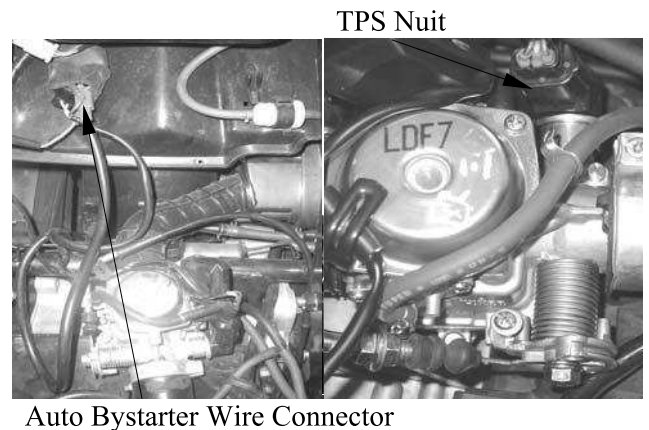



## 5. FUEL SYSTEM

### PILOT SCREW ADJUSTMENT

#### \* ADJUSTMENT

- \*
  - The pilot screw is factory pre-set and no adjustment is necessary. During carburetor disassembly, note the number of turns of the pilot screw and use as a reference when reinstalling it.
  - Place the motorcycle on its main stand on level ground for this operation.

A tachometer must be used when adjusting the engine speed.

Turn the pilot screw clockwise until it seats lightly and back it out to the specification given.

**Standard Opening:**  $3\pm\frac{1}{2}$  turns

- \*
  - The carburetor must be adjusted when the engine is warm and the auto bystarter is closed.
  - Do not force the pilot screw against its seat to prevent damage.

Warm up the engine and adjust the throttle stop screw to obtain the specified idle speed.

**Idle Speed:**  $1700\pm 100$ rpm

Turn the pilot screw in or out slowly to obtain the highest engine speed.

Slightly accelerate several times to make sure that the idle speed is within the specified range.

If the engine misses or runs erratic, repeat the above steps.



Pilot Screw

Throttle Stop Screw



## 5. FUEL SYSTEM

### FUEL TANK REMOVE

Remove the net-in box. (⇒2-3)  
 Remove the frame center cover.  
 Remove the frame body cover. (⇒2-3)  
 Remove the four bolts on the fuel tank, take the upper seat lock off.  
 Disconnect the fuel unit wire connector.  
 Remove the fuel tank.  
 The installation sequence is the reverse of removal.

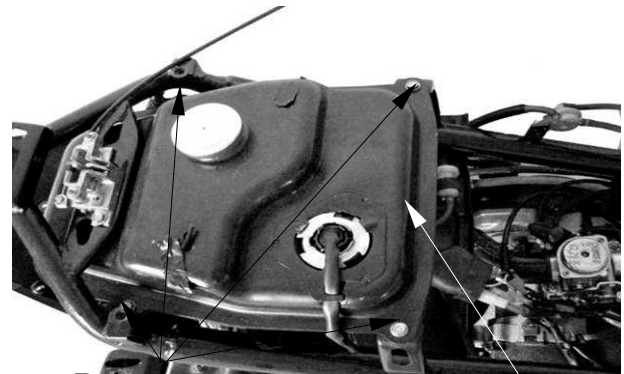

Bolts

Fuel Tank



Fuel Unit Wire Connector

### FUEL STRAINER REMOVAL

Remove the fuel strainer from the fuel tank.

#### INSPECTION

Inspect if the fuel strainer is clogged and clean it with compressed air.

- \* • When removing the fuel strainer, do not allow flames or sparks near the working area and drain the residual gasoline into a container.

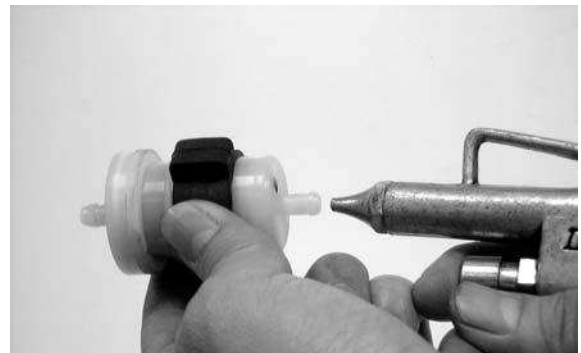

### INSTALLATION

Install the fuel strainer with its arrow mark toward the fuel pump.

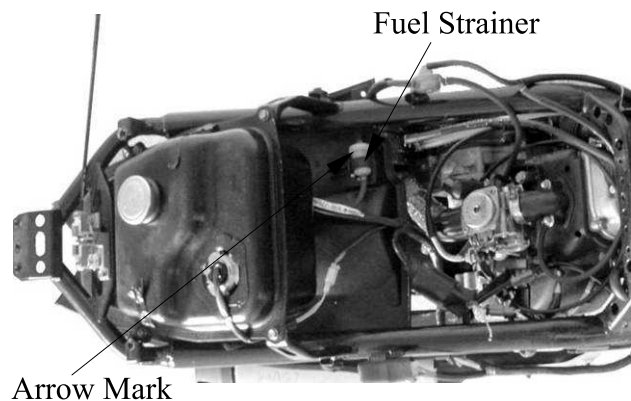

Arrow Mark

Fuel Strainer

## 5. FUEL SYSTEM

### FUEL UNIT

#### REMOVAL

Remove the related parts.  
 Disconnect the fuel unit wire connector.  
 Turn the fixed plate on the fuel unit, take the fuel unit off.

- \* Do not bend the float arm on the fuel unit, otherwise the figure on the fuel meter will not correct.

Fuel Unit Wire

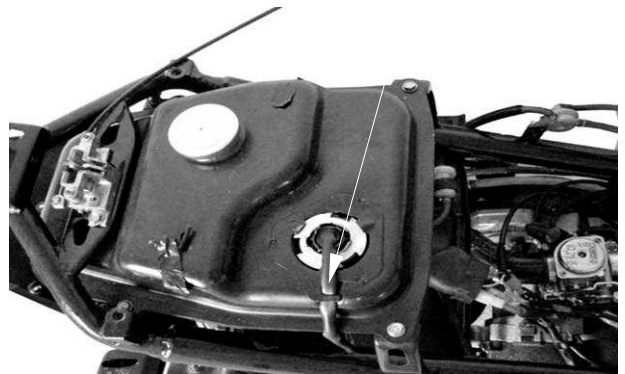

#### INSTALLATION

Inspect if the fuel unit is damaged, or hardened.  
 Assemble the fuel unit in the reverse order of disassembly.

- \*
  - Align the groove on the fuel unit with the angle on the fuel tank.
  - Inspect if the fuel tank leaked after installing and filling the gasoling.

Fuel Tank

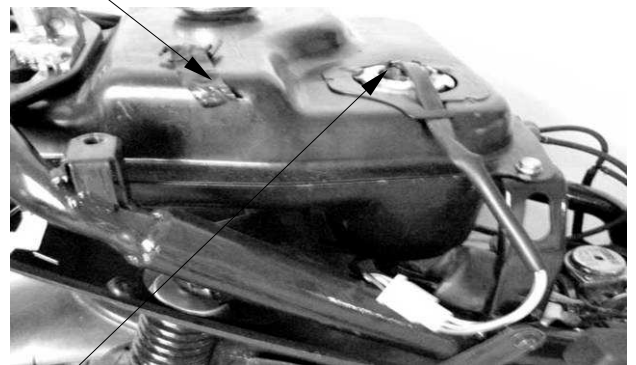

Fuel Unit

### AIR CLEANER

Loosen the air cleaner connecting tube band screw.  
 Disconnect the clinhead cover breather tube from the air cleaner.  
 Remove the two bolts and air cleaner case.

air cleaner

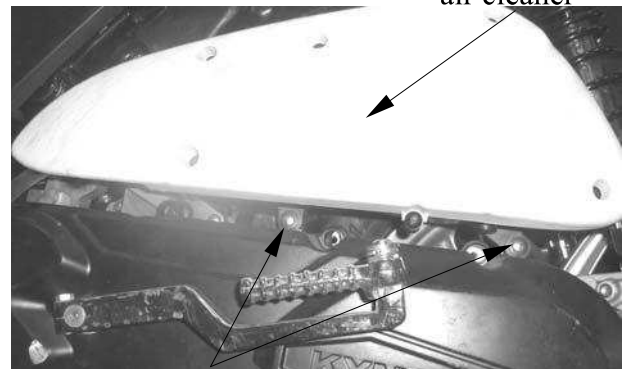

bolts

## 5. FUEL SYSTEM

### TPS REMOVE

Remove the TPS stay screw.  
Remove the TPS and TPS stay assembled.

- \* • While clean the carburetor, must remove the TPS unit.

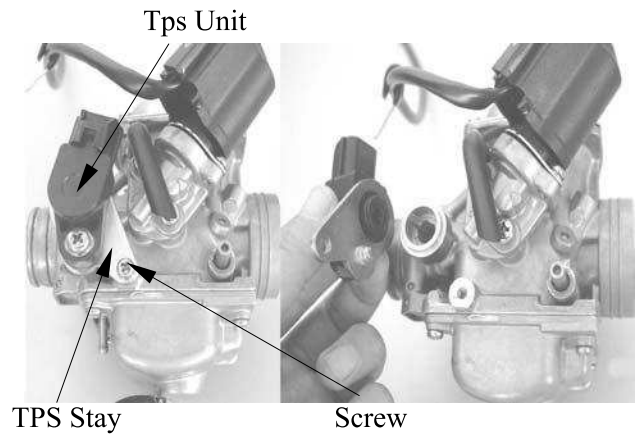

### TPS UNIT INSPECTION

Measure the TPS resistance between the violet/black and green wire terminals.

**Measure the resistance:  $5K\Omega \pm 30\%$**

Measure the TPS resistance between the violet/red and green wire terminals.

**Measure the resistance:  $5K\Omega \pm 30\%$**

- \* • When measure the TPS resistance, carburetor throttle open the max place .

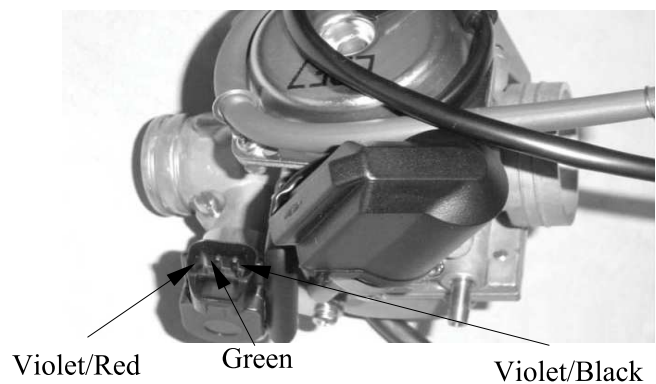

The installation sequence is the reverse of removal.

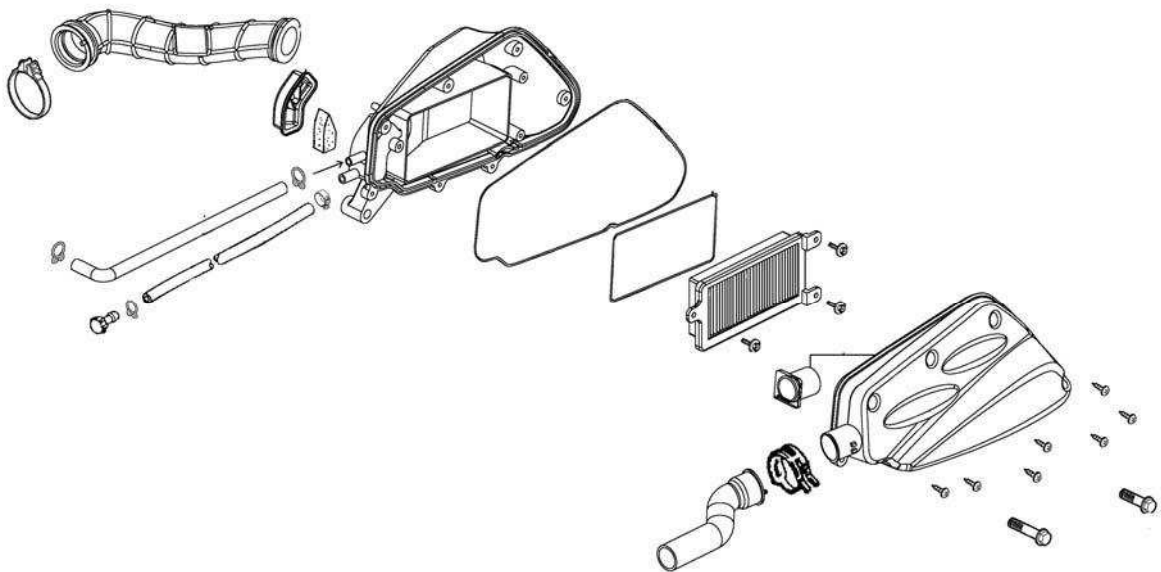

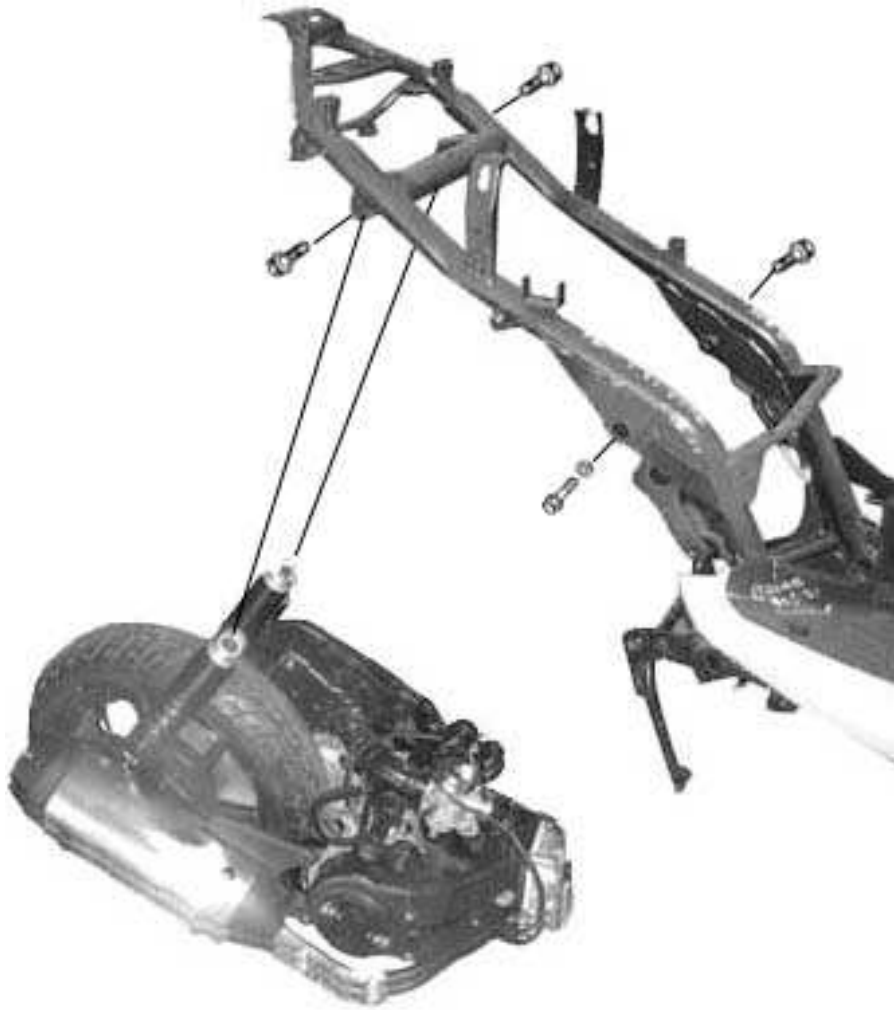

**6**

## **6. ENGINE REMOVAL/INSTALLATION**

SERVICE INFORMATION .....	6-1	ENGINE INSTALLATION .....	6-4
ENGINE REMOVAL .....	6-2		

### **SERVICE INFORMATION**

#### **GENERAL INSTRUCTIONS**

- A floor jack or other adjustable support is required to support and maneuver the engine. Be careful not to damage the motorcycle body, cables and wires during engine removal.
- Use shop towels to protect the motorcycle body during engine removal.
- Parts requiring engine removal for servicing:
  - Crankcase
  - Crankshaft

# 6. ENGINE REMOVAL/INSTALLATION AGILITY CITY 125/150

## ENGINE REMOVAL

Disconnect the battery negative cable.  
 Remove the frame body cover.  
 Disconnect the engine negative cable.  
 Disconnect the spark plug high tension wire.  
 Disconnect the auto bystarter wire connector.

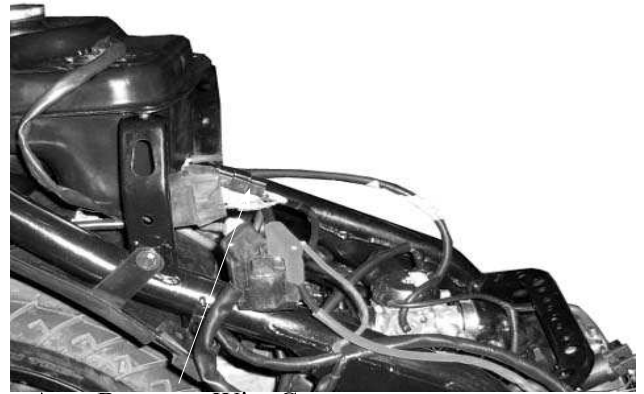

Auto Bystarter Wire Connector

Disconnect the starter motor cable from the starter relay.  
 Remove the spark plug cap and disconnect the ignition coil wire from the set plate.

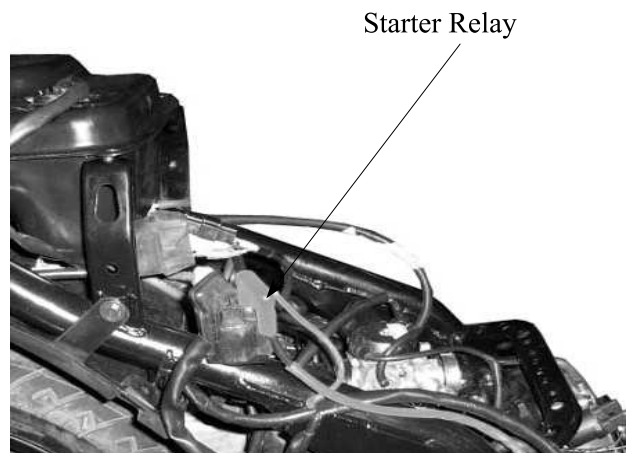

Starter Relay

Disconnect the fuel tube and vacuum tube that go to the carburetor from the fuel pump.  
 Disconnect the vacuum tube from the air cut-off valve.  
 Disconnect the throttle cable from the carburetor.

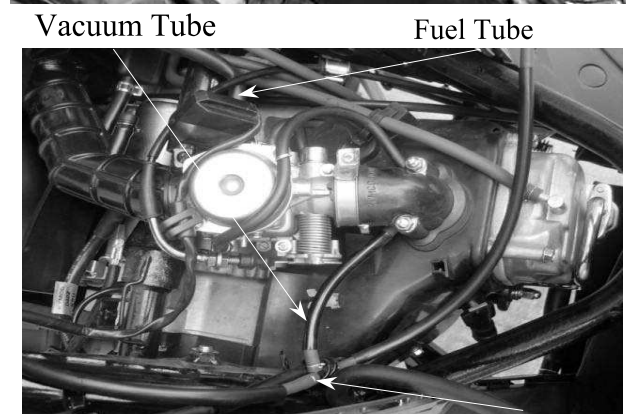

Vacuum Tube

Fuel Tube

Tee Tube

Loosen the drive belt air cleaner connecting tube band screw and remove the connecting tube.

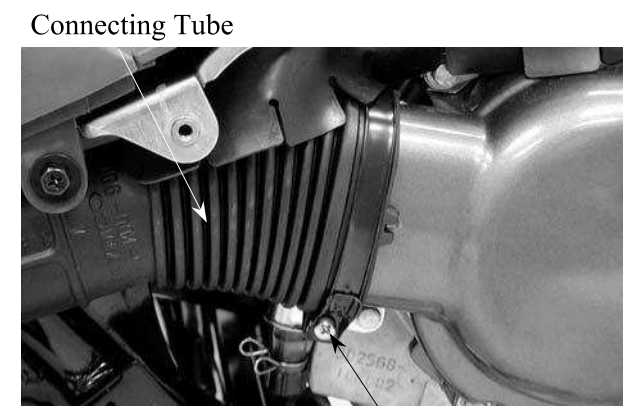

Connecting Tube

Screw

## 6. ENGINE REMOVAL/INSTALLATION

Remove the air cleaner bolts.  
Remove the rear brake adjusting nut,  
connecting pin and rear brake cable.

Brake Adjusting Nut



Remove the rear shock absorber lower  
mount bolt.

Rear Shock Absorber Lower Mount Bolt

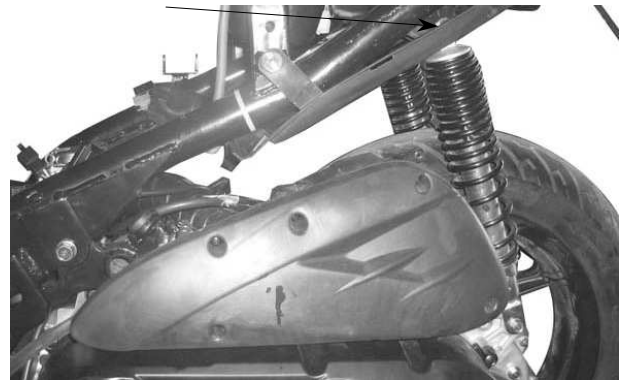

Remove the four A.C. generator cooling fan  
cover bolts and cooling fan cover.  
Remove the engine mounting bolt and pull  
out the engine with the engine hanger  
bracket backward.

Engine Mounting Bolt

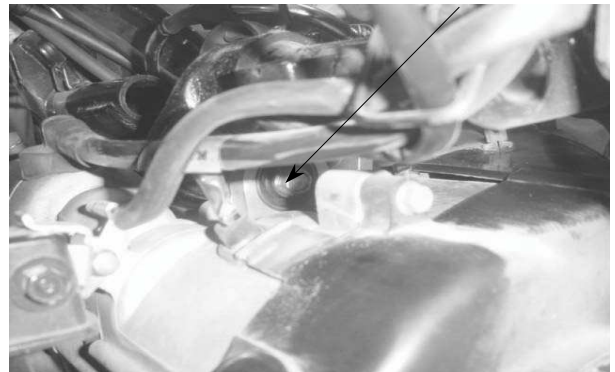

### **ENGINE HANGER BRACKET REMOVAL**

Remove the ignition coil from the engine  
hanger.  
Remove the engine hanger bracket bolt and  
nut.  
Remove the engine hanger bracket.

Engine Hanger Bracket

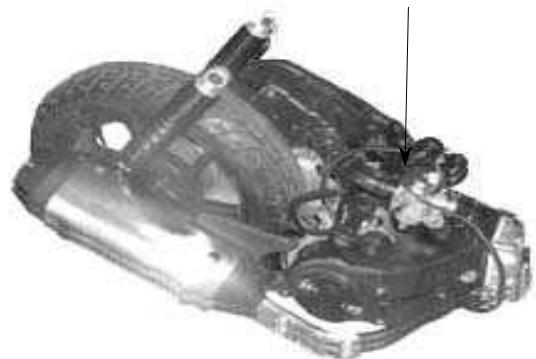



# 6. ENGINE REMOVAL/INSTALLATION AGILITY CITY 125/150

Inspect the engine hanger bushings and stopper rubbers for wear or damage.

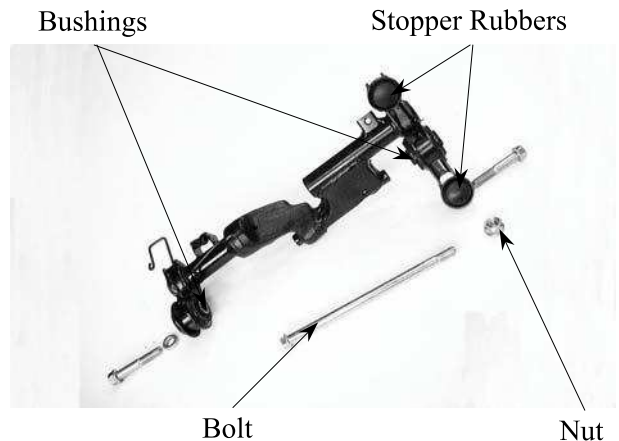

## ENGINE HANGER BRACKET INSTALLATION

Install the engine hanger bracket to the engine.  
Install the engine hanger bracket bolt and tighten the nut.

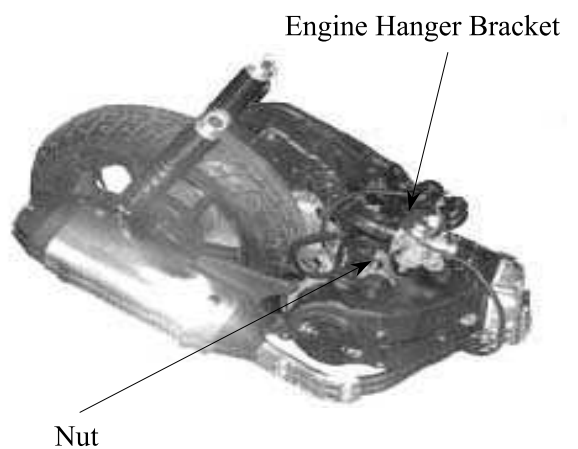

## ENGINE INSTALLATION

Install the engine and tighten the engine mounting bolt.

**Torque:** 7.0kg-m

Tighten the rear shock absorber upper mount bolt.

**Torque:** 4.0kg-m

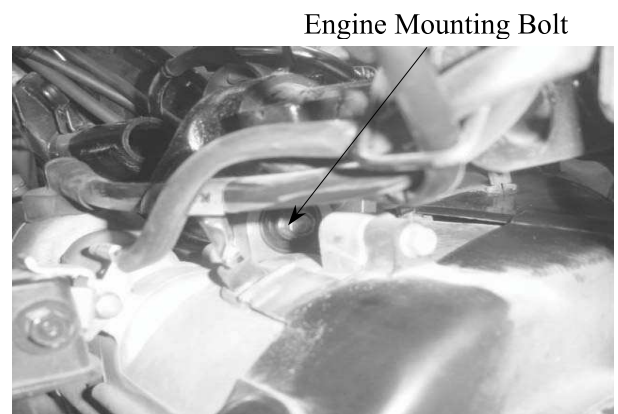

Install the removed parts in the reverse order of removal.

\* Route the wires and cables properly.

After installation, inspect and adjust the following:

- Throttle grip free play.
- Rear brake adjustment.

Rear Shock Absorber Lower Mount Bolt

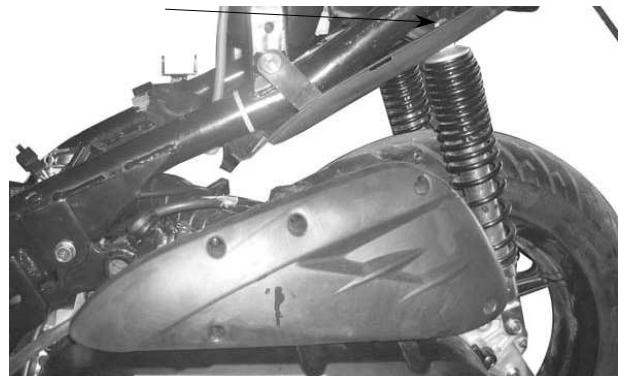

# 7. CYLINDER HEAD/VALVES

7

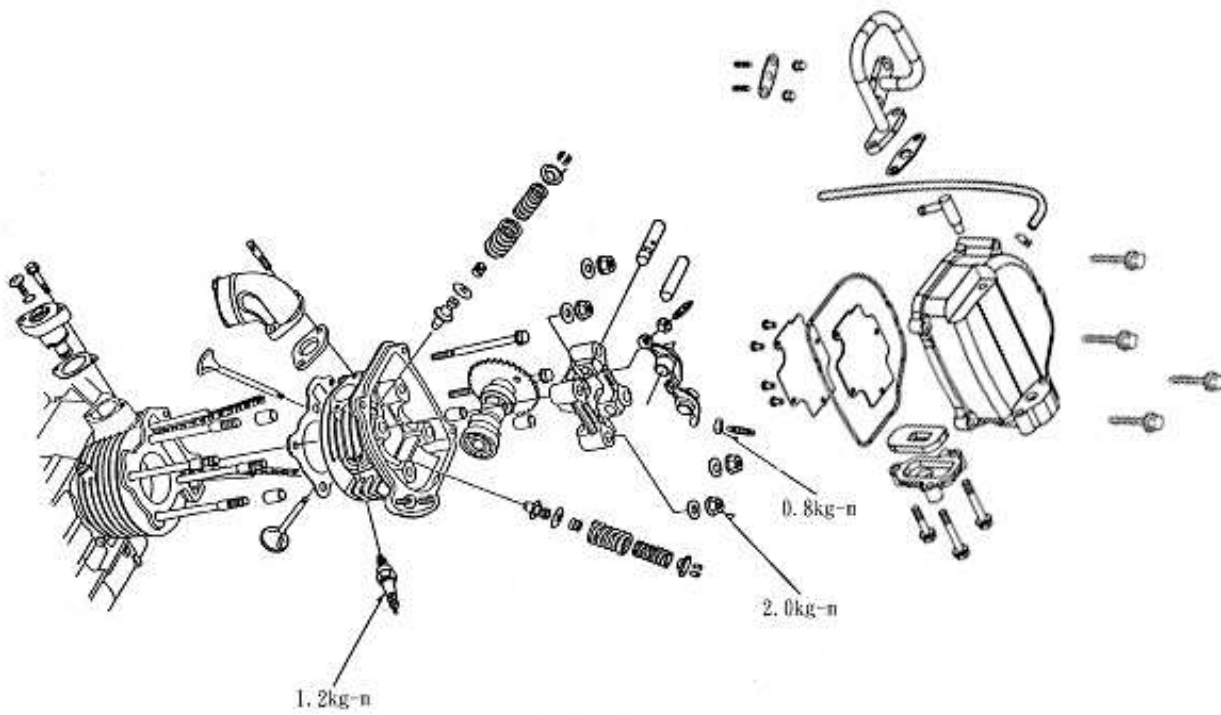

## 7. CYLINDER HEAD/VALVES

SERVICE INFORMATION.....	7-1	CYLINDER HEAD DISASSEMBLY .....	7-7
TROUBLESHOOTING .....	7-2	CYLINDER HEAD ASSEMBLY .....	7-8
CAMSHAFT REMOVAL.....	7-3	CYLINDER HEAD INSTALLATION .....	7-8
CYLINDER HEAD REMOVAL .....	7-5	CAMSHAFT INSTALLATION.....	7-9

### SERVICE INFORMATION

#### GENERAL INSTRUCTIONS

- The cylinder head can be serviced with the engine installed in the frame.
- When assembling, apply molybdenum disulfide grease or engine oil to the valve guide movable parts, valve arm and camshaft sliding surfaces for initial lubrication.
- The camshaft is lubricated by engine oil through the cylinder head engine oil passages. Clean and unclog the oil passages before assembling the cylinder head.
- After disassembly, clean the removed parts and dry them with compressed air before inspection.
- After removal, mark and arrange the removed parts in order. When assembling, install them in the reverse order of removal.

#### SPECIFICATIONS

Item		Standard (mm)	Service Limit (mm)
Valve clearance (cold)	IN	0.12	—
	EX	0.12	—
Cylinder head compression pressure		13kg/cm <sup>2</sup>	
Cylinder head warpage		—	
Camshaft cam height	IN	29.803	29.40
	EX	29.5637	29.16
Valve rocker arm I.D.	IN	10.000~10.015	10.10
	EX	10.000~10.015	10.10
Valve rocker arm shaft O.D.	IN	9.972~9.987	9.91
	EX	9.972~9.987	9.91
Valve seat width	IN	1.0	1.8
	EX	1.0	1.8
Valve stem O.D.	IN	4.975~4.990	4.90
	EX	4.955~4.970	4.90
Valve guide I.D.	IN	5.000~5.012	5.03
	EX	5.000~5.012	5.03
Valve stem-to-guide clearance	IN	0.010~0.037	0.08
	EX	0.030~0.057	0.10

## 7. CYLINDER HEAD/VALVES

---

### TORQUE VALUES

Cylinder head nut	2.0kg-m	Apply engine oil to threads
Valve clearance adjusting nut	0.9kg-m	Apply engine oil to threads
Stud bolt	0.9~1.1kg-m	

### SPECIAL TOOLS

Valve spring compressor

### TROUBLESHOOTING

- The poor cylinder head operation can be diagnosed by a compression test or by tracing engine top-end noises.

#### Poor performance at idle speed

- Compression too low

#### Compression too low

- Incorrect valve clearance adjustment
- Burned or bend valves
- Incorrect valve timing
- Broken valve spring
- Poor valve and seat contact
- Leaking cylinder head gasket
- Warped or cracked cylinder head
- Poorly installed spark plug

#### Compression too high

- Excessive carbon build-up in combustion chamber

#### White smoke from exhaust muffler

- Worn valve stem or valve guide
- Damaged valve stem seal

#### Abnormal noise

- Incorrect valve clearance adjustment
- Sticking valve or broken valve spring
- Damaged or worn camshaft
- Worn cam chain guide
- Worn camshaft and rocker arm

## 7. CYLINDER HEAD/VALVES

### CAMSHAFT REMOVAL

Remove the center cover.  
 Remove the four cylinder head cover bolts to remove the cylinder head cover.  
 Remove the two nuts attaching the secondary air inlet tube.

Cylinder Head Cover

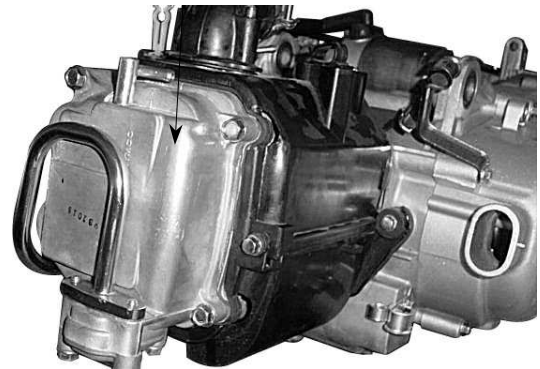

Remove the cam chain tensioner cap screw and the O-ring.

O-ring



Screw

Turn the cam chain tensioner screw clockwise to tighten it.

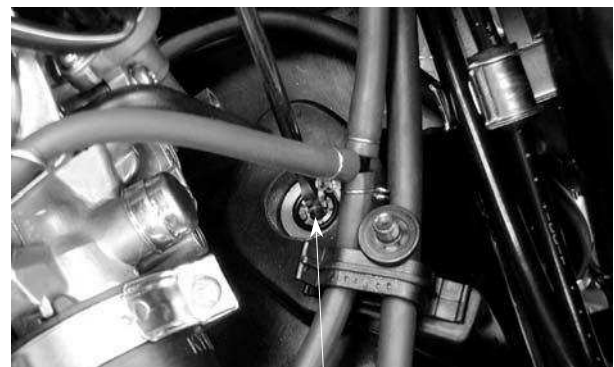

Tensioner Screw

Turn the flywheel counterclockwise so that the "T" mark on the flywheel aligns with the index mark on the crankcase to bring the round hole on the camshaft gear facing up to the top dead center on the compression stroke.

Camshaft Gear



Round Hole

Punch Marks

# 7. CYLINDER HEAD/VALVES

Remove the two cylinder head bolts.  
Remove the four cylinder head nuts and washers.

\* Diagonally loosen the cylinder head nuts in 2 or 3 times.

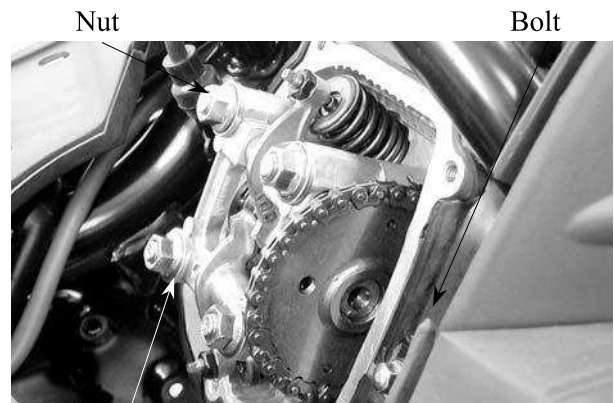

Washer

Remove the camshaft holder and dowel pins.

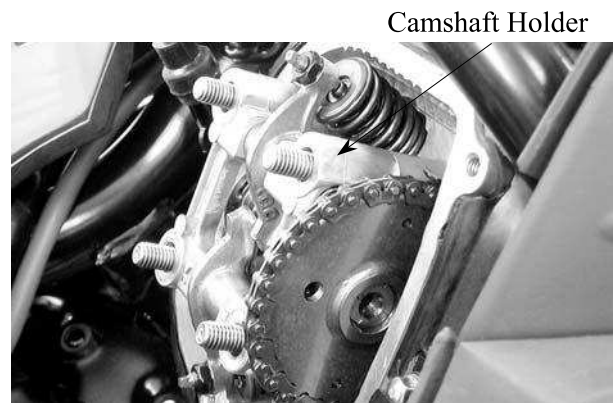

Camshaft Holder

Remove the camshaft gear from the cam chain and remove the camshaft.

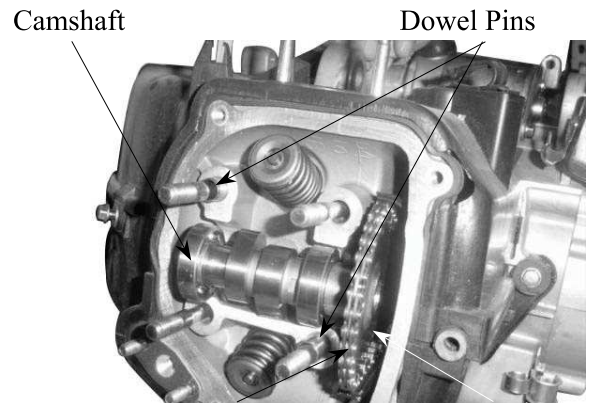

Camshaft

Dowel Pins

Cam Chain

Camshaft Gear

## CAMSHAFT INSPECTION

Check each cam lobe for wear or damage.  
Measure the cam lobe height.

### Service Limits:

IN : 29.40mm replace if below

EX: 29.16mm replace if below



## 7. CYLINDER HEAD/VALVES

Check each camshaft bearing for play or damage. Replace the camshaft assembly with a new one if the bearings are noisy or have excessive play.

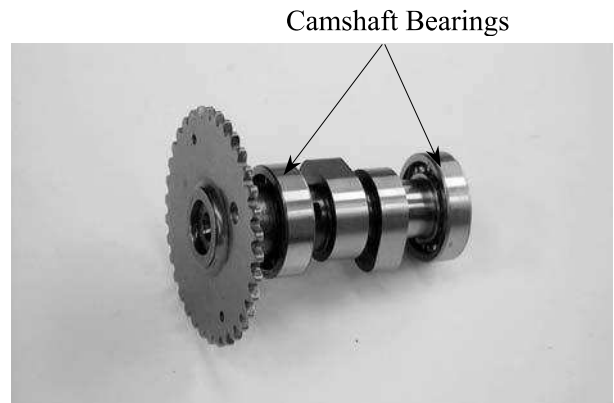

### CAMSHAFT HOLDER DISASSEMBLY

Take out the valve rocker arm shafts using a 5mm bolt.  
Remove the valve rocker arms.

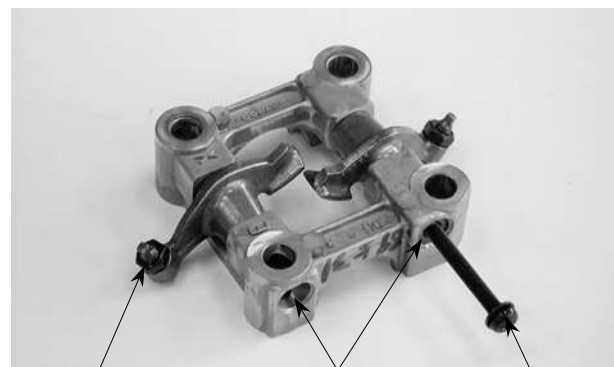

Rocker Arm    Rocker Arm Shaft    5mm Bolt

### CAMSHAFT HOLDER INSPECTION

Inspect the camshaft holder, valve rocker arms and rocker arm shafts for wear or damage.

\* If the valve rocker arm contact surface is worn, check each cam lobe for wear or damage.

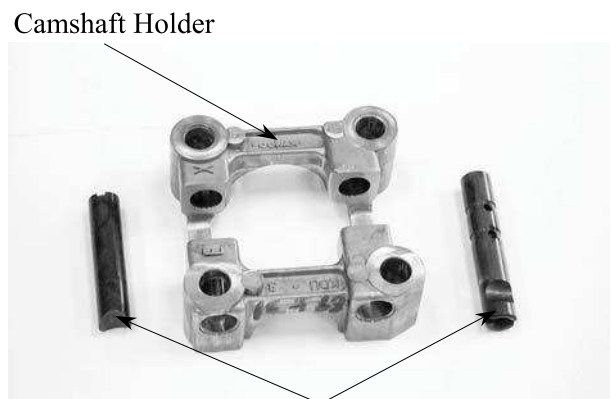

Rocker Arm Shafts

Measure the I.D. of each valve rocker arm.

#### Service Limits:

IN: 10.10mm replace if over

EX: 10.10mm replace if over

Measure each rocker arm shaft O.D.

#### Service Limits:

IN: 9.91mm replace if over

EX: 9.91mm replace if over



## 7. CYLINDER HEAD/VALVES

### CYLINDER HEAD REMOVE

Remove the camshaft.  
Remove the carburetor.  
Remove the exhaust muffler.  
Remove the carburetor intake manifold.  
Remove the cooling fan cover.  
Remove the engine cover bolts and screws.  
Separate the engine cover joint claws.

Remove the cylinder head.

Remove the dowel pins and cylinder head gasket.  
Remove the cam chain guide.

Remove all gasket material from the cylinder mating surface.

- \* • Avoid damaging the cylinder mating surface.
- Be careful not to drop any gasket material into the engine.

Intake Manifold

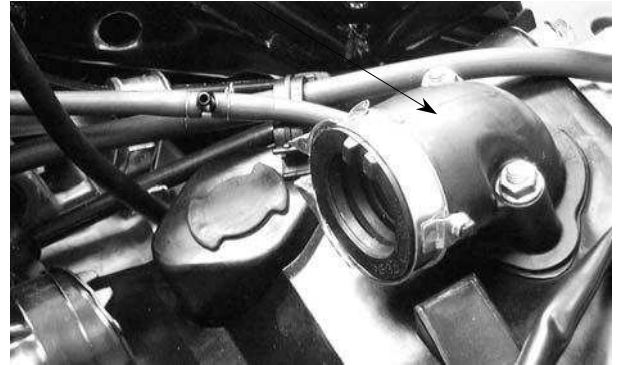

Cylinder Head



Bolts

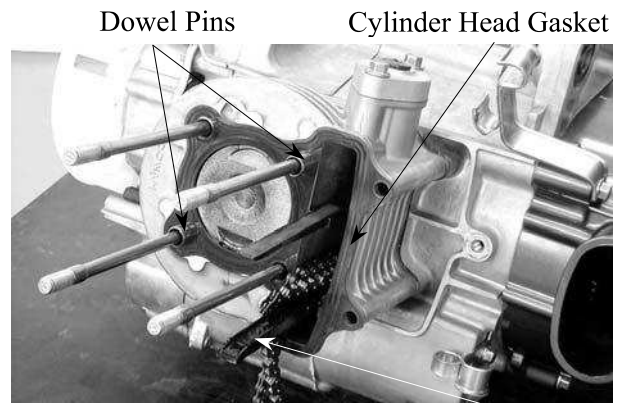

Dowel Pins

Cylinder Head Gasket

Cam Chain Guide

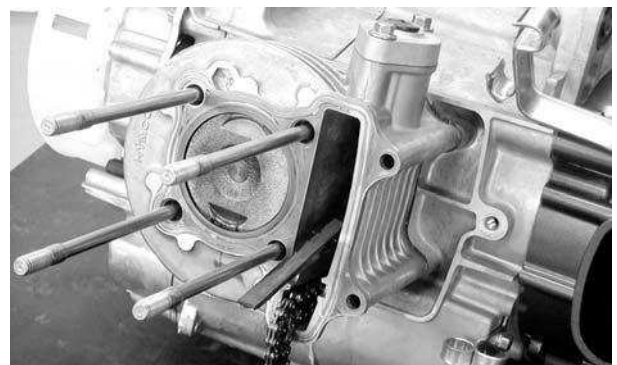



## 7. CYLINDER HEAD/VALVES

### CYLINDER HEAD DISASSEMBLY

Remove the valve spring cotters, retainers, springs, spring seats and valve stem seals using a valve spring compressor.

- \* Special
- Be sure to compress the valve springs with a valve spring compressor.
  - Mark all disassembled parts to ensure correct reassembly.

Special

Valve Spring Compressor

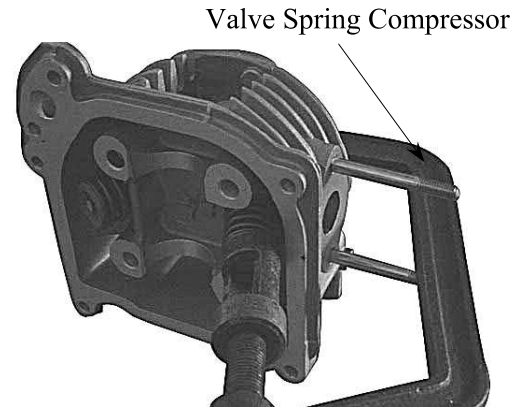

Remove carbon deposits from the combustion chamber.

Clean off any gasket material from the cylinder head mating surface.

- \* Special
- Be careful not to damage the cylinder head mating surface.

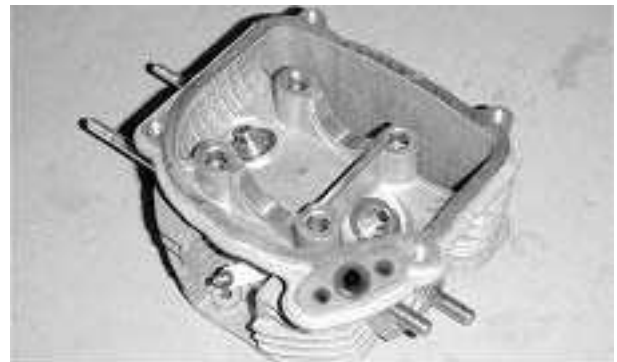

### INSPECTION

#### CYLINDER HEAD

Check the spark plug hole and valve areas for cracks.

Check the cylinder head for warpage with a straight edge and feeler gauge.

**Service Limit:** 0.05mm repair or replace if over

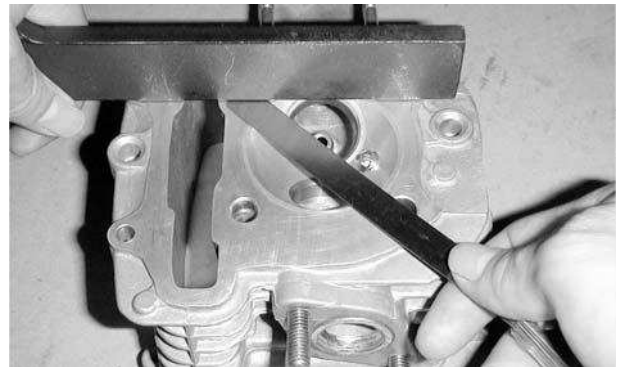

#### VALVE SPRING FREE LENGTH

Measure the free length of the inner and outer valve springs.

**Service Limits:**

Inner : 32.3mm replace if below

Outer : 35.0mm replace if below

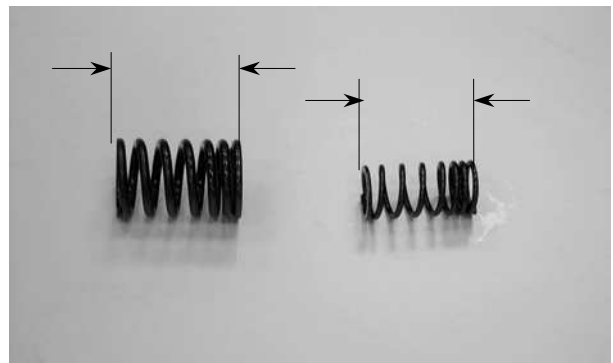

# 7. CYLINDER HEAD/VALVES

## VALVE /VALVE GUIDE

Inspect each valve for bending, burning, scratches or abnormal stem wear.  
Check valve movement in the guide.

Measure each valve stem O.D.

### Service Limits:

IN : 4.90mm replace if below

EX: 4.90mm replace if below

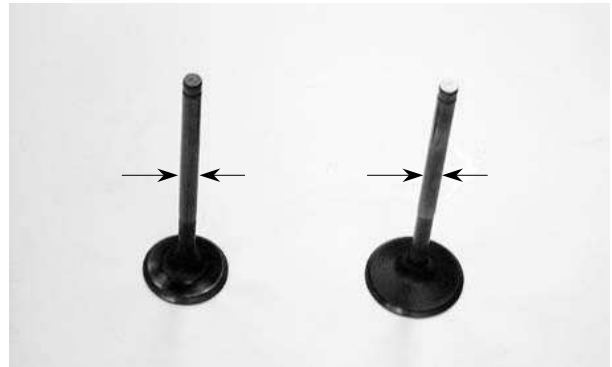

Measure each valve guide I.D.

**Service Limits:** IN : 5.03mm replace if over  
EX: 5.03mm replace if over

Subtract each valve stem O.D. from the corresponding guide I.D. to obtain the stem-to-guide clearance.

**Service Limits:** IN : 0.08mm replace if over  
EX: 0.10mm replace if over

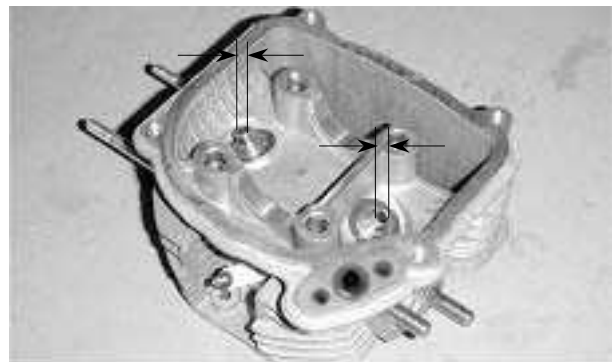

\* If the stem-to-guide clearance exceeds the service limits, replace the cylinder head as necessary.

## CYLINDER HEAD ASSEMBLY

Install the valve spring seats and valve stem seals.

\* Be sure to install new valve stem seals.

Lubricate each valve stem with engine oil and insert the valves into the valve guides.  
Install the valve springs and retainers.

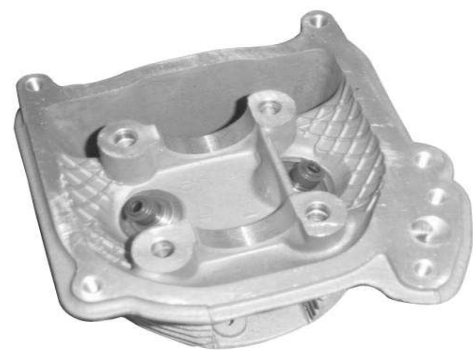

Compress the valve springs using the valve spring compressor, then install the valve cotters.

\* • When assembling, a valve spring compressor must be used.  
• Install the cotters with the pointed ends facing down from the upper side of the cylinder head.

Special

Valve Spring Compressor

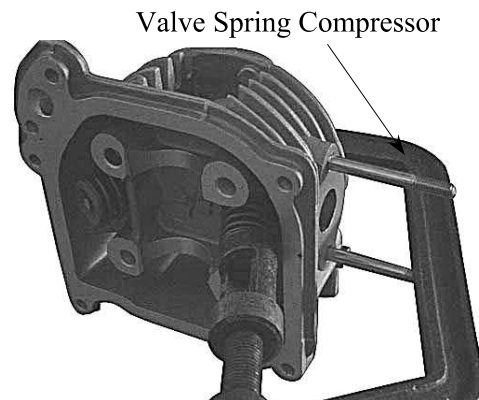

## 7. CYLINDER HEAD/VALVES

Tap the valve stems gently with a plastic hammer for 2~3 times to firmly seat the cotters.

\* Be careful not to damage the valves.

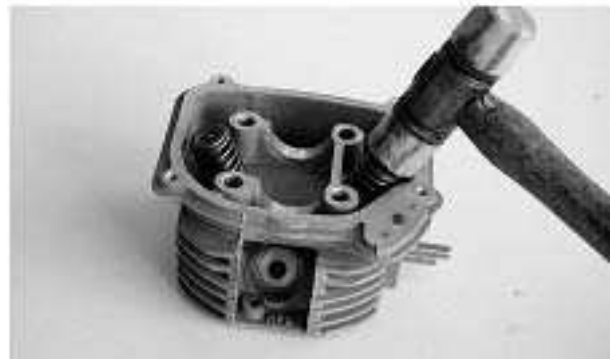

### CYLINDER HEAD INSTALLATION

Tighten the four stud bolts.

Install the dowel pins and a new cylinder head gasket.

Install the cam chain guide.

**Torque:** Stud Bolts :0.7~1.1kg-m

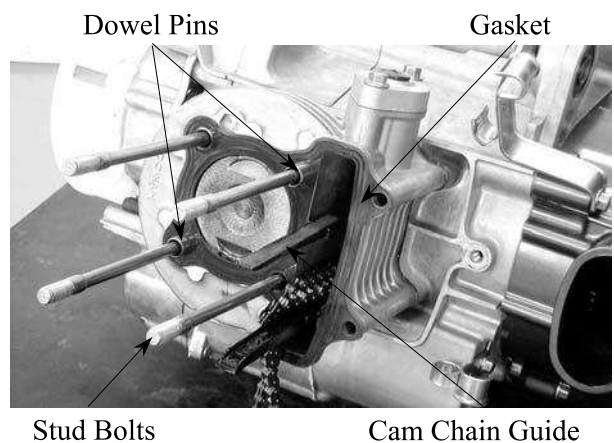

Install the cylinder head.

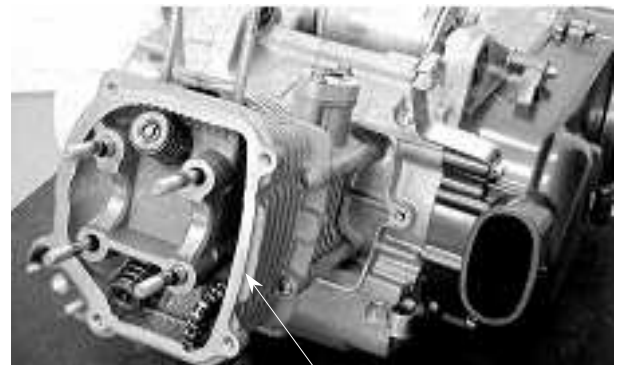

Cylinder Head

### CAMSHAFT HOLDER ASSEMBLY

Install the exhaust valve rocker arm to the "EX" mark side of the camshaft holder.

Install the intake valve rocker arm and the rocker arm shafts.

- \*
- Align the cutout on the front end of the intake valve rocker arm shaft with the bolt of the camshaft holder.
  - Align the cross cutout on the exhaust valve rocker arm shaft with the bolt of the camshaft holder.

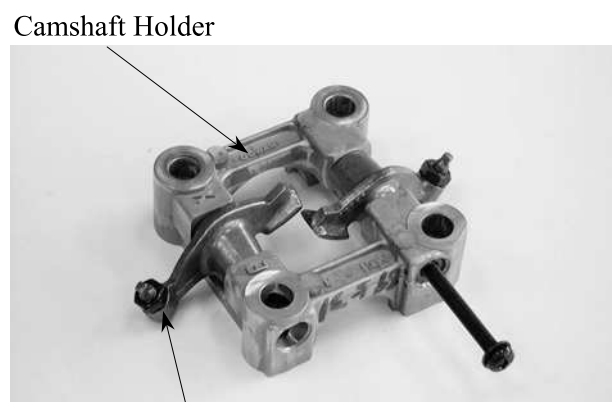

Valve Rocker Arm

## CAMSHAFT INSTALLATION

Turn the flywheel so that the “T” mark on the flywheel aligns with the index mark on the crankcase.

Keep the round hole on the camshaft gear facing up and align the punch marks on the camshaft gear with the cylinder head surface (Position the intake and exhaust cam lobes down.) and install the camshaft onto the cylinder head.

Install the cam chain over the camshaft gear.

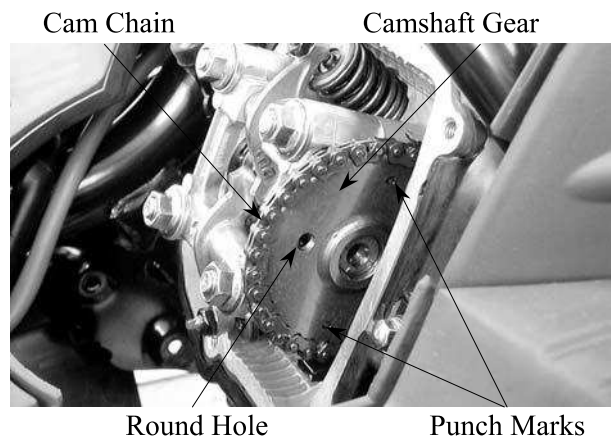

Install the dowel pins.

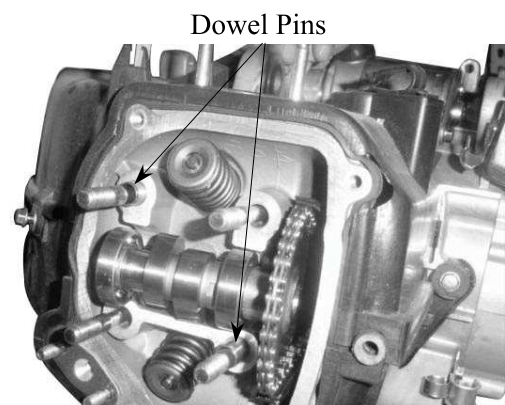

Install the camshaft holder, washers and nuts on the cylinder head.

Tighten the four cylinder head nuts and two bolts.

**Torque:** Cylinder head nut: 2.0kg-m

- \*
  - Apply engine oil to the threads of the cylinder head nuts.
  - Diagonally tighten the cylinder head nuts in 2~3 times.

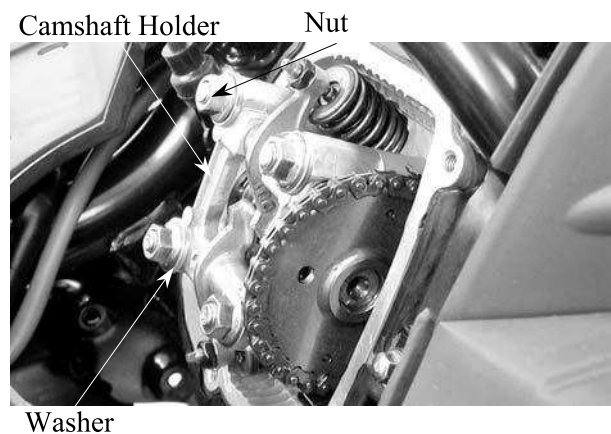

Adjust the valve clearance.

Turn the cam chain tensioner screw counter-clockwise to release it.



## 7. CYLINDER HEAD/VALVES

Apply engine oil to a new O-ring and install it.

Tighten the cam chain tensioner cap screw.

- \* Be sure to install the O-ring into the groove properly.



O-ring

Install a new cylinder head cover O-ring and install the cylinder head cover.

Install and tighten the cylinder head cover bolts.

- \* Be sure to install the O-ring into the groove properly.

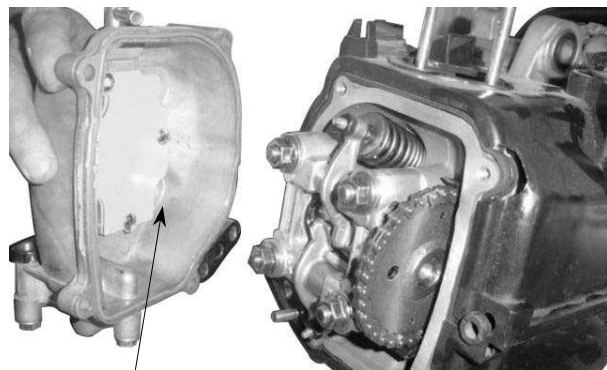

Cylinder Head Cover

# 8. CYLINDER/PISTON

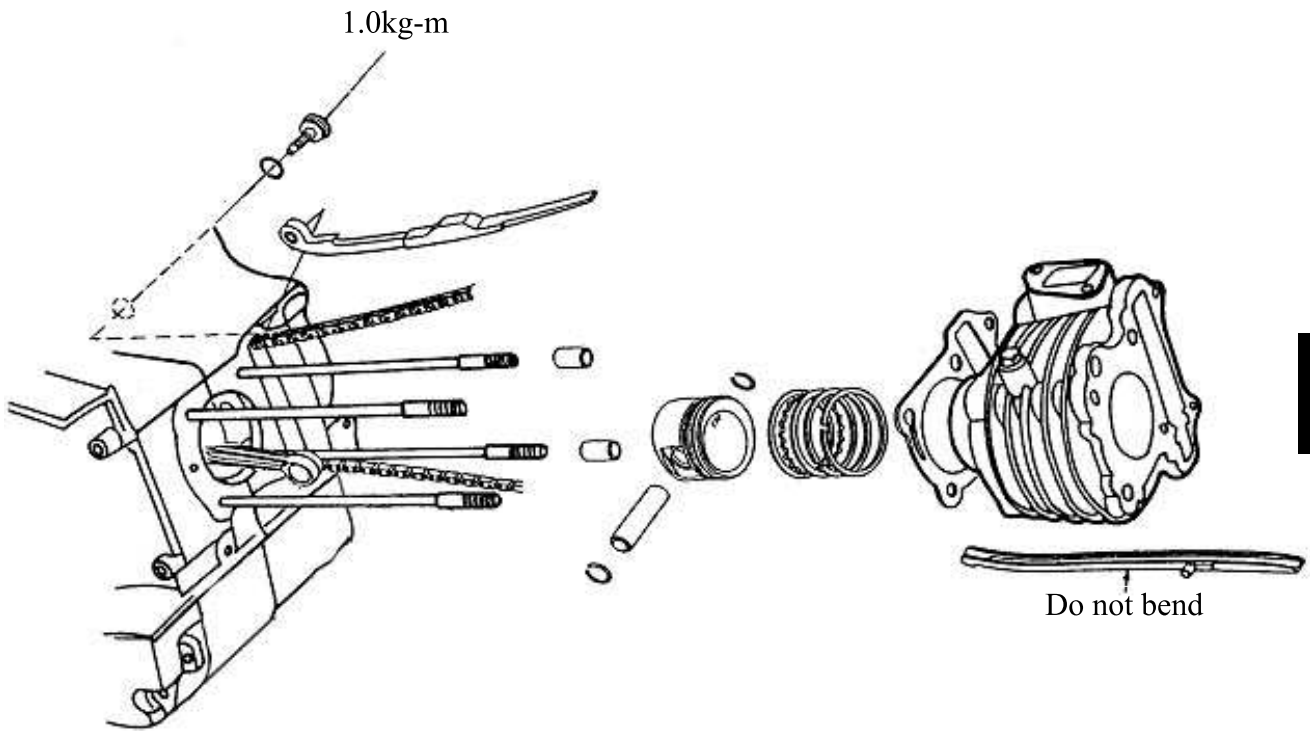

8

## 8. CYLINDER/PISTON

SERVICE INFORMATION.....8-1	PISTON REMOVAL..... 8-2
TROUBLESHOOTING.....8-1	PISTON INSTALLATION..... 8-6
CYLINDER REMOVAL .....8-2	CYLINDER INSTALLATION ..... 8-6

### SERVICE INFORMATION

#### GENERAL INSTRUCTIONS

- The cylinder and piston can be serviced with the engine installed in the frame.
- After disassembly, clean the removed parts and dry them with compressed air before inspection.

#### SPECIFICATIONS

Item		Standard (mm)	Service Limit (mm)	
Cylinder	I.D.	52.4~52.410	52.50	
	Warpage	—	0.05	
	Cylindricity	—	0.05	
	True roundness	—	0.05	
Piston, piston ring	Ring-to-groove clearance	Top	0.015~0.055	0.09
		Second	0.015~0.055	0.09
	Ring end gap	Top	0.10~0.25	0.5
		Second	0.10~0.25	0.5
		Oil side rail	0.2~0.7	—
	Piston O.D.		52.370~52.390	52.3
	Piston O.D. measuring position		9mm from bottom of skirt	—
	Piston-to-cylinder clearance		0.010~0.040	0.1
Piston pin hole I.D.		15.002~15.008	15.04	
Piston pin O.D		14.994~15.000	14.96	
Piston-to-piston pin clearance		0.002~0.014	0.02	
Connecting rod small end I.D. bore		15.016~15.034	15.06	

### TROUBLESHOOTING

- When hard starting or poor performance at low speed occurs, check the crankcase breather for white smoke. If white smoke is found, it means that the piston rings are worn, stuck or broken.

#### Compression too low or uneven compression

- Worn, stuck or broken piston rings
- Worn or damaged cylinder and piston

#### Compression too high

- Excessive carbon build-up in combustion chamber or on piston head

#### Excessive smoke from exhaust muffler

- Worn or damaged piston rings
- Worn or damaged cylinder and piston

#### Abnormal noisy piston

- Worn cylinder, piston and piston rings
- Worn piston pin hole and piston pin

## 8. CYLINDER/PISTON

AGILITY CITY 125/150

### CYLINDER REMOVAL

Remove the cylinder head.  
Remove the cam chain guide.  
Remove the cylinder base bolts.  
Remove the cylinder.

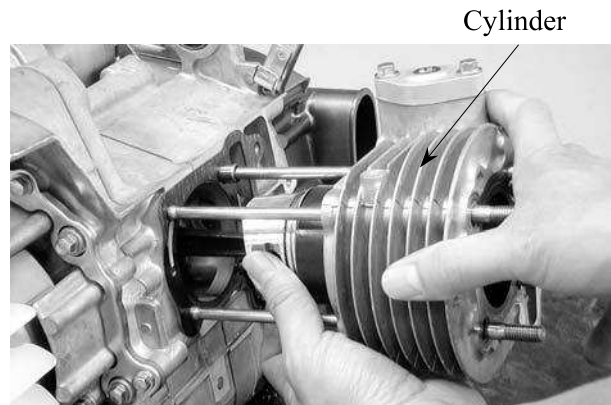

Remove the cylinder gasket and dowel pins.  
Clean any gasket material from the cylinder surface.

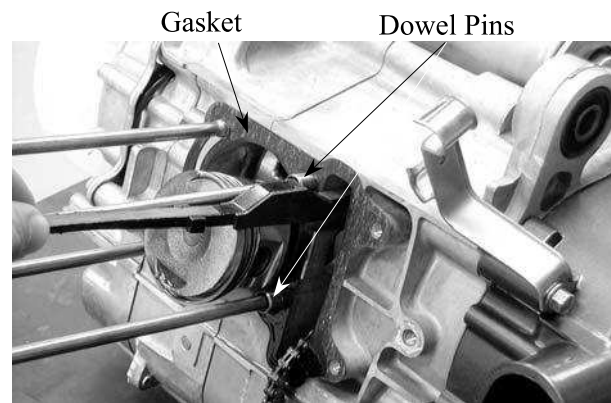

### PISTON REMOVAL

Remove the piston pin clip.

\* Place a clean shop towel in the crankcase to keep the piston pin clip from falling into the crankcase.

Press the piston pin out of the piston and remove the piston.



Piston Rings      Piston



## 8. CYLINDER/PISTON

Inspect the piston, piston pin and piston rings.  
Remove the piston rings.

- \* Take care not to damage or break the piston rings during removal.

Clean carbon deposits from the piston ring grooves.



Install the piston rings onto the piston and measure the piston ring-to-groove clearance.

**Service Limits:**

**Top:** 0.09mm replace if over

**2nd:** 0.09mm replace if over



Remove the piston rings and insert each piston ring into the cylinder bottom.

- \* Use the piston head to push each piston ring into the cylinder.

Measure the piston ring end gap.

**Service Limit:** 0.5mm replace if over



Measure the piston pin hole I.D.

**Service Limit:** 15.04mm replace if over

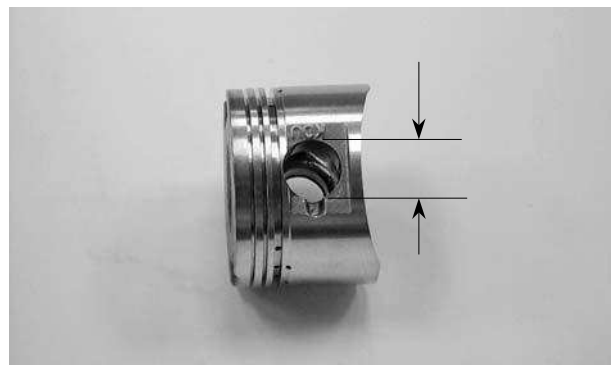

## 8. CYLINDER/PISTON

Measure the piston pin O.D.

**Service Limit:** 14.996mm replace if below

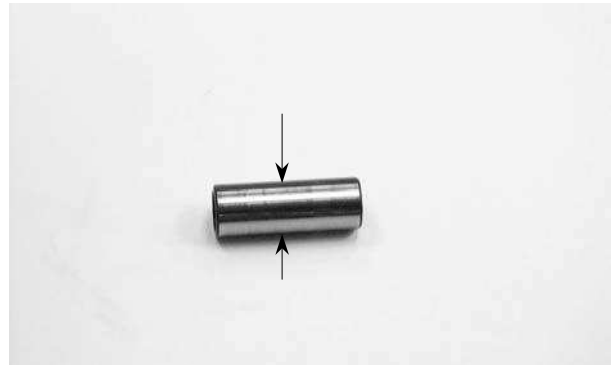

Measure the piston O.D.

\* Take measurement at 9mm from the bottom and 90° to the piston pin hole.

**Service Limit:** 52.3mm replace if below

Measure the piston-to-piston pin clearance.

**Service Limit:** 0.02mm replace if over

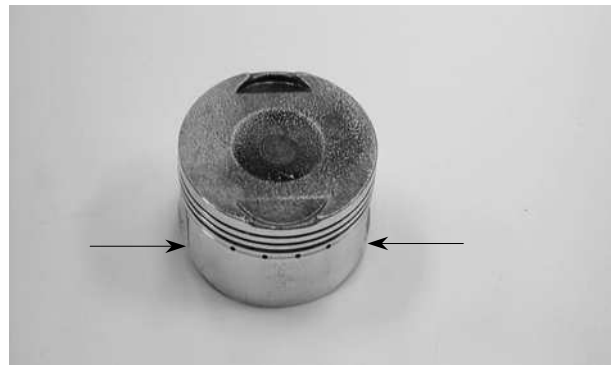

### CYLINDER INSPECTION

Inspect the cylinder bore for wear or damage. Measure the cylinder I.D. at three levels of top, middle and bottom at 90° to the piston pin (in both X and Y directions).

**Service Limit:** 52.50mm repair or replace if over

Measure the cylinder-to-piston clearance.

**Service Limit:** 0.1mm repair or replace if over



The true roundness is the difference between the values measured in X and Y directions. The cylindricity (difference between the values measured at the three levels) is subject to the maximum value calculated.

**Service Limits:**

**True Roundness:** 0.05mm repair or replace if over

**Cylindricity:** 0.05mm repair or replace if over

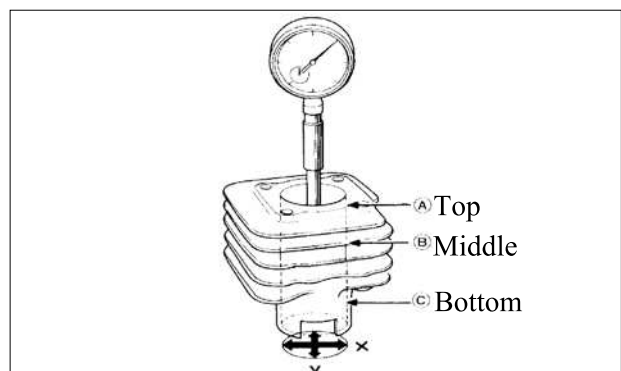

# 8. CYLINDER/PISTON

AGILITY CITY 125/150

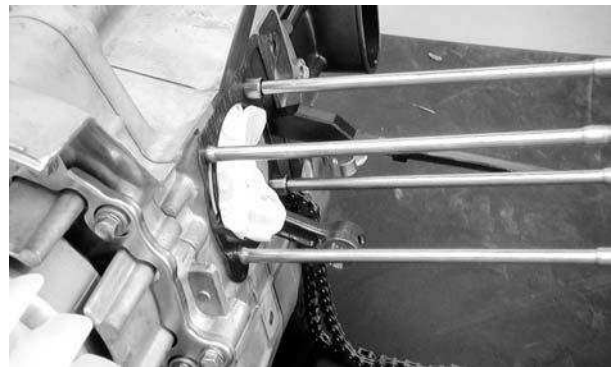

\*

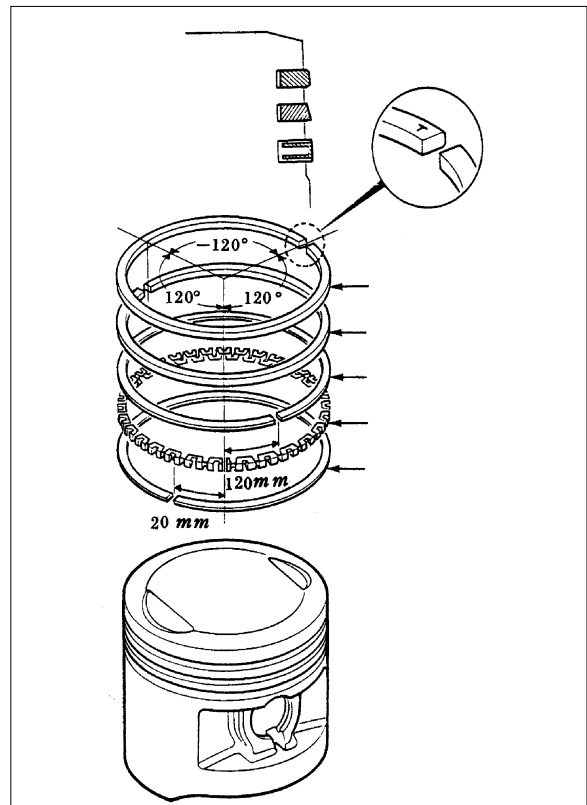

## 8. CYLINDER/PISTON

### PISTON INSTALLATION

Remove any gasket material from the crankcase surface.

- \* Be careful not to drop foreign matters into the crankcase.

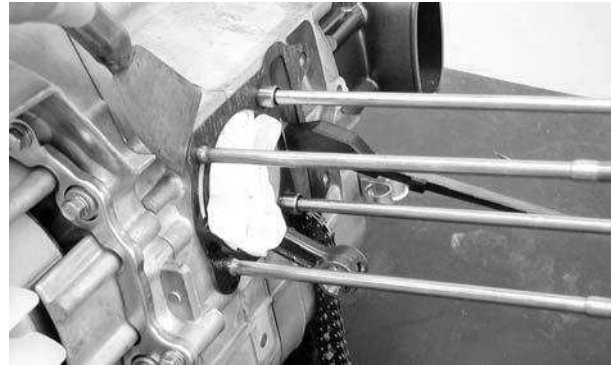

Install the piston, piston pin and a new piston pin clip.

- \*
  - Position the piston "IN" mark on the intake valve side.
  - Place a clean shop towel in the crankcase to keep the piston pin clip from falling into the crankcase.



Piston Pin Clip

Piston Pin

Piston

### CYLINDER INSTALLATION

Install the dowel pins and a new cylinder gasket on the crankcase.



Gasket

Coat the cylinder bore, piston and piston rings with clean engine oil. Carefully lower the cylinder over the piston by compressing the piston rings.

- \*
  - Be careful not to damage or break the piston rings.
  - Stagger the ring end gaps at 120° to the piston pin.

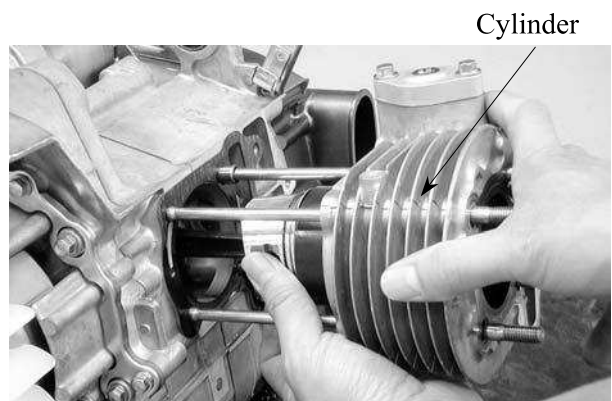

Cylinder

## 8. CYLINDER/PISTON

Loosely install the cylinder base bolts.

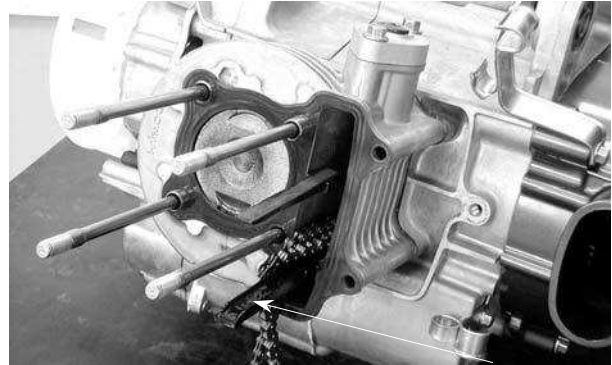

Cam Chain Guide

Install the cam chain guide.

\* Insert the tab on the cam chain guide into the cylinder groove.

Install the cylinder head.  
Tighten the cylinder base bolts.



Cylinder Base Bolt

# 9. DRIVE AND DRIVEN PULLEYS/ KICK STARTER

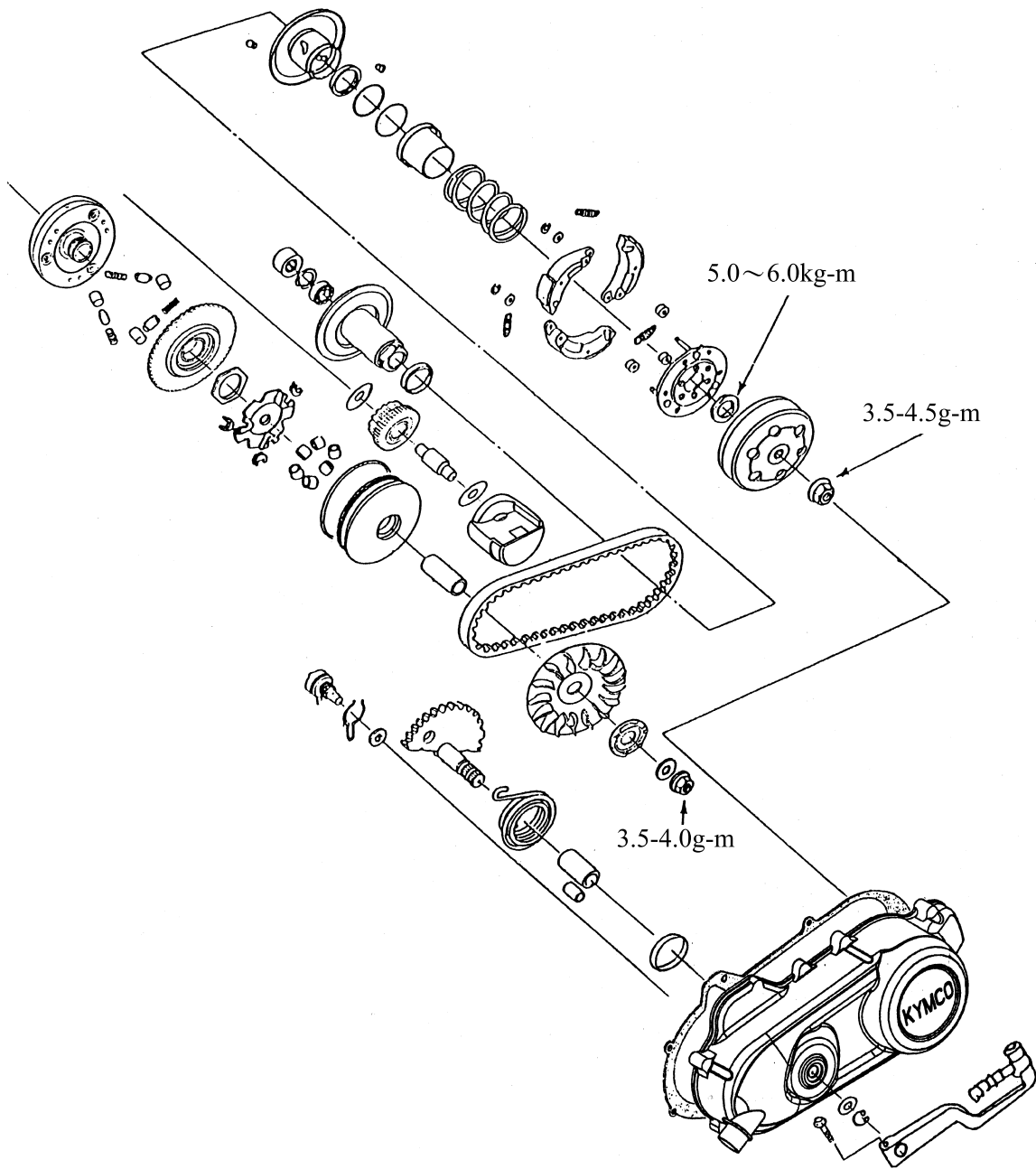

# 9. DRIVE AND DRIVEN PULLEYS/ KICK STARTER



AGILITY CITY 125/150

SERVICE INFORMATION.....9-1	DRIVE BELT ..... 9-5
TROUBLESHOOTING.....9-1	DRIVE PULLEY ..... 9-6
LEFT CRANKCASE COVER .....9-2	CLUTCH/DRIVEN PULLEY ..... 9-9
KICK STARTER.....9-2	

## SERVICE INFORMATION

### GENERAL INSTRUCTIONS

- The drive pulley, clutch and driven pulley can be serviced with the engine installed.
- Avoid getting grease and oil on the drive belt and pulley faces. Remove any oil or grease from them to minimize the slipping of drive belt and drive pulley.

### SPECIFICATIONS

Item	Standard (mm)	Service Limit (mm)
Movable drive face bushing I.D.	23.989~24.025	24.06
Drive face collar O.D.	23.960~23.974	23.94
Drive belt width	17.5	16.5
Clutch lining thickness	—	1.5
Clutch outer I.D.	125.2-125.7	125.5
Driven face spring free length	—	147.6
Driven face O.D.	33.965-33.485	33.94
Movable driven face I.D.	34.0-34.025	34.06
Weight roller O.D.	15.920~16.080	15.4

### TORQUE VALUES

Drive face nut	5.5~6.5kgf-m
Clutch outer nut	3.5~4.5kgf-m
Clutch drive plate nut	5.0-6.0kg-m

### SPECIAL TOOLS

Universal holder	Clutch spring compressor
------------------	--------------------------

### TROUBLESHOOTING

#### Engine starts but motorcycle won't move

- Worn drive belt
- Broken ramp plate
- Worn or damaged clutch lining
- Broken driven face spring

#### Engine stalls or motorcycle creeps

- Broken clutch weight spring

#### Lack of power

- Worn drive belt
- Weak driven face spring
- Worn weight roller
- Fouled drive face

## 9. DRIVE AND DRIVEN PULLEYS/ KICK STARTER

### LEFT CRANKCASE COVER

#### REMOVAL

Loosen the drive belt air tube band screw.

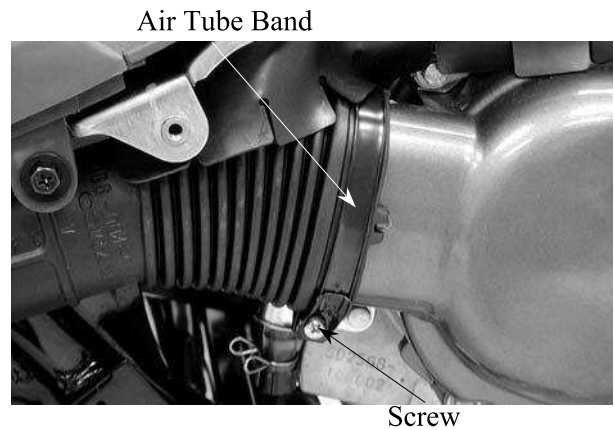

Remove the left crankcase cover bolts and cable clamp.  
Remove the seal rubber and dowel pins.

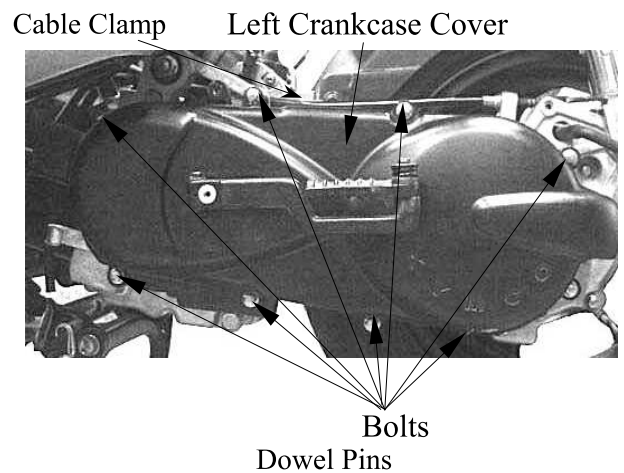

#### INSTALLATION

Install the dowel pins and gasket.

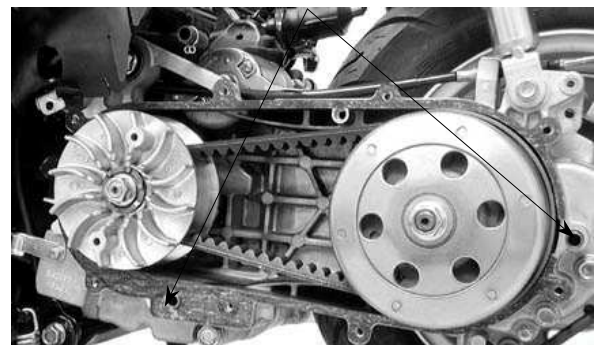

Install the left crankcase cover and tighten the left crankcase cover bolts.  
Install the cable clamp to the specified location and tighten the bolt.

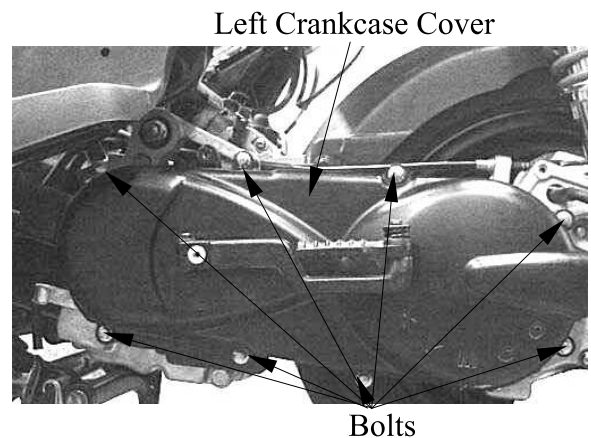



## 9. DRIVE AND DRIVEN PULLEYS/ KICK STARTER

Install the drive belt air tube and tighten the tube band screw.

### DRIVE PULLEY

#### REMOVAL

Remove the left crankcase cover.  
Hold the drive pulley using an universal holder and remove the drive face nut and starting ratchet.  
Remove the drive pulley face.

Special

Flywheel Holder

Hold the clutch outer with the universal holder and remove the clutch outer nut.  
Remove the clutch/driven pulley and drive belt.

#### INSPECTION

Check the drive belt for cracks, separation or abnormal or excessive wear.  
Measure the drive belt width.

**Service Limit:** 17.0mm replace if below

\* Use specified genuine parts for replacement.

Intake Cover

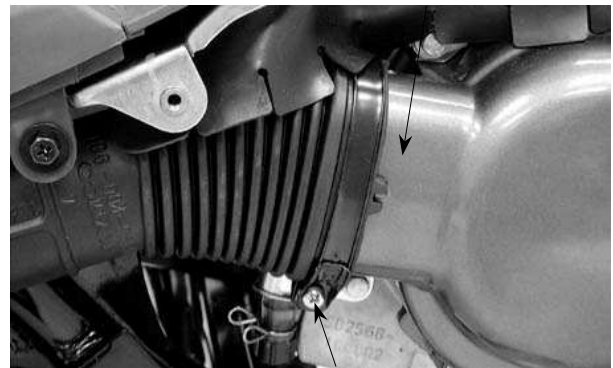

Tube Band Screw

Starting Ratchet

Drive Pulley Face

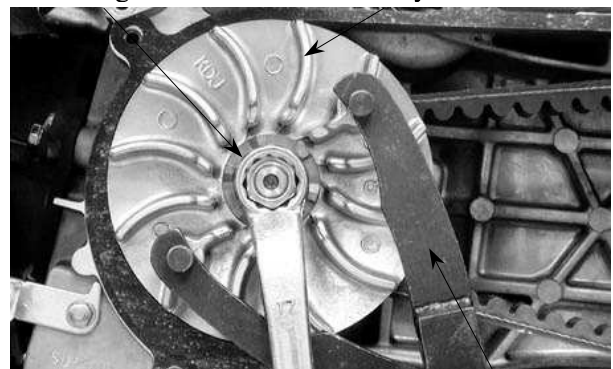

Flywheel Holder

Movable Drive Face



Drive Belt

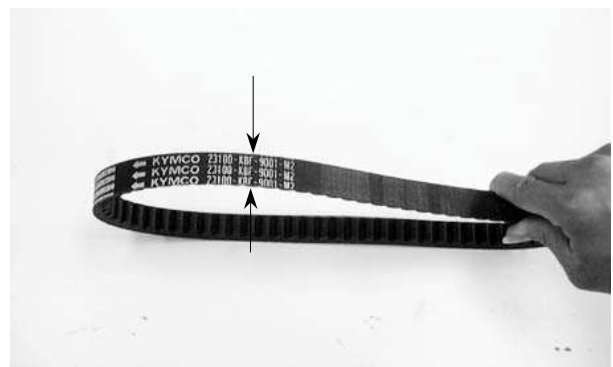

## 9. DRIVE AND DRIVEN PULLEYS/ KICK STARTER

Remove the movable drive face assembly.  
Remove the drive pulley collar.

Drive Pulley Collar

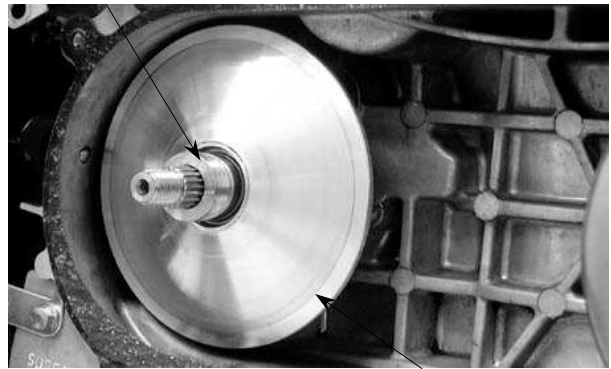

Movable Drive Face Assembly

### DISASSEMBLY

Remove the ramp plate.

Ramp Plate



Remove the weight rollers.



Weight Roller

### INSPECTION

Check each weight roller for wear or damage.

Measure each weight roller O.D.

**Service Limit:** 15.4mm replace if below

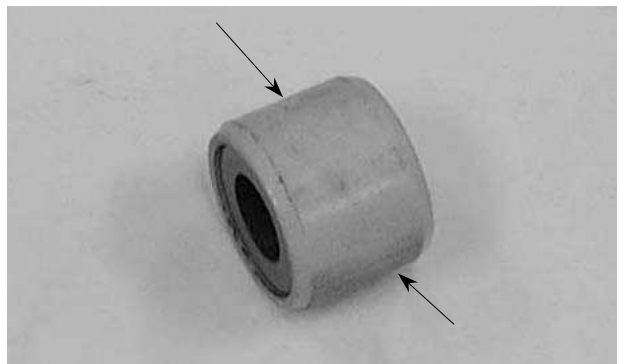

## 9. DRIVE AND DRIVEN PULLEYS/ KICK STARTER

Measure the movable drive face bushing I.D.

**Service Limit:** 24.06mm replace if over



Check the drive pulley collar for wear or damage.  
Measure the O.D. of the drive pulley collar sliding surface.

**Service Limit:** 23.94mm replace if below

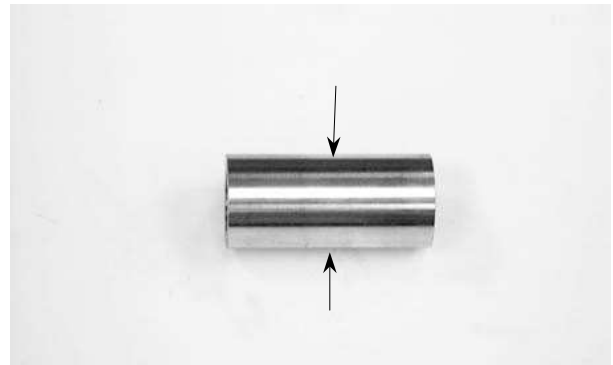

### ASSEMBLY

Install the weight rollers into the movable drive face.



Weight Roller

Install the ramp plate.

Ramp Plate



## 9. DRIVE AND DRIVEN PULLEYS/ KICK STARTER

Insert the drive pulley collar into the movable drive face.



### INSTALLATION

Install the movable drive face onto the crankshaft.

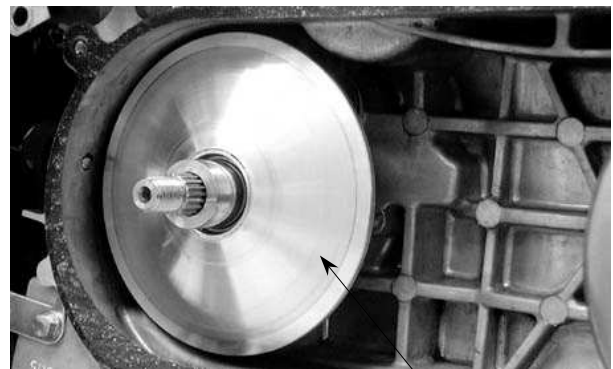

Lay the drive belt on the driven pulley.  
Set the drive belt on the drive pulley collar.

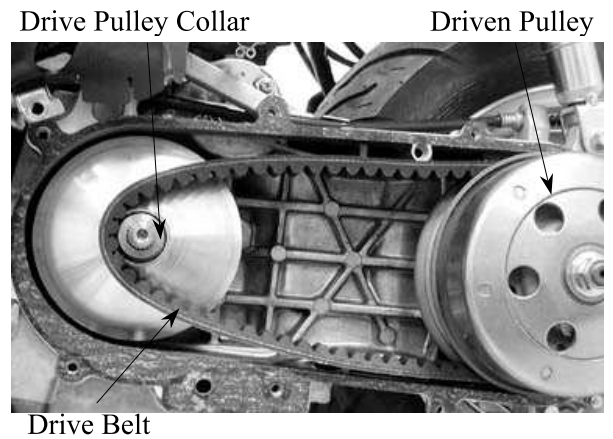

## 9. DRIVE AND DRIVEN PULLEYS/ KICK STARTER

Install the drive pulley face, starting ratchet and drive face nut.

- \* When installing the drive pulley face, compress it to let the drive belt move downward to the lowest position so that the drive pulley can be tightened.
- \* Install the starting ratchet by aligning the starting ratchet teeth with the crankshaft teeth.

Drive Pulley Face

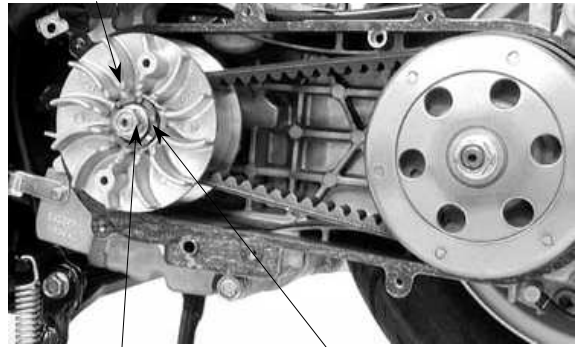

Drive Face Nut Starting Ratchet

Hold the drive pulley with the universal holder and tighten the drive face nut.

**Torque:** 5.5kg-m

Special

Flywheel Holder

- \* Do not get oil or grease on the drive belt or pulley faces.

Drive Pulley

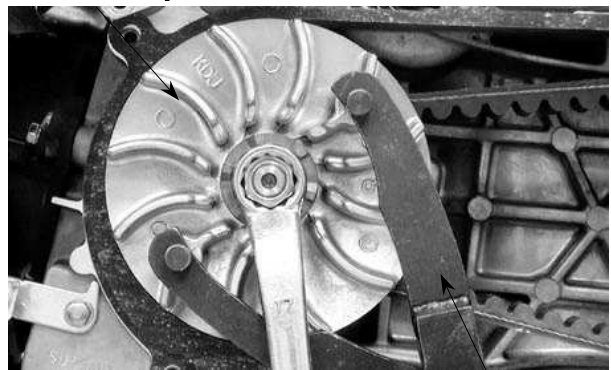

Flywheel Holder

### CLUTCH/DRIVEN PULLEY

Remove the left crankcase cover.  
Remove the drive pulley and drive belt.  
Hold the clutch outer with the universal holder and remove the clutch outer nut.

Special

Flywheel Holder

Clutch Outer

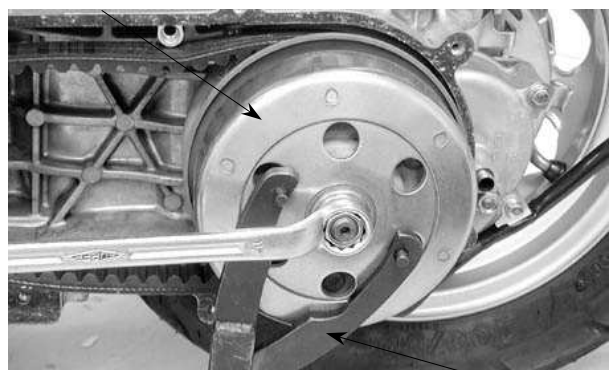

Flywheel Holder

### INSPECTION

Inspect the clutch outer for wear or damage.  
Measure the clutch outer I.D.

**Service Limit:** 125.5mm replace if over



## 9. DRIVE AND DRIVEN PULLEYS/ KICK STARTER

Check the clutch shoes for wear or damage.  
Measure the clutch lining thickness.

**Service Limit:** 1.5mm replace if below

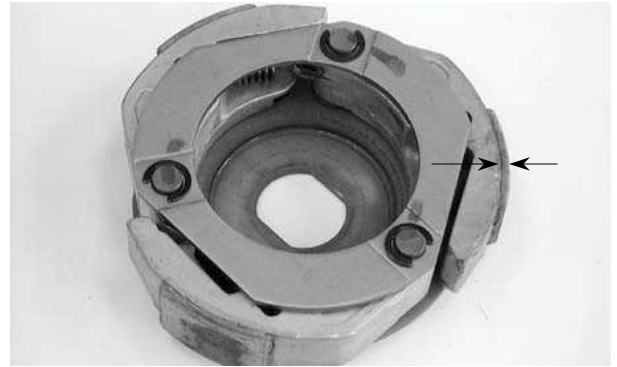

### CLUTCH/DRIVEN PULLEY DISASSEMBLY

Clutch/Driven Pulley

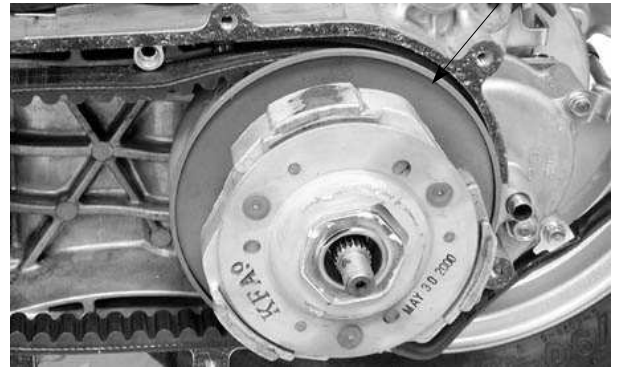

Hold the clutch/driven pulley assembly with  
the clutch spring compressor.

\* Be sure to use a clutch spring  
compressor to avoid spring damage.

Special

Clutch Spring Compressor

Clutch Spring Compressor



Set the clutch spring compressor in a vise  
and remove the clutch drive plate nut.

Loosen the clutch spring compressor and  
disassemble the clutch/driven pulley  
assembly.  
Remove the seal collar.



## 9. DRIVE AND DRIVEN PULLEYS/ KICK STARTER

Pull out the guide roller pins and guide rollers. Remove the movable driven face from the driven face.

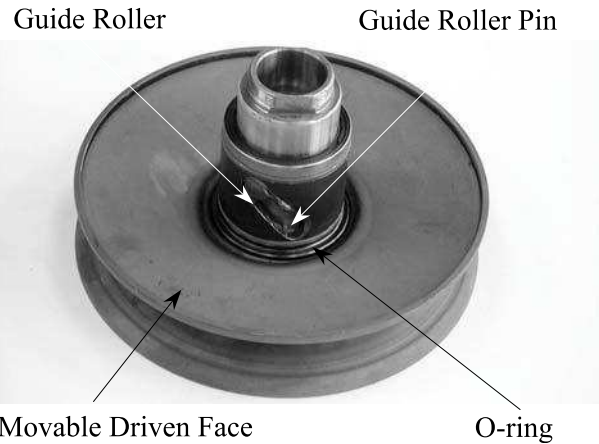

Remove the oil seal from the movable driven face.



### INSPECTION

Measure the driven face spring free length.

**Service Limit:** 147.6mm replace if below

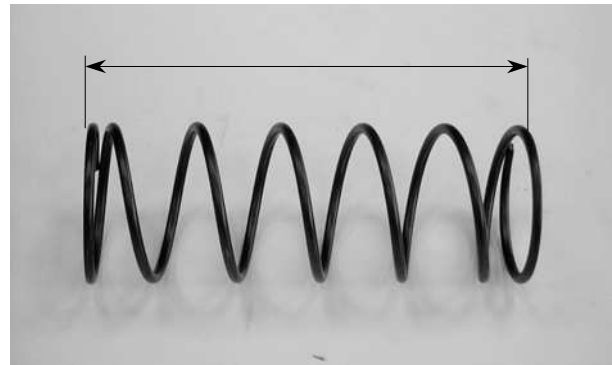

Check the driven face for wear or damage. Measure the driven face O.D.

**Service Limit:** 33.94mm replace if below



## 9. DRIVE AND DRIVEN PULLEYS/ KICK STARTER

Check the movable driven face for wear or damage.

Measure the movable driven face I.D.

**Service Limit:** 34.06mm replace if over



### DRIVEN PULLEY FACE BEARING REPLACEMENT

Drive the inner needle bearing out of the driven pulley face.

- \* Discard the removed bearing and replace with a new one.



Inner Bearing

Remove the drive the outer bearing out of the driven face.

- \* Discard the removed bearing and replace with a new one.

Apply grease to the outer bearing.  
Drive a new outer bearing into the driven face with the sealed end facing up.



Outer Bearing

Apply grease to the driven face bore areas.

- \* Pack all bearing cavities with 9~9.5g grease.  
Specified grease: Heat resistance 230°C





## 9. DRIVE AND DRIVEN PULLEYS/ KICK STARTER

Press a new needle bearing into the driven face.



### CLUTCH DISASSEMBLY

Remove the circlips and retainer plate to disassemble the clutch.

\* Keep grease off the clutch linings.

### CLUTCH ASSEMBLY

Install the damper rubbers on the drive plate pins.  
Install the clutch weights/shoes and clutch springs onto the drive plate.  
Install the retainer plate and secure with the circlips.

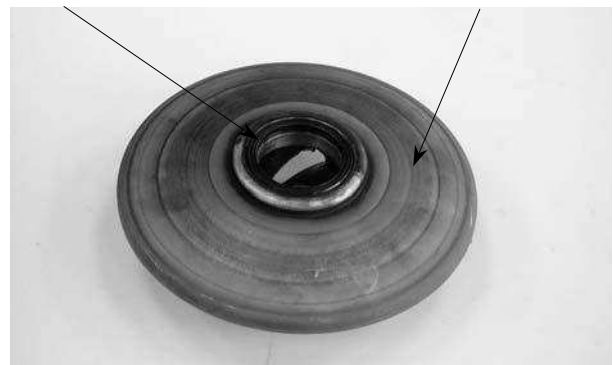
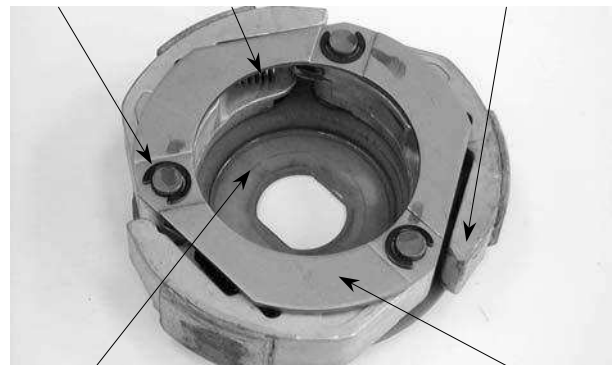
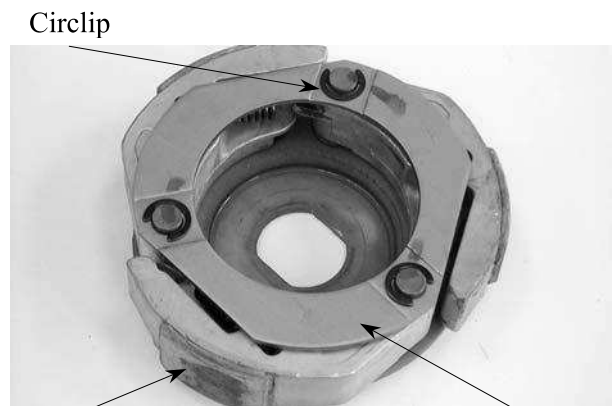

## 9. DRIVE AND DRIVEN PULLEYS/ KICK STARTER

Install the movable driven face onto the driven face.  
Apply grease to the guide rollers and guide roller pins and then install them into the holes of the driven face.  
Install the seal collar.  
Remove any excessive grease.

- \* Be sure to clean the driven face off any grease.

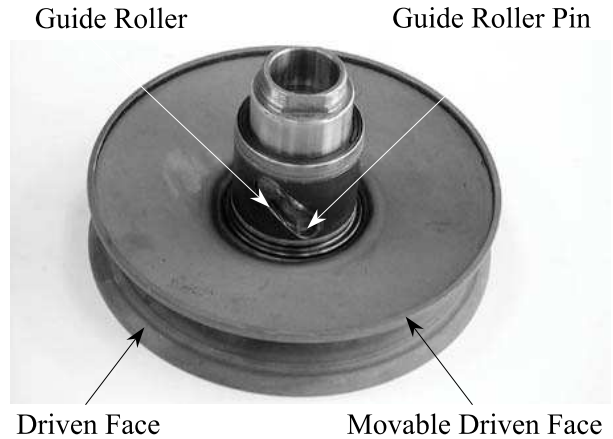

Set the driven pulley assembly, driven face spring and clutch assembly onto the clutch spring compressor.

- \* Align the flat surface of the driven face with the flat on the clutch drive plate.



Compress the clutch spring compressor and install the drive plate nut.  
Set the clutch spring compressor in a vise and tighten the drive plate nut to the specified torque.

**Torque:** 5.5kg-m

- \* Be sure to use a clutch spring compressor to avoid spring damage.

Special

Clutch Spring Compressor

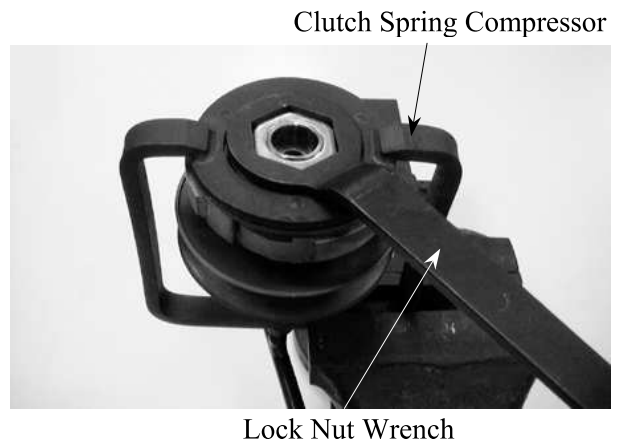

### INSTALLATION

Install the clutch/driven pulley onto the drive shaft.

- \* Keep grease off the drive shaft.

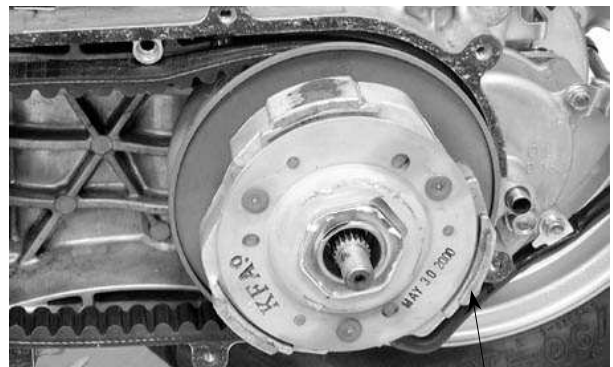

Clutch/Driven Pulley

## 9. DRIVE AND DRIVEN PULLEYS/ KICK STARTER

Install the clutch outer.  
Hold the clutch outer with the universal  
holder.

Install and tighten the clutch outer nut.

**Torque:** 5.5kg-m

Special

Flywheel Holder

Install the drive belt.  
Install the left crankcase cover.

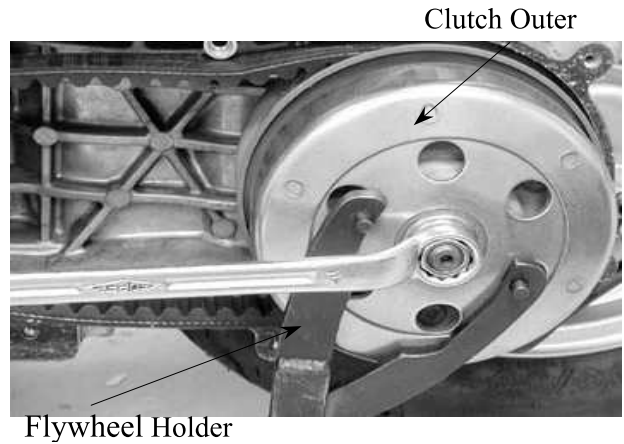

### KICK STARTER

#### REMOVAL

Remove the left crankcase cover.  
Remove the seal rubber and dowel pins.

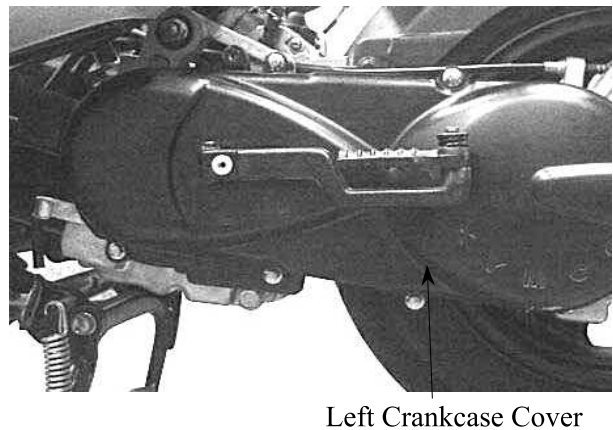

Remove the kick lever.  
Remove the circlip and washer from the kick  
starter spindle.

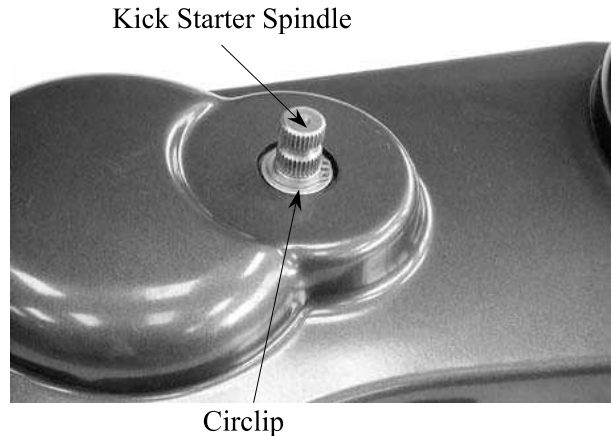

Gently turn the kick starter spindle to remove  
the starter driven gear together with the  
friction spring.

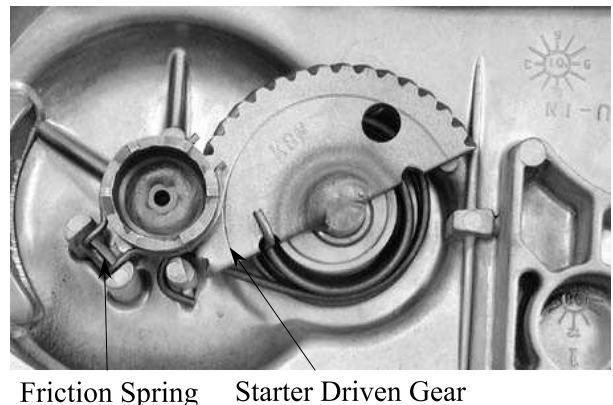

## 9. DRIVE AND DRIVEN PULLEYS/ KICK STARTER

Remove the kick starter spindle and return spring from the left crankcase cover.  
Remove the kick starter spindle bushing.

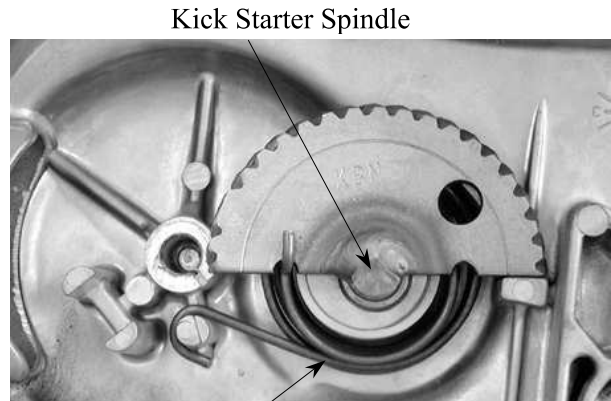

Kick Starter Spindle

Return Spring

Spindle

Return Spring

### INSPECTION

Inspect the kick starter spindle and gear for wear or damage.  
Inspect the return spring for weakness or damage.  
Inspect the kick starter spindle bushings for wear or damage.

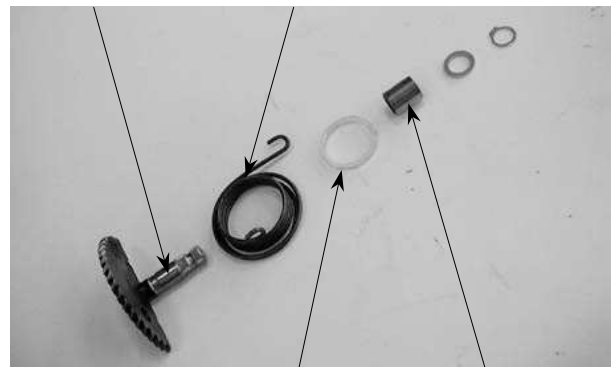

Plastic Bushing Spindle Bushing  
Friction Spring

Inspect the starter driven gear for wear or damage.  
Inspect the friction spring for wear or damage.



Starter Driven Gear

Kick Starter Spindle Forcing Part

Inspect the kick starter spindle and starter driven gear forcing parts for wear or damage.

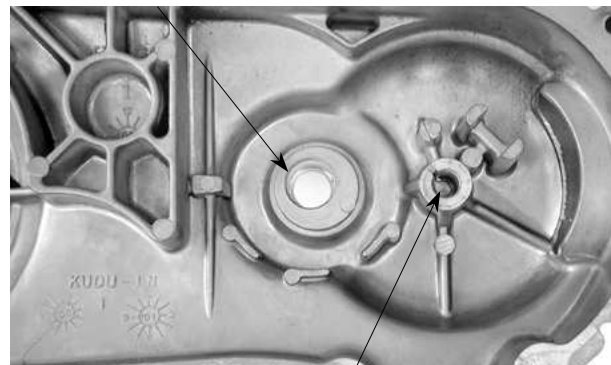

Starter Driven Gear Shaft Forcing Part

## 9. DRIVE AND DRIVEN PULLEYS/ KICK STARTER

### INSTALLATION

Install the kick starter spindle bushings and return spring onto the left crankcase cover.

- \* When installing the return spring, use a screw driver to press the inward and outward return spring hooks into their original positions respectively.

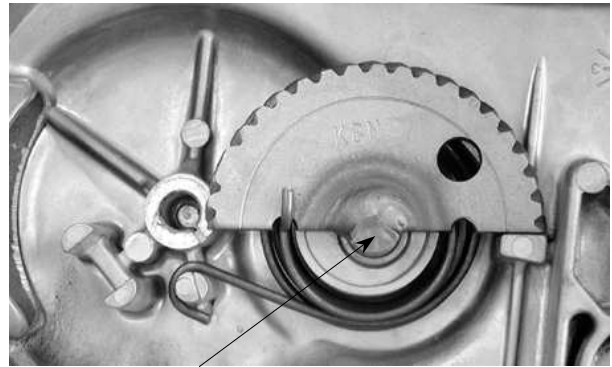

Kick Starter Spindle

Install the starter driven gear and friction spring as the figure shown.

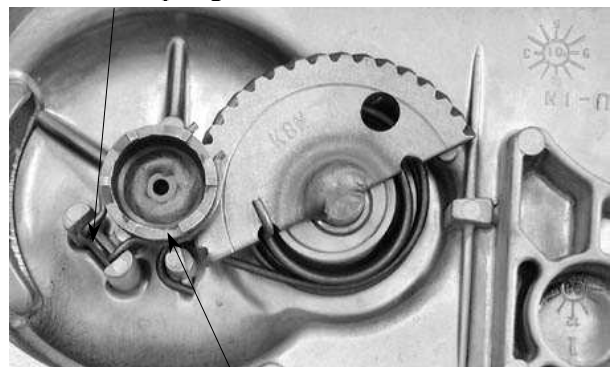

Friction Spring

Starting Ratchet

Install the kick lever.  
Install the left crankcase cover and tighten the cover bolts diagonally.  
Connect the drive belt air tube and tighten the band screw.

- \* For drum brake, be sure to install the rear brake cable clamp to the specified location and install the brake cable into the brake cable holder.

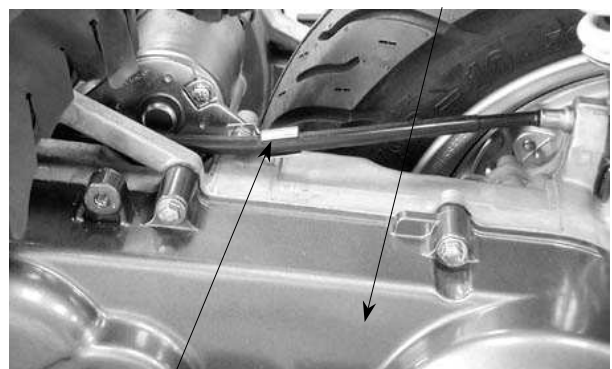

Left Crankcase Cover

Rear Brake Cable Clamp

# 10. FINAL REDUCTION

AGILITY CITY 125/150

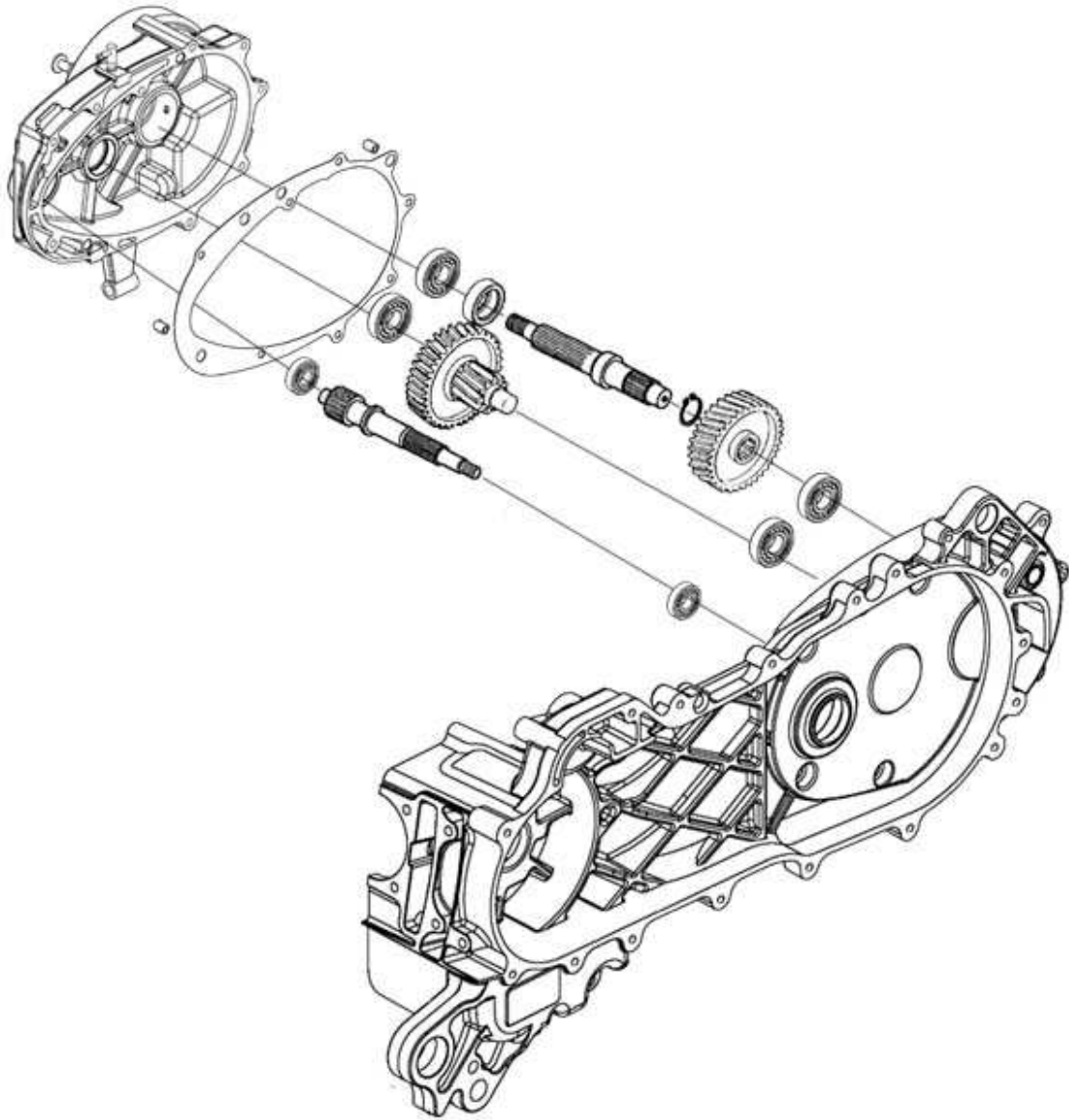

# 10. FINAL REDUCTION

---

SERVICE INFORMATION.....10-1	FINAL REDUCTION INSPECTION..... 10-2
TROUBLESHOOTING.....10-1	BEARING REPLACEMENT ..... 10-3
FINAL REDUCTION DISASSEMBLY ....10-2	FINAL REDUCTION ASSEMBLY..... 10-4

## SERVICE INFORMATION

### SPECIFICATIONS

Specified Oil: GEAR OIL SAE 90#

Oil Capacity:           At disassembly : 0.2 liter  
                                  At change           : 0.18 liter

### SPECIAL TOOLS

Bearing puller, 10,12,15,18mm

## TROUBLESHOOTING

### Engine starts but motorcycle won't move

- Damaged transmission
- Seized or burnt transmission
- Faulty drive belt
- Faulty clutch

### Abnormal noise

- Worn, seized or chipped gears
- Worn bearing

### Oil leaks

- Oil level too high
- Worn or damaged oil seal

# 10. FINAL REDUCTION

AGILITY CITY 125/150

## FINAL REDUCTION DISASSEMBLY

- Remove the rear brake cable. (⇒13-3)
- Remove the rear wheel. (⇒13-2)
- Remove the left crankcase cover. (⇒9-2)
- Remove the clutch/driven pulley. (⇒9-10)
- Drain the transmission gear oil into a clean container.
- Remove the transmission case cover attaching bolts.
- Remove the transmission case cover.
- Remove the gasket and dowel pins.

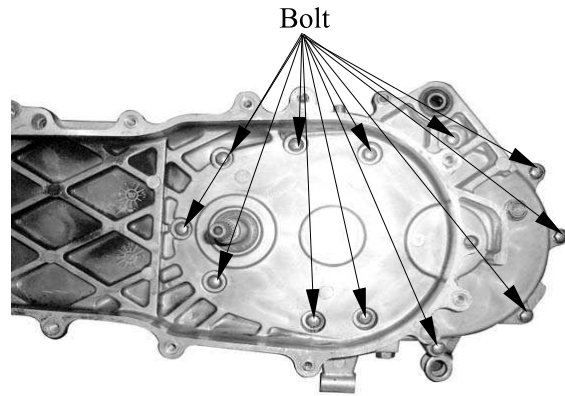

Remove the final gear and countershaft.

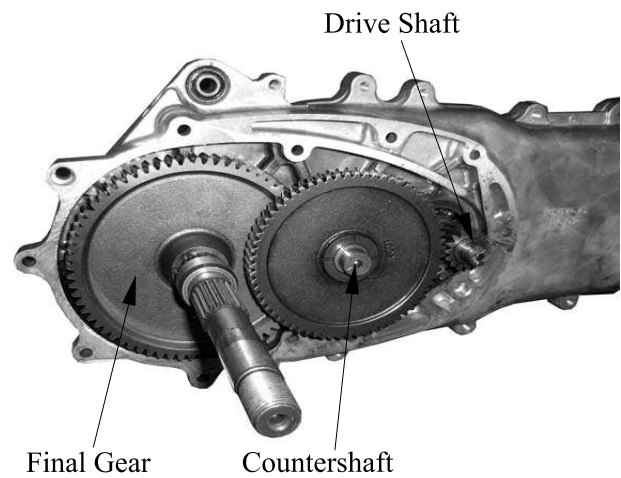

## FINAL REDUCTION INSPECTION

Inspect the countershaft and gear for wear or damage.

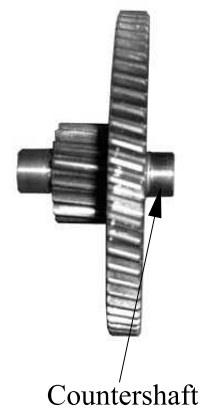

Inspect the final gear and final shaft for wear, damage or seizure.

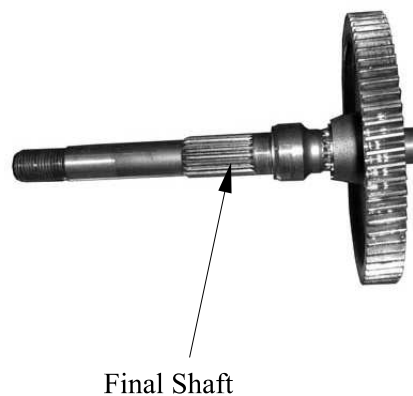



# 10. FINAL REDUCTION

Check the left crankcase bearings for excessive play and inspect the oil seal for wear or damage.

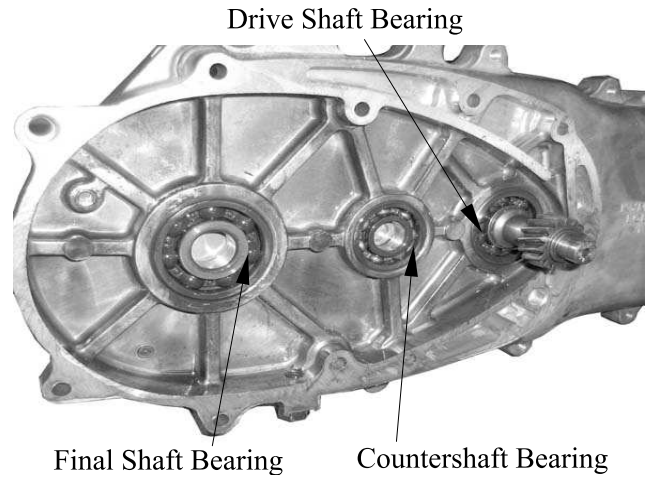

Inspect the drive shaft and gear for wear or damage. Check the transmission case cover bearings for excessive play and inspect the final shaft bearing oil seal for wear or damage.

\* Do not remove the transmission case cover except for necessary part replacement. When replacing the drive shaft, also replace the bearing and oil seal.

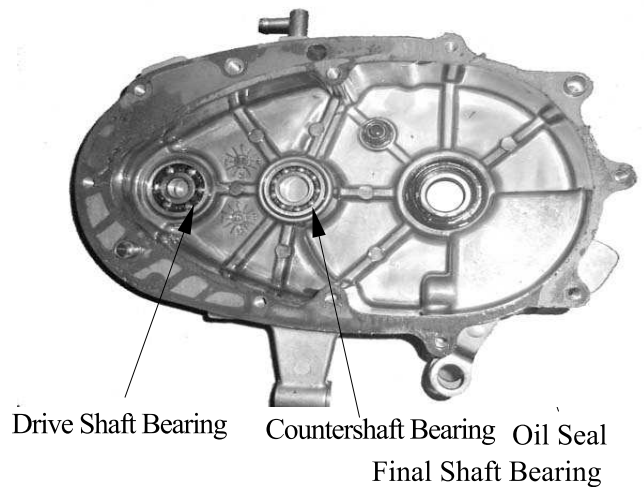

## BEARING REPLACEMENT (TRANSMISSION CASE COVER)

Remove the transmission case cover bearings using a bearing puller. Remove the final shaft oil seal.

Special

Bearing Puller

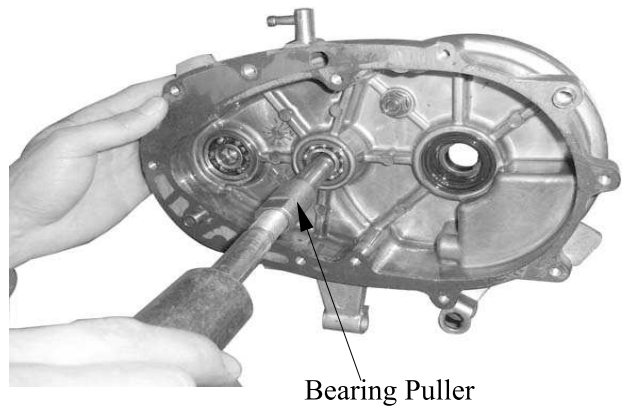

Drive new bearings into the transmission case cover.

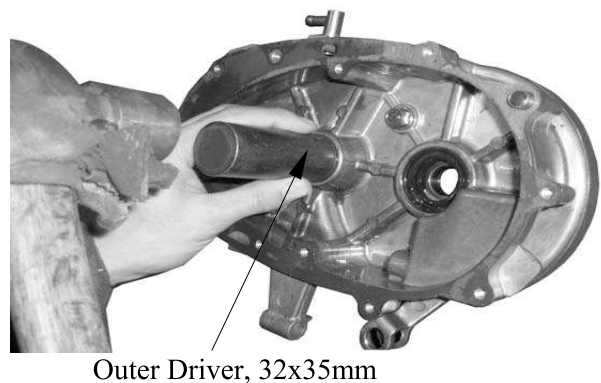

# 10. FINAL REDUCTION

## BEARING REPLACEMENT (LEFT CRANKCASE)

Remove the drive shaft.  
 Remove the drive shaft oil seal.  
 Remove the left crankcase bearings using a bearing puller.

**Special**

Bearing Puller

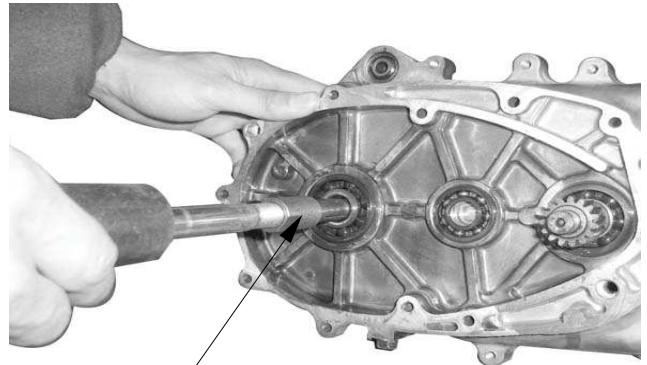

Bearing Puller, 12mm

Drive new bearings into the left crankcase.  
 Install a new drive shaft oil seal.

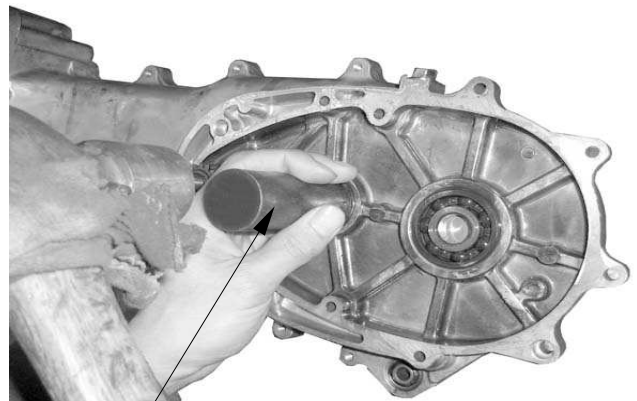

Pilot

## FINAL REDUCTION ASSEMBLY

Install the drive shaft into the left crankcase.

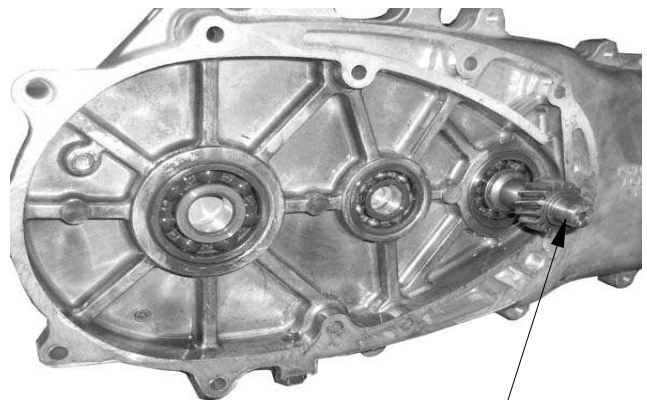

Drive Shaft

Install the final gear and final shaft into the left crankcase.

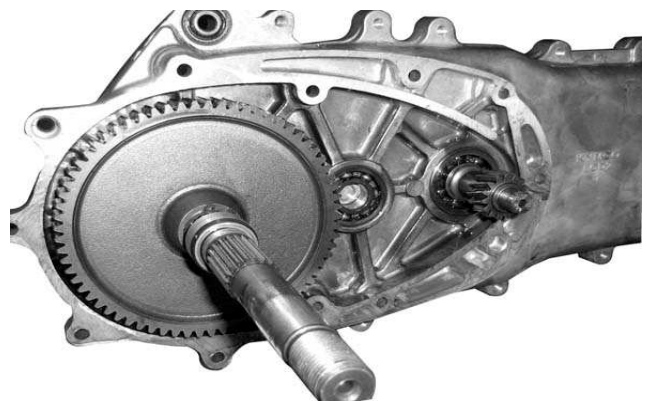

# 10. FINAL REDUCTION

Install the countershaft and gear into the left crankcase.  
Install the dowel pins and a new gasket.

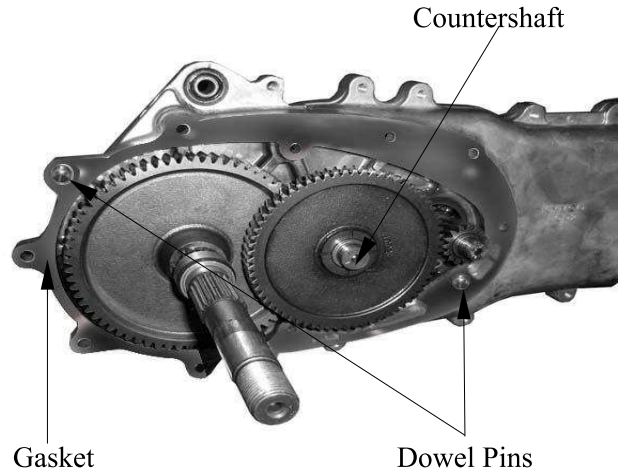

Install the transmission case cover.

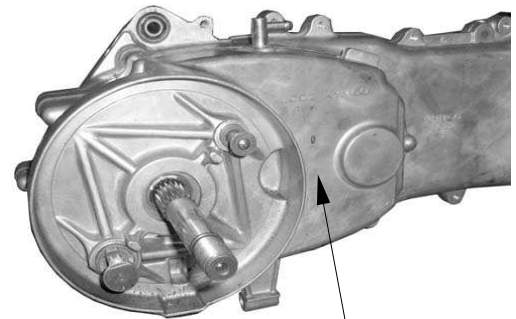

Transmission Case Cover Bolts

Install and tighten the transmission case cover bolts.  
Install the clutch/driven pulley. (⇒9-13)

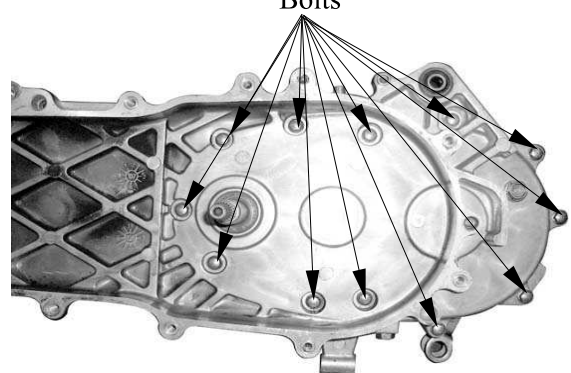

After installation, fill the transmission case with the specified oil. (⇒3-7)

- \*
- Place the motorcycle on its main stand on level ground.
  - Check the oil sealing washer for wear or damage.

**Specified Gear Oil:** SAE90#

**Oil Capacity:**

At disassembly : 0.2 liter

At change : 0.18 liter

Install and tighten the oil check bolt.

**Torque:** 0.8~1.2kgf-m

Start the engine and check for oil leaks.  
Check the oil level from the oil check bolt hole and add the specified oil to the proper level if the oil level is low.

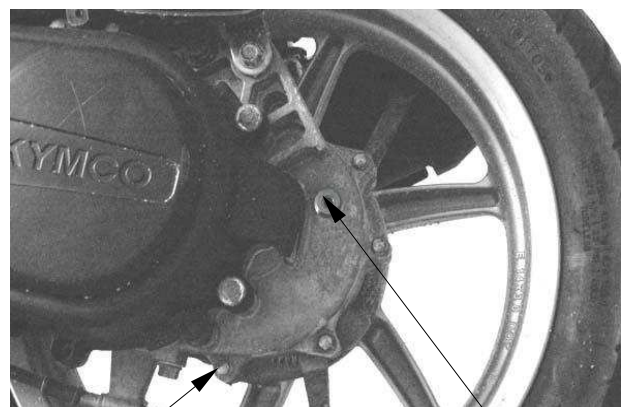

Drain Bolt

Oil Check Bolt Hole/Oil Filler

# 11. CRANKCASE/CRANKSHAFT

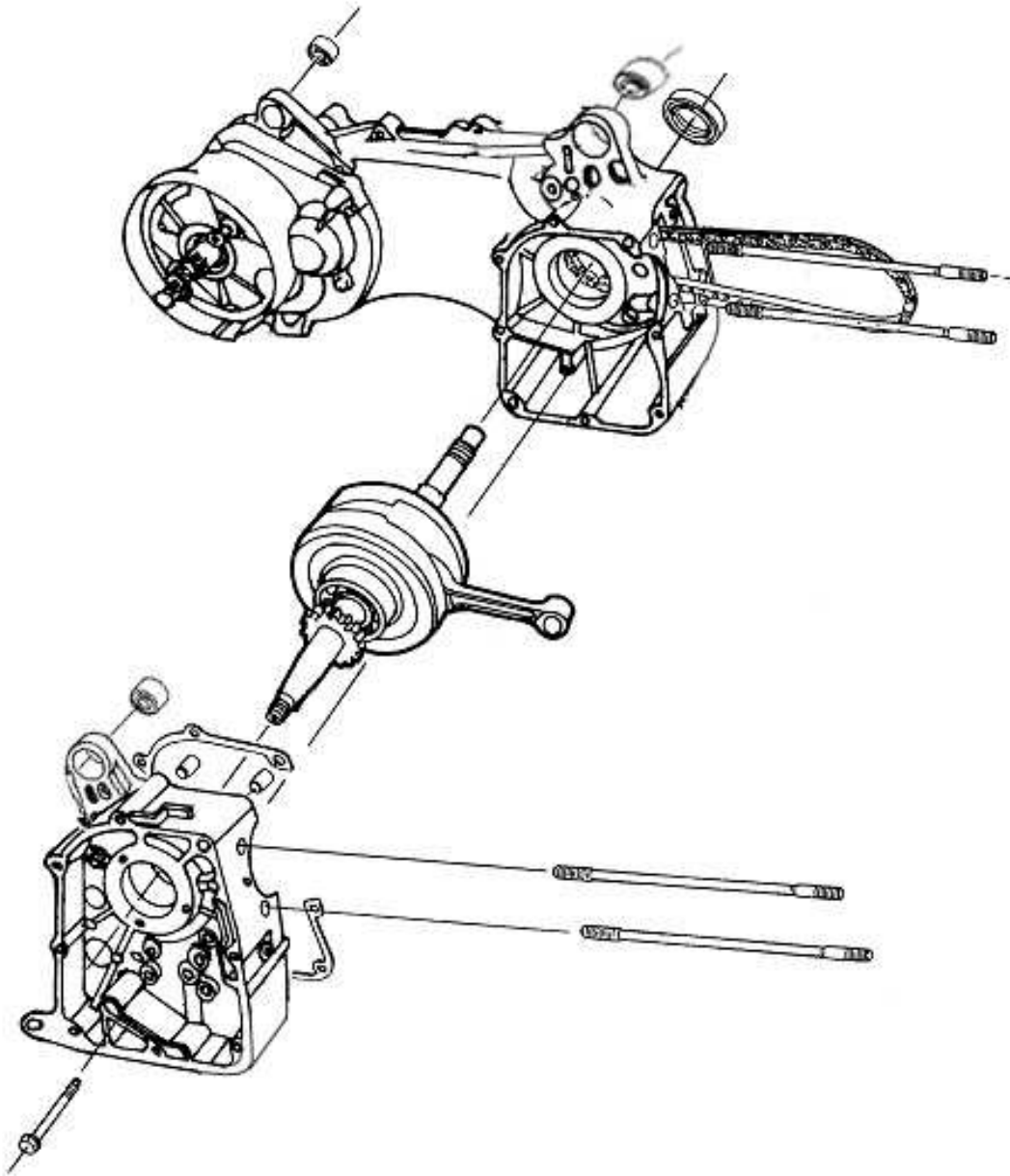

# 11. CRANKCASE/CRANKSHAFT

SERVICE INFORMATION.....	11-1	CRANKSHAFT.....	11-3
TROUBLESHOOTING .....	11-1	CRANKCASE ASSEMBLY.....	11-4
CRANKCASE SEPARATION .....	11-2		

## SERVICE INFORMATION

### GENERAL INSTRUCTIONS

- This section covers crankcase separation to service the crankshaft. The engine must be removed for this operation.
- The following parts must be removed before separating the crankcase.
  - Cylinder head (⇒Section 7)
  - Cylinder/piston (⇒Section 8)
  - Drive and driven pulleys (⇒Section 9)
  - A.C. generator (⇒Section 14)
  - Carburetor/air cleaner (⇒Section 5)
  - Rear wheel/rear shock absorber (⇒Section 13)
  - Starter motor (⇒Section 16)
  - Oil pump (⇒Section 4)

### SPECIFICATIONS

	Item	Standard (mm)	Service Limit (mm)
Crankshaft	Connecting rod big end side clearance	0.10~0.35	0.55
	Connecting rod big end radial clearance	0-0.008	0.05
	Runout	—	0.10

### TORQUE VALUES

Crankcase bolt	0.8~1.2kgf-m
Cam chain tensioner slipper bolt	0.8~1.2kgf-m

## TROUBLESHOOTING

### Excessive engine noise

- Excessive bearing play
- Excessive crankpin bearing play

# 11. CRANKCASE/CRANKSHAFT

## CRANKCASE SEPARATION

Remove the two crankcase attaching bolts.  
Separate the left and right crankcase halves.

\* Do not damage the crankcase gasket surface.

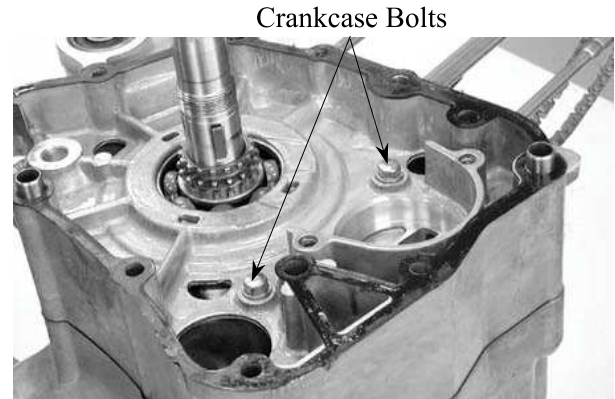

Remove the gasket and dowel pins.

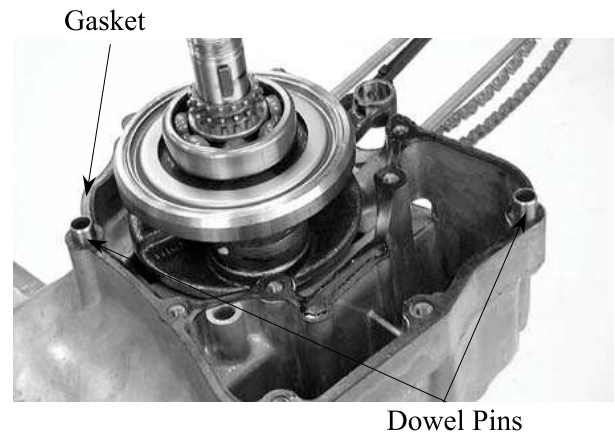

Remove the crankshaft and cam chain from the left crankcase.

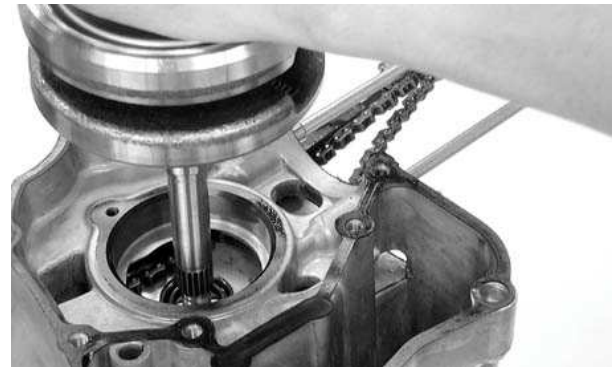

Clean off all gasket material from the crankcase mating surfaces.

\* Avoid damaging the crankcase mating surfaces.

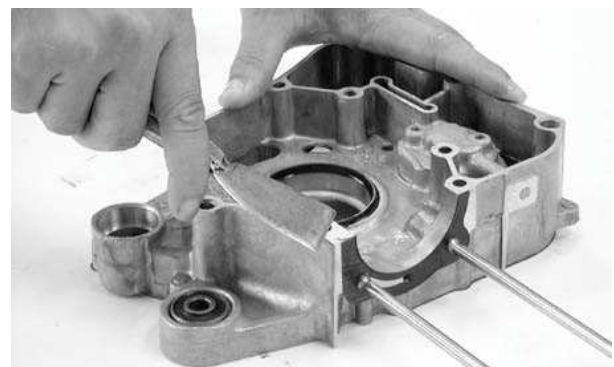

# 11. CRANKCASE/CRANKSHAFT

Remove the oil seal from the right crankcase.  
Check the oil seal lip for wear or deterioration.  
The installation sequence is the reverse of removal.

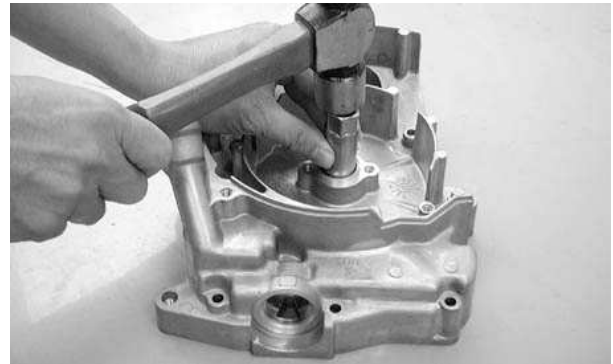

## CRANKSHAFT INSPECTION

Measure the connecting rod big end side clearance.

**Service Limit:** 0.55mm replace if over



Connecting Rod Big End

Measure the connecting rod big end radial clearance at two points at right angles to the shaft.

**Service Limit:** 0.05mm replace if over



Measuring Location

Measure the crankshaft runout.

**Service Limit:** 0.10mm replace if over

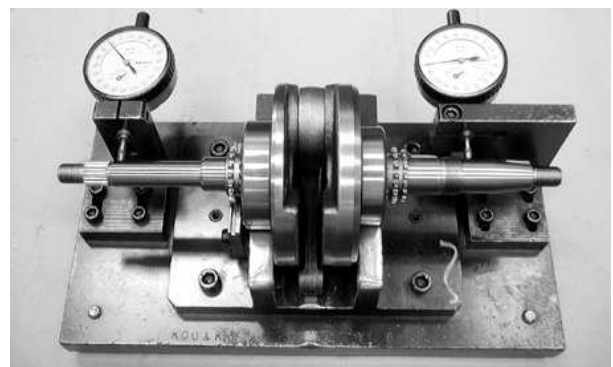

# 11. CRANKCASE/CRANKSHAFT

Turn the crankshaft bearings and check for excessive play.  
If they do not turn smoothly, quietly or if they fit loosely in the crankshaft, replace the crankshaft as a set.

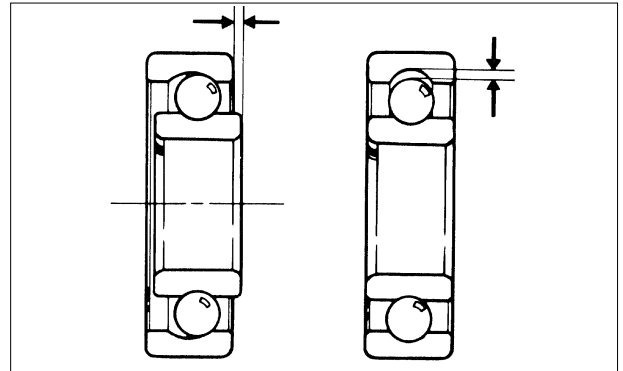

## CRANKCASE ASSEMBLY

Install the cam chain into the left crankcase.



Cam Chain

Install the crankshaft into the left crankcase.

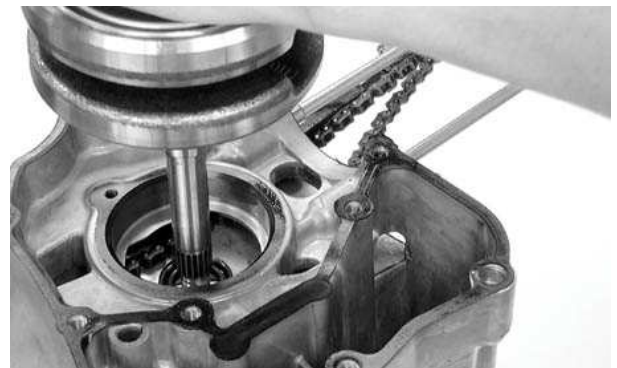

Install the dowel pins and a new gasket onto the left crankcase.

\*

Gasket



Dowel Pins



# 11. CRANKCASE/CRANKSHAFT

---

Tighten the two crankcase attaching bolts.

**Torque:** 0.9kg-m

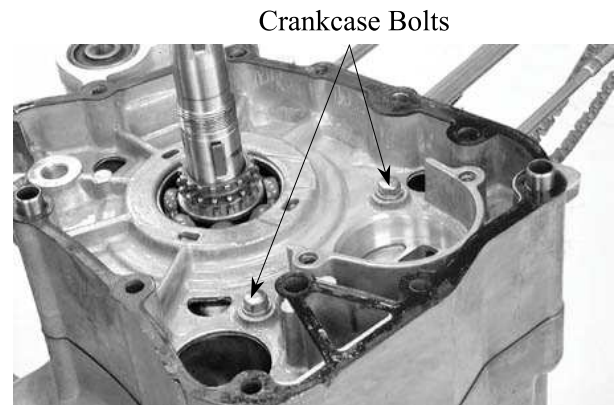

# 12. FRONT WHEEL/FRONT BRAKE/ FRONT SUSPENSION

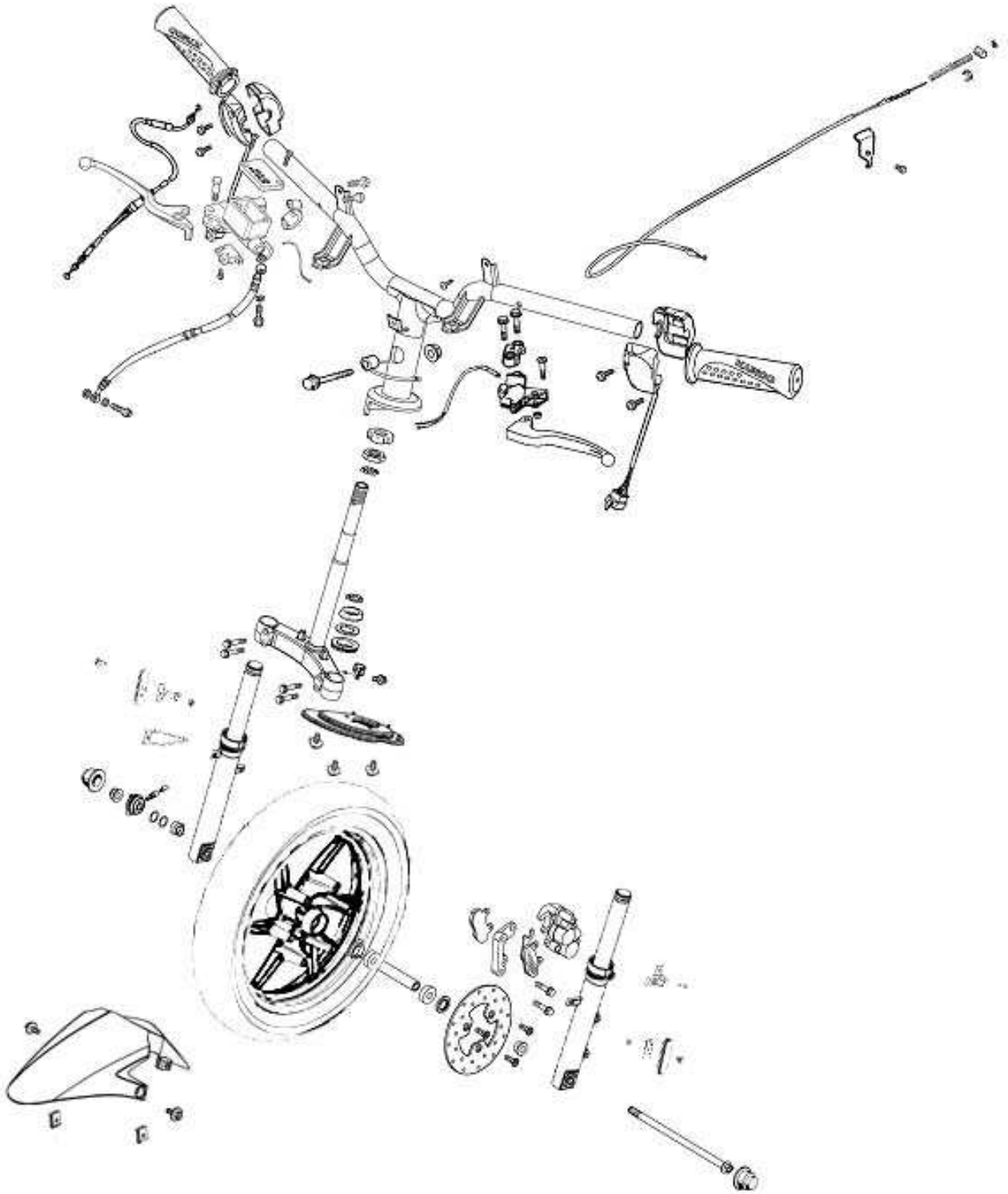

# 12. FRONT WHEEL/FRONT BRAKE/ FRONT SUSPENSION

SERVICE INFORMATION .....	12-1	FRONT SHOCK ABSORBER.....	12-18
TROUBLESHOOTING .....	12-2	FRONT FORK.....	12-21
STEERING HANDLEBAR.....	12-3		
FRONT WHEEL.....	12-4		

## SERVICE INFORMATION

### GENERAL INSTRUCTIONS

- Remove the motorcycle frame covers before removing the front wheel. Jack the motorcycle front wheel off the ground and be careful to prevent the motorcycle from falling down.
- During servicing, keep oil or grease off the brake drum and brake linings.

### SPECIFICATIONS

Item		Standard (mm)	Service Limit (mm)
Axle shaft runout		—	0.2
Front wheel rim runout	Radial	—	2.0
	Axial	—	2.0
Front shock absorber spring free length		230	226.5

### TORQUE VALUES

Handlebar bolt	4.5~5.5kgf-m
Steering stem lock nut	6.0~8.0kgf-m
Steering top cone race	0.5~1.3kgf-m
Front shock absorber bolt	3.0kgf-m
Front axle nut	5.0~7.0kgf-m
Brake arm bolt	0.8~1.2kgf-m

### SPECIAL TOOLS

Long socket wrench,32mm 8angle

### TROUBLESHOOTING

#### **Hard steering (heavy)**

- Excessively tightened steering stem top cone race
- Broken steering balls
- Insufficient tire pressure

#### **Steers to one side or does not track straight**

- Uneven front shock absorbers
- Bent front fork
- Bent front axle or uneven tire

#### **Front wheel wobbling**

- Bent rim
- Excessive wheel bearing play
- Bent spoke plate
- Faulty tire
- Improperly tightened axle nut

#### **Soft front shock absorber**

- Weak shock springs
- Insufficient damper oil

#### **Front shock absorber noise**

- Slider bending
- Loose fork fasteners
- Lack of lubrication

## 12. FRONT WHEEL/FRONT BRAKE/ FRONT SUSPENSION

### STEERING HANDLEBAR

#### REMOVAL

Remove the handlebar front and rear covers.  
(⇒2-2)  
Remove the two bolts attaching each of the  
front and rear brake levers.  
Remove the front and rear brake levers.



Bolts

Bolts

Screws

Throttle Pipe

Remove the two throttle holder screws and  
throttle holder.  
Disconnect the throttle cable from the throttle  
pipe and then remove the throttle pipe from  
the handlebar.

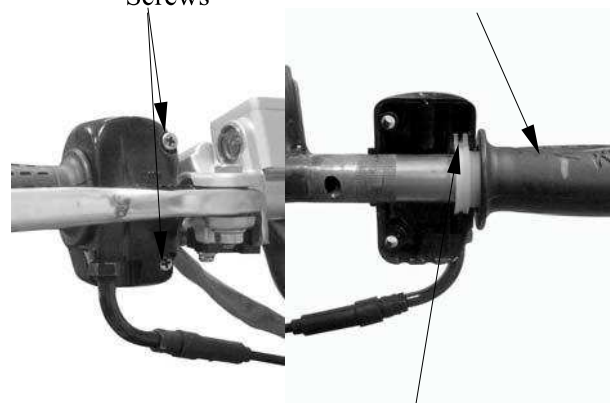

Throttle Cable

Remove the handlebar lock nut and bolt to  
remove the handlebar.



Nut

Bolt

Bolt Orifice

#### INSTALLATION

Install the handlebar onto the steering stem  
by aligning the tab on the handlebar with the  
bolt orifice on the steering stem.  
Install and tighten the handlebar bolt and lock  
nut.

**Torque:** 4.5~5.5kgf-m



## 12. FRONT WHEEL/FRONT BRAKE/ FRONT SUSPENSION

Apply grease to the tip of the throttle pipe.  
Install the throttle pipe and connect the  
throttle cable.



Install the front and rear brake levers in the  
reverse order of removal.

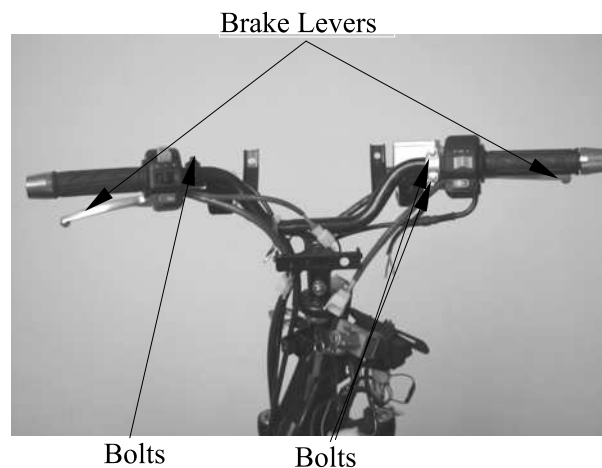

### FRONT WHEEL

#### REMOVAL

Jack the motorcycle front wheel off the  
ground.  
Remove the speedometer cable set screw and  
disconnect the speedometer cable.  
Remove the front axle nut and pull out the  
axle.  
Remove the front wheel.  
Remove the and speedometer gear box and  
side collar.

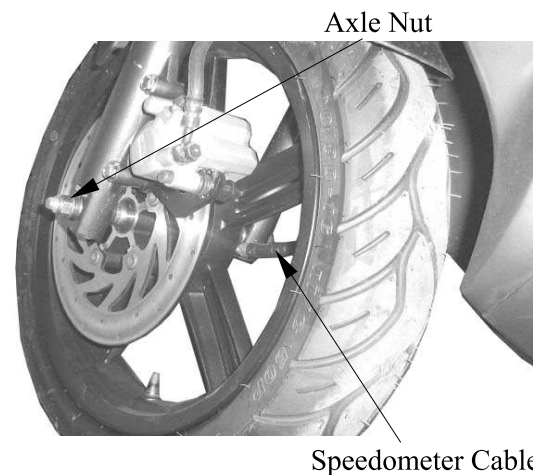

#### INSPECTION

##### AXLE RUNOUT

Set the axle in V blocks and measure the  
runout using a dial gauge.  
The actual runout is  $\frac{1}{2}$  of the total indicator  
reading.

**Service Limit:** 0.2mm replace if over

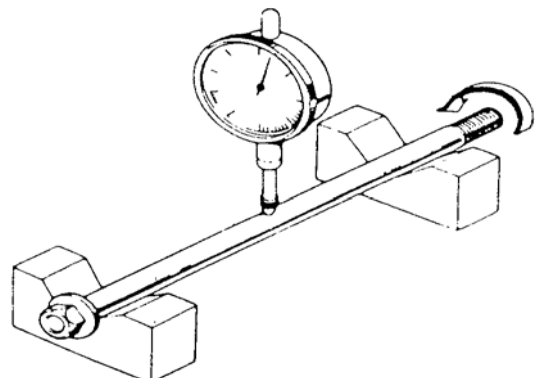

## 12. FRONT WHEEL/FRONT BRAKE/ FRONT SUSPENSION

### WHEEL RIM

Check the wheel rim runout.

#### Service Limits:

**Radial:** 2.0mm replace if over

**Axial:** 2.0mm replace if over

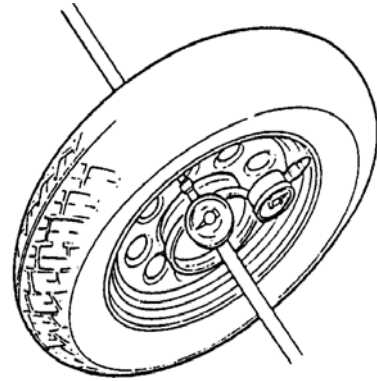

Turn the wheel bearings and replace the bearings if they are noisy or have excessive play.

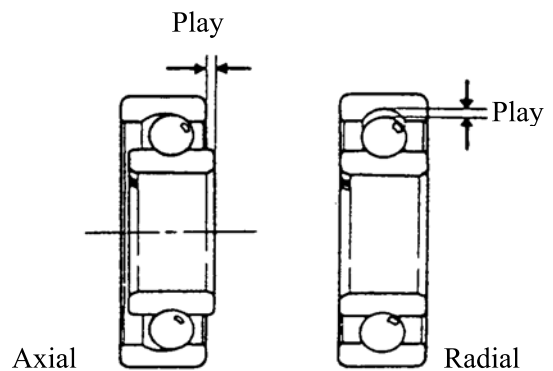

### DISASSEMBLY

Remove the dust seal.



## 12. FRONT WHEEL/FRONT BRAKE/ FRONT SUSPENSION

Remove the front wheel bearings and distance collar.

Special

Bearing Puller

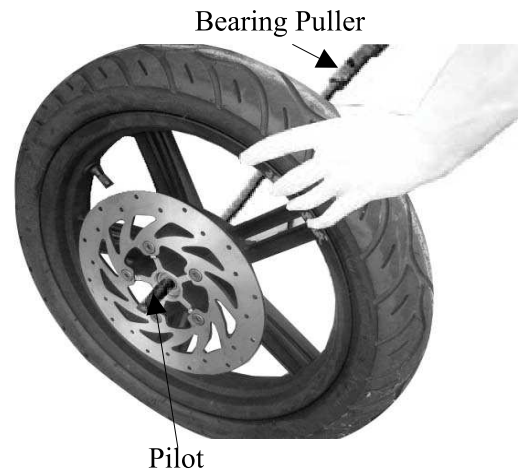

### ASSEMBLY

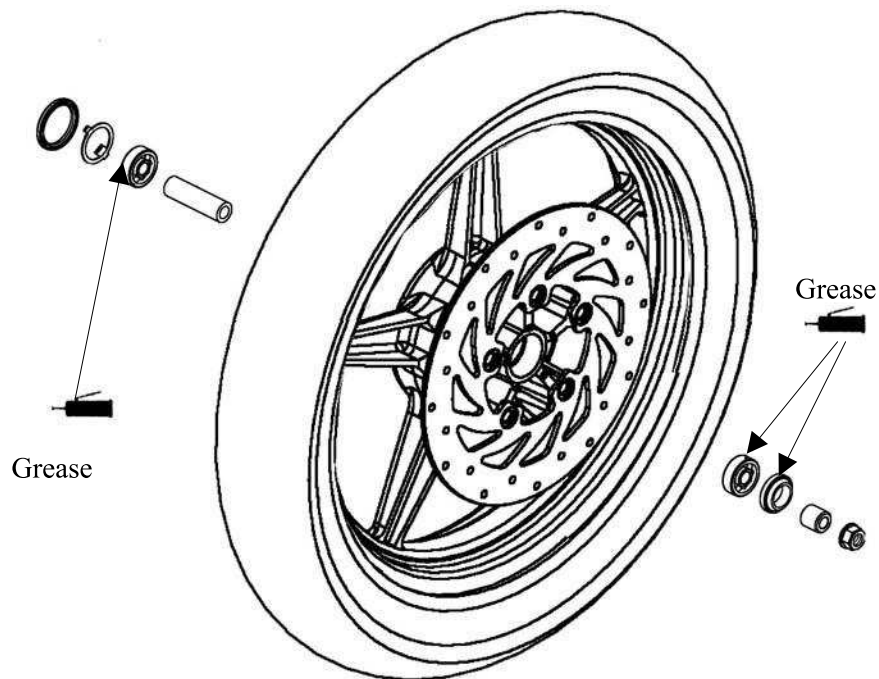

Pack all bearing cavities with grease.  
Drive in the left bearing.  
Install the distance collar.  
Drive in the right bearing.

\* Drive in the bearing squarely with the sealed end facing out.





## 12. FRONT WHEEL/FRONT BRAKE/ FRONT SUSPENSION

**KYMCO**  
AGILITY CITY 125/150

Apply grease to a new dust seal lip and install the dust seal.  
Install the side collar.

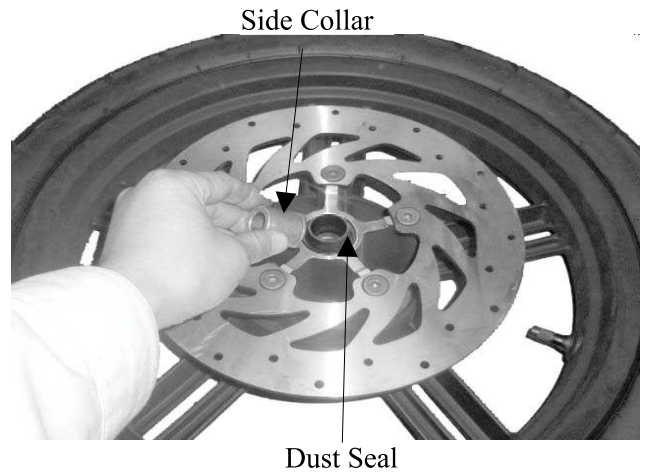

## 12. FRONT WHEEL/FRONT BRAKE/ FRONT SUSPENSION

### HYDRAULIC BRAKE (FRONT BRAKE)

#### Brake Fluid Replacement/Air Bleeding

Check the brake fluid level on level ground.

\*

- When operating the brake lever, the brake reservoir cap must be tightened securely to avoid spill of brake fluid.
- When servicing the brake system, use shop towels to cover plastic parts and coated surfaces to avoid damage caused by spill of brake fluid.

Upper Limit



Lower Limit

### Brake Fluid Bleeding

In order to avoid spill of brake fluid, connect a transparent hose to the bleed valve.

#### Warning

Brake fluid spilled on brake pads or brake disk will reduce the braking effect. Clean the brake pads and brake disk with a high quality brake degreaser.

Fully apply the brake lever and then loosen the brake caliper bleed valve to drain the brake fluid until there is no air bubbles in the brake fluid. Then, tighten the bleed valve. Repeat these steps until the brake system is free of air.

Bleed Valve

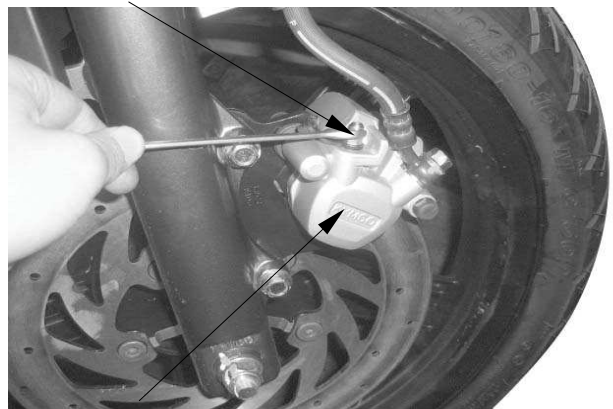

Front Brake Caliper

### Brake Fluid Refilling

Add DOT-4 brake fluid to the brake reservoir.

\*

- When bleeding, be careful not to allow air in the brake reservoir flowing into the brake system.
- When using a brake bleeder, follow the manufacturer's instructions.
- Never use dirty or unspecified brake fluid or mix different brake fluids because it will damage the brake system.

Make sure to bleed air from the brake system.

## 12. FRONT WHEEL/FRONT BRAKE/ FRONT SUSPENSION

### Brake Pad/Disk Replacement

- \* The brake pads must be replaced as a set to ensure the balance of the brake disk.

Remove the two bolts attaching the brake caliper.  
Remove the brake caliper.  
Downpress reed and remove the brake pads.  
Install the brake pads in the reverse order of removal.

- \*
  - Keep grease or oil off the brake pads to avoid brake failure.

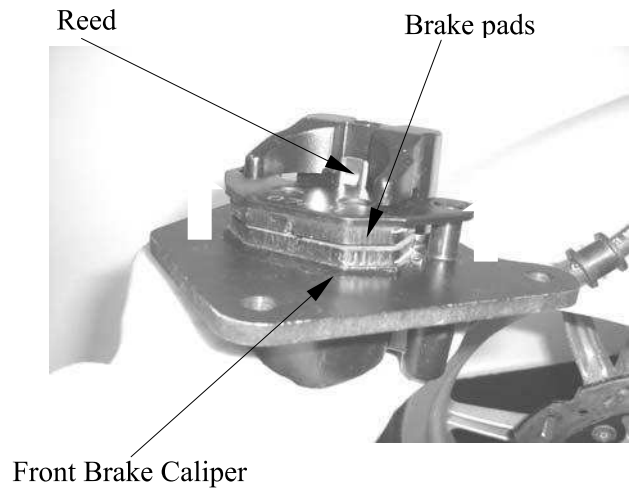

### Brake Disk

Measure the brake disk thickness.

**Service Limit:** 3.0mm

Measure the brake disk runout.

**Service Limit:** 0.3mm



## 12. FRONT WHEEL/FRONT BRAKE/ FRONT SUSPENSION

### BRAKE MASTER CYLINDER

#### Removal

First drain the brake fluid from the hydraulic brake system.

\*

- When servicing the brake system, use shop towels to cover rubber and plastic parts and coated surfaces to avoid being contaminated by brake fluid.
- When removing the brake fluid pipe bolt, be sure to plug the pipe to avoid

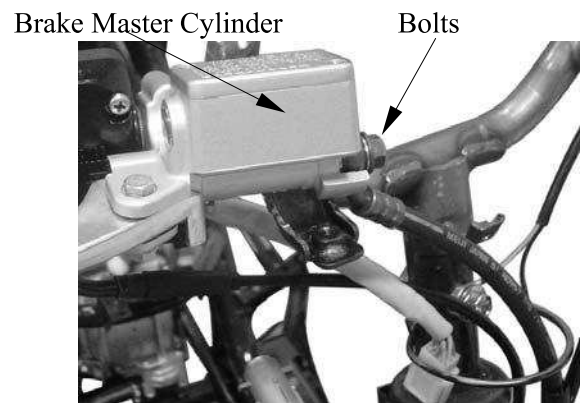

#### Disassembly

Remove the piston rubber cover and snap ring from the brake master cylinder.

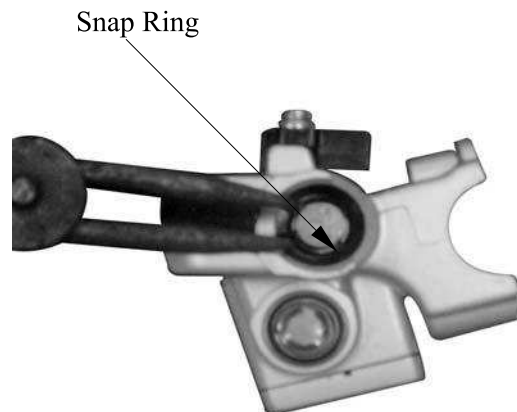

Remove the washer, main piston and spring from the brake master cylinder.  
Clean the inside of the master cylinder and brake reservoir with brake fluid.

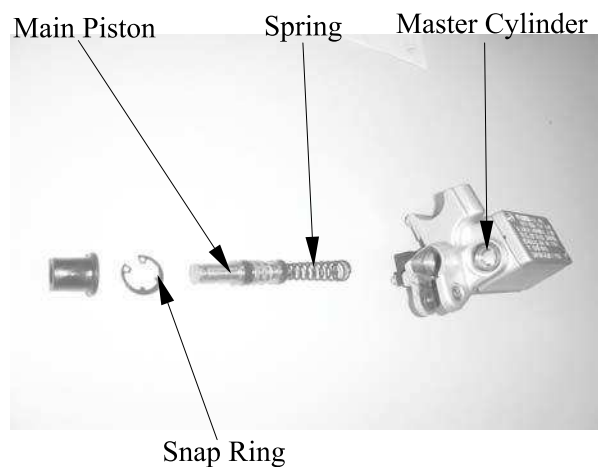

## 12. FRONT WHEEL/FRONT BRAKE/ FRONT SUSPENSION

### Inspection

Measure the brake master cylinder I.D.

**Service Limit:** 12.75mm

Inspect the master cylinder for scratch or crack.

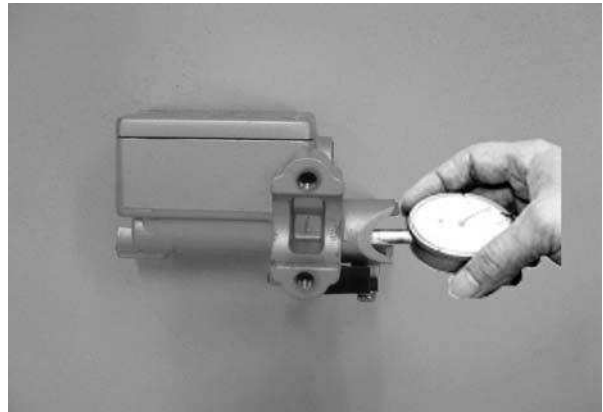

Measure the brake master cylinder piston O.D.

**Service Limit:** 12.6mm

Before assembly, inspect the 1st and 2nd rubber cups for wear.



### Assembly

Before assembly, apply brake fluid to all removed parts.

Install the spring together with the 1st rubber cup.

\*

- During assembly, the main piston and spring must be installed as a unit without exchange.
- When assembling the piston, soak the cups in brake fluid for a while.
- Install the cups with the cup lips facing the correct direction.



Install the main piston, spring and snap ring.

Install the rubber cover.

Install the brake lever.

## 12. FRONT WHEEL/FRONT BRAKE/ FRONT SUSPENSION

### Disassembly

Remove the brake caliper seat from the brake caliper.

Brake Caliper Seat

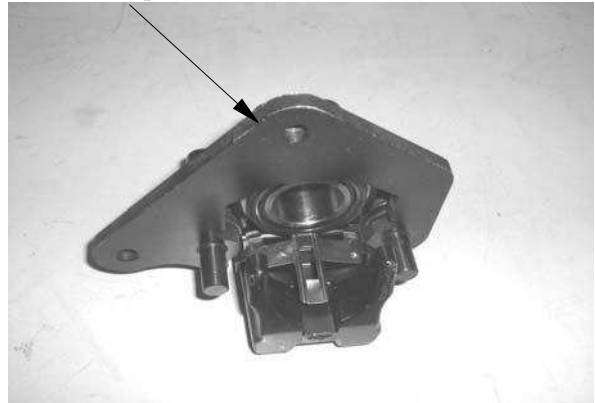

Remove the piston from the brake caliper. If necessary, use compressed air to squeeze out the piston through the brake fluid inlet opening and place a shop towel under the caliper to avoid contamination caused by the removed piston. Check the piston cylinder for scratch or wear and replace if necessary.

Compressed Air



Push the piston oil seal outward to remove it. Clean the oil seal groove with brake fluid.

\* Be careful not to damage the piston surface.

Piston Oil Seal



## 12. FRONT WHEEL/FRONT BRAKE/ FRONT SUSPENSION

Place the brake master cylinder on the handlebar and install the holder with “up” mark facing up. Be sure to align the punch mark with the holder joint. First tighten the upper bolt and then tighten the lower bolt.

**Torque:** 3.0~4.0kgf-m

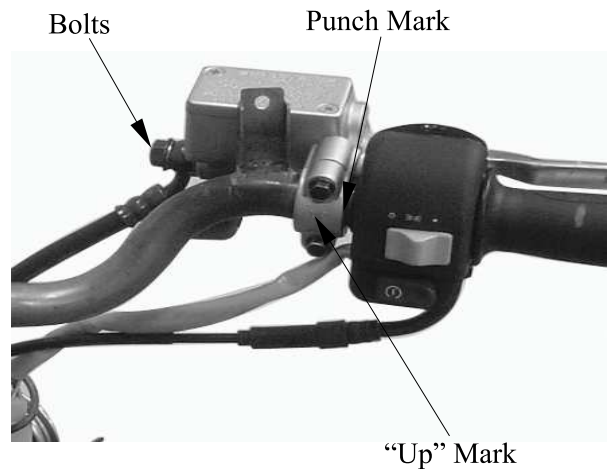

Install the brake fluid pipe with the attaching bolt and two sealing washers.

Install the handlebar covers. (⇒12-3)  
Fill the brake reservoir with recommended brake fluid to the upper limit and bleed air according to the method stated in 12-10.

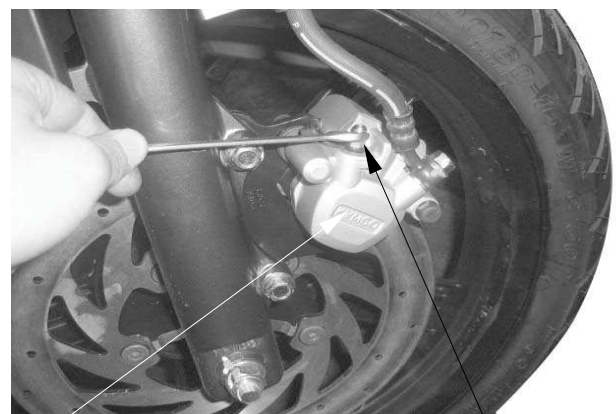

Brake Caliper

Bleed Valve

### **BRAKE CALIPER (FRONT)**

#### **Removal**

Remove the brake caliper.  
Place a clean container under the brake caliper and disconnect the brake fluid pipe from the caliper.

\* Do not spill brake fluid on any coated surfaces.

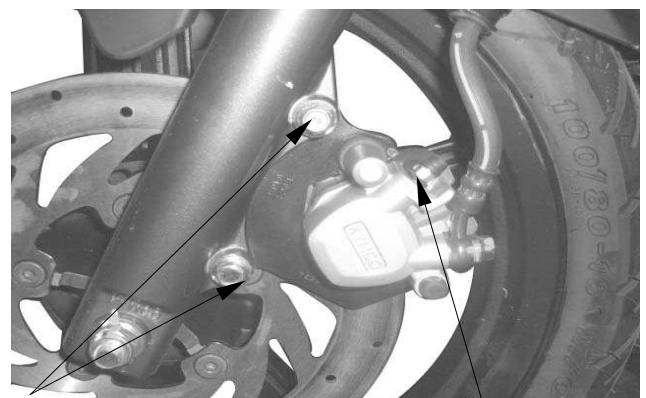

Bolt

Bleed Valve

## 12. FRONT WHEEL/FRONT BRAKE/ FRONT SUSPENSION

Check the piston for scratch or wear.  
Measure the piston O.D. with a micrometer.  
**Service Limit:** 34mm



Check the caliper cylinder for scratch or wear  
and measure the cylinder bore.  
**Service Limit:** 34.5mm



### Assembly

Clean all removed parts.  
Apply silicon grease to the piston and oil seal.  
Lubricate the brake caliper cylinder inside  
wall with brake fluid.  
Install the brake caliper piston with grooved  
side facing out.

\*

Install the piston with its outer end 3~  
5mm protruding beyond the brake  
caliper.

Wipe off excessive brake fluid with a clean  
shop towel. Apply silicon grease to the  
brake caliper seat pin and caliper inside.  
Install the brake caliper seat.





## 12. FRONT WHEEL/FRONT BRAKE/ FRONT SUSPENSION

### Installation

Install the brake caliper and tighten the two bolts.

**Torque:** 2.9~3.5kg-m

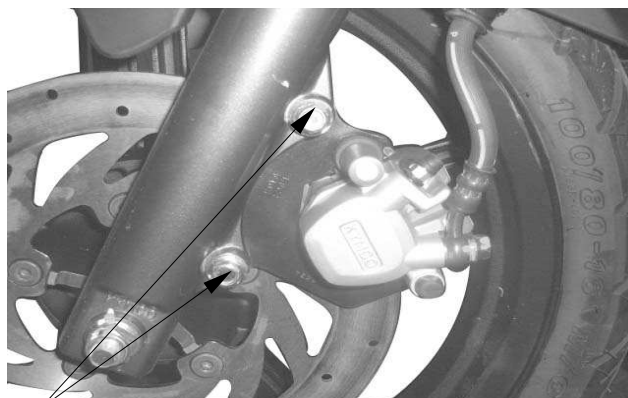

Bolts

Connect the brake fluid pipe to the brake caliper and tighten the fluid pipe bolt.

**Torque:** 2.5~3.5kg-m

Fill the brake reservoir with recommended brake fluid and bleed air from the brake system. (⇒12-10)



Bolt

## 12. FRONT WHEEL/FRONT BRAKE/ FRONT SUSPENSION

### FRONT SHOCK ABSORBER

#### REMOVAL

Remove the front wheel. (⇒12-4)  
Remove the front lower cover. (⇒2-2)  
Remove the front inner fender.  
Remove the front shock absorber upper mount bolts.  
Loosen the lower mount bolts to remove the front shock absorbers.

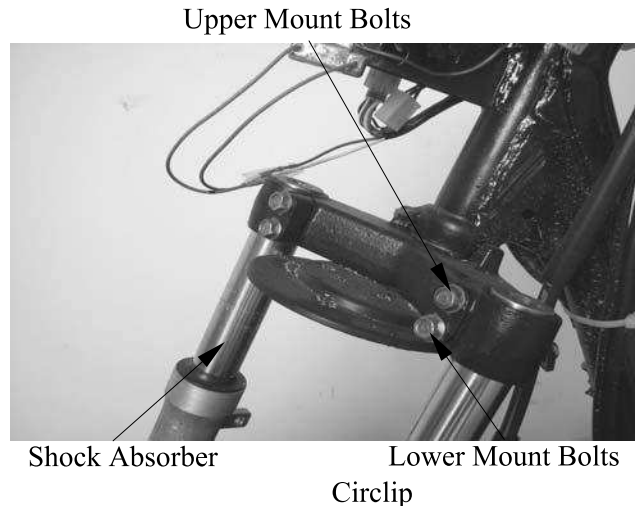

#### DISASSEMBLY

Remove the dust boot.  
Remove the circlip.

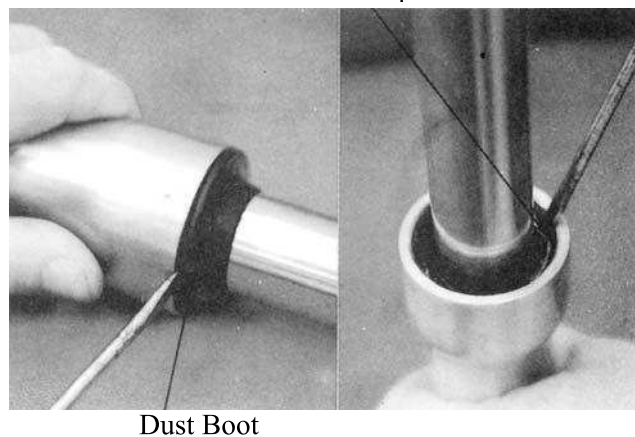

Set the front shock absorber in a vise.  
Remove the damper rod, hex bolt and copper washer.  
Pull out the front shock absorber tube.

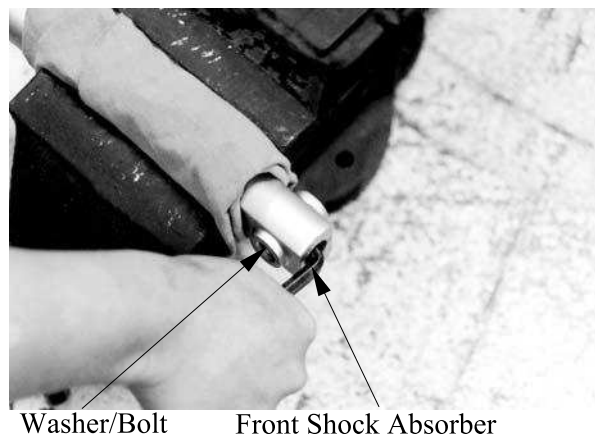

Set the front shock absorber tube in a vise.  
Remove the top nut, shock spring, damper, and damper spring from the front shock absorber tube.

- \*
  - When holding the shock absorber tube, place a shop towel to protect it and do not apply too much force.

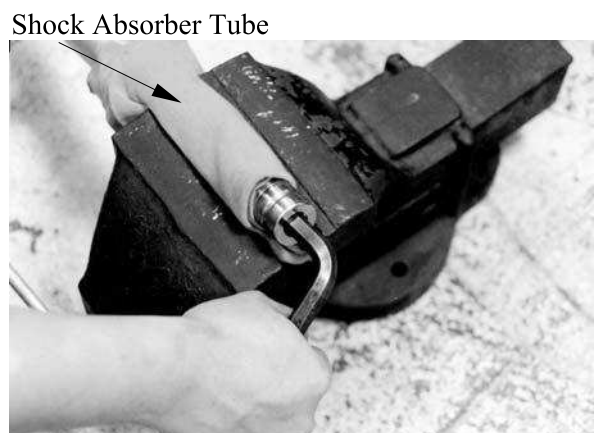

# 12. FRONT WHEEL/FRONT BRAKE/ FRONT SUSPENSION

Measure the front shock absorber spring free length.

**Service Limits:** Right : 226.5mm  
Left : 226.5mm

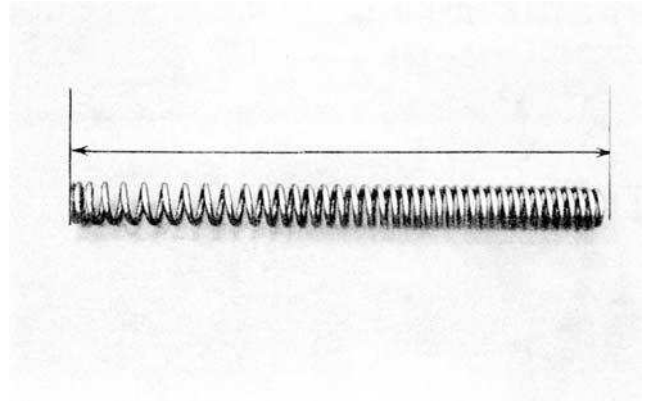

## ASSEMBLY

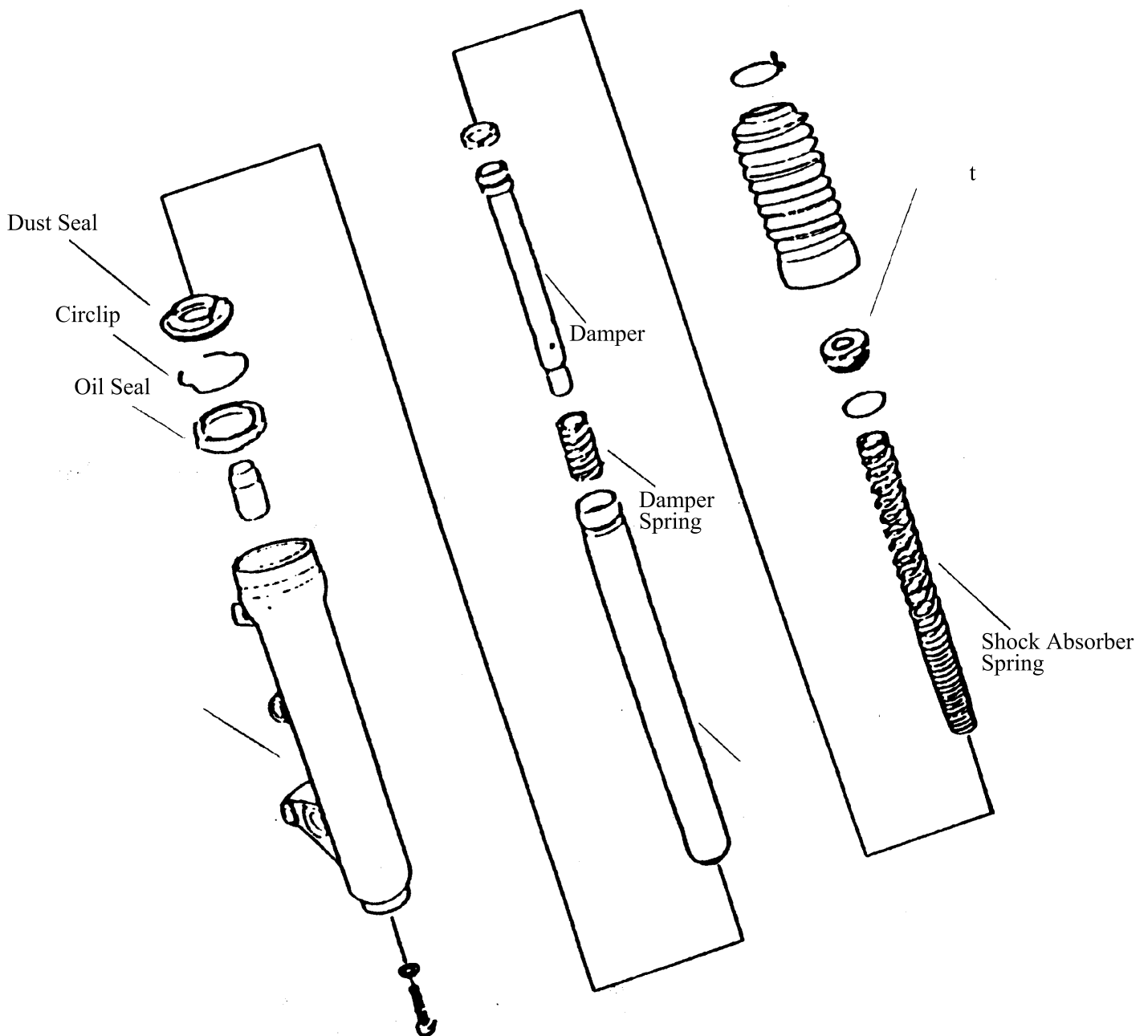

## 12. FRONT WHEEL/FRONT BRAKE/ FRONT SUSPENSION

Install the damper spring onto the damper rod and then install them into the front shock absorber tube.

Install the shock absorber spring onto the front shock absorber tube and tighten the top nut.

\* Install the front shock absorber spring with the closely wound coils facing down.



Shock Absorber Tube  
Circlip

Set the front shock absorber in a vise. Insert the shock absorber tube into the shock absorber and tighten the hex bolt. (Apply locking agent to the washer and install it together with the hex bolt.)

**Torque:** 3.0kgf-m

Add engine oil into the front shock absorber.

**Specified Oil:** SS#8

**Oil Capacity:** 97±1cc

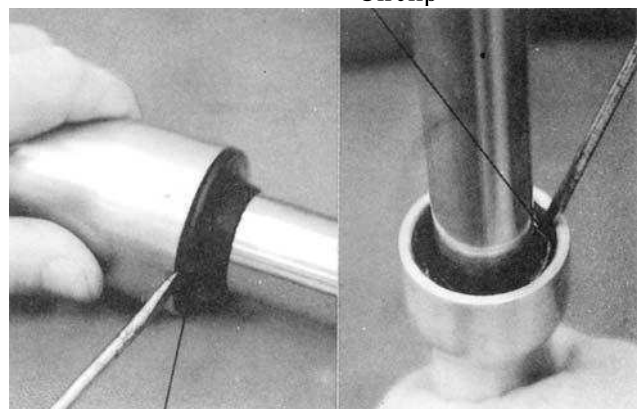

Dust Boot

Install the circlip.  
Install the dust boot.

Upper Mount Bolts



Front Shock Absorber

Lower Mount Bolts

### INSTALLATION

Install the front shock absorbers onto the steering stem.

Install and tighten the front shock absorber upper mount bolts.

Tighten the lower mount bolts.

\* Align the upper mount bolt hole with the groove on the front fork.

Install the front wheel. (⇒12-7)

# 12. FRONT WHEEL/FRONT BRAKE/ FRONT SUSPENSION

## FRONT FORK

### REMOVAL

Remove the steering handlebar. (⇒12-3)  
Remove the front wheel. (⇒12-4)  
Disconnect the speedometer cable.  
Remove the steering stem lock nut using long socket wrench.

Special

Long Socket Wrench, 32mm 8Angle

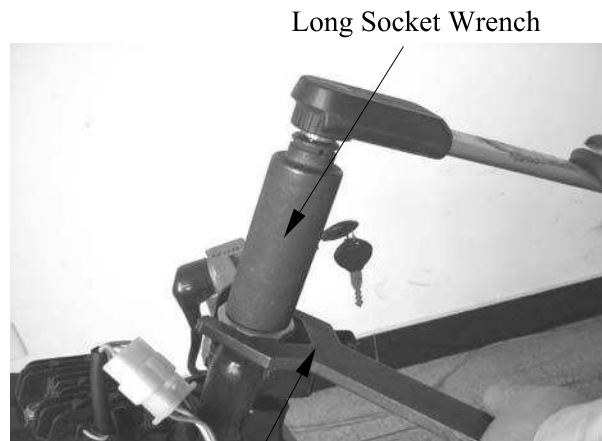

Lock Nut Wrench

Remove the top cone race and remove the steering stem.

- \* Be careful not to lose the steel balls (26 on top race and 29 on bottom race).

Inspect the ball races and cone races for wear or damage and replace if necessary.

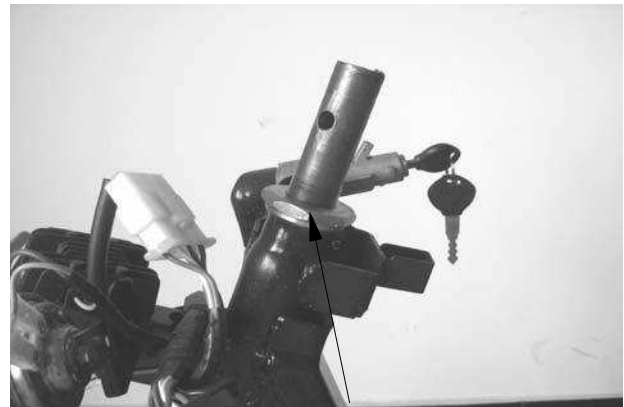

Top Cone Race

### BOTTOM CONE RACE REPLACEMENT

Remove the bottom cone race using a chisel.

- \* Be careful not to damage the steering stem and front fork.

Drive a new bottom cone race into place with a proper driver.

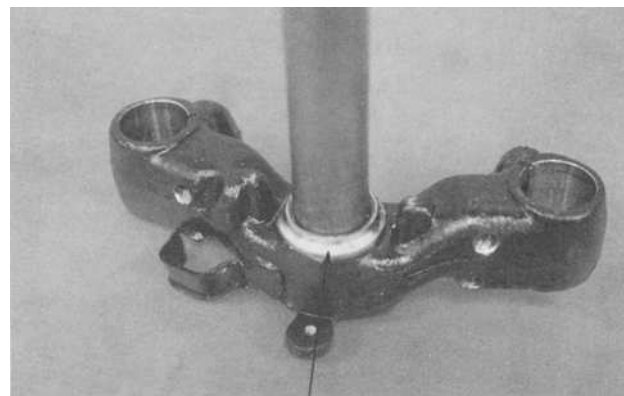

Bottom Cone Race

Ball Race Remover

### BALL RACE REPLACEMENT

Drive out the top and bottom ball races.



## 12. FRONT WHEEL/FRONT BRAKE/ FRONT SUSPENSION

Drive new top and bottom ball races into the steering head using the outer driver.

- \* Be sure to completely drive in the ball races.



Outer Driver, 37x40mm

### INSTALLATION

Apply grease to the top and bottom ball races and install 26 steel balls on the top ball race and 29 steel balls on the bottom ball race. Apply grease to the ball races and install the front fork.



Steel Balls

Apply grease to the top cone race and install it.

Tighten the top cone race and then turn the steering stem right and left several times to make steel balls contact each other closely.

- \* Check that the steering stem rotates freely without vertical play.

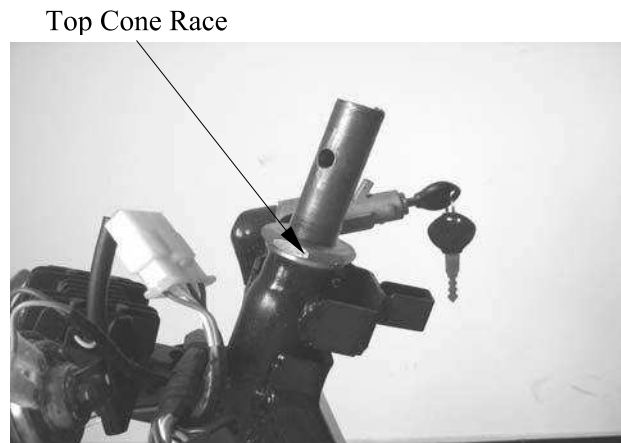

Top Cone Race

Install the steering stem lock nut and tighten it while holding the top cone race.

**Torque:** 6.0~8.0kgf-m

Install the front wheel. (⇒12-7)

Install the steering handlebar. (⇒12-3)

Install the speedometer cable. (⇒12-7)

**Special**

Long Socket Wrench, 32mm×8Angle

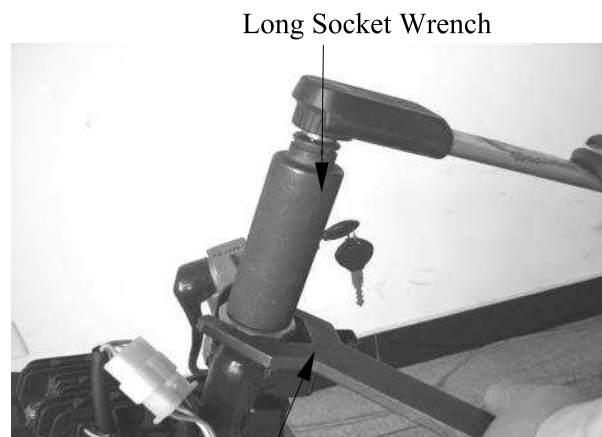

Long Socket Wrench

Lock Nut Wrench

# 13. REAR WHEEL/REAR BRAKE/ REAR SUSPENSION

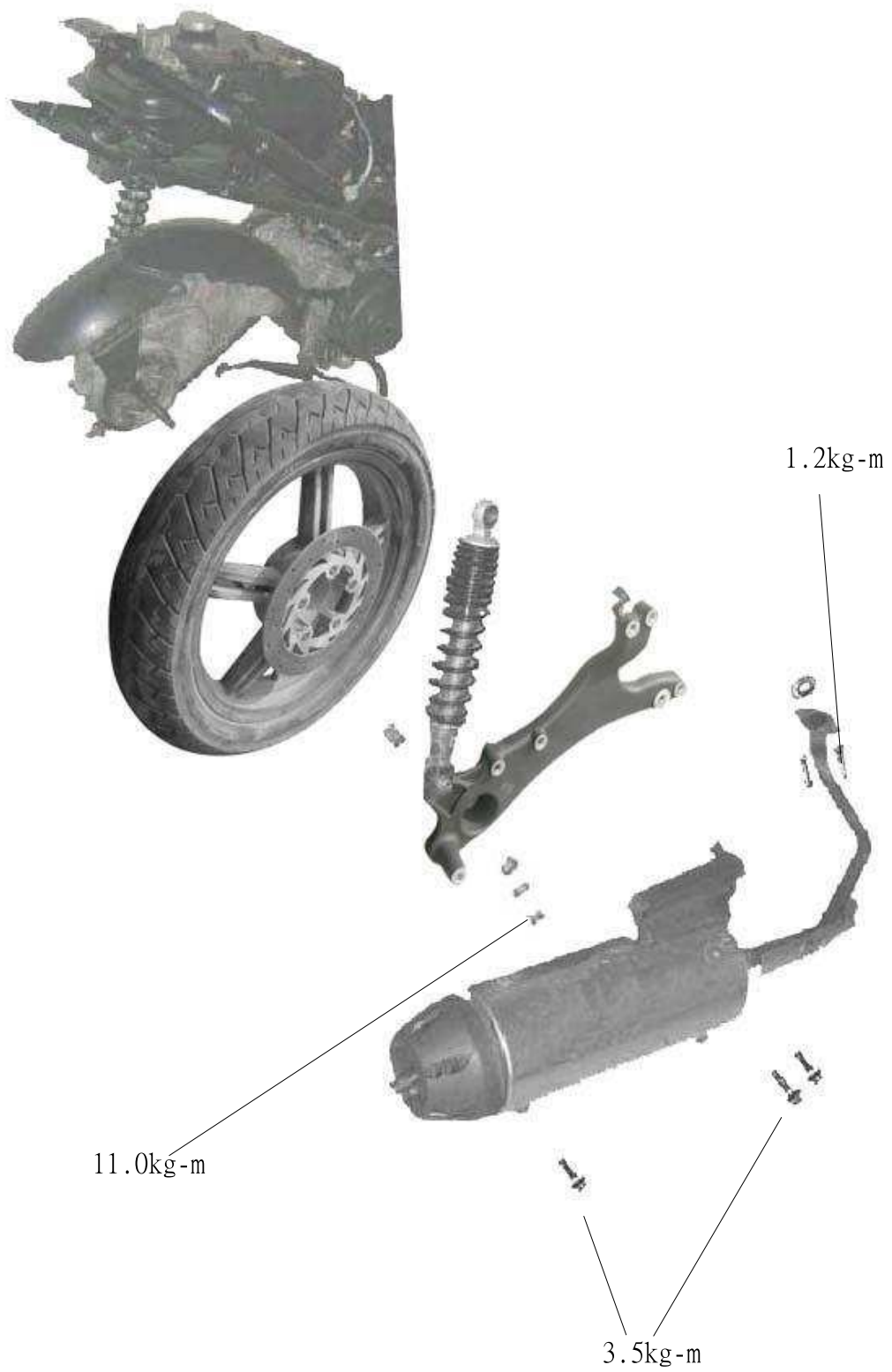

**13**

# 13. REAR WHEEL/REAR BRAKE/ REAR SUSPENSION

SERVICE INFORMATION .....	13-1	REAR BRAKE.....	13-3
TROUBLESHOOTING.....	13-1	REAR SHOCK ABSORBER.....	13-4
REAR WHEEL .....	13-2		

## SERVICE INFORMATION

### GENERAL INSTRUCTIONS

- During servicing, keep oil or grease off the brake drum and brake linings.

### SPECIFICATIONS

Item		Standard (mm)	Service Limit (mm)
Rear wheel	Rim runout	Radial	—
		Axial	—
	Rear brake drum I.D		131
Rear brake lining thickness		4.0	2.0
Rear shock absorber spring free length		225	210

### TORQUE VALUES

Rear axle nut	11~13kgf-m
Rear shock absorber upper mount bolt	3.5~4.5kgf-m
Rear shock absorber lower mount bolt	2.4~3.0kgf-m
Exhaust muffler joint lock nut	1.0~1.4kgf-m
Exhaust muffler lock bolt	3.0~3.6kgf-m

### Special Tool

Cushion Assemble & Disassemble Tool

## TROUBLESHOOTING

### Rear wheel wobbling

- Bent rim
- Faulty tire
- Axle not tightened properly

### Soft rear shock absorber

- Weak shock absorber spring
- Faulty damper

### Poor brake performance

- Brake not adjusted properly
- Worn brake linings
- Worn brake shoes at cam contacting area
- Worn brake cam
- Worn brake drum



# 13. REAR WHEEL/REAR BRAKE/ REAR SUSPENSION

## REAR WHEEL

### REMOVAL

- Remove the exhaust muffler. (⇒2-5)
- Remove the rear axle nut and rear shock absorber bolt.
- Remove the rear axle side collar and rear fork.
- Remove the rear wheel.

Rear Shock Absorber Bolt

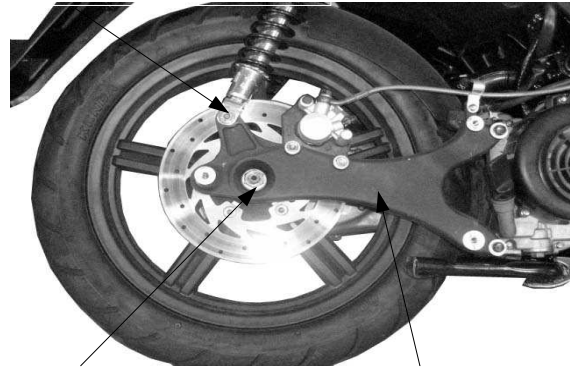

Rear Axle Nut

Rear Fork

### INSPECTION

Measure the rear wheel rim runout.

#### Service Limits:

**Radial:** 2.0mm replace if over

**Axial:** 2.0mm replace if over

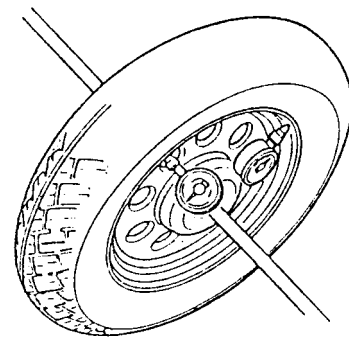

- Inspect the rear brake drum.
- Measure the rear brake drum I.D.
- Service Limits:** 130mm replace if over



### INSTALLATION

- Install the rear wheel in the reverse order of removal.
- Tighten the rear axle nut.
- Torque:** 11.0-13.0kg-m
- Install the exhaust muffler.
- Torque:**
  - Exhaust muffler joint lock nut: 1.0~1.4kgf-m
  - Exhaust muffler lock bolt: 3.0~3.6kgf-m

\* First install and tighten the exhaust muffler joint lock nuts and then the exhaust muffler lock bolts.

Lock Bolts

Joint Lock Nuts

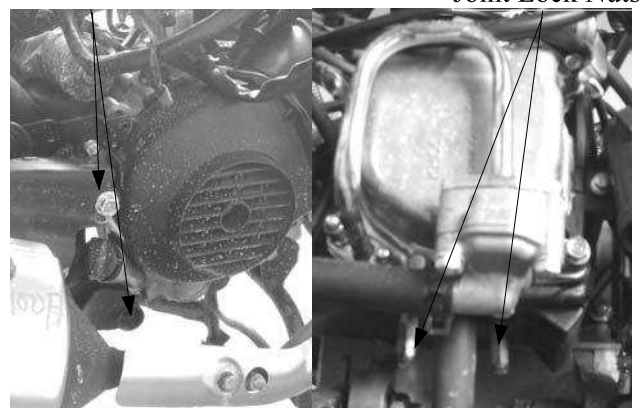

# 13. REAR WHEEL/REAR BRAKE/ REAR SUSPENSION

## REAR BRAKE

### BRAKE LINING INSPECTION

Measure the brake lining thickness.

**Service Limit:** 2.0mm replace if below

\* Keep oil or grease off the brake linings.



### REAR BRAKE DISASSEMBLY

Remove the rear brake adjusting nut and disconnect the rear brake cable.

Remove the rear brake shoes.

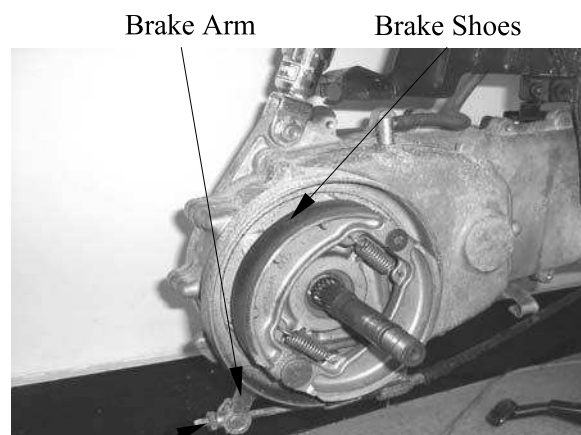

Adjusting Nut  
Brake Arm Bolt

Remove the brake arm bolt to remove the brake arm.  
Remove the brake cam.

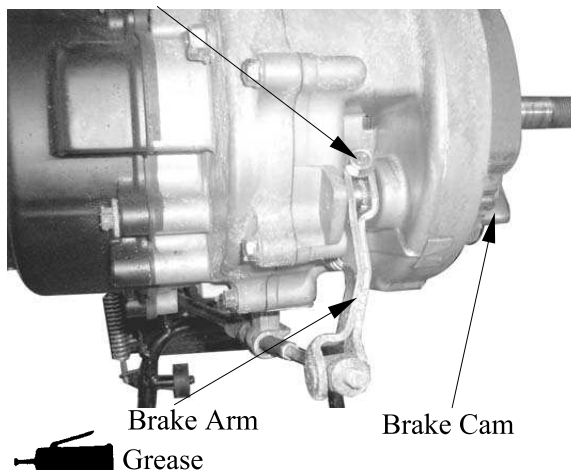

### REAR BRAKE ASSEMBLY

Apply grease to the anchor pin.

Apply grease to the brake cam and install it.

Install the brake shoes.

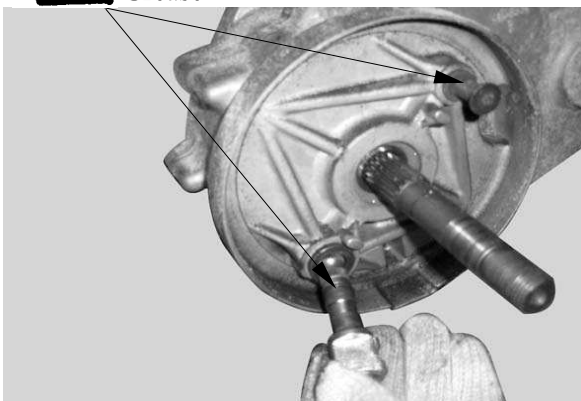

# 13. REAR WHEEL/REAR BRAKE/ REAR SUSPENSION

Apply a small amount of engine oil to the felt seal and install it to the brake cam.  
Install the brake arm.

\* Align the wide groove on the wear indicator plate with the wide tooth of the brake cam.

Install and tighten the brake arm bolt.

\* Align the scribed line on the brake arm with the punch mark on the brake cam.

Install the brake arm return spring.  
Install the brake arm pin.  
Connect the brake cable and install the adjusting nut.  
Install the rear wheel. (⇒13-2)  
Adjust the rear brake lever free play. (⇒3-8)

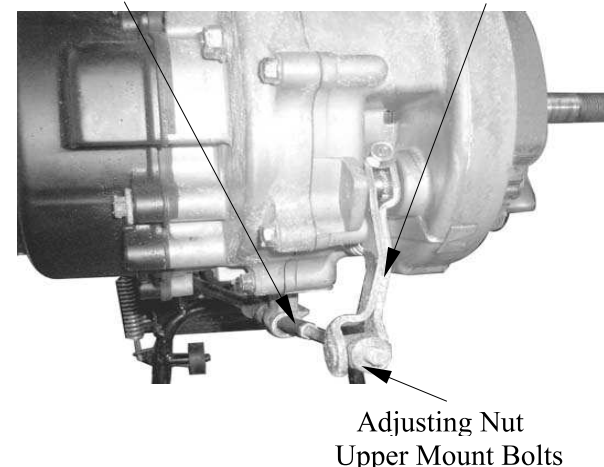
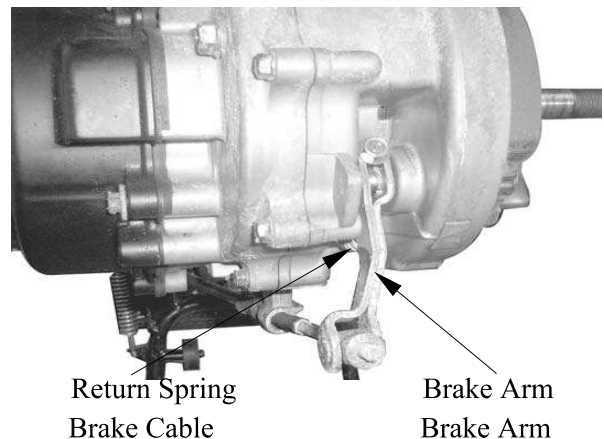

## LEFT REAR SHOCK ABSORBER REMOVAL

Remove the frame body cover. (⇒2-3)  
Remove the air cleaner case. (⇒5-19)

Remove the rear shock absorber upper and lower mount bolts.  
Remove the rear shock absorber.

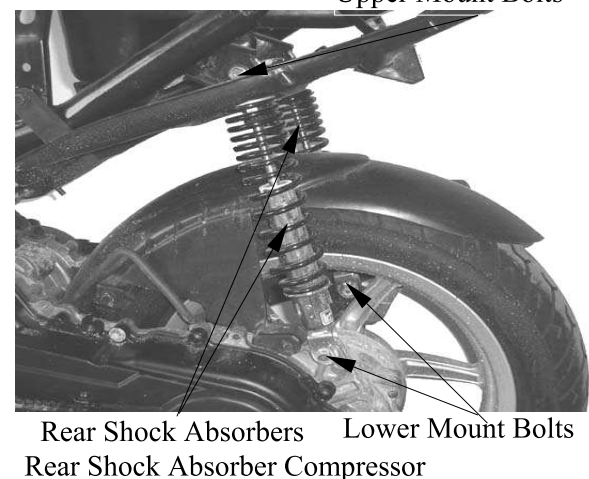

## DISASSEMBLY

Install the rear shock absorber compressor as the figure shown.

\* Install the rear shock absorber lower joint into the rear shock absorber compressor.

Compress the rear shock absorber spring.

**Special**

Cushion Assemble & Disassemble Tool

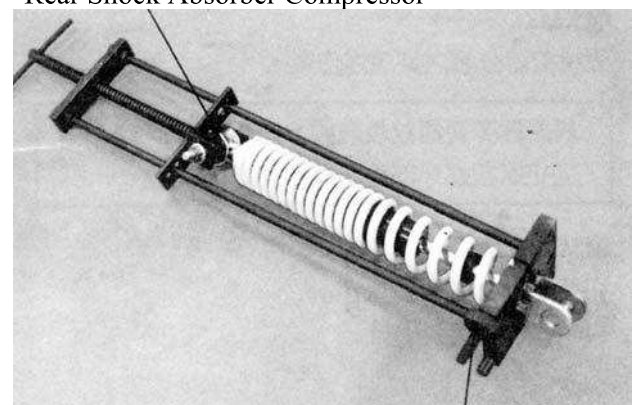

Cushion Assemble & Disassemble Tool

# 13. REAR WHEEL/REAR BRAKE/ REAR SUSPENSION

## INSPECTION

Inspect the damper rod for bending or damage.  
Inspect the damper for oil leaks.  
Inspect the damper rubber for deterioration or damage.

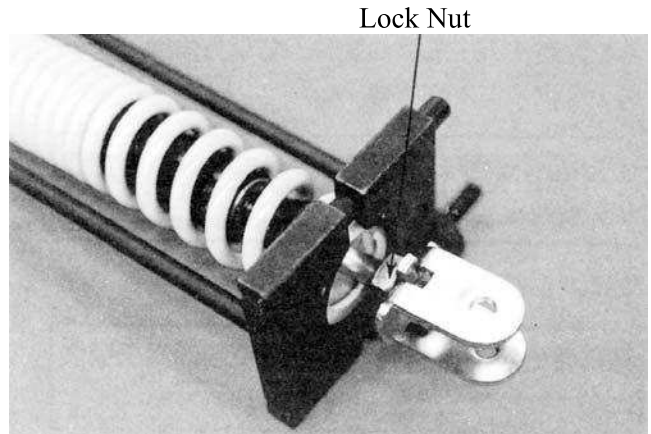

Measure the rear shock absorber spring free length.

**Service Limit:** 210mm replace if over

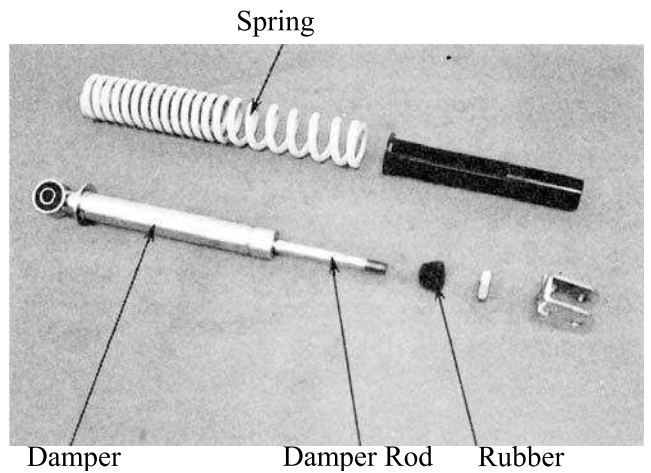

## ASSEMBLY

Assemble the rear shock absorbers in the reverse order of disassembly.

- \* Install the shock absorber spring with loosely wound coils facing down.
- \* Apply locking agent to the lock nut threads and tighten the lock nut.

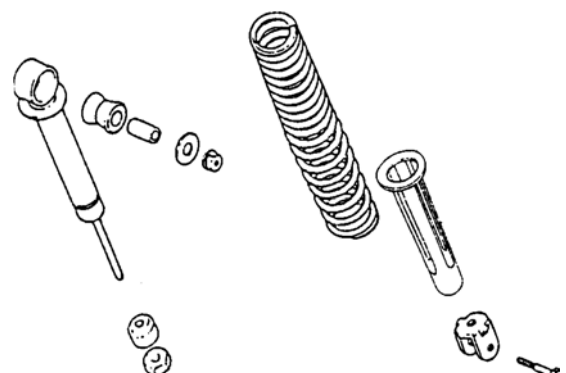
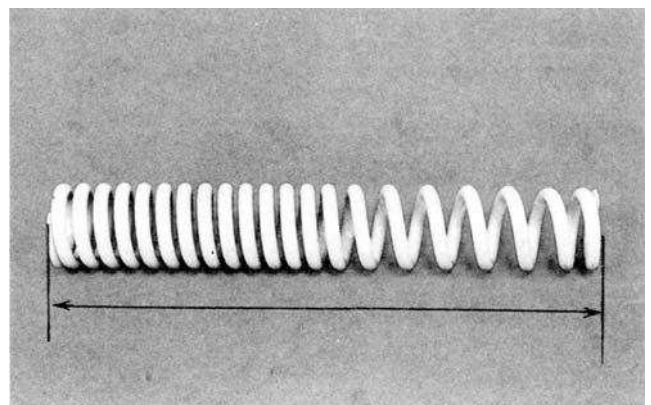

## 13. REAR WHEEL/REAR BRAKE/ REAR SUSPENSION

### INSTALLATION

Install the rear shock absorber.  
Install the rear shock absorber upper mount bolt and then the lower mount bolt.  
Tighten the bolts.

#### **Torque:**

Upper Mount Bolt: 3.5~4.5kgf-m

Lower Mount Bolt: 2.4~3.0kgf-m

Install the air cleaner case. (⇒5-15)

Install the frame body cover. (⇒2-3)

Upper Mount Bolt

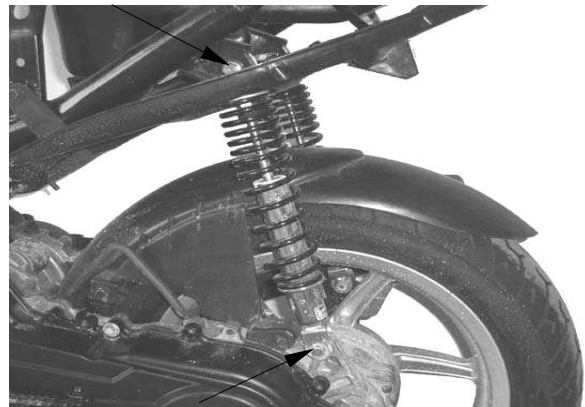

Lower Mount Bolt

# 14. BATTERY/CHARGING SYSTEM/ A.C. GENERATOR

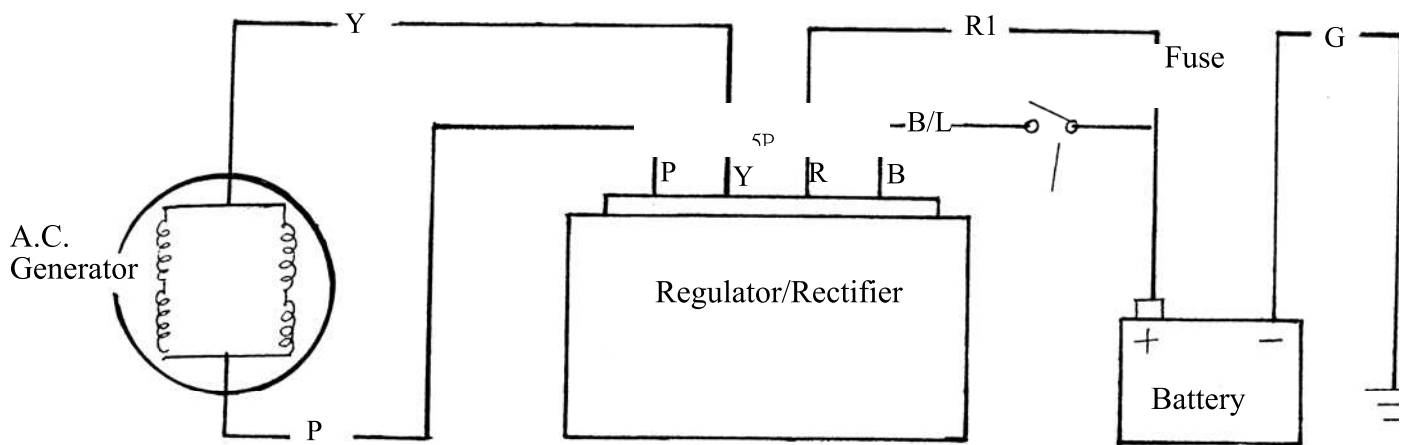
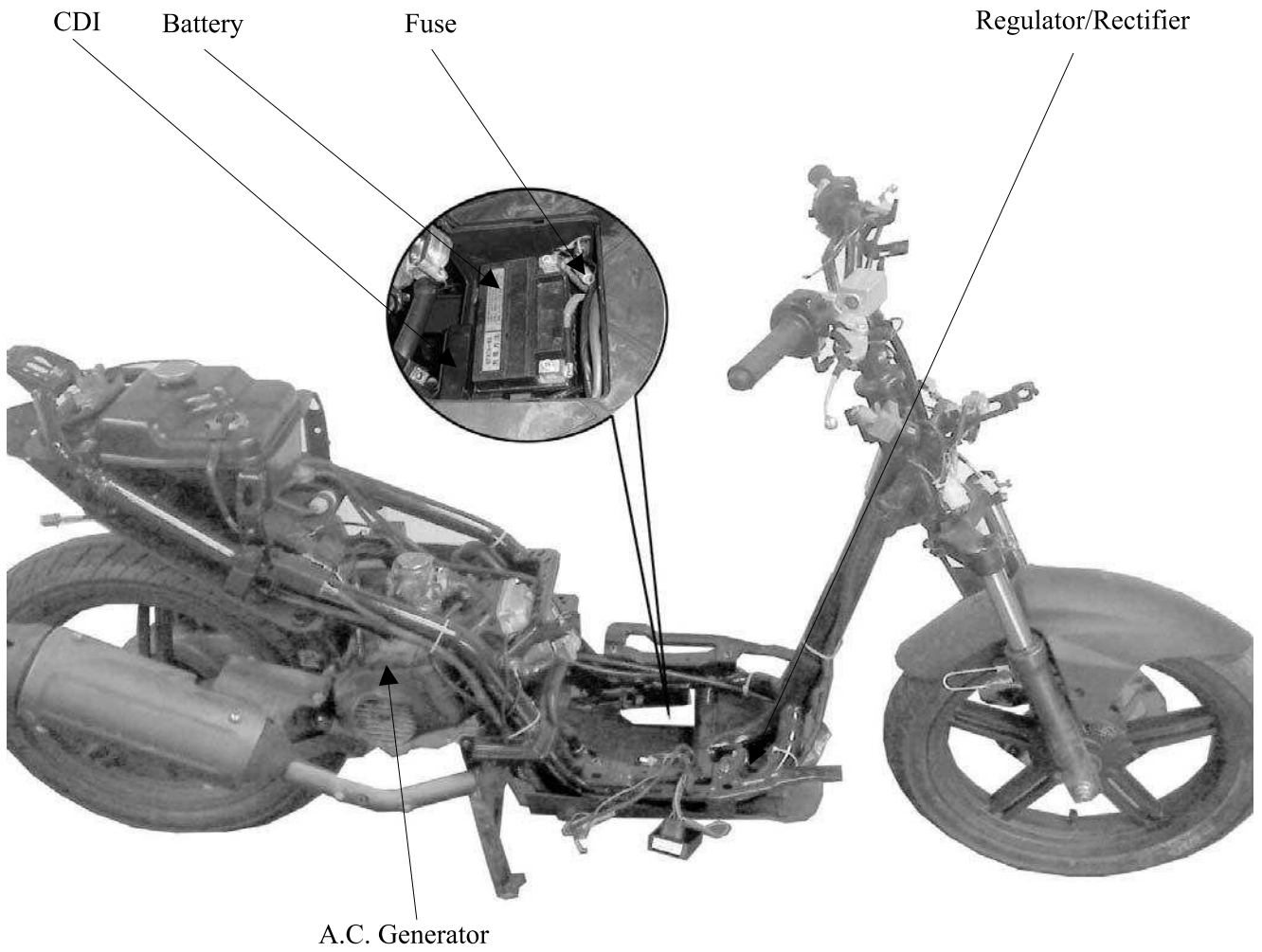

SERVICE INFORMATION.....	14-1	A.C. GENERATOR CHARGING COIL ...	14-6
TROUBLESHOOTING .....	14-2	RESISTOR INSPECTION.....	14-6
BATTERY.....	14-3	A.C. GENERATOR REMOVAL .....	14-6
CHARGING SYSTEM .....	14-4	A.C. GENERATOR INATALLATION ...	14-8
REGULATOR/RECTIFIER.....	14-5		

## SERVICE INFORMATION

### GENERAL INSTRUCTIONS



The battery electrolyte (sulfuric acid) is poisonous and may seriously damage the skin and eyes. Avoid contact with skin, eyes, or clothing. In case of contact, flush with water and get prompt medical attention

- The battery can be charged and discharged repeatedly. If a discharged battery is not used for a long time, its service life will be shortened. Generally, the capacity of a battery will decrease after it is used for 2~3 years. A capacity-decreased battery will resume its voltage after it is recharged but its voltage decreases suddenly and then increases when a load is added.
- When a battery is overcharged, some symptoms can be found. If there is a short circuit inside the battery, no voltage is produced on the battery terminals. If the rectifier won't operate, the voltage will become too high and shorten the battery service life.
- If a battery is not used for a long time, it will discharge by itself and should be recharged every 3 months.
- A new battery filled with electrolyte will generate voltage within a certain time and it should be recharged when the capacity is insufficient. Recharging a new battery will prolong its service life.
- Inspect the charging system according to the sequence specified in the Troubleshooting.
- Do not disconnect and soon reconnect the power of any electrical equipment because the electronic parts in the regulator/rectifier will be damaged. Turn off the ignition switch before operation.
- It is not necessary to check the MF battery electrolyte or fill with distilled water.
- Check the load of the whole charging system.
- Do not quick charge the battery. Quick charging should only be done in an emergency.
- Remove the battery from the motorcycle for charging.
- When replacing the battery, do not use a traditional battery.
- When charging, check the voltage with a voltmeter.

# 14. BATTERY/CHARGING SYSTEM/ A.C. GENERATOR

## SPECIFICATIONS

Item		Standard	
Battery	Capacity/Model	12V7AH	
	Voltage (20°C)	Fully charged	13.1V
		Undercharged	12.3V
	Charging current	STD: 0.4A Quick: 4.0A	
	Charging time	STD: 5~10hr Quick: 30min	
A.C. Generator	Capacity	0.144KW/5000rpm	
	Charging coil resistance (20°C)	Yellow~Peach 0.1~1.0Ω	
Regulator/Rectifier	Type	Single-phase full-wave SCR	
	Limit voltage		
		Charging	14.5±0.5V/5000rpm
Resistor	Resistance (20°C)	5W12Ω	

## TORQUE VALUES

Pulser coil bolt	0.45~0.6kgf-m
Stator bolt	0.8~1.2kgf-m
Flywheel nut	3.5~4.5kgf-m
Cooling fan bolt	0.8~1.2kgf-m

## SPECIAL TOOLS

Universal holder  
Flywheel puller

## TESTING INSTRUMENTS

Kowa electric tester  
Sanwa electric tester

## TROUBLESHOOTING

### No power

- Dead battery
- Disconnected battery cable
- Fuse burned out
- Faulty ignition switch

### Low power

- Weak battery
- Loose battery connection
- Charging system failure
- Faulty regulator/rectifier

### Intermittent power

- Loose battery cable connection
- Loose charging system connection
- Loose connection or short circuit in lighting system

### Charging system failure

- Loose, broken or shorted wire or connector
- Faulty regulator/rectifier
- Faulty A.C. generator



# 14. BATTERY/CHARGING SYSTEM/ A.C. GENERATOR

## BATTERY

### REMOVAL

Remove the battery cover screws on the floor board.

Open the battery cover and remove the battery by removing the bolt and band. First disconnect the battery negative (-) cable and then the positive (+) cable.

 When disconnecting the battery positive (+) cable, do not touch the frame with tool; otherwise it will cause short circuit and sparks to fire the fuel.

The installation sequence is the reverse of removal.

 First connect the positive (+) cable and the negative (-) cable to avoid short circuit.

### BATTERY VOLTAGE (OPEN CIRCUIT VOLTAGE) INSPECTION

Remove the floor board.  
Open the battery cover and disconnect the battery cables.  
Measure the voltage between the battery terminals.

Fully charged : 13.1V  
Undercharged : 12.3V max.

\* Battery charging inspection must be performed with a voltmeter.

### CHARGING

Connect the charger positive (+) cable to the battery positive (+) terminal.  
Connect the charger negative (-) cable to the battery negative (-) terminal.

 • Keep flames and sparks away from a charging battery.  
• Turn power ON/OFF at the charger, not at the battery terminals to prevent sparks near the battery to avoid explosion.  
• Charge the battery according to the

\* • Quick charging should only be done in an emergency.  
• Measure the voltage 30 minutes after the battery is charged.

Charging current: Standard : 0.4A  
Quick : 4A

Charging time : Standard : 5~10 hours  
Quick : 30 minutes

After charging: Open circuit voltage: 12.8V min.  
Note: The battery temperature should not exceed 45°C during charging.

Battery Cover



battery negative (-) cable



positive (+) cable

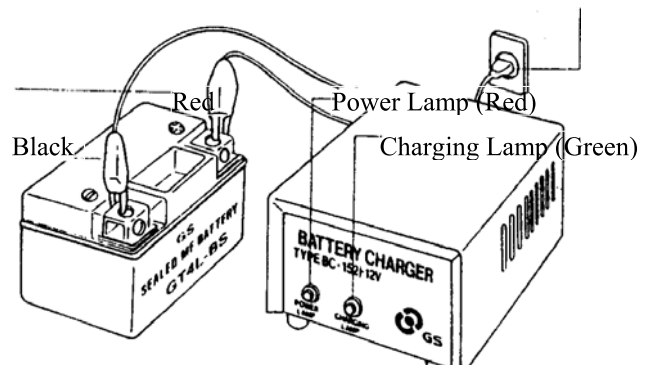
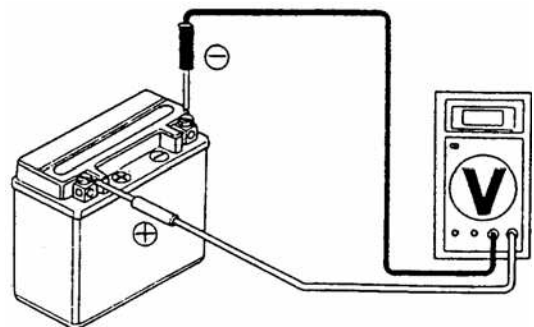

## CHARGING SYSTEM

### SHORT CIRCUIT TEST

Disconnect the ground wire from the battery and connect an ammeter across the battery negative (-) terminal and the ground wire. Turn the ignition switch OFF and check for short circuit.

\* Connect the electric tester positive (+) terminal to ground wire and the tester negative (-) terminal to the battery negative (-) terminal.

If any abnormality is found, check the ignition switch and wire harness for short circuit .

### CURRENT TEST

This inspection must be performed with an electric tester when the battery is fully charged.

Warm up the engine for inspection.

Connect the electric tester across the battery terminals. Disconnect the fuse and connect an ammeter between the fuse terminals.

Attach a tachometer to the engine.

Start the engine and gradually increase the engine speed to measure the limit voltage and current.

**Limit Voltage/Current:** 14~15V/0.5A max.  
(5000rpm max.)

If the limit voltage is not within the specified range, check the regulator/rectifier. (⇒14-5)

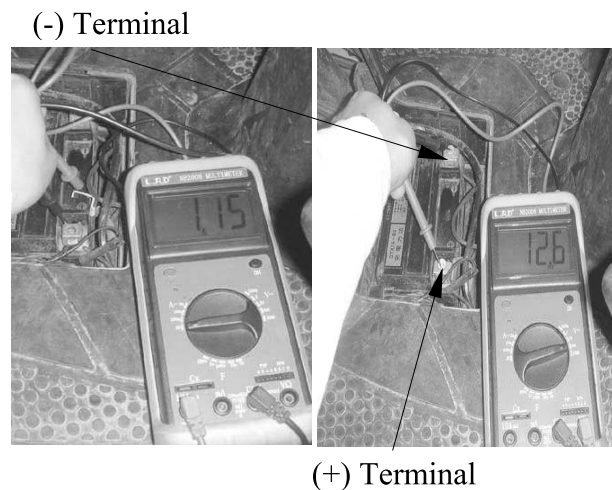
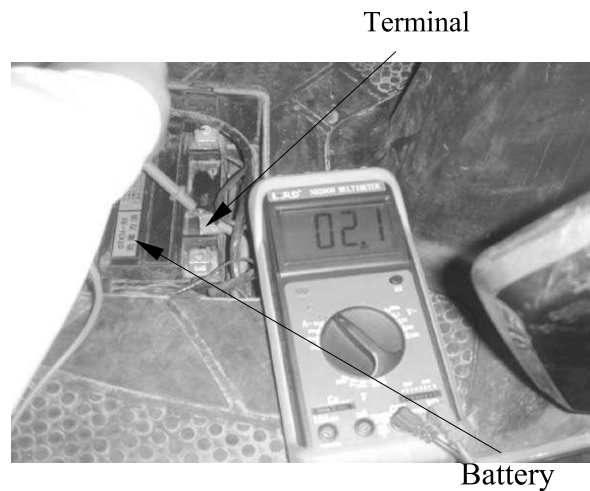

# 14. BATTERY/CHARGING SYSTEM/ A.C. GENERATOR

## REGULATOR/RECTIFIER

### MAIN HARNESS CIRCUIT INSPECTION

Remove the front covers. (⇒2-2)  
Remove the regulator/rectifier 4P coupler and check for continuity between the wire harness terminals according to the following :

Item (Wire Color)	Judgment
Between battery (red) and engine ground	Battery has voltage
Between ground (green) and engine ground	Continuity exists
Between c.d.i wire (black/blue) and engine ground (Remove the auto bystarter coupler and turn the lighting switch OFF for inspection)	A.C. generator stator nought resistance
Between charging coil (yellow or peach) and engine ground	A.C. generator stator nought resistance

Regulator/Rectifier

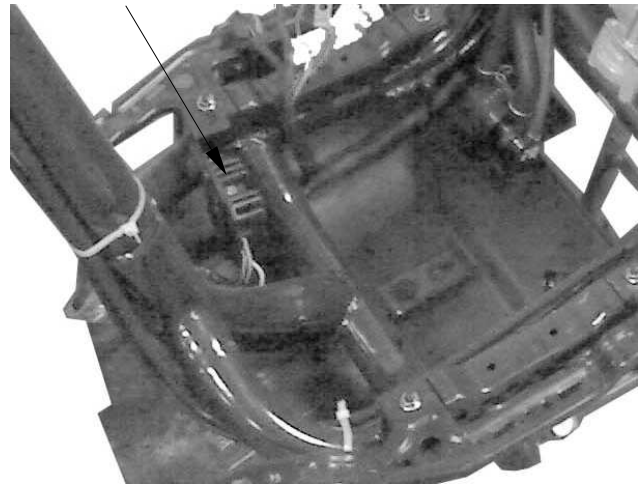

## REGULATOR/RECTIFIER

### REMOVAL

Remove the regulator/rectifier lock nut and disconnect the regulator/rectifier wire coupler.  
Measure the resistances between the regulator/rectifier wire terminals. Replace the regulator/rectifier if the readings are not within the specifications in the table below.

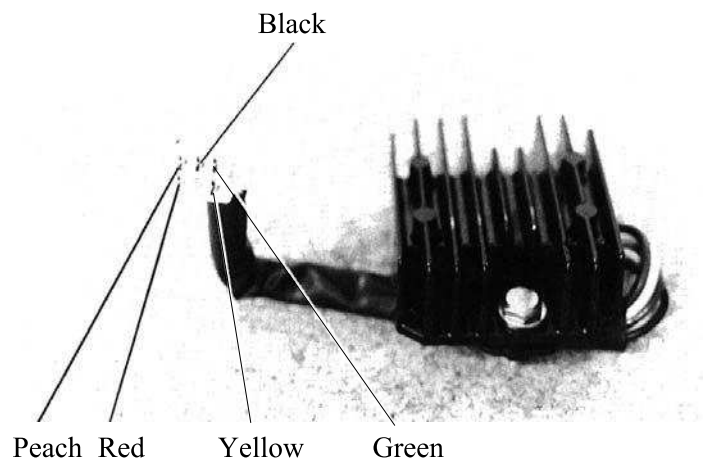

- \* • Due to the semiconductor in circuit, it is necessary to use a specified tester for accurate testing. Use of an improper tester or measurements in an improper range may give false readings.  
• Use a Sanwa Electric Tester or Kowa Electric Tester for testing.

### Testing Range

Range for the Sanwa Tester: xKΩ  
Range for the Kowa Tester: x100Ω

(+)Probe	Peach	Yellow	Red	Green	Black
(-)Probe					
Peach		∞	4-7K	∞	∞
Yellow	∞		4-7K	∞	∞
Red	∞	∞		∞	∞
Green	4-6K	4-6K	13-17K		1-2K
Black	4-7K	4-7K	13-17K	1-2K	

# 14. BATTERY/CHARGING SYSTEM/ A.C. GENERATOR

## A.C. GENERATOR CHARGING COIL

\* The inspection of A.C. generator charging coil can be made with the engine installed.

### INSPECTION

Disconnect the A.C. generator 2P connector. Measure the resistance between the A.C. generator white wire and engine ground with an electric tester.

**Standard:** 0.1 ~ 1.0Ω(at 20°C)

Replace the A.C. generator charging coil if the reading is not within the specifications.

Charging Coil Wire



## A.C. GENERATOR REMOVAL

Remove the right side cover. (⇒2-4)  
Remove the four bolts attaching the cooling fan cover to remove the fan cover.

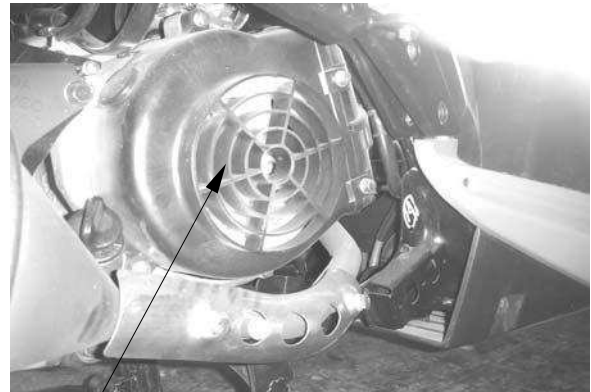

Fan Cover

# 14. BATTERY/CHARGING SYSTEM/ A.C. GENERATOR

Remove the cooling fan by removing the four cooling fan attaching bolts.

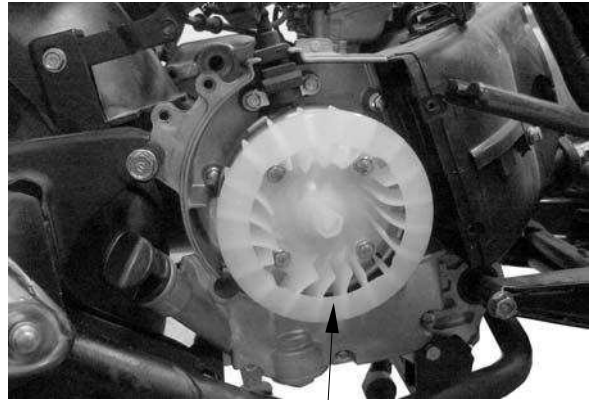

Cooling Fan

Hold the flywheel with an universal holder.  
Remove the flywheel nut.

**Special**

Universal Holder

Universal Holder

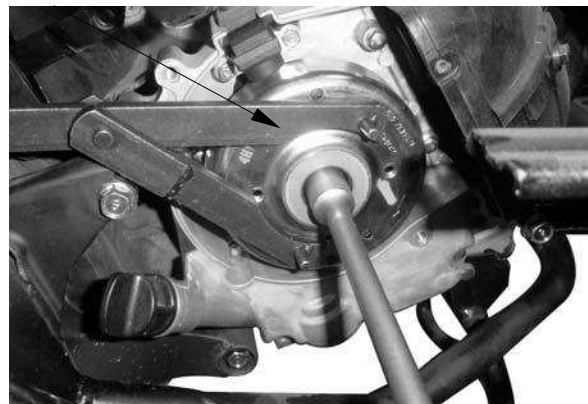

Remove the A.C. generator flywheel using  
the flywheel puller.  
Remove the woodruff key.

**Special**

Flywheel Puller

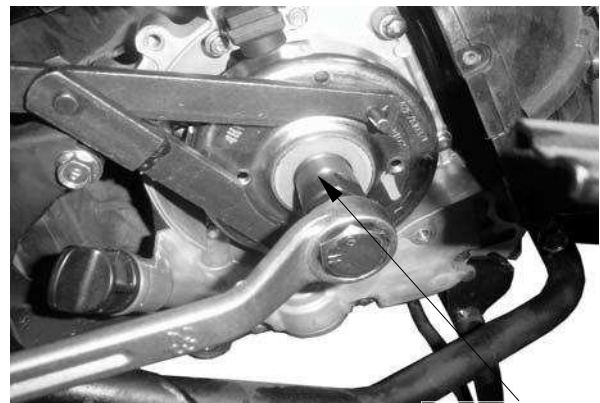

Flywheel Puller

A.C. Generator Wire Connector

Remove the A.C. generator wire connector.



# 14. BATTERY/CHARGING SYSTEM/ A.C. GENERATOR

Remove the A.C. generator wire set plate.  
Remove the pulser coil bolts.  
Remove the A.C. generator wire rubber sleeve and pulser coil from the right crankcase.

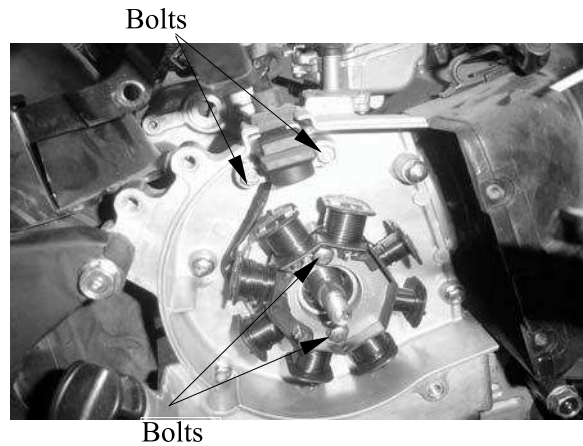

## A.C. GENERATOR INSTALLATION

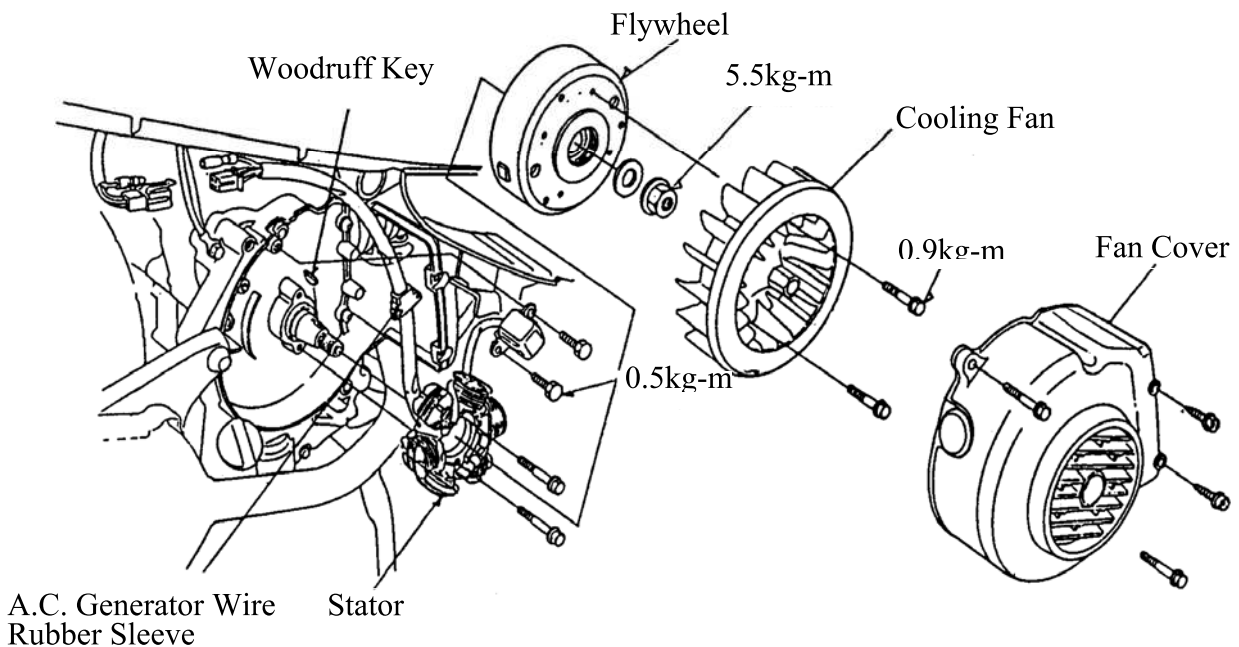

Install the A.C. generator stator and pulser coil onto the right crankcase.  
Tighten the stator and pulser coil bolts.

**Torques: Pulser Coil** : 0.45~0.6kgf-m  
**Stator** : 0.8~1.2kgf-m

Install the A.C. generator wire rubber sleeve and A.C. generator wire set plate.

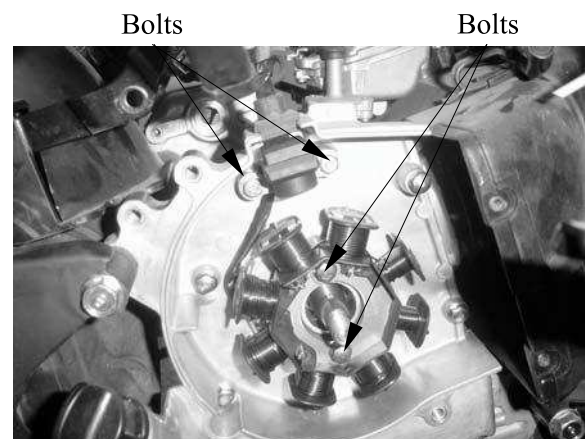

# 14. BATTERY/CHARGING SYSTEM/ A.C. GENERATOR

Connect the A.C. generator wire connector.

A.C. Generator Wire Connector



Clean the taper hole in the flywheel off any burrs and dirt.  
Install the woodruff key in the crankshaft keyway.

Woodruff Key



Install the flywheel onto the crankshaft with the flywheel hole aligned with the crankshaft woodruff key.

\* The inside of the flywheel is magnetic.  
Make sure that there is no bolt or nut before installation.

Universal Holder

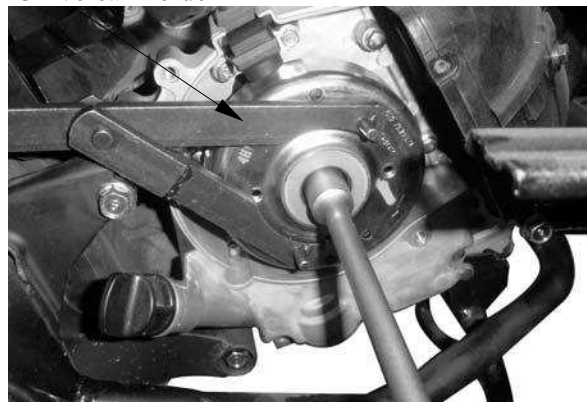

Hold the flywheel with the universal holder and tighten the flywheel nut.

**Torque:** 3.5~4.5kgf-m

Special

Universal Holder  
Install the cooling fan.  
**Torque:** 0.8~1.2kgf-m

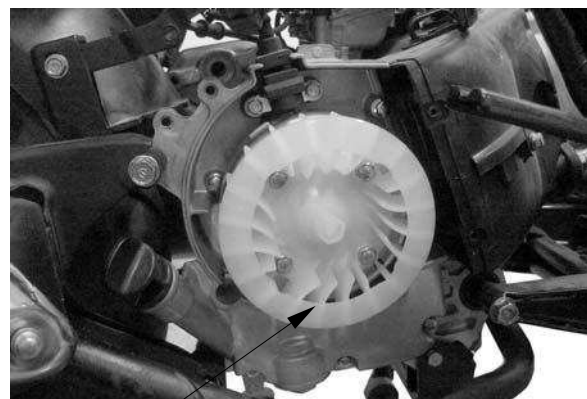

Cooling Fan

## 14. BATTERY/CHARGING SYSTEM/ A.C. GENERATOR

---

Install the fan cover.  
Install the right side cover. (⇒2-4)

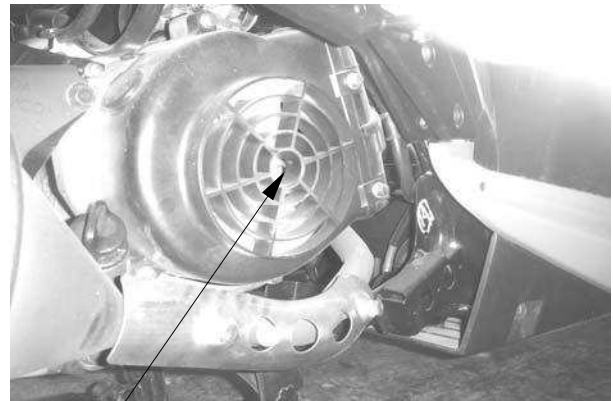

Fan Cover



# 15. IGNITION SYSTEM

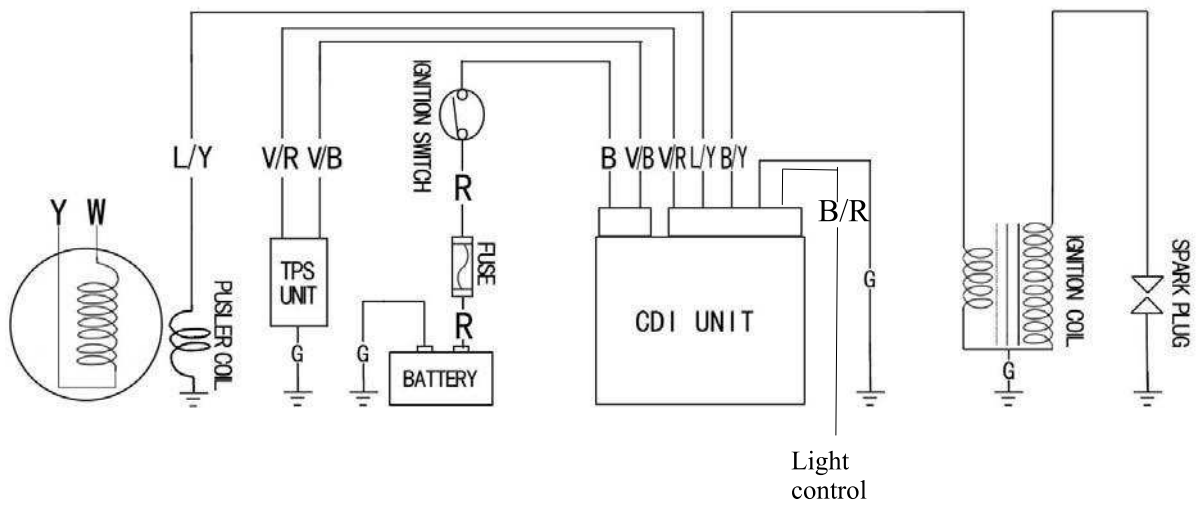
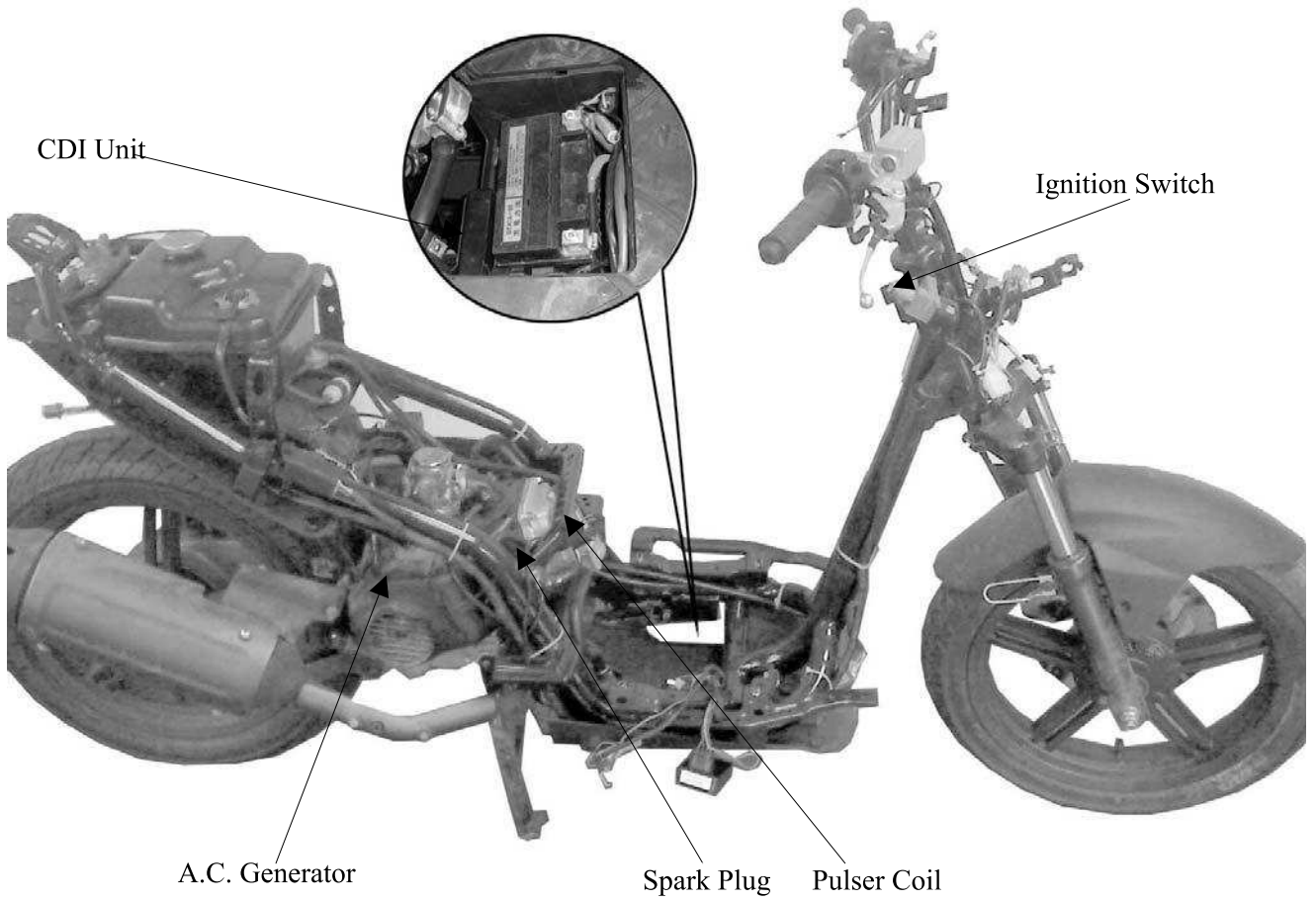

# 15. IGNITION SYSTEM

SERVICE INFORMATION .....	15-1	IGNITION COIL .....	15-4
TROUBLESHOOTING .....	15-2	PULSER COIL .....	15-5
CDI UNIT INSPECTION .....	15-3		

## SERVICE INFORMATION

### GENERAL INSTRUCTIONS

- Check the ignition system according to the sequence specified in the Troubleshooting. (⇒15-2)
- The ignition system adopts CDI unit and the ignition timing cannot be adjusted.
- If the timing is incorrect, inspect the CDI unit and A.C. generator and replace any faulty parts.  
Inspect the CDI unit with a CDI tester
- Loose connector and poor wire connection are the main causes of faulty ignition system. Check each connector before operation.
- Use of spark plug with improper heat range is the main cause of poor engine performance.
- The inspections in this section are focused on maximum voltage. The inspection of ignition coil resistance is also described in this section.
- Inspect the ignition switch according to the continuity table specified in page 17-3.
- Inspect the spark plug referring to Section 3.
- Remove the A.C. generator and pulser coil referring to Section 14.

### SPECIFICATIONS

Item		Standard	
Spark plug	Standard type	(NGK) C7HSA	
	Hot type	(NGK) C6HSA	
	Cold type	(NGK) C8HSA	
Spark plug gap		0.6~0.7mm	
Ignition timing	“F” mark Full advance	13° BTDC /1,700rpm±100RPM 28° BTDC /4,000rpm±100RPM	
Ignition coil resistance (20°C)	Primary coil	0.1~1.0Ω	
	Secondary coil	with plug cap	7~12KΩ
		without plug cap	3~5KΩ
Pulser coil resistance (20°C)		40~300Ω	
Ignition coil primary side max. voltage		12V min.	
Pulser coil max. voltage		2.1V min.	

### TESTING INSTRUMENT

Kowa Electric Tester

or commercially available electric tester with resistance over 10MΩ/CDV

# 15. IGNITION SYSTEM

---

## TROUBLESHOOTING

### High voltage too low

- Weak battery or low engine speed
- Loose ignition system connection
- Faulty ignition coil
- Faulty CDI unit
- Faulty pulser coil

### Intermittent high voltage

- Faulty ignition switch
- Poorly connected CDI unit coupler
- Poorly connected or broken CDI ground wire
- Faulty pulser coil
- Loose high tension wire connection
- Faulty CDI unit

### Normal high voltage but no spark at plug

- Faulty spark plug
- Faulty spark plug cap

### No high voltage

- Faulty ignition switch
- Dead battery or faulty regulator/rectifier
- Faulty charging circuit
- Faulty ignition coil
- Faulty CDI unit

### No or intermittent high voltage

- Faulty ignition coil
- Weak battery
- Faulty charging system

# 15. IGNITION SYSTEM

## CDI UNIT INSPECTION

Remove the two battery cover screws.  
 Disconnect the CDI coupler and remove the CDI unit.  
 Measure the resistance between the terminals using the electric tester.

- \*
- Due to the semiconductor in circuit, it is necessary to use a specified tester for accurate testing. Use of an improper tester in an improper range may give false readings.
  - Use a Sanwa Electric Tester or Kowa Electric Tester.
  - In this table, “Needle swings then returns” indicates that there is a charging current applied to a condenser. The needle will then remain at “∞” unless the condenser is discharged.



CDI Unit

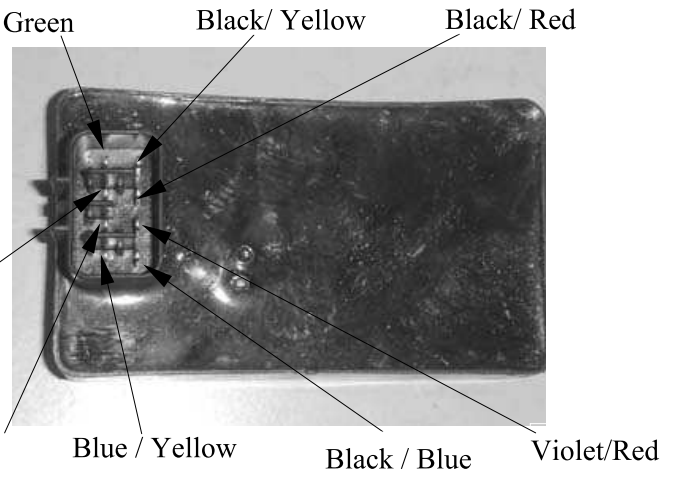

Violet/ Black

# 15. IGNITION SYSTEM

## IGNITION COIL

### REMOVAL

Remove the met-in box. (⇒2-3)  
 Remove the spark plug cap.  
 Disconnect the ignition coil wires and remove the ignition coil bolt and ignition coil.



Ignition Coil

### INSPECTION

#### CONTINUITY TEST

\* The CDI unit is not adjustable. If the timing is incorrect, inspect the CDI unit, pulser coil and A.C. generator and replace any faulty parts.

Measure the resistance between the ignition coil primary coil terminals.

**Resistance:** 0.1 ~ 1.0Ω

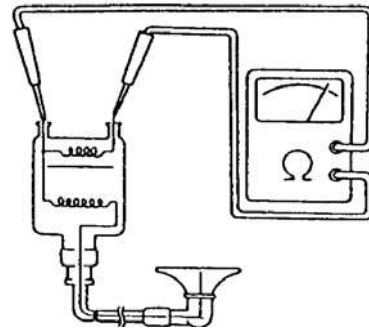

Measure the secondary coil resistances with and without the spark plug cap.

#### Resistances:

(with plug cap) : 7 ~ 12KΩ

(without plug cap) : 3 ~ 5KΩ

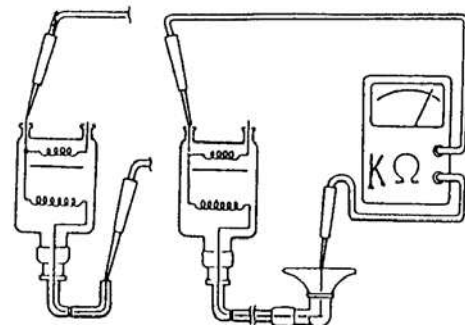

\* Correctly operate the tester following the manufacturer's instructions.

# 15. IGNITION SYSTEM

## PULSER COIL INSPECTION

\* This test is performed with the stator installed in the engine.

Remove the frame body cover. (⇒2-3)  
Disconnect the A.C. generator connector.



Pulser Coil Coupler

Measure the pulser coil resistance between the blue/yellow and green wire terminals.

**Resistance:** 80~160Ω

Refer to page 14-6 for the A.C. generator removal.

## IGNITION TIMING INSPECTION

\* The CDI unit is not adjustable. If the ignition timing is incorrect, inspect the CDI unit, pulser coil and A.C. generator and replace any faulty parts.

Remove the timing hole cap.

Timing Hole Cap



Warm up the engine and check the ignition timing with a timing light.  
When the engine is running at the ignition timing is correct if the "F" mark aligns with the index mark within  $\pm 2^\circ$ .

**Ignition Timing:** BTDC $28^\circ$ /4000rpm



"F" Mark

# 16. STARTING SYSTEM

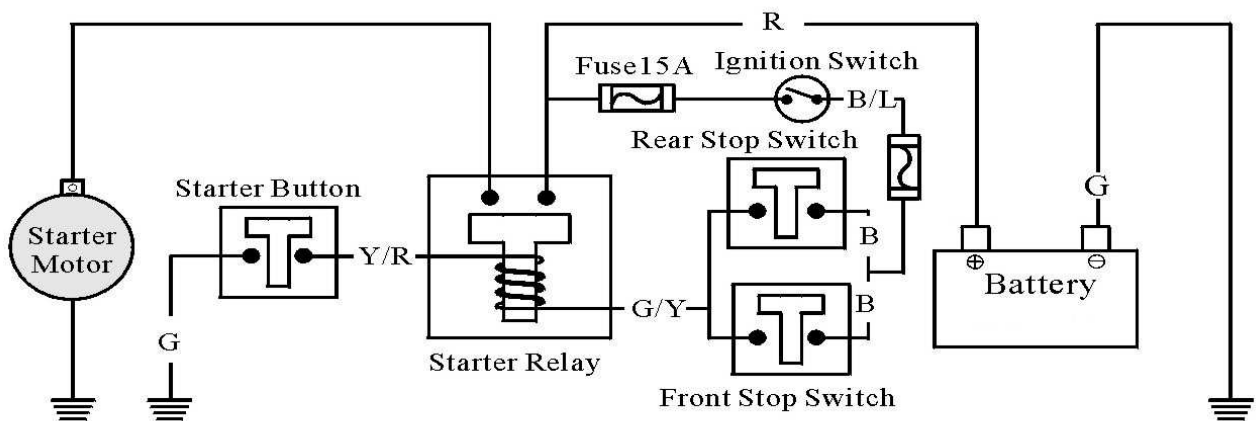
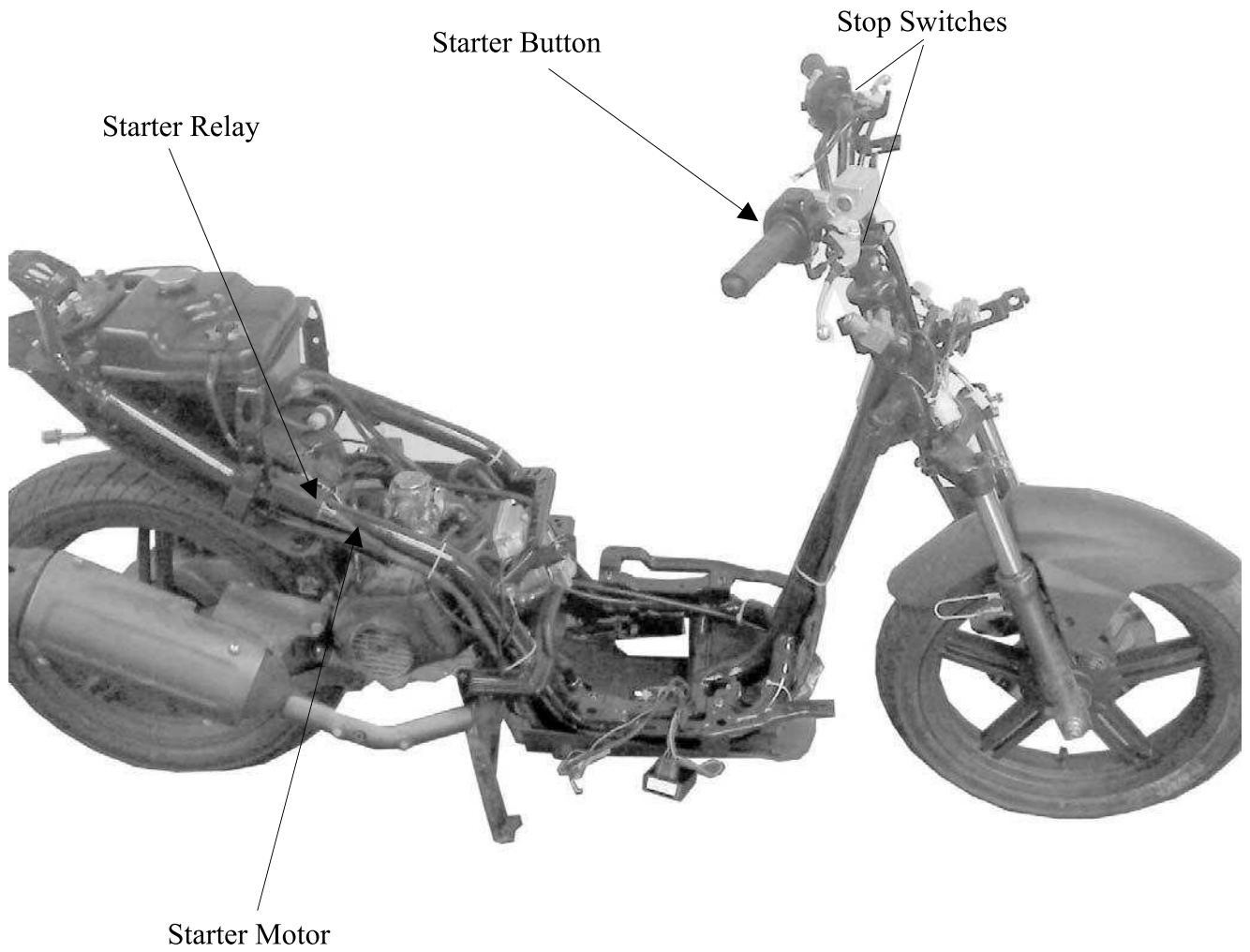

# 16. STARTING SYSTEM

SERVICE INFORMATION.....	16-1	STARTER MOTOR .....	16-2
TROUBLESHOOTING.....	16-1	STARTER RELAY.....	16-4

## SERVICE INFORMATION

### GENERAL INSTRUCTIONS

- The removal of starter motor can be accomplished with the engine installed.

### SPECIFICATIONS

Item	Standard (mm)	Service Limit (mm)
Starter motor brush length	12.5	8.5

### TORQUE VALUES

Starter clutch cover socket bolt	1.2kg-m
Starter clutch lock nut	9.5kg-m

### SPECIAL TOOLS

Flywheel Holder

## TROUBLESHOOTING

### Starter motor won't turn

- Fuse burned out
- Weak battery
- Faulty ignition switch
- Faulty starter clutch
- Faulty front or rear stop switch
- Faulty starter relay
- Poorly connected, broken or shorted wire
- Faulty starter motor

### Lack of power

- Weak battery
- Loose wire or connection
- Foreign matter stuck in starter motor or gear

### Starter motor rotates but engine does not start

- Faulty starter clutch
- Starter motor rotates reversely
- Weak battery



# 16. STARTING SYSTEM

## STARTER MOTOR

### REMOVAL

\* Before removing the starter motor, turn the ignition switch OFF and remove the battery ground. Then, turn on the ignition switch and push the starter button to see if the starter motor operates properly.

Remove the two starter motor mounting bolts and the motor.

Remove the waterproof rubber jacket and disconnect the starter motor cable connector.

### DISASSEMBLY

Remove the two starter motor case screws, front cover, motor case and other parts.

### INSPECTION

Inspect the removed parts for wear, damage or discoloration and replace if necessary. Clean the commutator if there is metal powder between the segments.

Check for continuity between pairs of the commutator segments and there should be continuity.

Also, make a continuity check between individual commutator segments and the armature shaft. There should be no continuity.

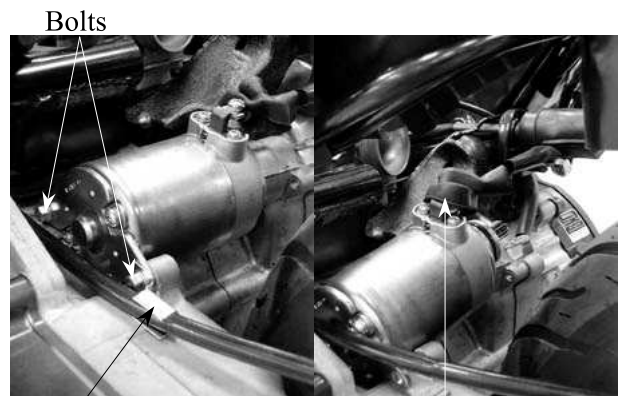

Bolts

Cable Clamp

Starter Motor Cable

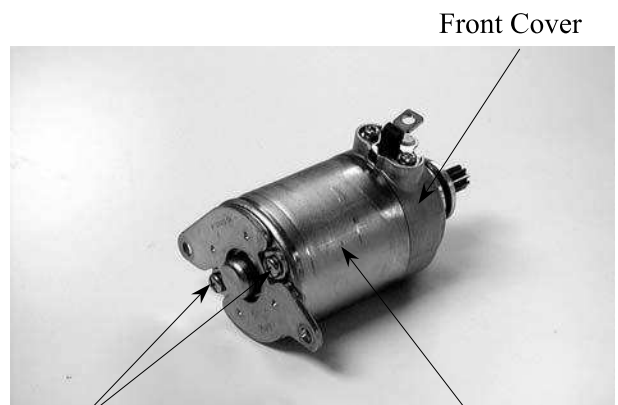

Front Cover

Case Screws

Motor Case



Commutator

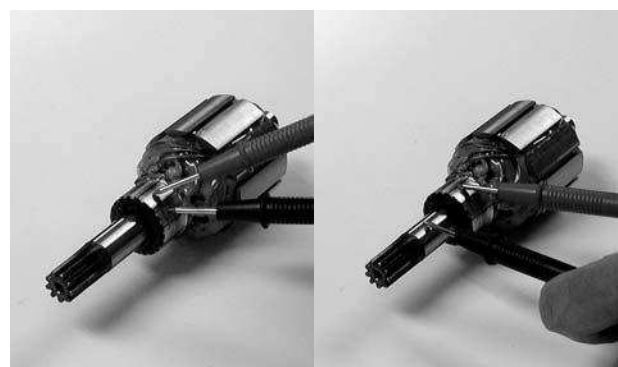

# 16. STARTING SYSTEM

## STARTER MOTOR CASE CONTINUITY CHECK

Check to confirm that there is no continuity between the starter motor wire terminal and the motor front cover.

Also check for the continuity between the wire terminal and each brush.

Replace if necessary.



Wire Terminal

Measure the length of the brushes.

**Service Limit:** 8.5mm replace if below



Check for continuity between the brushes. If there is continuity, replace with new ones.



Check if the needle bearing in the front cover turns freely and has no excessive play.

Replace if necessary.

Check the dust seal for wear or damage.

Bearing



Dust Seal

# 16. STARTING SYSTEM

## ASSEMBLY

Apply grease to the dust seal in the front cover.  
 Install the brushes onto the brush holders.  
 Apply a thin coat of grease to the two ends of the armature shaft.  
 Insert the commutator into the front cover.

- \* 
 • Be careful not to damage the brush and armature shaft mating surfaces.  
 • When installing the commutator, the armature shaft should not damage the dust seal lip.

Install a new O-ring to the front cover.  
 Install the starter motor case, aligning the tab on the motor case with the groove on the front cover.  
 Tighten the starter motor case screws.

- \* 
 When assembling the front cover and motor case, slightly press down the armature shaft to assemble them.

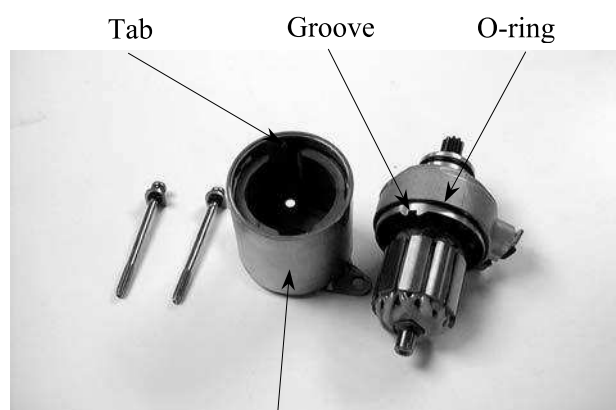
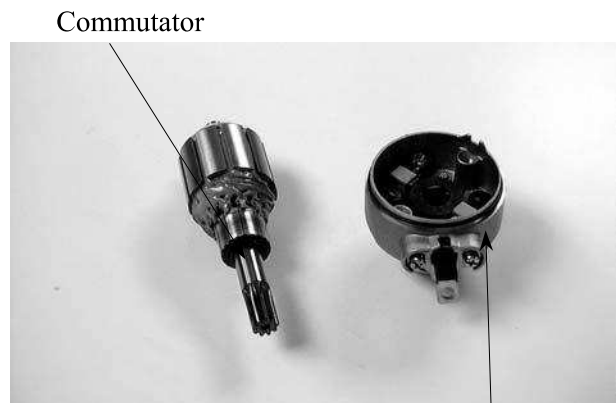

Motor Case

## STARTER RELAY INSPECTION

Remove the frame body cover.  
 Turn the ignition switch ON and the starter relay is normal if you hear a click when the starter button is depressed.  
 If there is no click sound:

- Inspect the starter relay voltage
- Inspect the starter relay ground circuit
- Inspect the starter relay operation



## STARTER RELAY VOLTAGE INSPECTION

Place the motorcycle on its main stand.  
 Measure the voltage between the starter relay connector green/yellow wire (-) and engine ground.  
 Turn the ignition switch ON and the battery voltage should be normal when the brake lever is fully applied.  
 If the battery has no voltage, inspect the stop switch continuity and cable.



# 16. STARTING SYSTEM

## STARTER RELAY GROUND CIRCUIT INSPECTION

Disconnect the starter relay wire connector. Check for continuity between the yellow/red wire terminal and ground.

There should be continuity when the starter button is depressed.

If there is no continuity, check the starter button for continuity and inspect the wire.

Yellow/Red Wire



## OPERATION TEST

Connect the electric tester to the starter relay larger terminals that connect to the battery positive cable and the starter motor cable. Connect a fully charged battery across the starter relay yellow/red and green/yellow wire terminals.

Check for continuity between the starter relay large terminals. The relay is normal if there is continuity.



Starter Relay

Starter Motor Cable

## INSTALLATION

Connect the starter motor cable connector and properly install the waterproof rubber jacket. Check the O-ring for wear or damage and replace if necessary.

Apply grease to the O-ring and install the starter motor.

Tighten the two mounting bolts.

\* The starter motor cable connector must be installed properly.

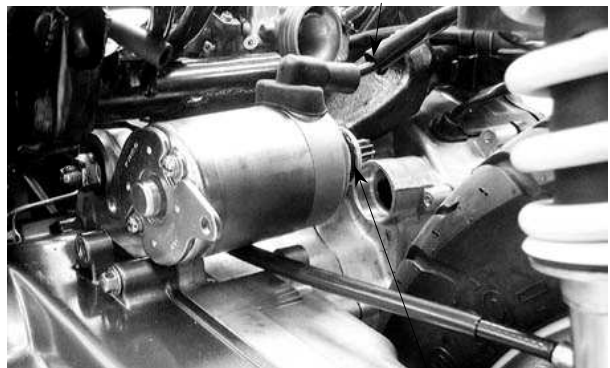

O-ring

## STARTER CLUTCH

### REMOVAL

Remove the A.C. generator.

Remove the right crankcase cover.

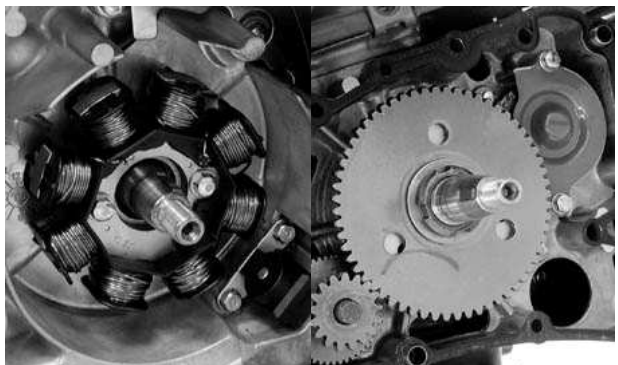

# 16. STARTING SYSTEM

Remove the starter clutch lock nut.

Special

Flywheel Holder

\* Note that the lock nut is left threaded.

Remove the starter clutch.

Remove the starter idle gear and shaft.

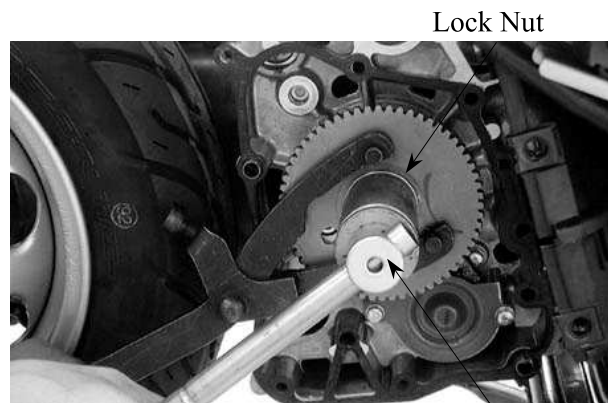

Lock Nut

Flywheel Holder

## INSPECTION

Inspect the operation of the starter drive gear when it is assembled on the clutch.

The starter drive gear should turn clockwise freely and should not turn counterclockwise.



## STARTER CLUTCH DISASSEMBLY

Inspect the starter drive gear for wear or damage and replace if necessary.

Measure the starter drive gear I.D.

**Service Limit:** 32.06mm replace if over

Inspect the needle bearing for wear or damage and replace if necessary.

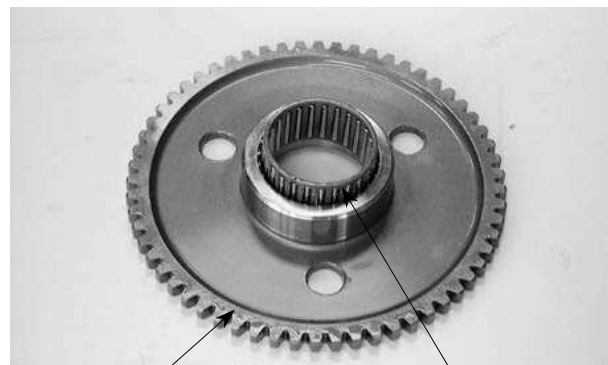

Starter Drive Gear

Needle Bearing

Clutch Body

## CLUTCH BODY DISASSEMBLY

Remove the rollers, plungers and springs from the clutch body.

Inspect the clutch body for wear or damage and replace if necessary.

Inspect each roller and plunger for wear or damage and check for weak spring.

Replace if necessary.

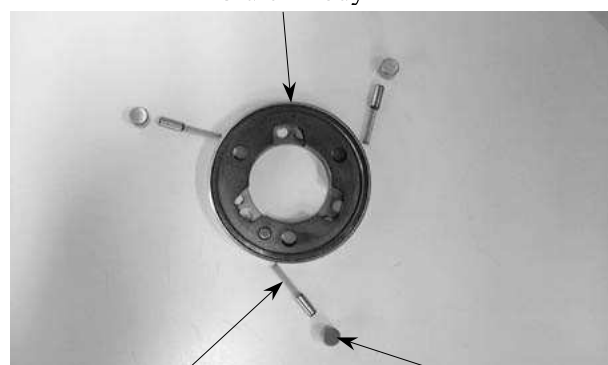

Spring

Roller

# 16. STARTING SYSTEM

Measure the clutch cover O.D.

**Service Limit:** 27.94mm replace if over

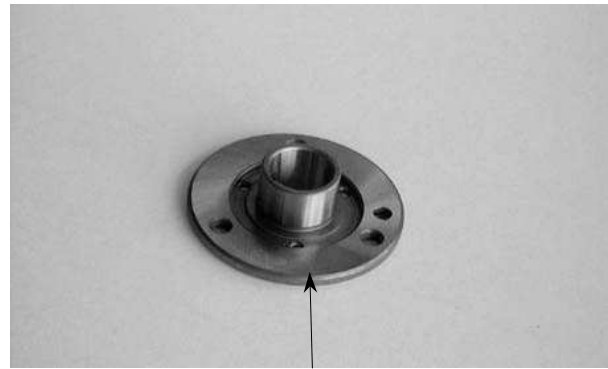

Clutch Cover

Measure the starter idle gear I.D.

**Service Limit:** 10.05mm replace if over

Starter Idle Gear

Measure the starter idle gear shaft O.D.

**Service Limit:** 9.94mm replace if below

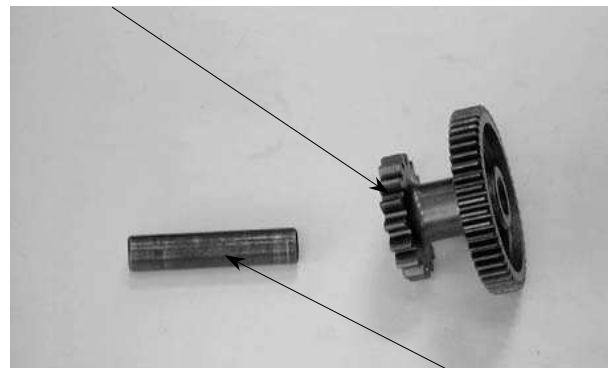

Anchor Pin

Hole

Idle Gear Shaft  
Clutch Cover

## ASSEMBLY

Install the springs, plungers and rollers onto the clutch body.

Install the clutch cover by aligning the clutch cover anchor pin with the hole in the clutch body. Apply locking agent to the threads of the clutch cover bolts and tighten them.

**Torque:** 1.2kg-m

Apply engine oil to the needle bearing and starter drive gear and then install them to the clutch body.

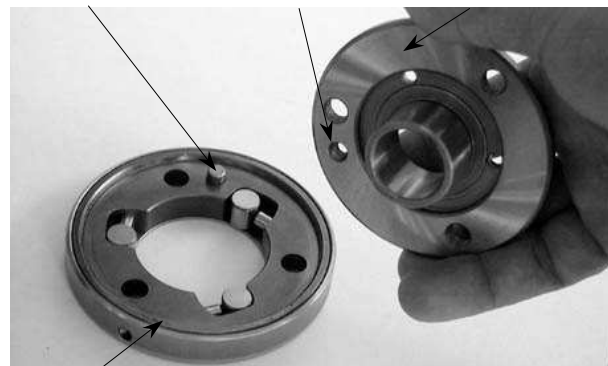

Clutch Body

Lock Nut Wrench

Lock Nut

## INSTALLATION

Install the starter clutch onto the crankshaft. Apply engine oil to the starter idle gear and shaft and then install them.

Hold the starter drive gear with the universal holder and tighten the starter clutch lock nut.

**Torque:** 9.5kg-m

Special

Flywheel Holder

\* Note that the lock nut is left threaded.

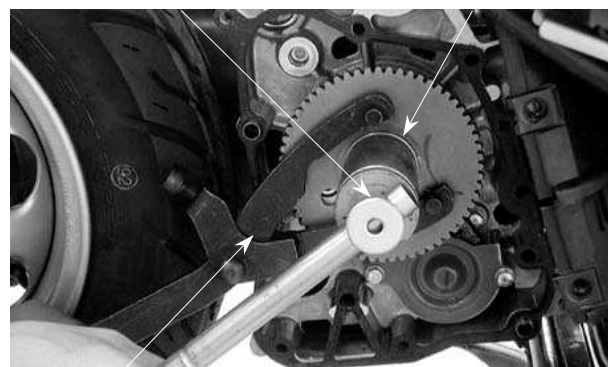

Flywheel Holder

Install the right crankcase cover.

<b>SERVICE INFORMATION.....</b>	<b>17-0</b>	<b>IGNITION SWITCH.....</b>	<b>17-3</b>
<b>TROUBLESHOOTING.....</b>	<b>17-0</b>	<b>STOP SWITCHES/HORN .....</b>	<b>17-4</b>
<b>FUEL UNIT.....</b>	<b>17-1</b>	<b>INSTRUMENTS .....</b>	<b>17-4</b>
<b>HANDLEBAR SWITCHES .....</b>	<b>17-2</b>	<b>HEADLIGHT/LIGHTS .....</b>	<b>17-5</b>

## SERVICE INFORMATION

### GENERAL INSTRUCTIONS

- An electric tester is needed to measure or test the electric equipment.
- Be sure to use fuses and bulbs of the same specifications to avoid damage of electrical equipment.
- After installation of each switch, a continuity check must be performed. A continuity check can usually be made without removing the part from the motorcycle.

## TROUBLESHOOTING

### Lights do not come on when ignition switch is “ON”

- Burned bulb
- Faulty switch
- Broken wire
- Fuse burned out
- Weak battery
- Poorly connected or shorted wire
- Faulty winker

### Light dims

- Faulty ignition coil
- Wire or switch resistance too high
- Faulty regulator/rectifier

### Headlight does not change when dimmer switch is turn to Hi or Lo

- Faulty or burned bulb
- Faulty dimmer switch

### Fuel gauge pointer does not register correctly

- Disconnected wire or connector
- Broken wire
- Faulty float
- Faulty fuel unit
- Faulty instrument

### Fuel gauge pointer fluctuates or swings

- Loose wire connection
- Faulty fuel unit
- Faulty instrument

### FUEL UNIT

\* No Smoking!

#### REMOVAL

Remove the met-in box. (⇒2-3)  
 Remove the frame right side cover. (⇒2-4)  
 Disconnect the fuel unit wire connector.  
 Turn the fuel unit retainer counterclockwise to remove it.

\* Do not damage the fuel unit wire.

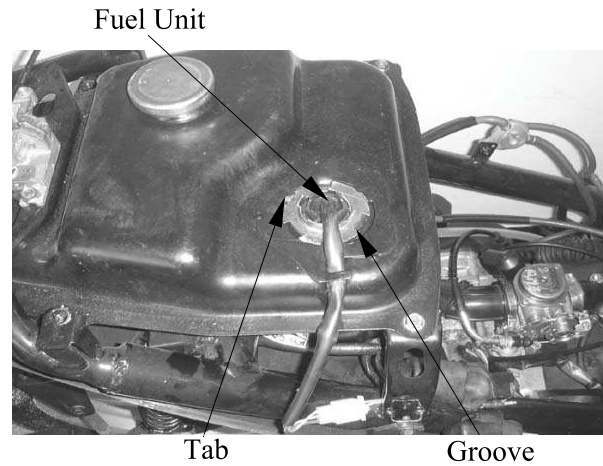

Remove the fuel unit.

\* Be careful not to bend or damage the fuel unit float arm.

#### INSTALLATION

The installation sequence is the reverse of removal.

\* 

- Align the groove on the fuel unit with the tab on the fuel tank.
- Align the arrow on the retainer with the arrow on the fuel tank.
- Turn the retainer clockwise to secure it.

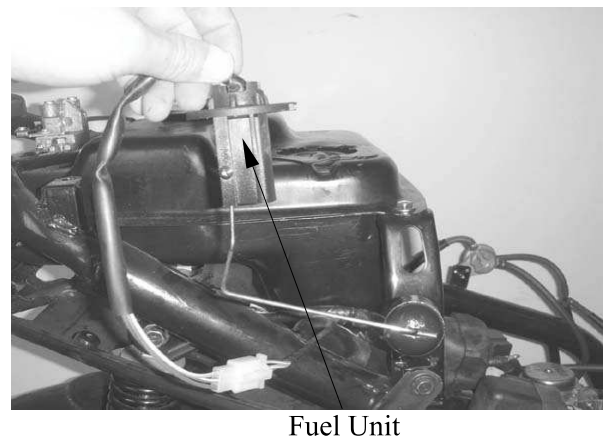

#### INSPECTION

Remove the fuel unit.  
 Measure the resistance between the fuel unit wire terminals with the float at upper and lower positions.

Wire Terminals	Upper	Lower
G~Y/W	30Ω	686Ω
G~L/W	566Ω	153Ω
Y/W~L/W	599Ω	599Ω

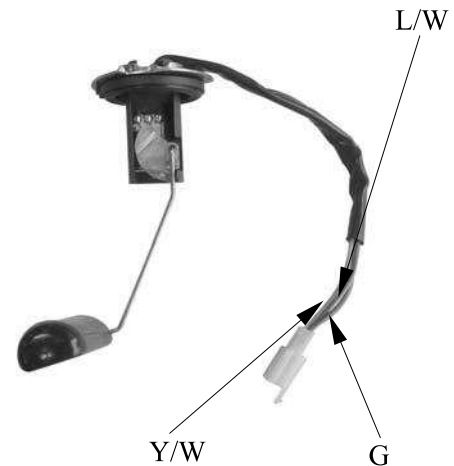

#### FUEL GAUGE INSPECTION

Connect the fuel unit wire connector and turn the ignition switch "ON".

\* Before performing the following test, operate the turn signals to determine that the battery circuit is normal.

Check the fuel gauge needle for correct indication by moving the fuel unit float up and down.

Float Position	Needle Position
Upper	"F" (Full)
Lower	"E" (Empty)

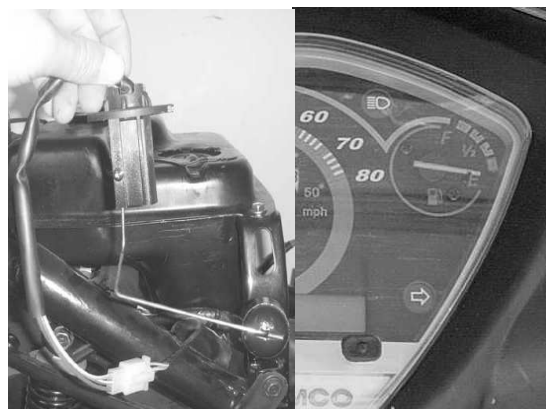



### HANDLEBAR SWITCHES

#### INSPECTION

Remove the handlebar front cover. (⇒2-2)  
 Disconnect the handlebar switch couplers and check for continuity between wire terminals. If there is any abnormality found, check each switch.

#### HEADLIGHT SWITCH

Color	Black	Brown	Blue/White	Brown/White
•	○			
≡	○	○		○
☀	○	○	○	

\* Use the X1Ω range for test when using an electric tester.

#### STARTER SWITCH

Color	Yellow/Red	Green
FREE		
PUSH	○	○

#### DIMMER SWITCH

Color	White	Black	Blue
≡	○	○	
≡		○	○

#### TURN SIGNAL SWITCH

Color	Gray	Light Blue	Orange
R	○	○	
N			
L	○		○

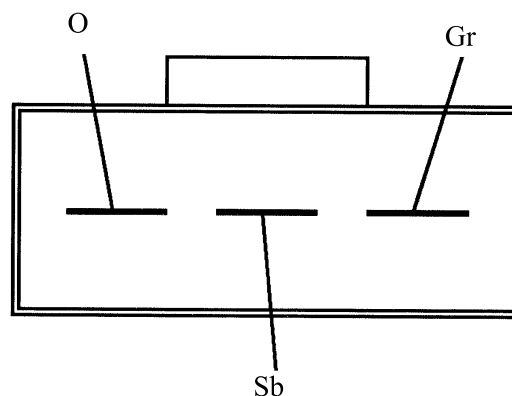
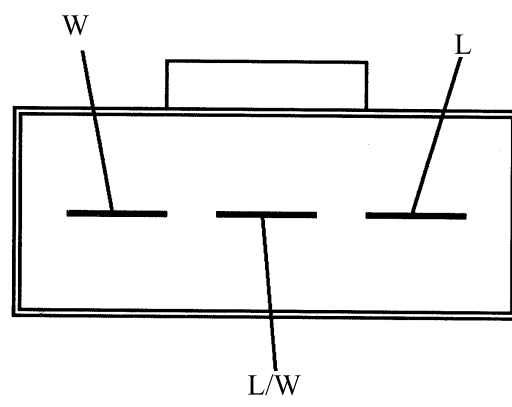
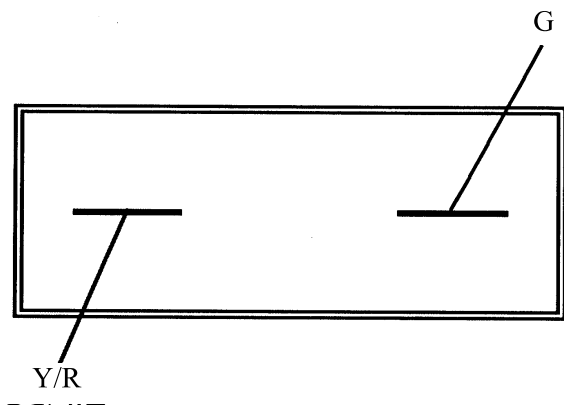
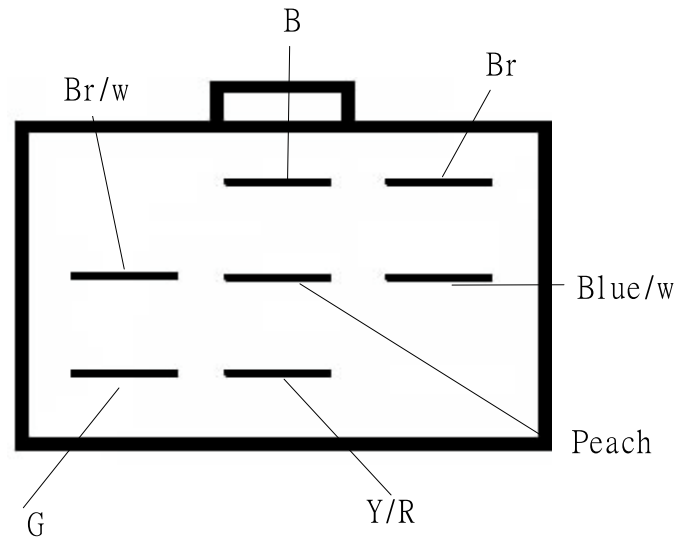

### HORN SWITCH

Color	Light Green	Black
FREE		
PUSH		

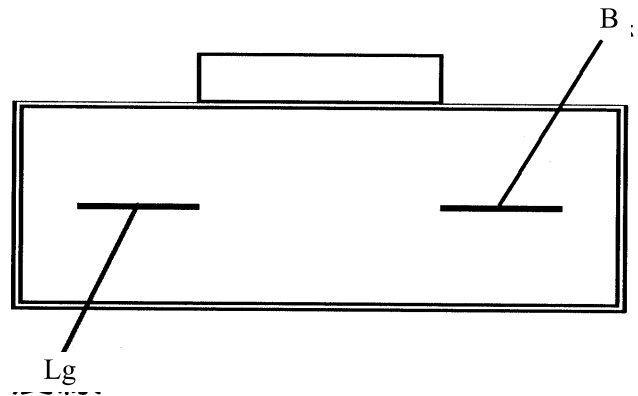

### SWITCH REPLACEMENT

Remove the front covers. (⇒2-2)  
 Remove the handlebar front cover. (⇒2-2)  
 The installation sequence is the reverse of removal.

### IGNITION SWITCH

#### INSPECTION

Remove the front covers. (⇒2-2)  
 Disconnect the ignition switch wire coupler.  
 Check for continuity between the wire terminals.

Color	Black	Red	Black/Blue	Green
OFF				
ON				
LOCK				

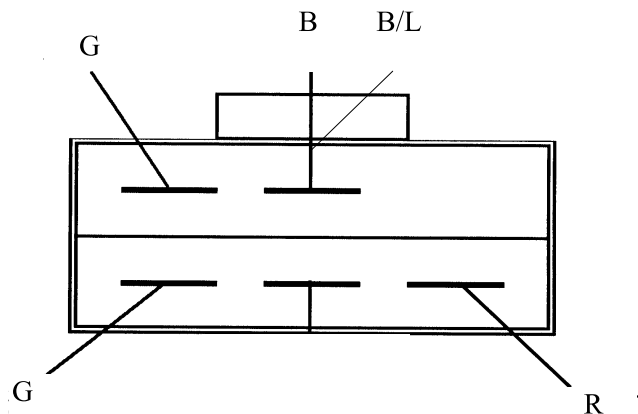

### IGNITION SWITCH REPLACEMENT

Remove the front covers. (⇒2-2)  
 Disconnect the ignition switch wire coupler.  
 Remove the two mounting bolts to remove the ignition switch decorative ring and holder.  
 Remove the two screws to remove the ignition switch from the ignition switch holder for replacement.  
 The installation sequence is the reverse of removal.



Bolts

### STOP SWITCH

#### INSPECTION

Remove the handlebar front cover. (⇒2-2)  
 Disconnect the front stop switch wire coupler.  
 Check for continuity between the wire terminals when the front brake lever is applied. The switch is normal if there is continuity.  
 Disconnect the rear stop switch wire coupler.  
 Check for continuity between the wire terminals when the rear brake lever is applied. The switch is normal if there is continuity.



Stop Switch Wire

### HORN

#### INSPECTION

Remove the front covers. (⇒2-2)  
 Disconnect the horn wire coupler.  
 The horn is normal if it sounds when a 12V battery is connected across the horn wire terminals.

#### REPLACEMENT

Disconnect the horn wire coupler.  
 Remove the two bolts attaching the horn.  
 Remove the horn.  
 The installation sequence is the reverse of removal.

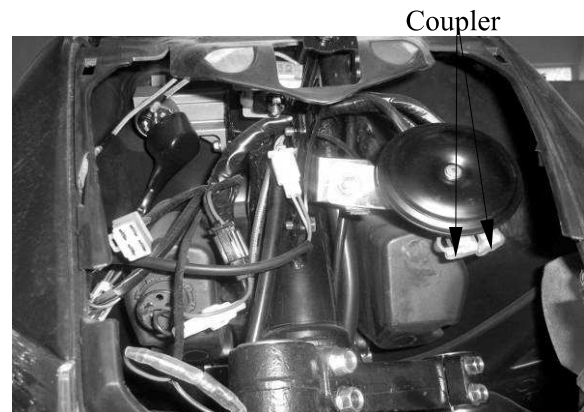

Coupler

### INSTRUMENTS

Remove the handlebar front cover. (⇒2-2)  
 Remove the handlebar rear cover. (⇒2-2)  
 Disconnect the handlebar switch couplers.  
 Remove the three screws to remove the instruments.  
 Install a new horn in the reverse order of removal.

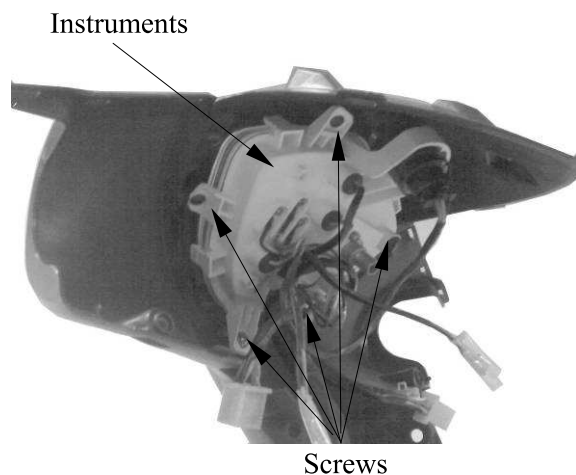

Instruments

Screws

### HEADLIGHT

#### REMOVAL

Remove the screw on the front cover.  
 Remove the two screws on the back of the front cover.  
 Remove the front cover.

The installation sequence is the reverse of removal.

- \*
- Align the tab on the headlight with the groove on the handlebar cover.
  - After installation, adjust the headlight beam. (⇒3-9)

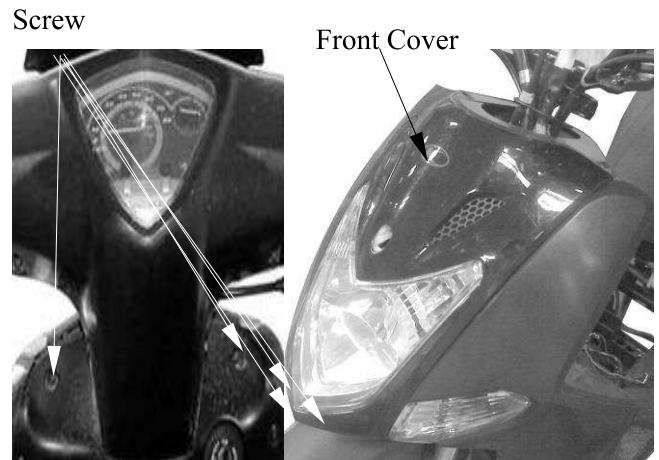

#### BULB REPLACEMENT

Remove the headlight bulb Coupler. (⇒2-2)  
 Remove the headlight replace with new bulbs.  
 The installation sequence is the reverse of removal.

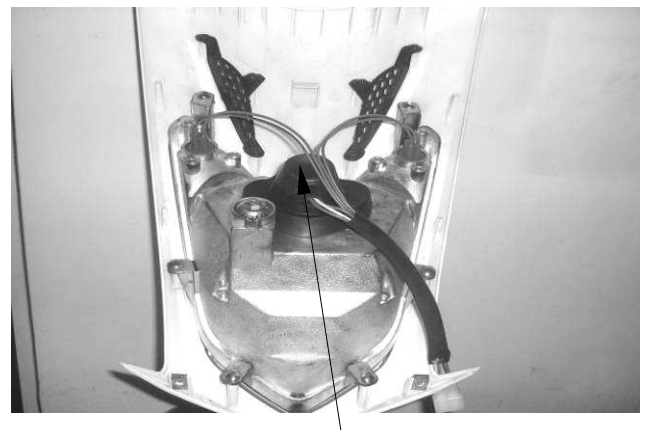

Headlight Bulb Coupler

#### TAILLIGHT/STOPLIGHT/REAR TURN SIGNAL LIGHT/LICENSE LIGHT

Remove the two screws attaching the rear protector molding.  
 Remove the rear protector molding and remove the two nuts attaching the rear light shell.  
 Remove the rear turn signal light bulb and replace with a new one.  
 The installation sequence is the reverse of removal.

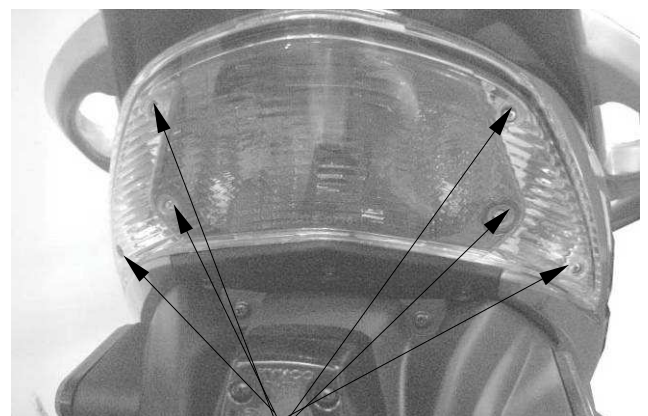

Nuts