

External Components

This chapter covers the location and servicing of the external components for the **KYMCO K-XCT 300i**.

- Exhaust System1-2~1-13
- Luggage Box.....1-14~1-16
- Seat.....1-17~1-19
- Rear Carrier1-20~1-22
- Body Cover1-23~1-32
- Windshield1-33~1-36
- Front Cover Meter1-37~1-38
- Side Molding A.....1-39~1-48
- Side Cover1-49~1-59
- Front Fender1-60~1-63
- Center Cover.....1-64~1-66
- Under Cover.....1-67~1-68
- Rear Meter Cover..... 1-69~1-72
- Floorboard1-73~1-78
- Leg Shield..... 1-79~1-83
- Handle Cover1-84~1-89
- Rear Tire Fender1-90~1-94
- Stands1-95~1-99

Exhaust System

General Instructions

- When removing frame covers, use care not to pull them by force because the cover joint claws may be damaged.
- Make sure to route cables and harnesses according to the Cable & Harness Routing.

Troubleshooting

Noisy exhaust muffler

- Damaged exhaust muffler
- Exhaust muffler joint air leaks

Lack of power

- Caved exhaust muffler
- Clogged exhaust muffler
- Exhaust muffler air leaks

Removal



1. External components > Exhaust System



Remove the two exhaust pipe joint nuts with a 12 mm deep well socket.



Remove the O2 sensor wire band.



Unplug the O2 sensor connector.



Remove the three muffer mounting bolts with a 14 mm socket.

1. External components > Exhaust System



Remove the exhaust system.



Remove the exhaust pipe gasket and discard it.

O₂ Sensor

Removal



Remove the O₂ sensor with a 17 mm wrench. Use care not to pinch the wires.

The O₂ sensor issues signal to ECU when the temperature is over 350°C while the engine is running.

Test the O₂ sensor at room temperature.

Use a digital multimeter set to ohms of resistance to inspect the O₂ sensor.

1. External components > Exhaust System



Measure the resistance between the white wire terminals of the O² sensor connector.

Replace the O² sensor if the reading is out of specification.

ITEM	SPECIFICATIONS
O ² heater sensor resistance (at 20°C/68°F)	6.7 - 9.5 Ω (engine warming condition)

Heat Shields



Remove the three muffler heat shield bolts with a 10 mm socket if needed.

1. External components > Exhaust System



To remove the four bolts to free the heat shield on the muffler.

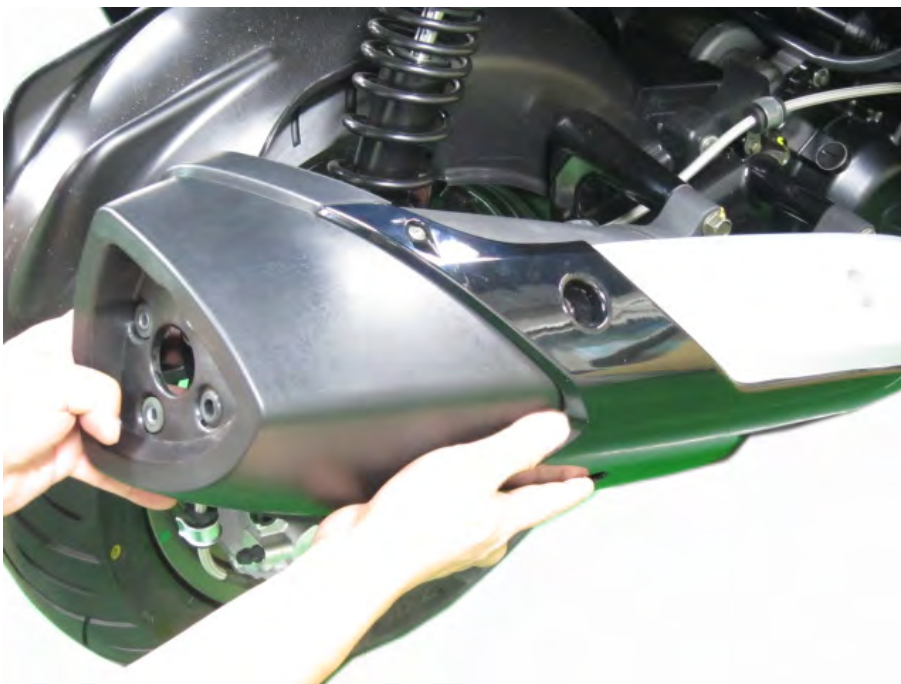

Remove the heat shield.

1. External components > Exhaust System

Installation

Heat Shields



Install the heat shields and tighten the bolts securely.

O² Sensor



Apply anti-seize compound to the threads of the O² sensor. Install the O² sensor and tighten it to specification with a 17 mm wrench. Use care not to pinch the wires.

Item	Torque	
	N-m	lb-ft
O ² Sensor	25	18

1. External components > Exhaust System

Exhaust System



Insert a new exhaust pipe gasket into the exhaust port.



Fit the exhaust system into place

1. External components > Exhaust System



Install the two exhaust pipe joint nuts with a 12 mm deep well socket. Do not tighten.



Install the three muffler mounting bolts and tighten to specification with a socket.

Item	Torque	
	N-m	kgf-m
Muffler Mounting Bolts	35	3.5

1. External components > Exhaust System



Tighten the two exhaust pipe joint nuts to specification with a 12 mm deep well socket.

Item	Torque	
	N-m	kgf-m
Exhaust Pipe Joint Nuts	20	2

If the exhaust pipe and muffler were separated installed the muffler clamp securely.

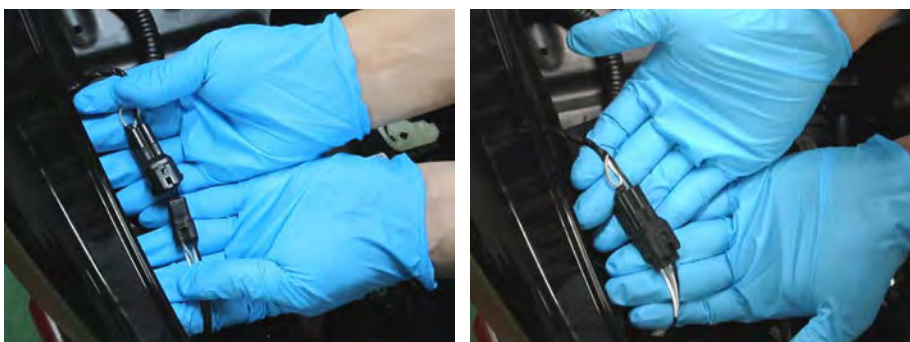

Plug in the O² sensor.

1. External components > Exhaust System



Install a new O² sensor clamp.

Luggage Box

Removal



Remove the four luggage bolts with a 10 mm socket.



Remove the two luggage nuts with a 10 mm socket.

1. External Components > Luggage Box



Lift up the luggage box to unplug the luggage box light connector.

Remove the luggage box.

Installation

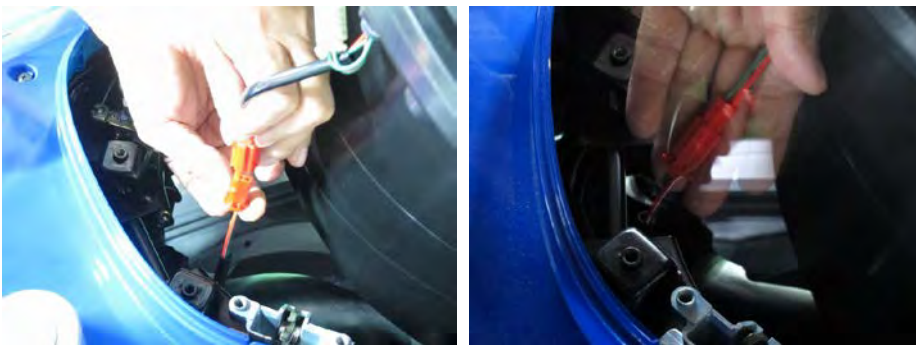

Plug in the luggage box light connector.

Install the luggage box.



1. External Components > Luggage Box



Install the four luggage bolts and tighten securely with a 10 mm socket.



Remove the two luggage nuts with a 10 mm socket.

Install the seat.

Seat

Removal



Insert the key and turn it counterclockwise.

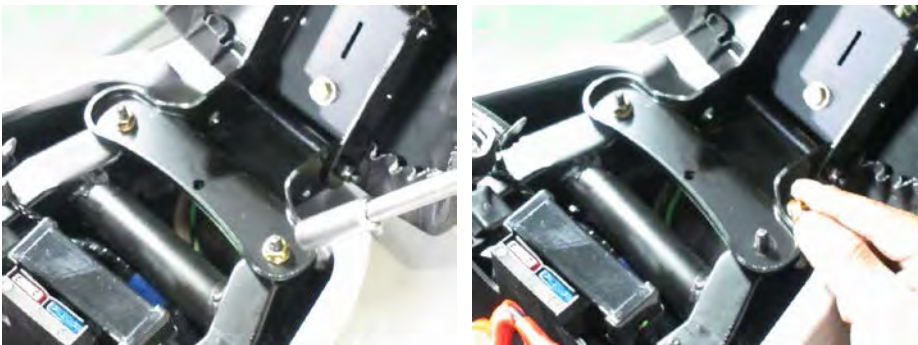

Remove the two seat hinge nuts with a 10 mm socket.

Seat Latch Cable



The seat latch cable runs from the ignition switch to the seat latches.

The cable must be adjusted periodically so that the latches will open correctly.

Open the seat.



Loosen the lock nuts and turn the adjusters as needed to adjust the seat latch cable operation.

There is one adjuster for each latch. Tighten the locknuts securely when finished.

Installation

Install the seat onto the hinge.



Install the two seat hinge nuts and tighten securely with a 10 mm socket.

Rear Carrier

Removal

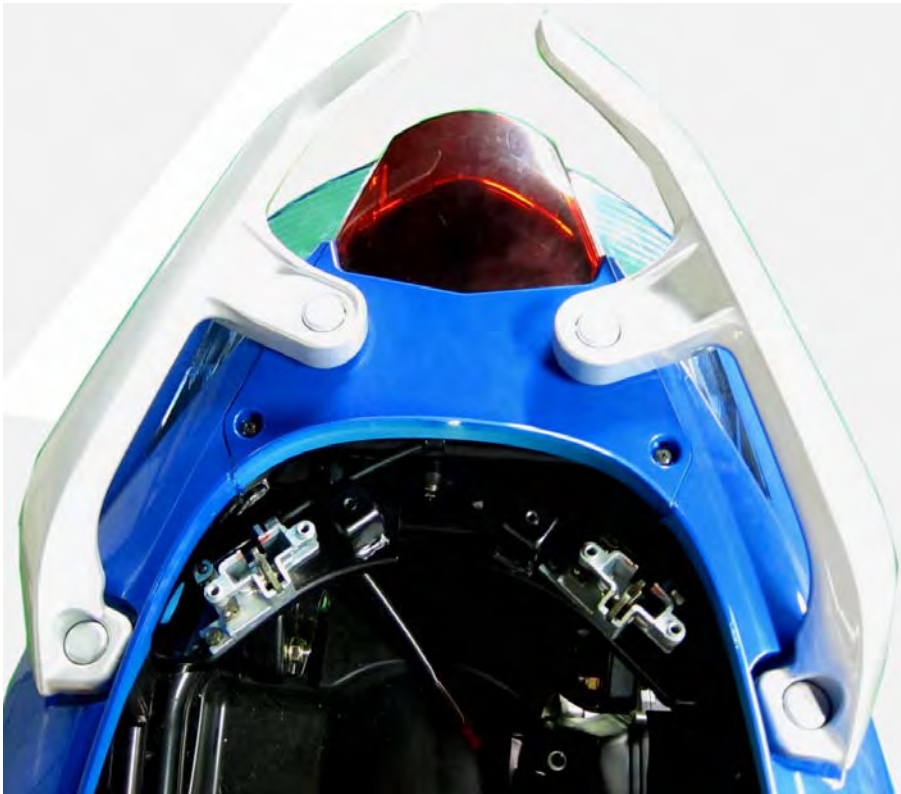

Pry off the carrier bolt covers with a small flat blade screwdriver, the arrow mark indicates the pry point.

1. External Components > Rear Carrier



Remove the four carrier bolts with a 6 mm Allen.



Remove the carrier each side.

Installation



Install the carrier.



Install the four carrier bolts on each side with a 6 mm Allen.



Push on the carrier bolt covers.

1. External Components > Body Cover

Body Cover

Removal

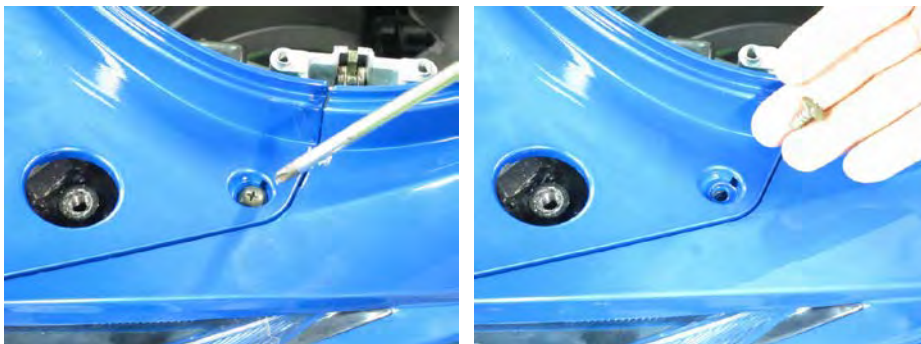

Remove the two rear center cover screws with a #2 Phillips.

1. External Components > Body Cover

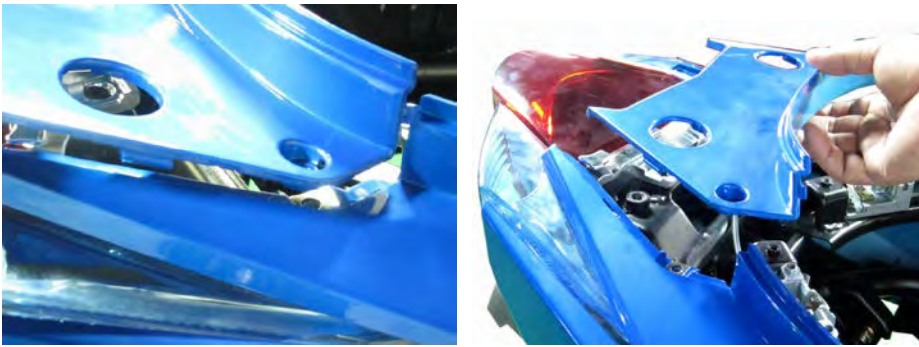

Carefully unhook the tabs on both side of the rear center cover.

Remove the rear center cover.



Remove the four lower body cover nuts with a 10 mm socket.

1. External Components > Body Cover

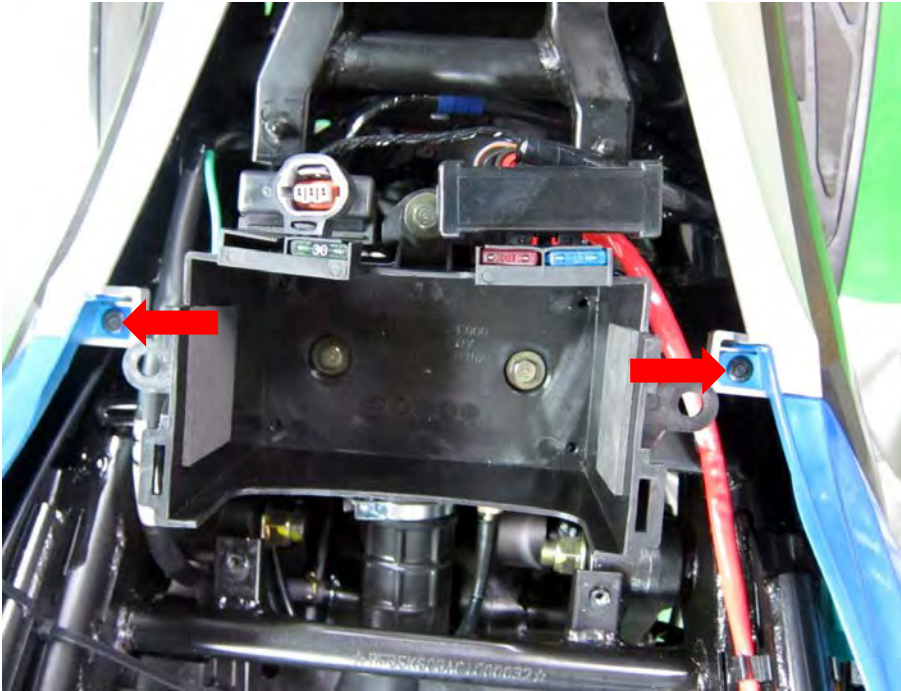

Remove the two plastic screws from the front of the body cover.



Carefully unhook the tabs on both sides of the body cover.

1. External Components > Body Cover



Unplug the taillight connector.



Remove the body cover.

1. External Components > Body Cover

Disassembly

Rear Center Molding

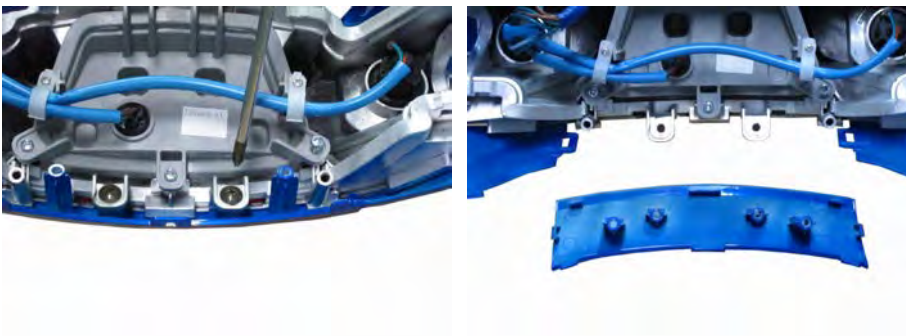
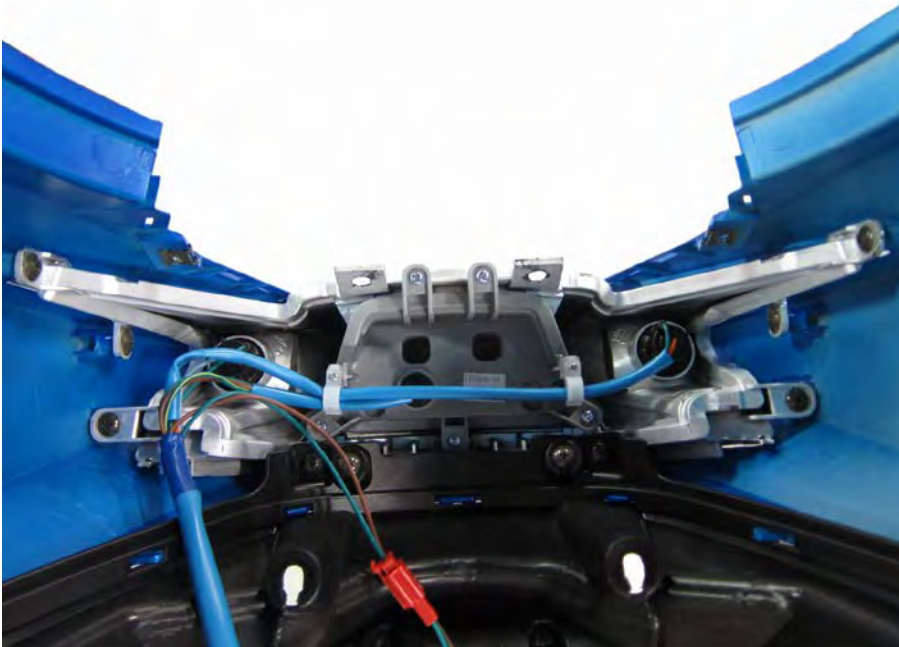

Remove the two Rear Center Molding screws with a #2 Phillips.
Remove the rear center molding.

1. External Components > Body Cover

Rear Fender

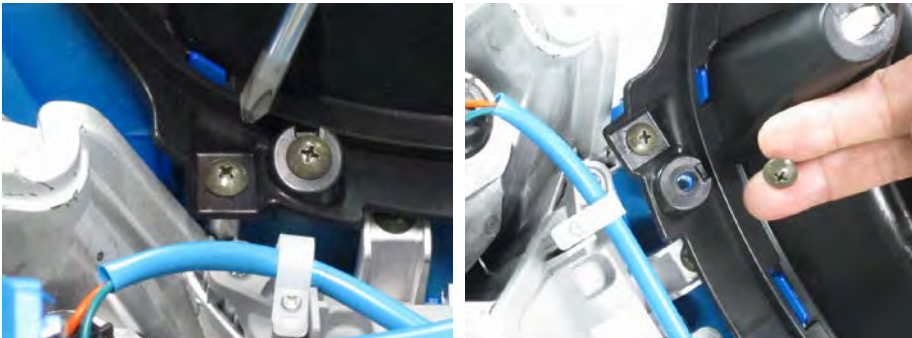

Remove the rear fender screws with a #2 Phillips.

Carefully unhook the tabs on both sides of the rear fender.



Remove the rear fender.

1. External Components > Body Cover

Taillight Assembly



Remove the eight taillight assembly screws with a #2 Phillips.

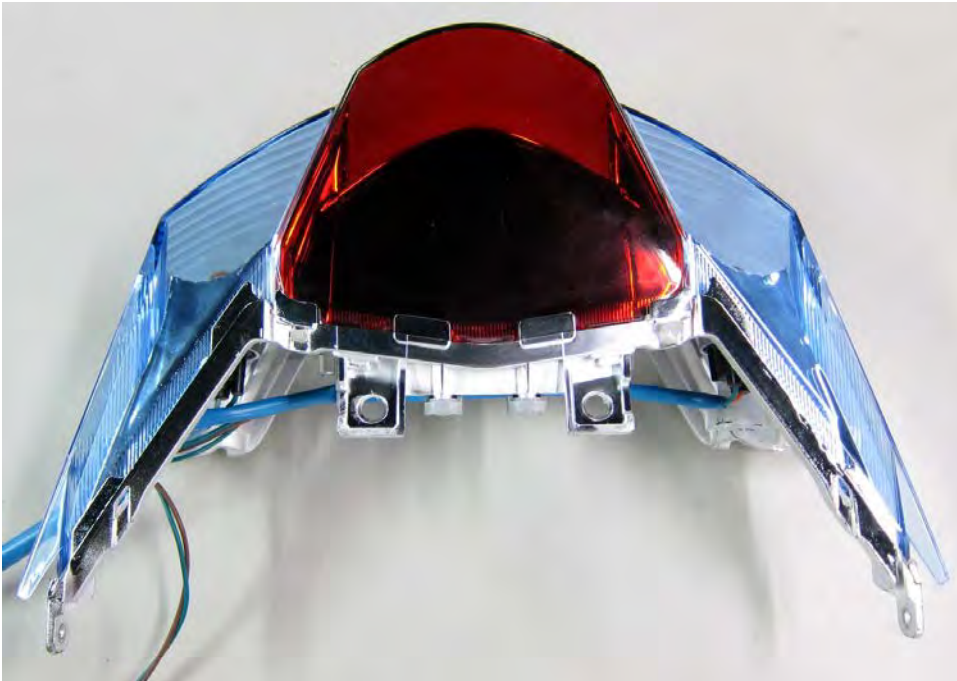

Unhook the taillight section and separate from the body cover.

Remove the taillight assembly

1. External Components > Body Cover

License Light

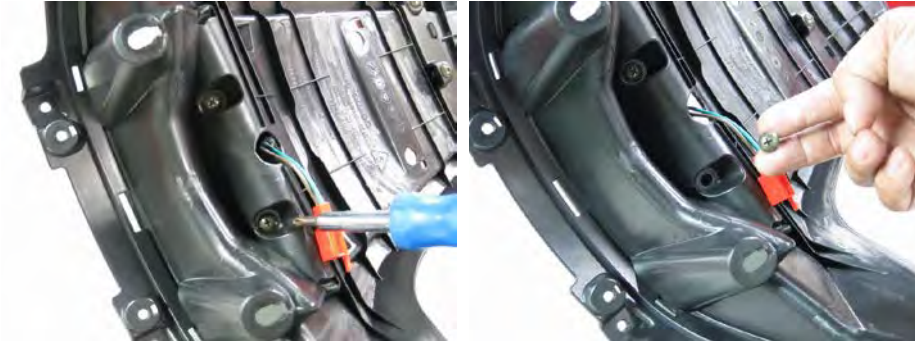

Remove the two license light assembly screws with a screwdriver.

Disconnect the connector license light.

Remove the license light assembly.

Installation



Fit the body cover into place.

1. External Components > Body Cover



Plug in the taillight connector.

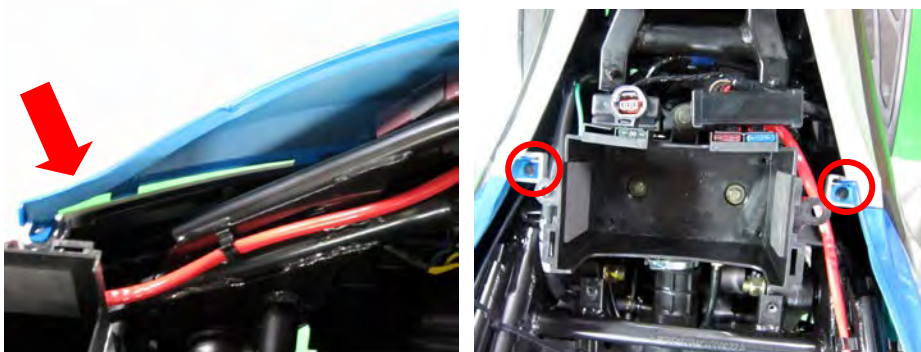

Carefully push the hooks into the corresponding tabs on both sides of the body cover.

Install the two screws on both sides of the body cover.



1. External Components > Body Cover



Install the four lower body cover nuts and tighten securely with a 10 mm socket.



Carefully install the rear center cover.



Install the two rear center cover screws and tighten securely with a #2 Phillips.

Windshield

Removal

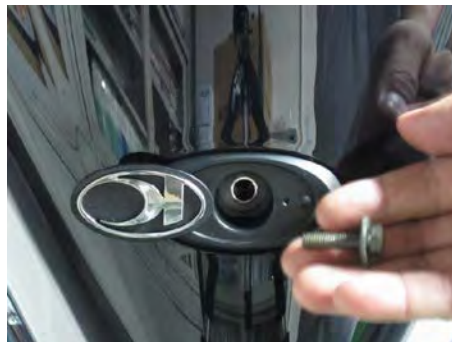

Remove the hidden bolt with a 10 mm socket.



Depress the head of the fastener center piece.
Pull out the fastener.

1. External Components > Windshield



Carefully pull out the front cover with a thinner driver on each side.



Lightly slap downward at the front cover on each side.

1. External Components > Windshield

Remove the front cover.



Remove the four bolts with a 12mm socket on each side.



Remove the windshield.

1. External Components > Windshield**Installation**

Install the windshield.



Install the four windshield bolts and tighten securely with a 12mm socket.

There are two bolts on each side.



Install the center cover carefully. Install the push pin

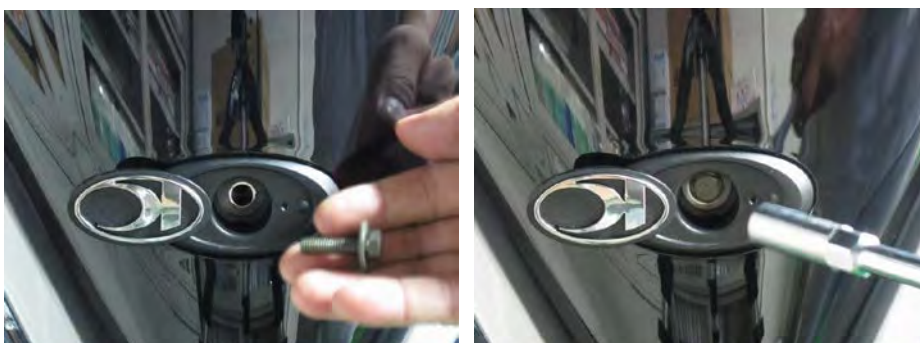

Install the hidden bolt and tighten securely with a 10 mm socket. Close the cover.

1. External Components > Front Cover Meter

Front Cover Meter

Removal



Remove the two front cover meter mounting nuts with a 10 mm socket



Remove the two screws mounting on the front cover meter on each side.



Remove the front cover meter

1. External Components > Front Cover Meter

Install



Install the front cover meter



Install the two screws mounting on the front cover meter on each side.



Install the two screws mounting on the front cover meter on each side.

Side Molding A

Removal



Remove the side molding mounting nuts with a 10 mm socket.



Carefully depress the front inner cover.

1. External Components > Side Molding A



Carefully pull out the side molding and leg shield with a thinner driver on each side.



Carefully pull off the side molding with hand.

1. External Components > Side Molding A



Carefully pull out the side molding and side skirt with hand on each side.



Unplug the headlight leads.

1. External Components > Side Molding A



Gently pull the side molding forward and free the tabs.

Disassembly

Light Assembly



1. External Components > Side Molding A

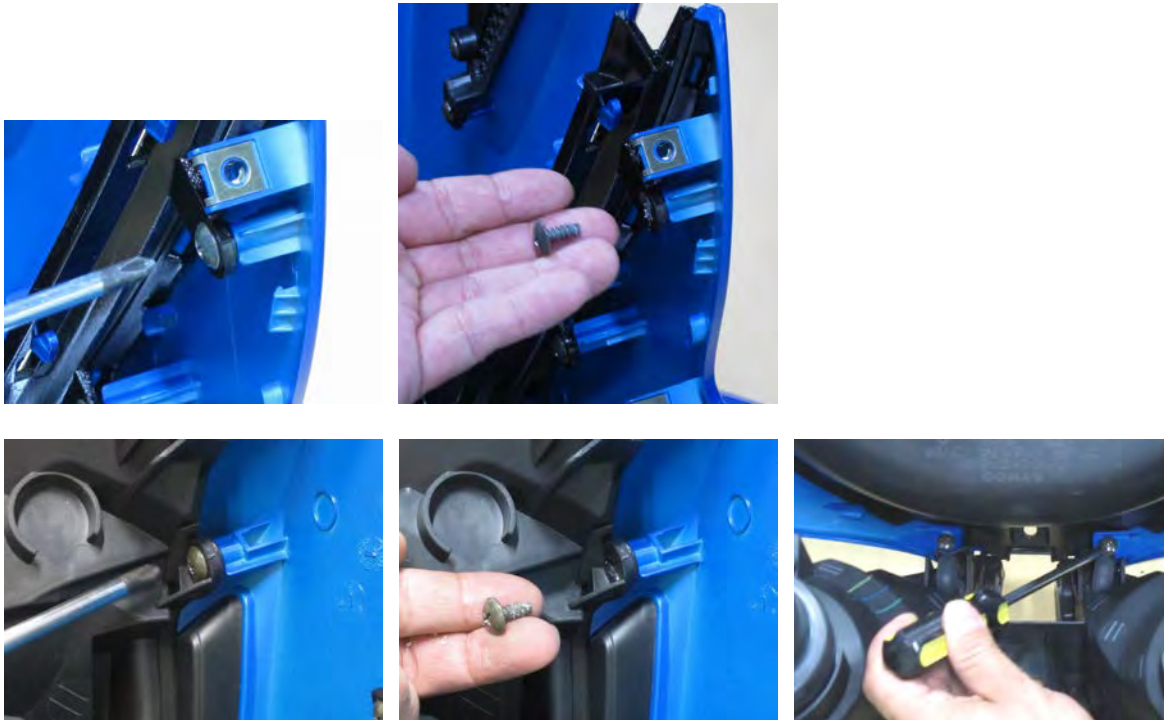

Remove the eight light assembly mounting screws with a #2 Phillips.



Separate the light assembly from the side molding A.

1. External Components > Side Molding A

Side Piece

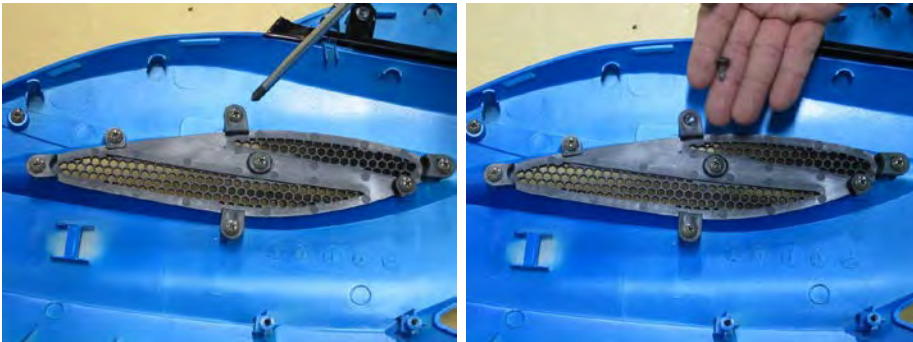

Remove the eight side piece screws with a #2 Phillips.

Assembly

Side Piece



Install the eight side piece screws and tighten securely with a #2 Phillips.

1. External Components > Side Molding A

Light Assembly



Install the eight light assembly mounting screws and tighten securely with a #2 Phillips.

1. External Components > Side Molding A



Install the headlight assembly on the side molding A.

Installation

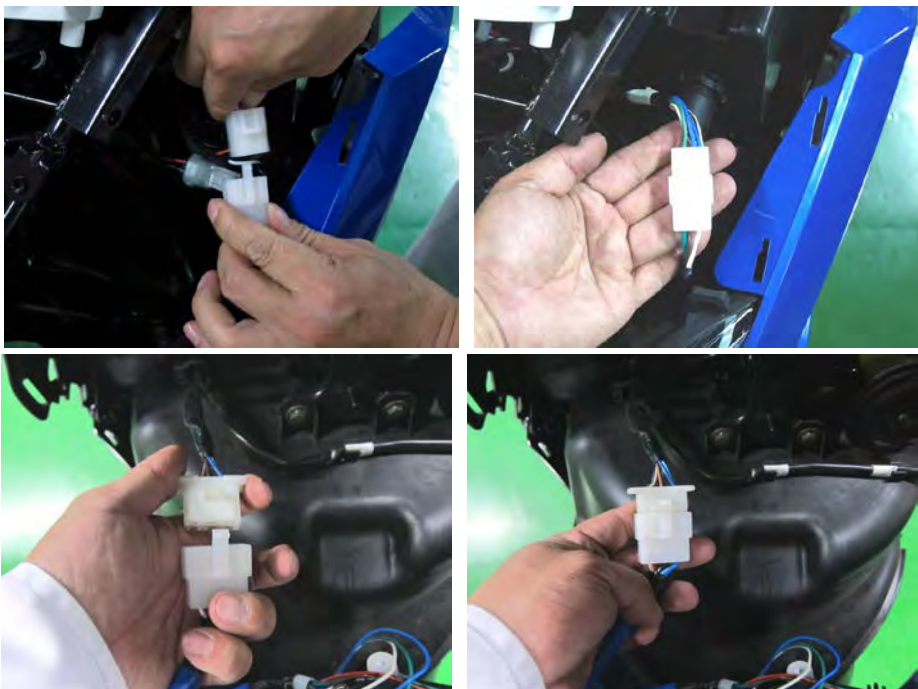

Plug in the headlight and turn signal leads.

1. ExternalComponents > Side Molding A



Align front cover tabs. Install the front cover.



Carefully Align the side molding and side skirt with hand on each side.

1. External Components > Side Molding A



Carefully Align the side molding and leg shield



Install the two front cover mounting nuts with a 10 mm socket.

1. External Components > Side Skirt

Side Skirt



Removal



Pull up the footboard rubber covers.

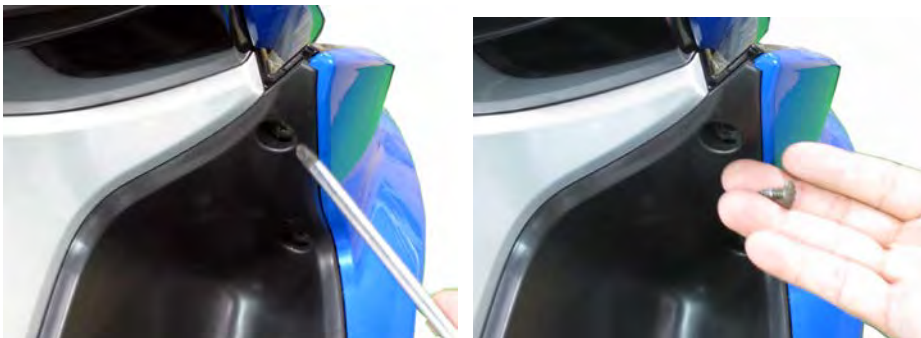

Remove the four screws mounting the footboard with a #2 Phillips.

1. External Components > Side Skirt

Remove the six leg shield mounting screws with a #2 Phillips.

There are three screws on each side.

1. External Components > Side Skirt

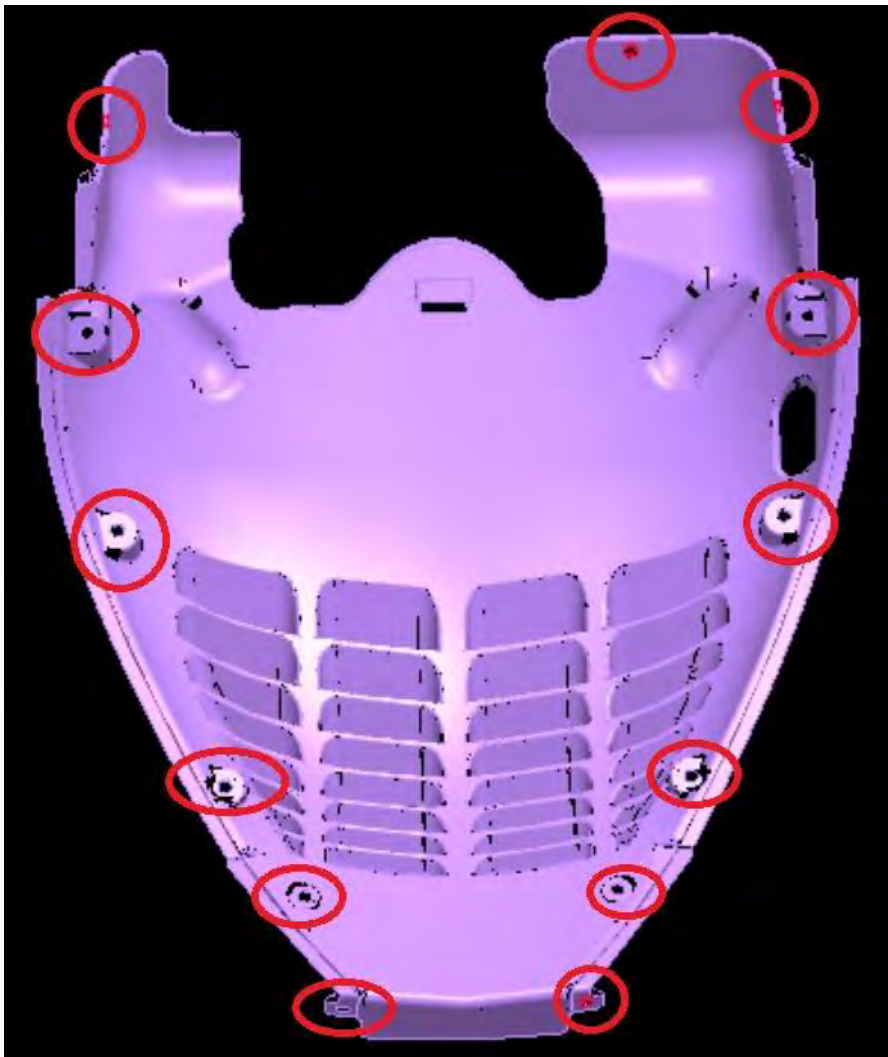

Remove the six lower fairing push pins on each side including the undercover.

1. External Components > Side Skirt

Remove the left lower bolt under the side skirt with a 10mm socket.



Gently separate the floorboard from the side skirt. Carefully free the tabs.

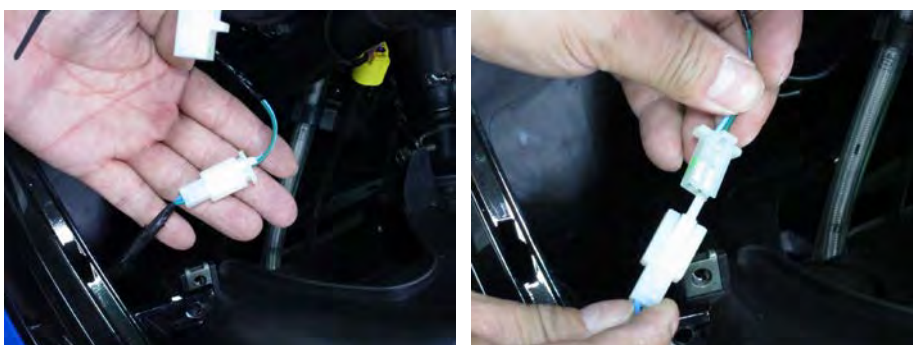

Remove the cover side skirt after the turn signal leads removed.

1. External Components > Side Skirt



Remove the two cover side skirt mounting screws with a #2 Phillips.

Disassembly

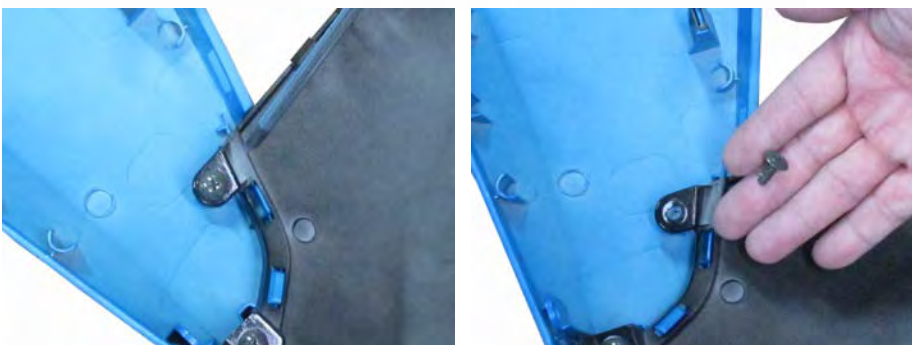

Remove the two screws from the side board A with a #2 Phillips.

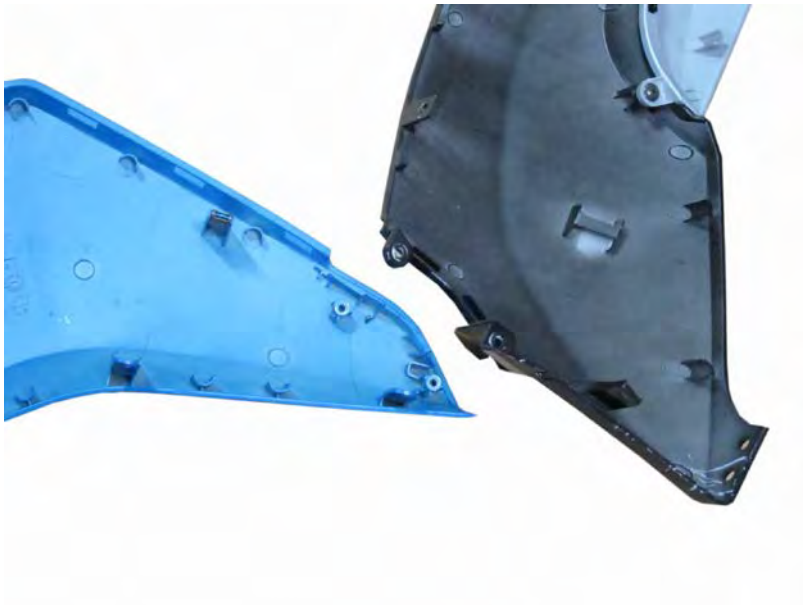
1. External Components > Side Skirt

Separate the Side skirt and side board A.



Remove the three cover side skirt mounting screws with a #2 Phillips.



Carefully pull out the cover side skirt from side skirt.

1. External Components > Side Skirt



Remove the three winker assembly mounting screws with a #2 Phillips.



Remove the winker assembly from the cover side skirt.

1. External Components > Side Skirt**Assembly****Winker Assembly**

Install the three winker assembly mounting screws with a #2 Phillips.



Install the three screws onto the cover side skirt.

1. External Components > Side Skirt
Installation

Install the side skirt. Carefully fit the upper tabs of the side board A into the floorboard. Install the side board A while aligning the tabs.



Install the four screws under the footboard rubber cover with a #2 Phillips on each side. Tighten them securely.



Install the left lower bolt under the footboard rubber cover with a 10mm socket.

1. External Components > Side Skirt



Install the footboard rubber covers.



Install the two cover side skirt mounting screws with a #2 Phillips.



Connect the turn signal leads removed.

1. External Components > Side Skirt



Install the six leg shield mounting screws with a #2 Phillips.

There are three screws on each side.

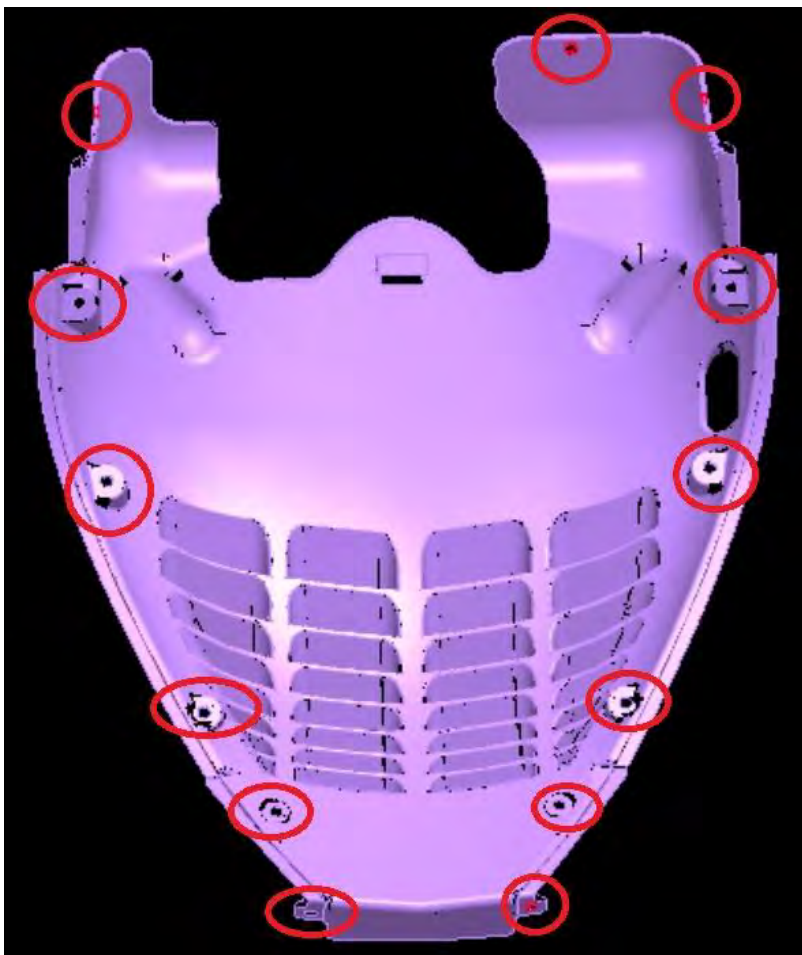

Install the six lower fairing push pins on each side including the undercover.

Front Fender

Removal



Remove the left forward front fender bolt with a 6 mm Allen.



Remove the left rear fender bolt with a 10 mm socket.

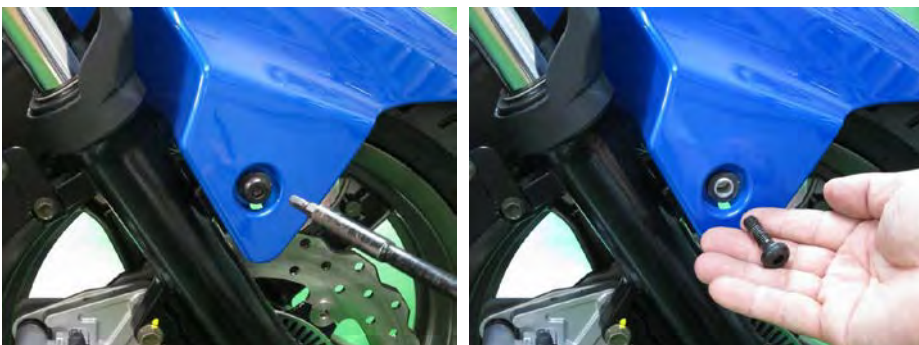

Remove the right forward front fender bolt with a 6 mm Allen.

1. External Components > Front Fender

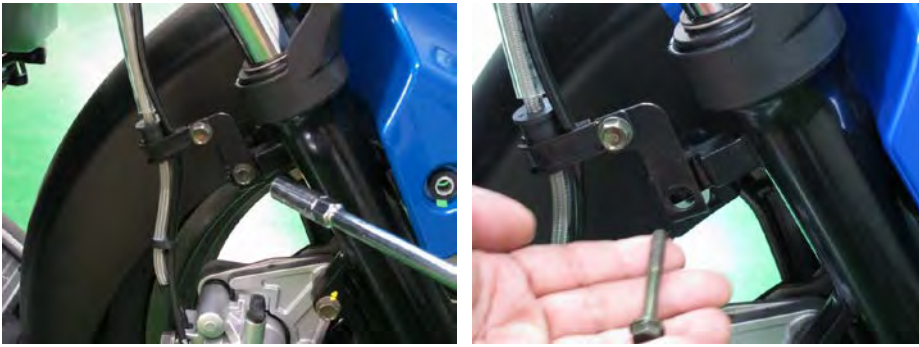

Remove the right rear fender bolt with a 10 mm socket.



Remove the front fender from the forks.

1. External Components > Front Fender

Installation



Guide the fender between the forks.



Install the right rear fender bolt with a 10 mm socket.

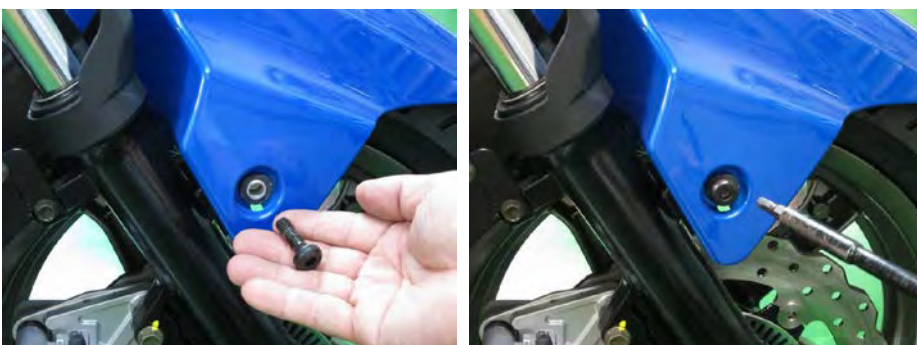

Install the right forward front fender bolt with a 6 mm Allen.

1. External Components > Front Fender



Install the left rear fender bolt with a 10 mm socket.

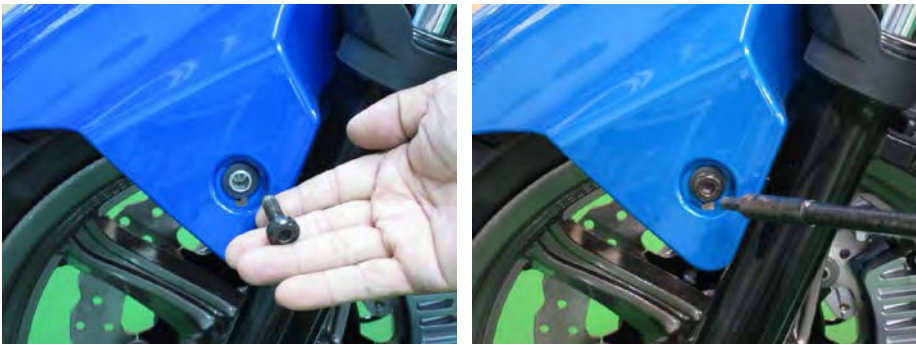

Install the left forward front fender bolt with a 6 mm Allen.

1. External Components > Center Cover

Center Cover

Removal

Note: Do not force the cover and damage the claws.

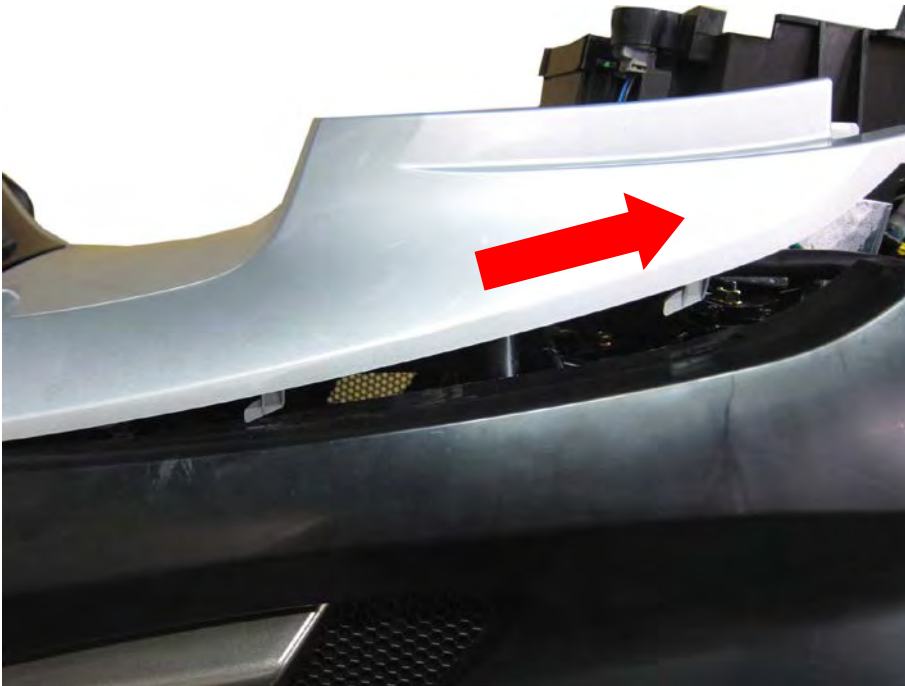

Pull the center cover back and up to free the claws and then move the cover backward to free it from the scooter.

1. External Components > Center Cover



Remove the center cover.

Installation



Place the center cover on the scooter.

1. External Components > Center Cover

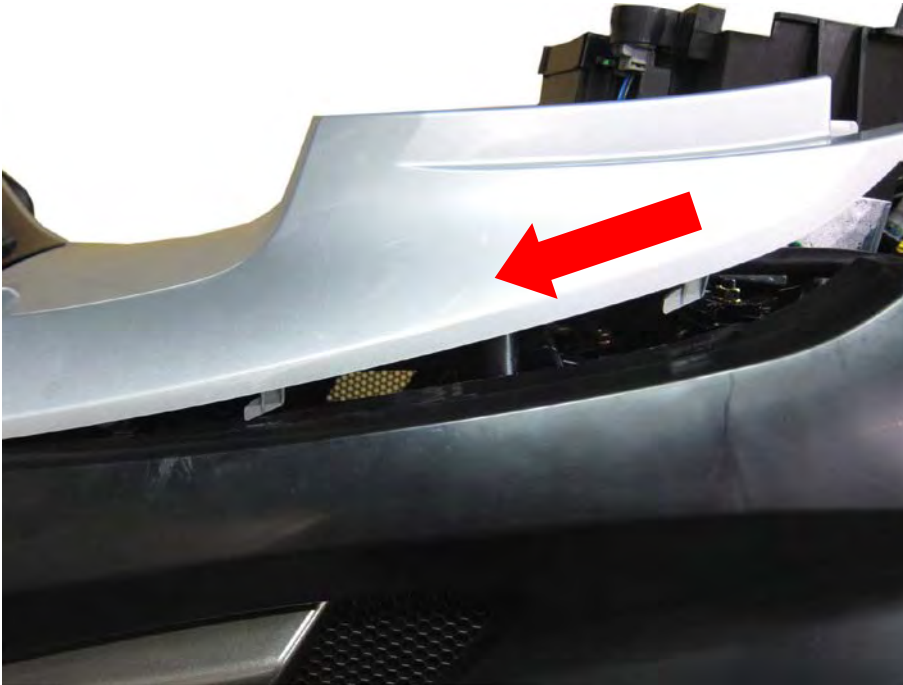

Push the cover down and forward to lock in the claws.

1. External Components > Under Cover

Under Cover

Removal

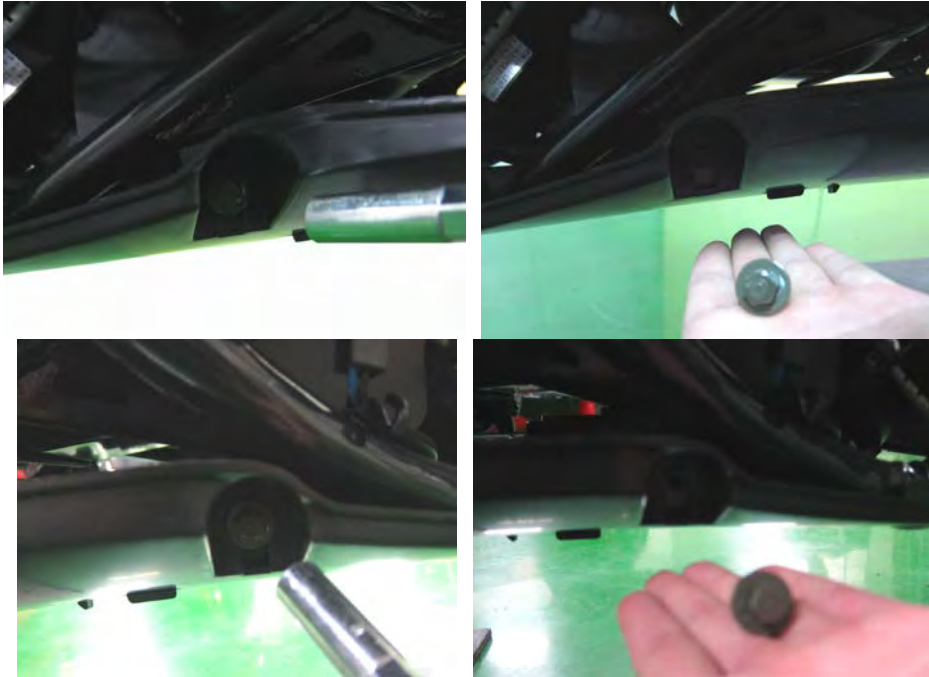

Remove the two cover bolts mounting the under cover each side with a 10 mm socket.



Remove the under cover.

Installation



Install the under cover.



Install the two under cover bolts on the each side and tighten securely with a 10 mm socket.

1. External Components > Rear Meter Cover

Rear Meter Cover

Removal



Remove the two push pins below the handlebar. Depress the head of the fastener center piece. Pull out the fastener.



Remove the bolt attaching the rear meter cover on the left with a 10 mm socket.



Remove the bolt attaching the speedometer cover on the right with a 10 mm socket.

1. External Components > Rear Meter Cover

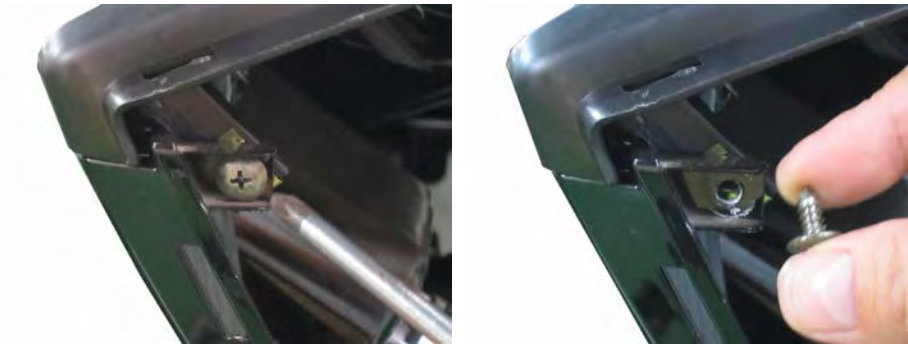

Remove two screws mounting the rear meter cover on both sides with a #2 Phillips.



Remove the connector speedometer assembly.



Remove the speedometer assembly

1. External Components > Rear Meter Cover

Installation



Install the speedometer assembly

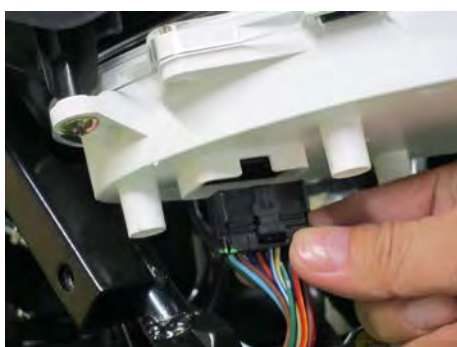

Install the connector speedometer assembly.



Install two screws mounting the speedometer cover on both sides with a #2 Phillips.

1. External Components > Rear Meter Cover

Install the bolt attaching the rear meter cover on the left with a 10 mm socket.



Install the bolt attaching the speedometer cover on the right with a 10 mm socket.



Install the two push pins below the handlebar. Depress the head of the fastener center piece. Pull out the fastener.

Note: To prevent the pawl from damage, insert the fastener all the way into the installation hole.

1. External Components > Floorboard

Floorboard

Removal



Remove the two bolts mounting the floorboard on the left side with a 10 mm socket.



Remove the two bolts mounting the floorboard on the right side with a 10 mm socket.

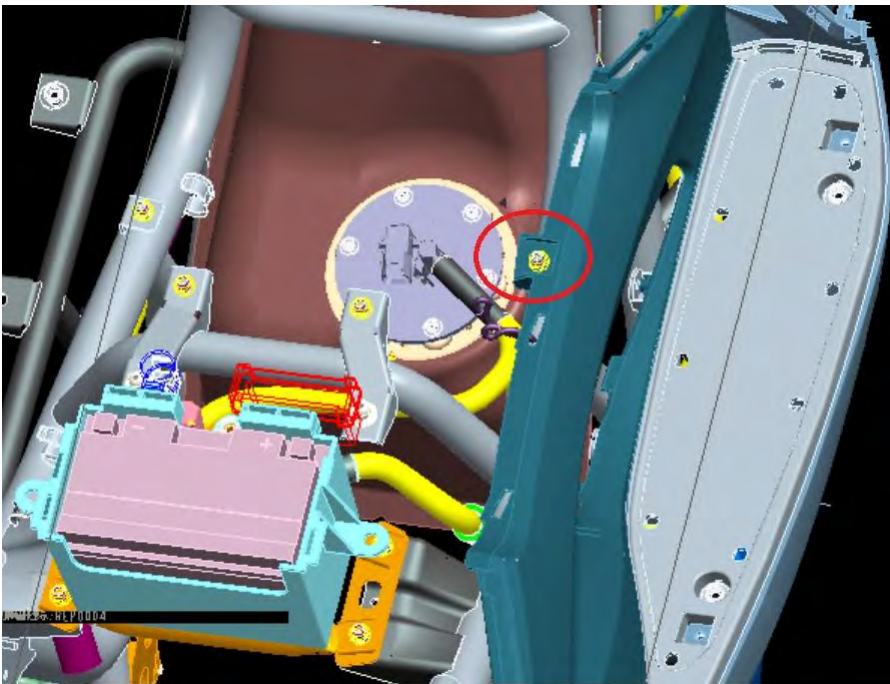

Remove the two bolts mounting the side board A on each side with a 10 mm socket.

1. External Components > Floorboard

Remove the two nuts mounting the side board A on each side with a 10 mm socket.

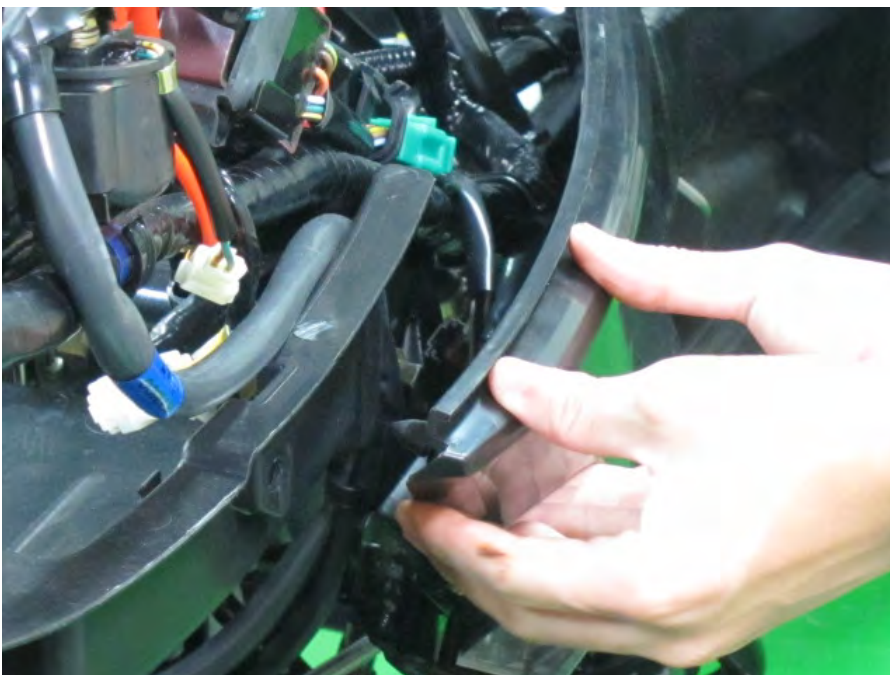

Carefully unhook the tabs on both sides of the side board A.

1. External Components > Floorboard



Remove the floorboard on each side.

Disassembly



Remove the four screws mounting the side board A

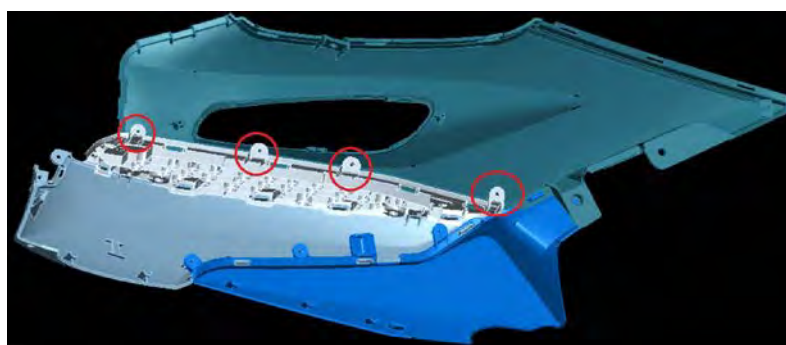

Separate the floorboard from side board A.

1. External Components > Floorboard

Disassembly



Install the four screws mounting the side board A

Installation



Install the floorboard on each side.

1. External Components > Floorboard

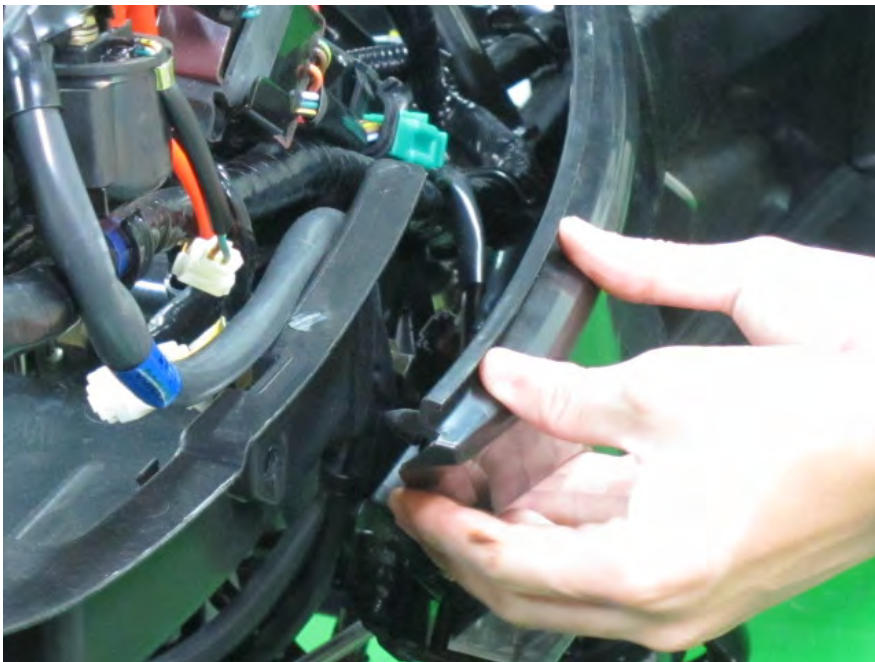

Carefully install the tabs on both sides of the side board A.

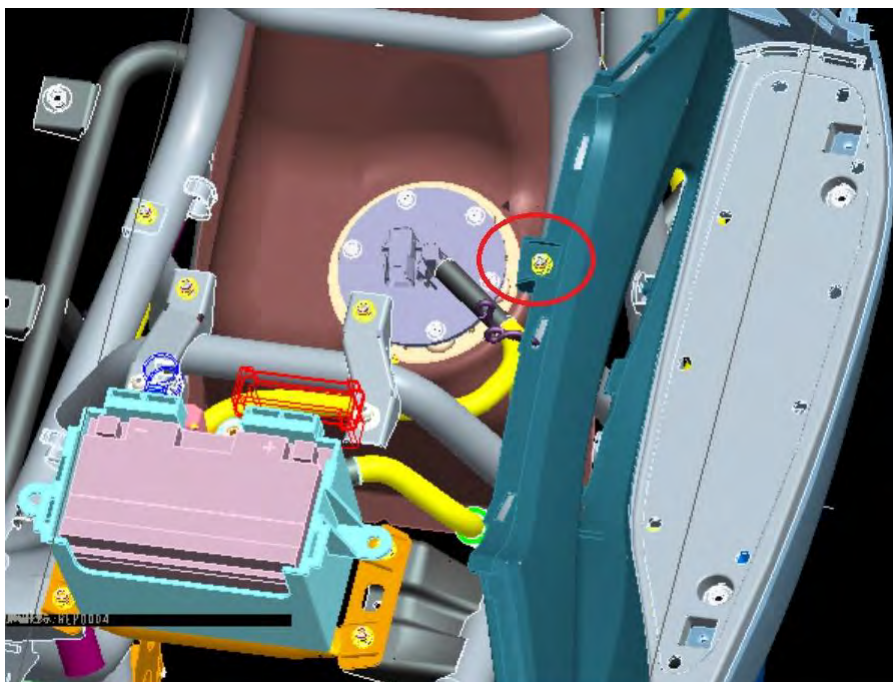

Install the two nuts mounting the side board A on each side with a 10 mm socket.

1. External Components > Floorboard

Install the four bolt mounting the floorboard on each side with a 10 mm socket.

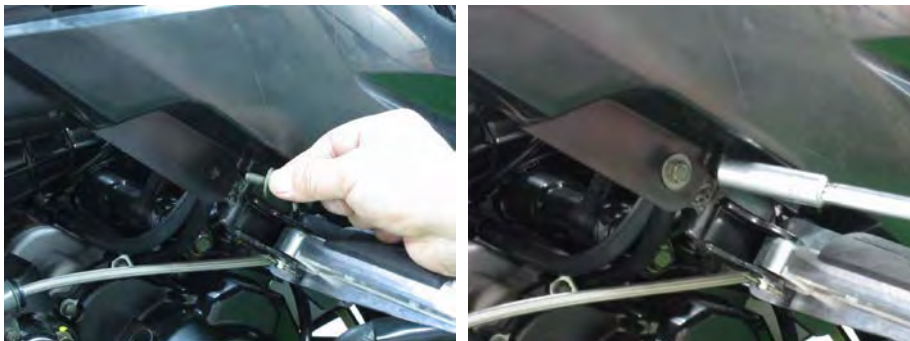

Install the two bolt mounting the side board A on each side with a 10 mm socket.

1. External Components > Leg Shield

Leg Shield

Removal

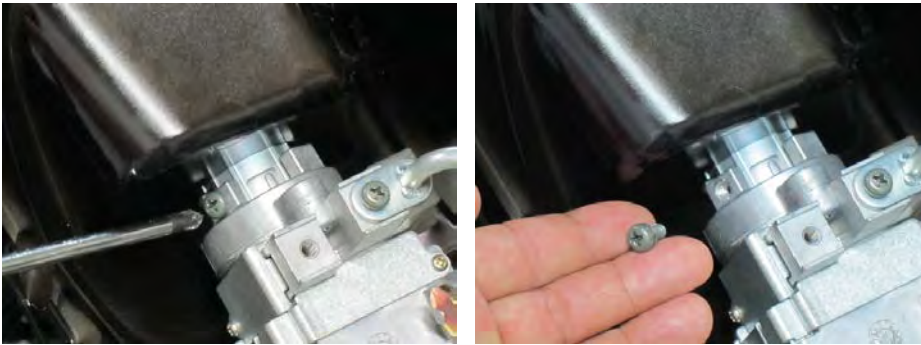

Remove the screw mounting the collar ignition switch with a #2 Phillips.



Take off the collar.



Open the fuel cap panel.

1. External Components > Leg Shield



Remove the fuel cap with the key.



Remove the Lid fuel cap maint.

1. External Components > Leg Shield



Remove the gas cap overflow pad.



Lift off the leg shield.

1. External Components > Leg Shield

Installation



Install the leg shield.



Align the pin hole of the body frame.

1. External Components > Leg Shield



Install the gas cap overflow pad and the Lid fuel cap maint.

Handlebar Covers

Removal

Upper Cover



Remove the four cover screws with a #2 Phillips.

1. External Components > Handlebar Cover



Carefully free the tabs and remove the upper handlebar cover.

Lower Cover



Route the throttle cables out of the handlebar cover.

1. External Components > Handlebar Cover

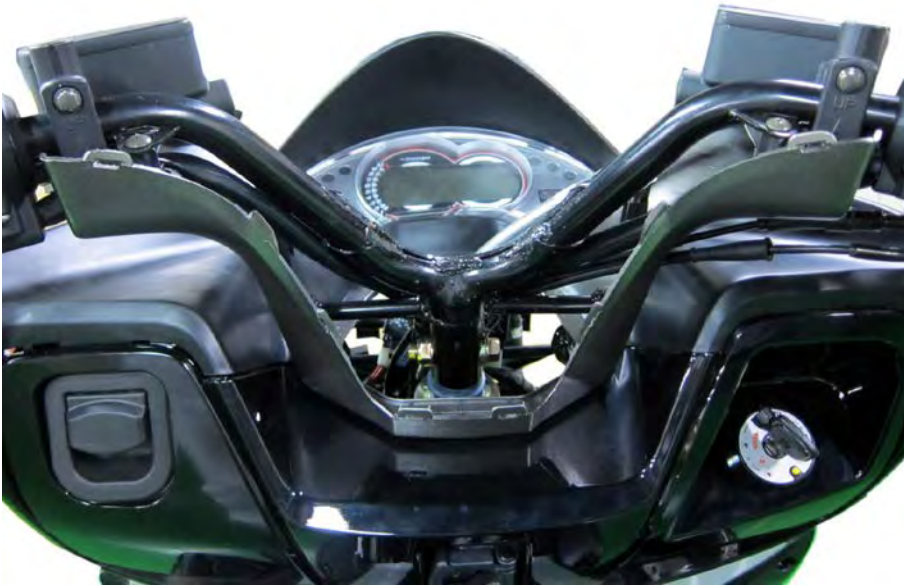

Remove the two handle lower cover screws with a #2 Phillips.

1. External Components > Handlebar Cover



Remove the lower cover.

Installation



Place the lower cover onto the handlebar.

1. External Components > Handlebar Cover



Route the throttle cables into the handlebar cover.



Carefully install the upper handlebar cover.

1. External Components > Handlebar Cover



Remove the four cover screws with a #2 Phillips.

Rear Tire Fender

Removal



Remove the two fender mounting bolts with a 8 mm socket on the right side.

1. External Components > Rear Tire Fender

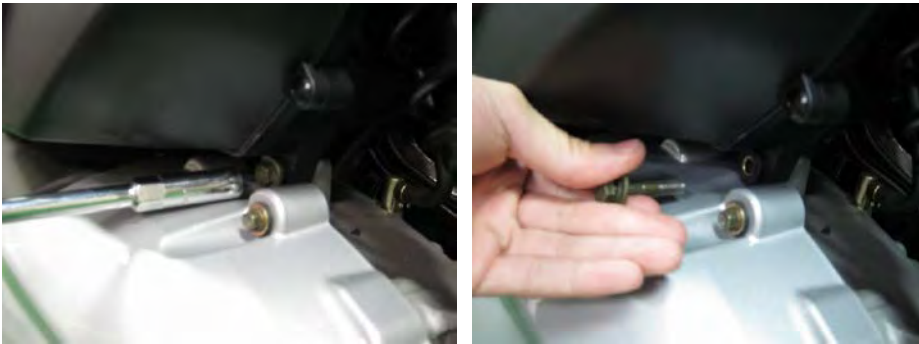

Remove the two airbox mounting bolts with a 8mm socket.



Remove the connecting tube screw with a 2# Phillips.



Remove the fender mounting bolt with a 8 mm socket on the left side.

1. External Components > Rear Tire Fender



Remove the rear fender.

Installation



Install the rear fender.

1. External Components > Rear Tire Fender



Install the fender mounting bolt with a 8 mm socket on the left side.



Install the connecting tube screw with a 2# Phillips.

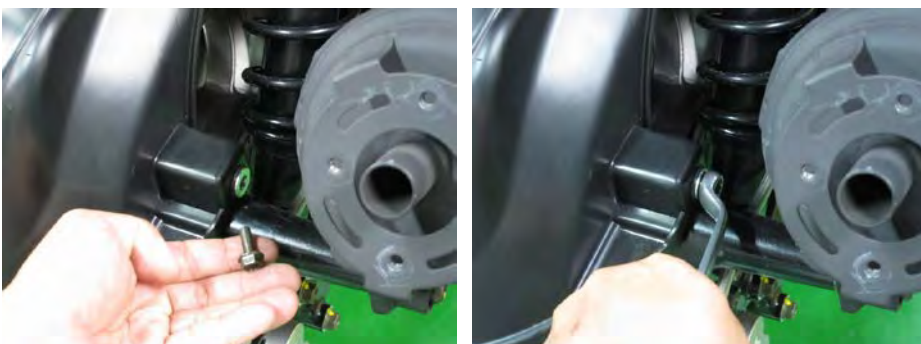

Install the two fender mounting bolts with a 8 mm socket on the right side.

1. External Components > Rear Tire Fender



Install the two airbox mounting bolts with a 8mm socket.
Install the airbox.

Stands

Side stand

Removal



Unplug the three-pin side stand switch connector.



Remove the side stand spring with a spring puller.

1. External Components > Stands



Remove the side stand bolt, switch, and side stand.

Installation



Install the side stand, switch, and bolt. Make sure to fit the switch into place correctly. Tighten the bolt securely.

1. External Components > Stands



Install the side stand spring with a spring puller.



Plug in the side stand switch connector.

Center Stand

Removal



Remove the center stand spring with a spring puller.



Remove the two center stand nuts and bolts. Remove the center stand.

1. External Components > Stands

Installation



Install the nuts and bolts. Tighten them securely.



Install the center stand spring with a spring puller.

Maintenance Schedule

Perform the pre-ride inspection (Owner's Manual) at each scheduled maintenance period. This interval should be judged by odometer reading or months, whichever comes first.

Maintenance schedule legend

I: INSPECT AND CLEAN, ADJUST, LUBRICATE OR
REPLACE IF NECESSARY

C: CLEAN

A: ADJUST

R: REPLACE

L: LUBRICATE

I: INSPECTION

The maintenance schedule specifies the maintenance required to keep your K-XCT 300i scooter in peak operating condition. Maintenance work should be performed in accordance with KYMCO standards and specifications by properly trained and equipped technicians. Your KYMCO dealer meets all of these requirements.

* Should be serviced by your KYMCO dealer, unless you have the proper tools, service data and are technically qualified.

** In the interest of safety, we recommend these items be serviced only by your KYMCO dealer. KYMCO recommends that your KYMCO dealer road test your scooter after each periodic maintenance service is completed.

2. Periodic Maintenance > Periodic Maintenance Chart

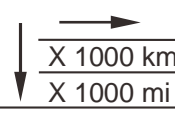
ITEM		FREQUENCY	WHICHEVER COMES FIRST	ODOMETER READING							
											
		X 1000 km	1	5	10	15	20	25	30	REFER TO PAGE	
		X 1000 mi	0.6	3	6	9	12	15	18		
		MONTH	1	6	12	18	24	30	36		
*	AIR CLEANER			R	R	R	R	R	R	33	
	SPARK PLUGS			I	R	I	R	I	R	34	
*	THROTTLE OPERATION			I	I	I	I	I	I	33	
*	VALVE CLEARANCE			I	A	I	A	I	A	-	
*	FUEL LINE				I		I		I	-	
	CRANKCASE BREATHER			C	C	C	C	C	C	-	
*	ENGINE OIL			R	R	R	R	R	R	29	
*	ENGINE OIL SCREEN				C	R	C	R	C	-	
*	ENGINE OIL FILTER			R	R	R	R	R	R	-	
*	ENGINE IDLE SPEED					I		I		-	
*	TRANSMISSION FLUID			R	R	R	R	R	R	32	
*	DRIVE BELT				I	I	I	R	I	-	

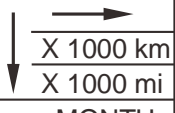
ITEM		FREQUENCY	WHICHEVER COMES FIRST	ODOMETER READING							
											
		X 1000 km	1	5	10	15	20	25	30	REFER TO PAGE	
		X 1000 mi	0.6	3	6	9	12	15	18		
		MONTH	1	6	12	18	24	30	36		
**	CLUTCH SHOE WEAR				I		I		I	-	
	BRAKE FLUID				I	R	I	R	I	38	
	BRAKE PAD WEAR				I	I	I	I	I	40	
	BRAKE SYSTEM				I	I	I	I	I	-	
*	BRAKE LIGHT SWITCH				I	I	I	I	I	-	
**	STEERING BEARINGS				I	I	I	I	I	-	
*	HEADLIGHT AIM				I	I	I	I	I	-	
*	NUTS, BOLTS, FASTENERS				I	I	I	I	I	-	
**	WHEELS/TIRES				I	I	I	I	I	42	
**	COOLANT				I	R	I	R	I	35	

Air Filter Servicing

SAFETY FIRST: Protective gloves and eyewear are recommended at this point.

Replace the air filter according to the Maintenance Schedule, and more often in exceptionally rainy or dusty areas.

Removal



Remove the 8 air filter cover screws with a #2 Phillips screwdriver.

2. Periodic Maintenance > Air Filter Servicing



Remove the air filter cover.



Remove the 7 air filter bolts with an 8 mm socket or a #2 Phillips screwdriver.



Remove the air filter from the airbox. Discard the air filter in favor of a new item.

Caution:

- The air cleaner element has a viscous type paper element. Do not clean it with compressed air.
- Be sure to install the air cleaner element and cover securely.

Installation



Fit the new air filter into place.



Insert the 7 air filter bolts. Tighten the air filter bolts securely with an 8 mm socket or a #2 Phillips screwdriver.



Install the air filter cover.



Install the 8 air filter cover screws and tighten them securely with a #2 Phillips screwdriver.

Brake Fluid

The KYMCO K-XCT 300i uses DOT 4 brake fluid that should be inspected after 3,000 mi (5,000 km) of use. It should be flushed and bled every 12 months, 6,000 mi (10,000 km), whenever the brakes feel spongy, or if the brake system has been taken apart and rebuilt. Always use fresh brake fluid from a tightly sealed container.

SAFETY FIRST: Protective gloves and eyewear are recommended at this point.

Warning: Brake fluid is very caustic and can damage paint, chrome and plastic. Wipe up any spills immediately.

Inspection



Turn the handlebars until the top of the master cylinder reservoir is level with the ground. Do this for both master cylinder reservoirs and check the level of brake fluid.

2. Periodic Maintenance > Brake Fluid

Draining

The brake bleeding process is the same for the front and rear brakes.



Remove the two master cylinder cover screws with a #2 Phillips head screwdriver.



Remove the master cylinder cover, plastic piece and rubber diaphragm. Clean and inspect the rubber diaphragm for tears or other damage. Replace as necessary.

2. Periodic Maintenance > Brake Fluid

Pull off the rubber cap over the bleeder valve and crack open the bleeder valve on the brake caliper using an 8 mm wrench. This valve is usually very tight so use a box end wrench or a 6 point socket and ratchet to prevent rounding off the head. Snug the bleeder valve back down.



Open the valve and remove the old brake fluid with a Mighty -Vac or a similar device.

2. Periodic Maintenance > Brake Fluid

Bleeding



Place a length of 6 mm inside diameter clear hose on the bleeder valve and place the other end in a suitable container. A spare battery vent hose works well for this job.



Fill the brake fluid with the proper type from a fresh, newly opened container.

2. Periodic Maintenance > Brake Fluid

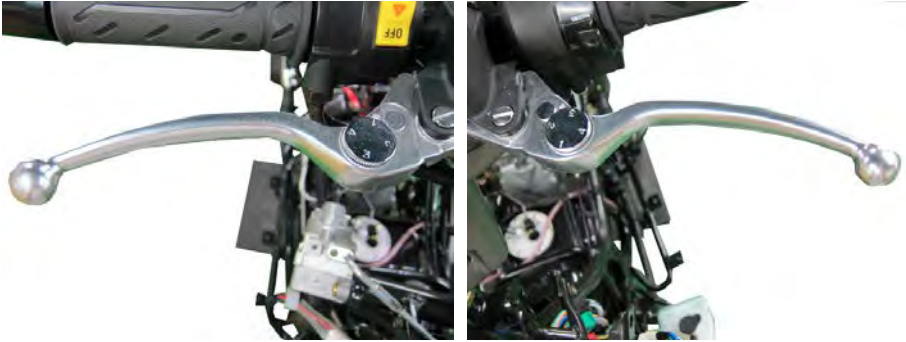

Pump the brake lever several times and hold the lever in. While holding the lever in, crack open the bleeder valve. The front brake lever will travel all the way to the grip and brake fluid and/or air will come out of the bleeder valve into the 6 mm hose. Tighten the bleeder valve before releasing the front brake lever. Pump the lever several times again and repeat the process.

Be certain to check the master cylinder reservoir occasionally to make sure the reservoir doesn't run dry. Add more brake fluid as necessary. Continue this process until clean brake fluid comes out of the bleeder valve and there are no air bubbles. The brake lever should feel firm.

Tighten the bleeder valve to specification and push its rubber cover over the nipple.

(Air Bleeder Valve Torque: 7.5 N-m or 5.5 lb-ft)



Make sure the reservoir has the proper amount of fluid.

2. Periodic Maintenance > Brake Fluid



Place the rubber diaphragm, plastic piece and cover over the reservoir.



Thread in the reservoir cover screws and tighten them securely with a #2 Phillips screwdriver.

Engine Compression Test

SAFETY FIRST: Protective gloves and eyewear are recommended at this point.

Remove the seat. See the Seat topic for more information.

Remove the luggage box. See the Luggage Box topic for more information.

Before testing the compression make sure the cylinder head bolts are tightened securely and the valve clearance is specification. See the Cylinder Head and Valve Clearance topics for more information.

Remove the spark plug. See the Spark Plug topic for more information.



Thread a compression tester into the spark plug hole hand tight. Hold the throttle all the way open. Crank the engine with the starter motor until the needle on the gauge stops rising. Do not crank the engine more than a few seconds.

Cylinder compression	$16 \pm 2 \text{ kg/cm}^2$	$228 \pm 28.4 \text{ psi}$
----------------------	----------------------------	----------------------------

Low compression is an indication of excessive engine wear, possibly worn rings or poorly sealing valves, or maybe a tight valve with not enough valve clearance. High compression is possibly an indication of excessive carbon buildup on the piston or performance modifications.

Install the spark plug.

Engine Oil

SAFETY FIRST: Protective gloves and eyewear are recommended at this point.

Caution: Hot engine oil can burn. Avoid letting used motor oil contact exposed skin.

TROUBLESHOOTING

Oil level too low

1. Natural oil consumption
2. Oil leaks
3. Worn or poorly installed piston rings
4. Worn valve guide or seal

Poor lubrication pressure

1. Oil level too low
2. Clogged filter or oil passages
3. No use the specified oil

Oil Specifications

Use a fully synthetic quality 4-stroke engine oil to ensure longer service life of the scooter. Only use oils that have a SJ rating above per the API service classification.

Engine oil viscosity : SAE 5W-50

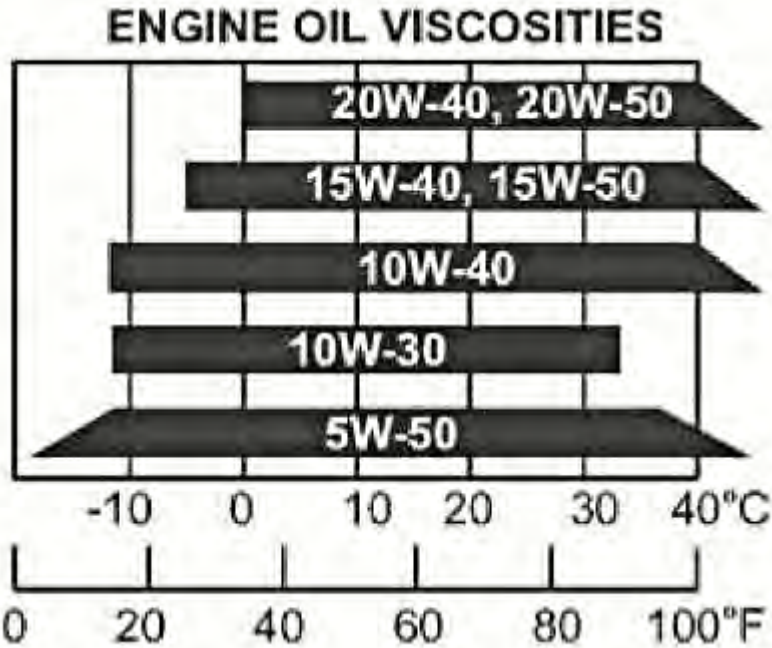

If these viscosities are not available, select an alternative engine oil according to the chart shown above.

Engine oil capacity	
At disassembly	1.5 Liter
At change	1.3 Liter

Inspection

Oil Level

Check the engine oil level each day before operating the scooter.

Place the motorcycle upright on level ground for engine oil level check. Run the engine for 2 ~ 3 minutes and check the oil level after the engine is stopped for 2 ~ 3 minutes.

2. Periodic Maintenance > Engine Oil



The oil filler cap/dipstick is located on the right side of the engine.



Remove the oil filler cap/dipstick and wipe off the oil. Inspect the O-ring and replace it as needed. Insert the dipstick in without threading it in. Remove the dipstick and check the oil level.

2. Periodic Maintenance > Engine Oil



The level must be maintained between the upper (1) and lower level (2) marks on the oil filler cap/dipstick.



If the oil level is at or below the lower mark add more of the same type and brand of oil to the engine through the oil filler hole. If the oil level is too high remove the drain plug and the excess oil.

Servicing

Draining

Warm the engine as with the inspection, this will heat the engine and allow the oil to drain out faster and more completely. The vehicle should be on level ground. Stop the engine.

Caution: Hot engine oil can burn. Avoid letting used motor oil contact exposed skin.

2. Periodic Maintenance > Engine Oil



Place an oil pan under the engine. The oil drain bolt is located on the left side of the engine.



2. Periodic Maintenance > Engine Oil



Loosen the engine oil drain bolt with a 17 mm socket. Remove the bolt and allow the oil to drain into the pan.



Discard the old sealing washer.

2. Periodic Maintenance > Engine Oil



Remove the oil filler cap to allow for faster oil draining. Inspect the oil filler cap O-ring and replace it as needed.



When the oil has drained completely Install the drain bolt with a new sealing washer. Tighten the drain bolt to specification with a 17 mm socket.

Item	Qty	Torque		Remarks
		kgf-m	lb-ft	
Oil Drain bolt	1	2.5	18.08	New sealing washer

2. Periodic Maintenance > Engine Oil

Strainer Screen



Remove the oil strainer screen bolt with a 17 mm socket. Inspect the strainer screen bolt O-ring and replace it as needed.



Remove the oil strainer screen.

2. Periodic Maintenance > Engine Oil



Remove the O-rings from the oil strainer screen and inspect them. Replace the O-rings if they are in poor condition. Inspect the oil strainer screen for debris and damage. Clean it with a high flash point solvent and compressed air. Metal debris in the strainer screen can be an indicator of engine wear or damage.

NOTE: Always wear safety glasses when using compressed air and never point it directly at yourself or anyone else.

2. Periodic Maintenance > Engine Oil



Return the O-rings to the oil strainer screen and install it into the left side of the engine. Tighten the oil strainer screen cap to specification with a 17 mm socket.

Item	Qty	Torque	
		kgf-m	lb-ft
Engine oil strainer cap	1	1.02	7.2

Filter Replacement



The oil filter compartment is located on the bottom of the engine below the oil filler cap/dipstick. Ready an oil drain pan to catch any remaining engine oil.



Loosen the oil filter cap with a 24 mm socket.



Remove the oil filter cap with spring and take out the used oil filter.

2. Periodic Maintenance > Engine Oil



Inspect the oil filter cap O-ring and spring. Replace the items if they are in poor condition.



Install the spring to the oil filter cap. Apply a light coat of engine oil to the oil filter cap O-ring.



Pour a small amount of fresh engine oil into the oil filter. Insert the oil filter into place with the rubber seal side facing up.



Install the oil filter cap with spring. Make sure the spring fits against the filter correctly. Tighten the oil filter cap securely with a 24 mm socket.

2. Periodic Maintenance > Engine Oil

Filling



Add the oil to the engine through the oil filler/dipstick hole.

Use a fully synthetic quality 4-stroke engine oil to ensure longer service life of the scooter. Only use oils that have a SJ rating above per the API service classification.

Engine oil viscosity : SAE 5W-50

Engine oil capacity	
At disassembly	1.5 Liter
At change	1.3 Liter



General Lubrication

SAFETY FIRST: Protective gloves and eyewear are recommended at this point.



The frame lubrication points are listed below. Use general purpose grease. Apply clean engine oil or grease to cables and movable parts not specified. This will avoid abnormal noise and increase the durability of the motorcycle.

- Front Wheel Axle
- Side Stand Pivot
- Center Stand Pivot
- Rear Wheel axle

Hose Inspection

Remove the seat. See the Seat topic for more information.

Remove the luggage box. See the Luggage Box topic for more information.



Inspect the breather hose for damage and deterioration.



Inspect the fuel hose for damage and deterioration.

2. Periodic Maintenance > Spark Plug

Spark Plug

SAFETY FIRST: Protective gloves and eyewear are recommended at this point.

Removal

Remove the seat. See the Seat topic for more information.

Remove the luggage box. See the Luggage Box topic for more information.

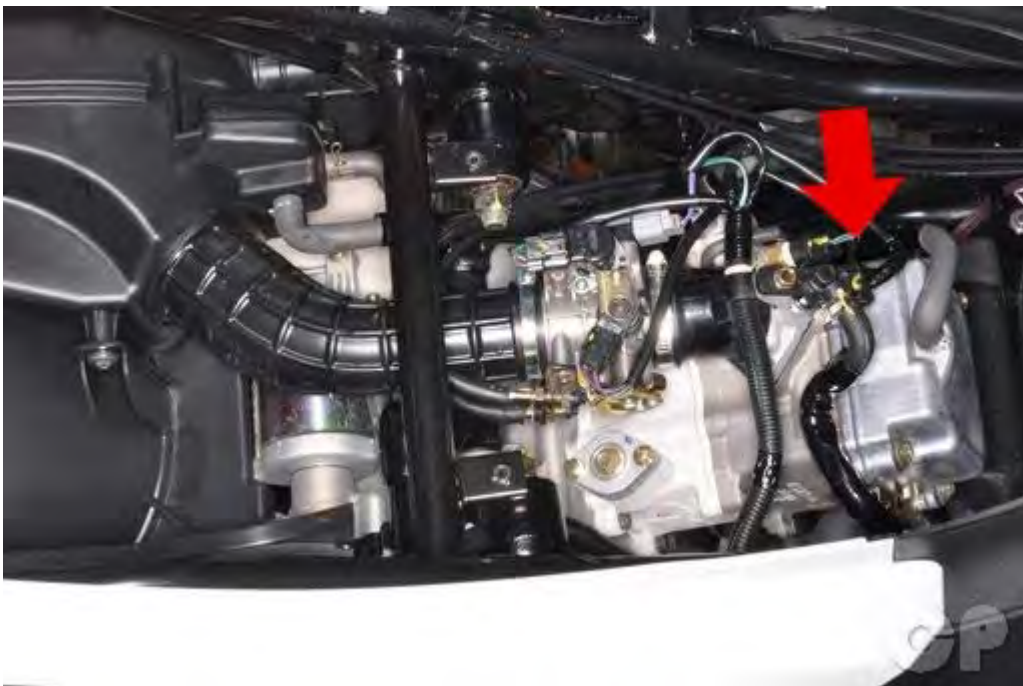

The spark plug is located on the left side of the cylinder.



remove the spark plug wire off of the spark plug.

2. Periodic Maintenance > Spark Plug



Clean off the area surrounding the spark plug with compressed air or a shop towel to make sure debris doesn't get into the combustion chamber when the spark plug is removed.

NOTE: Always wear safety glasses when using compressed air and never point it directly at yourself or anyone else.



Remove the spark plug with a spark plug with a 5/8 in socket.

Spark plug	NGKCR7E
------------	---------

2. Periodic Maintenance > Spark Plug

Inspection



Always check the gap of the spark plug before installation. If the gap needs to be adjusted bend the ground electrode carefully. Inspect the color of the porcelain nose of the spark plug. The color of the spark plug can indicate how the mixture is burning. A white colored plug shows a lean mixture, where a dark plug shows a rich mixture. Do not hesitate to replace a spark plug. Always replace a spark plug if any part of it is damaged.

Spark plug gap	0.6 - 0.7 mm
----------------	--------------

Installation



Thread the spark plug by hand before using a socket to tighten. Torque to specification with a 5/8" spark plug socket. Do not over tighten the spark plug. The cylinder head is made out of soft metal, and it can be easily damaged.

2. Periodic Maintenance > Spark Plug

Item	Torque
Spark plug	17.2 N-m (1.5 - 2 ft-lb, 10.84 - 14.47 kgf-m)



Install the spark plug wire over the plug.

Install the luggage box. See the LuggageBox topic for more information.

Install the seat. See the Seat topic for more information.

Steering

SAFETY FIRST: Protective gloves and eyewear are recommended at this point.

Inspection



Raise the front wheel off the ground and check that the steering handlebar rotates freely. If the handlebar moves unevenly, binds, or has vertical movement, adjust the steering head bearing. See the Steering topic for more information.

2. Periodic Maintenance > Suspension

Suspension

SAFETY FIRST: Protective gloves and eyewear are recommended at this point.

Front Suspension



Check the action of the front shock absorbers by compressing them several times. Check the entire shock absorber assembly for oil leaks, looseness or damage.

2. Periodic Maintenance > Suspension

Pre-Load Setting

Each shock absorber on the scooter has 5 spring preload adjustment positions for different load or riding conditions.

Position 1 is for light loads and smooth road conditions. Position 3 to 5 increase spring preload for stiffer rear suspension and can be used when the scooters heavily loaded. Be certain to adjust both shock absorbers to the same spring preload positions.



Use a pin spanner to adjust the rear shock spring preload. The shock absorbers are adjustable for pre-load. There are 5 settings. Position 1 is the softest and 5 is the stiffest.

Caution: Always adjust the shock absorber pre-load position in sequence (1-2-3-4-5 or 5-4-3-2-1). Attempting to adjust directly from 1 to 5 or 5 to 1 may damage the shock absorber. (Pre-Load Standard Setting: Position 3)

Tires

SAFETY FIRST: Protective gloves and eyewear are recommended at this point.

Check tires before each ride for wear and air pressure.



Check tire air pressure before riding when tires are cold.

Cold inflation tire pressure	Solo riding	Front	2.00 kg/cm ² (28.4 psi)
		Rear	2.25 kg/cm ² (32 psi)
	Dual riding	Front	2.00 kg/cm ² (28.4 psi)
		Rear	2.25 kg/cm ² (32 psi)

2. Periodic Maintenance > Tires



Replace tires if the tread depth reaches the wear mark or fails to meet the minimum tread depth.

Tires	Front wheel	120/70-14
	Rear wheel	150/70-13

Valve Clearance

SAFETY FIRST: Protective gloves and eyewear are recommended at this point.

The valve clearance specification is only relevant if the engine is cold (below 35°C or 95°F).

Inspection

Remove the seat. See the Seat topic for more information.

Remove the luggage box. See the LuggageBox topic for more information.

Remove the spark plug. See the SparkPlug topic for more information.

Remove the cylinder head cover. See the Cylinder Head Cover topic for more information.



Remove the crankshaft cap on the right side of the engine with a large flat blade screwdriver. Inspect the O-ring on the cap and replace it as needed.



Remove the timing inspection cap from the right side of the engine with a large flat blade screwdriver. Inspect the O-ring on the cap and replace it as needed.

2. Periodic Maintenance > Valve Adjustment



The crankshaft must be rotated (clockwise) until the piston is at top dead center (TDC) on the compression stroke.



Turn crankshaft clockwise until the "T" mark aligns with the index notch in the timing inspection hole.

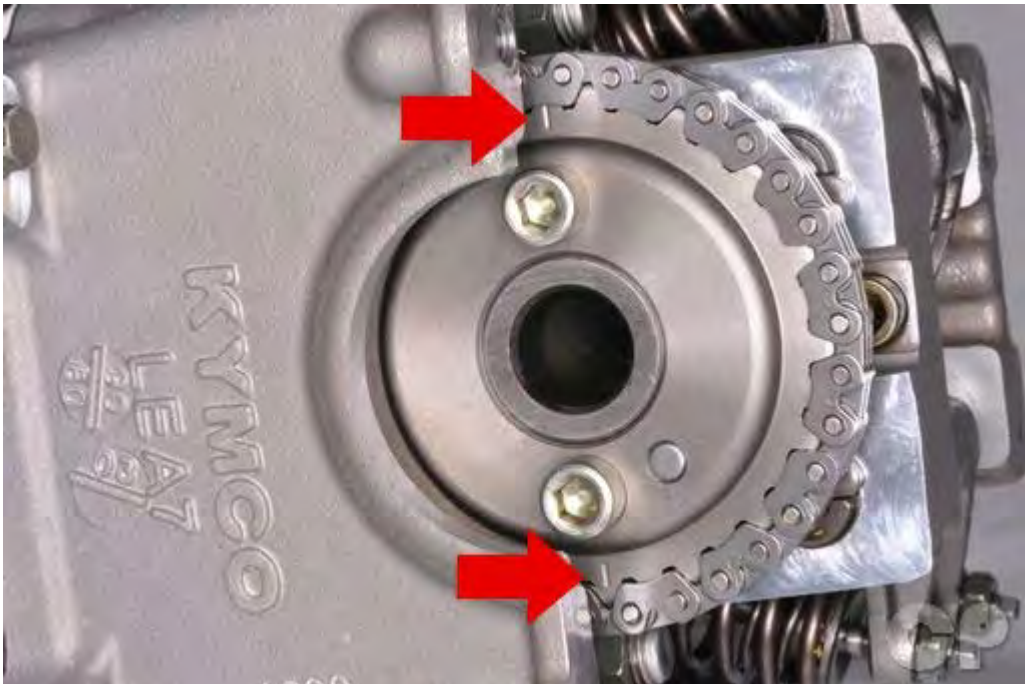

For correct engine timing the marks on the camshaft sprocket must be even with the cylinder head mating surface at the same time the "T" mark is lined up with the with the index notch in the timing inspection hole. Also the camshaft sprocket mounting boss should be visible above the cylinder head surface.

If this is not the case, rotate the crankshaft 360° clockwise until the "T" mark is once again aligned with the notch on the case cover.



Measure the valve clearance with a thickness feeler gauge. Insert the feeler gauge between the tappet adjusting screw and the valve stem. The clearance is correct when there is a light drag on the feeler gauge. The clearance is the same for the exhaust and intake valves. If the clearance is out of spec move on to the adjustment section.

Valve clearance	IN: 0.10 mm	EX: 0.10 mm
------------------------	--------------------	--------------------

Adjustment



Use a tappet adjuster tool to adjust the valves.

SPECIAL TOOLS		
ITEM	TOOL NO.	DESCRIPTION
TAPPET ADJUSTER	E012	Tappet adjustment



2. Periodic Maintenance > Valve Adjustment

Place a 9 mm box end wrench over the locknut, and loosen the locknut. If the valve clearance is tight back out the valve tappet adjusting screws with the tappet adjustment tool. If the clearance is to loose turn in the adjusting screw until there is a light drag on the feeler gauge. Hold the adjusting screw locknut in place with the wrench to make sure it doesn't interfere with the adjustment.

Lubricate the tappet adjusting screw threads with fresh engine oil. Hold the adjuster in place and tighten the locknut. Always recheck the clearance after tightening the locknut. Also, recheck after turning the engine over a full 360°.

Item	Qty	Thread size (mm)	Torque		Remarks
			kgf-m	lb-ft	
Valve adjusting lock nut	4	5	0.7-1.1	5.06-7.96	Apply oil to thread



Make sure the O-rings on the crankshaft and timing plugs are in good condition. Replace them as needed. Install the timing inspection and crankshaft caps to the right side of the engine. Tighten the caps securely but not overly with a large flat blade screwdriver.

3. Engine

Engine

This chapter covers the location and servicing of the engine components for the KYMCO K-XCT 300i.

- Engine Removal3-4~3-13
- Cylinder Head Cover3-14~3-19
- Camshaft.....3-20~3-37
- Valves3-38~3-47
- Cylinder and Piston3-48~3-65
- Generator3-66~3-86
- Oil Pump3-87~3-93
- Crankcase3-94~3-105
- Camshaft.....3-106~3-110
- Engine Installation.....3-111~3-118
- Specifications3-119~3-127

GENERAL INSTRUCTIONS

Lubrication System

The maintenance of lubrication system can be performed with the engine installed in the frame. Use care when removing and installing the oil pump not to allow dust and foreign matters to enter the engine and oil line.

Do not attempt to disassemble the oil pump. The oil pump must be replaced as a set when it reaches its service limit.

After the oil pump is installed, check each part for oil leaks.

TROUBLESHOOTING

Oil level too low

1. Natural oil consumption
2. Oil leaks
3. Worn or poorly installed piston rings
4. Worn valve guide or seal

3. Engine

Poor lubrication pressure

1. Oil level too low
2. Clogged filter or oil passages
3. No use the specified oil

Cylinder Head, Camshaft, and Valves

- The cylinder head can be serviced with the engine installed in the frame. Coolant in the radiator and water hoses must be drained.
- When assembling, apply molybdenum disulfide grease or engine oil to the valve guide movable parts and valve arm sliding surfaces for initial lubrication.
- The valve rocker arms are lubricated by engine oil through the engine oil passages. Clean and unclog the oil passages before assembling the cylinder head.
- After disassembly, clean the removed parts and dry them with compressed air before inspection.
- After removal, mark and arrange the removed parts in order. When assembling, install them in the reverse order of removal.

TROUBLESHOOTING

- The poor cylinder head operation can be diagnosed by a compression test or by tracing engine top-end noises.

Poor performance at idle speed

- Compression too low

Compression too low

- Incorrect valve clearance adjustment
- Burned or bent valves
- Incorrect valve timing
- Broken valve spring
- Poor valve and seat contact
- Leaking cylinder head gasket
- Warped or cracked cylinder head
- Poorly installed spark plug

3. Engine

Compression too high

- Excessive carbon build-up in combustion chamber

Abnormal noise

- Incorrect valve clearance adjustment
- Sticking valve or broken valve spring
- Damaged or worn camshaft
- Worn cam chain tensioner
- Worn camshaft and rocker arm

White smoke from exhaust muffler

- Worn valve stem or valve guide
- Damaged valve stem oil seal

Cylinder and Piston

- The cylinder and piston cannot be serviced with the engine installed in the frame.
- After disassembly, clean the removed parts and dry them with compressed air before inspection.
- If replacing the piston or cylinder, they must be changed as a pair.

TROUBLESHOOTING

Compression too low or uneven compression

- Worn, stuck or broken piston rings
- Worn or damaged cylinder and piston

Compression too high

- Excessive carbon build-up in combustion chamber or on piston head.

Excessive smoke from exhaust muffler

- Worn or damaged piston rings
- Worn or damaged cylinder and piston

Abnormal noisy piston

- Worn cylinder, piston and piston rings
- Worn piston pin hole and piston pin

3. Engine > Engine Removal

Engine Removal

SAFETY FIRST: Protective gloves and eyewear are recommended at this point.

- A floor jack or other adjustable support is required to support and maneuver the engine. Be careful not to damage the scooter body, cables and wires during engine removal.
- Use shop towels to protect the scooter body during engine removal.

Place the scooter on the center stand.

Remove the following external components:

- Seat
- Luggage Box
- Center Cover
- Front Cover
- Front Lower Cover
- Foot Skirt
- Rear Carrier
- Body Cover
- Under Cover

Disconnect the cables from the battery terminals. See the Battery topic for more information.

Remove the spark plug cap. See the Spark Plug topic for more information.

Drain the coolant. See the Coolant topic for more information.

Drain the engine oil. See the Engine Oil topic for more information.

Remove the air box. See the Air box topic for more information.

Remove the rear brake caliper. See the Rear Brake Caliper topic for more information.

Remove the throttle body. See the Throttle Body topic for more information.

Remove the exhaust system. See the Exhaust System topic for more information.

3. Engine > Engine Removal



The regulator/rectifier is located on the right side of the vehicle.



Disconnect the generator 3-pin connector.



Disconnect the crank position sensor wire coupler.

3. Engine > Engine Removal



Unplug the water temperature sensor.

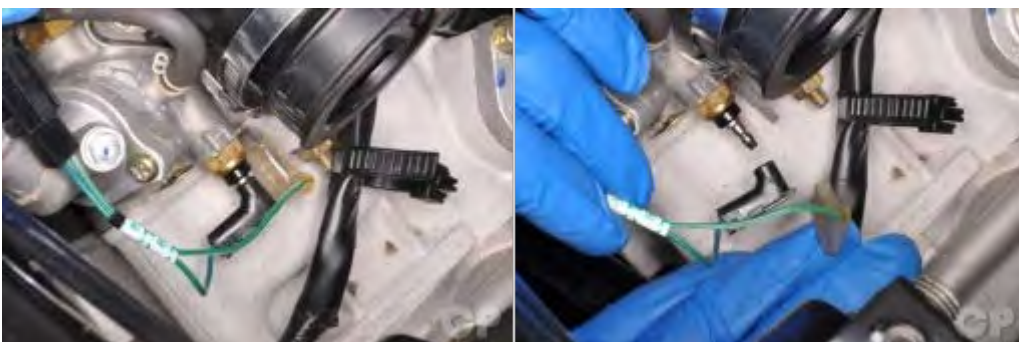

Unplug the thermo sensor unit and thermo unit ground connectors.



Pull back the rubber starter motor lead cover.

3. Engine > Engine Removal



Remove the starter motor lead nut with a 10 mm wrench. Free the cable lead from the starter motor. Thread the nut back on to keep track of it.



Loosen the fuel hose stay bolt with an 8 mm socket. Free the fuel hose stay from the cylinder head cover.

3. Engine > Engine Removal



Loosen the water pump hose clamp with a #2 Phillips screwdriver. Slide up the clamp and free the coolant hose from the water pump. Allow any remaining coolant to drain into a suitable container.



Loosen the thermostat hose clamp with a #2 Phillips screwdriver. Slide up the clamp and free the coolant hose from the thermostat. Allow any remaining coolant to drain into a suitable container.



Squeeze the air bleed hose clamp with needle nose pliers and slide back the clamp. Free the air bleed hose from the thermostat.

3. Engine > Engine Removal



Loosen the main engine ground bolt with an 8 mm socket. Remove the bolt and free the engine ground from the right side of the engine.



Free the starter motor lead from the stay on the right crankcase cover.



Unplug the oil pressure switch wire at the bullet connector. The oil pressure switch is located below the cylinder.

3. Engine > Engine Removal



Free the wiring harness from its guide above the intake pipe.



Support the engine with a suitable jack or stand.

3. Engine > Engine Removal

Remove the rear shock absorbers. See the ShockAbsorbers topic for more information.



Loosen the engine mounting bracket damper nut with a 14 mm socket. Remove the nut and washer.



Hold the engine mounting bolts with a 14 mm wrench and loosen the nuts with a 19 mm socket.



Remove the engine mounting nuts and bolts from both sides.

3. Engine > Engine Removal



Loosen the engine mounting bracket damper bolt and nut with a 17 mm wrench for the nut and a 14 mm socket for the bolt.



Remove the engine mounting bracket damper bolt and nut.



Remove the engine mounting bracket.

3. Engine > Engine Removal



Remove the engine mounting bracket damper assembly.

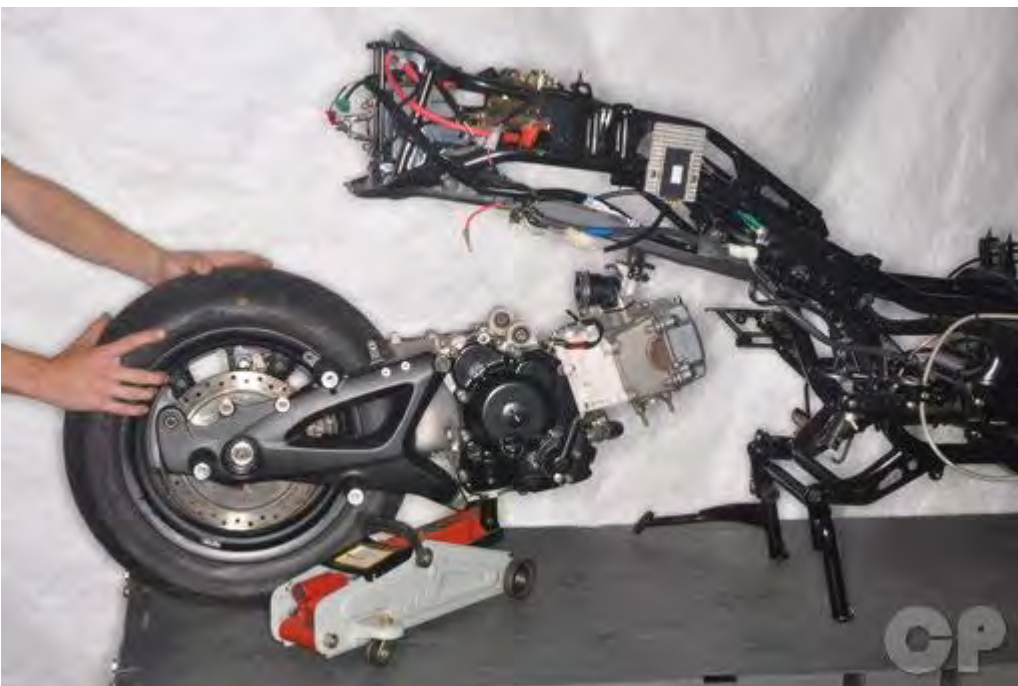

Carefully move the engine back and separate it from the chassis.
To install the engine see the Engine Installation topic.

3. Engine > Cylinder Head Cover

Cylinder Head Cover

SAFETY FIRST: Protective gloves and eyewear are recommended at this point.

Removal

Remove the seat. See the Seat topic for more information.

Remove the luggage box. See the Luggage Box topic for more information.

Remove the spark plug. See the Spark Plug topic for more information.



Squeeze the breather hose clamp with needle nose pliers and slide it back. Remove the breather hose from the cylinder head cover.

3. Engine > Cylinder Head Cover



Loosen the fuel hose stay bolt with an 8 mm socket. Free the fuel hose stay from the cylinder head cover.



Loosen the four cylinder head cover bolts with a 10 mm socket. Remove the cylinder head cover bolts with washers and grommets. Note the gold colored and longer bolts are on the left side.



Remove the cylinder head cover and gasket. Discard the gasket and replace it with a new item on installation.

3. Engine > Cylinder Head Cover



Remove the dowel pin.

Installation



Install the dowel pin into the cylinder head.

3. Engine > Cylinder Head Cover



Fit the cylinder head cover gasket onto the cylinder head. Make sure the projection fits into the groove in front of the camshaft sprocket correctly.



Install the cylinder head cover over the gasket. Make sure the ridge on the gasket fits into the groove on the cylinder head cover correctly. Align the bolt holes and dowel pin.

3. Engine > Cylinder Head Cover



Coat the cylinder head cover bolt seals in fresh engine oil. Insert the cylinder head cover bolts with grommet seals and washers. Note the gold colored and longer bolts go on the left side.



Tighten the cylinder head cover bolts securely in two steps and in a crisscross pattern with an 8 mm socket.

3. Engine > Cylinder Head Cover

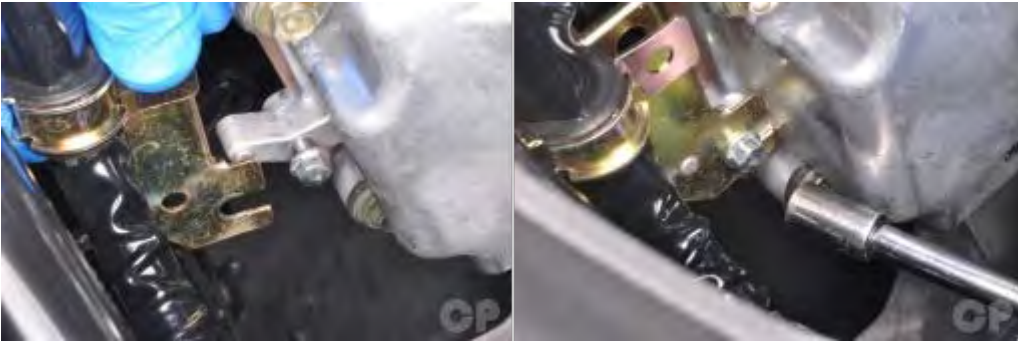

Fit the fuel stay into place. Tighten the stay bolt securely with an 8 mm socket.



Install the breather hose to the cylinder head cover. Secure the hose with the clamp.

Install the spark plug. See the SparkPlug topic for more information.
Install the luggage box. See the LuggageBox topic for more information.
Install the seat. See the Seat topic for more information.

3. Engine > Camshaft

Camshaft

SAFETY FIRST: Protective gloves and eyewear are recommended at this point.

Removal

Remove the seat. See the Seat topic for more information.

Remove the luggage box. See the Luggage Box topic for more information.

Remove the spark plug. See the Spark Plug topic for more information.

Remove the cylinder head cover. See the Cylinder Head Cover topic for more information.



Remove the crankshaft cap on the right side of the engine with a large flat blade screwdriver. Inspect the O-ring on the cap and replace it as needed.



Remove the timing inspection cap from the right side of the engine with a large flat blade screwdriver. Inspect the O-ring on the cap and replace it as needed.

3. Engine > Camshaft



The crankshaft must rotate (clockwise) until the piston is at top dead center (TDC) on the compression stroke.



Turn crankshaft clockwise until the "T" mark aligns with the index notch in the timing inspection hole.

3. Engine > Camshaft



The piston should now be at TDC on the compression stroke. You can make sure that it is on the compression stroke by checking that there is some slack in the rocker arms. If the rocker arms are rigid, rotate the crankshaft 360° clockwise until the "T" mark is once again aligned with the notch on the case cover.



The cam chain tensioner is located on the back of the cylinder.

3. Engine > Camshaft



Remove the cam chain tensioner cap bolt with a 10 mm socket.



Loosen the cam chain tensioner mounting bolts evenly with an 8 mm socket.



Lift the cam chain tensioner out of the cylinder. Remove the cam chain tensioner gasket.

3. Engine > Camshaft



Use a 5 mm Allen wrench to remove the camshaft sprocket bolts.



Remove the camshaft sprocket as shown. Support the chain so it does not fall into the cylinder head.



Use a 5 mm Allen wrench to remove the set plate bolt.

3. Engine > Camshaft



Remove the set plate as shown.



Thread a bolt into the rocker arm shafts and pull the shafts out.

3. Engine > Camshaft



Lift out the rocker arms as the shafts are removed.



Remove the camshaft from the cylinder head.

3. Engine > Camshaft

Inspection



Inspect the camshaft cam heights for the intake and exhaust lobes. Inspect the camshaft bearings for excessive play or roughness. Replace the entire camshaft assembly if the bearings are rough or have excessive play.

Item		Standard (mm)
Camshaft cam height	IN	34.2987
	EX	34.1721

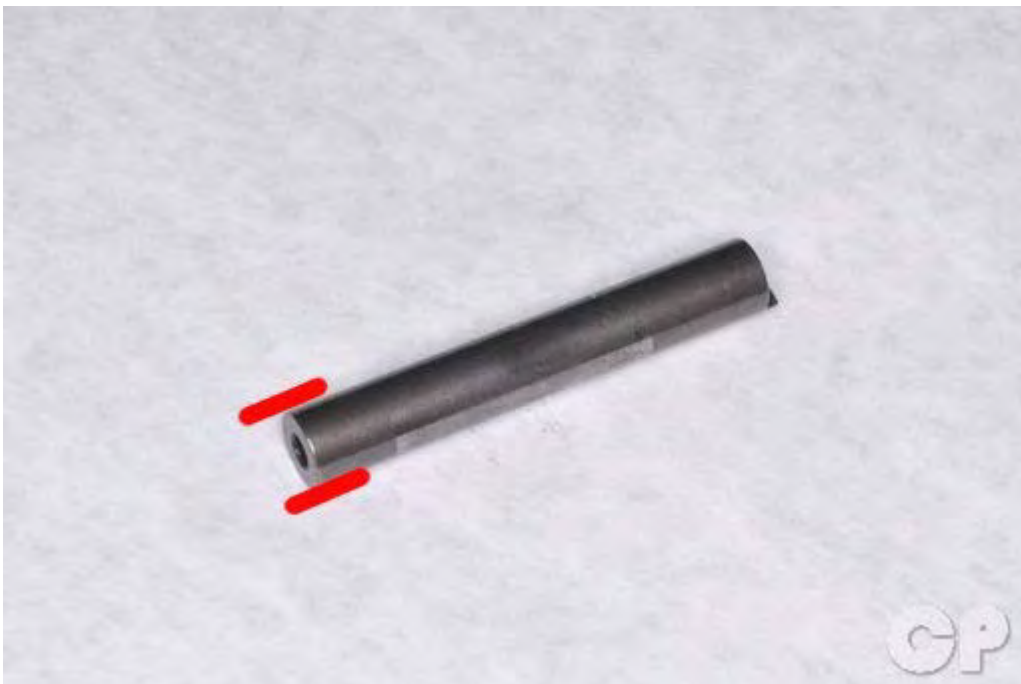

Inspect the rocker arm shaft outer diameter for the intake and exhaust valves.

Item		Standard (mm)
Valve rocker arm shaft O.D.	IN	9.972 - 9.987
	EX	9.972 - 9.987

3. Engine > Camshaft



Inspect the rocker arm inner diameter for the intake and exhaust valves.

Item		Standard (mm)
Valve rocker arm I.D.	IN	10.00 - 10.015
	EX	10.00 - 10.015



Inspect the camshaft bearing journals for scoring or scratches.

3. Engine > Camshaft



Inspect the camshaft sprocket for worn teeth or other signs of wear or damage.

Camshaft Installation

Clear out the cylinder head oil passages with compressed air. Make sure all cylinder head oil passages are free of clogs.

NOTE: Always wear safety glasses when using compressed air and never point it directly at yourself or anyone else.

3. Engine > Camshaft



Position the piston at top dead center as above. The "T" mark should be aligned with the index notch in the timing inspection hole. Support the cam chain if the crank must be turned to position the piston correctly.

Lubricate the camshaft lobes and bearings with fresh engine oil.



Insert the camshaft into the camshaft holders with the lobes facing down.

3. Engine > Camshaft



Lubricate the inside diameter of the rocker arms and the roller with fresh engine oil. Position the rocker arms to accept the rocker arm shafts.



Wipe the rocker arm shafts clean. Insert the rocker arm shafts through the camshaft holders and rocker arms. Install the rocker arm shafts so that the end sits as shown.

3. Engine > Camshaft



Install the camshaft set plate so it fits into the groove on the camshaft and between the projections on the rocker arm shafts.



Apply a small amount of blue Loctite (non-permanent) to the threads of the set plate bolt. Thread in the bolt and tighten it to specification with a 5 mm Allen socket.

Item	Qty	Thread size (mm)	Torque	
			kgf-m	lb-ft
Camshaft set plate bolt	1	5	1.2	2.0

3. Engine > Camshaft



Install the camshaft sprocket onto the camshaft so the camshaft sprocket boss fits into the appropriate hole on the camshaft sprocket. Make sure the camshaft sprocket boss is facing up so it is visible above the edge of the cylinder head as shown. Align the horizontal marks on

the camshaft sprocket with the top edge of the cylinder head as shown. Fit the camchain over the camshaft sprocket.

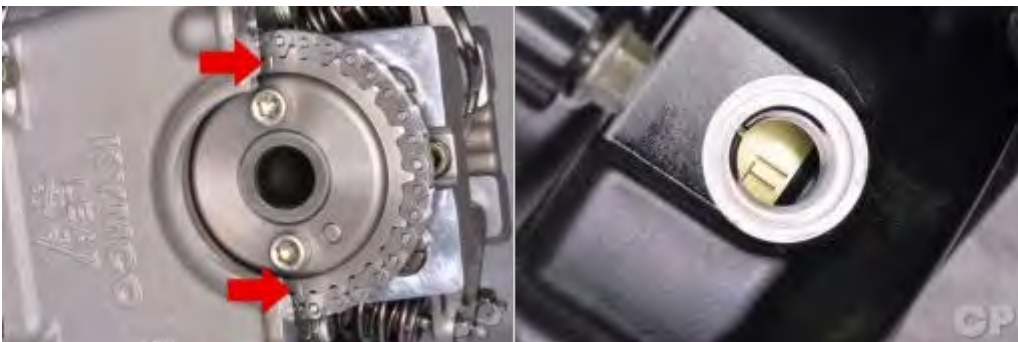

For correct engine timing the marks on the camshaft sprocket must be even with the cylinder head mating surface at the same time the "T" mark is lined up with the index notch in the timing inspection hole. The camshaft lobes should be facing down and their should be slack in the rocker arms.



Apply a small amount of blue Loctite (non-permanent) to the threads of the camshaft sprocket bolts. Thread in the camshaft sprocket bolts and tighten to specification using a 5 mm Allen socket.

3. Engine > Camshaft

Item	Qty	Thread size (mm)	Torque	
			kgf-m	lb-ft
Cam sprocket bolt	2	6	1.0-1.4	7.23-10.13

Double check the engine timing.



Use a small flat blade screwdriver bring in the cam chain tensioner rod. Turn the screwdriver counter clockwise to retract the rod. The rod must be held in with the screwdriver until the cam chain tensioner mounting bolts have been installed.

3. Engine > Camshaft



Install the camchain tensioner with a new gasket. Insert the mounting bolts and tighten them evenly to specification with an 8 mm socket. Remove the screwdriver and release the camchain tensioner rod.

Item	Qty	Thread size (mm)	Torque	
			kgf-m	lb-ft
Cam chain tensioner bolt	2	6	1.0-1.4	7.23-10.13



3. Engine > Camshaft



Rotate the crankshaft 360° clockwise and check the engine timing one more time.



Make sure the cam chain tensioner cap bolt O-ring is in good condition. Install the O-ring and cam chain tensioner cap bolt. Tighten the bolt to securely with a 10 mm socket.

Check the valve clearance. See the Valve Clearance topic for more information.

3. Engine > Camshaft



Make sure the O-rings on the crankshaft and timing plugs are in good condition. Replace them as needed. Install the timing inspection and crankshaft caps to the right side of the engine. Tighten the caps securely but not overly with a large flat blade screwdriver.

Install the cylinder head cover. See the [Cylinder Head Cover_topic](#) for more information.

Install the spark plug. See the [Spark Plug](#) topic for more information.

Install the luggage box. See the [Luggage Box](#) topic for more information.

Install the seat. See the [Seat](#) topic for more information.

3. Engine > Valves

Valves

SAFETY FIRST: Protective gloves and eyewear are recommended at this point.

Removal

Remove the camshaft. See the Camshaft topic for more information.

Remove the cylinder head. See the Cylinder Head topic for more information.

IMPORTANT: Record the position of all parts so they can be returned to their proper place during reassembly.



Push down the valve springs with a valve spring compressor.

Special Tool- Valve Spring Compressor: E040



3. Engine > Valves

Remove the split keepers. There are two per valve.



Remove the spring retainer.

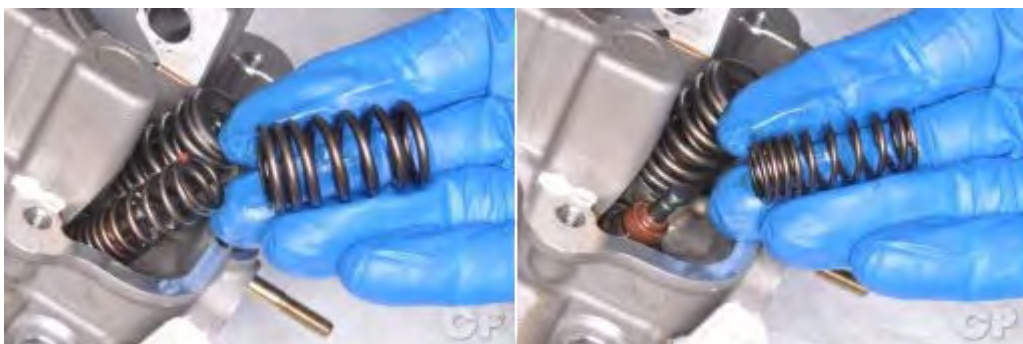

Remove the valve springs.

3. Engine > Valves



Push the valve stem down and remove the valve from the combustion chamber side of the cylinder head. Rotate the valve as it is removed.



Remove the valve seal from the valve guide. The valve seals should be replaced if they are removed or you are going to install new valves.

3. Engine > Valves



Remove the spring seat.

Inspection



Inspect the valve springs for fatigue and damage. Replace the valve springs as needed or if the valve is also to be replaced.

3. Engine > Valves



Inspect the valves for damage and burning. Measure the valve stem diameter in several places where the valve makes contact with the guide. If the measurement is below specification replace the valve.

Item		Standard (mm)
Valve stem O.D.	IN	4.990 - 4.975
	EX	4.970 - 4.955



Inspect the valve seat and the valve seat width. The valve seat should

3. Engine > Valves

be centered on the valve face. If the seat is pitted, worn out, or fits poorly on the valve face the valve seat must be resurfaced.

Item		Standard (mm)
Valve seat width	IN	1.2
	EX	1.2



Measure the inside diameter of the valve guides. Replace the guides if the measurement is out of specification. Calculate the valve stem-to-guide clearance. Replace the guide and valve if the clearance is out of specification

Item		Standard (mm)
Valve guide I.D	IN	5.00 - 5.012
	EX	5.00 - 5.012
Valve stem-to-guide clearance	IN	0.010 - 0.037
	EX	0.030 - 0.057

3. Engine > Valves

Installation

Clean the cylinder head components thoroughly with a high flash-point solvent and compressed air. Return the components to their original locations.

NOTE: Always wear safety glasses when using compressed air and never point it directly at yourself or anyone else.



Install the spring seat.



Coat the new valve seal in fresh engine oil and install it onto the valve guide.

3. Engine > Valves



Coat the valve stem in fresh engine oil and insert the valve into the valve guide and through the seal. Turn the valve slowly as it is inserted. If you are installing a new valve you must ream the valve guide first. Make sure the valve will move smoothly in the valve guide without wobble.



Install the valve springs. The tightly coiled end of the springs should sit against the spring seat.

3. Engine > Valves



Place the spring retainer on top of the spring.



Push down the valve springs with a valve spring compressor to allow enough room to install the split keepers. The valve cotter installer tool can also be used to install the split keepers.

Special Tool- Valve Spring Compressor: E040

3. Engine > Valves



Apply grease to the inside of the split keepers. Apply a dab of grease to the end of a flat blade screwdriver. Set the keeper in the grease on the screwdriver and insert it onto the valve stem. Repeat this with the other keeper.

After the valves have been reassemble place a clean shop towel under the cylinder head in the combustion chamber area and gently tap each valve stem with a plastic rod and rubber mallet to make sure the valves are seated properly.

Install the cylinder head. See the Cylinder Head topic for more information.

Install the camshaft. See the Camshaft topic for more information.

Cylinders and Pistons

SAFETY FIRST: Protective gloves and eyewear are recommended at this point.

Cylinder Block Removal

Remove the engine from the frame. See the Engine Removal topic for more information.

Remove the cylinder head cover. See the Cylinder Head Cover topic for more information.

Remove the camshaft sprocket. See the Camshaft topic for more information.

Remove the cylinder head. See the Cylinder Head topic for more information.



Slide out the lower cam chain guide. Inspect the guide for excessive wear and damage. Replace the guide as needed.

3. Engine > Cylinders and Pistons



Remove the two right side cylinder bolts with an 8 mm socket.



Loosen the cylinder coolant hose clamp with a #2 Phillips screwdriver.
Free the coolant hose from the cylinder.

3. Engine > Cylinders and Pistons



Slide the cylinder off of the studs and piston. Guide the cam chain through its opening and do not allow it to fall into the crankcase. Remove the cylinder.



Remove the base gasket.

3. Engine > Cylinders and Pistons



Remove the two cylinder dowel pins from the left studs.

Place a clean shop towel under and around the base of the piston to prevent any parts or debris falling into the crankcase.



Remove the piston pin clips with a pick or needle nose pliers. Discard the piston pin clips.



Remove the piston pin and the piston.

3. Engine > Cylinders and Pistons

Clean off the cylinder mating surface, but take care to keep debris from falling into the crankcase.

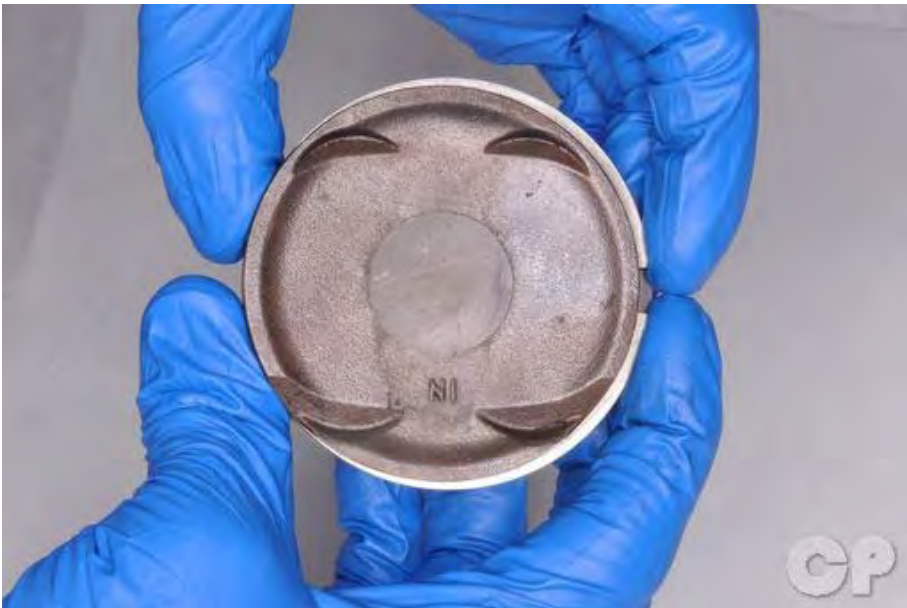

Spread the piston rings and lift them off opposite the gap. Spread the rings the minimum amount during removal. The rings can be easily damaged.

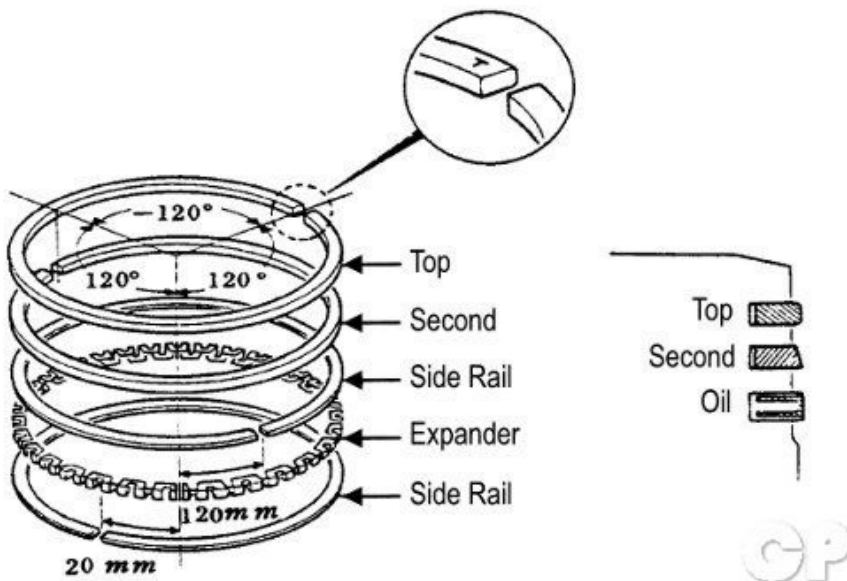

The two upper rings are each a single piece of metal. The oil ring consists of an expander ring and two side rails.

3. Engine > Cylinders and Pistons

The two upper rings are each a single piece of metal. The oil ring consists of an expander ring and two side rails.



Clean the carbon build up off of the piston with a stiff bristled plastic brush or rag. Never use a wire brush to clean a piston.



Also clean out the ring grooves. You can use an old ring to scrape out any carbon build up in the grooves.

3. Engine > Cylinders and Pistons

Inspection

The cylinder and piston must be replaced as a set. There are two sets of cylinder and piston combinations. Make sure to have a No.1 cylinder with an "A" piston or a No.2 cylinder with a "B" piston.

No.	Mark	Piston O.D. (mm)	Cylinder I.D. (mm)
1	A	72.680 - 72.690	72.700 - 72.710
2	B	72.690 - 72.700	72.710 - 72.720

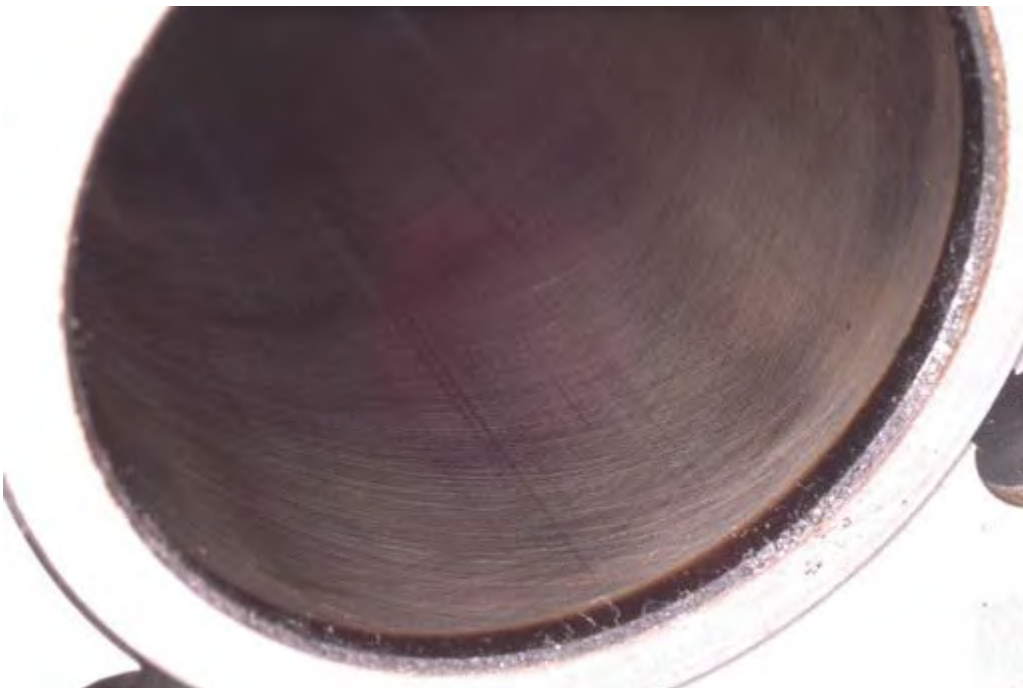

Inspect the cylinder bore for damage and abnormal wear

3. Engine > Cylinders and Pistons



Measure the cylinder diameter as described below with a telescoping gauge.

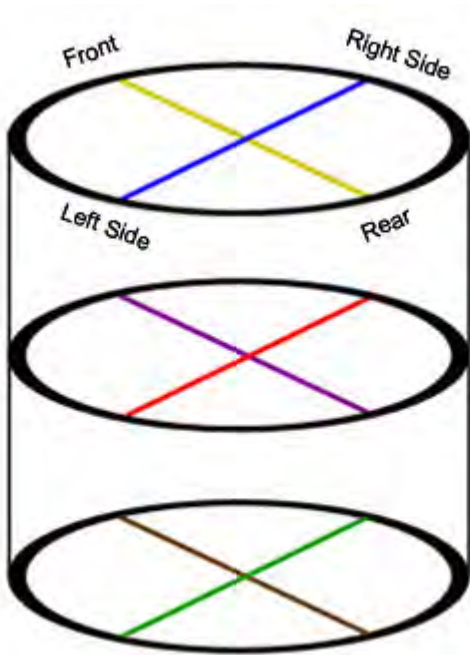

Inspect the cylinder front to back and side to side at three different height levels with a dial bore gauge.

Item		Standard (mm)
Cylinder	I.D.	72.7

Calculate the cylinder taper. The taper is the maximum difference between either yellow and brown or blue and green.

3. Engine > Cylinders and Pistons

Item		Limit (mm)
Cylinder	Taper	0.05

Calculate the cylinder out of round. The out of round is greatest out of yellow, purple, or brown minus the smallest of blue, red, or green.

Item		Limit (mm)
Cylinder	Out of round	0.05

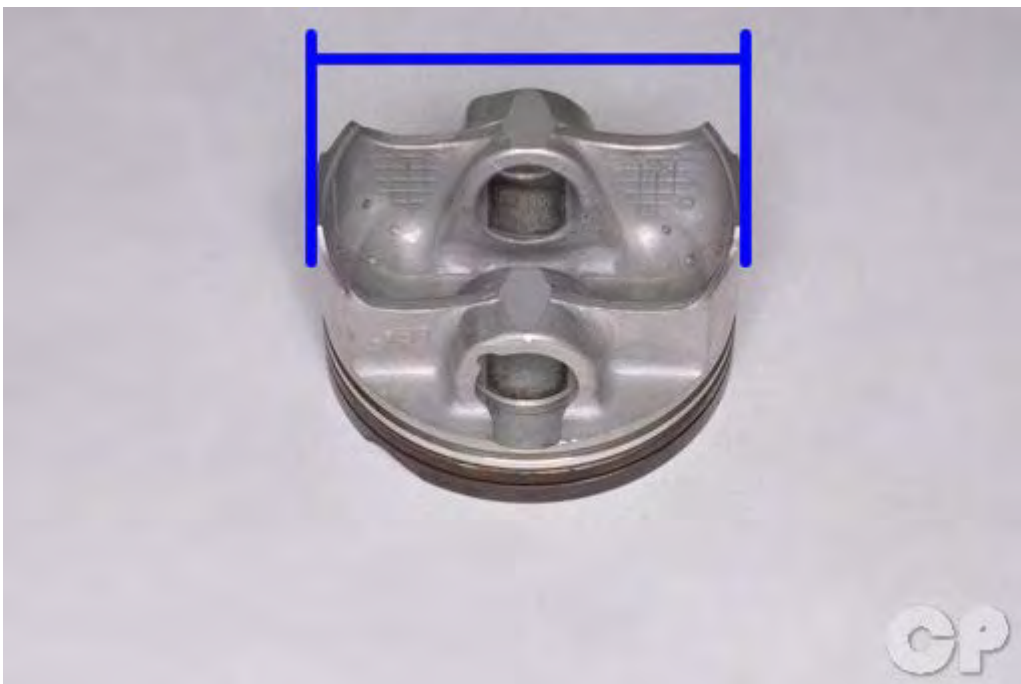

Measure the outside diameter of the piston at 9 mm up from the bottom of the skirt at a 90° angle to the piston pin. Measure the piston with vernier calipers or a micrometer. Check the piston for wear, damage, and extreme discoloration.

Subtract the diameter of the piston from the maximum front to rear diameter measurement of the cylinder to calculate the piston-to-cylinder clearance. Replace the piston and cylinder as needed to achieve a correct piston-to-cylinder clearance.

Item	Standard (mm)
Piston-to-cylinder clearance	0.010 - 0.030

3. Engine > Cylinders and Pistons



Measure the piston pin diameter with a micrometer. Measure the piston pin bore diameter with vernier calipers or a small bore gauge. Measure at three different points for each. Replace the parts if any of the specifications are not met.

Item	Standard (mm)
Piston pin hole I.D.	15.002 - 15.008
Piston pin O.D.	14.994 - 15.000
Piston-to-piston pin clearance	0.002 - 0.014



Measure the inside diameter of the small end of the connecting rod with vernier calipers.

Item	Standard (mm)
Connecting rod small end I.D. Bore	15.016 - 15.034

3. Engine > Cylinders and Pistons



Measure the ring groove width and the ring-to-groove clearance with feeler gauges.

Item		Standard mm
Piston ring-to-groove clearance	1st	0.015 - 0.055
	2nd	0.015 - 0.055



Insert the top ring into the cylinder. Push the top ring in the cylinder about an inch. Use the piston to push in the ring to keep it square with the cylinder.

3. Engine > Cylinders and Pistons



Measure the ring gap with a feeler gauge. Repeat this procedure with second ring and the oil side rails.

Item		Standard mm
Ring end gap	Top	0.10 - 0.25
	Second	0.10 - 0.25
	Oil side rail	0.2 - 0.7



Check the oil jet for clogs.

Assembly

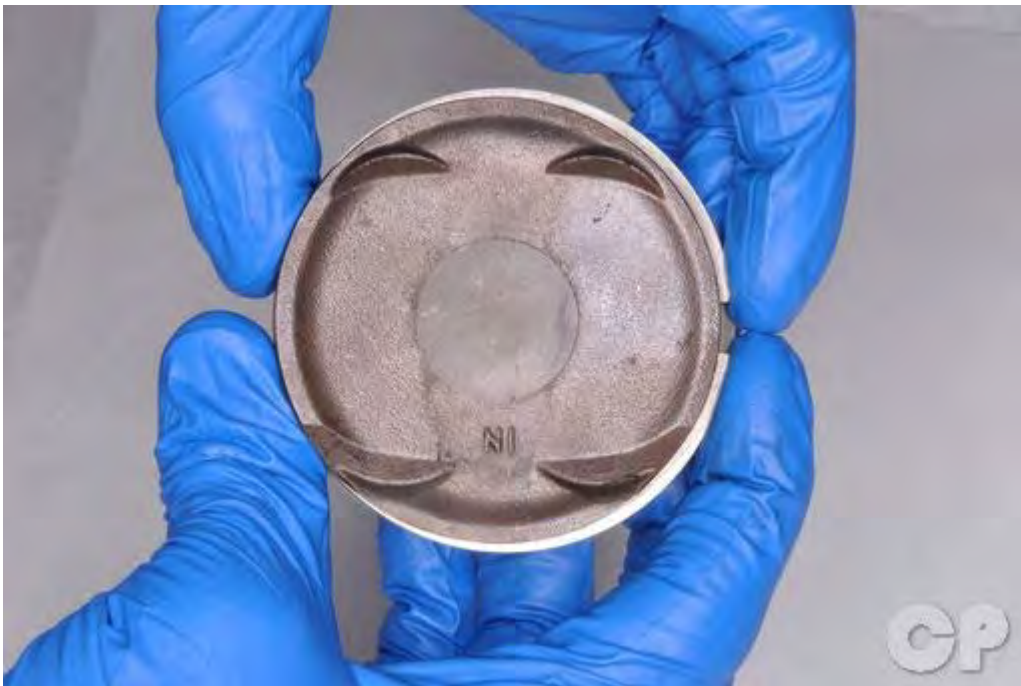

Clean the piston ring grooves and apply fresh engine oil to the piston rings. Spread the rings the minimum amount possible to install them. Do not try and force them on the piston.

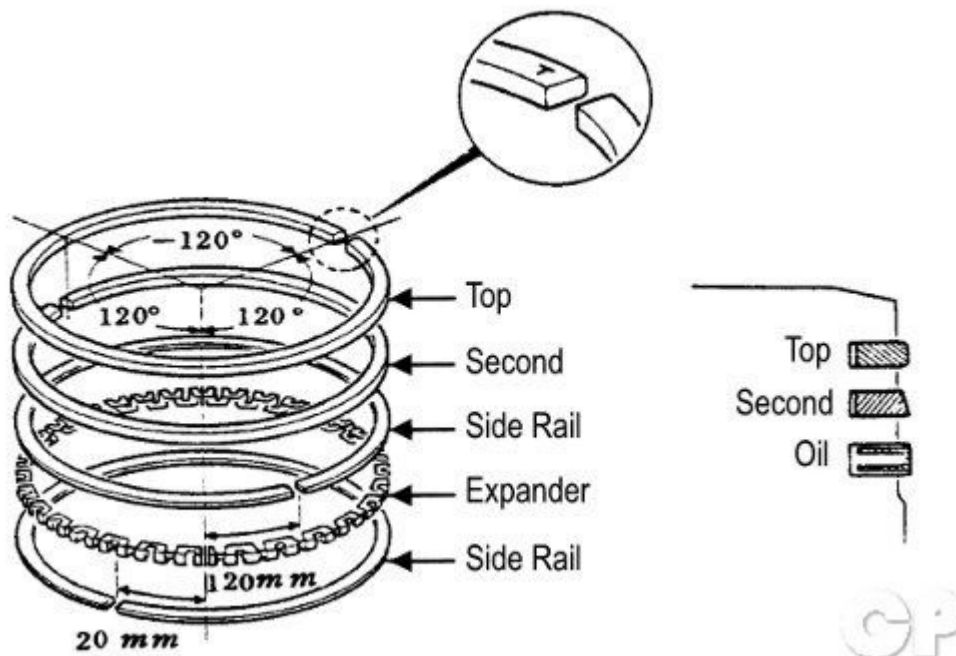

Install the top and second rings with their markings facing up. Install the rings to the piston as shown above so that no ring end gaps line up with the piston pin or perpendicular to the piston pin. The rings should turn easily on the piston without sticking or roughness.

3. Engine > Cylinders and Pistons

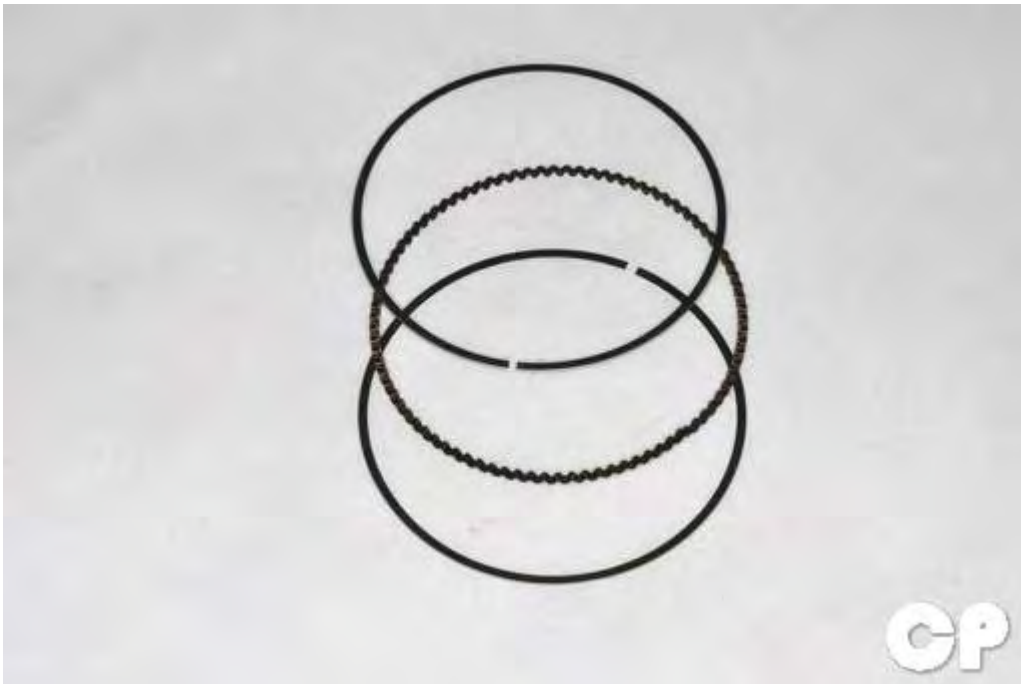

Install the oil expander ring so that the ends are not overlapping. Install the steel rails above and below the oil ring.

Lubricate the piston pin and the small end of the connecting rod with fresh engine oil.



The "IN" mark should face the intake side (rear) of the engine.

3. Engine > Cylinders and Pistons



Place the piston over the connecting rod. Insert the piston pin into the piston and rod.



Install new piston pin clips securely into their grooves. Turn the gap in the clips away from the access gap.



Make sure the cylinder head mating surface is clean. Install the two dowel pins as shown.

3. Engine > Cylinders and Pistons



Install the new base gasket onto the crankcase.



3. Engine > Cylinders and Pistons

Coat the inside of the cylinder, piston rings, and piston in fresh engine oil. Lower the cylinder over the studs and guide the piston into the cylinder while you are compressing the rings with your fingers. Be careful to not damage the rings during this step. Bring the cam chain and guide through the opening.



Thread in the two cylinder bolts on the right side of the engine.



Fit the coolant hose to the cylinder. Tighten the cylinder coolant hose clamp to securely with a #2 Phillips screwdriver.



Insert the lower cam chain guide and make sure it is seated correctly.

3. Engine > Cylinders and Pistons

Install the cylinder head. See the Cylinder Head topic.

Install the camshaft. See the Camshaft topic for more information.

Install the cylinder head cover. See the Cylinder Head Cover topic for more information.

Install the engine into the frame. See the Engine Installation topic for more information.

A.C. Generator and Starter clutch

SAFETY FIRST: Protective gloves and eyewear are recommended at this point.

Removal

Generator Cover

Remove the following components -

- # Seat
- # Luggage Box
- # Center Cover
- # Rear Carrier
- # Body Cover
- # Front Cover
- # Front Lower Cover
- # Foot Skirt

Drain engine oil and remove the oil filter. See the Engine Oil topic for more information.

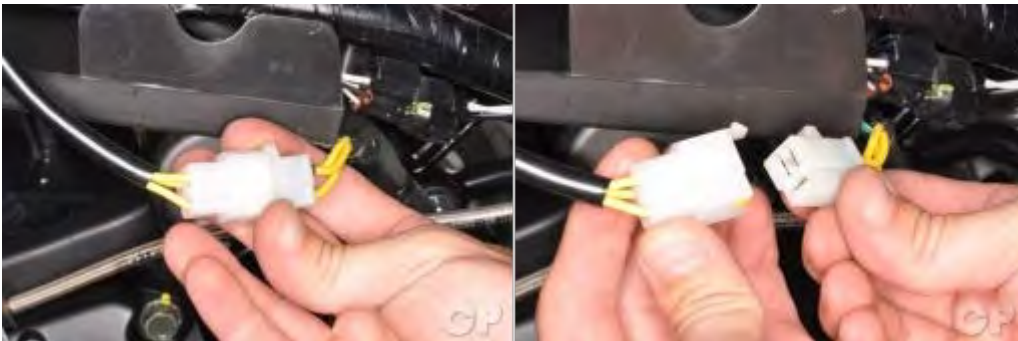

Disconnect the generator 3-pin connector.



Disconnect the crank position sensor wire coupler.

3. Engine > Generator



Loosen the water pump hose clamp with a #2 Phillips screwdriver. Slide up the clamp and free the coolant hose from the water pump. Allow any remaining coolant to drain into a suitable container.



Loosen the right crankcase coolant hose clamp with a #2 Phillips screwdriver. Slide up the clamp and free the coolant hose from the right crankcase cover. Allow any remaining coolant to drain into a suitable container.



3. Engine > Generator



Remove the 12 generator cover bolts with an 8 mm socket. Note the upper most bolt holds a wire stay.



Utilize the pry points and remove the generator cover.



Remove the generator cover gasket.



Remove the two dowel pins.

3. Engine > Generator



Remove the two oil filter chamber O-rings. Inspect the O-rings and replace them as needed.

Stator and Pulsar Coil/Crank Position Sensor

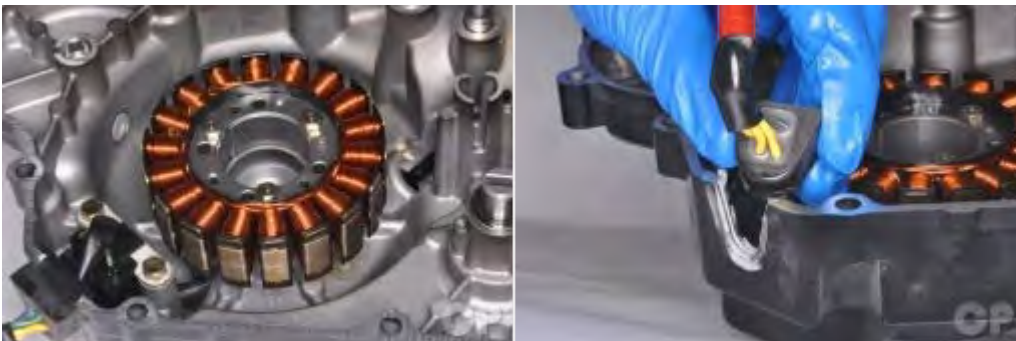

Free the rubber wire grommet from the right crankcase cover.



Remove the three stator mounting bolts and the two crank position sensor bolts with an 8 mm socket. Remove the stator and the crank position sensor together.

Flywheel



To remove the fly wheel two special tools are needed.

ITEM	TOOL NO.
UNIVERSAL HOLDER	E021



ITEM	TOOL NO.
FLYWHEEL PULLER	E003

3. Engine > Generator



Hold the flywheel with the universal holder and loosen the nut with a 19 mm socket.



Remove the flywheel nut and washer.

3. Engine > Generator



Apply grease to the threads of the flywheel puller tool before using it. Thread the puller onto the flywheel. Hold the tool with a large wrench and turn in the bolt until the pressure separates the flywheel from the crankshaft.



Remove the flywheel from the crankshaft.

3. Engine > Generator



Slide the starter driven gear off of the crankshaft.



Remove the woodruff key from the crankshaft.

3. Engine > Generator

Starter Clutch



Remove the starter idle gear and shaft from the crankcase.

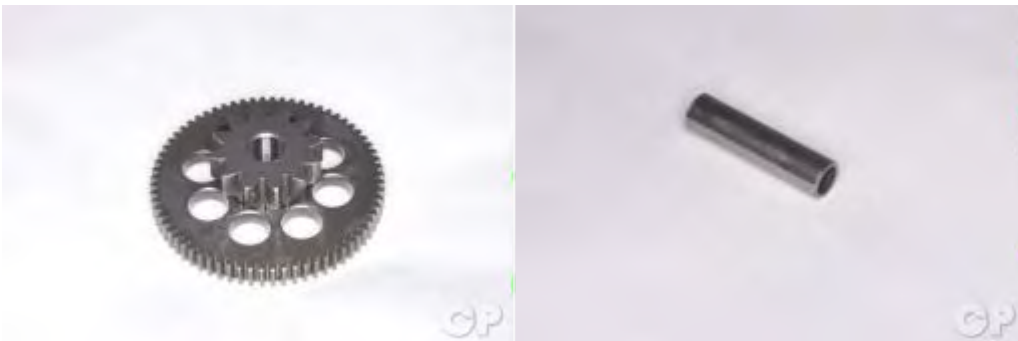

Inspect the starter idle gear and shaft for wear and damage. Replace the idle gear and shaft as needed.

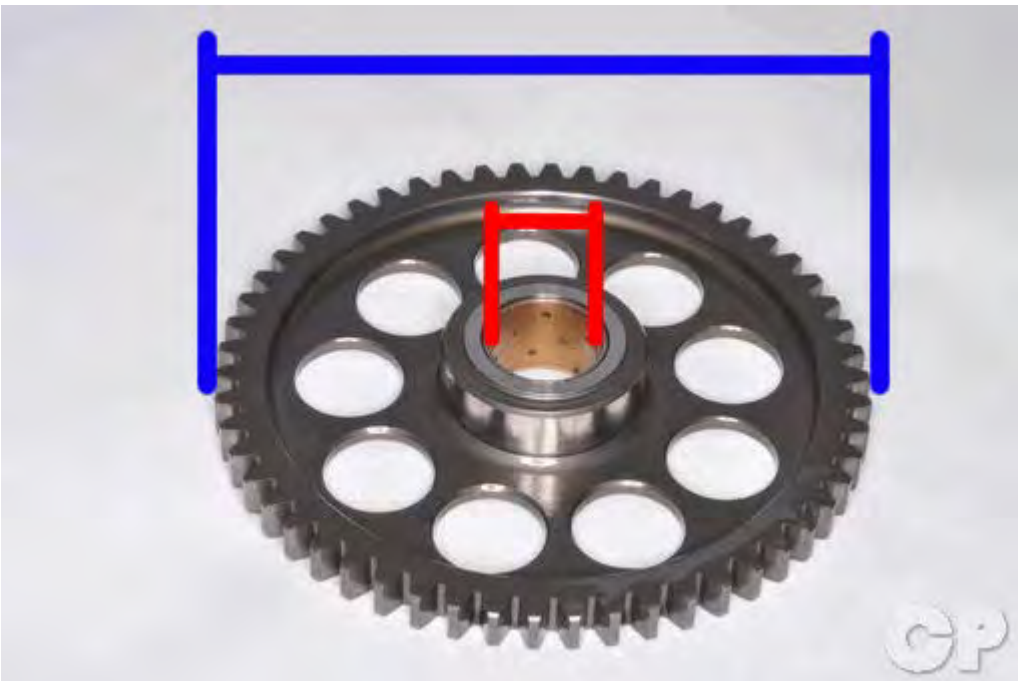

Inspect the starter driven gear for wear and damage. Measure the inside and outside diameter of the starter driven gear and replace it as needed.

3. Engine > Generator

Item	Service Limit (mm)
Starter drive gear I.D.	22.15
Starter drive gear O.D.	41.50



Fit the boss of the starter driven gear into the starter clutch. The starter clutch should only allow the driven gear to turn in one direction. If the starter clutch allows turning both ways or will not let the driven gear rotate smoothly in one direction the starter clutch must be replaced.

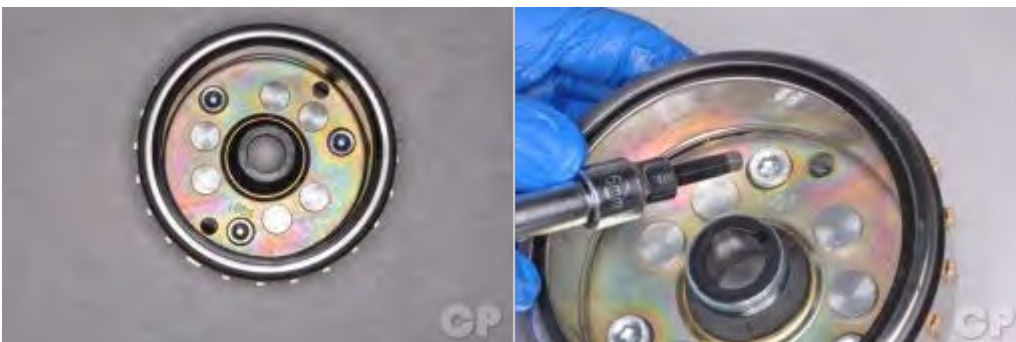

Remove the three starter clutch mounting bolts with a 6 mm Allen socket.

Installation

Starter Clutch



Fit the starter clutch to the back of the flywheel. Apply blue Loctite to the threads of the three starter clutch mounting bolts. Insert the three starter clutch mounting bolts.

3. Engine > Generator



Tighten the starter clutch mounting bolts to specification with a 6 mm Allen socket.

Item	Qty	Thread size (mm)	Torque	
			kgf-m	lb-ft
Oneway clutch bolt	3	8	1.8-2.2	13.02-15.91



Lubricate the starter idle gear shaft with fresh engine oil. Install the starter idle gear and shaft into the crankcase.

3. Engine > Generator

Flywheel



Install the woodruff key into its slot on the end of the crankshaft.



Lubricate the inside of the starter driven gear with fresh engine oil. Slide the starter driven gear onto the flywheel as shown.

Clean off the tapered end of the crankshaft where the flywheel will ride and make sure the inside of the flywheel is oil free where it will contact the crankshaft.

3. Engine > Generator



Line up the groove in the flywheel with the key and fit the flywheel onto the crankshaft. Guide the starter driven gear into the starter clutch on the back of the flywheel.



Install the washer and flywheel nut.



Hold the flywheel with the universal holder and torque the flywheel nut to specification with a 19 mm socket.

Item	Qty	Thread size (mm)	Torque	
			kgf-m	lb-ft
ACG flywheel nut	1	14	5.5-6.5	39.78-47.01

ITEM	TOOL NO.
UNIVERSAL HOLDER	E021

3. Engine > Generator

Stator and Crank Position Sensor



Fit the stator and the crankshaft position sensor into the generator cover together as shown. Insert the two crank position sensor mounting bolts and the three stator mounting bolts. Tighten the bolts securely with an 8 mm socket.



Coat the rubber grommet in silicone sealant where it contacts the generator cover. Fit the rubber wire grommet into its cutout in the crankcase cover.

3. Engine > Generator

Generator Cover



Make sure the generator cover mating surface is clean. Install the two dowel pins and a new generator cover gasket.



3. Engine > Generator



Make sure the oil filter chamber O-rings are in place and in good condition.



Fit the generator cover into place. Make sure the water pump shaft engages correctly with the oil pump shaft.

3. Engine > Generator



Insert the 12 generator cover bolts. Note the upper most bolt holds a wire stay. Tighten the bolts securely in a with an 8 mm socket.



Fit the coolant hose to the right crankcase cover pipe. Secure the hose with the clamp and tighten the coolant hose clamp securely with a #2 Phillips screwdriver.

3. Engine > Generator



Connect the coolant hose to the water pump. Move the clamp into place and tighten it securely with a #2 Phillips screwdriver.



Plug in the regulator/rectifier 3-pin connector.

3. Engine > Generator



Plug in the crank position sensor wire coupler on the right side of the frame.

Fill the engine oil. See the Engine Oil topic for more information.

Install the exhaust system. See the Exhaust System topic for more information.

Fill the coolant and bleed the coolant. See the Coolant topic for more information.

Install the following components-

- ! Foot Skirt
- ! Front Lower Cover
- ! Front Cover
- ! Body Cover
- ! Rear Carrier
- ! Center Cover
- ! Luggage Box
- ! Seat

Oil Pump

SAFETY FIRST: Protective gloves and eyewear are recommended at this point.

GENERAL INSTRUCTIONS

The maintenance of lubrication system can be performed with the engine installed in the frame. Use care when removing and installing the oil pump not to allow dust and foreign matters to enter the engine and oil line.

Do not attempt to disassemble the oil pump. The oil pump must be replaced as a set when it reaches its service limit.

After the oil pump is installed, check each part for oil leaks.

TROUBLESHOOTING

Oil level too low

1. Natural oil consumption
2. Oil leaks
3. Worn or poorly installed piston rings
4. Worn valve guide or seal

Poor lubrication pressure

1. Oil level too low
2. Clogged filter or oil passages
3. Not using the specified oil

Oil Pump Removal

Drain the engine oil. See the Engine Oil topic for more information.

Remove the generator cover, flywheel, starter idle gear and starter driven gear. See the Generator topic.

3. Engine > Oil Pump



The oil pump is driven by a chain off of the crankshaft.



Loosen the two oil pump cover bolts with an 8 mm socket.

3. Engine > Oil Pump



Remove the two oil pump cover bolts and the oil pump cover.



Remove the snap ring on the oil pump shaft with snap ring pliers.



Remove the oil pump drive chain and driven sprocket.

3. Engine > Oil Pump



Inspect the oil pump drive chain and sprocket for signs of wear and damage. Replace the parts as needed.



Remove the two oil pump screws with an impact #3 Phillips screwdriver.



Remove the oil pump.

3. Engine > Oil Pump



Turn the oil pump shaft by hand and make sure it turns smoothly. If the oil pump shaft will not rotate smoothly the oil pump should be replaced with a new unit.

Oil Pump Installation



Fit the oil pump into place so that the arrow is pointing up.

3. Engine > Oil Pump



Insert the two oil pump mounting screws and tighten them securely with an impact #3 Phillips screwdriver.



Fit the oil pump driven sprocket into the drive chain. Install the gear onto the oil pump shaft and fit the chain onto its teeth on the crankshaft.



Install a new snap ring into its groove with snap ring pliers.

3. Engine > Oil Pump



Install the oil pump cover and its two mounting bolts.



Tighten the two oil pump cover bolts securely with an 8 mm socket.

Install the starter driven gear, flywheel, and the generator cover. See the Generator topic.

Fill the engine oil. See the Engine Oil topic for more information.

Crankcase

SAFETY FIRST: Protective gloves and eyewear are recommended at this point.

Splitting

Drain the engine oil and remove the strainer screen. See the Engine Oil topic for more information.

Remove the engine. See the Engine Removal topic for more information.

Remove the cylinder head cover. See the Cylinder Head Cover topic for more information.

Remove the camshaft sprocket. See the Camshaft topic for more information.

Remove the cylinder head. See the Cylinder Head topic for more information.

Remove the generator cover, flywheel, starter idle gear and starter driven gear. See the Generator topic.

Remove the starter motor. See the Starter Motor topic for more information.

Remove the oil pump. See the Oil Pump topic for more information.

Remove the CVT pulleys and belt. See the CVT Removal topic.

Remove the rear wheel. See the Rear Wheel topic for more information.



Remove the upper cam chain guide bolt with an 8 mm Allen.

3. Engine > Crankcase

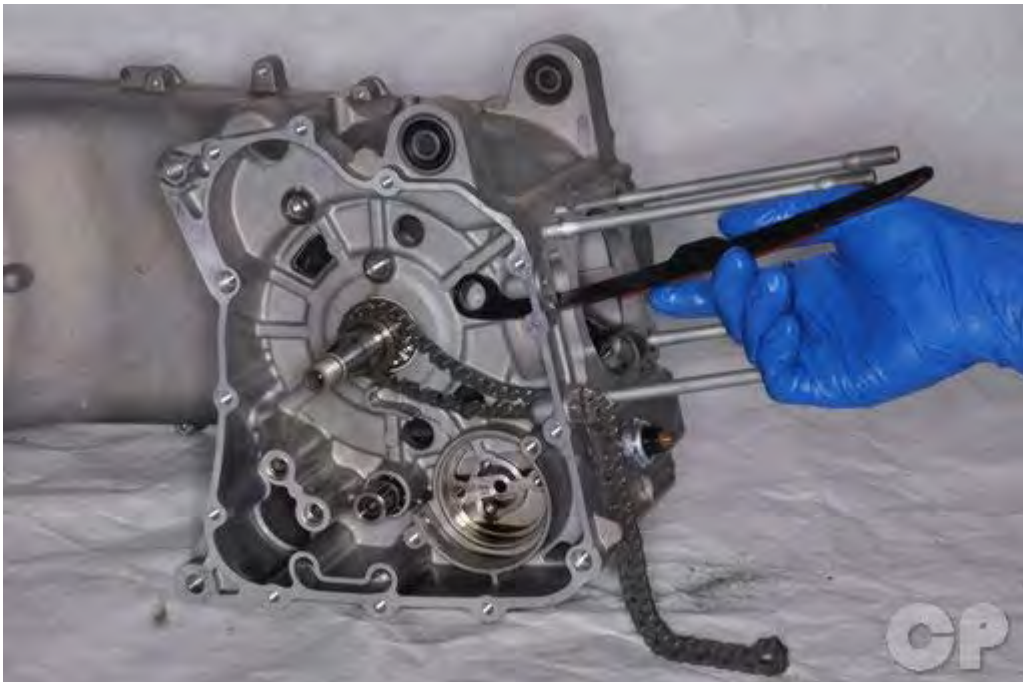

Remove the upper cam chain guide.



Inspect the cam chain guides for damage and excessive wear. Replace the guides as needed.

3. Engine > Crankcase



Remove the cam chain from the crankshaft and crankcase. Inspect the cam chain for wear and damage. Replace the cam chain as needed.

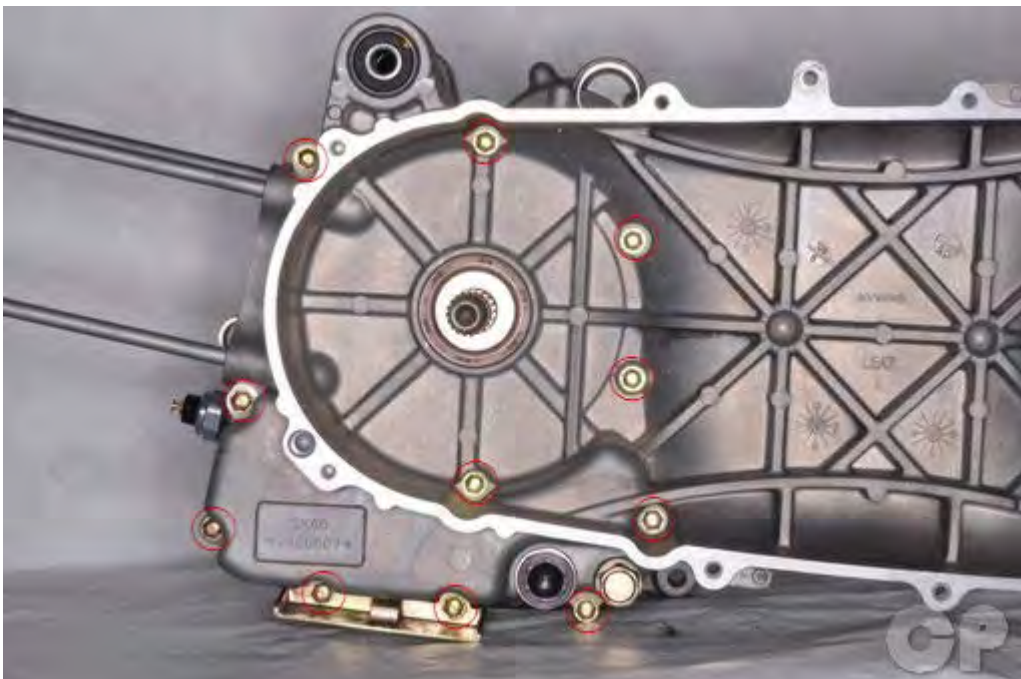

There are 11 crankcase bolts.

3. Engine > Crankcase



Loosen the 11 crankcase bolts in a crisscross pattern with an 8 mm socket. Remove the crankcase bolts from the left side of the engine.

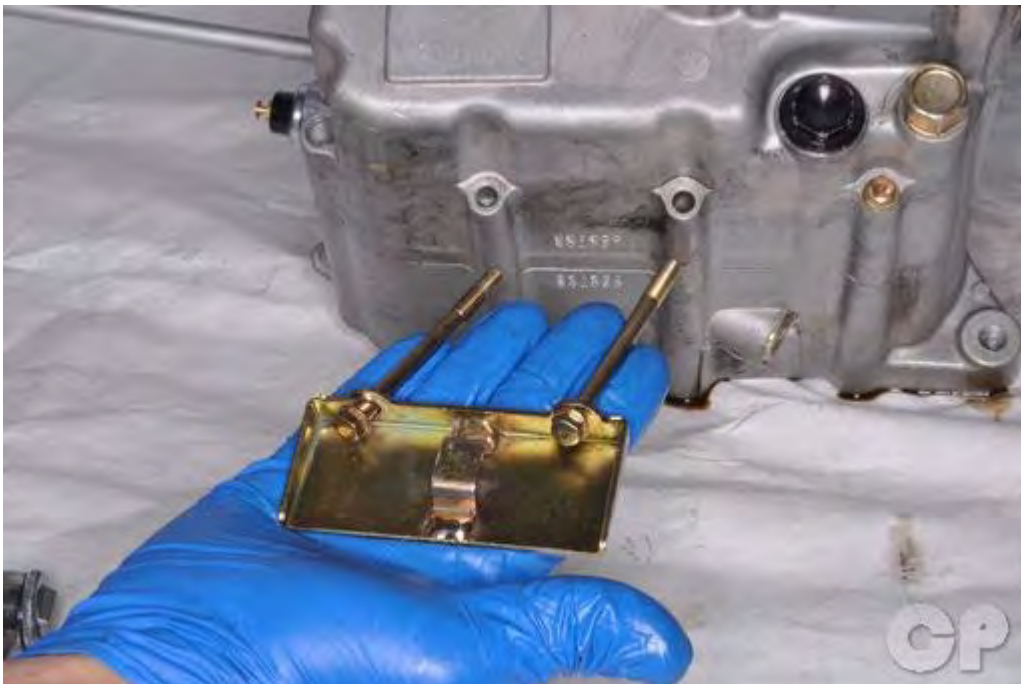

Remove the plate with the bottom two crankcase bolts.

3. Engine > Crankcase



Set the crankcases on the right side.



Separate the halves of the crankcase. If needed gently tap the reinforced areas of the right crankcase half with a rubber mallet. Lift the right crankcase off of the left.

3. Engine > Crankcase



Remove the three dowel pins from the crankcase. Inspect the O-ring and replace it as needed.

3. Engine > Crankcase

To remove the crankshaft see the Crankshaft topic.



Replace the left crankshaft seal if the crankcases are separated.



Remove the seal with a seal pick.

3. Engine > Crankcase



Drive the new seal into the left crankcase from the outside with a suitable driver. The driver should have the same outside diameter as the seal. Lubricate the new crankshaft seal lips with fresh engine oil.

Assembly

Thoroughly clean the crankcase mating surface.

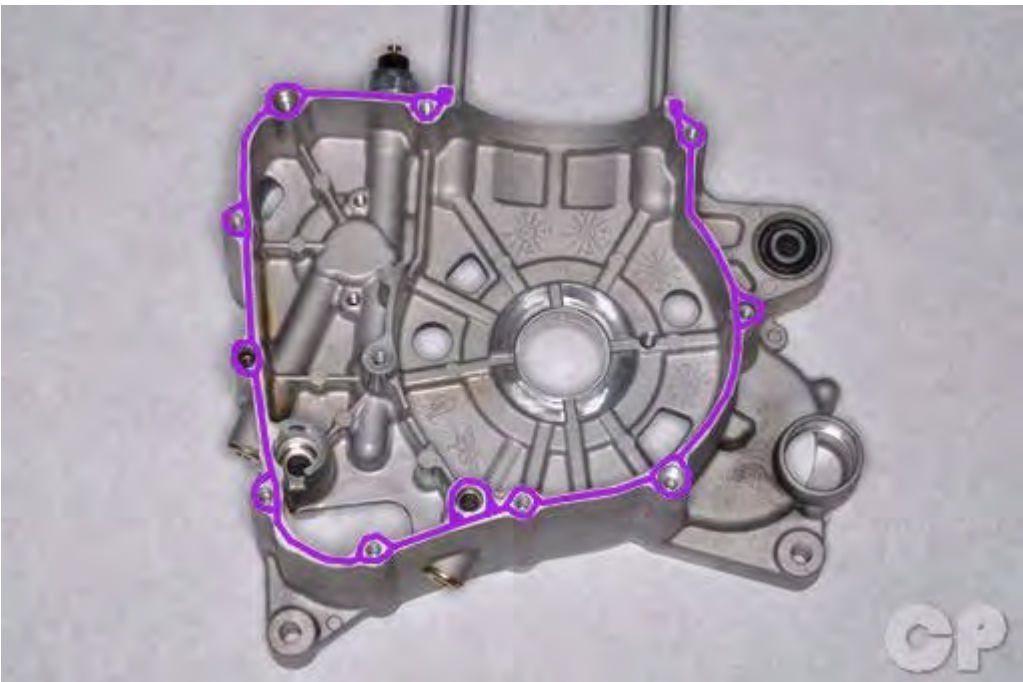

Apply sealant uniformly to the crankcase mating surface as indicated. Do not allow sealant to enter oil passages or get in bearings.

3. Engine > Crankcase



Set the right case half down on top of the left. Install the engine mount spacer.

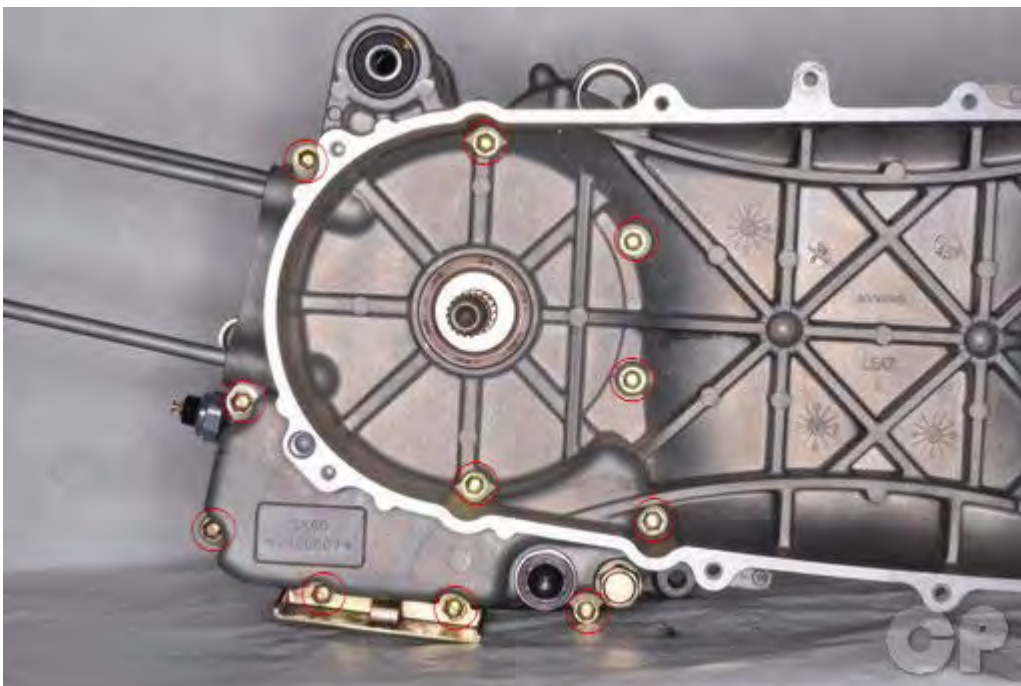

Insert the 11 crankcase bolts. The plate goes on with the bottom two bolts.

3. Engine > Crankcase



Tighten the bolts securely and evenly in a crisscross pattern with an 8mm socket.



Install the cam chain around the timing sprocket teeth on the crankshaft.

3. Engine > Crankcase

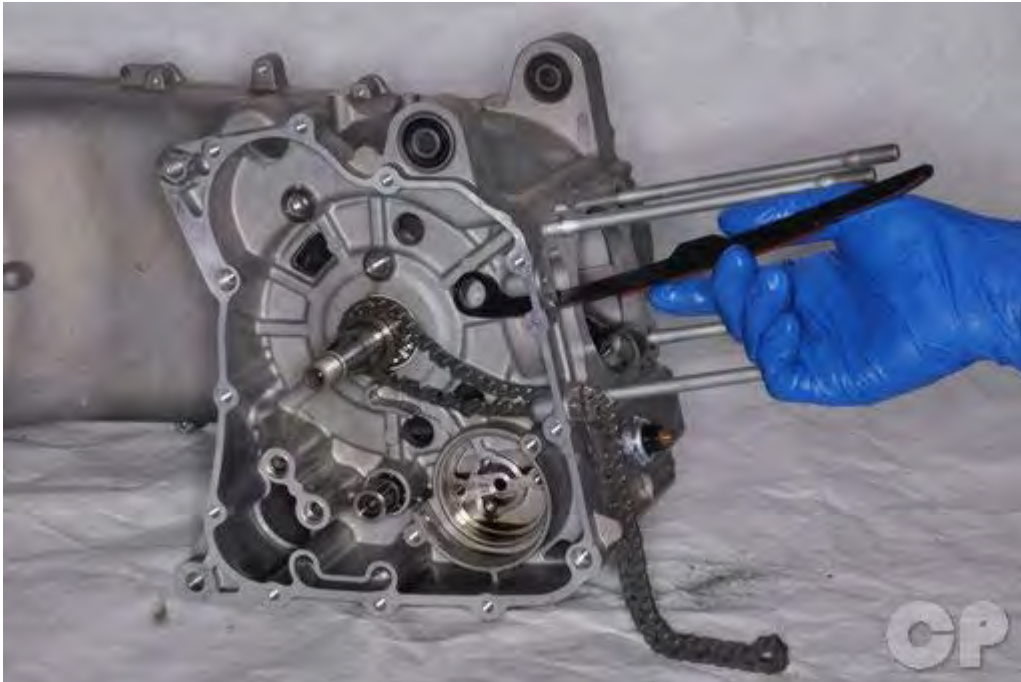

Fit the upper cam chain guide into place.



Insert the upper cam chain guide mounting bolt and tighten it to specification with an 8 mm Allen socket.

Item	Qty	Thread Size(mm)	Torque	
			kgf-m	lb-ft
Cam chain tensioner pivot	1	8	0.8-1.2	5.79 - 8.68

Install the oil pump. See the OilPump topic for more information.

Install the starter idle gear, driven gear, flywheel, and the generator cover. See the Generator topic.

Install the starter motor. See the StarterMotor topic for more information.

Install the CVT pulleys and belt. See the CVTInstallation topic for more information.

3. Engine > Crankcase

Install the cylinder and piston. See the [CylinderandPiston](#) topic for more information.

Install the cylinder head. See the [CylinderHead](#) topic.

Install the camshaft. See the [Camshaft](#) topic for more information.

Install the cylinder head cover. See the [Cylinder Head Cover](#) topic for more information.

Install the rear wheel. See the [Rear Wheel](#) topic for more information.

Install the engine into the frame. See the [Engine Installation](#) topic for more information.

3. Engine > Crankshaft

Crankshaft

SAFETY FIRST: Protective gloves and eyewear are recommended at this point.

Removal

Split the crankcases. See the Crankcase topic for more information.



Lift the crankshaft out of the left crankcase half.

3. Engine > Crankshaft



Remove the thrust washer from the right side of the crankshaft.

Crankshaft Inspection



Check the side clearance of the big end of the connecting rod with a feeler gauge.

3. Engine > Crankshaft

	Item	Standard (mm)	Service Limit (mm)
Crankshaft	Connecting rod big end side clearance	0.15 - 0.35	0.6



Grip the small end of the connecting rod and try and push the rod down towards the crank weights. If there is definite play between the connecting rod and crank the crankshaft should be replaced.

Crankshaft Bearings



Inspect the crankshaft bearings for signs of damage and wear. Replace the bearings if they show any kind of imperfection. Note the bearing color code and crankcase code.

The crank weights are also marked with a size code.

Bearing Color				
Crankshaft mark	Crankshaft mark			
	A	B	C	D
A	black	green	green	red
B	green	green	red	----

When the crankshaft and or crankcases must be replaced also replace both crank bearings according to the chart below.

3. Engine > Crankshaft

Installation



Place the thrust washer on the crankshaft as shown.

Lubricate the connecting rod big end and crankshaft shaft bearings with fresh engine oil.



Fit the crankshaft into the left crankcase bearing. Take care to avoid damaging the new oil seal.

Join the crankcases. See the Crankcase topic for more information.

3. Engine > Engine Installation

Engine Installation

SAFETY FIRST: Protective gloves and eyewear are recommended at this point.

Before the engine is returned to the install the rear wheel. See the Rear Wheel topic for more information.



Set the chassis on its center stand. Use a jack to support the engine. Guide the engine into the back of the frame.



3. Engine > Engine Installation



Fit the engine mounting bracket and damper assembly into place.



Install the two engine mounting bracket to frame mounting bolts and nuts. Insert the bolts from the outside of the frame.



Insert the engine mounting bracket and damper bolt from the right side. Thread on the nut.



Install the engine mounting bracket damper washer and nut.



Hold the engine mounting bolts with a 14 mm wrench and torque the nuts to specification with a 19 mm socket.

Item	Qty	Thread size (mm)	Torque		Remarks
			kgf-m	lb-ft	
Engine hanger: Frame side	2	14	6.0-7.0	43.40-50.63	U-nut



Tighten the engine mounting bracket damper bolt and nut with a 17 mm wrench for the nut and a 14 mm socket for the bolt.

Item	Qty	Thread size(mm)	Torque		Remarks
			kgf-m	lb-ft	
Engine hanger: Engine side	1	10	4.5-5.5	32.55-39.78	U-nut



Tighten the damper nut securely with a 14 mm socket.

Install the rear shock absorbers. See the Shock Absorbers topic for more information.



Route the wiring harness through its guide above the intake pipe.



Plug in the oil pressure switch bullet connector.



Route the starter motor lead to the starter motor and secure it in the stay on the right crankcase cover.



Fit the starter motor cable lead onto the terminal and thread on the nut. Tighten the starter motor lead nut securely with a 10 mm wrench.



Fit the rubber starter motor lead cover into place.



Install the main engine ground to the right side of the engine. Tighten the main engine ground bolt securely with an 8 mm socket.



Install air bleed hose and secure it with the clamp.



Connect the coolant hose to the thermostat. Move the clamp into place and tighten it securely with a #2 Phillips screwdriver.



Connect the coolant hose to the water pump. Move the clamp into place and tighten it securely with a #2 Phillips screwdriver.

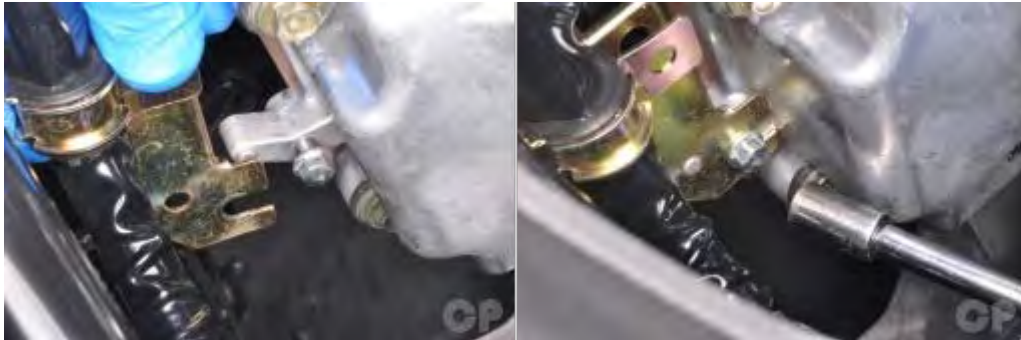

Fit the fuel stay into place. Tighten the stay bolt securely with an 8 mm socket.



Plug in the thermo sensor unit and ground connectors.



Plug in the water temperature sensor connector.

3. Quick Reference > Specifications
General Information

Name & Model No.		LKG7		
Motorcycle Name & Type		K-XCT300i		
Overall length (mm)		2145		
Overall width (mm)		800		
Overall height (mm)		1290		
Wheel base (mm)		1450		
Engine type		4 stroke OHC		
Displacement (cc)		298.9		
Fuel recommended		90 # nonleaded gasoline		
Net weight (kg)	Front wheel	76		
	Rear wheel	106.5		
	Total	182.5		
Max. weight capacity (kg)	Front wheel	138		
	Rear wheel	220		
	Total	358		
Tires	Front wheel	120/70-14		
	Rear wheel	150/70-13		
Ground clearance (mm)		140		
Performance	Braking distance (m)	7.9m / 40 km/hr		
	Min. turning radius (m)	2.45		
Engine	Starting system		Starting motor	
	Type		Gasoline, 4-stroke	
	Cylinder arrangement		SINGLE CYLINDER	
	Combustion chamber type		Semi-sphere	
	Valve arrangement		O.H.C. Chain drive	
	Bore x stroke (mm)		72.7 x 72	
	Compression ratio		10.8:1	
	Compression pressure		16 (kg/cm ²), 228 (psi)	
	Max. Horsepower		28 / 7750 PS/rpm	
	Max. Torque		2.7 / 6500 Kg-m/rpm	
	Valve timing	Intake	Open	9.5° BTDC
			Close	37.5° ABDC
		Exhaust	Open	40° BBDC
			Close	10° ATDC
	Valve clearance (cold) (mm)		Intake	0.10
			Exhaust	0.10
Idle speed (rpm)		1600 ± 100		
Lubrication System		Lubrication type	Forced pressure & Wet pump	
		Oil pump type	Inner/outer rotor type	
		Oil filter type	Full-flow filtration	
		Oil capacity	1.5 liter	
Cooling Type		Liquid cooling		
Fuel System	Air cleaner type & No		Paper element, wet	
	Fuel capacity		10 liter	
	Injection	Brand	Keihin	
		Type	Throttle body	
		Venturi dia.(mm)	34	
Fuel pump pressure		3.0 Bar		

3. Quick Reference > Specifications

Electrical Equipment	Ignition System	Type		ECU
		Ignition timing		8° - 12° BTDC
		Spark plug	Spec	CR7E (NGK)
	Gap		0.6-.7mm	
Battery Capacity		12V10AH		
Power Drive System	Clutch Type		Dry multi-clutch	
	Transmission Gear	Type		CVT
	Reduction Gear	Operation		Automatic centrifugal type
		Type		Two-stage reduction
		Reduction ratio	1st	2.24 ~ 0.72
2nd	7.222			
Moving Device	Tire type		Tubeless	
	Wheel material		Aluminum	
	Tire pressure Kg/cm2 (psi)		Front	2.0 (28.4)
			Rear	2.25 (32)
	Handle turning angle(L/R)		Left	40°
Right			40°	
Brake system type		Front	Wavy Disc brake	
		Rear	Disc brake	
Damping Device	Suspension type		Front	Telescope
			Rear	Swing arm
	Shock absorber stroke		Front	110 mm
			Rear	93 mm
Frame type		UNDER BONE		

ENGINE		
Throttle grip free play	2 ~ 6 mm	
Spark plug	NGK: CR7E	
Spark plug gap	0.6 mm ~ 0.7 mm	
Valve clearance	IN: 0.10 mm	EX: 0.10 mm
Idle speed	1600 ± 100 rpm	
Cylinder compression	16 ± 2 kg/cm2	228 ± 28.4 psi
Ignition timing	ECU	
Coolant type	Coolant type	
Engine oil capacity		
At disassembly	1.5 Liter	
At change	1.3 Liter	
Gear oil type:	SAE 90	
Gear oil capacity		
At disassembly	0.23 Liter	
At change	0.21 Liter	

3. Quick Reference > Specifications

Coolant capacity	
Radiator	766 cc
Hose with cool coolant	169 cc
Hose with hot coolant	194 cc
Reserve tank	590 cc
Total capacity	1719 cc

Engine

Item		Standard (mm)
Valve clearance (cold)	IN	0.10
	EX	0.10
Cylinder head compression pressure		16 kg/cm ² , 228 psi
Camshaft cam heigh	IN	34.2987
	EX	34.1721
Valve rocker arm I.D	IN	10.00 - 10.015
	EX	10.00 - 10.015
Valve rocker arm shaft O.D	IN	9.972 - 9.987
	EX	9.972 - 9.987
Valve seat width	IN	1.2
	EX	1.2
Valve stem O.D	IN	4.990 - 4.975
	EX	4.990 - 4.975
Valve guide I.D	IN	5.00 - 5.012
	EX	5.00 - 5.012
Valve stem-to-guide clearance	IN	0.010 - 0.037
	EX	0.010 - 0.037

Item		Standard (mm)	
Cylinder	I.D.	72.7	
	Taper limit	0.05	
	Out of round limit	0.05	
Piston piston ring	Ring-to-groove clearance	Top	0.015 - 0.055
		Second	0.015 - 0.055
	Ring end gap	Top	0.10 - 0.25
		Second	0.10 - 0.25
		Oil side rail	0.2 - 0.7
	Piston O.D	72.67 - 72.69	
	Piston O.D. measuring point	9 mm from bottom of skirt	
Piston-to-cylinder clearance	0.101 - 0.040		
Piston pin hole I.D.	15.002 - 15.008		
Piston pin O.D	14.994 - 15.000		
Piston-to-piston pin clearance	0.002 - 0.014		
Connecting rod small end I.D. Bore	15.016 - 15.034		

3. Quick Reference > Specifications

Item		Standard (mm)	Service Limit (mm)
Crankshaft	Connecting rod big end side clearance	0.15 - 0.35	0.6
	Connecting rod big end radial clearance	0 - 0.008	0.05

Bearing Color				
Crankcase mark				
Crankshaft mark	A	B	C	D
A	black	green	green	red
B	green	green	red	---

Item	Service Limit (mm)
Starter drive gear I.D	22.15
Starter drive gear O.D.	41.50

CVT

Item	Standard (mm)	Service Limit (mm)
Clutch lining thickness	4.0	2.0
Clutch outer I.D.	152.1 - 152.2	152.2
Weight roller O.D (Drive Pulley)	19.92 - 20.08	20.08

Cooling System

Radiator cap relief pressure	0.9 ± 0.15 kg/cm ² (12.8 ± 2.1 psi)	
Thermostat temperature	Begins to open	71 °C
	Full-open	80 °C
	Valve lift	3.5 - 4.5 mm
Coolant capacity	Total 1719 cc	Radiator: 766 cc Reserve tank: 590 cc Hose: 363 cc

3. Quick Reference > Specifications

COOLANT MIXTURE (WITH ANTI-RUST AND ANTI-FREEZING EFFECTS)			
Freezing Point	Mixing Rate	Coolant Concentrate	Distilled Water
-9°C	20%	344 cc	1375 cc
-15°C	30%	516 cc	1203 cc
-25°C	40	688 cc	1031 cc
-37°C	50%	860 cc	859 cc
-44.5°C	55%	945 cc	774 cc

COOLANT GRAVITY CHART						
Temp. C° Coolant concentration	0	5	10	15	20	25
5%	1.009	1.009	1.008	1.008	1.007	1.006
10%	1.018	1.107	1.017	1.016	1.015	1.014
15%	1.028	1.027	1.026	1.025	1.024	1.022
20%	1.036	1.035	1.034	1.033	1.031	1.029
25%	1.045	1.044	1.044	1.042	1.040	1.038
30%	1.053	1.051	1.051	1.049	1.047	1.045
35%	1.063	1.065	1.060	1.058	1.056	1.054
40%	1.072	1.070	1.068	1.066	1.064	1.062
45%	1.080	1.078	1.076	1.074	1.072	1.069
50%	1.086	1.084	1.082	1.080	1.077	1.074
55%	1.095	1.093	1.091	1.088	1.085	1.082
60%	1.100	1.098	1.095	1.092	1.089	1.086

Temp. C° Coolant concentration	30	35	40	45	50
5%	1.005	1.003	1.001	0.009	0.99
10%	0.013	1.011	1.009	1.007	1.005
15%	1.020	1.018	1.016	1.014	1.012
20%	1.027	1.025	1.023	1.021	1.019
25%	1.036	1.034	1.031	1.028	1.025
30%	1.043	1.041	1.038	1.035	1.032
35%	1.052	1.049	1.046	1.043	1.040
40%	1.059	1.056	1.053	1.050	1.047
45%	1.056	1.063	1.062	1.057	1.054
50%	1.071	1.068	1.065	1.062	1.059
55%	1.079	1.076	1.073	1.070	1.067
60%	1.083	1.080	1.077	1.074	1.071

3. Quick Reference > Specifications
Fuel Injection System

ITEM		SPECIFICATIONS
Throttle body identification number		LKG7
Idle speed		1620 ± 100 rpm
Throttle grip free play		2 - 6 mm (1/16 - 1/4 in)
Fuel injector resistance (at 20°C/68°F)		11.7 ± 0.6 9Ω
Fuel pump resistance(at 20°C/68°F)	Float at full position	1100 ± 33 9Ω
	Float at empty position	100 ± 3 9Ω
Fuel pump standard pressure (at 40L/Hr)		294 ± 6 kPa (3 Bar)
Water temperature sensor resistance	At -20°C/-4°F	18.8 KΩ
	At 40°C/104°F	1.136 KΩ
	At100°C/212°F	0.1553 KΩ
Intake pressure sensor (MAP) pressure(at 1 - 4.2V)	13.332 kPa (0.13332 kgf/ cm ² , 1.89 psi) - 119.99 KPa (1.1999 kgf/ cm ² , 17.04 psi)	
Inductive ignition coil	Primary: 3.57 - 4.83Ω Secondary: 10.42~14.49KΩ	
Throttle position sensor (TPS) resistance (at 20°C/68°F)	3500 - 6500Ω	
Crank position sensor voltage (at 200rpm)	100 - 130Ω	
O2 heater sensor resistance (at 20C/68°F)	6.7 - 9.5Ω (engine warming condition)	
Tilt switch voltage	Standard	0.4 - 1.4 V
	Over 65° (fall down)	3.7 - 4.4 V

3. Quick Reference > Specifications

CELP FAILURE CODES LIST				
Failure	Codes	Contents	Causes	Symptoms
06	P0120	Faulty TPS	<ul style="list-style-type: none"> • Faulty TPS voltage range (0.3 -4.5 V) • Loose or poor connection on TPS Sensor • Open or short circuit on the TP Swire • Faulty TPS itself 	Engine operates normally
09	P0105	Faulty MAP	<ul style="list-style-type: none"> • Faulty MAP voltage range (1 - 4.2V) • Loose or poor connection on MAP Sensor • Open or short circuit on MAP wire • Faulty MAP itself 	Engine operates normally
12	P0115	Faulty WTS (water temp.)	<ul style="list-style-type: none"> • Faulty ECT range (-20°C: 18.8 /40°C: 1.136/100°C: 0.1553) • Loose or poor connection on ECT • Open or short circuit on ECT wire • Faulty ECT 	Engine operates normally
15	P1630	Faulty Tilt switch (Roll)	<ul style="list-style-type: none"> • Faulty Tilt switch voltage range (inclined angle <65°: 0.4 - 1.4 V/ Inclined angle >65°: 3.7 - 4.4 V) • Loose or poor connection on Tilt switch • Open or short circuit in Tilt switch wire • Faulty tilt switch 	Engine operates normally
17	P0130	Faulty O2 sensor	<ul style="list-style-type: none"> • Faulty O2 sensor voltage range(A/F below 14.7: > 0.7V/ A/F over14.7: < 0.18 V) • Loose or poor connection on O2 sensor • Open or short circuit on O2 sensor wire • Faulty O2 sensor 	Engine operates normally
33	P0201	Faulty injector (Nozzle)	<ul style="list-style-type: none"> • Faulty Fuel injector range(9.945 - 13.5) • Loose or poor connection on injector • Open or short circuit on injector wire • Faulty fuel injector 	Engine fails to be operated
37	P0351	Faulty inductive ignition coil	<ul style="list-style-type: none"> • Faulty Inductive ignition coil !range (4.2 ! ± 15%) • Loose or poor connection on inductive ignition coil • Open or short circuit on inductive ignition coil wire • Faulty inductive ignition coil 	Engine fails to be operated
41	P0230	Faulty fuel pump	<ul style="list-style-type: none"> • Faulty Fuel pump fl range (F:1100 ± 33 ! E: 100 + 3 !) • Loose or poor connection on fuel pump • Open or short circuit on fuel pump wire • Faulty fuel pump 	Engine fails to be operated
45	P0135	Faulty O2 sensor heater	<ul style="list-style-type: none"> • Faulty O2 sensor heater ! range(6.7 -9.5 !) • Loose or poor connection on O2 sensor heater • Open or short circuit on O2 sensor heater wire • Faulty O2 sensor heater 	Engine starts normally but not smooth
49	P1505	Faulty ISC	<ul style="list-style-type: none"> • Loose or poor contacts on ISC • Open or short circuit in ISC wire • Faulty ISC 	Engine operates normally
66	P0335	Faulty CPS	<ul style="list-style-type: none"> • Loose or poor connection on CPS sensor • Open or short circuit on CPS wire • Faulty CPS sensor 	Engine starts normally but not smooth

3. Quick Reference > Specifications
Axle/Brakes/Wheels

Item	Standard mm (in)	Service Limit
Axle shaft run out	–	0.2 mm(0.008 in)
Brake disk thickness (front)	3.8 - 4.2(0.15 - 0.165)	0.3 mm(0.012 in)
Brake disk thickness (rear)	5.0 (0.2)	–
Brake disk run out	–	0.4 mm
Brake master cylinder I.D	12.7 - 12.74(0.508 - 0.5096)	–
Brake master cylinder piston O.D.	12.65 - 12.68(0.506 - 0.5072)	–
Front brake caliper piston O.D	26.93 - 26.96(1.0602 - 1.0614)	–
Front brake caliper cylinder I.D	27 - 27.05(1.063 - 1.065)	–

Item	Standard (mm)
Wheel rim run out service limit	max 5
Rear brake disk thickness	5.0
Rear brake disk run out	max 0.4
Rear brake caliper piston O.D.	25.33 - 25.36
Rear brake caliper cylinder I.D.	25.40 - 25.45

Electrical

Item		Standard	
Battery	Capacity	12V 10AH	
	Voltage (20°C)	Fully charged	13.2V
		Insufficient charged	< 12.3V
	Charging current	1.2A* 5 - 10H	

3. Quick Reference > Specifications

Item		Standard	
Spark plug	Standard type	NGK CR7E	
Spark plug gap		0.6 - 0.7 mm	
Inductive Ignition Coil	Primary coil	3.57 - 4.83Ω	
	Secondary coil without plug cap	10.42 - 14.49 KΩ	
Throttle Position Sensor		3500 - 6500Ω	
Fuel Injector		1.9 9 approx.	
Water Temperature Sensor		2.076 KΩ± 10% (25°C)	
Oxygen Sensor (engine warming condition)		6.7 - 9.5Ω	
Crank Position Sensor		115 9 ± 15 9Ω	
Tilt Switch		0.4V - 1.4V(normal) 3.7V - 4.4V (fall down)	
Water temperature sensor resistance		At -20°C/-4°F	18.8 KΩ
		At 40°C/104°F	1.136 KΩ
		At 100°C/212°F	0.1553 KΩ

Item	Standard	Service Limit
Starter motor brush length	12.5 mm	8.5 mm
Fuse	10A,15A,30A	
Headlight bulb	12V 35W/35W *2	
Turn signal light bulb	12V 21 W(Front) / 10W(Rear)	
Stoplight	12V2W LED	
Taillight	12V0.2W LED	

CVT Continuously Variable Transmission

This chapter covers the location and servicing of the CVT components for the KYMCO K-XCT 300i.

- Belt Case 4-2~4-11
- CVT Removal 4-12~4-31
- CVT Installation 4-32

GENERAL INSTRUCTIONS

- The drive pulley, clutch and driven pulley can be serviced with the engine installed.
- Avoid getting grease and oil on the drive belt and pulley faces. Remove any oil or grease from them to minimize the slipping of drive belt and drive pulley.

TROUBLESHOOTING

Engine starts but motorcycle won't move

- Worn drive belt
- Broken ramp plate
- Worn or damaged clutch lining
- Broken driven face spring

Engine stalls or motorcycle creeps

- Broken clutch weight spring

Lack of power

- Worn drive belt
- Weak driven face spring
- Worn weight roller
- Faulty driven face

Belt Case

SAFETY FIRST: Protective gloves and eyewear are recommended at this point.

Removal

Remove the following components -

- Seat
- Luggage Box
- Center Cover
- Rear Carrier
- Body Cover
- Front Cover
- Front Lower Cover
- Foot Skirt



Disconnect the drain hose from the plastic belt case cover.



Remove the belt case plastic cover bolts with an 8 mm socket.



Remove the belt case bodywork.



Inspect the plastic belt case cover and replace it if it is damaged.

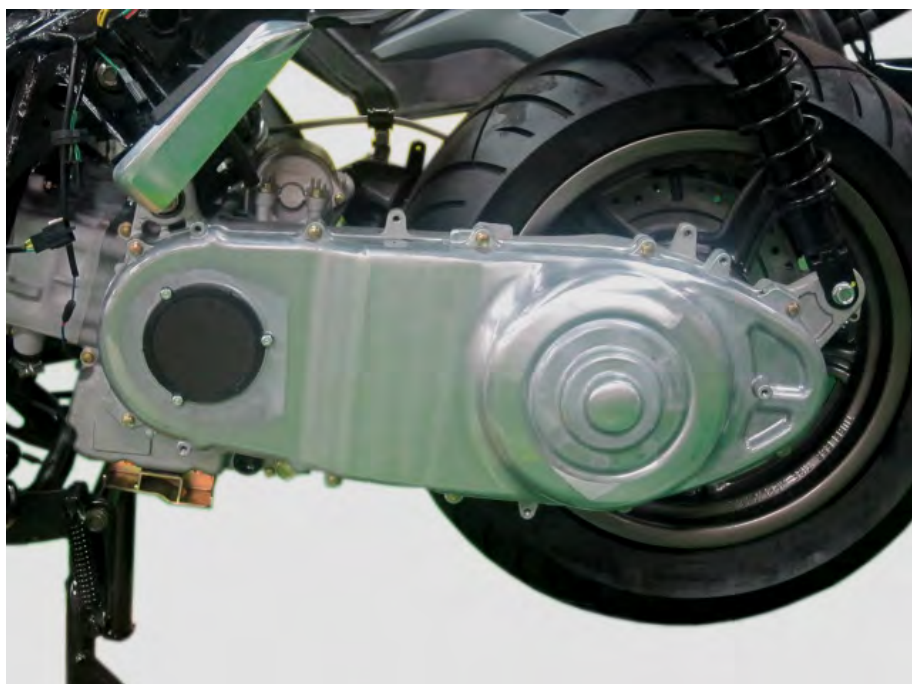

Remove the belt case cover bolts with an 8 mm socket.



Use the pry points to free the belt case cover.



Remove the belt case cover and gasket.



Remove the two dowel pins.

Inspection



Inspect the drive belt for cracks or excessive wear.



Inspect the belt case bearing by turning it with a finger. Replace the bearing if it is rough or noisy.



Remove the bearing snap ring with snap ring pliers.



Remove the bearing with a suitable bearing puller.



Drive in a new bearing with a suitable bearing driver that has the same outside diameter as the bearing.



Install a new snap ring with snap ring pliers.

Installation



Install the two dowel pins into the belt case.

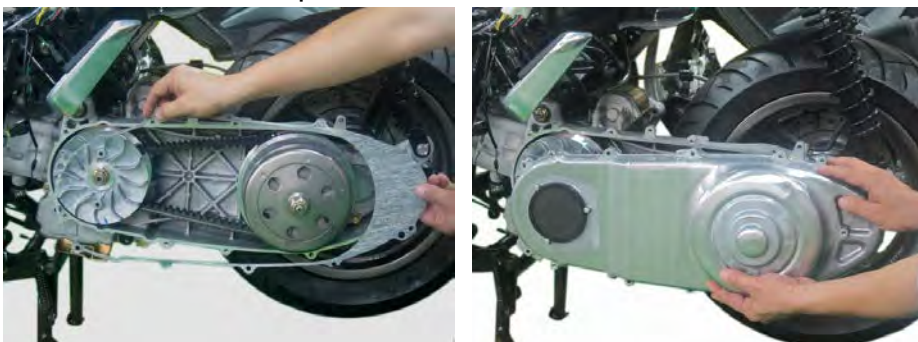

Install a new gasket with the belt case cover.



Install the belt case cover bolts and tighten them securely with an 8 mm socket.



Install the belt case plastic cover.



Insert the plastic cover bolts and tighten them securely with an 8 mm socket.



Fit the drain hose to the plastic belt case cover as shown.

CVT Removal

SAFETY FIRST: Protective gloves and eyewear are recommended at this point.

Remove the belt case. See the Belt Case topic for more information.

Pulleys and Belt



Hold the drive pulley with a universal holder tool and loosen the nut with a 19 mm socket.



Remove the drive pulley nut and washer from the crankshaft.



Remove the left face of the drive pulley.



Loosen the driven pulley nut with a 19 mm socket.



Remove the driven pulley nut and bushing.



Slide the driven pulley off of the shaft.



Remove the belt from the driven pulley.

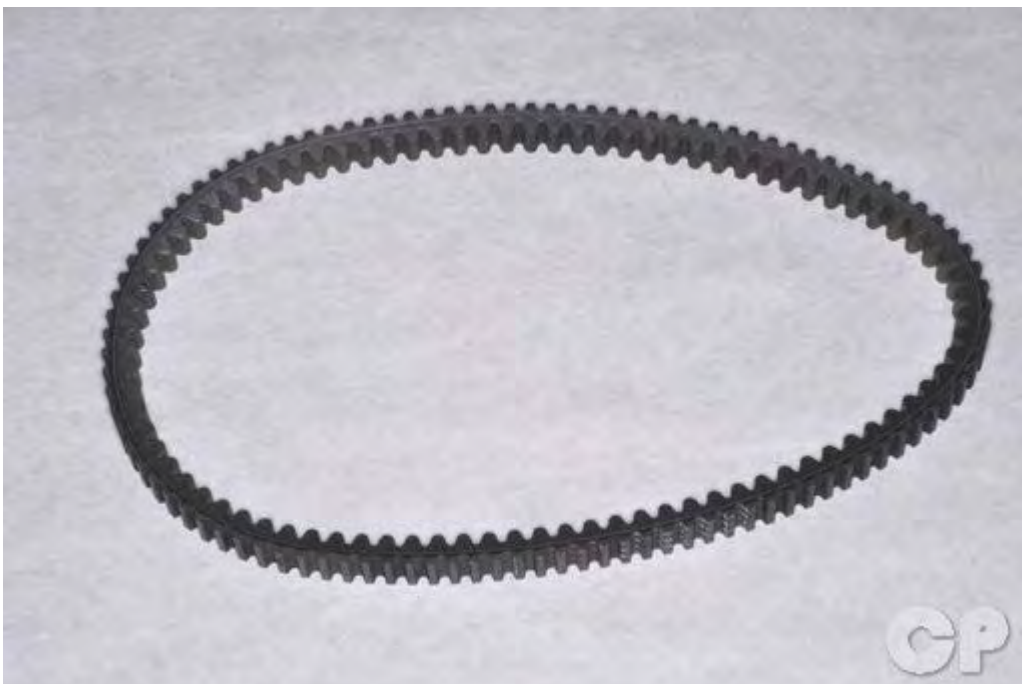

Inspect the drive belt for cracks or excessive wear.



Remove the right (movable) face of the drive pulley from the crankshaft.
Slide the bushing out of the movable drive face.



Remove the washer from the crankshaft.

Drive Pulley Disassembly



Inspect the faces of the drive pulley. Clean away any grease from the faces.



Lift the ramp plate out of the back of the left drive pulley face.



Remove the rubber damper pieces from the ramp.



There are eight weight rollers in the back of the right face of the drive pulley.

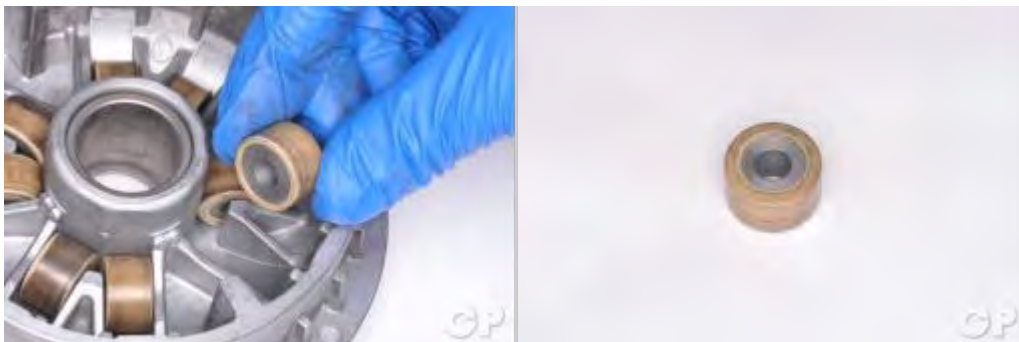

Remove the rollers and check them for excessive or uneven wear. Measure the outside diameter of the rollers. Replace the weight rollers as needed.

Item	Standard (mm)	Service Limit (mm)
Weight roller O.D (Drive Pulley)	19.92 - 20.08	20.08



Inspect the movable drive face and bushing for wear and damage. Replace the parts as needed.

Clutch Disassembly

Lift the clutch outer off of the centrifugal clutch.



Inspect the inside of the clutch outer for excessive wear and damage. Measure the inside diameter of the clutch outer and replace the part as needed.

Item	Standard (mm)	Service Limit (mm)
Clutch outer I.D.	152.1 - 152.2	152.2



Inspect the clutch shoe lining thickness. Replace the shoes if the wear is below the service limit.

Item	Standard (mm)	Service Limit (mm)
Clutch lining thickness	4.0	2.0

To disassemble the clutch and driven pulley set the clutch fitting tool to onto the clutch.

ITEM	TOOL NO.	DESCRIPTION
#41 NUT AND FITTING TOOL	A120E00028	Clutch disassembly



Fit the clutch and fitting tool into the clutch spring compressor tool.

4. CVT Transmission > CVT Removal



Use the clutch spring compressor tool to compress the spring in the driven pulley assembly.

Loosen the clutch drive plate nut with the special socket that comes with the fitting tool.



Remove the clutch drive plate nut.



Inspect the left side bearing by turning it with a finger. If the bearing is rough turning or noisy it should be replaced.

Remove the clutch spring compressor tool. Lift off the centrifugal clutch.





Remove the collars and spring.



Measure the free length of the clutch spring. Replace the spring if the measurement fails to meet the service limit.



Remove the three circlips from the clutch pivot pins with a small flat blade screwdriver.



Lift off the plate.

4. CVT Transmission > CVT Removal



Slide the clutch shoes off of the pivots on the drive plate.



Inspect the clutch shoe bumpers and replace them as needed.

Driven Pulley Disassembly

Remove the clutch as shown above.



Remove the four guide rollers with guide roller pins.



Separate the left and right faces of the driven pulley.



Inspect the faces of the driven pulley. Clean away any grease from the faces where the belt rides.



Remove the seals from the left face of the driven pulley.

4. CVT Transmission > CVT Removal



Drive in the new seals with a suitable driver with the same outside diameter as the seal.



Remove the O-rings on the left face.

Clean the left face and roller pins with a high flash point solvent and compressed air.

NOTE: Always wear safety glasses when using compressed air and never point it directly at yourself or anyone else.

Bearing Replacement



Inspect the bearings in the right face of the driven pulley.



Remove the needle bearing with a suitable puller.



Remove the collar, snap ring, and bearing from the right face of the driven pulley.

Clean the right face with a high flash point solvent and compressed air.

NOTE: Always wear safety glasses when using compressed air and never point it directly at yourself or anyone else.



Drive in the new bearing so the sealed side face out towards the clutch. Install the snap ring into the groove. Install the collar and drive in the new needle bearing so that its markings face out. Drive in the bearings with a suitable driver with the same outside diameter as the bearing.



Lubricate the bearings in the right face of the driven pulley with grease

CVT Installation

SAFETY FIRST: Protective gloves and eyewear are recommended at this point.

Driven Pulley



Lubricate the bearings in the right face of the driven pulley with grease.

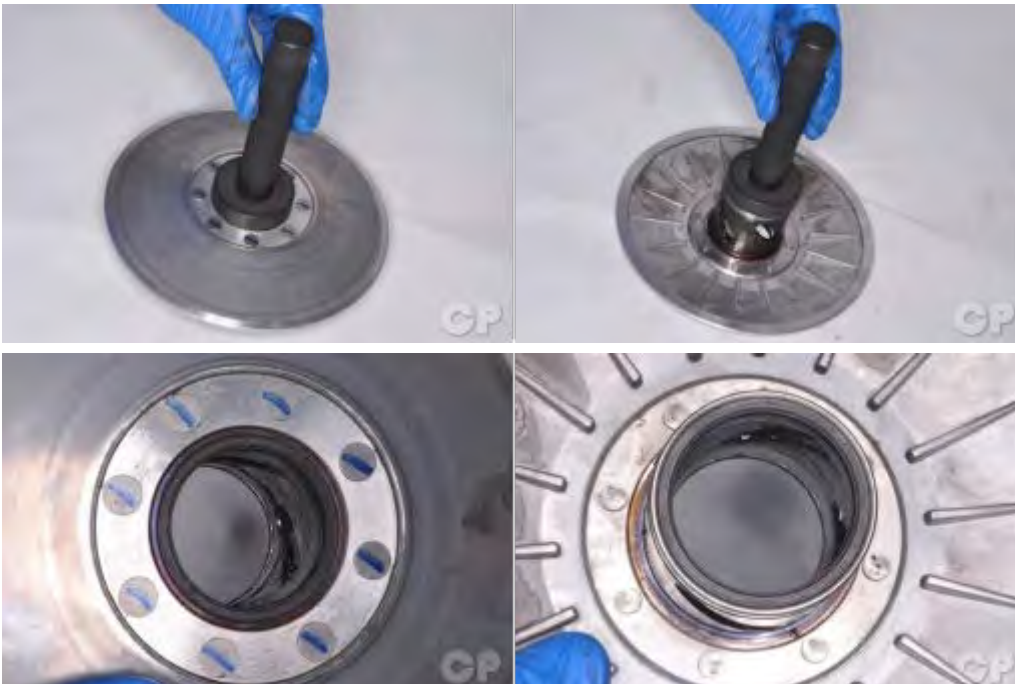

Drive in the new seals with a suitable driver with the same outside diameter as the seal.

5. Final Drive

Final Drive

This chapter covers the location and servicing of the final drive components for the KYMCO K-XCT 300i.

- Final Reduction..... 5-2
- Final Drive Oil..... 5-3~5-8

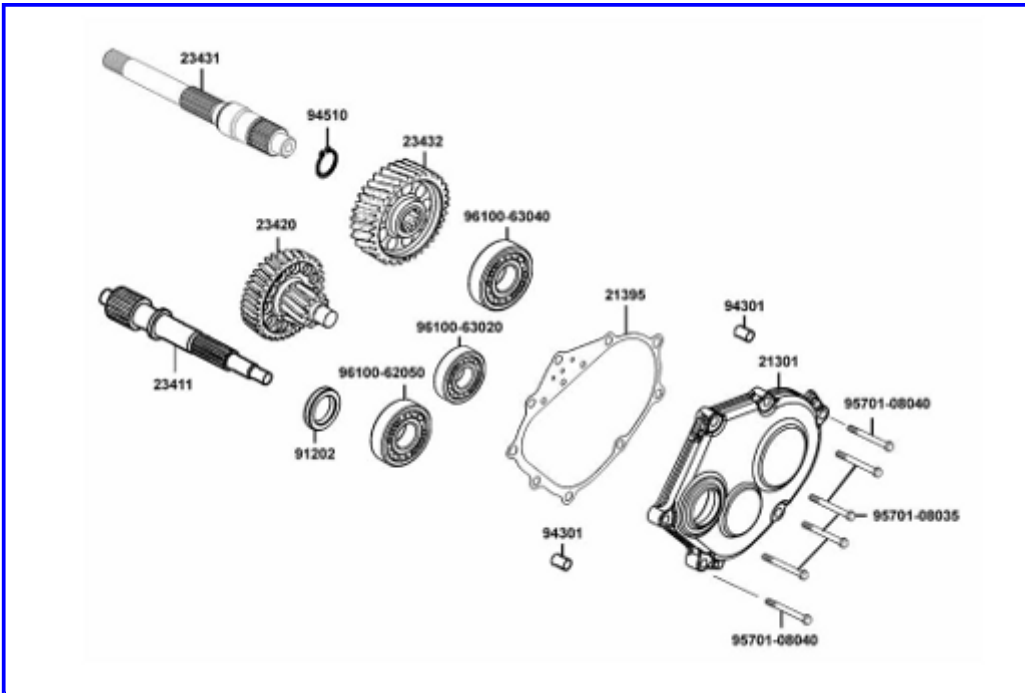

GENERAL INSTRUCTIONS

- The servicing operations of this section can be made with the engine installed.
- When replacing the drive shaft, use a special tool to hold the bearing inner race for this operation.

TROUBLESHOOTING

Engine starts but motorcycle won't move

- Damaged transmission
- Seized or burnt transmission

Abnormal noise

- Worn, seized or chipped gears
- Worn bearing

Oil leaks

- Oil level too high
- Worn or damaged oil seal

Final Reduction

SAFETY FIRST: Protective gloves and eyewear are recommended at this point.

Disassembly

Note: Do not remove the transmission case cover except for necessary part replacement. If the drive shaft is replaced, make sure to also replace the bearing and oil seal.

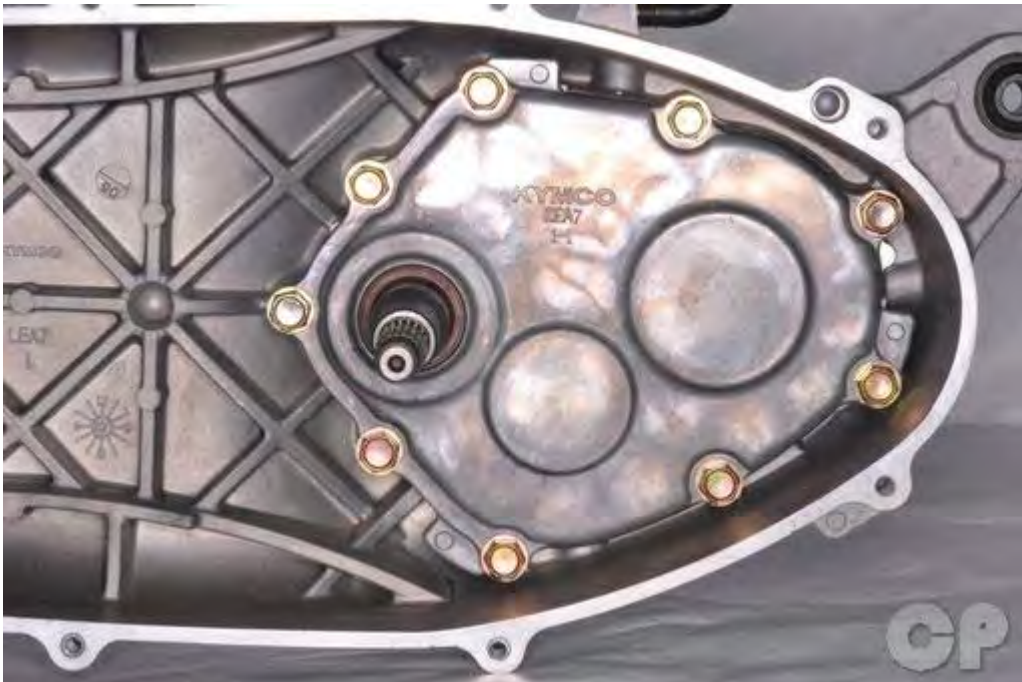

There are 9 transmission case cover bolts



Final Drive Oil

SAFETY FIRST: Protective gloves and eyewear are recommended at this point.

Place the scooter on level ground and up on its center stand.



The oil drain bolt and oil filler bolt are located on the transmission.

Gear oil type:	SAE 90
Gear oil capacity:	
At disassembly	0.23 Liter
At change	0.21 Liter

Inspection

Place the vehicle on its center stand on level ground.



Remove the transmission oil level check bolt with a 12 mm socket. The oil level is correct when oil flows from the bolt hole. Install the oil level check bolt and tighten it to specification with a 12 mm socket.

Item	Qty	Thread size (mm)	Torqu	
			kgf-m	lb-ft
Final Drive oil check bolt	1	8	0.8 - 1.2	5.79 - 8.68

5. Final Drive > Transmission Oil

If the level is too high allow the oil to flow out of the check hole until the level is even with the bolt hole.

If the level is low add more of the same type and brand of oil as shown below. Inspect for leaks.

Draining

Place the vehicle on its center stand on level ground. Place a suitable oil drain pan under the transmission oil drain plug.



Place a suitable container under the drain plug to capture the final drive oil. Loosen the oil drain plug with a 12 mm socket. Remove the drain plug and slowly rotate the rear wheel to drain the transmission oil.

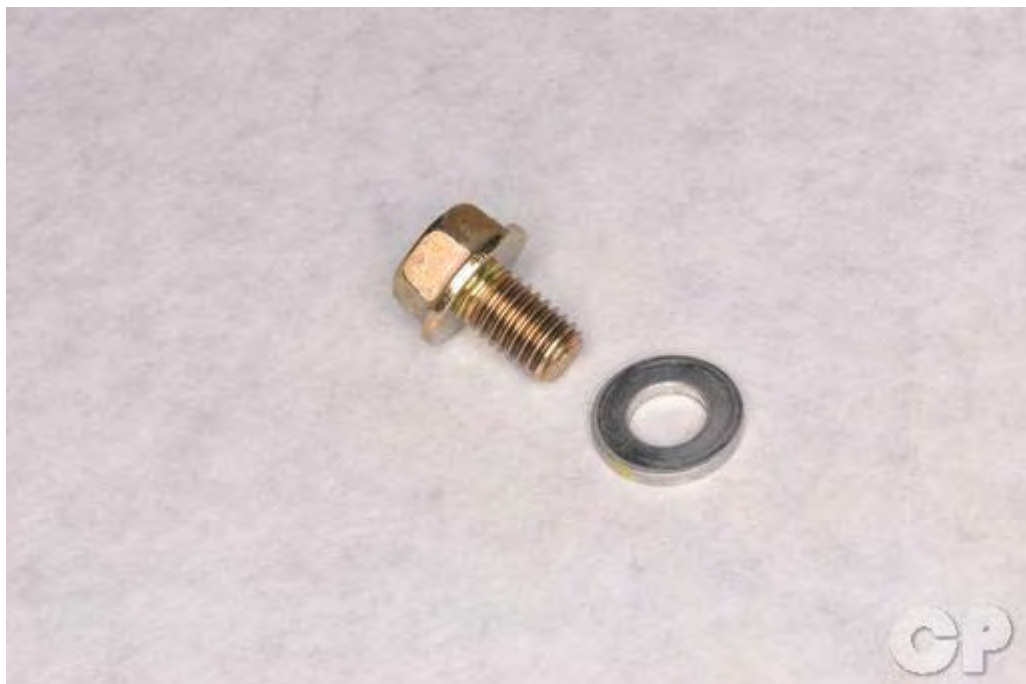

Inspect the drain plug and washer.



Install the oil drain plug and washer with a 12 mm socket. Tighten to specification.

5. Final Drive > Transmission Oil

Item	Qty	Thread size (mm)	Torqu	
			kgf-m	lb-ft
Final Drive oil check bolt	1	8	0.8 - 1.2	5.79 - 8.68

Filling



Fill the final drive oil with a syringe until oil begins to flow from the level check bolt hole.

Gear oil type:	SAE 90
Gear oil capacity:	
At disassembly	0.23 Liter
At change	0.21 Liter

5. Final Drive > Transmission Oil



Thread in the final drive oil level check bolt.



Install the oil check plug and torque it to specification with a 12 mm socket.

Item	Qty	Thread size (mm)	Torque	
			kgf-m	lb-ft
Final drive oil check bolt	1	8	0.8 - 1.2	5.79 - 8.68

Cooling System

This chapter covers the location and servicing of the cooling system components for the KYMCO K-XCT 300i.

- Coolant6-3~6-11
- Radiator6-12~6-29
- Thermostat.....6-30~6-40
- Water Pump6-41~6-49

GENERAL INSTRUCTIONS

- The water pump must be serviced after removing the engine. Other cooling system service can be done with the engine installed in the frame.
- The engine must be cool before servicing the cooling system. When the coolant temperature is over 100°C, never remove the radiator cap to release the pressure because the boiling coolant may cause danger.
- Avoid spilling coolant on painted surfaces because the coolant will corrode the painted surfaces. Wash off any spilled coolant with fresh water as soon as possible.
- After servicing the system, check for leaks with a cooling system tester.

TROUBLESHOOTING

Engine temperature too high

- Faulty temperature gauge or sensor
- Faulty radiator cap
- Faulty thermostat
- Insufficient coolant
- Passages blocked in hoses or water jacket
- Clogged radiator fins
- Passages blocked in radiator
- Faulty water pump

6. Cooling System

Temperature gauge shows the wrong temperature

- Faulty temperature gauge or sensor
- Faulty thermostat

Coolant leaks

- Faulty pump mechanical (water) seal
- Deteriorated O-rings
- Damaged or deteriorated water hoses

6. Cooling System > Coolant

Coolant

SAFETY FIRST: Protective gloves and eyewear are recommended at this point.

Warning: Allow the engine sufficient time to cool before handling or working on the cooling system components.

To check the coolant level, see the Coolant Level Check topic for more information.

Draining

SAFETY FIRST: Antifreeze is highly toxic and can kill pets and animals if drank. Do not leave coolant where animals (including children!) can get to it.



Remove the radiator coolant panel screws with a #2 Phillips screwdriver.



Remove the panel to access the radiator cap.

6. Cooling System > Coolant



Remove the radiator cap in two stages. Allow any built up pressure to vent and then open the cap all the way and remove it.

The water pump is located on the right side of the engine. Ready a drain pan under the water pump drain bolt.



Loosen the coolant drain bolt with an 8 mm socket.

6. Cooling System > Coolant



Remove the drain bolt and sealing washer and allow the coolant to drain into a suitable container.



The coolant reserve tank is under the inner cover.
Remove the engine coolant lid screw with a #2 Phillips.
Remove the engine coolant lid.

6. Cooling System > Coolant



Open the coolant reserve tank lid. Siphon the coolant out of the reserve tank with an appropriate suction device. If a suction device is unavailable remove the reserve tank and pour it out. See the Radiator topic for more information.

When the coolant has finished draining return the drain bolt to the water pump with a new sealing washer.



Tighten the drain bolt securely with an 8 mm socket.

6. Cooling System > Coolant

Filling

Coolant capacity	
Radiator	766 cc
Hose with cool coolant	169 cc
Hose with hot coolant	194 cc
Reserve tank	590 cc
Total capacity	1719 cc

- Use coolant of specified mixing rate. (The mixing rate of 860cc coolant concentrate + 859cc distilled water is 50%.)
- Do not mix coolant concentrate of different brands.
- Do not drink the coolant, which is poisonous.

COOLANT MIXTURE (WITH ANTI-RUST AND ANTI-FREEZING EFFECTS)			
Freezing Point	Mixing Rate	KYMCO SIGMA Coolant Concentrate	Distilled Water
-9°C	20%	344 cc	1375 cc
-15°C	30%	516 cc	1203 cc
-25°C	40%	688 cc	1031 cc
-37°C	50%	860 cc	859 cc
-44.5°C	55%	945 cc	774 cc

- The freezing point of coolant mixture shall be 5°C lower than the freezing point of the riding area.

6. Cooling System > Coolant



Fill the cooling system with a mix of distilled water and Coolant Concentrate. Continue filling until the coolant level reaches the bottom of the filler neck as shown.



Add coolant to the reserve tank until it reaches the upper level mark.

6. Cooling System > Coolant

Gently rock the vehicle side-to-side to release any air bubbles trapped in the cooling system.

Place the vehicle on its center stand and start the engine. Let it run for several minutes. This will purge any air out of the cooling system. Check for coolant leaks

When the air bubbles stop coming up turn off the engine and recheck the coolant level, add coolant if necessary. Check the reserve tank and add coolant if needed.



Wet the seal of the radiator cap and install.



Install the coolant reserve tank lid.

6. Cooling System > Coolant



Install the engine coolant reserve tank cover. Insert the screw and tighten its securely with a #2 Phillips.



Install the radiator cap access panel.



Install the radiator coolant panel screws and tighten securely with a #2 Phillips screwdriver.

6. Cooling System > Radiator

Radiator

SAFETY FIRST: Protective gloves and eyewear are recommended at this point.

Warning: Allow the engine sufficient time to cool before handling or working on the cooling system components.

Pressure Testing



Remove the radiator coolant panel screws with a #2 Phillips screwdriver.

Remove the panel to access the radiator cap.

6. Cooling System > Radiator



Remove the radiator cap in two stages. Allow any built up pressure to vent and then open the cap all the way and remove it.

When checking the cooling system for leaks you will need a pressure tester. Remove the radiator cap, wet the tester seal, and install the end of the pressure tester onto the filler neck. Pump the tester up until the gauge reads 0.84 kg/cm^2 or 12 psi. The cooling system should hold this pressure for at least 6 seconds. If it does not you will need to inspect the entire system for leaks. Do not pressurize the cooling system more than 1.05 kg/cm^2 or 14.9 psi.

CAUTION: Never remove the radiator cap when the engine is hot.

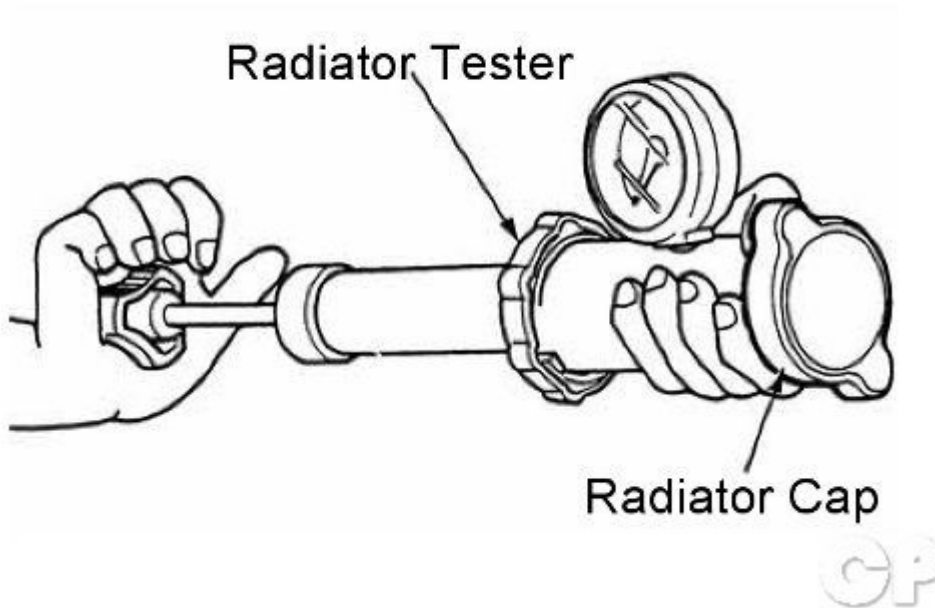

Wet the seal on the radiator cap and install it to the pressure tester. Replace the cap if it does not relieve the pressure as specified.

Radiator cap relief pressure	$0.9 \pm 0.15 \text{ kg/cm}^2$ (12.8 \pm 2.1 psi)
------------------------------	---

Removal



Unplug the thermostatic switch connectors.

6. Cooling System > Radiator



Unplug the cooling fan motor connector.



There are three coolant hoses that connect to the radiator. The top right hose runs to the filler neck and cap. The top left hose runs to the thermostat on the cylinder head. The bottom right hose runs to the water pump.



Loosen the coolant hose clamps with a #2 Phillips screwdriver.



Free the filler neck coolant hose from the stay and remove it from the radiator.



Remove the water pump and thermostat hoses in the same manner.



Remove the two radiator mounting bolts with a 10 mm socket.



Slide the radiator to the left and free the grommet from the post above the right side of the radiator.



Remove the radiator from the frame.

Coolant Reserve Tank



The coolant reserve tank is mounting to the frame with two bolts. There are two hoses that connect to the reserve tank. The top hose is a dump hose that hangs over the other side. The bottom hose is the overflow hose that runs to the filler neck.



Position a suitable container below the reserve tank.



Pull back the clamp and free the overflow hose from the bottom of the reserve tank. Allow the coolant in the reserve tank to drain into the container.



Remove the two reserve tank mounting bolts with a 10 mm socket.



Remove the reserve tank from the frame.



To remove the reserve tank bracket take off the mounting nuts with a 10 mm socket.

6. Cooling System > Radiator



Remove the reserve tank bracket from the studs on the frame.

Inspection

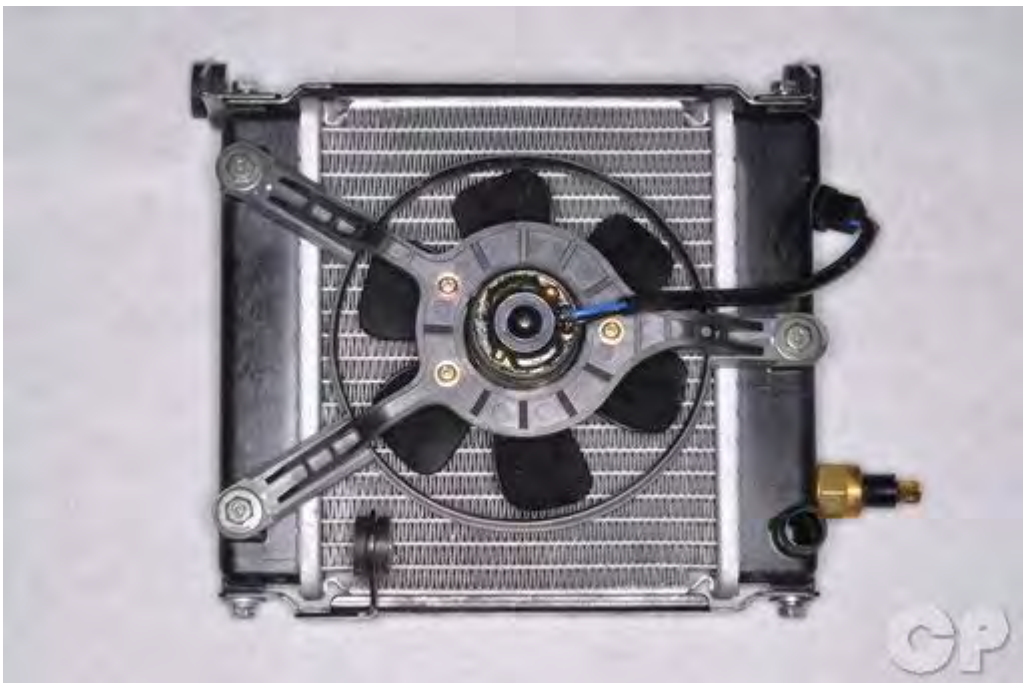

Inspect the radiator fins for damage and clogging. To remove the fan take out the three mounting bolts with a 10 mm socket.

6. Cooling System > Radiator

Clean out the fins with low pressure compressed air and water.

NOTE: Always wear safety glasses when using compressed air and never point it directly at yourself or anyone else.



Check the radiator for any bent or damaged fins. Use a small flat blade screwdriver to straighten them out, but be careful not to puncture the radiator.



Jump a 12 volt battery to the fan connector and make sure the radiator fan operates.

6. Cooling System > Radiator



If the thermostatic switch needs to be removed use a 22 mm wrench. The thermostatic switch should be off below 85°C (185°F) and on above 90°C (194°F).

Installation

Coolant Reserve Tank



Fit the coolant reserve tank bracket to the studs on the left side of the frame.



Install the two reserve tank mounting nuts and tighten them securely with a 10 mm socket.



Fit the reserve tank to its bracket.



Insert the two reserve tank mounting bolts and tighten them securely with a 10 mm socket.



Connect the dump hose to the top of the reserve tank and the overflow hose to the bottom. Secure the hoses with the clamps.

Radiator





Fit the radiator into place so that the post on the frame fits into the rubber grommet on the right side of the radiator.



Install the two radiator mounting bolts and tighten them securely with a 10 mm socket.

6. Cooling System > Radiator



Route the filler neck coolant hose through the guide to the top right of the radiator.



Connect the coolant hose from the thermostat on the cylinder head to the top left of the radiator. Connect the coolant hose from the water pump to the bottom right of the radiator.



Tighten the coolant hose clamp screws securely with a #2 Phillips screwdriver.



Plug in the cooling fan motor connector.



Plug in the thermostatic switch connectors.

Thermostat and Thermosensor

SAFETY FIRST: Protective gloves and eyewear are recommended at this point.

Removal

Thermosensor



Unplug the thermosensor unit and thermo unit ground connectors.



Remove the thermosensor unit with a 12 mm deep well socket

6. Cooling System > Thermostat

Water Temperature Sensor (WTS)



Unplug the water temperature sensor.



Use a 17 mm wrench to remove the water temperature sensor.

6. Cooling System > Thermostat

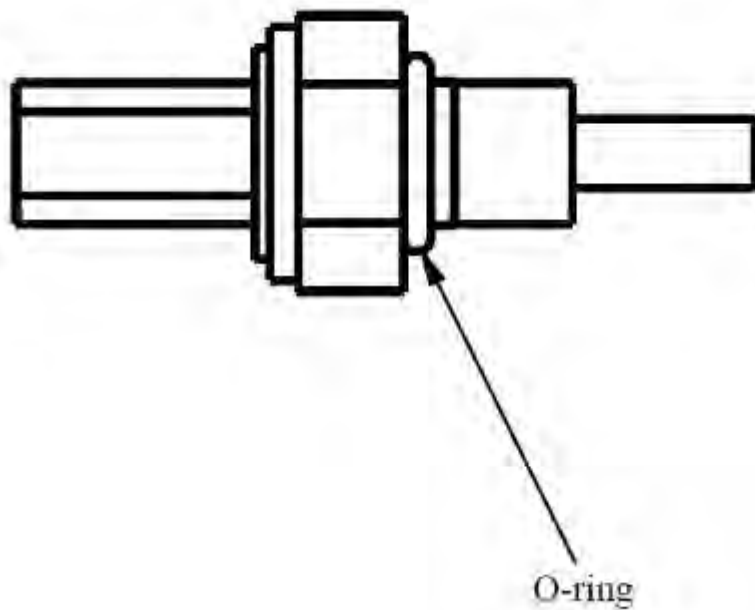

Discard the WTS O-ring and replace it with a new item.

Thermostat



Loosen the thermostat hose clamp with a #2 Phillips screwdriver. Slide up the clamp and free the coolant hose from the thermostat.



Squeeze the air bleed hose clamp with needle nose pliers and slide back the clamp. Free the air bleed hose from the thermostat.

6. Cooling System > Thermostat



Remove the two thermostat mounting bolts with an impact #3 Phillips screwdriver.

6. Cooling System > Thermostat



Lift off the thermostat cover.



Lift out the thermostat. Remove the thermostat O-ring and discard it.

6. Cooling System > Thermostat

Inspection

Thermosensor

Set a digital multimeter to read ohms of resistance ()

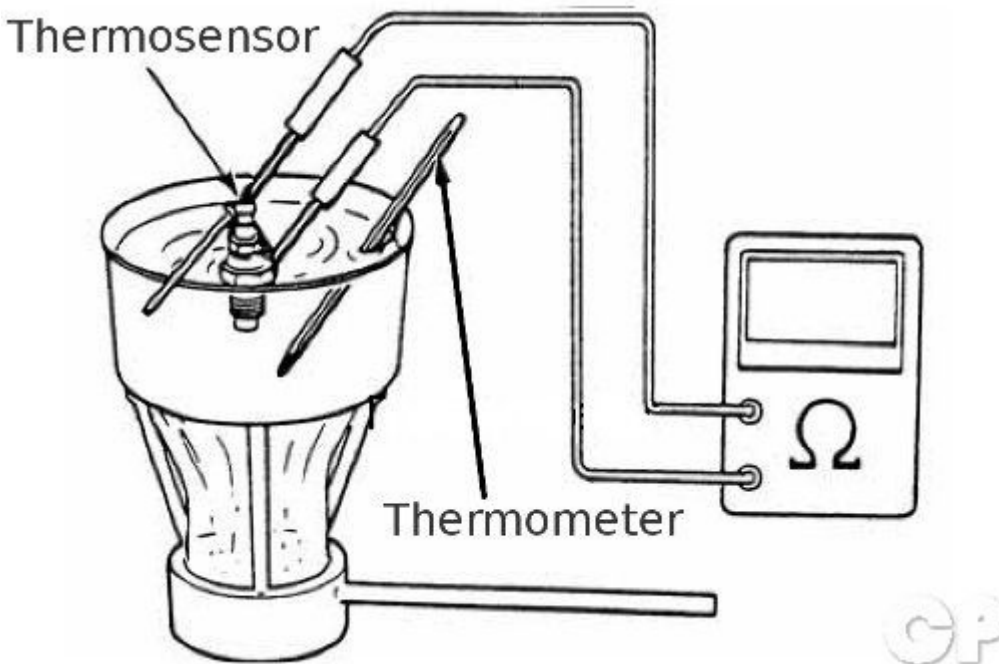

Suspend the thermosensor in a pan of water over a burner and measure the resistance through the sensor as the water heats up. Do not allow the thermosensor or the thermometer to contact the sides of the pan.

Thermosensor resistance	At 50 °C/122 °F	154 Ω
	At 80 °C/176 °F	52 Ω
	At 100 °C/212 °F	27 Ω
	At 120 °C/248 °F	16 Ω

Water Temperature Sensor

Inspect the WTS in a similar manner as the thermosensor. Measure the resistance between the WTS terminals and compare this to the specifications.

WTS resistance	At -20 °C/-4 °F	18.8 kΩ
	At 40 °C/104 °F	1.136 kΩ
	At 100 °C/212 °F	0.1553 kΩ

6. Cooling System > Thermostat

Thermostat

The thermostat should be closed at room temperature.

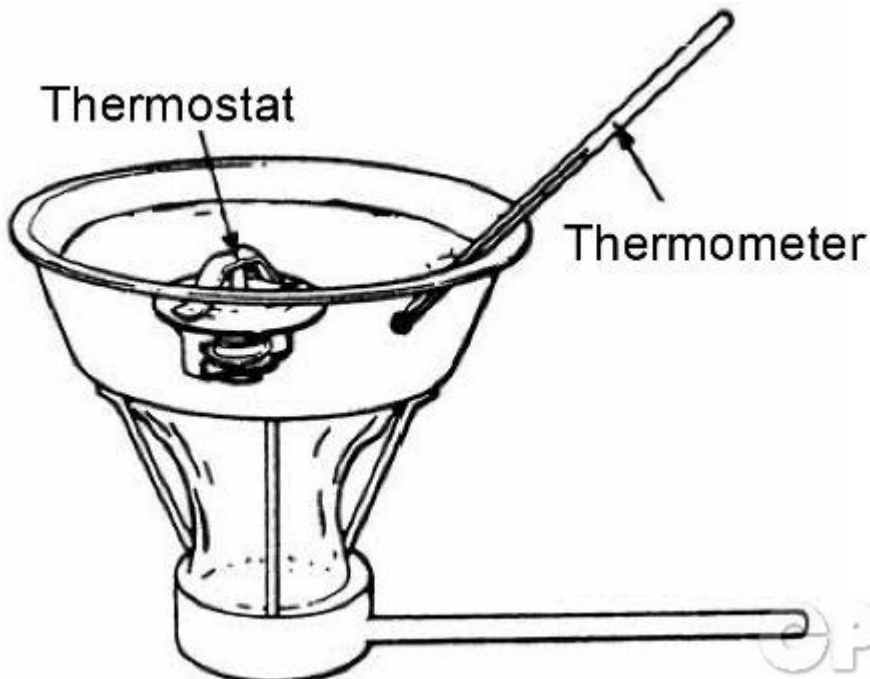

Suspend the thermostat and a thermometer in a pot of water with string. Make sure the thermostat and the thermometer are not touching the pot. Bring the temperature up to the specification slowly and check the operation of the thermostat.

The valve should begin to open around 71° C (160° F). The valve should lift 3.5 - 4.5 mm (0.14 - 0.18 in) at 80° C (176° F).

After the thermostat has been open for around 5 min. allow the thermostat to cool. The thermostat should close at 70° C (158° F).

Replace the thermostat with a new unit if it fails to function properly.

6. Cooling System > Thermostat

Installation

Thermosensor



Tighten the thermosensor unit securely with a 12 mm deep well socket



Plug in the thermosensor unit and ground connectors.

6. Cooling System > Thermostat

Water Temperature Sensor



Install the WTS with a new O-ring. Tighten the WTS to specification with a 17 mm wrench.



Plug in the water temperature sensor connector.

6. Cooling System > Thermostat

Thermostat



Make sure the thermostat seal is in good condition. Replace the thermostat if needed. Apply a light coat of waterproof grease to the thermostat seal. Insert the thermostat into its cavity in the cylinder head.



Fit the thermostat cover into place.

6. Cooling System > Thermostat



Insert the two thermostat bolts and tighten them securely with an impact #3 Phillips screwdriver.



Install air bleed hose and secure it with the clamp.



Connect the coolant hose to the thermostat. Move the clamp into place and tighten it securely with a #2 Phillips screwdriver.

Water Pump

SAFETY FIRST: Protective gloves and eyewear are recommended at this point.

Mechanical Seal Inspection



Inspect the telltale hole in the generator cover below the water pump for signs of coolant leaking. If there is coolant coming from this hole the mechanical seal is compromised and must be replaced.

Removal

Water Pump Cover

Remove the following components -

- ' Seat
- ' Luggage Box
- ' CenterCover
- ' RearCarrier
- ' BodyCover
- ' FrontCover
- ' FrontLowerCover
- ' Foot Skirt
- ' Exhaust System

6. CoolingSystem > Water Pump



Loosen the water pump hose clamp with a #2 Phillips screwdriver. Slide up the clamp and free the coolant hose from the water pump. Allow any remaining coolant to drain into a suitable container.



Loosen the four water pump cover bolts with an 8 mm socket.



Remove the bolts and the water pump cover.

6. CoolingSystem > Water Pump



Remove the two dowel pins and the water pump cover gasket.

Impeller and Shaft



Hold the water pump shaft and loosen the impeller with a 12 mm socket. The impeller has left hand threads.



Remove the impeller.

6. CoolingSystem > Water Pump



Remove the seal washer from the back of the impeller. Inspect the impeller blades and seal. Replace the seal washer if the mechanical seal is to be replaced.



Remove the water pump shaft from the generator cover.

6. CoolingSystem > Water Pump



To replace the mechanical and oil seals drive them out from the inside of the generator cover.

Assembly

Seals, Shaft, and Impeller

Coat the lips of the new oil seal in fresh engine oil and drive it in with a suitable drive that is the same outside diameter as the oil seal.



Apply silicone sealant to the outside of the mechanical seal. Press in the seal with a suitable drive that is the same outside diameter as the oil seal.

6. CoolingSystem > Water Pump



Place the washer and thrust washer on the water pump shaft. Install a new snap ring onto the water pump shaft if the snap ring was removed.



Lubricate the water pump shaft with fresh engine oil where it will ride in the case. Insert the water pump shaft into the generator cover from the inside.

6. CoolingSystem > Water Pump



Install a new washer into the back of the impeller if the mechanical seal was replaced.



Install the impeller to the water pump shaft. Note: Left hand threads.

6. CoolingSystem > Water Pump



Hold the water pump shaft and tighten the impeller to specification with a 12 mm socket. Remember the impeller has left hand threads.

Item	Qty	Thread size (mm)	Torque	
			kgf-m	lb-ft
Water pump impeller	1	7	1.0-1.4	7.23-10.13

Make sure the water pump cover mating surface is clean.



Install the two dowel pins into the generator cover and set a new water pump cover gasket in place.

6. CoolingSystem > Water Pump



Install the water pump cover and insert the four bolts.



Tighten the water pump cover bolts to specification with an 8 mm socket.



Connect the coolant hose to the water pump. Move the clamp into place and tighten it securely with a #2 Phillips screwdriver.

Fuel Injection System

This chapter covers the location and servicing of the fuel system components for the KYMCO K-XCT 300i.

- Air box..... 7-2~7-8
- Fuel Tank..... 7-9~7-12
- Fuel Pump and Fuel Level Gauge 7-13~7-22
- Throttle Body Removal and Installation 7-23~7-39
- Throttle Body 7-40
- Fuel Injector 7-41~7-49
- Self-Diagnosis 7-50~7-51
- Fuel Injector Diagnostic Tool..... 7-52
- Throttle Cable 7-53~7-59
- TPS ISC Reset Procedure 7-60

SERVICE INFORMATION

GENERAL INSTRUCTIONS

- Scooter services can be done with the engine installed in the frame.
- Be sure to relieve the fuel pressure before fuel pump or fuel hose removal.
- Bending or twisting the control cables will affect operation and could cause the cables to stick or bind, resulting in loss of vehicle control.
- Work in a fully ventilated area. Smoking or allowing flames or sparks in the work area or where gasoline is stored can cause a fire or explosion.
- Do not apply the Carburetor Cleaners to the inside of the throttle body, which is coated with molybdenum.
- Do not snap the throttle valve from fully open to fully close after the throttle cable has been removed; it may cause incorrect idle speed.
- Do not loosen or tighten the painted bolts and screws of the throttle body. Loosening or tightening them can cause throttle and idle valve synchronization failure.
- Seal the cylinder head intake ports with tape or a clean towel to prevent dirt and debris from entering the intake ports after the throttle body has been removed.
- Do not damage the throttle body. It may cause incorrect throttle and idle valve synchronization.
- Do not take the fuel pump on the ground downward.

Air box

SAFETY FIRST: Protective gloves and eyewear are recommended at this point.

Removal



Loosen the air box connecting hose clamp screw at the throttle body with a #2 Phillips.



Remove the breather hose from the air box.



Disconnect the transmission vent hose.



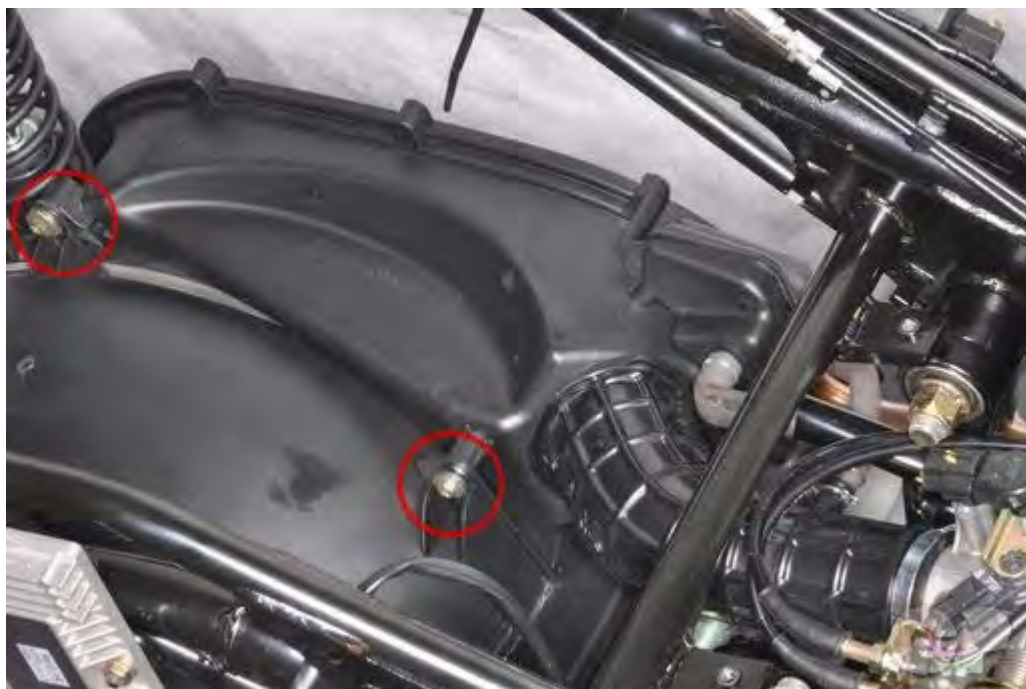

Remove the two rear air box screws with an 8 mm socket.



Remove the two front air box screws with an 8 mm socket.



Remove the air box.

Installation



Fit the air box into the frame and guide the boot over the mouth of the throttle body.



Tighten the air box connecting hose clamp screw at the throttle body with a Phillips.





Install the two front air box screws and tighten securely with an 8 mm socket.

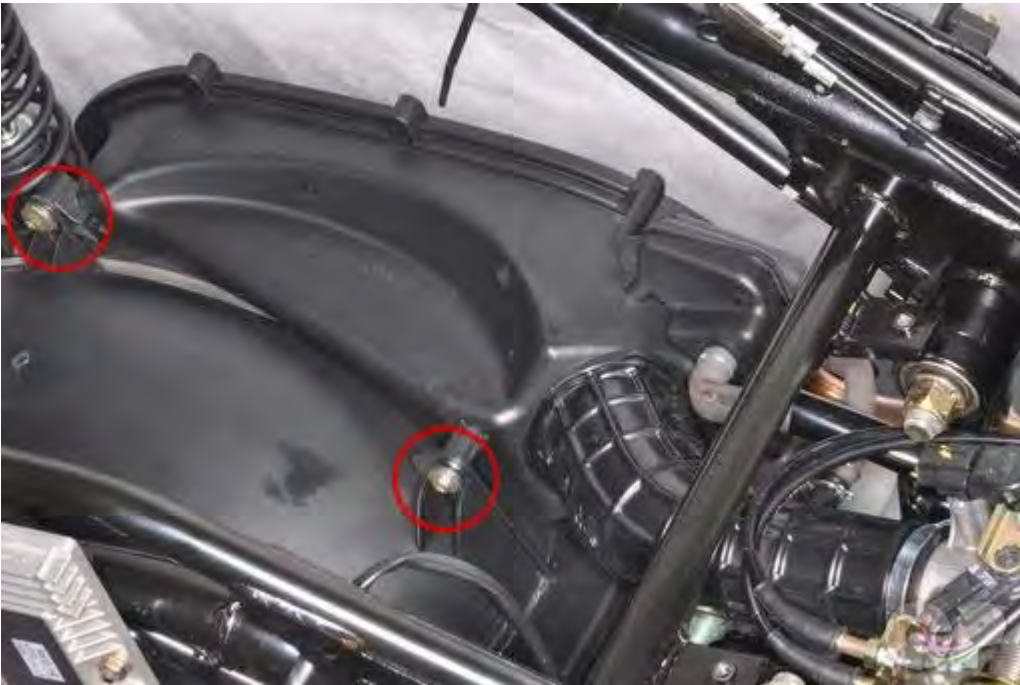

Install the two rear air box screws and tighten securely with an 8 mm socket.



Connect the transmission vent hose.



Connect the breather hose to the air box.

7. Fuel System> Fuel Tank

Fuel Tank

SAFETY FIRST: Protective gloves and eyewear are recommended at this point.

Warning: Gas is extremely flammable! Do not work around an open flame or a source of sparks.

Removal



In order to drain the fuel from the fuel pipe and release the fuel pressure unplug the fuel pump connector. Start the engine and let it run until it dies of fuel starvation. Turn the ignition switch off.



Loosen the fuel hose clamp with a #2 Phillips screwdriver. Slide back the clamp and free the injector fuel hose from the fuel pump pipe. Clean up any remaining fuel immediately.

7. Fuel System> Fuel Tank



Remove the fuel tank mounting nuts and brackets. Remove the fuel tank from the bottom of the frame.

7. Fuel System> Fuel Tank

Installation

Fit the fuel tank into place.



Install the brackets and nuts. Tighten the nuts securely



Connect the fuel hose to the outlet pipe on the fuel pump. Tighten the clamp securely with a #2 Phillips screwdriver.

7. Fuel System> Fuel Tank



Plug in the fuel pump connecter.

7. Fuel System> Fuel Pump

Fuel Pump

SAFETY FIRST: Protective gloves and eyewear are recommended at this point.

Warning: Gas is extremely flammable! Do not work around an open flame or a source of sparks.

Input Voltage Inspection

Turn the ignition switch off.

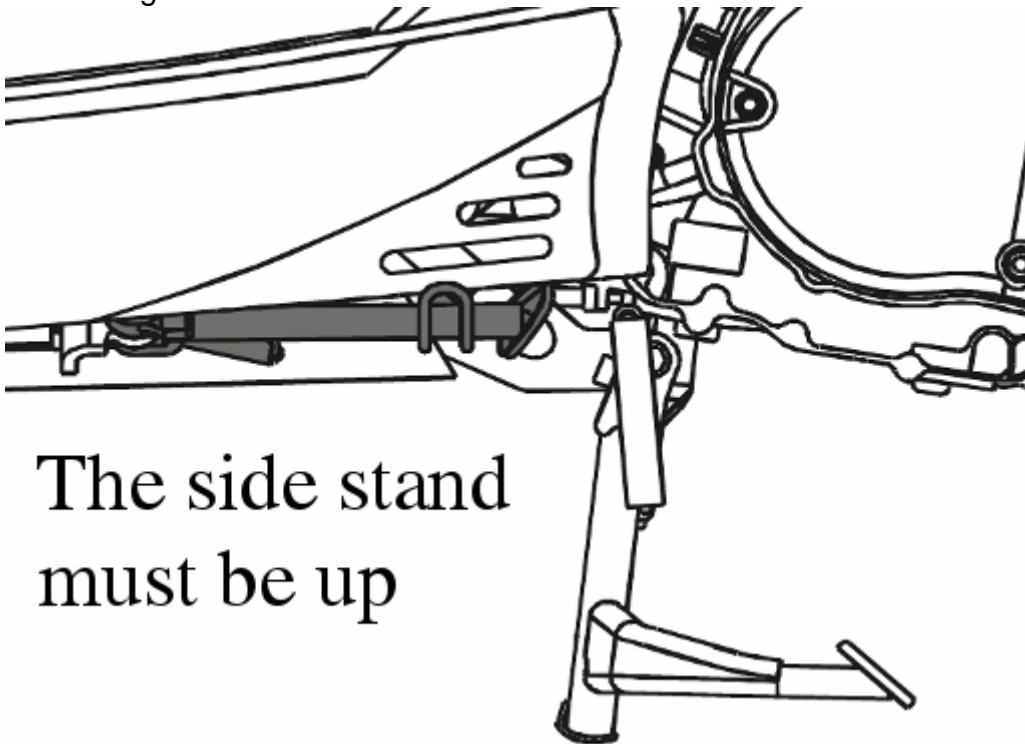

The side stand
must be up

Place the scooter on its main stand and put the side stand up.



Set the engine stop switch to the “RUN” position.



Unplug the fuel pump connector.

Set the multi meter to read battery voltage.

Touch the multi meter leads to the harness side of the fuel pump connector, with the positive lead touching the red/black wire terminal and the negative lead touching the green wire terminal.

Turn the ignition switch on. The battery voltage should show for a few seconds. Replace the fuel pump if it is not functioning and the input voltage is correct.

If the battery voltage is not present check the following:

- Fuse B (10 A)
- Fuel cut-off relay
- ECU

Removal



In order to drain the fuel from the fuel pipe and release the fuel pressure unplug the fuel pump connector. Start the engine and let it run until it dies of fuel starvation. Turn the ignition switch off.



Loosen the fuel hose clamp with a #2 Phillips screwdriver. Slide back the clamp and free the injector fuel hose from the fuel pump pipe. Clean up any remaining fuel immediately.



Remove the 6 fuel pump bolts with a 7 mm socket or #2 Phillips screwdriver.

7. Fuel System> Fuel Pump



Lift the fuel pump out of the tank.



Discard the fuel pump O-ring, and replace it with a new item on assembly.

Fuel Level Gauge Inspection



Using a digital multi meter set to ohms of resistance (Ω), measure the resistance between the fuel pump/level gauge connector terminals (green and yellow/white) with the float raised to the positions indicated below.

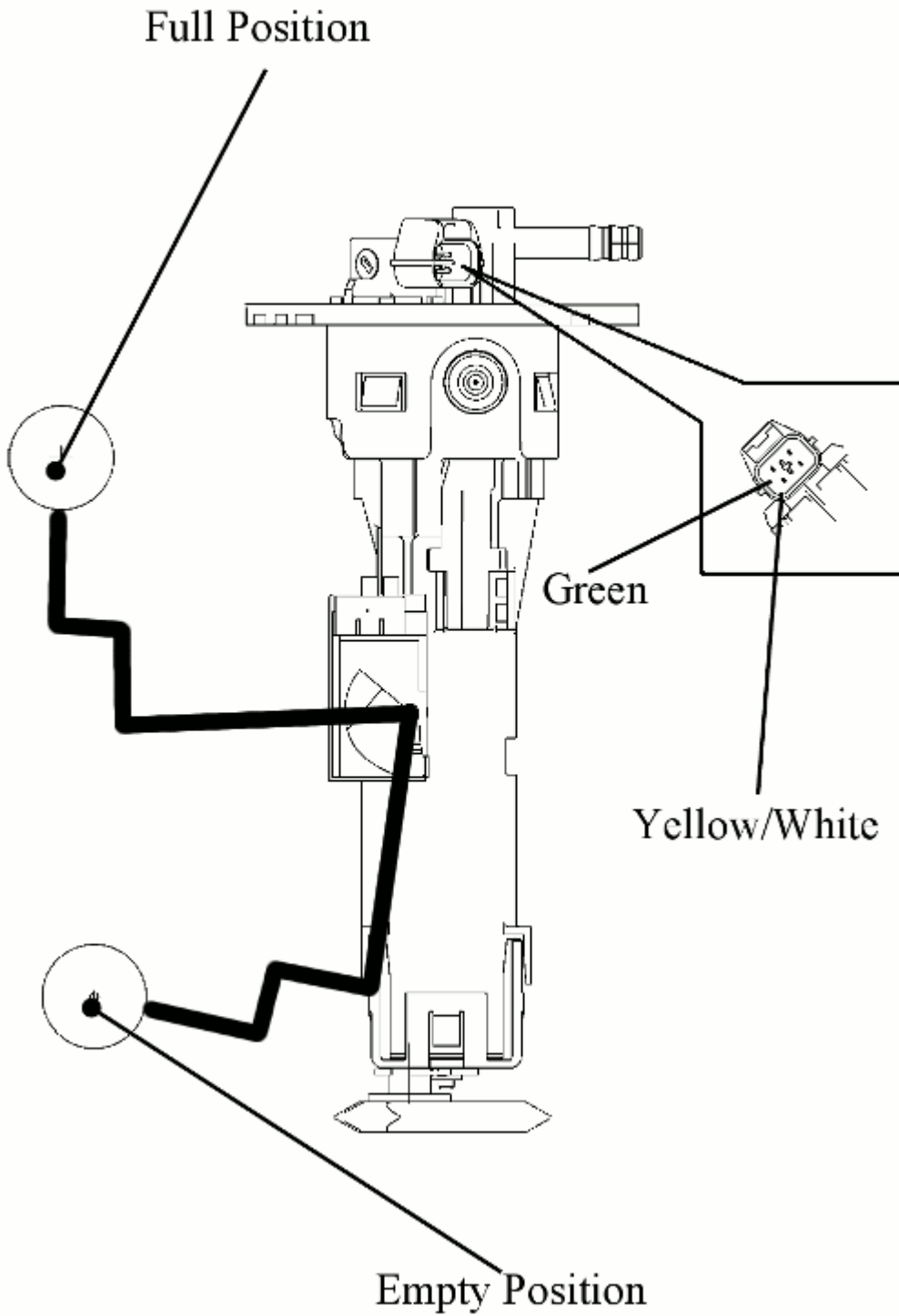

Fuel Level Float Position	Resistance
Full	1100 ± 33 Ω
Empty	100 ± 3 Ω

Replace the fuel level float unit with a new part if the resistance is out of specification.

Fuel Output Pressure

Turn the key to the OFF position.



Use a fuel hose clamp as shown.

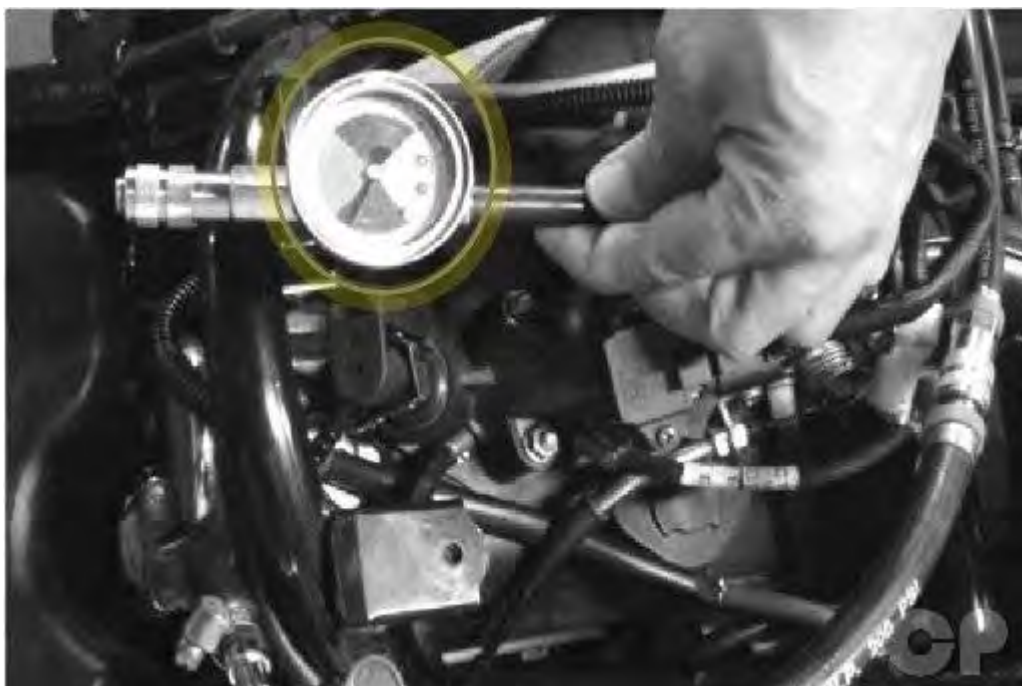

Disconnect the fuel hose from the fuel injector. Connect the fuel pressure gauge. Remove the fuel hose clamp. Turn the key to the ON position. Check the fuel pressure.

If the fuel output pressure is less than 3.0 bar, may fail to start the engine or in trouble in case of riding.

7. Fuel System> Fuel Pump

Turn the key to the OFF position and use the fuel hose clamp to block the fuel hose. Return the fuel line to the injector.

To inspect the fuel pump relay see the Relays topic.

Fuel Pump Relay

See the Relay topic.

Installation



Replace the O-ring with new item and apply a small amount of fresh engine oil to the new O-ring.

7. Fuel System> Fuel Pump



Carefully insert the fuel pump into the tank. Avoid damaging the fuel pump wire. The fuel delivery pipe should face to the rear.



Insert the 6 fuel pump mounting bolts. Tighten the bolts to specification with a 7 mm socket or #2 Phillips screwdriver.

Item	Qty	Torque	
		kgf-m	lb-ft
Fuel Pump Bolts	6	0.35	2.5

7. Fuel System> Fuel Pump



Connect the fuel hose to the outlet pipe on the fuel pump. Tighten the clamp securely with a #2 Phillips screwdriver.



Plug in the fuel pump connector.

Throttle Body Removal and Installation

SAFETY FIRST: Protective gloves and eyewear are recommended at this point.

Inspection

Throttle Body /MAP/ISC/TPS

- Turn off the ignition switch during removal/installation.
- Check and confirm if the voltage is over 12V with a voltmeter after replacement.
- Check and confirm if the other connectors are installed correctly after replacement.
- Do not damage the throttle body, it may cause the throttle and idle valve to fail synchronization.
- The throttle body is preset in KYMCO factory, do not disassemble it incorrectly.
- Do not loosen or tighten the painted bolts and screws for the throttle body. Loosening or tightening them can cause the throttle and idle valve synchronization to fail.
- TPS and ISC have to be reset after the throttle body MAP, TPS, ISC or ECU has been reinstalled.

MAP Inspection

Support the scooter on a level surface.

Put the side stand up and engine stop switch is at "RUN".

Turn the ignition switch to "ON" position.

7. Fuel System> Throttle Body Removal



Measure if the ECU voltage outputs to the MAP between the following terminals of the MAP connector.

Terminal	Normal
Violet/Red (+) – Green/Pink (-)	5 V

TPS Inspection

Support the scooter on a level surface.

Put the side stand up and engine stop switch is at "RUN".

Turn the ignition switch to "ON".

7. Fuel System> Throttle Body Removal



Measure if the ECU voltage outputs to TPS between the following terminals of the TPS connector.

Terminal	Normal
Violet/Red (+) – Green/Pink (-)	5 V
Throttle Position Sensor (TPS) resistance (at 20°C/68°F)	3500 - 6500 Ω

7. Fuel System> Throttle Body Removal

Removal

Throttle Cables



Free the throttle cables from the throttle drum.

7. Fuel System> Throttle Body Removal

Fuel Injector

SAFETY FIRST: Protective gloves and eyewear are recommended at this point.

Warning: Gas is extremely flammable! Do not work around an open flame or a source of sparks.

Disconnect the Fuel Pump Relay or Fuel Pump Connector.



In order to release fuel pressure from the fuel pipe when removing the fuel injector, unplug the fuel pump connector. Start the engine and let it run until it dies of fuel starvation. Turn the ignition switch off.



Inspect the fuel hose for signs of deterioration or damaged. Replace the fuel hose as needed.

7. Fuel System> Throttle Body Removal



Remove the fuel injector mounting bolt with a 10 mm socket.



Unplug the fuel injector connector.

7. Fuel System> Throttle Body Removal



Lift the fuel injector out of the intake pipe.

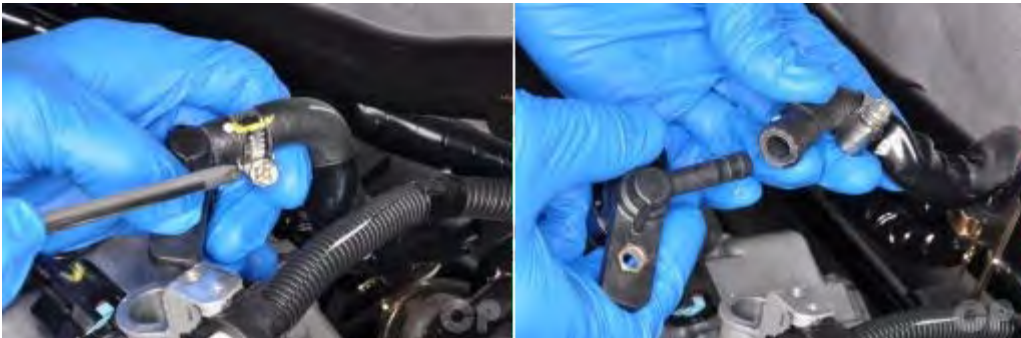

Loosen the fuel hose clamp with a #2 Phillips screwdriver. Slide back the clamp and free the injector fuel pipe from the fuel hose.

7. Fuel System> Throttle Body Removal



Lift the fuel pipe off the top of the injector.

Sensors



Unplug the MAP sensor.

7. Fuel System> Throttle Body Removal



Unplug the ISC connector.

Throttle Body



Unplug the throttle position sensor (TPS) connector.

7. Fuel System> Throttle Body Removal



Loosen the air box hose clamp screw at the throttle body with a #2 Phillips.



Loosen the intake hose clamp screw at the throttle body with a flat blade screwdriver.



Remove the throttle out of the air box and intake boots.

7. Fuel System> Throttle Body Removal

Installation

Throttle Body



Fit the throttle body into the air box and intake boots.



Tighten the intake hose clamp securely with a flat blade screwdriver.

7. Fuel System> Throttle Body Removal

Throttle Cables



Connect the throttle cables to the throttle drum.

Adjust the throttle cable free play with 12 mm wrenches.

7. Fuel System> Throttle Body Removal

Sensors



Plug in the TPS connector.



Plug in the ISC connector.

7. Fuel System> Throttle Body Removal



Plug in the MAP sensor.

Fuel Injector



Apply a light coat of fresh engine oil to a new fuel injector O-ring.

7. Fuel System> Throttle Body Removal



Fit the fuel injector pipe onto the top of the injector. The tab on the injector must fit into the pipe.



Fit the fuel hose onto the fuel injector pipe. Secure the hose to the fuel injector with the clamp. Tighten the clamp securely with a #2 Phillips screwdriver.



Fit the injector into the intake pipe as shown.



Plug in the fuel injector connector and thread in the mounting bolt.



Tighten the fuel injector bolt securely with a 10 mm socket.

Connect the Fuel Pump Relay or Fuel Pump Connector.

The throttle position sensor (TPS) and idle air bypass valve (ISC) have to be reset when the throttle body MAP, TPS, ISC or ECU have been reinstalled. See the TPS/ISC Reset Procedure for more information.

Throttle Body

SAFETY FIRST: Protective gloves and eyewear are recommended at this point.

Remove the throttle body. See the Throttle Body Removal topic for more information.

Disassembly



The throttle position sensor (TPS) and idle air bypass valve (ISC) have to be reset when the throttle body MAP, TPS, ISC or ECU have been reinstalled.

MAP Sensor



Fuel Injector

SAFETY FIRST: Protective gloves and eyewear are recommended at this point.

Warning: Gas is extremely flammable! Do not work around an open flame or a source of sparks.

Removal



In order to release fuel pressure from the fuel pipe when removing the fuel injector, unplug the fuel pump connector. Start the engine and let it run until it dies of fuel starvation. Turn the ignition switch off.



Inspect the fuel hose for signs of deterioration or damaged. Replace the fuel hose as needed.



Remove the fuel injector mounting bolt with a 10 mm socket.



Unplug the fuel injector connector.



Lift the fuel injector out of the intake pipe.

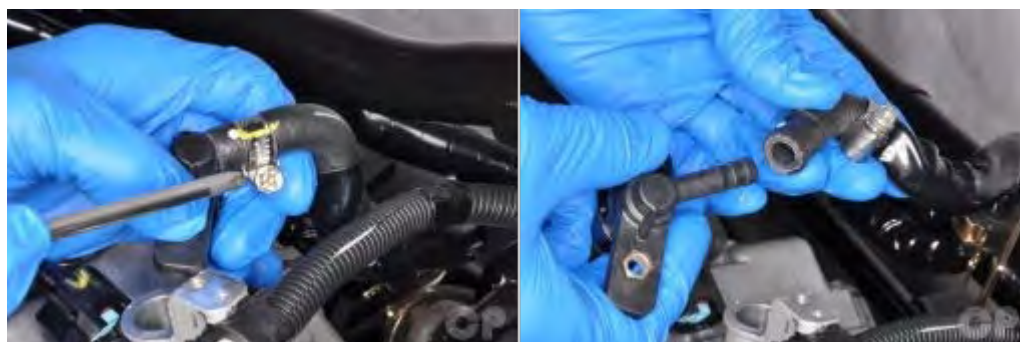

Loosen the fuel hose clamp with a #2 Phillips screwdriver. Slide back the clamp and free the injector fuel pipe from the fuel hose.



Lift the fuel pipe off the top of the injector.

Inspection

A digital multi meter is needed to test the fuel injector.

Measure the resistance between the fuel injector terminals

ITEM	SPECIFICATIONS
Fuel injector resistance (at 20°C/68°F)	11.7 ± 0.6 Ω



Inspect the seals on both sides of the fuel injector. Replace the injector if the seals are in poor condition.

Check for signs of clogging.

Set the multi meter to read ohms of resistance (Ω).

Cleaning

PROBLEM

1. Fuel Injector cannot output the fuel.
2. The Injector injection time (ms) is shorter or longer.

Standard: < 1.6ms

ANALYSIS

Injector block (With some carbons).

TROUBLESHOOTING

1. Use the specified injector cleaner.
2. Pouring the liquid of carburetor cleaner until half container.
3. Connect the battery as picture.
4. The injector cleaner with the flash relay.
5. Keeping the fuel Injector operation.
6. Waiting for 20-30 minutes.
7. Cleaning the carbons completely.

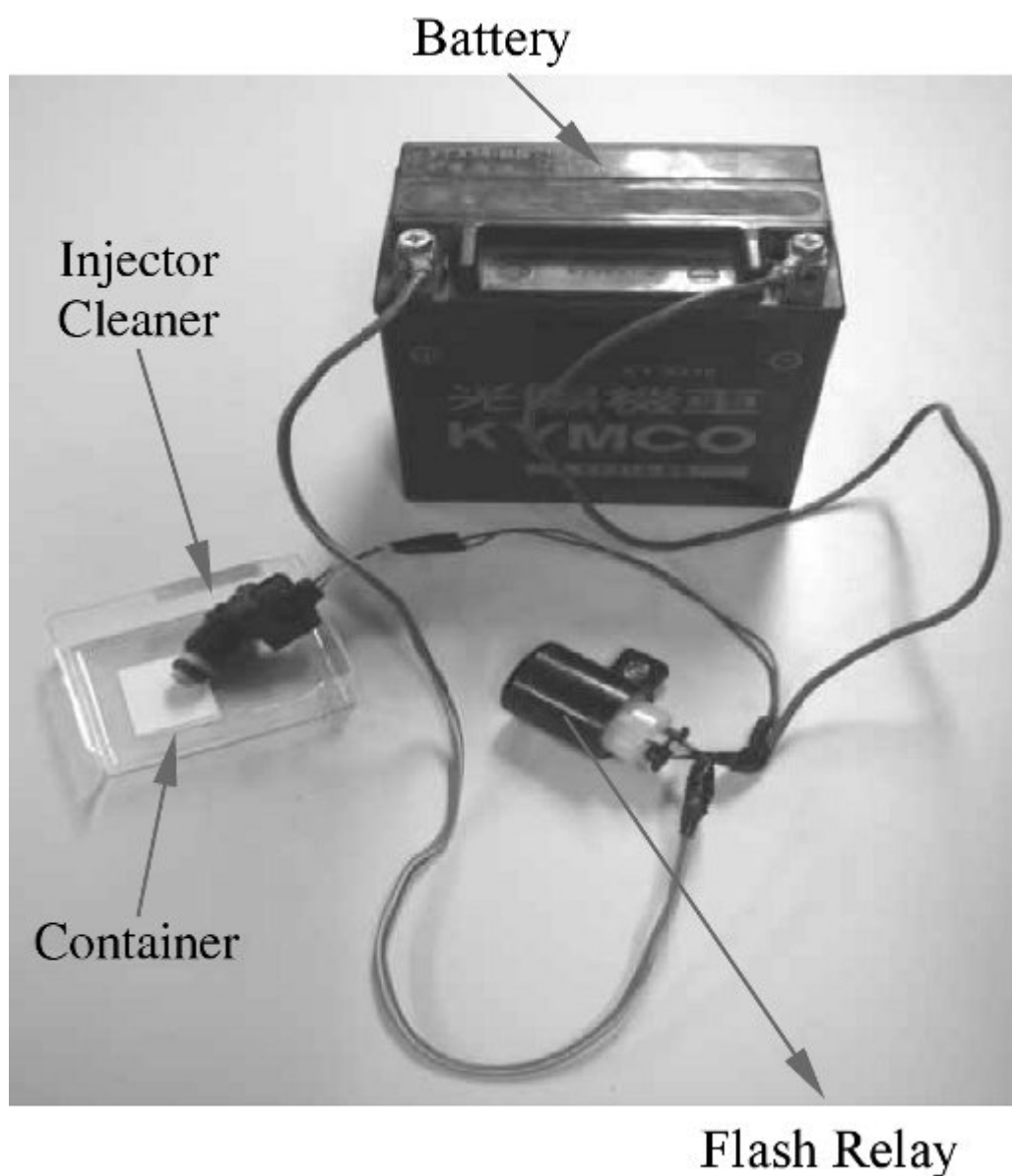

Installation



Apply a light coat of fresh engine oil to the fuel injector O-ring seals.



Fit the fuel injector pipe onto the top of the injector. The tab on the injector must fit into the pipe.



Fit the fuel hose onto the fuel injector pipe. Secure the hose to the fuel injector with the clamp. Tighten the clamp securely with a #2 Phillips screwdriver.



Fit the injector into the intake pipe as shown.



Plug in the fuel injector connector and thread in the mounting bolt.



Tighten the fuel injector bolt securely with a 10 mm socket.



Plug in the fuel pump connector.

Self-Diagnosis

SAFETY FIRST: Protective gloves and eyewear are recommended at this point.

Note: No matter when the CELP illuminated while riding condition, should find out the cause of the problem as soon as possible.

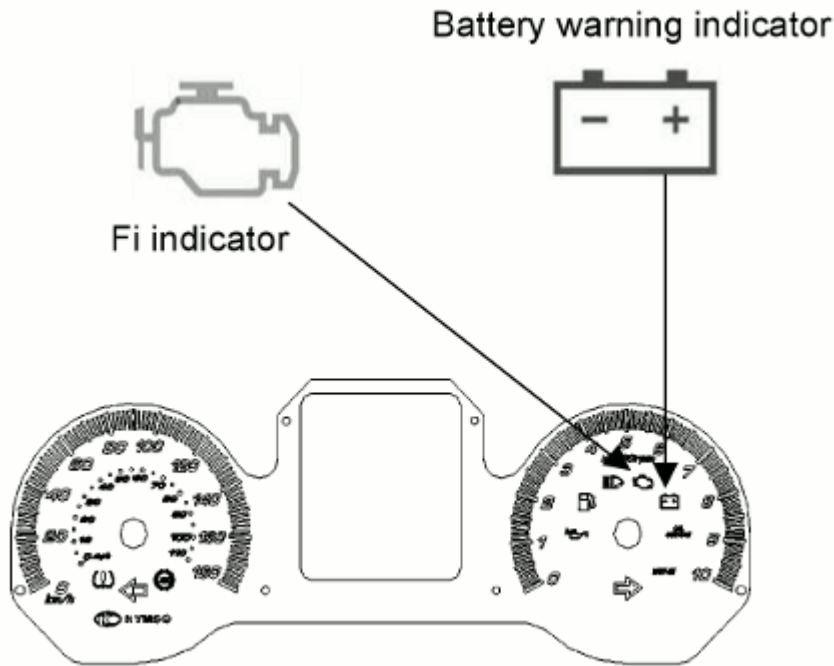

The check engine lamp (CELP) or Fi indicator is located next to the battery warning indicator.

If the ECM connectors, or battery leads are disconnected the stored malfunction codes will be lost.

Without Diagnostic Special Tool

SELF-DIAGNOSTIC PROCEDURES

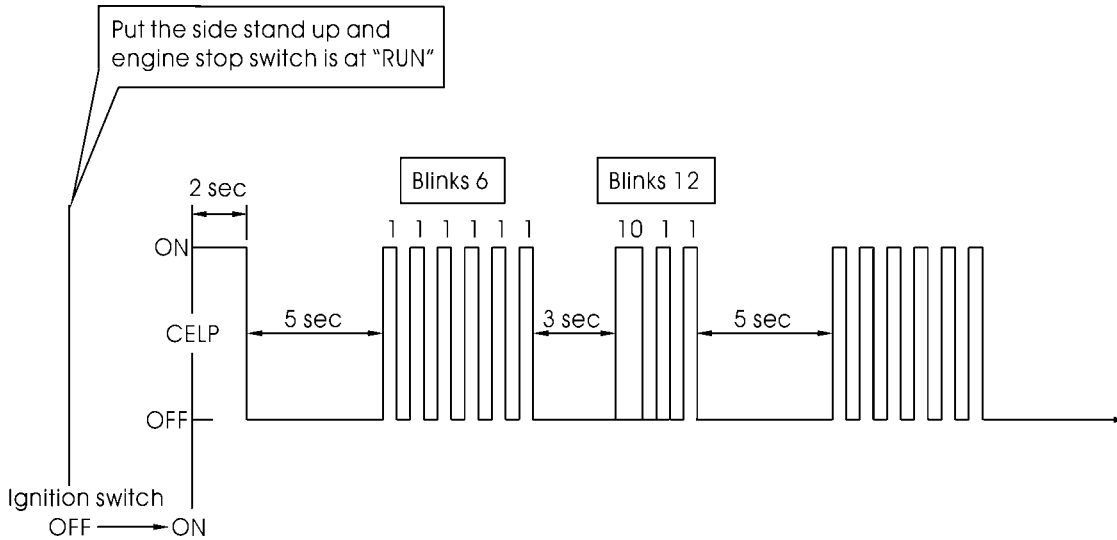

The "CELP" denotes the failure codes. When the indicator lights for one second is equal to ten.

For example: one longer blink illumination and two shorter blinks (0.5 second x 2) of the indicator are equal to 12 blinks. Follow code 12.

If more than a damaged part has occurred, the "CELP" begins blinking in order.

For example: If the indicator blinks six times, then shows one second illumination and two blinks, so there are two failures have occurred. Follow code 6 and 12.

Fuel Injection Diagnostic Tool

SAFETY FIRST: Protective gloves and eyewear are recommended at this point.

OPERATION INSTRUCTIONS



Diagnostic tool Part Number: 3620A-LEB2-E00

This tool has been developed by KYMCO and for KYMCO vehicles only. The tool software can be updated for new models with a computer via the USB cable.

Please refer to the specifications when serving this vehicle. See the K-XCT 300i Specifications topic for more information.

This tool does not have an internal battery. The power for the tool is provided by the vehicle when connected. The vehicle should have a fully charged battery when using the diagnostic tool.

Throttle Cable

SAFETY FIRST: Protective gloves and eyewear are recommended at this point.

Removal

Adjust the throttle cables for maximum free play at the throttle body.



Free the throttle cables from the throttle drum.

7. Fuel System> Throttle Cable



Remove the two right switch housing mounting screws with a #2 Phillips screwdriver. Disconnect the switch.



Separate the switch housing from the handlebar.

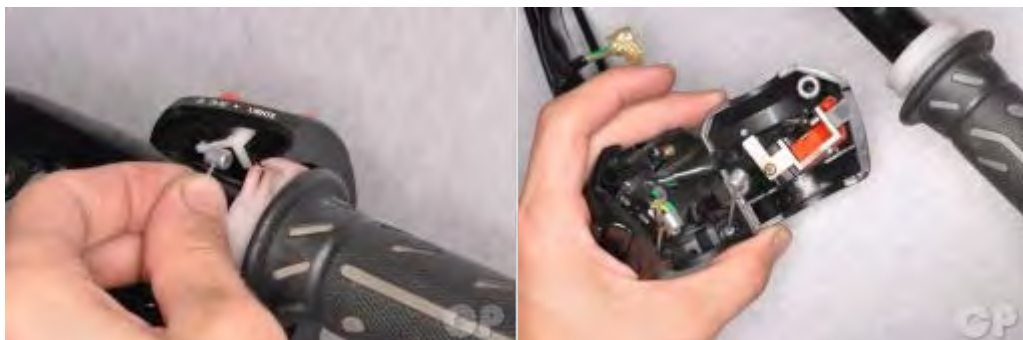

Disconnect the throttle cables and free the right switch housing from the handlebar.



Guide the throttle cables out towards the handlebar side.

Installation



Route the throttle body end of the cables through the opening in the lower handlebar cover.

7. Fuel System> Throttle Cable



Route the cables through the guide.



Route the cables down the inside of the left side of the frame.



Route the cables to the throttle body as shown.



7. Fuel System> Throttle Cable



Connect the throttle cables to the throttle drum.



Slide the throttle grip onto the right side of the handlebar.



Install the right switch and throttle housing. The post on the housing should fit into the hole in the bar.



Lubricate the end of the throttle in grease. Fit the ends of the throttle cables into the throttle tube.

Adjust the throttle cable free play with 12 mm wrenches.

TPS ISC Reset Procedure

SAFETY FIRST: Protective gloves and eyewear are recommended at this point.

- When opening and closing the throttle grip randomly, the ECU may record the incorrect TPS reading when the ECU or the throttle body has been reinstalled. It can cause hard to start engine or idling speed is not smooth when engine installation.
- ISC has a motor inside, which controls the ISC valve to obtain a smooth idling speed. The ECU may record the incorrect ISC position when the engine is running because the ECU or the throttle body has been reinstalled. It can cause engine to stop, hard to start engine or rough idling speed.
- The throttle position sensor (TPS) and idle air bypass valve (ISC) have to be reset when throttle body, MAP, TPS, ISC or ECU have been reinstalled.

TPS/ISC RESET PROCEDURE

1. Put the side stand up and engine stop switch is at "RUN".
2. Turn the key to the "OFF" position.
3. Fully open the throttle.
4. Turn the key to the "ON" position.
5. Release the throttle after waiting for eight seconds.
6. Turn the key to the "OFF" position.
7. Turn the key to the "ON" position.
8. TPS and ISC have been reset successfully.

If the procedure fails, repeat the steps from 1 to 8.

Steering

This chapter covers the location and servicing of the steering components for the KYMCO K-XCT 300i.

- Steering Stem and Bearing Removal..... 8-2~8-8
- Steering Stem and Bearing Installation 8-9~8-14
- Handlebar 8-15~8-25

TROUBLESHOOTING

Hard steering (heavy)

- Excessively tightened steering stem top cone race
- Broken steering balls
- Insufficient tire pressure

Steers to one side or does not track straight

- Uneven front shock absorbers
- Bent front fork
- Bent front axle or uneven tire

Steering Stem Removal

SAFETY FIRST: Protective gloves and eyewear are recommended at this point.



Support the vehicle with a suitable stand or jack so that the front wheel is off the ground. Grip the bottom of the fork legs and turn the front end side-to-side. If the movement is rough the bearings should be greased or replaced. If the movement is too tight or loose the steering stem adjusting nut may need to be adjusted.

The KYMCO K-XCT 300i uses ball bearings in the steering. Always replace the races at the same time as the bearings.

8. Steering > Removal



A special lock nut wrench is needed to loosen the steering stem lock nut.

Special Tool - Lock Nut Wrench: A120F00002



8. Steering > Removal



Slide the special tool over the steering stem and loosen the lock nut.
Remove the steering stem lock nut.
Slide off the lock washer.



Support the steering stem and loosen the steering stem adjusting nut
with a pin spanner.

8. Steering > Removal



Remove the steering stem adjusting nut.

Remove the dust cover and grease seal.



Lower the steering stem out of the frame.

8. Steering > Removal



Remove the upper bearing inner race.
Lift out the upper ball bearings.



Slide the lower ball bearings up and off of the steering stem.

Inspect the bearings and races for wear and damage. Replace them as needed.

8. Steering > Removal



Use a chisel to remove the bottom bearing inner race and dust seal. Do not damage the steering stem.



Use the special tools or a drift and hammer to drive out the bearing races in the steering head.

8. Steering > Removal



Have the drift set against the lip of the race, and work around the race evenly to drive it out. Repeat the process with the remaining bearing race.

Steering Stem Installation

SAFETY FIRST: Protective gloves and eyewear are recommended at this point.



Coat the new dust seal in grease and slide it down the steering stem. Drive the new lower bearing inner race onto the steering stem with a pipe with the same outside diameter as the bearing race.



Drive the new bearing races into the steering head with a suitable driver with the same outside diameter as the bearing race.

8. Steering > Installation



Lubricate the upper bearing with grease and set it into place.



Lubricate the new lower bearing with grease and place it on the steering stem.

8. Steering > Installation



Set the upper bearing inner race into the upper bearing.



Guide the steering stem into the steering head of the frame.

8. Steering > Installation



Lubricate the grease seal with grease. Set the grease seal and dust cover into place over the steering stem.



Thread on the steering stem adjusting nut.

8. Steering > Installation



Tighten the steering stem adjusting nut. Turn the steering stem lock-to-lock several times to seat the bearings.

Loosen the adjusting nut 1/4 to 1/2 half turn. Adjust the nut so the steering moves correctly. The adjusting nut should be tight enough so that the steering doesn't flop back and forth and vertical movement is eliminated. However, it should not be so tight as to cause binding or require excessive force to turn.



Slide the lock washer onto the steering stem as shown.

8. Steering > Installation



Thread the steering stem lock nut onto the steering stem.



Torque the steering stem lock nut to specification with the lock nut wrench special tool.

Item	Qty	Thread size (mm)	Torque	
			kgf-m	lb-ft
Steering Stem lock nut	1	BC1	6.0-8.0	43.40-57.86

Special Tool - Lock Nut Wrench: A120F00002

8. Steering > Handlebar

Handlebar

SAFETY FIRST: Protective gloves and eyewear are recommended at this point.

Removal

Bar Ends



Remove the bar ends with a 6 mm Allen.

To remove the brake master cylinders see the. Brake Master Cylinder topic.

Switch Housings and Throttle



Remove the two right switch housing mounting screws with a #2 Phillips screwdriver. Disconnect the switch.

8. Steering > Handlebar



Separate the switch housing from the handlebar.

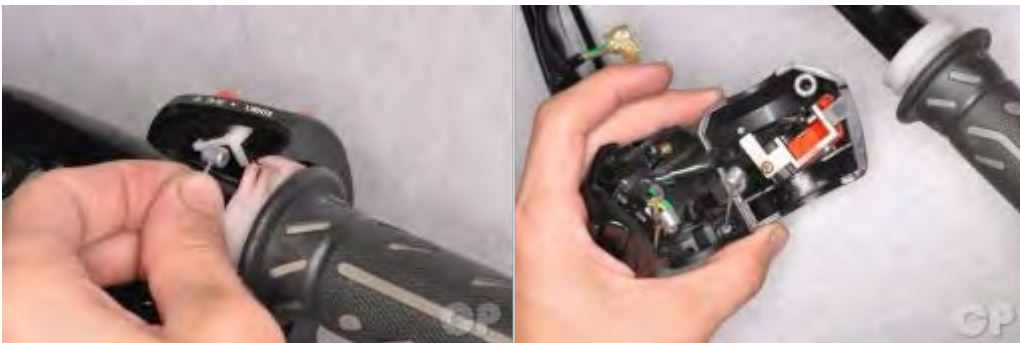

Disconnect the throttle cables and free the right switch housing from the handlebar.



Slide off the throttle grip.

8. Steering > Handlebar



Remove the two left switch housing mounting screws with a #2 Phillips screwdriver.



Disconnect the switch. Separate the left switch housing from the handlebar.

8. Steering > Handlebar

Handlebar



Route the cables and lines from the handlebar cable guide.



Hold the handlebar lock bolt with a 14 mm wrench and loosen the nut with a 17 mm socket.

8. Steering > Handlebar



Remove the handlebar lock nut and bolt.



Remove the handlebar.

Grips



If you plan to replace the grips you can slice them lengthwise with a razor blade and peel them off. To remove the grips without cutting them use a screwdriver to open a gap between the grip and the handlebar.

Spray in contact cleaner to break up the grip cement. Use compressed air to expand the grip so it can be easily slid off the end of the handlebar. Note the relationship between the angle of the grip and the throttle tube so that the new grip can be installed with the correct angle.

NOTE: Always wear safety glasses when using compressed air and never point it directly at yourself or anyone else.

Before installing the grips to either the throttle tube or the handlebar, wipe down the area with a brake or parts cleaner that will dry without leaving a residue. When you are sure the area is dry apply grip cement to the bar or tube. Install the left grip at an angle of your preference. Install the throttle grip onto the tube with the same angle as the original grip.

8. Steering > Handlebar

Installation

Handlebar



Install the handlebar onto the steering stem and align the holes.



Install the handlebar lock bolt and thread on the nut.

8. Steering > Handlebar



Hold the handlebar lock bolt with a 14 mm wrench and tighten the nut to specification with a 17 mm socket.

Item	torque	
	N-m	lb-ft
Handlebar Lock Nut	45	32



Route the cables and lines through the handlebar cable guide.

8. Steering > Handlebar

Switch Housings and Throttle



Align the left switch housing and install on the handlebar.



Insert the two housing screws and tighten them securely with a #2 Phillips screwdriver. Connect the switch.

8. Steering > Handlebar



Slide the throttle grip onto the right side of the handlebar.



Install the right switch and throttle housing. The post on the housing should fit into the hole in the bar.



Lubricate the end of the throttle in grease. Fit the ends of the throttle cables into the throttle tube.

8. Steering > Handlebar



Insert the two housing screws and tighten them securely with a #2 Phillips screwdriver. Tighten the front bolt before the rear.

Bar Ends



Install the bar ends with a 6 mm Allen.

Brakes

This chapter covers the location and servicing of the brake system components for the KYMCO Downtown 300i.

- Master Cylinders..... 9-2~9-16
- Front Caliper..... 9-17~9-26
- Rear Caliper 9-27~9-33
- Brake Discs 9-34~9-42
- Brake Pad Replacement 9-43~9-54
- ABS 9-55~9-72

GENERAL INSTRUCTIONS

- During servicing, keep oil or grease off the brake pads and brake disk.

TROUBLESHOOTING

Poor brake performance

- Worn brake pads
- Contaminated brake pad surface
- Deformed brake disk
- Air in brake system
- Deteriorated brake fluid
- Worn brake master cylinder piston oil seal
- Clogged brake fluid line
- Unevenly worn brake caliper

Master Cylinders

SAFETY FIRST: Protective gloves and eyewear are recommended at this point.

NOTE: Brake fluid is a corrosive chemical and can damage paints and some plastics.
Avoid contact with skin.

Removal



Remove the brake hose banjo bolt from the master cylinder using a 12 mm socket. Discard the sealing washers.





Unplug the brake light switch connector.



Remove the two master cylinder mounting bolts with an 8 mm socket.



Remove the master cylinder clamp.



Remove the master cylinder.



Remove the two master cylinder cover screws with a #2 Phillips head screwdriver.



Remove the master cylinder cover, plastic piece and rubber accordion diaphragm. Pour out any remaining brake fluid.

Disassembly

Brake Levers



Loosen the brake lever pivot nut with a 10 mm socket and the pivot bolt with a flat blade screwdriver.



Remove the pivot nut and bolt.



Remove the brake lever.

Brake Light Switch

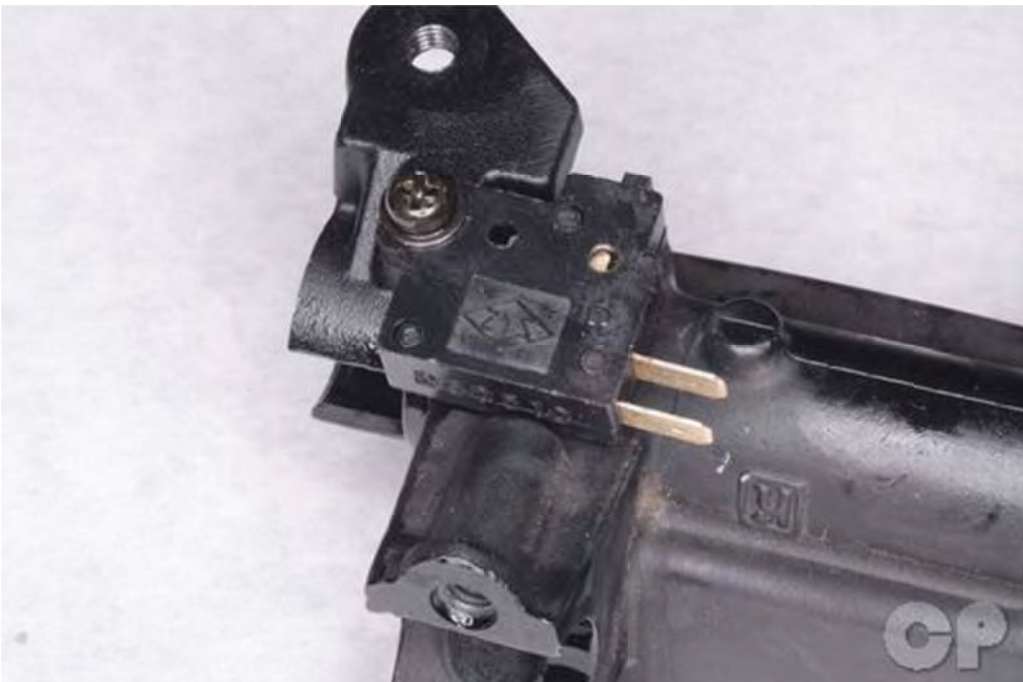

Remove the brake light switch mounting bolt with a #2 Phillips screwdriver. Remove the brake light switch.

Piston



Remove the rubber piston cover.



Remove the snap ring using a pair of internal snap ring pliers. Use a suitable tool to hold back the piston as it can spring out.



Remove the piston, spring and cups.



Remove the spring from the piston and

Inspection

Clean the master cylinder components with fresh brake fluid. Inspect the master cylinder components for wear and damage. Replace the parts as needed



Inspect the piston and cups for wear and damage. Measure the outside diameter of the piston.

Item	Standard mm (in)
Brake master cylinder piston O.D.	12.65 - 12.68 (0.506 - 0.5072)



Inspect the master cylinder bore for wear and damage. Measure the inside diameter of the brake master cylinder.

Item	Standard mm (in)
Brake master cylinder I.D.	12.7 - 12.74 (0.508 - 0.5096)

Assembly

Piston



Place a film of clean DOT 4 brake fluid on the piston, spring and master cylinder bore.



Install the master cylinder piston and spring into the master cylinder bore.



Compress the snap ring with internal snap ring pliers and Install the snap ring.

Brakes > Front Brake Caliper

Install the rubber boot over the end of the master cylinder piston.

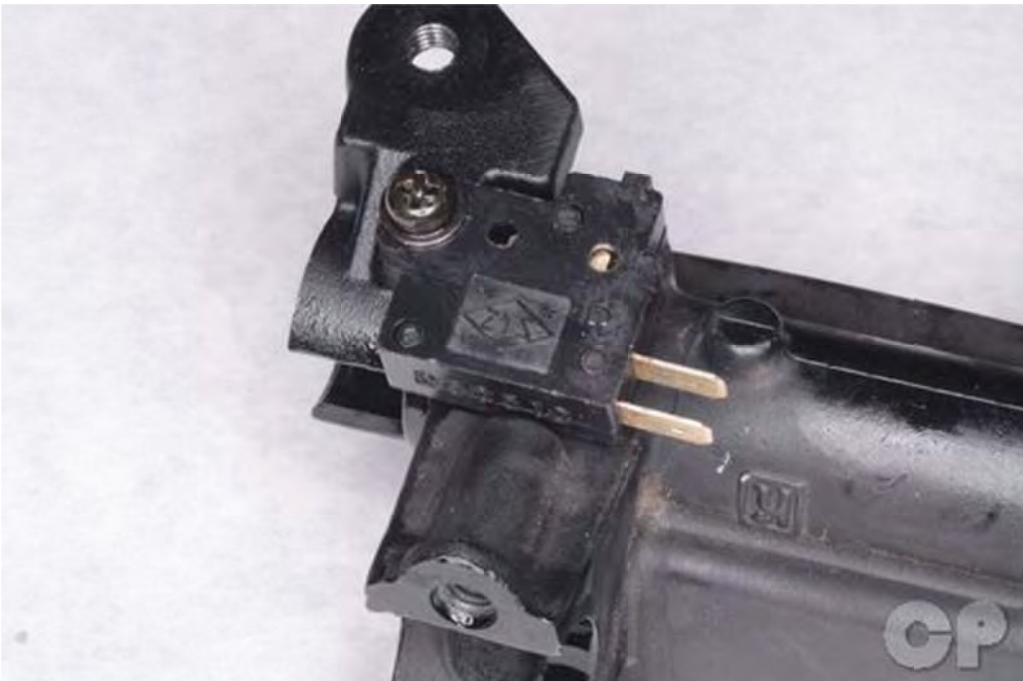
Brake Light Switch

Install the brake light switch. Tighten the mounting screw securely with a #2 Phillips screwdriver.

Brake Levers



Install the brake lever.



Apply a light coat of grease to brake lever pivot bolt. Insert the pivot bolt from above and thread on the nut.



Tighten the brake lever bolt with a flat blade screwdriver and then tighten the nut with a 10 mm socket.

Installation



Position the master cylinder on the handlebar.



Install the master cylinder clamp. Be sure to insert the pin on the clamp into the hole on the handlebar.



Install the two master cylinder mounting bolts and tighten them securely with an 8 mm socket.

Brakes > Front Brake Caliper



Plug in the brake light switch connector.



Install the brake hose to the master cylinder with the banjo bolt. Use new sealing washers. Tighten the banjo bolt to specification with a 12 mm socket.

Item	Torque	
	N-m	lb-ft
Banjo bolt	35	25.8

Fill the master cylinder reservoir/s with brake fluid and bleed the system.

Front Caliper

SAFETY FIRST: Protective gloves and eyewear are recommended at this point.

Removal

Drain the brake fluid if the caliper is to be disassembled.



Remove the two caliper mounting bolts with a 12 mm socket.



Remove the speedometer sensor mounting bolt with an 8 mm socket.

Brakes > Front Brake Caliper



Remove the speedometer sensor.

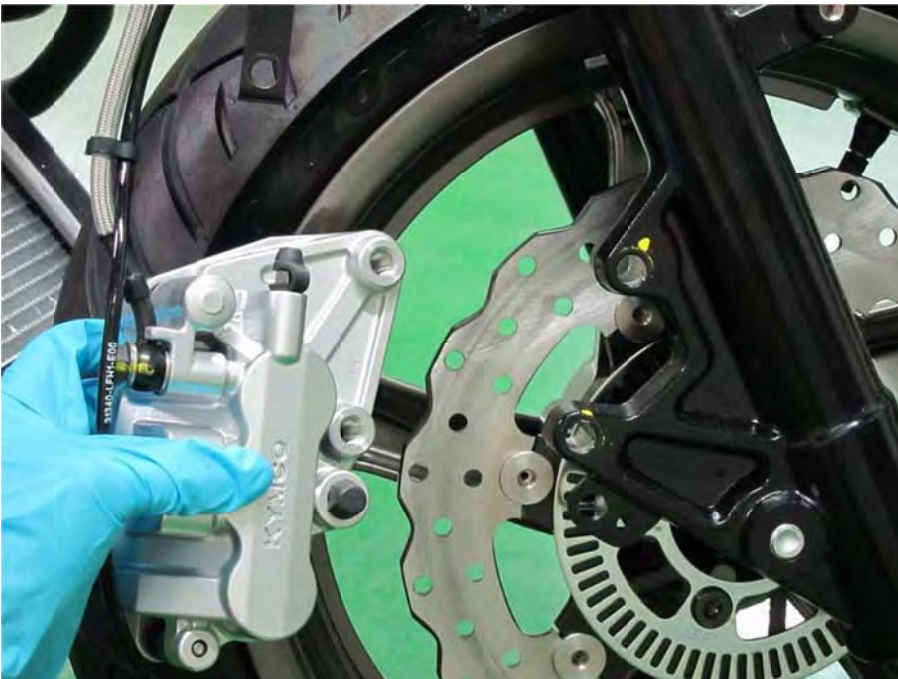

Remove the front caliper.

Brake Pad Removal



Loosen the brake pad pin with a 5 mm Allen.
Remove the brake pad pin.



Remove the brake pads. Replace the pads if the brake wear exceeds the wear indicator lines or if the wear is uneven.

Disassembly



Remove the pad spring.

Inspection



Inspect the pistons for wear and damage.



Measure the outside diameter of the piston with a micrometer and compare the measurement with the specification. Replace the pistons as needed.

Item	Standard mm (in)
Brake caliper piston O.D.	26.93 - 26.96 (1.0602 - 1.0614)

Brakes > Front Brake Caliper



Inspect the piston bores for wear and damage.



Inspect the piston bores for wear and damage. Measure the inside diameter of the piston bore with a telescoping gauge and micrometer. Replace the caliper as needed.

Item	Standard mm (in)
Brake caliper cylinder I.D.	27 - 27.05 (1.063 - 1.065)

Brake Pad Installation



Insert the brake pads into the caliper.



Fit the ends of the pads into the pad retainer as shown.



Apply a light coat of waterproof grease to the brake pad pin.
Push the pads against the pad spring and insert the brake pad pin.

Installation

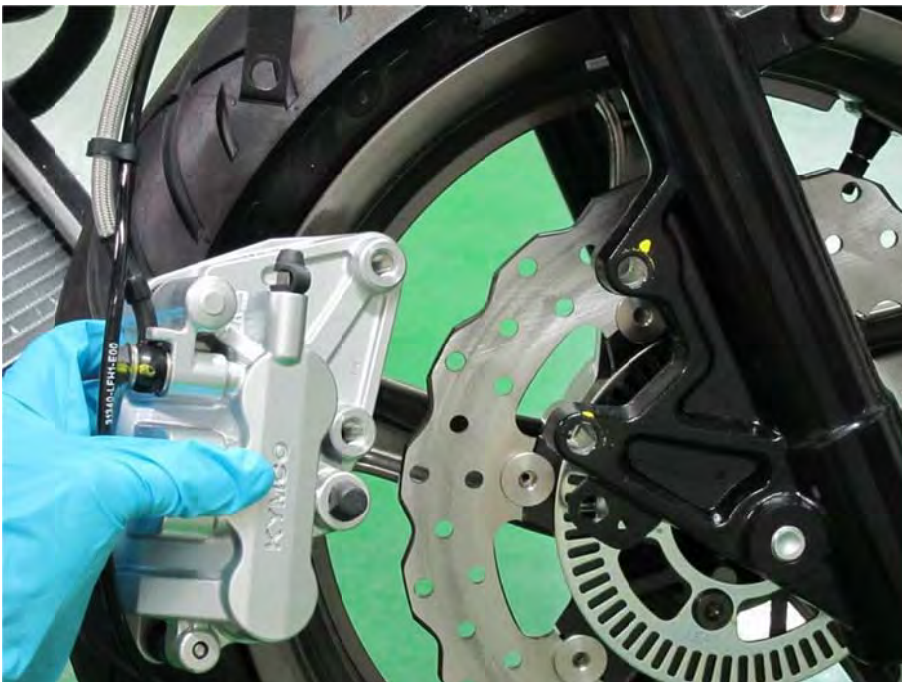

Install the front caliper. Guide the brake disc between the pads.
Line up the caliper bracket mounts with the fork.

Brakes > Front Brake Caliper



Install the two caliper bracket mounting bolts. Tighten the mounting bolts to specification.

Item	Torque	
	N-m	Lb-ft
Front/Rear caliper bolt	35	25.8



Install the banjo bolt with new sealing washers and tighten to specification with a 12 mm socket.

Item	Torque	
	N-m	Lb-ft
Banjo bolt	35	25.8

8. Brakes > Rear Brake Caliper



Install the speedometer sensor.



Install the speedometer sensor mounting bolt with an 8 mm socket.

Item	Torque	
	N-m	Lb-ft
Speed sensor cable	9.80 - 13.73	7.23 - 10.13

Tighten the brake pad pin securely with a 5 mm Allen.

8. Brakes > Rear Brake Caliper

Rear Caliper

SAFETY FIRST: Protective gloves and eyewear are recommended at this point.

Warning: Brake fluid is very caustic and can damage paint, chrome and plastic.
Wipe up any spills immediately.

Removal

If the caliper is to be disassembled the brake hose must be removed.

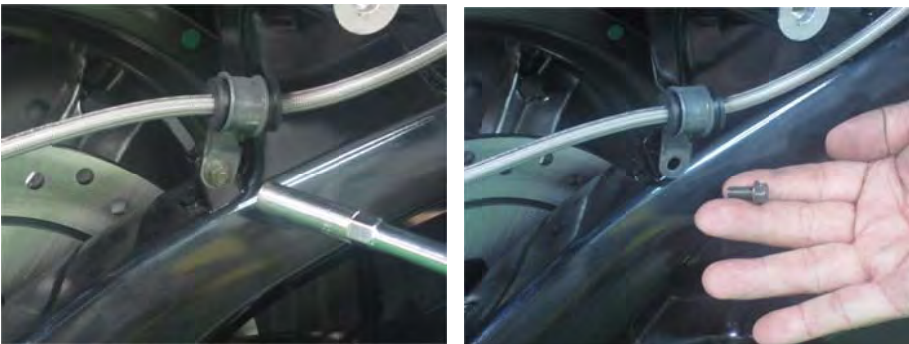
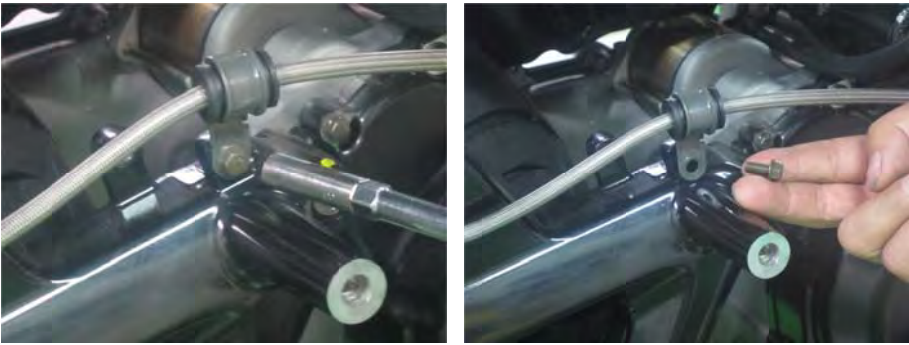

Remove the two rear brake hose clamp bolts with a 8 mm socket.



Remove the rear brake hose clamp.

8. Brakes > Rear Brake Caliper



Remove the two rear caliper mounting bolts with a 12 mm socket.

8. Brakes > Rear Brake Caliper



Remove the rear caliper from the swingarm.

Disassembly



One at a time, move the brake pads to the center gap in the pad retainers and lift the pad out. If needed, use the piston side pad to push the pistons in to allow for more room.

Replace the pads if the brake wear exceeds the wear indicator lines or if the wear is uneven.

8. Brakes > Rear Brake Caliper

Inspection



Measure the outside diameter of the piston with a micrometer and compare the measurement with the specification. Replace the pistons as needed.

Item	Standard (mm)
Rear brake caliper piston O.D.	25.33-25.36



Inspect the piston bores for wear and damage.

8. Brakes > Rear Brake Caliper



Inspect the piston bores for wear and damage. Measure the inside diameter of the piston bore with a telescoping gauge and micrometer. Replace the caliper as needed.

Item	Standard (mm)
Rear brake caliper bore I.D.	25.40 - 25.45

Assembly

Lubricate the caliper pistons, the caliper piston bores and the seals with DOT 4 brake fluid from a tightly sealed container.

NOTE: Brake fluid is a corrosive chemical and can damage paints and some plastics. Avoid contact with skin.



One at a time, fit the brake pads into the center gap in the pad retainers and then move the pad into the retainer. If needed, use the piston side pad to push the pistons in to allow for more room.

Installation

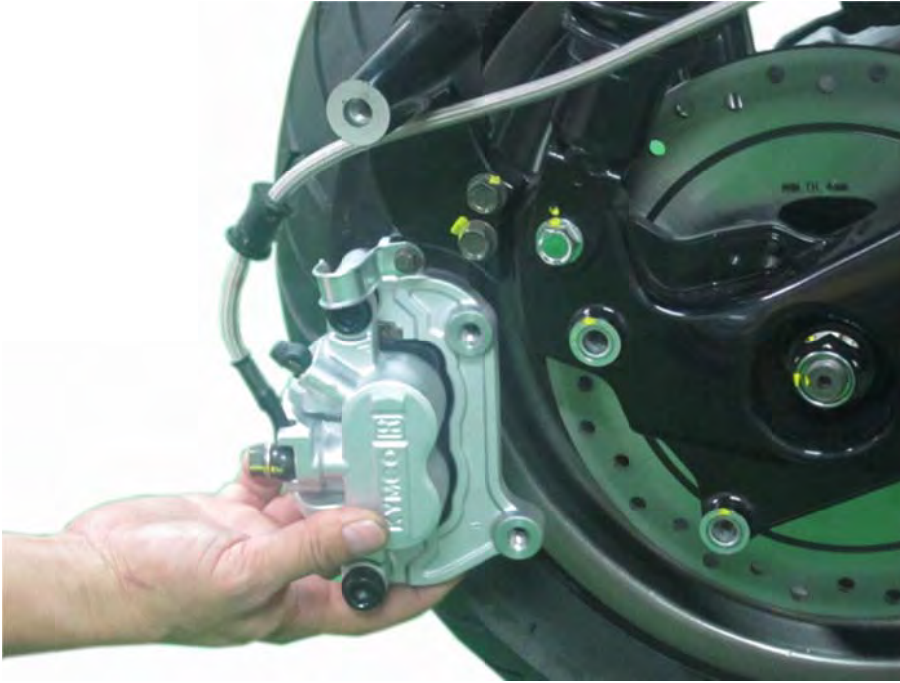

Install the rear caliper onto the swingarm.



Install the two caliper bracket mounting bolts.
Tighten the mounting bolts to specification.

Item	Torque	
	N-m	lb-ft
Front/Rear caliper bolt	35	25.8

9. Brakes > Brake Disc



Fit the rear brake hose guide into place.

Insert the two rear brake hose clamp bolts and tighten them securely with a 10 mm socket.

Fill the rear brake system with fresh brake fluid and bleed out the air. See the Brake Fluid topic for more information.

Pump the brake lever to seat the caliper pistons against the pads. Check the operation on the brakes before returning the vehicle to service.

Disc Brake

SAFETY FIRST: Protective gloves and eyewear are recommended at this point.

Inspection



Measure the thickness of the brake rotor with a Vernire caliper or micrometer.

ITEM		STANDARD
Brake disc thickness	Front	3.8 - 4.2 mm(0.15 - 0.165 in)
	Rear	5.0 mm(0.2 in)



Check if the brake rotor runout is within service limit.

Measure the runout of the brake disc with a dial gauge. If the reading is out of specification remove the disc from the wheel and recheck.

Item	Standard (mm)
Rear brake disk runout	max 0.4

Front

Removal

Remove the front wheel. See the Front Wheel topic for more information.



Remove the five brake disc mounting bolts with an Allen wrench.



Remove the front brake disc and front wheel speed sensor rotor.



Separate the wheel speed sensor rotor from the brake disc.

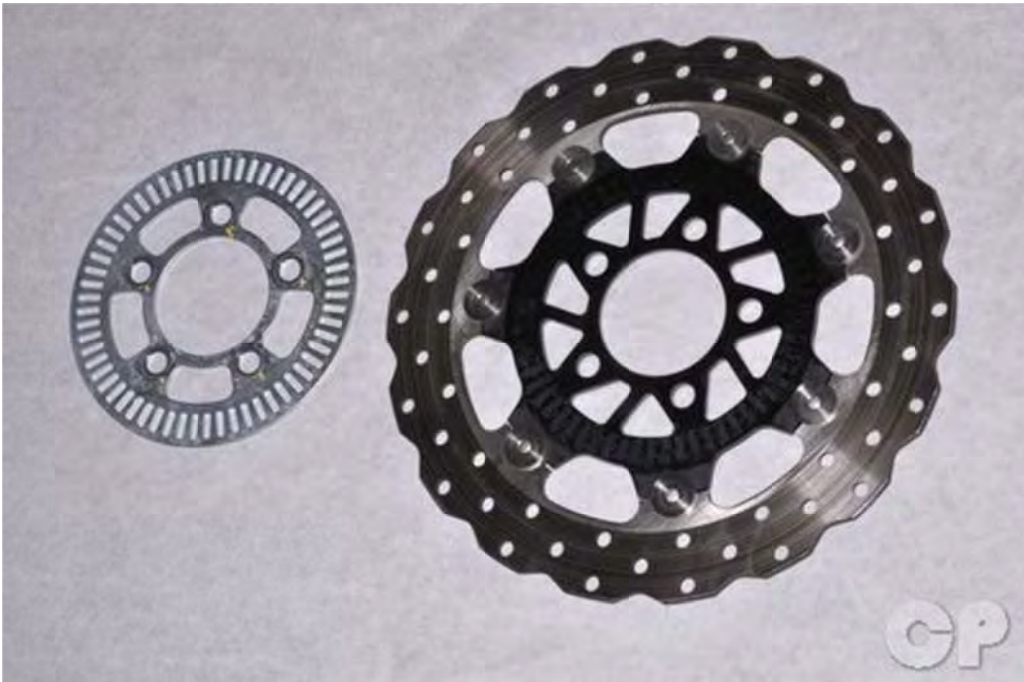

Inspect the wheel speed sensor and brake disc for wear and damage. Replace the parts as needed.



Set the front brake disc and speed sensor rotor in place on the front wheel.

Installation

Coat the threads of the disc bolts in a non-permanent thread locking agent. Thread in the bolts and torque them to specification with an Allen socket.



Set the speed sensor rotor on the front brake disc. Position the rotor so that its sharp side sits against the brake disc.



Insert the front brake disc mounting bolts. Tighten the bolts to specification with an Allen socket.

Item	Qty	Thread size (mm)	Torque	
			kgf-m	lb-ft
Disk bolt	5	8	3.2-3.8	23.15-27.48

Install the front wheel. See the Front Wheel topic for more information.

Rear

Removal



Remove the five brake disc mounting bolts with an Allen wrench.



Lift the brake disc off of the rear wheel.

Installation

Coat the threads of the disc bolts in a non-permanent thread locking agent. Thread in the bolts and torque them to specification with an Allen socket.



Set the rear brake disc in place as shown.



Insert the five rear brake disc mounting bolts and tighten them to specification with an Allen socket.

Item	Qty	Thread size (mm)	Torque	
			kgf-m	lb-ft
Disk bolt	5	8	3.2-3.8	23.15-27.48

Brake Pad Replacement

SAFETY FIRST: Protective gloves and eyewear are recommended at this point.



Replace the pads if the brake wear exceeds the wear indicator lines or if the wear is uneven.

Front



Loosen the brake pad pin with a 5 mm Allen.



Remove the two caliper mounting bolts with a 12 mm socket.



Remove the speedometer sensor mounting bolt with an 8 mm socket.



Remove the speedometer sensor.



Remove the front caliper.



Remove the brake pad pin.



Remove the brake pads. Replace the pads if the brake wear exceeds the wear indicator lines or if the wear is uneven. Insert new brake pads as needed.



Fit the ends of the pads into the pad retainer as shown.



Apply a light coat of waterproof grease to the brake pad pin.
Push the pads against the pad spring and insert the brake pad pin.

It may be necessary to spread the pads and force the pistons back into the caliper in order to allow room for the brake disc to fit between the new pads.



Install the front caliper. Guide the brake disc between the pads.
Line up the caliper bracket mounts with the fork.



Install the two caliper bracket mounting bolts. Tighten the mounting bolts to specification.

Item	Torque	
	N-m	lb-ft
Front/Rear caliper bolt	35	25.8



Install the speedometer sensor.



Install the speedometer sensor mounting bolt with an 8 mm socket.

Item	Torque	
	N-m	lb-ft
Speed sensor cable	9.80 - 13.73	7.23 - 10.13



Tighten the brake pad pin securely with a 5 mm Allen.

Pump the brake lever to seat the caliper pistons against the pads. Check the operation on the brakes before returning the vehicle to service.

Rear

If the caliper is to be disassembled the brake hose must be removed.
Drain the rear brake fluid. See the Brake Fluid topic for more information.

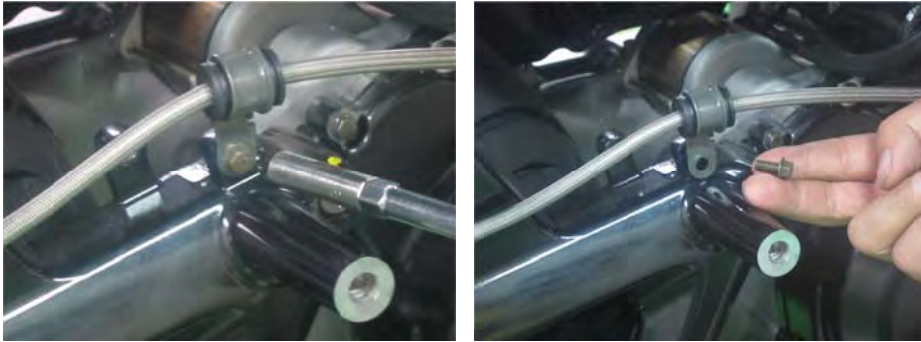

Remove the two rear brake hose clamp bolts with a 10 mm socket.

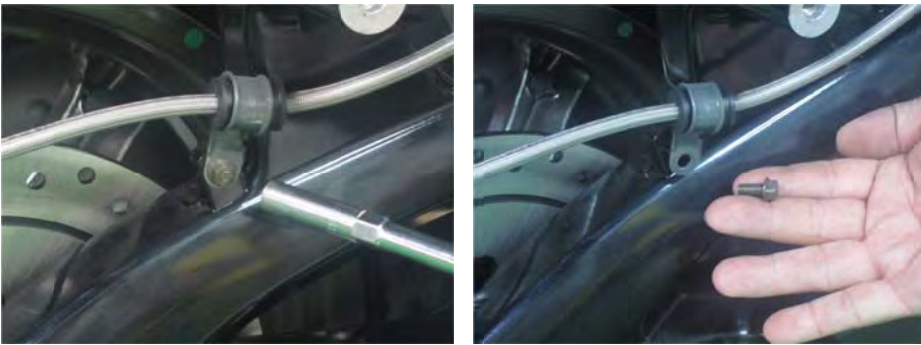

Remove the rear brake hose clamp.



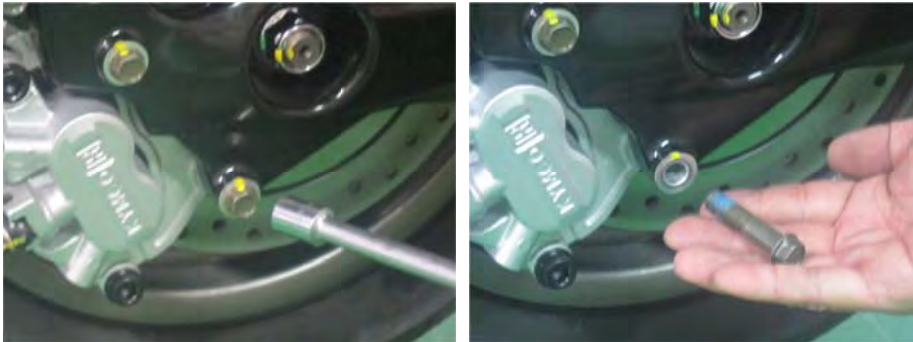

Remove the two rear caliper mounting bolts with a 12 mm socket.



Remove the rear caliper from the swingarm.



One at a time, move the brake pads to the center gap in the pad retainers and lift the pad out. If needed, use the piston side pad to push the pistons in to allow for more room.



Replace the pads if the brake wear exceeds the wear indicator lines or if the wear is uneven.

One at a time, fit the brake pads into the center gap in the pad retainers and then move the pad into the retainer. If needed, use the piston side pad to push the pistons in to allow for more room.

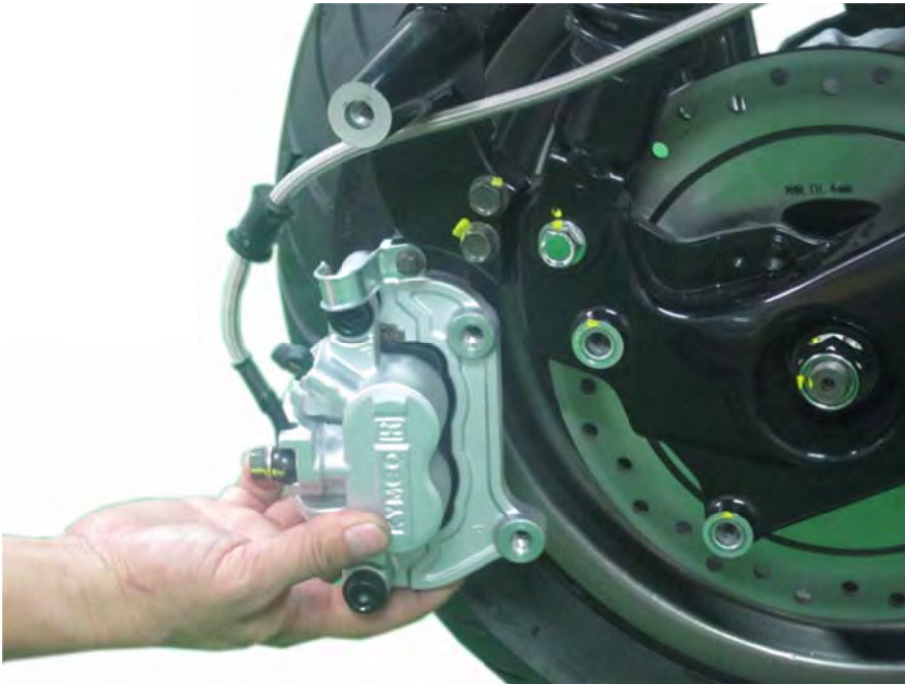

Install the rear caliper onto the swingarm.



Install the two caliper bracket mounting bolts. Tighten the mounting bolts to specification.

Item	Torque	
	N-m	lb-ft
Front/Rear caliper bolt	35	25.8

9. Brakes

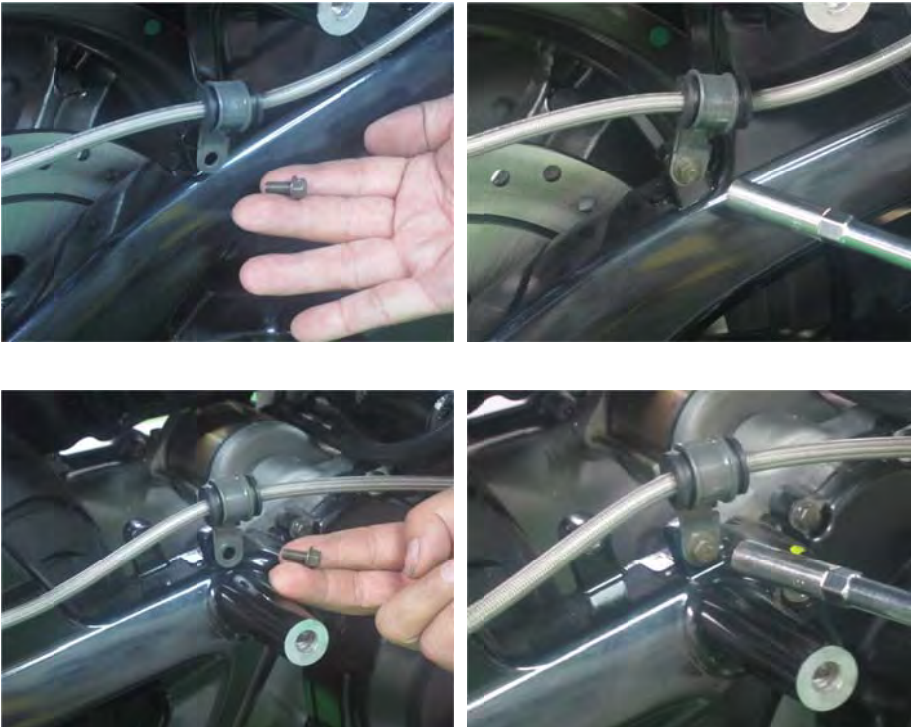

Fit the rear brake hose guide into place.

Insert the two rear brake hose clamp bolts and tighten them securely with a 10 mm socket.

Pump the brake lever to seat the caliper pistons against the pads. Check the operation on the brakes before returning the vehicle to service.

ABS

SAFETY FIRST: Protective gloves and eyewear are recommended at this point.

ABS Component Location



1. Front Wheel speed Sensor
2. Front Wheel speed Sensor Rotor
3. Rear Wheel speed Sensor
4. Rear Wheel speed Sensor Rotor
5. ABS Indicator Light
6. ABS Hydraulic Unit
7. ABS diagnosis tool Connector (Near battery position)

Introduction to KYMCO Anti-Lock Brake System

ABS is designed to help prevent the wheels from locking up when the brakes are applied hard while running straight. The ABS automatically regulates brake force.

Intermittently gaining gripping force and braking force helps prevent wheel lock-up and allows stable steering control while stopping.

Brake control function is identical to that of conventional vehicle. The brake lever is used for the front brake and rear brake.

Although the ABS provides stability while stopping by preventing wheel lock-up, remember the following characteristics:

- ABS can not compensate for adverse road conditions, misjudgment or improper application of brakes. You must take the same care as with vehicle not equipped with ABS.
- ABS isn't designed to shorten the braking distance. On loose, uneven or downhill surfaces, the stopping distance of a vehicle with ABS may be longer than that of an equivalent vehicle without ABS. Use special caution in such areas.
- ABS will help prevent wheel lock-up when braking in straight line but it cannot control wheel slip which may be caused by braking during cornering. When turning a corner, it is better to limit braking to a light application of both brakes or not to brake at all. Reduce your speed before you get into the corner.
- The computers integrated in the ABS compare vehicle speed with wheel speed. Since non-recommended tires can affect wheel speed, they may confuse the sensors resulting in extended braking distance.

Caution: Use of non-recommended tires may cause malfunctioning of ABS and lead to extended braking distance. The rider could have an accident as a result. Always use the standard tires for this vehicle.

Notice:

- When the ABS is functioning, you may feel a pulsing in the brake lever. This is normal - you need not suspend applying the brakes.
- ABS does not function below speeds of approximately 10 kph or 7 mph.
- ABS does not function if battery is discharged or there is a battery power supply malfunction (ABS light will come on).

ABS Servicing Precautions

There are a number of important precautions that should be followed servicing the ABS system.

- This ABS system is designed to be used with a 12V sealed battery as its power source. Do not use any other battery except for a 12V sealed battery as a power source.
- Do not reverse the battery cable connections. This will damage the ABS hydraulic unit.
- To prevent damage to the ABS parts, do not disconnect the battery cables or any other electrical connections when the ignition switch is ON or while the engine is running.
- Take care not to short the leads that are directly connected to the battery positive (+) terminal to the chassis ground.
- Do not turn the ignition switch is ON while any of the ABS electrical connectors are disconnected. The ABS hydraulic unit memorizes service codes.
- Do not spray water on the electrical parts, ABS parts, connectors, leads and wiring.
- Whenever the ABS electrical connections are to be disconnected, first turn off the ignition switch.
- The ABS parts should never be struck sharply, as with a hammer, or allowed to fall on a hard surface. Such a shock to the parts can damage them.
- The ABS parts cannot be disassembled. Even if a fault is found, do not try to disassemble and repair the ABS parts, replace the ABS unit with a new component.
- The ABS has many brake lines, pipes, and leads. And the ABS cannot detect problems with the conventional braking system (brake disk wear, unevenly worn brake pads and other mechanical faults). To prevent trouble, check the brake lines and pipes for correct routing and connection, the wiring for correct routing, and the brakes for proper braking power. Be sure to check for fluid leaking, and bleed the brake line thoroughly.

Caution

If any of the brake line fittings, including the ABS hydraulic unit joint nuts, or the bleed valve are opened at any time, the air must be bled completely from the brake line.

Do not ride the scooter with air in the brake line, or the ABS could malfunction.

- The ABS indicator light may light if the tire pressure is incorrect, a non-recommended tire is installed, or the wheel is deformed. If the indicator light lights, remedy the problem and clear the service code.

- When the ABS operates, the ABS makes noise and the rider feels the reaction force on the brake lever and brake pedal. This is a normal condition. It informs the rider that the ABS is operating normally.

- Service codes detected once by the ABS hydraulic unit will be memorized in the ABS hydraulic unit. Therefore, after maintenance work is finished, be sure to erase the service codes. Do not erase the service codes during troubleshooting. Wait until all the checks and repair work is finished to prevent duplication of previous service codes and unnecessary maintenance work.

- Before delivering the scooter to the customer, be sure to erase any service codes which might be stored in the ABS hydraulic unit. Test run the scooter at a speed of more than 6 kph (4 mph) to see that the ABS indicator light does not come on. Finally, test run the scooter at a speed of more than 30 km/h (20 mph) and brake suddenly to see that the scooter stops without loss of steering control and the ABS operates normally. (The reaction force generated is felt in the brake lever and pedal.) This completes the final inspection.

ABS Troubleshooting Outline

When an abnormality in the system occurs, the ABS indicator light lights up to alert the rider. The service codes stored in memory are not erased until the DTCs have been cleared after the fault has been corrected. Therefore, after correcting the problem always erase the service codes.

Even when the ABS is operating normally, the ABS indicator light may light up under the conditions listed below. Turn the ignition switch OFF to stop the indicator light. If the scooter runs without erasing the service codes, the light may light up again.

- After continuous riding on a rough road.

- When the ABS has been subjected to strong electrical interference.

9. Brakes

- When tire pressure is abnormal. Adjust tire pressure.
- When a tire different in size from the standard size is being used. Replace with standard size.
- When the wheel is deformed. Replace the wheel.

Much of the ABS troubleshooting work consists of confirming continuity of the wiring. The ABS parts are assembled and adjusted by the manufacturer, so there is no need to disassemble or repair them. Replace the ABS hydraulic unit if needed.

The basic troubleshooting procedures are listed below.

- Carry out pre-diagnosis inspections as a preliminary inspection.
- Check wiring and connections from the ABS hydraulic unit connector to the suspected ABS part, using the diagnosis tool.
Special tool - Diagnosis tester: 3620A-LEB2-E00
- Visually inspect the wiring for signs of burning or fraying. If any wiring is poor, replace the damaged wiring.
- Pull each connector apart and inspect it for corrosion, dirt and damage. If the connector is corroded or dirty, clean it carefully. If it is damaged, replace it.
- Check the wiring for continuity.

9. Brakes

Pre-diagnosis Inspection 1

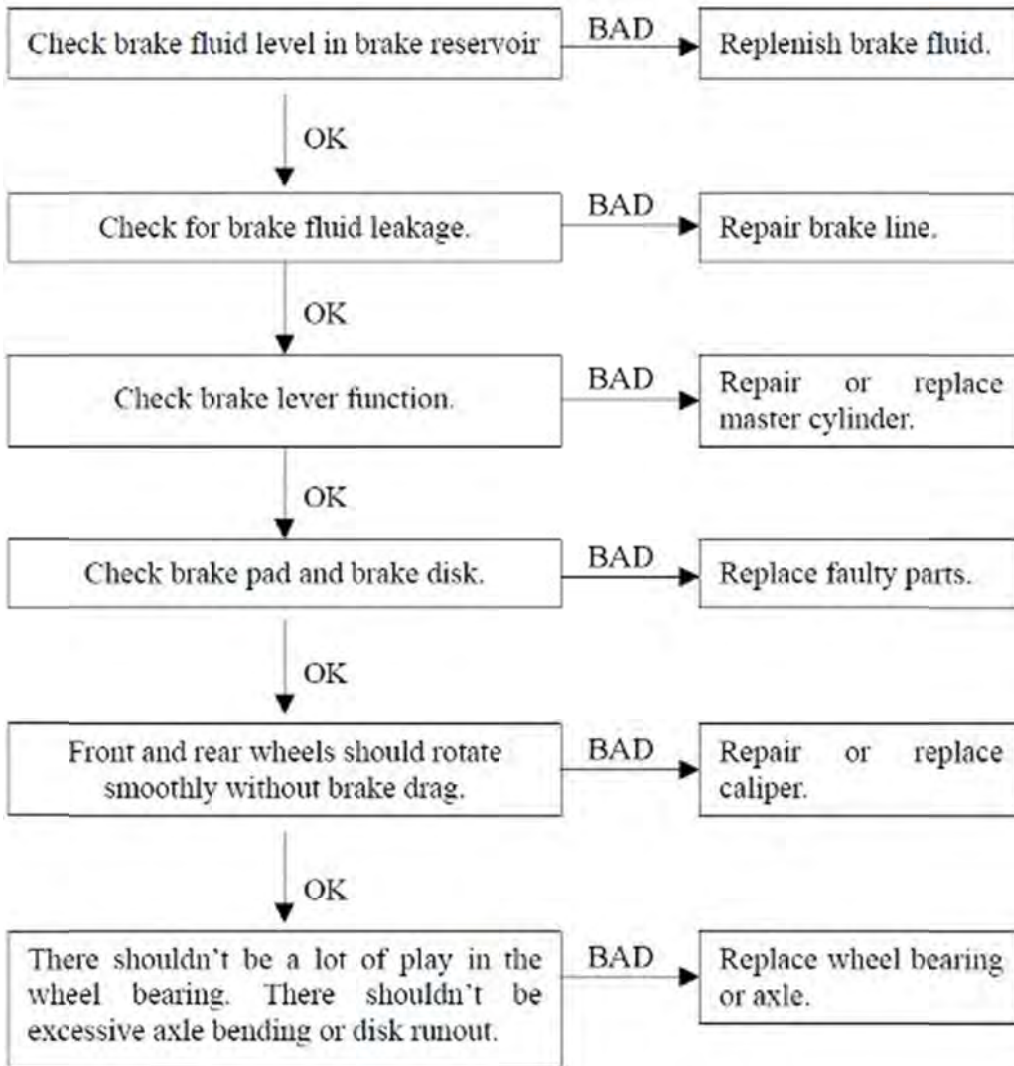

Pre-diagnosis Inspection 2

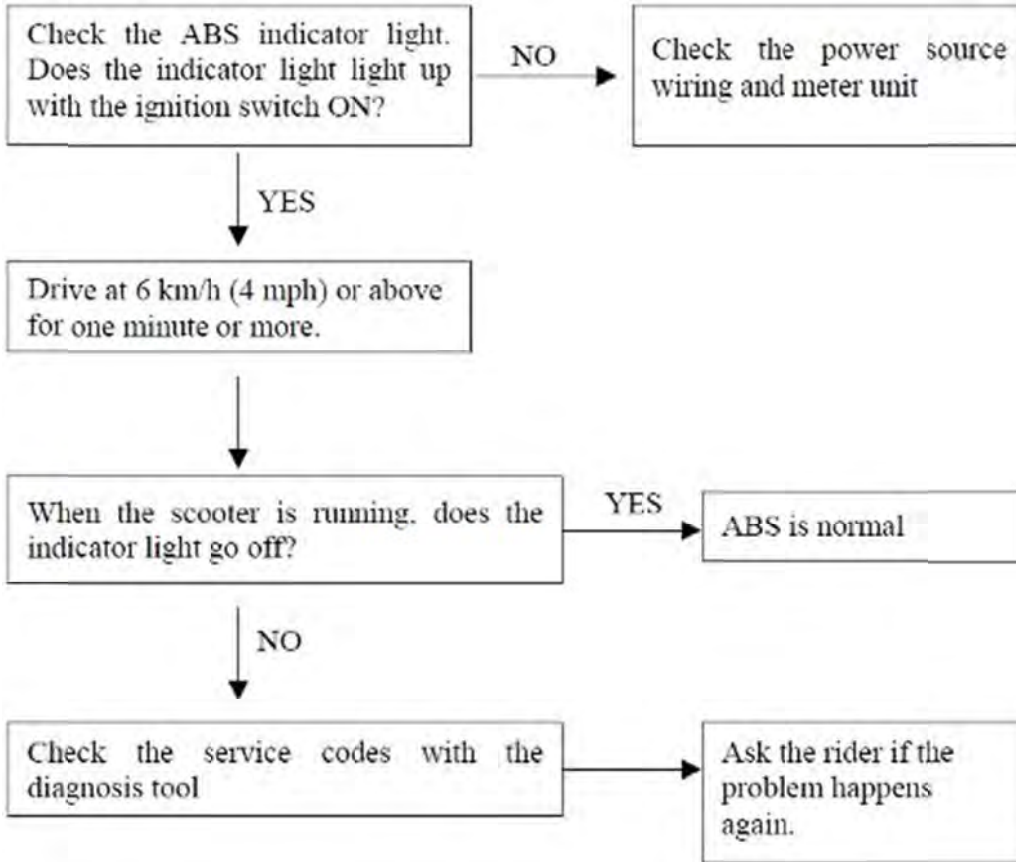

Meter Instruments (For models equipped with ABS)

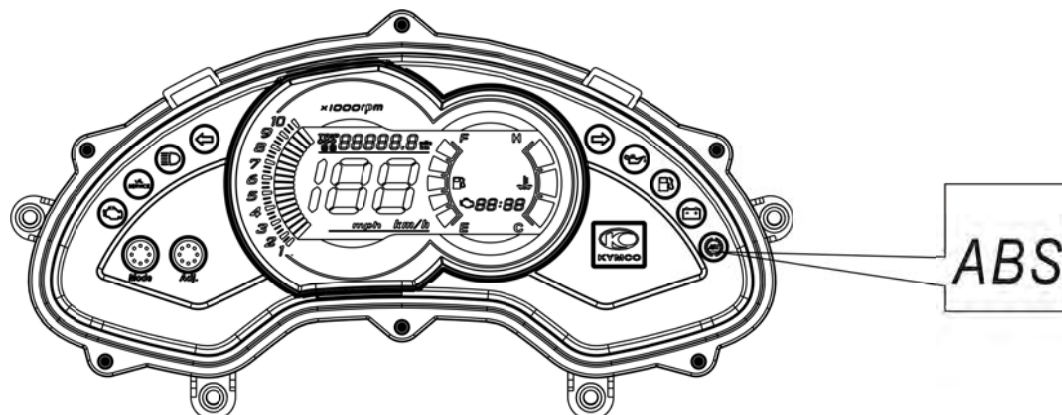

The ABS indicator light is on the right side of the meter. This light will come on when the ignition switch is turned on and goes off shortly after the vehicle starts moving it stays off as long as the system is ok.

If something is wrong with the ABS the indicator comes on and remains on. When the indicator light is on the ABS doesn't function, but the conventional brake system will still work normally.

ABS Indicator Light Is Unlit (When The Ignition Switch Turned To ON)

1st step test.

Check the terminal voltage between the Pink lead terminal of the meter connector and ground. Turn the ignition switch ON.

Terminal Voltage Standard: About 8V

If the terminal voltage correct, replace the meter assembly.

9. Brakes

2nd step test.

Disconnect the meter connector.

Check for continuity between the Pink lead terminal of the main harness side connector and ground.

If there is the continuity in the lead, replace or repair the main harness.

3rd step test.

Disconnect the ABS hydraulic unit connector.

Check for continuity between the Pink lead terminal of the main harness side connector and Pink lead terminal of the main harness side connector.

If there is the continuity in the lead, replace the ABS hydraulic unit.

If there is not the continuity in the lead, replace or repair the main harness.

ABS Indicator Light lights (When the scooter is running, - no service code)

1st step test.

Disconnect the ABS hydraulic unit connector and meter connector.

Check for continuity between the Pink lead terminal of the main harness side connector and Pink lead terminal of the main harness side connector.

If there is the continuity in the lead, replace the ABS hydraulic unit.

If there is not the continuity in the lead, replace or repair the main harness.

Solenoid Valve Inspection (Service Code 13,14,17,18)

1st step test.

Recheck the service code indication: erase the service code, perform the pre-diagnosis inspection 1 and 2. and retrieve the service code.

If the ABS indicator light lit, faulty solenoid valve in the ABS hydraulic unit. Replace the ABS hydraulic unit.

If the ABS indicator light unlit. ABS system is normal.

ABS solenoid valve relay inspection (service code 19)

1st step test.

Check the ABS solenoid valve relay fuse (40A).

Front, Rear Wheel Rotation Difference Abnormal (service code 25)

1st step test.

Check the following and correct the faulty part.

1. Incorrect the tire pressure
2. Tire not recommended for the scooter were installed (incorrect tire size).
3. Deformation of the wheel or tire.
4. Sensor rotor for missing teeth and clogging with foreign matter.

If the all parts are correct move on to the 2nd step.

2nd step test.

Recheck the service code indication: erase the service code, perform the pre-diagnosis inspection 1 and 2, and retrieve the service code.

If the ABS indicator light lit, faulty ECU in the ABS hydraulic unit. Replace the ABS hydraulic unit.

If the ABS indicator light unlit. ABS system is normal.

ABS Motor Relay Inspection (service code 35)

1st step test.

Check the ABS motor relay fuse (40A).

Front Wheel Rotation Sensor Signal Abnormal (service code 42)

1st step test.

Measure the clearance between the front wheel rotation sensor and sensor rotor.

Standard: 1 mm (0.04 in.)

If the measurement is over standard, check each part for deformation and looseness and correct accordingly. Recheck the clearance.

Check that there is iron or other magnetic deposits between the sensor and sensor rotor, and the sensor rotor slots for obstructions.

Check the installation condition of the sensor for looseness.

Check the sensor and sensor rotor tip for deformation or damage (example chipped sensor rotor teeth).

Front Wheel Rotation Sensor Wiring Inspection (service code 43)

1st step test.

Disconnect the ABS hydraulic unit connector and front wheel sensor connector.

Short the white/brown and red-green lead terminals of the main harness side connector with a jumper lead, and check for continuity between the white/brown and red green lead terminals of the main harness side connector.

If there is not the continuity in the lead, replace the rear wheel rotation sensor.

Rear Wheel Rotation Sensor Wiring Inspection (service code 44)

1st step test.

Measure the clearance between the rear wheel rotation sensor and sensor rotor.

Standard: 1 mm (0.04 in.)

If the measurement is over standard, check each part for deformation and looseness and correct accordingly. Recheck the clearance.

Check that there is iron or other magnetic deposits between the sensor and sensor rotor, and the sensor rotor slots for obstructions.

Check the installation condition of the sensor for looseness.

Check the sensor and sensor rotor tip for deformation or damage (example chipped sensor rotor teeth).

Rear Wheel Rotation Sensor Wiring Inspection (service code 45)

1st step test.

Disconnect the ABS hydraulic unit connector and rear wheel sensor connector.

Short the light-blue/brown and black/red lead terminals of the main harness side connector with a jumper lead, and check for continuity between the light-blue brown and black/red lead terminals of the main harness side connector.

If there is not the continuity in the lead, replace the rear wheel rotation sensor.

Power Supply Voltage Abnormal (under-voltage) (service code 52)

1st step test.

Disconnect the ABS diagnosis connector and ABS hydraulic unit connector.

Check for continuity for the black lead terminal of the main harness side connector.

9. Brakes

2nd step test.

Connect the ABS diagnosis connector and ABS hydraulic unit connector.

Check the battery terminal voltage, connect the diagnosis tool to the ABS diagnosis connector.

Turn the ignition switch ON.

Battery terminal voltage
Standard: 9.6V or more

3rd step test.

Inspect the following parts.

Battery, ignition switch, main harness and main fuse 10A.

4th step test.

Recheck the service code indication: erase the service code, perform the pre-diagnosis inspection 1 and 2, and retrieve the service code.

If the ABS indicator light lit, faulty ECU in the ABS hydraulic unit. Replace the ABS hydraulic unit.

If the ABS indicator light unlit, ABS system is normal.

Power Supply Voltage Abnormal (over-voltage) (service code 53)

1st step test.

Disconnect the ABS diagnosis connector and ABS hydraulic unit connector.

Check for continuity for the black lead terminal of the main harness side connector.

2nd step test.

Connect the ABS diagnosis connector and ABS hydraulic unit connector.

Check the battery terminal voltage, connect the diagnosis tool to the ABS

9. Brakes

diagnosis connector.

Turn the ignition switch ON.

Battery terminal voltage
Standard: 16.6V or less

3rd step test.

Inspect the following parts.

Battery, ignition switch, main harness and main fuse 10A

4th step test.

Recheck the service code indication; erase the service code, perform the pre-diagnosis inspection 1 and 2, and retrieve the service code.

If the ABS indicator light lit, faulty ECU in the ABS hydraulic unit. Replace the ABS hydraulic unit.

If the ABS indicator light unlit. ABS system is normal.

ECU Inspection (service code 55)

1st step test.

Recheck the service code indication; erase the service code, perform the pre-diagnosis inspection 1 and 2, and retrieve the service code.

If the ABS indicator light lit. faulty ECU in the ABS hydraulic unit. Replace the ABS hydraulic unit.

If the ABS indicator light unlit, ABS system is normal.

ABS Diagnostic Tool



Connect the diagnostic tool and set the ECU to the ABS. See the [Diagnostic Tool](#) topic for more information.



Check and clear the ABS DTCs in the same manner as the fuel injection DTCs.

9. Brakes

Bosch ABS8m DTC LIST		
Code NO (Diagnostic Tool 3620A- LEB2-E00)	DTC (PDA)	description
01	5013	Rear Inlet Valve malfunction (EV)
02	5014	Rear Outlet Valve malfunction (AV)
03	5017	Front Inlet Valve malfunction (EV)
04	5018	Front Outlet Valve malfunction (AV)
05	5019	Valve Relay malfunction (Failsafe relay)
06	5025	Deviation between Wheel speeds (WSS_GENERIC)
07	5035	Pump Motor Malfunction
08	5042	Front wheel speed sensor malfunction-Plausibility
09	5043	Front wheel speed sensor Disconnection/gnd Short/Battery Voltage Short
10	5044	Rear wheel speed sensor malfunction - Plausibility
11	5045	Rear wheel speed sensor Disconnection/gnd Short/Battery Voltage Short
12	5052	Power Supply Malfunction (Under Voltage)
13	5053	Power Supply Malfunction (Over Voltage)
14	5055	ECU malfunction



When using the DATA Analyze feature of the diagnostic tool with the ABS system the front and rear wheel speed sensors should show speed when the wheels are rotated.

9. Brakes

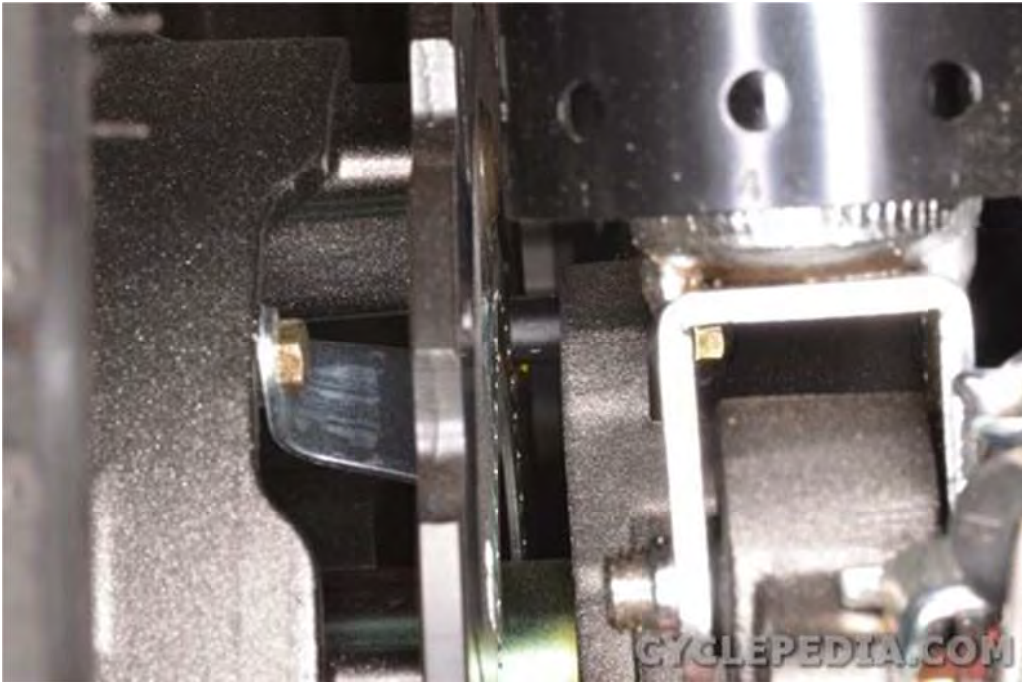

Inspect the wheel speed sensors, rotors, wires, and connectors if the speed doesn't show correctly.



Check the speed sensor to rotor clearance with a feeler gauge and make sure that it is 0.3 - 1.2 mm (0.0012 - 0.048 in).

ABS Unit



Note the markings on the ABS unit for the brake Front (F) and Rear (R) brake hose positions.



Do not attempt to disassemble the ABS unit.

If the ABS unit must be replaced the new unit should come filled with brake fluid. Install the new component immediately so that the brake fluid doesn't drain out.

Front Suspension

This chapter covers the location and servicing of the front fork components for the KYMCO K-XCT 300i.

- Front Fork Removal and Installation 10-2~10-7
- Fork Disassembly 10-8~10-19
- Fork Assembly 10-20~10-27

TROUBLESHOOTING

Soft front shock absorber

- Weak shock springs
- Insufficient damper oil

Front shock absorber noise

- Slider bending
- Loose fork fasteners
- Lack of lubrication

Front Fork Removal and Installation

SAFETY FIRST: Protective gloves and eyewear are recommended at this point.

Removal



Remove the front wheel speed sensor mounting bolt with an 8 mm socket.



Remove the front wheel speed sensor from the bottom of the right fork leg.



10. Front Suspension > Front Fork Removal



Remove the speed sensor wire and front brake hose guide mounting bolt with an 8 mm socket. Free the guide from the fork clamp.



Loosen the fork clamp pinch bolts with a 12 mm socket. The top bolts must be removed.



Slide the forks legs down and out of the fork clamp using a twisting motion.

Installation



Slide the fork legs up into fork clamp using a twisting motion.



Install the fork legs so that the upper fork clamp bolt hole lines up with the groove on the inner fork tube. Insert the fork clamp upper bolt.



Tighten the fork clamp bolts securely and evenly with a 12 mm socket.



Install the speed sensor wire and front brake hose guide to the fork clamp. Insert the guide mounting bolt and tighten it to specification with an 8 mm socket.

10. Front Suspension > Front Fork Removal

Item	Qty	Thread size (mm)	Torque	
			kgf-m	lb-ft
Speed sensor cable	1	6	1.0-1.4	7.23-10.13

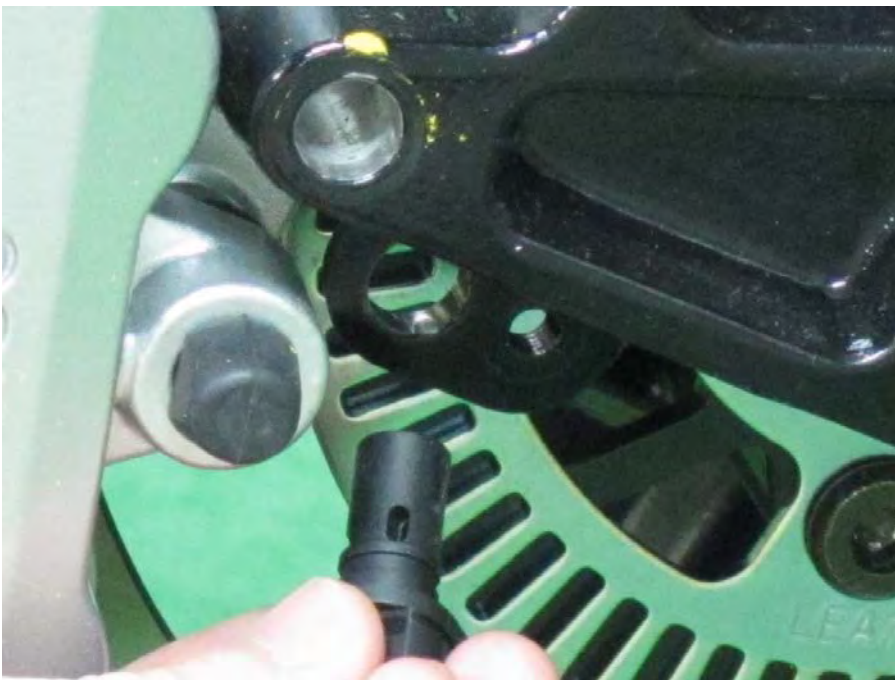

Fit the front wheel speed sensor into place on the right fork leg.
Insert the bolt and tighten it to specification with an 8 mm socket.

10. Front Suspension > Fork Disassembly

Fork Disassembly

SAFETY FIRST: Protective gloves and eyewear are recommended at this point.

Remove the front forks. See the Front Fork Removal and Installation topic for more information.



Clean the outside of the forks before disassembly and inspect them for any cracks, dents or other damage.



Slide off the fork protectors.

10. Front Suspension > Fork Disassembly



Remove the rubber fork cap.



Place the fork leg in a soft jawed vice.

10. Front Suspension > Fork Disassembly



Push down on the top plug and remove the snap ring.



Remove the top plug.

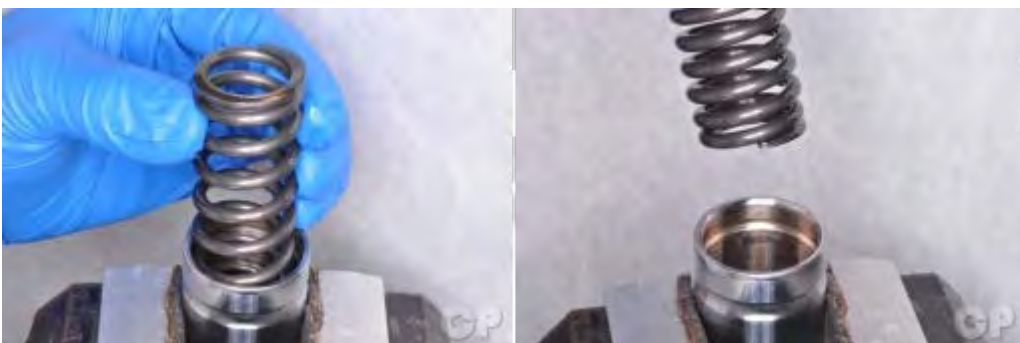

Lift out the fork spring.

10. Front Suspension > Fork Disassembly



Dump the fork oil into a suitable container. Pump the fork through its stroke several times to free as much oil as possible. Hold the fork inverted for several minutes to let the oil drain completely.



Use a flat blade screwdriver to pop the dust seal out of the fork slider. Take care to avoid scratching the fork tube.

10. Front Suspension > Fork Disassembly



Use a small flat blade screwdriver to pry out the fork oil seal stopper ring. Take care to avoid scratching the fork tube.



Slide off the stopper ring.

10. Front Suspension > Fork Disassembly



Place the axle holder of the outer fork tube in a soft jawed.



Insert an 8 mm Allen socket into the damper rod. Hold the damper rod and loosen the fork bottom bolt with an 8 mm Allen wrench.

10. Front Suspension > Fork Disassembly



Remove the fork bottom bolt from the bottom of the fork slider. Discard the sealing washer.



Separate the inner and outer fork tubes by pulling them apart using a slide hammer motion.



Remove the oil lock piece. The oil lock piece may come out with the damper rod in the inner fork tube or it may be left in the slider.

10. Front Suspension > Fork Disassembly



Remove the damper rod and rebound spring.



Inspect the oil seal and the bushing in the fork slider.

10. Front Suspension > Fork Disassembly



Place a rag across the top of the fork slider and pry our the oil seal as shown.



Remove the oil seal and spacer from the fork slider.

10. Front Suspension > Fork Disassembly

Inspection



Inspect the top plug O-ring O-ring and replace it if needed.



Insert the slider bushing and replace it as needed.

10. Front Suspension > Fork Disassembly

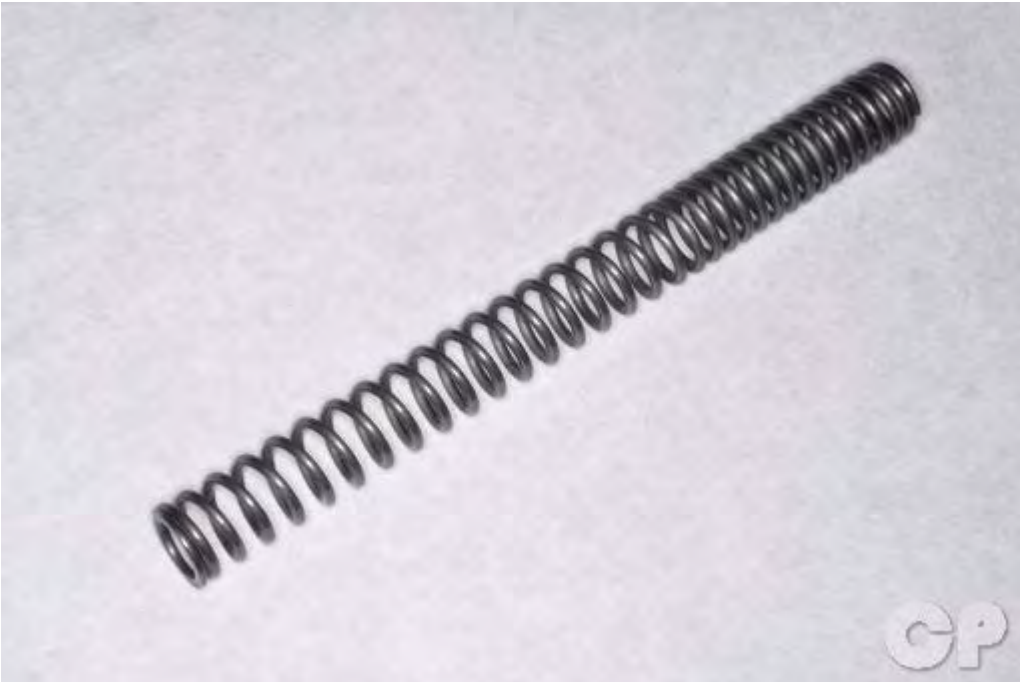

Inspect the fork springs for signs of fatigue. Replace the fork springs if they vary dramatically in length.



Inspect the damper rod and seal. Replace the components as needed.

10. Front Suspension > Fork Disassembly

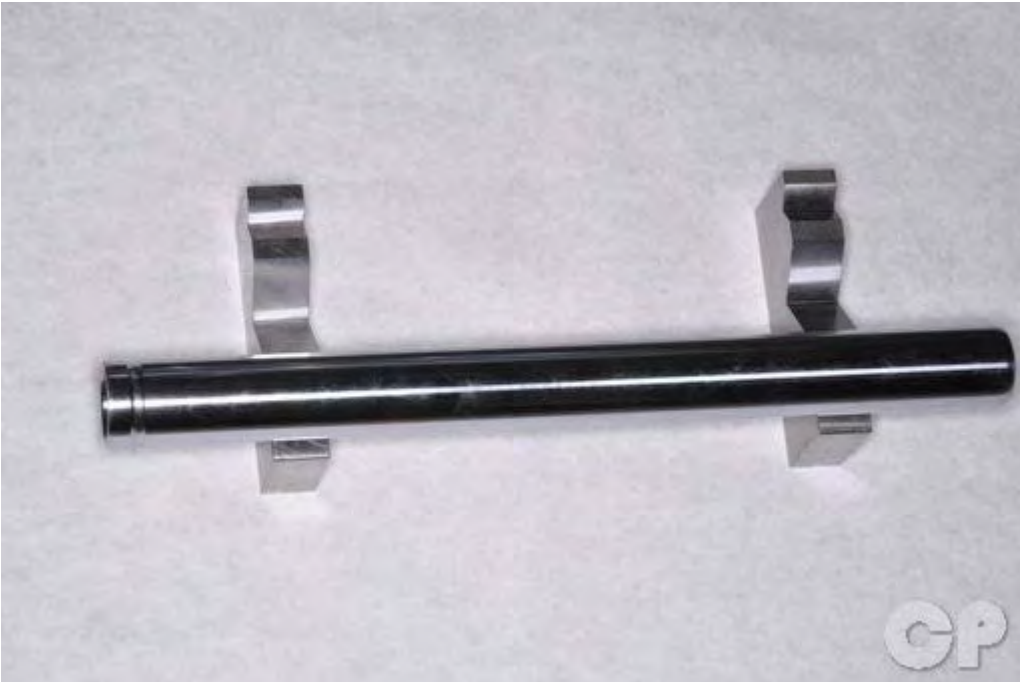

Inspect the inner fork tube for bends and damage. Replace it as needed.

For assembly see the Fork Assembly topic.

Fork Assembly

SAFETY FIRST: Protective gloves and eyewear are recommended at this point.

Clean all of the fork components with aerosol brake cleaner and a lint free cloth. Coat the bushing and seals with fork oil before installation.



Drive the fork slider bushing into the slider with a suitable driver with the same outside diameter as the bushing.



Insert the damper rod with rebound spring into the inner fork tube. Place the fork oil lock piece on the end of the damper rod.

Slide the dust seal, oil seal stopper ring and oil seal onto the bottom of the inner fork tube.

10. Front Suspension > Fork Assembly



Place the spacer into the fork slider.



Insert the inner fork tube into the inner fork tube.

10. Front Suspension > Fork Assembly



Place a new sealing washer on the fork bottom bolt. Insert the fork bottom bolt into the bottom the fork slider and thread it into the damper rod.



Place the axle holder of the outer fork tube in a soft jawed.

10. Front Suspension > Fork Assembly



Insert an 8 mm Allen socket into the damper rod. Hold the damper rod and tighten the fork bottom bolt securely with an 8 mm Allen wrench.



Drive in the fork oil seal with the fork seal driver.

10. Front Suspension > Fork Assembly



Insert the stopper ring into its groove.



Install the dust seal securely into the outer fork tube.

10. Front Suspension > Fork Assembly

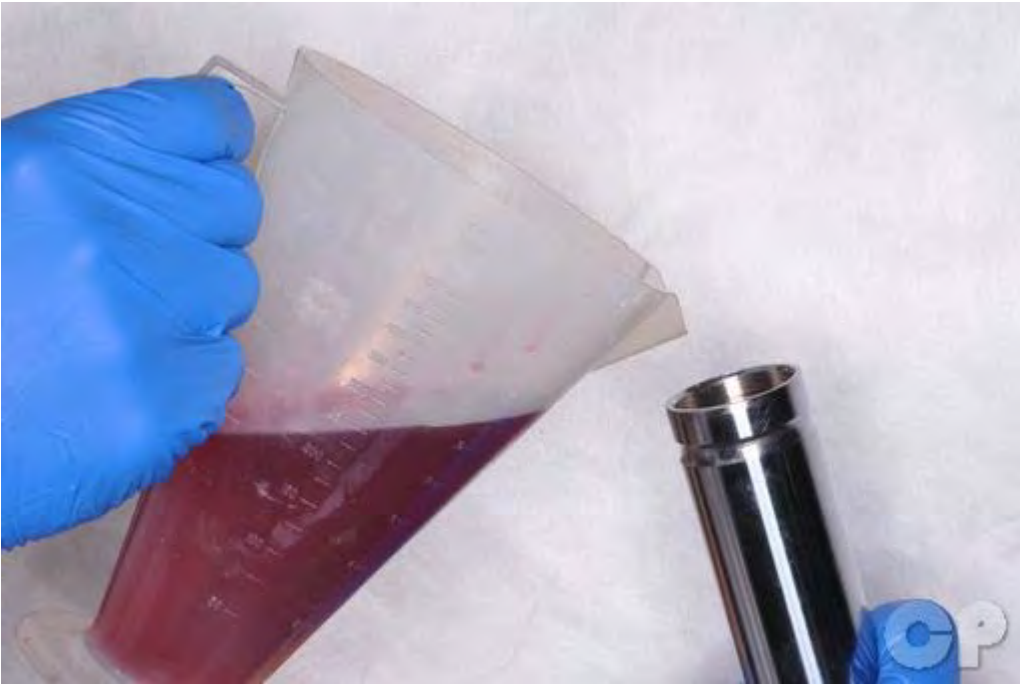

Compress the fork tube all the way. Fill the fork tube with the specified quantity of fork oil 185 cc or 6.26 US oz. Use fork oil type SS#8 (10W).

Pump the fork slowly through its stroke several times to release any trapped air.

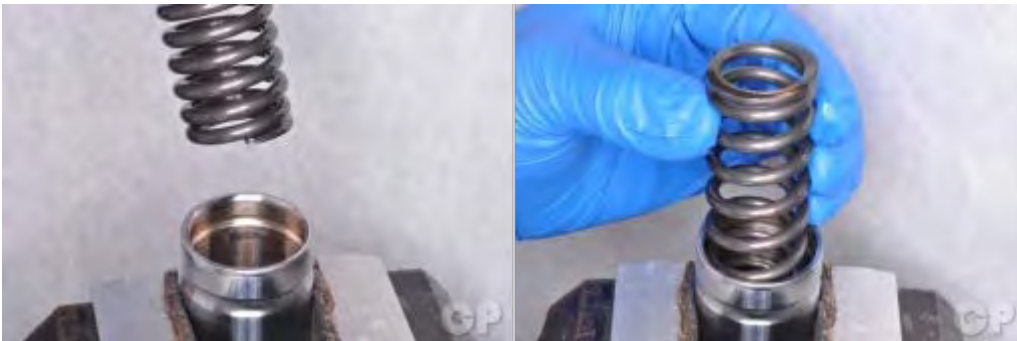

Fully extend the fork and insert the fork spring with its tightly coiled end facing down towards the axle.

10. Front Suspension > Fork Assembly



Lubricate the top plug O-ring with fresh fork oil and insert the plug into the top of the inner fork tube as shown.



Push the top plug down against the spring and install the stopper ring into its groove. Release the pressure on the top plug and make sure the plug seats against the ring.

10. Front Suspension > Fork Assembly



Install the rubber fork cap.



Fit the fork protectors into place so that they face forward.

Install the front fork. See the Front Fork Removal and Installation topic for more information.

11. Rear Suspension

Rear Suspension

This chapter provides information on the rear suspension components of the KYMCO K-XCT 300i.

- Shock Absorbers 11-2~11-9
- Swingarm 11-10~11-14

TROUBLESHOOTING

Soft rear shock absorber

- Weak shock absorber spring
- Damper oil leaks

Shock Absorbers

SAFETY FIRST: Protective gloves and eyewear are recommended at this point.

Pre-Load Setting



Each shock absorber on the scooter has 5 spring preload adjustment positions for different load or riding conditions.

Position 1 is for light loads and smooth road conditions. Position 3 to 5 increase spring preload for stiffer rear suspension and can be used when the scooters heavily loaded. Be certain to adjust both shock absorbers to the same spring preload positions.

Use a pin spanner to adjust the rear shock spring preload. The shock absorbers are adjustable for pre-load. There are 5 settings. Position 1 is the softest and 5 is the stiffest.

Caution: Always adjust the shock absorber pre-load position in sequence (1-2-3-4-5 or 5-4-3-2-1). Attempting to adjust directly from 1 to 5 or 5 to 1 may damage the shock absorber.

(Pre-Load Standard Setting: Position 3)

11. Rear Suspension > Shock Absorbers

Removal

Place the vehicle on its center stand.

Remove the body cover to access the upper shock absorber mounts.
See the Body Cover topic for more information.



Remove the two rear shock mounting bolt with a 12 mm socket.

11. Rear Suspension > Shock Absorbers

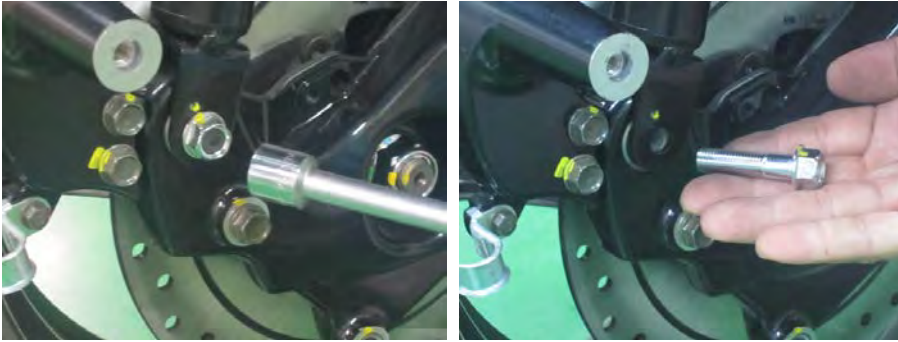

Remove the right side rear shock mounting bolt with a 14 mm socket.



Free the lower mount of the rear shock.

11. Rear Suspension > Shock Absorbers



Remove the upper shock absorber mounting bolt with a 12 mm socket.
Free the shock absorber from the frame.

11. Rear Suspension > Shock Absorbers

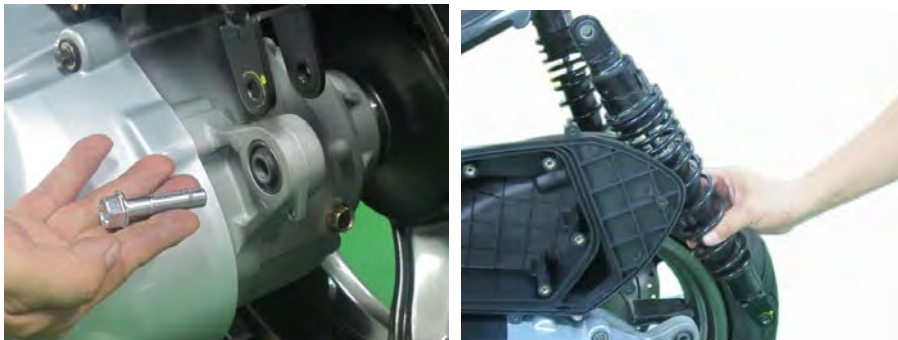
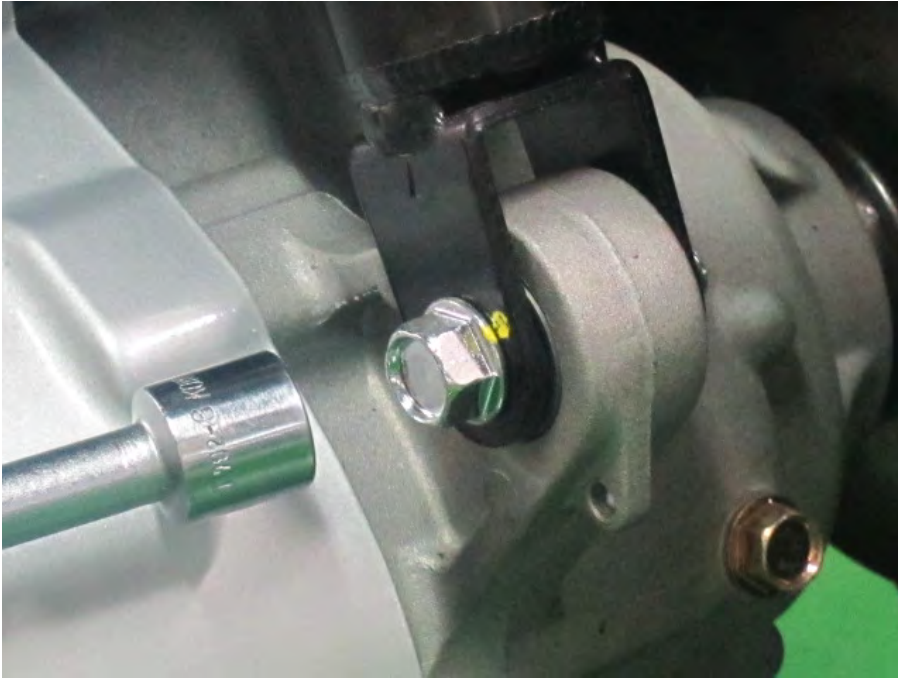

Remove the left shock absorber in the same manner as the right.

Inspect the shock absorbers for wear and damage. Replace the shock absorbers as needed.

Check over the shock absorber for damage and oil leaks. Replace the shock absorber if needed. Do not attempt to disassemble the shock absorber.

11. Rear Suspension > Shock Absorbers

Installation



Fit the shock absorber into place. Make sure the preload arrow indicator faces out from the lower mount.



Install the upper shock absorber mounting bolt and torque it to specification with a 12 mm socket.

11. Rear Suspension > Shock Absorbers

Item	Torque	
	kgf-m	lb-ft
Shock absorber mounting bolt	4	28.93

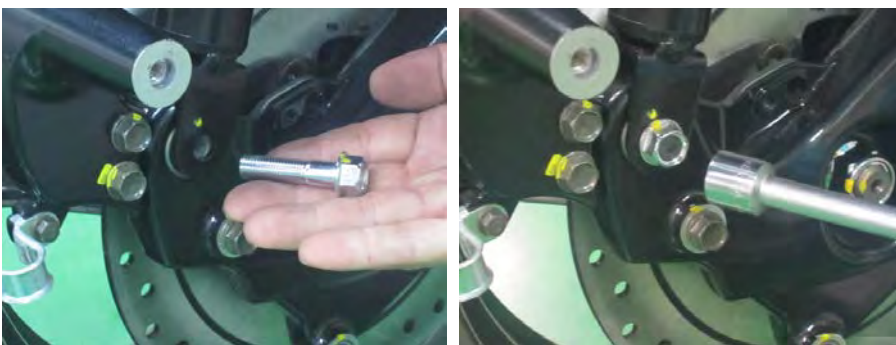

Install the lower shock absorber mounting bolt and torque it to specification with a 12 mm socket.

Item	Torque	
	kgf-m	lb-ft
Shock absorber mounting bolt	4	28.93

11. Rear Suspension > Shock Absorbers

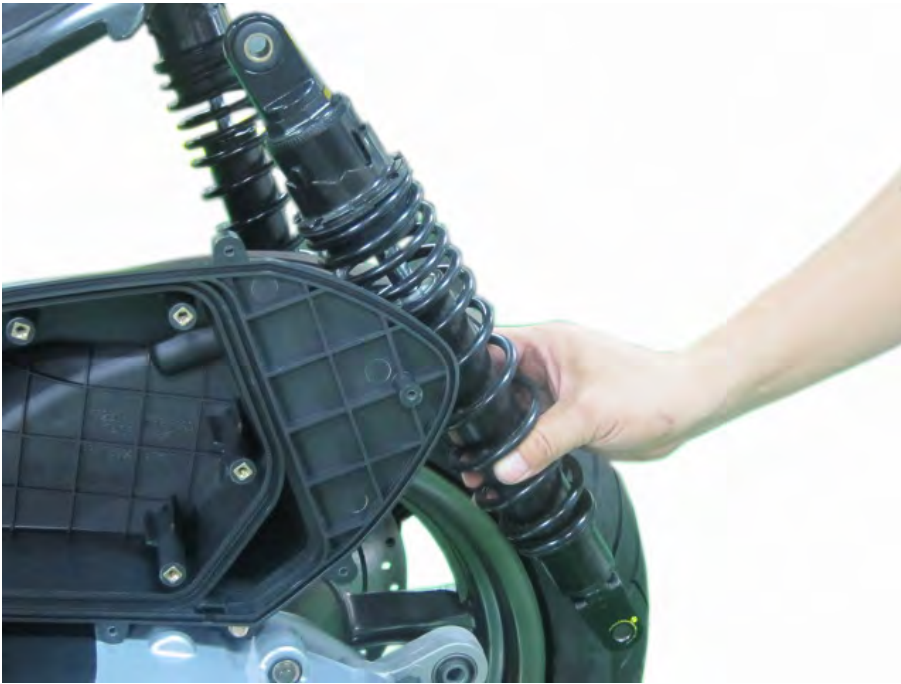

Install the other shock absorber in the same manner.

Rear Fork

SAFETY FIRST: Protective gloves and eyewear are recommended at this point.

Removal

Place the vehicle on its center stand.



Remove the right side rear shock mounting bolt with a 14 mm socket.

11. Rear Suspension > Swingarm



Hold the rear brake to keep the rear wheel from turning. Remove the rear axle nut with a 24 mm socket.



Remove the two rear fork bolts with a 14 mm socket.



Slide the rear fork out and remove it from the right side of the vehicle.

Inspect the rear fork for damage and replace it as needed.

Installation



Fit the rear fork into place.



Install the two rear fork mounting bolts and tighten them securely with a 14 mm socket.

11. Rear Suspension > Swingarm



Install the rear axle nut and tighten it to specification with a 24 mm socket.

Item	Qty	Thread size (mm)	Torque		Remarks
			kgf-m	lb-ft	
Rear axle nut	1	16	11-13	79.56-94.03	U-nut

11. Rear Suspension > Swingarm



Install the lower shock absorber mounting bolt and torque it to specification with a 12 mm socket.

Item	Torque	
	kgf-m	lb-ft
Shock absorber mounting bolt	4	28.93

Wheels

This chapter covers the location and servicing of the wheels for the KYMCO K-XCT 300i.

- Front Wheel 12-2~12-7
- Rear Wheel 12-8~12-17
- Wheel Inspection..... 12-18
- Bearing Replacement..... 12-19~12-22

Troubleshooting

Front wheel wobbling

- Bent rim
- Loose front axle
- Bent spoke plate
- Faulty tire
- Improperly tightened axle nut

Rear wheel wobbling

- Bent rim
- Faulty tire
- Axle not tightened properly

Rear wheel noise

- Worn rear wheel axle bearings
- Worn rear fork bearings
- Deformed rear fork

Front Wheel

SAFETY FIRST: Protective gloves and eyewear are recommended at this point.

Removal



Loosen the front axle pinch bolt with a 6 mm Allen.



Loosen the front axle with an 8 mm socket.

12. Weels > Front Wheel



Lift the front end of the vehicle with a suitable stand or jack so that the front wheel comes off of the ground.



Support the front wheel and slide the front axle out from the left side.

12. Weels > Front Wheel



Guide the front wheel out from the fork legs and the brake disc out from between the pads. Do not squeeze the brake lever while the disc is not present between the pads.



Remove the collars from each side of the wheel. Inspect the bearing seals and the O-rings seals on the collars. Replace the seals if they are in poor condition.

Inspect the wheel bearings by turning them in the hub. If the bearings have play in them or are rough replace all the bearings for that wheel. See the Bearing Replacement topic for more information.

To remove the wheel speed sensor rotor loosen the three bolts with an

12. Weels > Front Wheel

Installation



Apply grease to the lips of the dust seals and collar O-rings. Insert the collars into the hub as shown.



Make sure the tire direction of rotation marker is correct. Slide the front wheel into the fork. Fit the brake disc between the brake pads in the front caliper.



Apply a light coat of grease to the front axle. Insert the axle from the left side.

12. Weels > Front Wheel

Set the front wheel on the ground. Pump the front suspension up and down several times to seat the front axle



Torque the axle to specification with an 8 mm Allen.

Item	Qty	size (mm)	Torque	
			Kgf-m	lb-ft
Front axle	1	14	1.5-2.5	10.84-18.08

12. Weels > Front Wheel

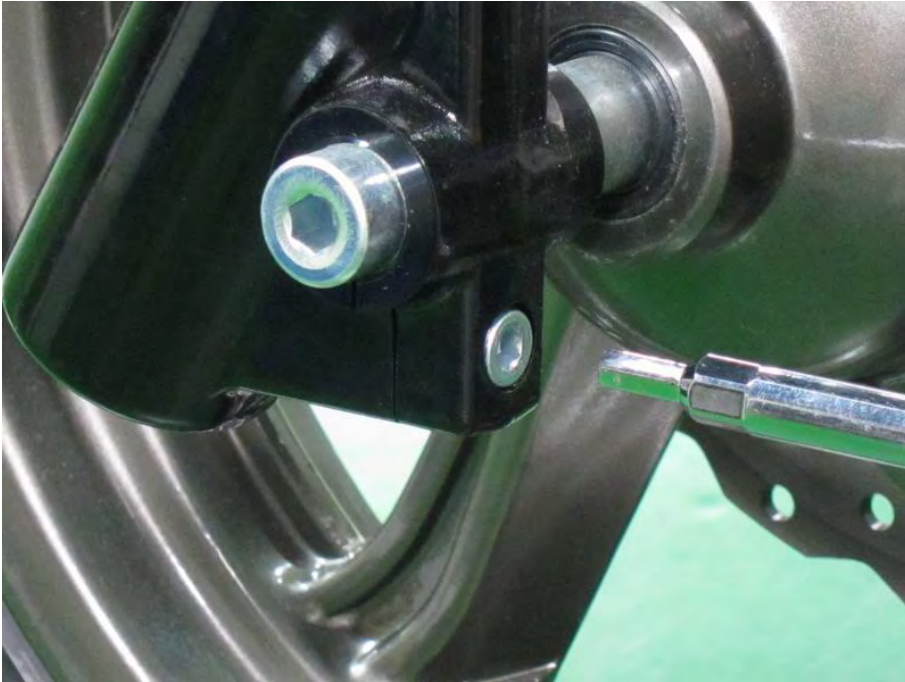

Tighten the front axle pinch bolt securely with a 6 mm Allen.

Pump the front brake lever to establish pressure and to seat the pads against the disc. If the Brakes do not pump up correctly check the brake fluid.

Rear Wheel

SAFETY FIRST: Protective gloves and eyewear are recommended at this point.

- When performing the services stated in this section, the engine and exhaust muffler must be cold to avoid scalding.
- During servicing, keep oil or grease off the brake pads and brake disk.

Removal

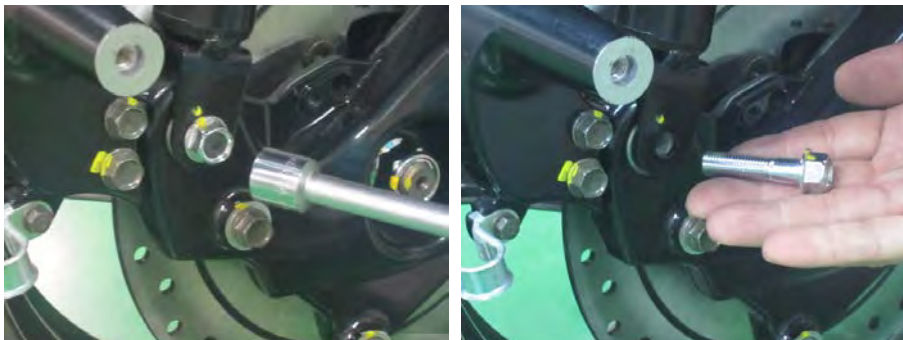

Remove the right side rear shock mounting bolt with a 14 mm socket.

12. Wheels > Rear Wheel



Move the rear shock out of the way.



Hold the rear brake to keep the rear wheel from turning.
Remove the rear axle nut with a 24 mm socket.



Remove the two rear fork bolts with a 14 mm socket.

12. Wheels > Rear Wheel



Slide the rear fork out and remove it from the right side of the vehicle.



Remove the rear axle collar from the right side of the rear axle.

12. Wheels > Rear Wheel



To remove the rear wheel support the right rear shock absorber so that it is out of the way or remove it.



Remove the upper shock absorber mounting bolt with a 12 mm socket. Free the right shock absorber from the frame.



Slide the rear wheel to the right and off of the rear axle. Inspect the wheel bearings by turning them with a finger. If the bearings have play in them or are rough replace all the bearings for that wheel.

12. Wheels > Rear Wheel

Installation



Line up the splines on the rear wheel with those of the rear axle. Slide the rear wheel on to the axle so that the brake disc sits on the right side.



Install the right shock absorber if it was removed. Install the upper mounting bolt and tighten it to specification with a 12 mm socket.

Item	Torque	
	kgf-m	lb-ft
Shock absorber mounting bolt	4	28.93

12. Wheels > Rear Wheel



Slide on the rear axle collar.



Fit the rear fork into place.

12. Wheels > Rear Wheel



Install the two rear fork mounting bolts and tighten them securely with a 14 mm socket.



12. Wheels > Rear Wheel



Install the rear axle nut and tighten it to specification with a 24 mm socket.

Item	Qty	Thread size (mm)	Torque		Remarks
			kgf-m	lb-ft	
Rear axle nut	1	16	11-13	79.56-94.03	U-nut



Fit the shock absorber into place. Make sure the preload arrow indicator faces out from the lower mount.

12. Wheels > Rear Wheel



Install the upper shock absorber mounting bolt and torque it to specification with a 12 mm socket.

Item	Torque	
	kgf-m	lb-ft
Shock absorber mounting bolt	4	28.93



12. Wheels > Rear Wheel



Install the lower shock absorber mounting bolt and torque it to specification with a 12 mm socket.

Item	Torque	
	kgf-m	lb-ft
Shock absorber mounting bolt	4	28.93

Wheel Inspection

SAFETY FIRST: Protective gloves and eyewear are recommended at this point.

Turn the inner race of each bearing with your finger to see if they turn smoothly and quietly. Also check if the outer race fits tightly in the hub. Replace the bearings if the races do not turn smoothly, quietly, or if they fit loosely in the hub.



Place the wheel on a truing stand and use a dial indicator to check if the rim is out of true. The specifications for the front and rear wheels are the same. Check for lateral wobble. The service limit is 2.0 mm (0.08 in) or less.

Wheel Bearing Replacement

SAFETY FIRST: Protective gloves and eyewear are recommended at this point.

Replace bearings as a set, and do not reuse old bearings.
Place the new bearings in the freezer about an hour before you plan to install them.
Do not let the wheel rest on its brake disc.

Front Wheel



Remove the dust seal from the right side of the front wheel using a seal pick or large flat blade screwdriver. Discard the dust seal, it should be replaced by a new item.

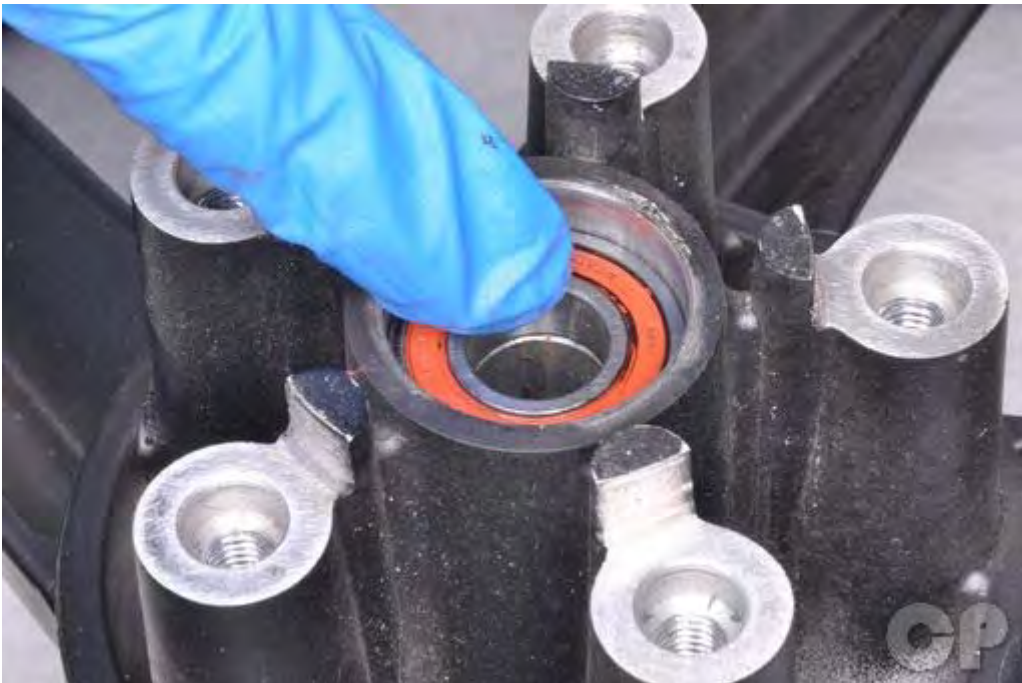

Inspect the wheel bearings by turning them in the hub. If the bearings have excessive play in them or are rough replace all the bearings for that wheel.

12. Wheels > Bearing Replacement



Remove one of the bearings with a bearing puller.

Special Tools- Bearing Puller: A120E00037



Remove the distance collar.



Repeat the procedure and remove the other bearing and seal. The seal should be replaced with a new item.

12. Wheels > Bearing Replacement



Heat the bearing area of the wheel with a heat gun, take the bearing out of the freezer and install it. You can use a bearing installer tool or a socket with the same outside diameter as the bearing. Make sure the bearing is fully seated and the marked side is facing out.

Special Tools-Bearing Installer: A120E00014



Insert the distance collar into the hub.

12. Wheels > Bearing Replacement



Drive in the other bearing. The bearing should fit against the distance collar. Do not continue to force the bearing in or the distance collar will begin to push the right bearing back out.



Apply grease to the lips of the dust seals. Drive in new dust seals.

Electrical Systems

This chapter covers the location and servicing of the electrical systems for the KYMCO K-XCT 300i.

- Battery 13-6~13-10
- Charging System..... 13-11
- Ignition System..... 13-12~13-16
- Starting System..... 13-17~13-21
- Starter Motor 13-22
- Fuses..... 13-23
- ECU Removal..... 13-24~13-27
- Self-Diagnosis 13-28~13-33
- Horn..... 13-34
- Lights..... 13-35~13-41
- Relays 13-42~13-46
- Switches..... 13-47~13-61
- Wiring Diagrams..... 13-62~13-64

CHARGING SYSTEM AND BATTERY

GENERAL INSTRUCTIONS

- The battery can be charged and discharged repeatedly. If a discharged battery is not used for a long time, its service life will be shortened. Generally, the capacity of a battery will decrease after it is used for 2~3 years. A capacity-decreased battery will resume its voltage after it is recharged but its voltage decreases suddenly and then increases when a load is added.
- When a battery is overcharged, some symptoms can be found. If there is a short circuit inside the battery, no voltage is produced on the battery terminals. If the rectifier won't operate, the voltage will become too high and shorten the battery service life.
- If a battery is not used for a long time, it will discharge by itself and should be recharged every 3 months.
- A new battery filled with electrolyte will generate voltage within a certain time and it should be recharged when the capacity is insufficient. Recharging a new battery will prolong its service life.
- Inspect the charging system according to the sequence specified in the Troubleshooting

13. Electrical Systems

- Do not disconnect and soon reconnect the power of any electrical equipment because the electronic parts in the regulator/rectifier will be damaged. Turn off the ignition switch before operation.
- It is not necessary to check the MF battery electrolyte or fill with distilled water.
- Check the load of the whole charging system.
- Do not quick charge the battery. Quick charging should only be done in an emergency.
- Remove the battery from the motorcycle for charging.
- When replacing the battery, do not use a traditional battery.
- When charging, check the voltage with an electric tester.

TROUBLESHOOTING

No power

- Dead battery
- Disconnected battery cable
- Fuse burned out
- Faulty ignition switch

Intermittent power

- Loose battery cable connection
- Loose charging system connection
- Loose connection or short circuit in the ignition system

Low power

- Weak battery
- Loose battery connection
- Charging system failure
- Faulty regulator/rectifier

Charging system failure

- Loose, broken or shorted wire or connector
- Faulty regulator/rectifier
- Faulty A.C. generator

13. Electrical Systems

IGNITION SYSTEM

GENERAL INSTRUCTIONS

- Some electrical components may be damaged if terminals or connectors are connected or disconnected while the ignition switch is “ON” and current is present.
- When servicing the ignition system, always follow the steps in the troubleshooting on page above.
- The ignition timing cannot be adjusted since the ignition control module is already adjusted in factory.
- The ignition control module or ECU maybe damaged if dropped or the connector is disconnected when the key is "ON", the excessive voltage may damage the ignition control module or ECU. Always turn off the ignition switch before servicing.
- A faulty ignition system is often related to poor connections. Check those connections before proceeding.
- Make sure the battery is adequately charged. Using the starter motor with weak battery results in a slower engine cranking speed as well as no spark at the spark plug.
- Use a spark plug of the correct heat range. Using spark plug with an incorrect heat range can damage the engine.

TROUBLESHOOTING

No peak voltage

- Short circuit in engine stop switch or ignition switch wire.
- Faulty engine stop switch or ignition switch.
- Loose or poorly connected ignition control module connectors.
- Open circuit or poor connection in ground wire of the ignition control module.
- Faulty crank position sensor.
- Faulty ignition control module.

Peak voltage is normal, but no spark jumps at the plug

- Faulty spark plug or leaking ignition coil secondary current.
- Faulty ignition coil.

13. Electrical Systems

Starting System

GENERAL INSTRUCTIONS

- The removal of starter motor can be accomplished with the engine installed.
- After the starter clutch is installed, be sure to add the engine oil and coolant and then bleed air from the cooling system.

TROUBLESHOOTING

Starter motor will not turn

- Fuse burned out
- Weak battery
- Faulty ignition switch
- Faulty starter clutch or gear
- Faulty front or rear stop switch
- Faulty starter relay
- Poorly connected, broken or shorted wire
- Faulty starter motor

Lack of power

- Weak battery
- Loosed wire or connection
- Foreign matter stuck in starter motor

Starter motor rotates but engine does not start

- Faulty starter pinion
- Starter motor rotates in reverse
- Weak battery

LIGHTS, SWITCHES, AND FUEL PUMP

GENERAL INSTRUCTIONS

- Note the following when replacing the halogen headlight bulb
 1. Wear clean gloves while replacing the bulb. Do not put finger prints on the headlight bulb, as they may create hot spots on the bulb and cause it to fail.
 2. If you touch the bulb with your bare hands, clean it with a cloth moistened with alcohol to prevent its early failure.
 3. Be sure to install the dust cover after replacing the bulb.
- Check the battery condition before performing any inspection that requires proper battery voltage.
- A continuity test can be made with the switches installed on the scooter.
- Route the wires and cables properly after servicing each component.

TROUBLESHOOTING

Lights do not come on when ignition switch is "ON"

- Burned bulb
- Faulty switch
- Poorly connected, broken or shorted wire

Temperature gauge does not register correctly

- Faulty temperature gauge
- Faulty thermosensor
- Broken or shorted wire between the temperature gauge and thermosensor

Fuel gauge does not work or shows wrong figures

- Faulty fuel gauge
- Faulty fuel unit
- Poorly connected wire between fuel gauge and fuel unit
- Fuse burned out

Battery

SAFETY FIRST: Protective gloves and eyewear are recommended at this point.

Warning: The battery electrolyte (sulfuric acid) is poisonous and may seriously damage the skin and eyes. Avoid contact with skin, eyes, or clothing. In case of contact, flush with water and get prompt medical attention.

Removal



Remove the battery cover screw. Remove the battery cover.

13. Electrical System > Battery



The battery is located under the seat.



Remove the negative battery cable bolt with a 10 mm socket or #3 Phillips screwdriver. Free the negative cable from the battery.



Remove the positive battery cable bolt with a 10 mm socket or #3 Phillips screwdriver. Free the positive cable from the battery.

13. Electrical System > Battery



Lift the battery out of the battery tray.

Testing

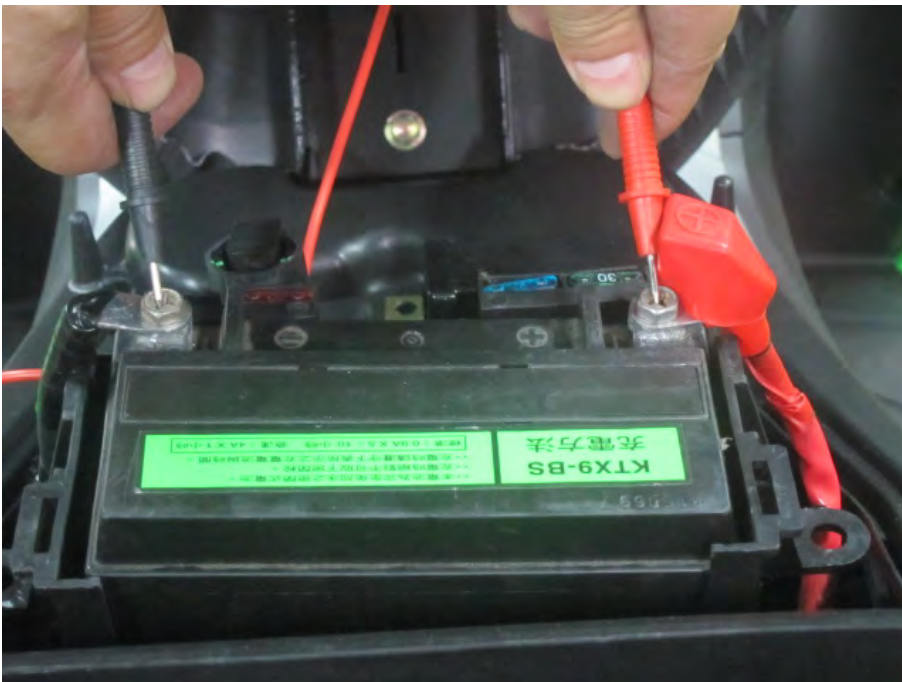

Check the battery voltage with a multi-meter. Place the positive probe onto the positive battery terminal and the negative probe to the negative battery terminal. If the battery reads under 12.3 V it is undercharged.

Battery Voltage (20°C/68°F)	
Fully Charged	13.0 - 13.2 V

13. Electrical System > Battery

Installation

Only install the specified battery



Fit the battery into the battery tray.



Connect the positive battery cable and install the bolt with a 10 mm socket or #3 Phillips screwdriver.



Connect the negative battery cable and install the bolt with a 10 mm socket or #3 Phillips screwdriver.

13. Electrical System > Battery



Install the battery cover. Install the four battery cover screws and tighten them securely.

Battery Charging

Charge the battery with a motorcycle specific battery charger at the specified rate. Connect the charger leads to their appropriate battery terminals. Keep open flames away from a charging battery.

Standard Charge	
1.2 Amps	5 - 10 Hours

Note: For battery charging, do not exceed the charging current and time specified on the battery. Using excessive current or extending the charging time may damage the battery.

Charging System

SAFETY FIRST: Protective gloves and eyewear are recommended at this point.

You will need a digital multimeter to inspect the charging system.

Charging Voltage Inspection

Remove the battery cover. See the Battery topic for more information.

Note: The battery should be fully charged prior to making charging system checks.

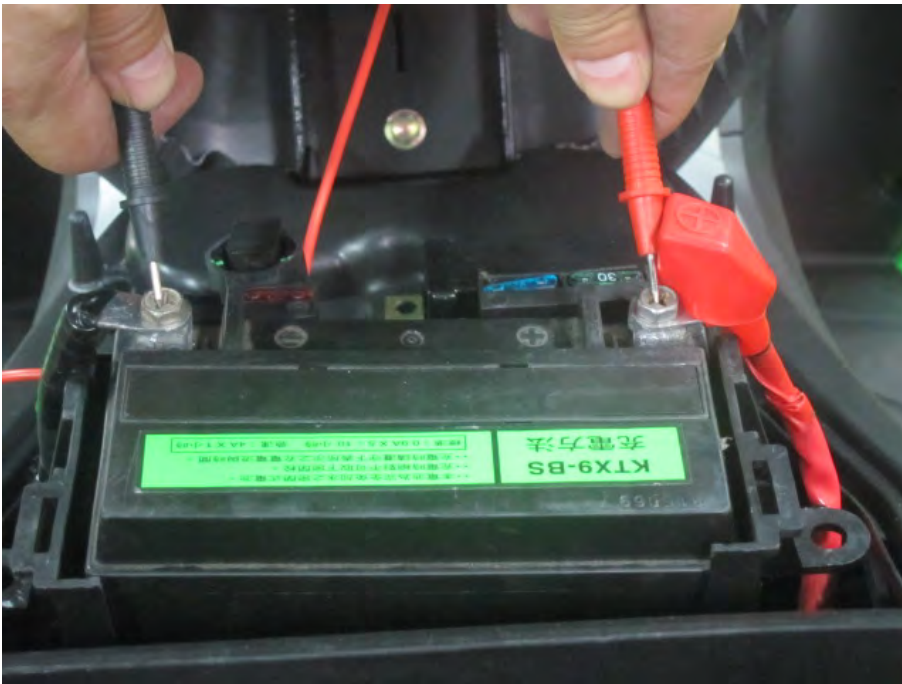

Start the engine and warm it up to the operating temperature; stop the engine. Connect the multimeter between the positive (+) and negative (-) terminals of the battery. To prevent short, make absolutely certain which are the positive (+) and negative (-) terminals or cable.

With the headlight on and turned to the high beam position, restart the engine. Measure the voltage on the multimeter when the engine runs at 5000 rpm.

Battery charging voltage@ 5000 rpm	14 ~ 15V
------------------------------------	----------

Ignition System

SAFETY FIRST: Protective gloves and eyewear are recommended at this point.

The ignition timing is set at the factory and is not adjustable. Perform the following checks. Before performing any tests make sure the electrical connections are not loose or corroded.

Spark Test

Check the spark plug to see if it is the correct type and gapped properly. If the spark plug is black and fouled, replace it.

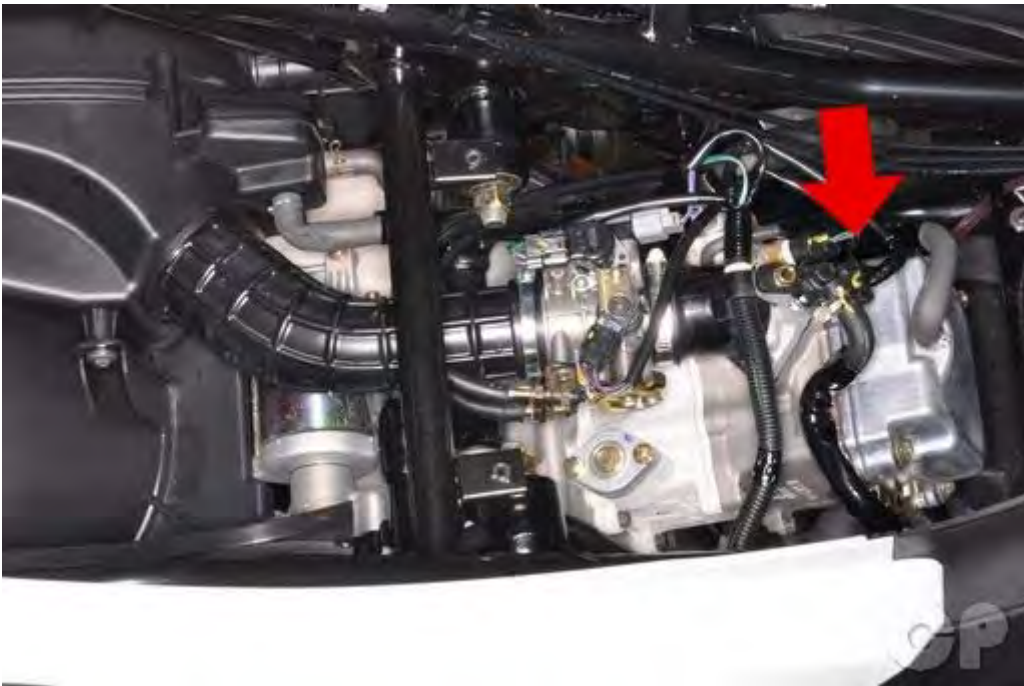

Leave the old spark plug installed. Connect known good spark plug to the coil and ground the plug to the cylinder head.

13. Electrical System > Ignition System

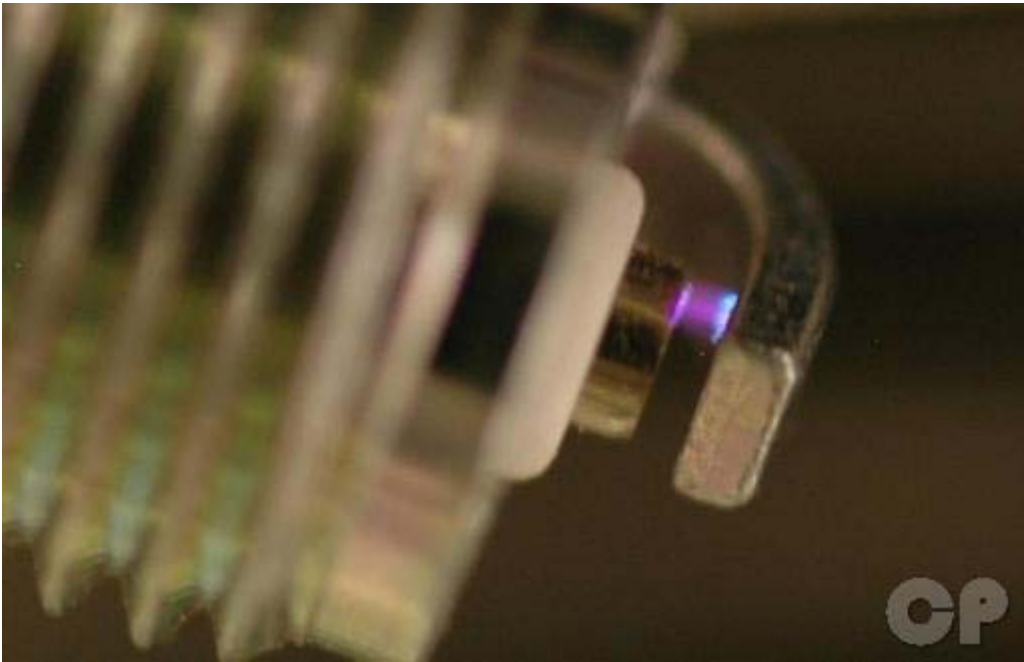

Turn the ignition switch to ON, lift the side stand, hold in one of the brake levers, and push the engine start button. The plug should spark.

Caution: Do not touch the spark plug or spark plug wire while cranking or running the engine as this can result in a severe shock.

Ignition Coil

Removal



13. Electrical System > Ignition System

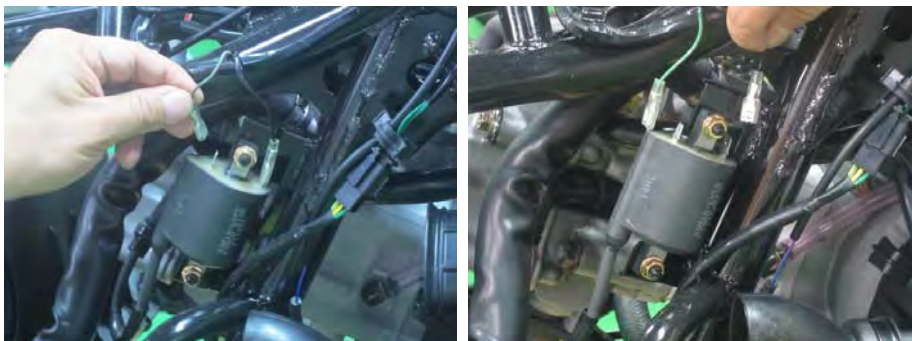

Remove the two ignition coil leads.



Remove the two ignition coil mounting bolts with an 8 mm socket.

Remove the ignition coil.

13. Electrical System > Ignition System

Ignition Coil Resistance

Primary

Set the multimeter to read ohms of resistance (Ω).

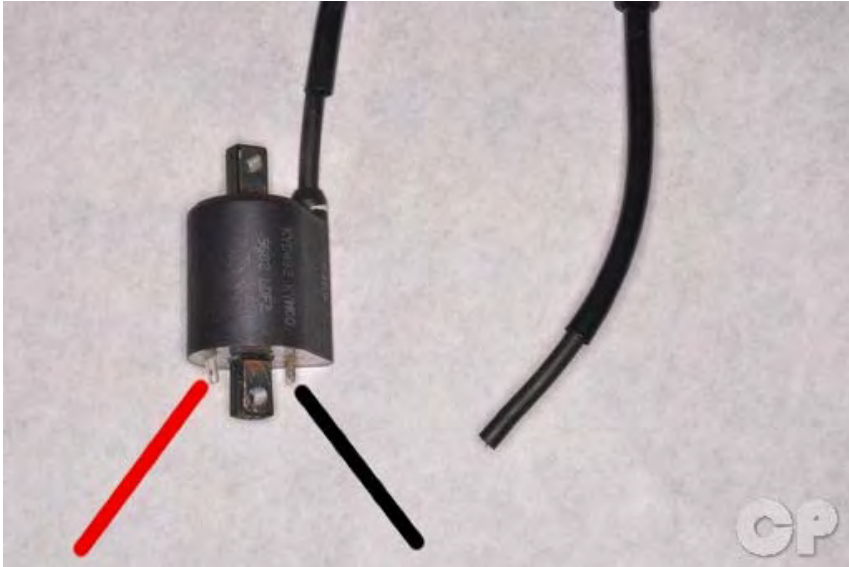

Touch the positive and negative meter leads to the ignition coil terminals as shown. Measure the resistance.

Ignition Coil Primary Resistance	3.57 - 4.83 Ω
----------------------------------	----------------------

Secondary With Plug Cap



Check the secondary resistance between the ignition coil terminal and the spark plug cap. Touch the negative meter lead to the terminal and the positive meter lead to the spark plug cap as shown.

Secondary Resistance With Plug Cap	15 - 19 Ω
------------------------------------	------------------

13. Electrical System > Ignition System

Secondary Without Plug Cap

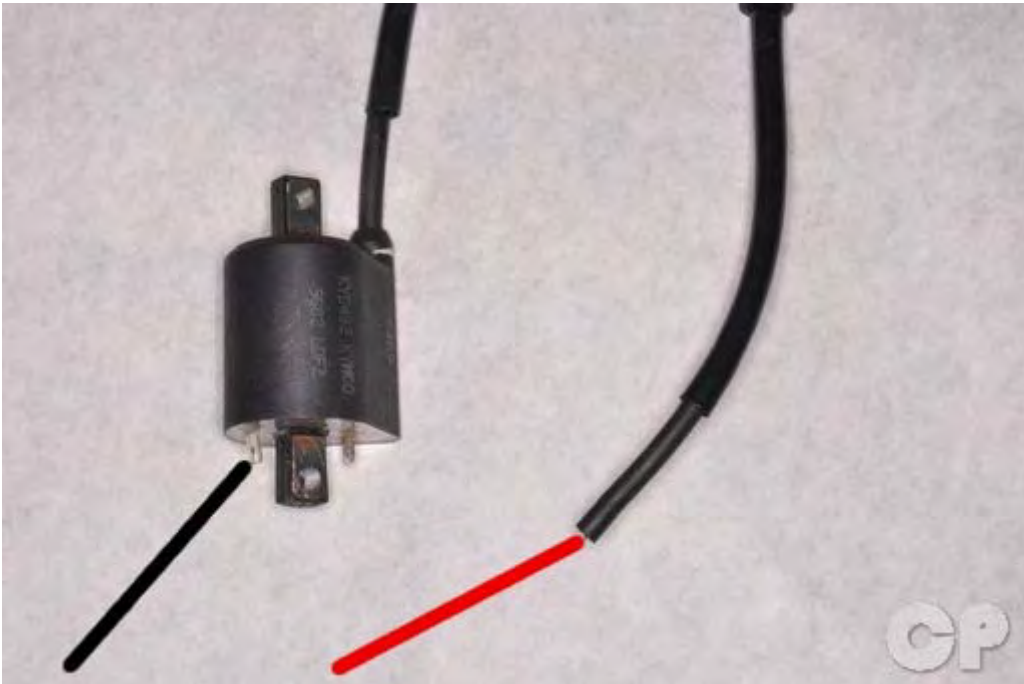

Check the secondary resistance between the ignition coil terminal and the spark plug wire without the cap. Touch the negative meter lead to the terminal and the positive meter lead to the spark plug wire as shown.

Secondary Resistance Without Plug Cap	10 - 14 Ω
---------------------------------------	-----------

AC Generator Inspection

Crank Position Sensor Inspection

Note: This test is performed with the stator installed in the engine.



Disconnect the crank position sensor wire coupler. Measure the resistance between the and green/white wire terminals.

Blue/White - Green/White	115 Ω ± 15 Ω
--------------------------	--------------

Starting System

SAFETY FIRST: Protective gloves and eyewear are recommended at this point.

You will need a digital multimeter to inspect the starting system.

Starter Relay

Inspection

Remove the body cover. See the Body Cover topic for more information.



The starter relay is located on the right side of the vehicle.

13. Electrical System > Starting System



Disconnect the starter relay wire connector.

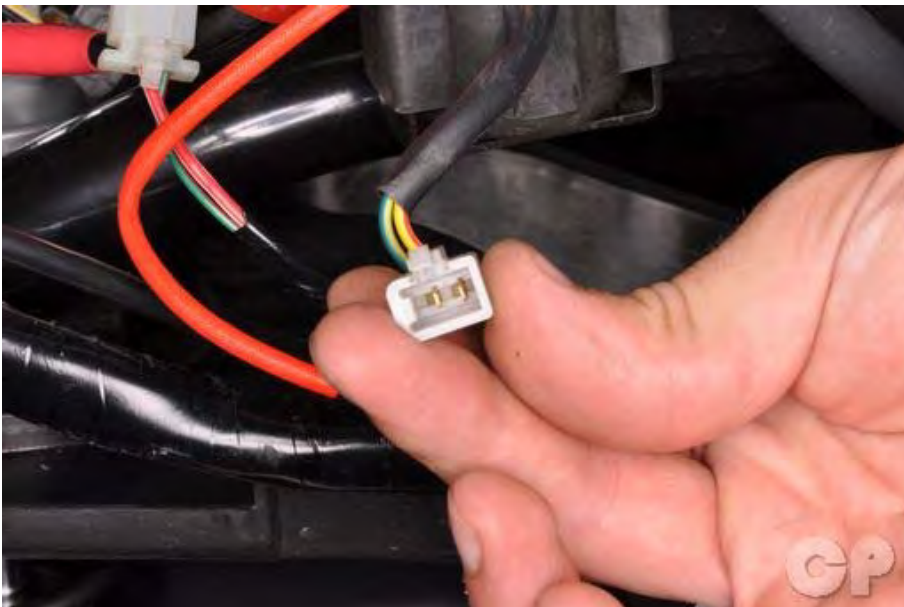

Check for continuity between the yellow/red wire and the green/yellow wire. There should be continuity when the starter button is depressed. If there is no continuity, check the starter button for continuity and inspect the wire.

13. Electrical System > Starting System

Operation Test

Turn the ignition switch to "OFF".



Remove the negative battery cable bolt with a 10 mm socket or #3 Phillips screwdriver. Free the negative cable from the battery.



Remove the two terminal covers.



13. Electrical System > Starting System



Remove the nuts that hold the starter motor lead and battery lead wires to the starter relay with a 10 mm socket.



Remove the leads from the starter relay.



Disconnect the starter relay wire connector.

13. Electrical System > Starting System

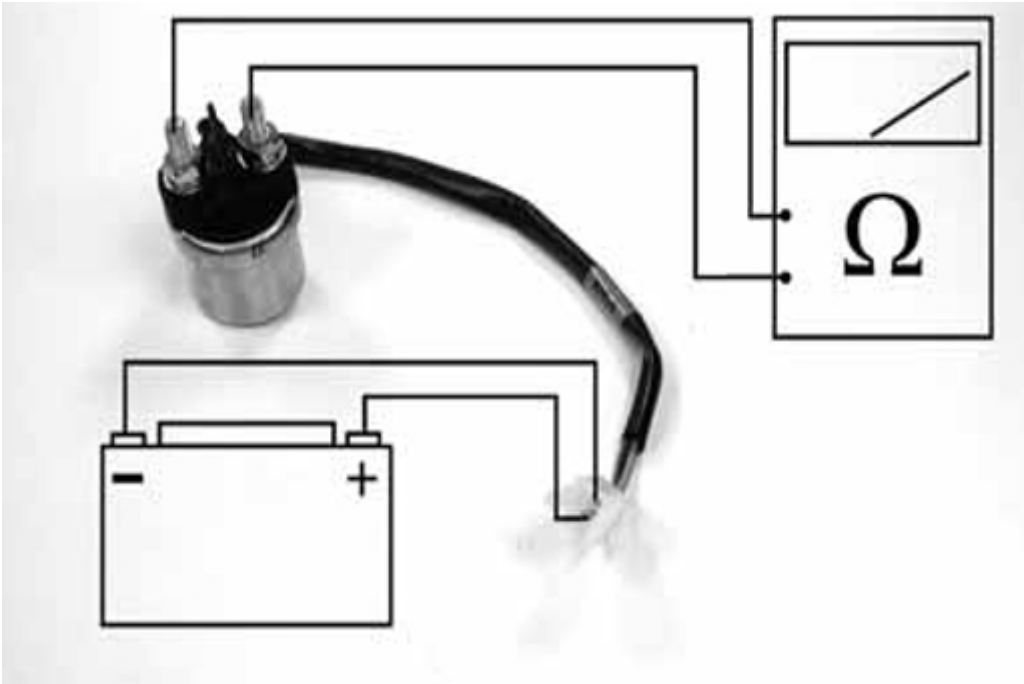

Connect the electric meter to the starter relay terminals that connect to the battery positive cable and the starter motor cable. Connect a fully charged battery across the starter relay yellow/red and green/yellow wire terminals. Check for continuity between the starter relay large terminals. The relay is normal if there is continuity and hear sounds.

Warning: Do not apply the battery voltage jump for more than five seconds or the relay may be damaged.

Starter Motor

SAFETY FIRST: Protective gloves and eyewear are recommended at this point.

Removal

Turn the ignition switch to "OFF".



Remove the negative battery cable bolt with a 10 mm socket or #3 Phillips screwdriver. Free the negative cable from the battery.



Pull back the rubber starter motor lead cover.

13. Electrical System > Fuses

Fuses

SAFETY FIRST: Protective gloves and eyewear are recommended at this point.

Fuse Box



Fuses box

The fuse box is located in the front of the battery.

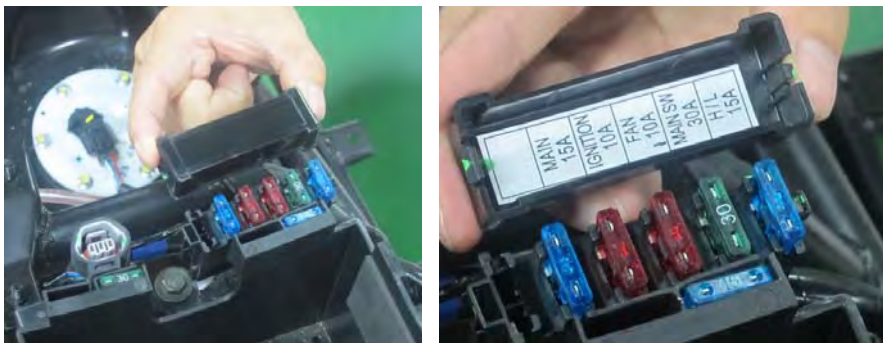

Open the covers to access the fuses.

ECU Removal

SAFETY FIRST: Protective gloves and eyewear are recommended at this point.



Note: The ignition control module or ECU may be damaged if dropped or the connector is disconnected when the key is "ON". The excessive voltage may damage the ignition control module or ECU. Always turn off the ignition switch before servicing.



Disconnect the ECU harness.

13. Electrical System > ECU Removal



Remove the two mounting nuts with a socket.

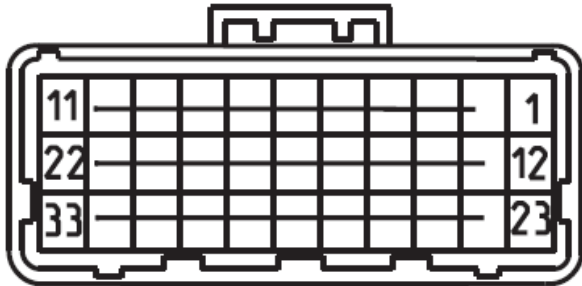

Remove the ECU.

13. Electrical System > ECU Removal
Inspection

Disconnect and remove the ECU from the frame.

Check for continuity between pin 9 and 10 of the ECU side connector.

There should be continuity at all times.

Check for continuity between each pins 2, 4 and 23 of the ECU side connector.

There should be continuity at all times.

Check for continuity between pin 24 and 10 of the ECU side connector.

PIN NO.	NAME	FUNCTION	PIN NO.	NAME	FUNCTION
01	IGP	IGNITION POWER	19	FLPR	FUEL PUMP RELAY
02	LGI	LOGIC GROUND I	20	ISCBP	IDEL SPEED CONTROL B
03	HEGO	HEGO SENSOR	21	ISCAP	IDEL SPEED CONTROL A
04	SG	SENSOR GROUND	22	HEGO HT	HEGO SENSOR HTATER
05	TH	THROTTLE POSITION SENSOR	23	CRK-M	CRANK PULSE SENSOR GND
06	VCC	SENSOR POWER OUTPUT(+5V)	24	TW	WATER TEMP. SENSOR
07	BATT	BATTERY	25	-	-
08	FAN	FAN RELAY	26	ROLL	ROLL SENSOR
09	PG1	POWER GROUND I	27	PM	MANIFOLD PRESSURE SENSOR
10	PG2	POWER GROUND 2	28	SOL	-
11	IG	IGNITION COIL	29	-	-
12	CRK-P	CRANK PULSE SENSOR	30	K-LINE	DIAGNOSTIC TOOL
13	-	-	31	ISCBN	IDEL SPEED CONTROL / B
14	-	-	32	ISCAN	IDLE SPEED CONTROL / A
15	TEST	-	33	NE	METER
16	INJ	INJECTION			
17	-	-			
18	MIL	MULTI INDICATOR LAMP			

13. Electrical System > ECU Removal**Installation**

Install the two mounting nuts and tighten securely with a socket.



Connect the ECU harness.

Self-Diagnosis

SAFETY FIRST: Protective gloves and eyewear are recommended at this point.

Note: No matter when the CELP illuminated while riding condition, should find out the cause of the problem as soon as possible.

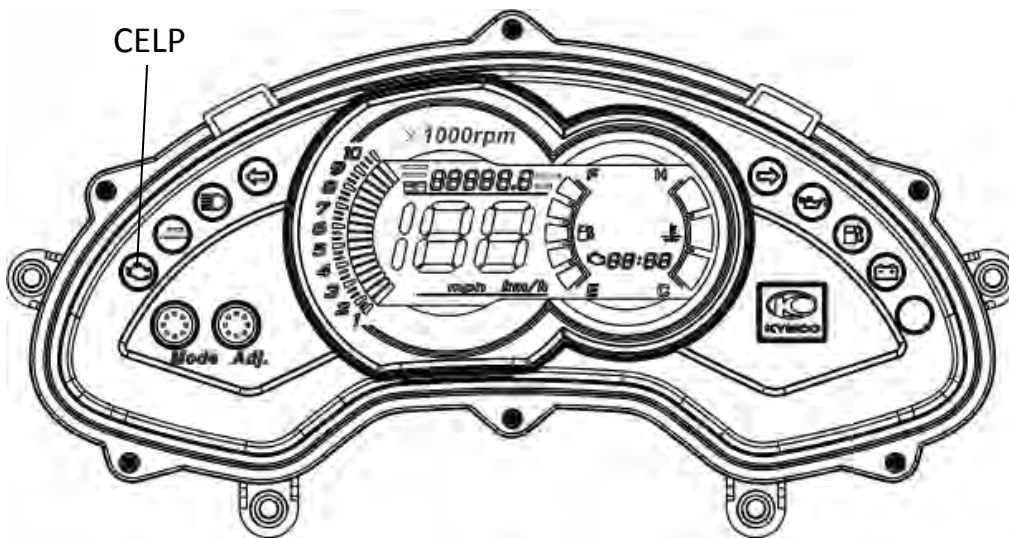

The check engine lamp (CELP) or Fi indicator is located next to the battery warning indicator.

If the ECM connectors, or battery leads are disconnected the stored malfunction codes will be lost.

Without Diagnostic Special Tool

SELF-DIAGNOSTIC PROCEDURES

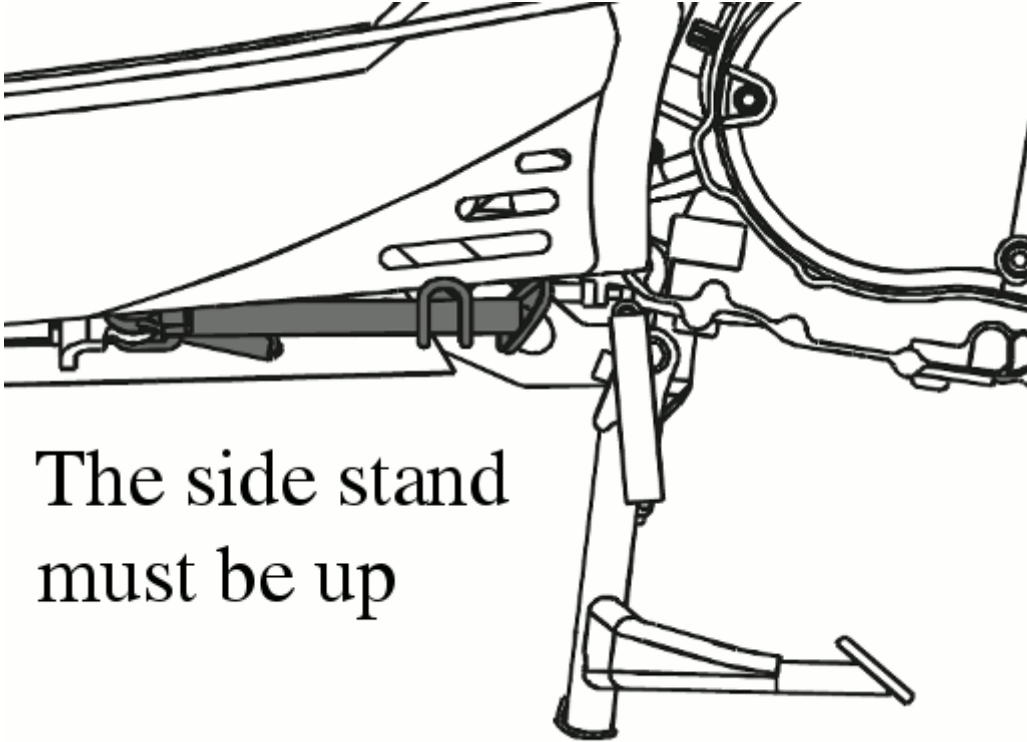

The side stand must be up

Place the scooter on its main stand and put the side stand up.



Set the engine stop switch to the "RUN" position.

13. Electrical System > Self-Diagnosis

- Turn key to On position.
- The CELP will be lighting for two seconds and then off.
- If the engine has problem, the CELP will blink to show the failure codes.
- There're 11 failure codes for the KEHIN system.

If the vehicle gets more failure codes, the CELP will be blinking from a lower number, then show the higher number after three seconds. All failure codes would be appeared repeatedly. It can be performed without diagnostics program.

EFI SELF-DIAGNOSIS FAILURE CODES

The CELP denotes the failure codes. When the indicator lights for one second that is equal to ten.

For example: one longer blink illumination and two shorter blinks (0.5 second x 2) of the indicator is equal to 12 blinks. Follow code 12.

If more than a damaged part has occurred, the CELP begins blinking in order.

For example: If the indicator blinks six times, then shows one second illumination and two blinks, so there are two failures have occurred. Follow code 6 and 12.

CELP FAILURE CODES LIST				
Blinks	Failure Codes	Contents	Causes	Symptoms
06	P0120	Faulty TPS	<ul style="list-style-type: none"> • Faulty TPS voltage range (0.3 - 4.5 V) • Loose or poor connection on TPS Sensor • Open or short circuit on the TPS wire • Faulty TPS itself 	Engine operates normally
09	P0105	Faulty MAP	<ul style="list-style-type: none"> • Faulty MAP voltage range (1 - 4.2 V) • Loose or poor connection on MAP Sensor • Open or short circuit on MAP wire • Faulty MAP itself 	Engine operates normally
12	P0115	Faulty WTS (water temp.)	<ul style="list-style-type: none"> • Faulty ECT Ω range (-20°C: 18.8 Ω/40°C: 1.136 Ω/100°C: 0.1553 Ω) • Loose or poor connection on ECT • Open or short circuit on ECT 	Engine operates normally

13. Electrical System > Self-Diagnosis

15	P1630	Faulty Tilt switch (Roll)	<ul style="list-style-type: none"> wire • Faulty ECT • Faulty Tilt switch voltage range (inclined angle <65°: 0.4 - 1.4 V/ Inclined angle >65°: 3.7 - 4.4 V) • Loose or poor connection on Tilt switch • Open or short circuit in Tilt switch wire • Faulty tilt switch 	Engine operates normally
17	P0130	Faulty O ² sensor	<ul style="list-style-type: none"> • Faulty O² sensor voltage range (A/F below 14.7: > 0.7V/ A/F over 14.7: < 0.18 V) • Loose or poor connection on O² sensor • Open or short circuit on O² sensor wire • Faulty O² sensor 	Engine operates normally
33	P0201	Faulty injector (Nozzle)	<ul style="list-style-type: none"> • Faulty Fuel injector Ω range (9.945 - 13.5 Ω) • Loose or poor connection on injector • Open or short circuit on injector wire • Faulty fuel injector 	Engine fails to be operated
37	P0351	Faulty inductive ignition coil	<ul style="list-style-type: none"> • Faulty Inductive ignition coil Ω range (4.2 $\Omega \pm 15\%$) • Loose or poor connection on inductive ignition coil • Open or short circuit on inductive ignition coil wire • Faulty inductive ignition coil 	Engine fails to be operated
41	P0230	Faulty fuel pump	<ul style="list-style-type: none"> • Faulty Fuel pump fl range (F: 1100 \pm 33 Ω E: 100 + 3 Ω) • Loose or poor connection on fuel pump • Open or short circuit on fuel pump wire • Faulty fuel pump 	Engine fails to be operated
45	P0135	Faulty O ² sensor heater	<ul style="list-style-type: none"> • Faulty O² sensor heater Ω range (6.7 - 9.5 Ω) • Loose or poor connection on O² sensor heater • Open or short circuit on O² sensor heater wire • Faulty O² sensor heater 	Engine starts normally but not smooth
49	P1505	Faulty ISC	<ul style="list-style-type: none"> • Loose or poor contacts on ISC • Open or short circuit in ISC wire • Faulty ISC 	Engine operates normally
66	P0335	Faulty CPS	<ul style="list-style-type: none"> • Loose or poor connection on CPS sensor • Open or short circuit on CPS wire • Faulty CPS sensor 	Engine starts normally but not smooth

Self-Diagnosis Reset Procedure

Note: The self-diagnosis cannot be reset when has still problem inside the system.

1. Put the side stand up and engine stop switch is at "RUN".
2. Turn the key to the ON position and wait for ten seconds.

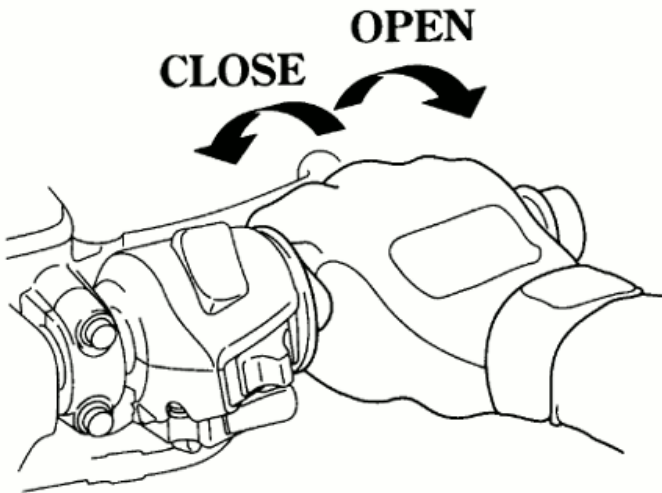

3. Fully open the throttle and wait for ten seconds.
4. Release the throttle.

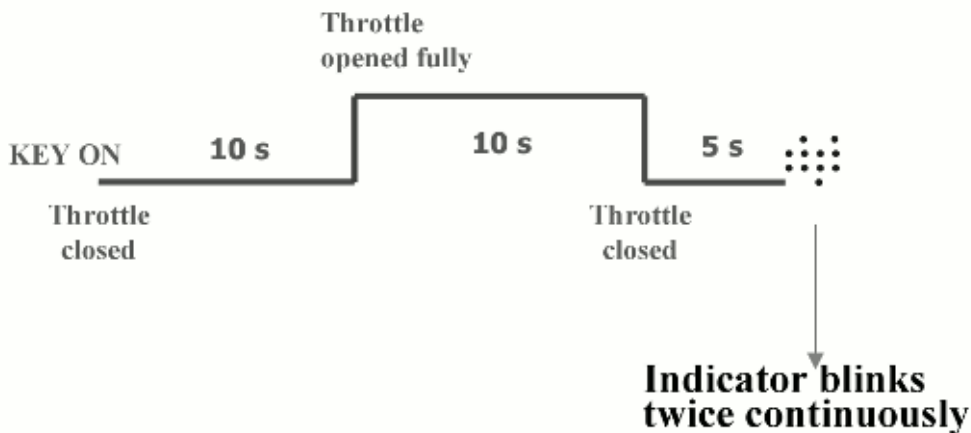

5. The indicator will blink twice (0.5 second) after five seconds quickly.
6. Self-diagnosis memory data is disappeared after the CELP lamp is off.

Spark Plug Anti-Flood

When no failure code occurs and pressing starter switch repeatedly can still not start the engine the spark plug maybe fouled be a flooded engine. Perform the spark plug anti-flood to purge the fuel in the engine.

Make sure the battery voltage is greater than 12 V.

1. Close the throttle, turn the ignition switch to ON.
2. Open and hold the throttle fully, pressing starter switch more than 3 seconds.

TPS/ISC Reset

- If the throttle is being moved when the throttle body or TPS is installed it can cause a hard to start engine or incorrect idling speed.
- ISC has a motor inside, which controls air bypass valve to obtain a smooth idling speed. The ECU may record the incorrect ISC position when the ECU or the throttle body has been reinstalled. It can cause engine stop, hard to start engine or rough idling speed.

The throttle position sensor (TPS) and idle air bypass valve (ISC) have to be reset when throttle body, MAP, TPS, ISC or ECU have been reinstalled.

TPS/ISC RESET PROCEDURE

1. Put the side stand up and engine stop switch is at "RUN".
2. Turn the key to the OFF position.
3. Fully open the throttle.
4. Turn the key to the ON position.
5. Release the throttle after waiting for eight seconds.
6. Turn the key to the OFF position.
7. Turn the key to the ON position.
8. TPS and ISC have been reset successfully. If fail to reset, repeat the steps from 1 to 8.

Horn

SAFETY FIRST: Protective gloves and eyewear are recommended at this point.



Disconnect the horn connectors from the horn. Connect a 12 V battery to the horn terminals. The horn is normal if it sounds when the 12 V battery is connected across the horn terminals.

13. Electrical System > Lights

Lights

SAFETY FIRST: Protective gloves and eyewear are recommended at this point.

Headlight

Bulb Replacement

Make sure the machine has been off for several minutes before removing the headlight bulb.



Slide back the rubber headlight covers and then remove the headlight bulbs to free it from the lamp.

Unplug the bulb from its connector. Do not touch the bulb with your bare hands if you plan to reuse it.

13. Electrical System > Lights

Do not touch your new bulb with your bare hand. The oils on your hand can cause an early failure of the headlight bulb. If you do touch the bulb with your bare hand wipe off the bulb with a clean shop towel and alcohol.

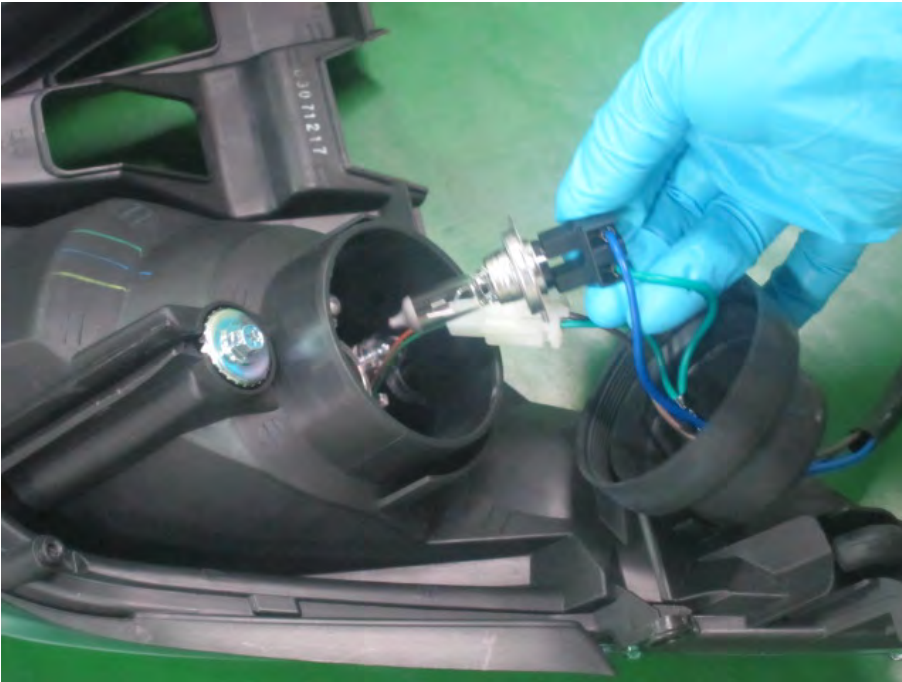

Fit the bulb into the lamp and then remove the headlight bulbs to free it from the lamp.



Fit the rubber cover into place. Make sure the rubber covers are secured in place.

13. Electrical System > Lights

Aim



Turn the screws to adjust the head light aim as needed.

Front Turn Signals



Turn the turn signal bulb socket counterclockwise and free it from the lamp.

13. Electrical System > Lights



Push in on the bulb and rotate it clockwise to remove it from the socket. Insert the new bulb. Push down on the bulb and rotate it counterclockwise to lock it into place.

Insert the turn signal bulb and socket into place. Turn the socket clockwise to lock it into place.

13. Electrical System > Lights

Taillights

LED Replacement

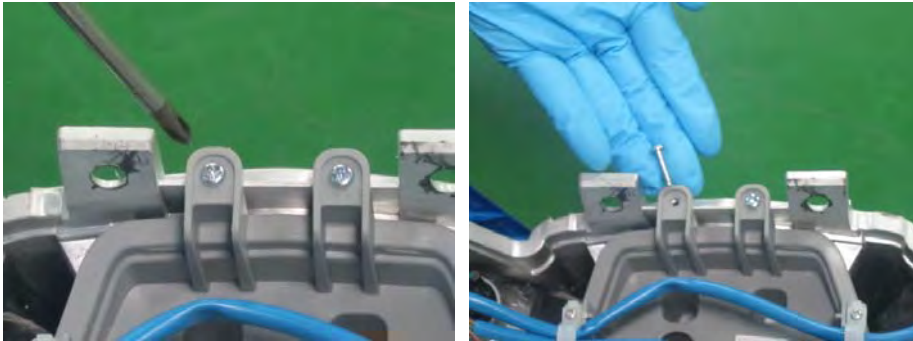

Remove the five taillight mounting the tail light housing.



Remove two screws mounting the clips.

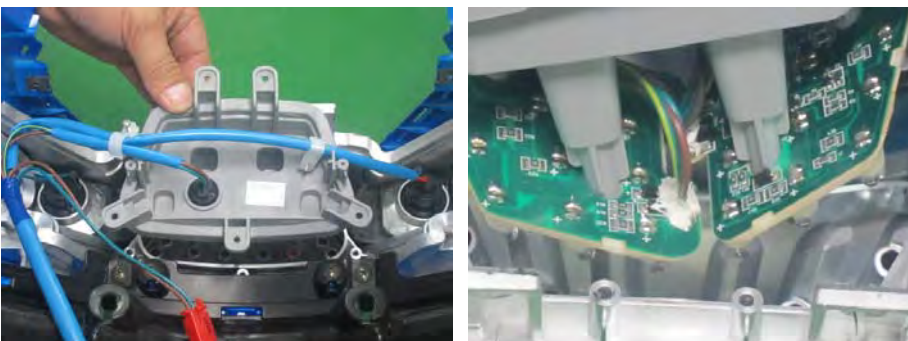

Remove the LED taillight assy.
Replace the LED as needed.
Install the taillight socket into the LED.

13. Electrical System > Lights

Rear Turn Signals

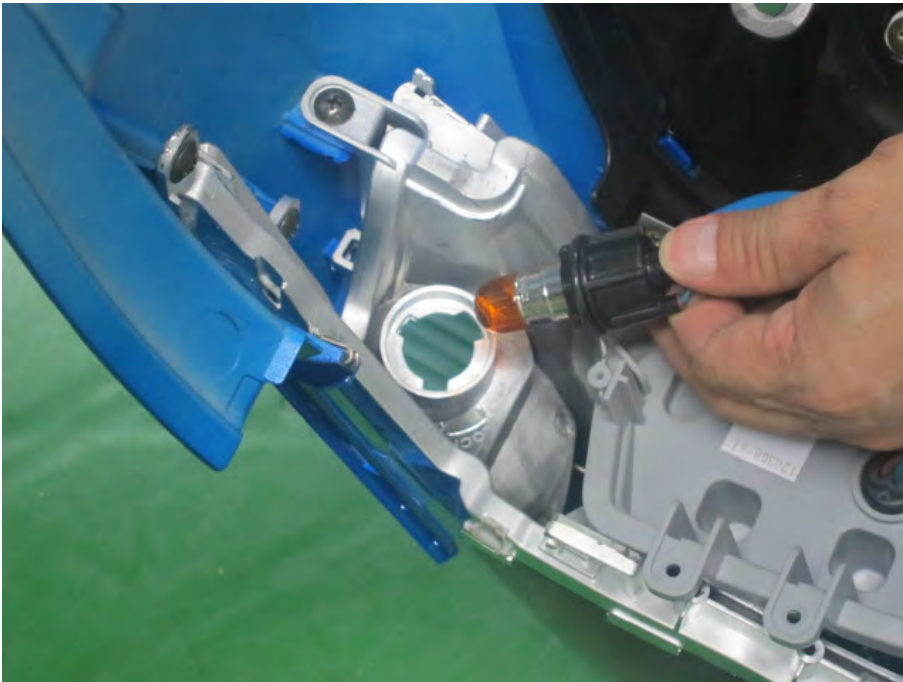

Turn the socket counter-clockwise and remove it from the lamp.



Push in the bulb and turn it counter-clockwise. Remove the bulb. Insert the new bulb and turn it clockwise to lock it in place.

13. Electrical System > Lights

License Tag Light

Remove the license tag light from the mud flap.



Pull the rubber tag light socket out of its housing. Pull the bulb straight out and insert a new one.

Relays

SAFETY FIRST: Protective gloves and eyewear are recommended at this point.

High/Low Beam Relays

Remove the front cover.

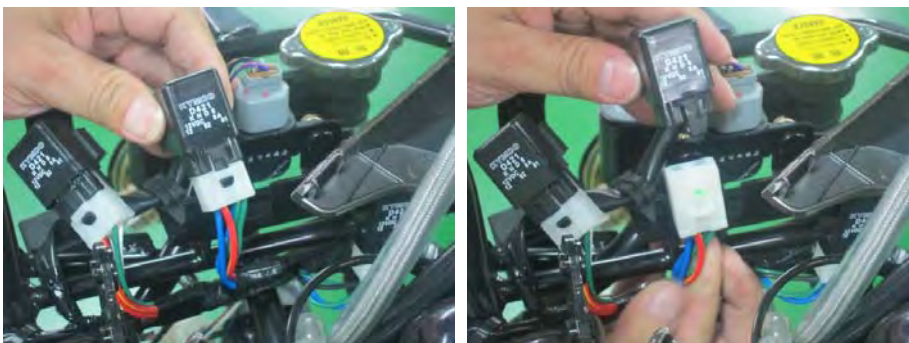

Remove and disconnect the high beam relay. The Low beam relay is on the left.

13. Electrical System > Relays

Fuel Pump Relay

Remove the luggage box.



The fuel pump relay is located in front of battery. Remove and disconnect the fuel pump relay.

Inspection

Use a digital multimeter to inspect the fuel cut-off relay. Set the multimeter to read ohms of resistance.

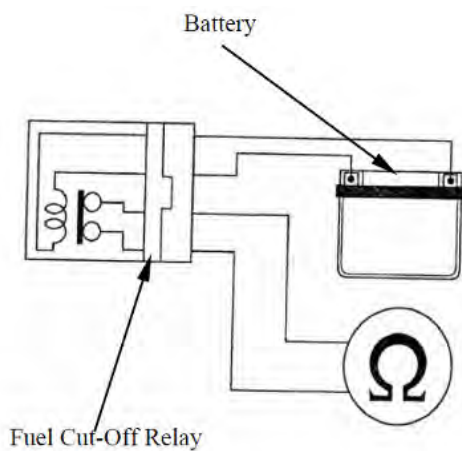

13. Electrical System > Relays

Connect the multimeter to the fuel cut-off relay connector terminals

Connection: Black - Red/Black

Connect 12 V battery with the fuel cut-off relay connector. Connection: Blue/Black - Black

There should be continuity only when 12 V battery connected.

If there is not continuity when the 12 V battery is connected, replace the fuel cut-off relay.

Start Relay



The start relay is located in front of battery. Remove and disconnect the start relay.

Inspection

Use a digital multimeter to inspect the start relay.

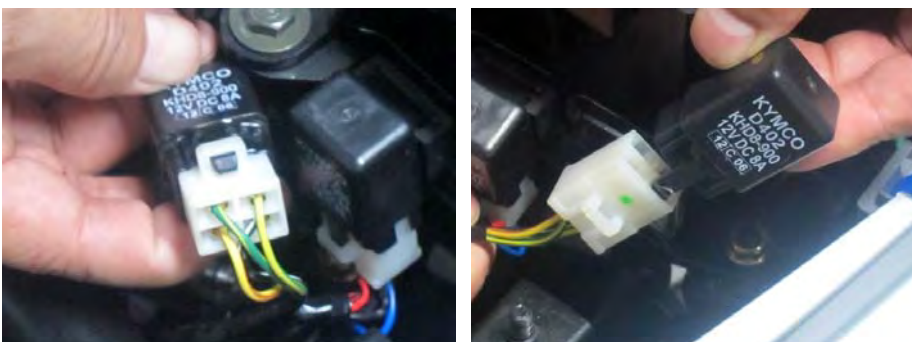

13. Electrical System > Relays

Turn on the ignition switch to “ON” position.

Turn on the engine stop switch to “RUN” position.

Keep the side switch upward.

Apply the brake lever fully.

Connect the multimeter to the start relay connector terminals. Set the multimeter to read ohms of resistance.

Connection: Yellow/Green – Black/White

ECU Relay

Remove the body cover.

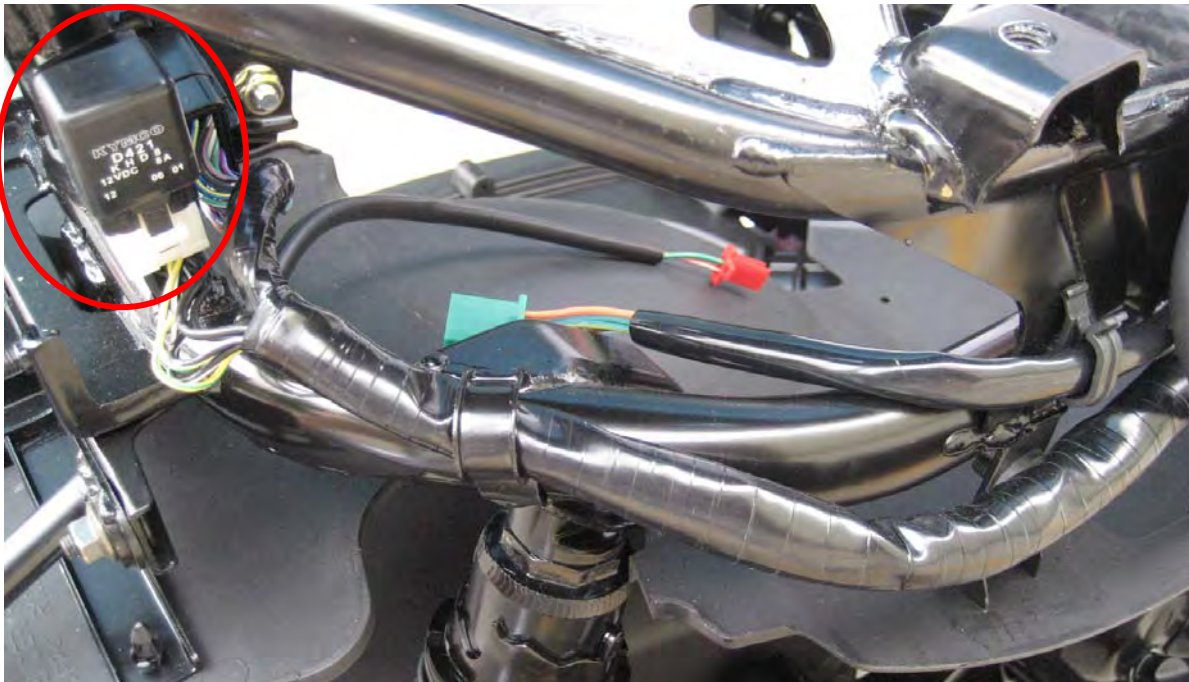

The ECU relay is located in the rear next to the ECU. Remove and disconnect the ECU relay.

13. Electrical System > Relays

FAN Relay



Remove the front cover.

The Fan relay is on the left.

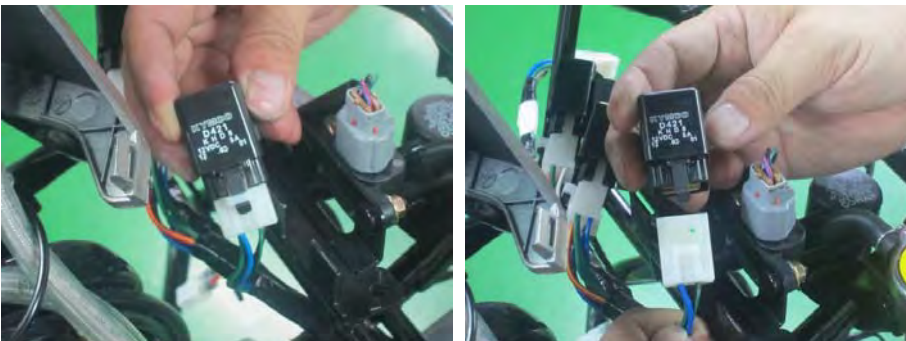

Remove and disconnect the Fan relay.

Switches

SAFETY FIRST: Protective gloves and eyewear are recommended at this point.

You will need a digital multimeter to inspect the switches.

Ignition Switch

Remove the front cover.



Unplug the white six-pin ignition switch connector.



Use a digital multimeter to check for continuity to inspect the ignition switches. Continuity should exist between the wires as indicated.

13. Electrical System > Switches

COMB SW

	BAT2	IG	E	BAT1	HA
LOCK		○—○			
OFF		○—○		○—○	
ON	○—			○—○	
COLOR	B	B/W	G	R	B/L

Removal

Remove the front cover.

Remove the dash.



13. Electrical System > Switches



Remove the seat latch cable cover.



Loosen the seat latch cable screw with a #2 Phillips screwdriver.



Remove the seat latch cable screw and free the seat latch cable from the ignition switch.

13. Electrical System > Switches



To remove the anti-tamper bolts use a punch and a hammer to strike the bolts so that they rotate loose. Turn the bolts clockwise to loosen them.

Installation

Install new anti-tamper bolts and tighten them securely.



Fit the end of the seat latch cable into the ignition switch.



Install the seat latch cable screw and tighten it securely with a #2 Phillips screwdriver.

13. Electrical System > Switches



Install the seat latch cable cover.

Tilt Switch

Remove the front cover.

Support the scooter level surface.

Put the side stand up and engine stop switch on "RUN". Turn the ignition switch to "OFF".

Note: Do not disconnect the tilt switch connector during inspection.
The capacity of battery must be fully charged.



The tilt switch is next to the radiator cap.

13. Electrical System > Switches



Remove the two tilt switch bolts with a 10 mm socket.



Place the tilt switch vertical as shown and the ignition switch "ON". Measure the voltage as below.

Terminal	Standard
Violet/Red (+) ~ Green/Pink (-)	5 V (ECU voltage)
Black/Blue (+) ~ Green/Pink (-)	0.4 - 1.4 V less



Incline the tilt switch 65 ± 10 degrees to the left or right at the ignition switch "ON". Measure the voltage as below.

Terminal	Standard
Violet/Red (+) ~ Green/Pink (-)	5 V (ECU voltage)
Black/Blue (+) ~ Green/Pink (-)	3.7 - 4.4 V

Note: Repeat this test, first turn the ignition switch to "OFF", then turn the ignition switch to "ON".

13. Electrical System > Switches



Disconnect the connector to remove the tilt switch.

Note: Install the tilt switch with its “up” mark facing up and tighten the two screws securely.

Handlebar Switches

Remove the front cover.

To remove the handle bar switches see the Handlebar topic.



Unplug the black connector for the left handlebar switches.

13. Electrical System > Switches



Unplug the green connector for the right handlebar switches.

Right Handlebar Switches

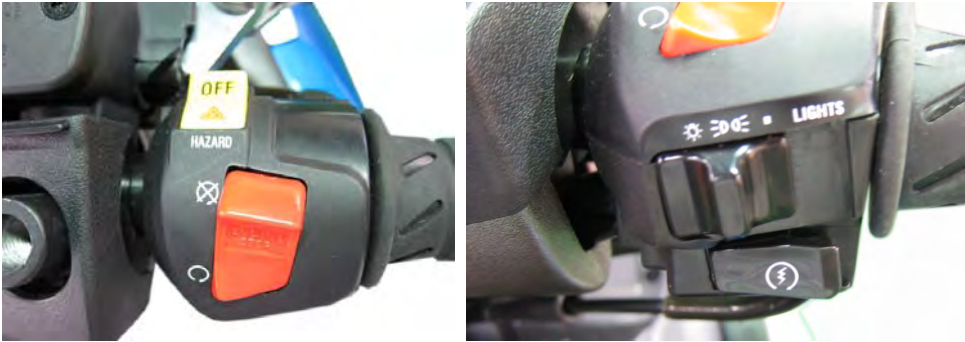

Use a digital multimeter to check for continuity to inspect the handlebar switches. Continuity should exist between the wires as indicated.

LIGHTING SW

	BAT3	PO	TL	HL
•				
(N)				
P	○—○	○—○	○	
(N)	○—○	○—○	○—○	○
H	○—○	○—○	○—○	○
COLOR	BR/L	BR/W	BR	W/L



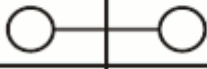

Starter Switch

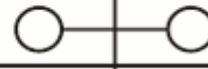
	E	ST
FREE		
PUSH		
COLOR	G	Y/R

Engine Stop Switch

	IG	BAT3
OFF		
RUN		
COLOR	B/W	B/G

HAZARD SW

	(N)	WR	HA
			
N			
			

13. Electrical System > Switches

Left Handlebar Switches



Use a digital multimeter to check for continuity to inspect the handlebar switches. Continuity should exist between the wires as indicated.

Passing Switch

Horn Switch

	BAT4	HI
FREE		
PUSH	○—○	
COLOR	BR/L	L

	BAT4	HO
FREE		
PUSH	○—○	
COLOR	BR/L	LG

Turn Signal Switch

Dimmer Switch

	WR	R	L
R	○—○		
N			
L	○—○		
COLOR	GR	SB	O

	HL	HI	LO
LO	○—○	○—○	
(N)	○—○	○—○	
HI	○—○		
COLOR	W/L	L	W

13. Electrical System > Switches

Luggage Box Switch

Remove the luggage box.



Unplug the two-pin luggage box light LED switch connector with red/white and green wires.

Use a digital multimeter to check for continuity. Test the switch side of the connector for continuity as the switch is manipulated. There should be continuity when the switch is pushed and none when it is released.



The switch is located both the side seat latch.

13. Electrical System > Switches



Luggage box light LED switch

Side Stand Switch

Remove the luggage box.

Place the vehicle on the center stand.

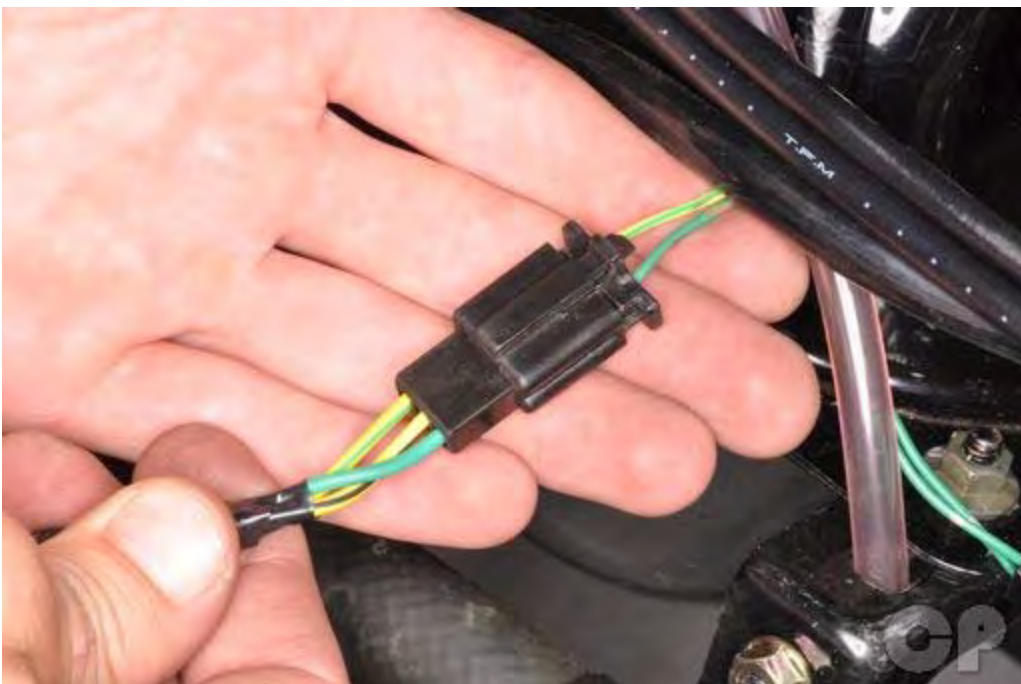

Unplug the three-pin side stand switch connector.

13. Electrical System > Switches

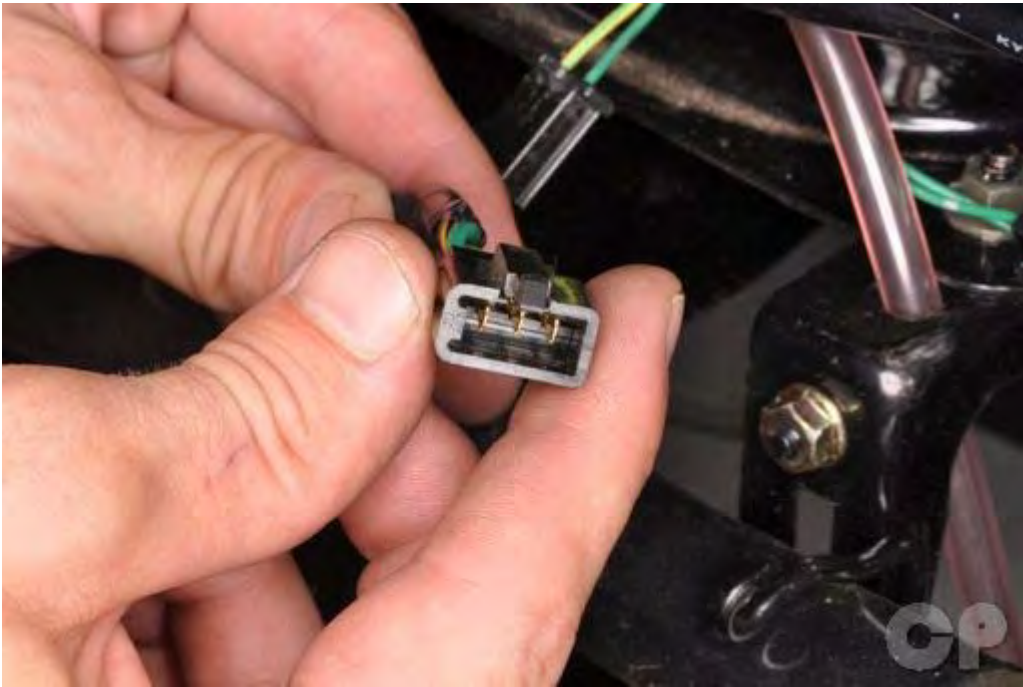

Use a digital multimeter to check for continuity.



With the side stand retracted there should be continuity between the yellow/green wire and the green wire terminals.

13. Electrical System > Switches



With the side stand extended there should be continuity between the yellow/black wire and the green wire terminals.

Brake Light Switches

Test the front and rear brake light switches in the same manner. Use a digital multimeter to check for continuity.

Remove the upper handlebar cover.



Unplug the brake light switch connectors.

13. Electrical System > Switches



Check for continuity between the brake light switch connectors. There should be continuity when the lever is pulled and none when released.

IGNITION SYSTEM K-XCT 300i

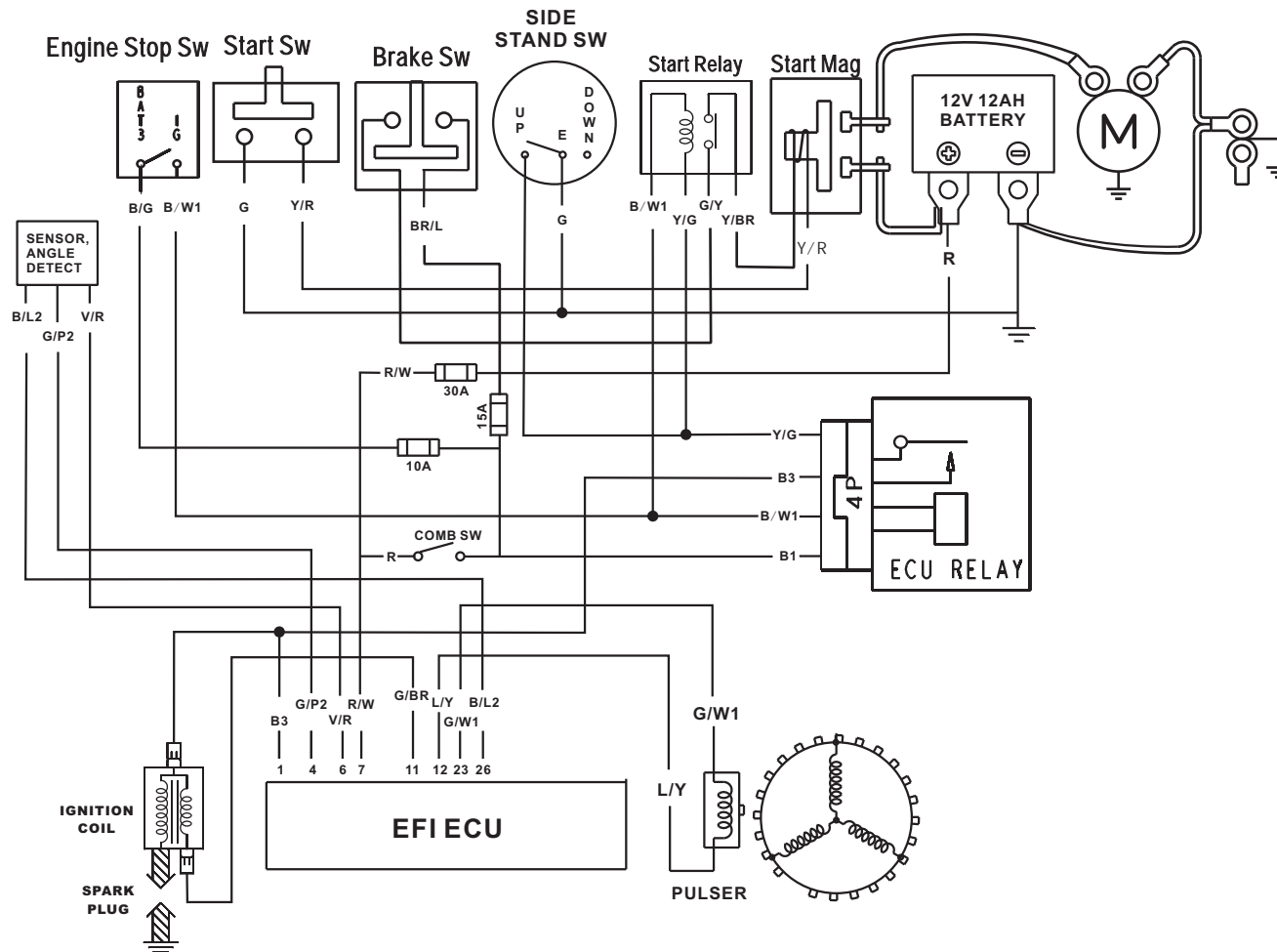

CHARGING SYSTEM K-XCT 300i

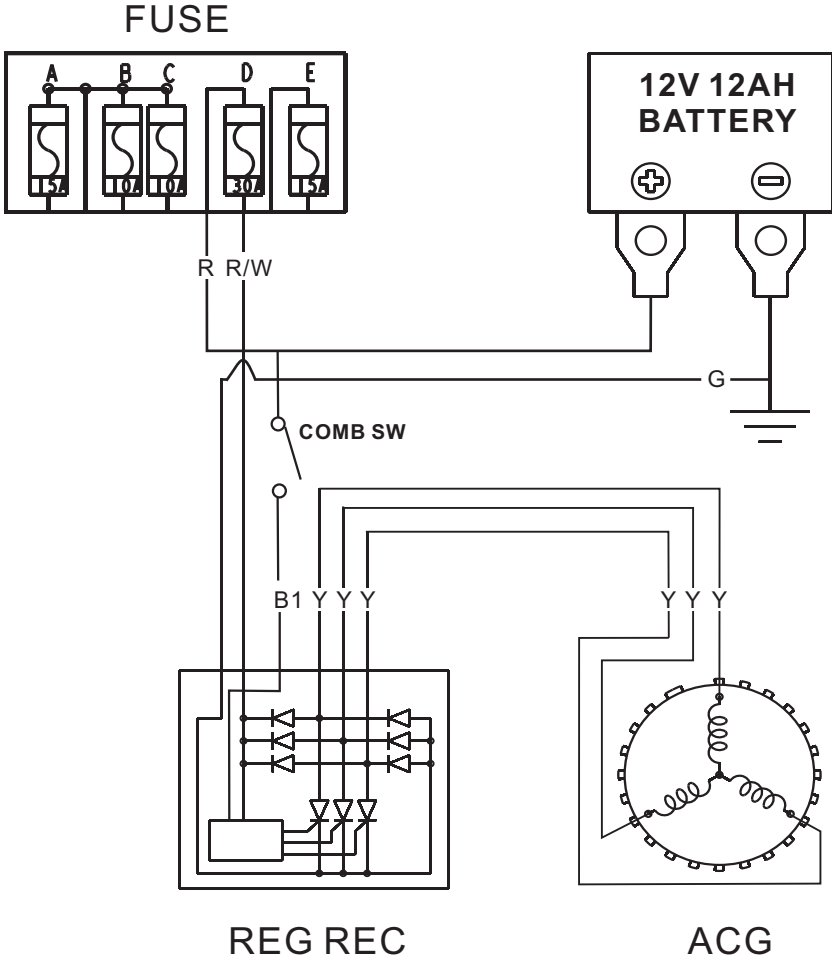

K-XCT 300i WIRING DIAGRAM

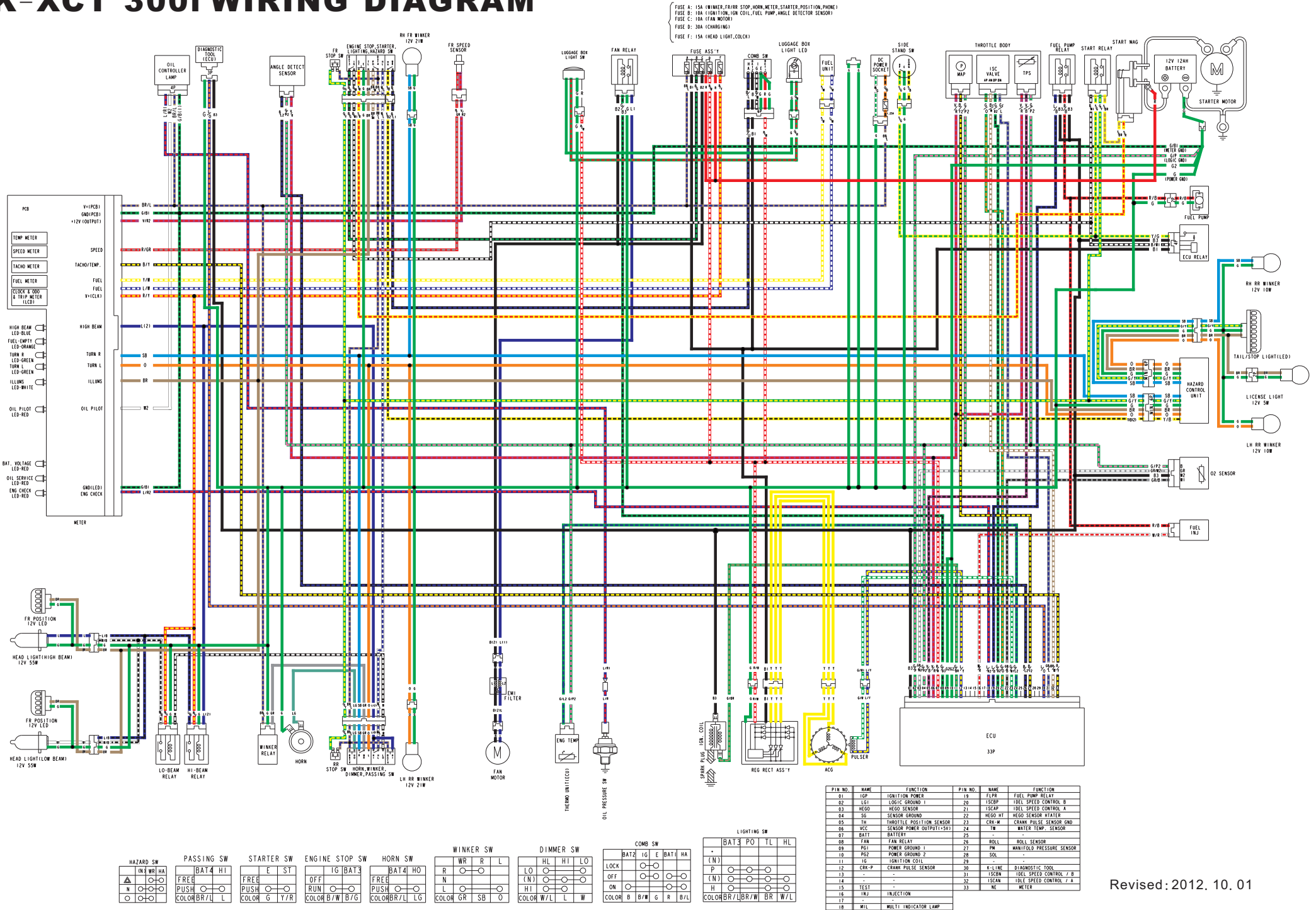

Quick Reference

This chapter provides a quick reference source of technical specifications and information for KYMCO K-XCT 300i models.

- Component Location14-2~14-10
- Special Tools..... 14-11
- K-XCT 300i Specifications 14-12~14-20
- Torque Specifications..... 14-21~14-22
- Troubleshooting 14-23~14-28
- VIN and Engine Number Location..... 14-29~14-30

14. Quick Reference > Component Location

Component Location

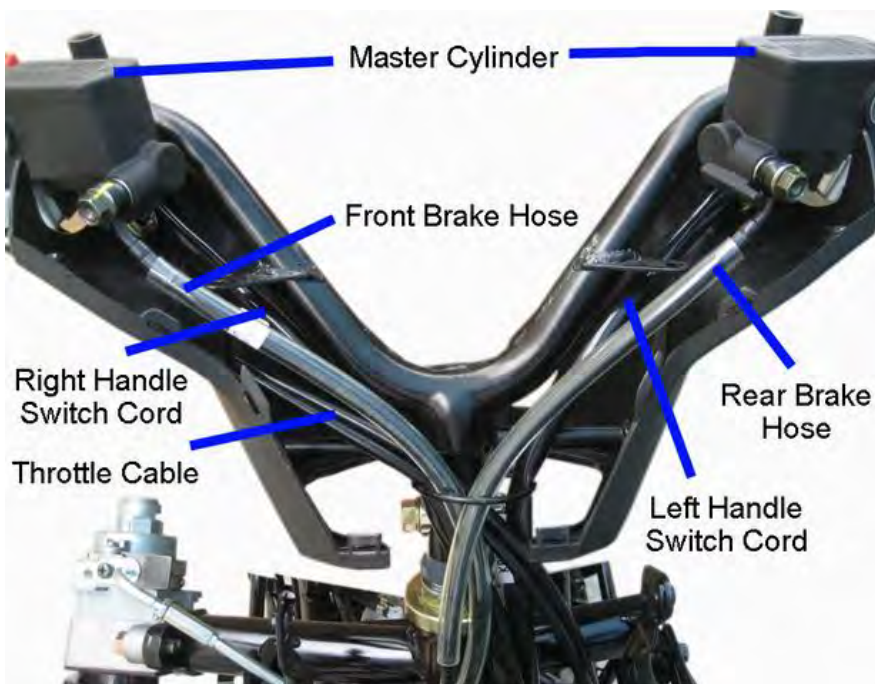
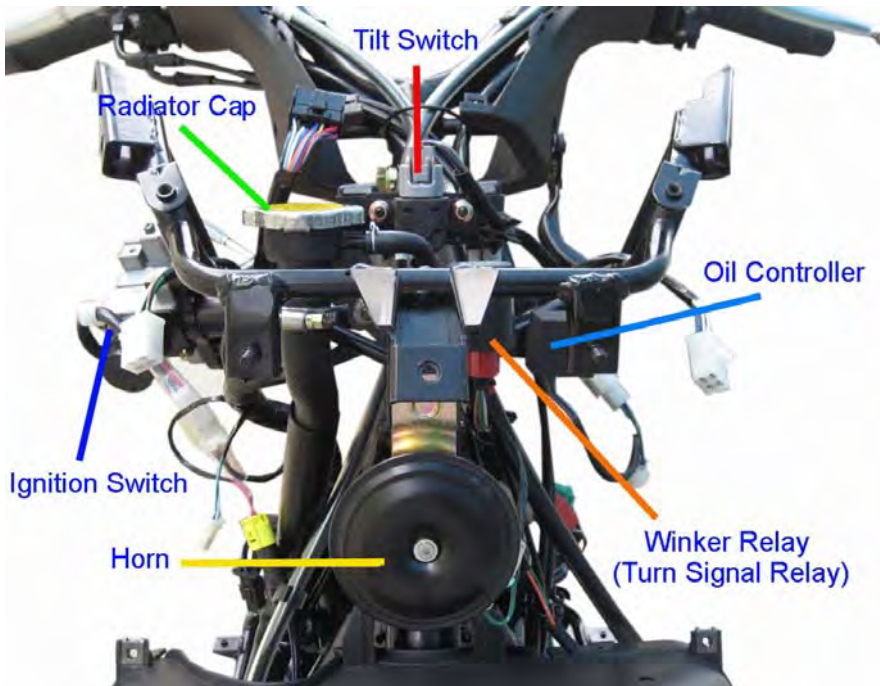

14. Quick Reference > Component Location

- Throttle Body
- ISC
- TPS
- MAP Sensor
- Fuel Injector
- WTS

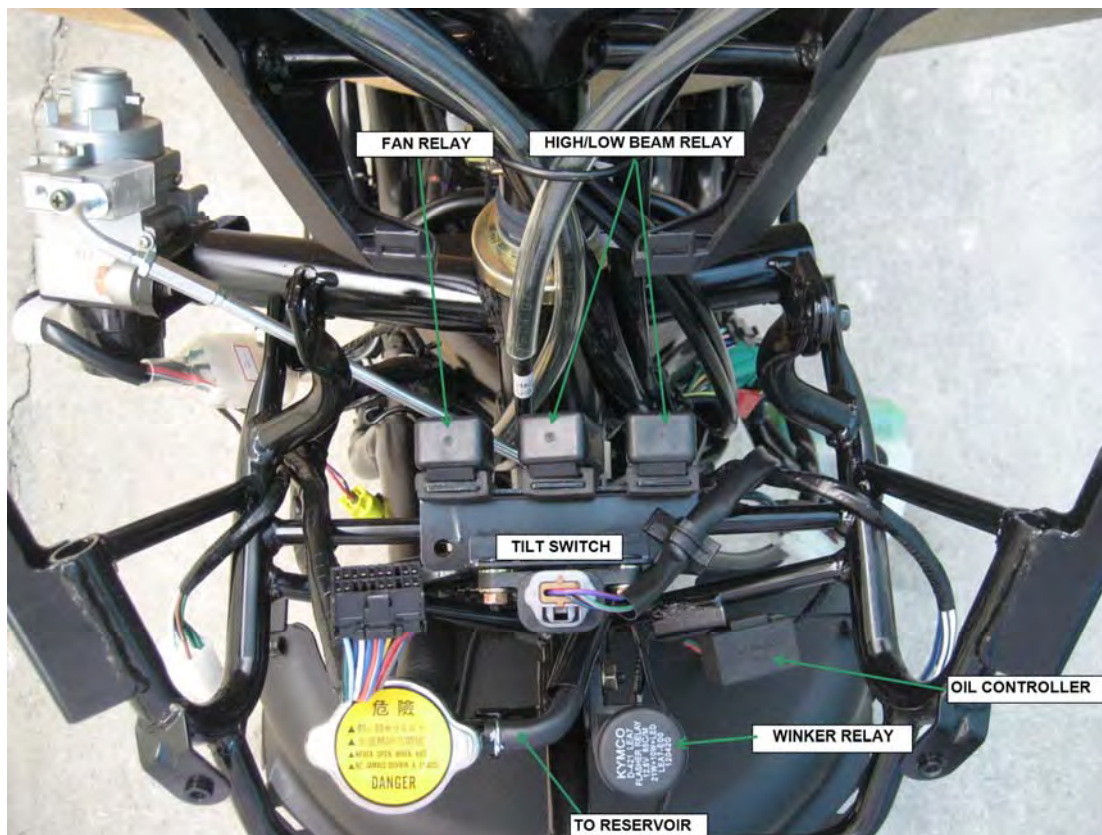

14. Quick Reference > Component Location

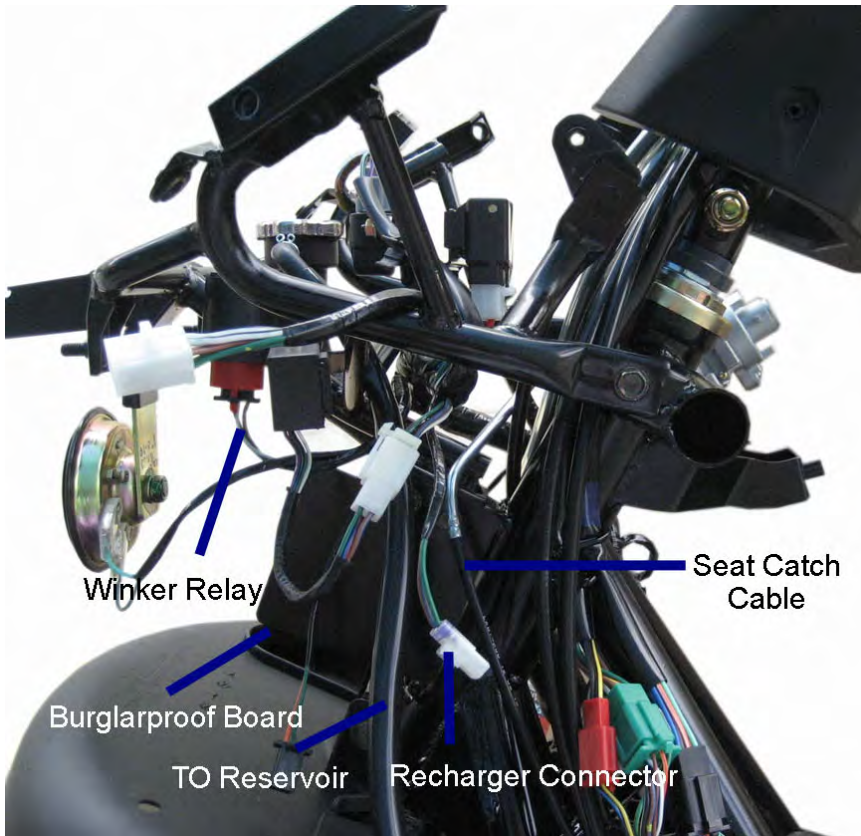

14. Quick Reference > Component Location

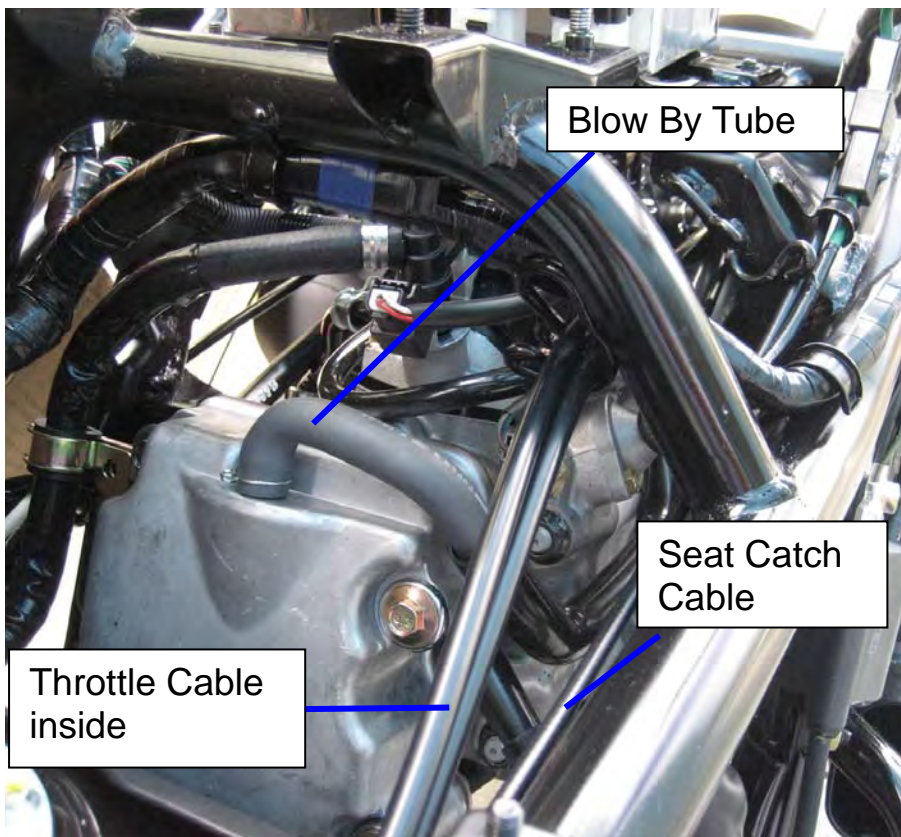
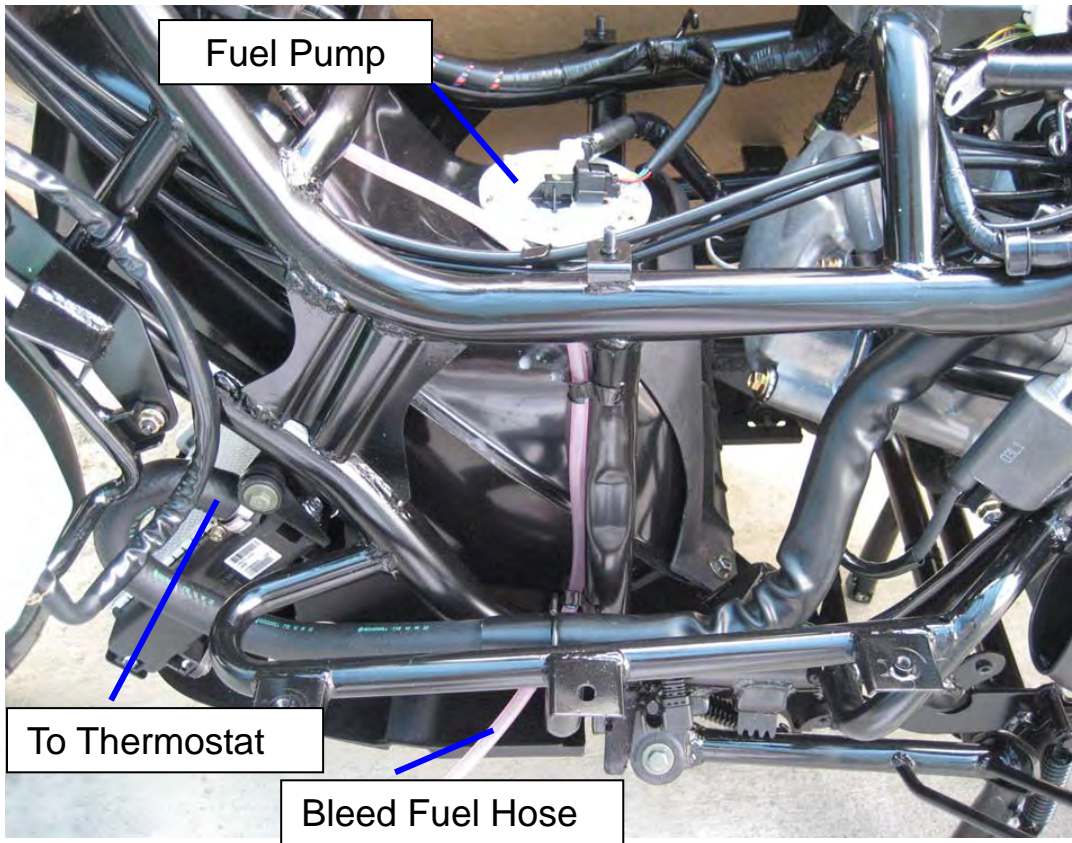

14. Quick Reference > Component Location

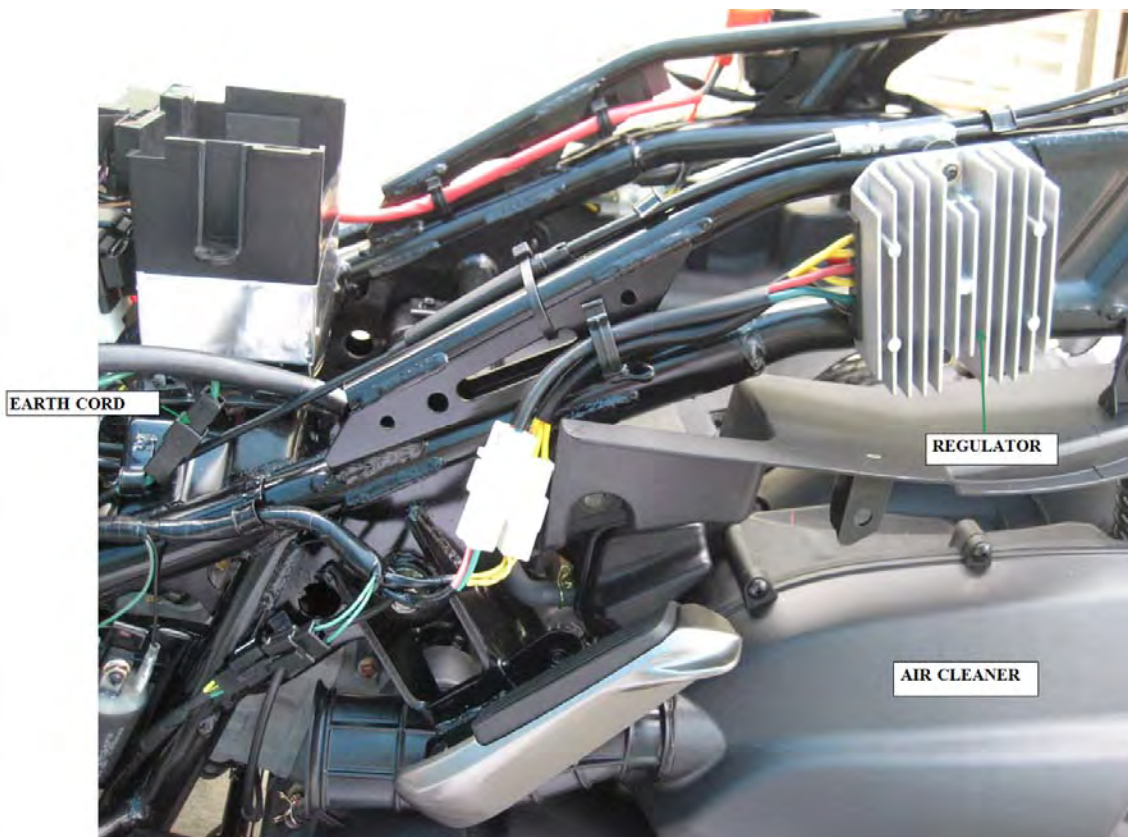
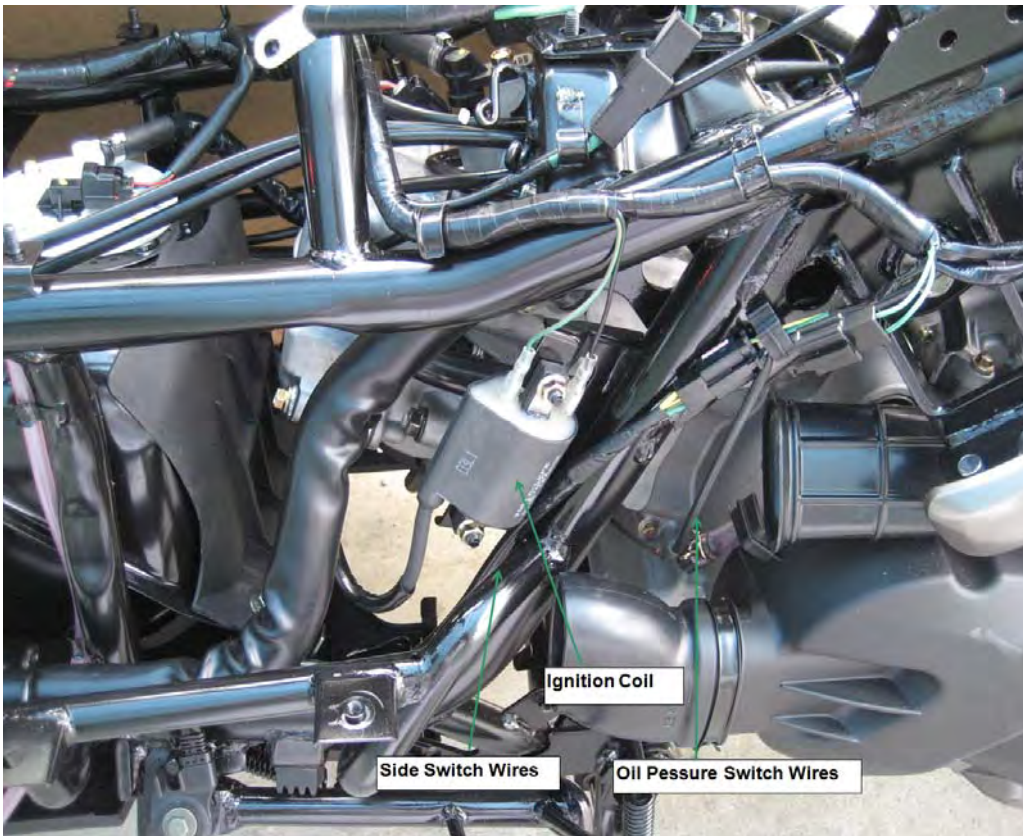

14. Quick Reference > Component Location

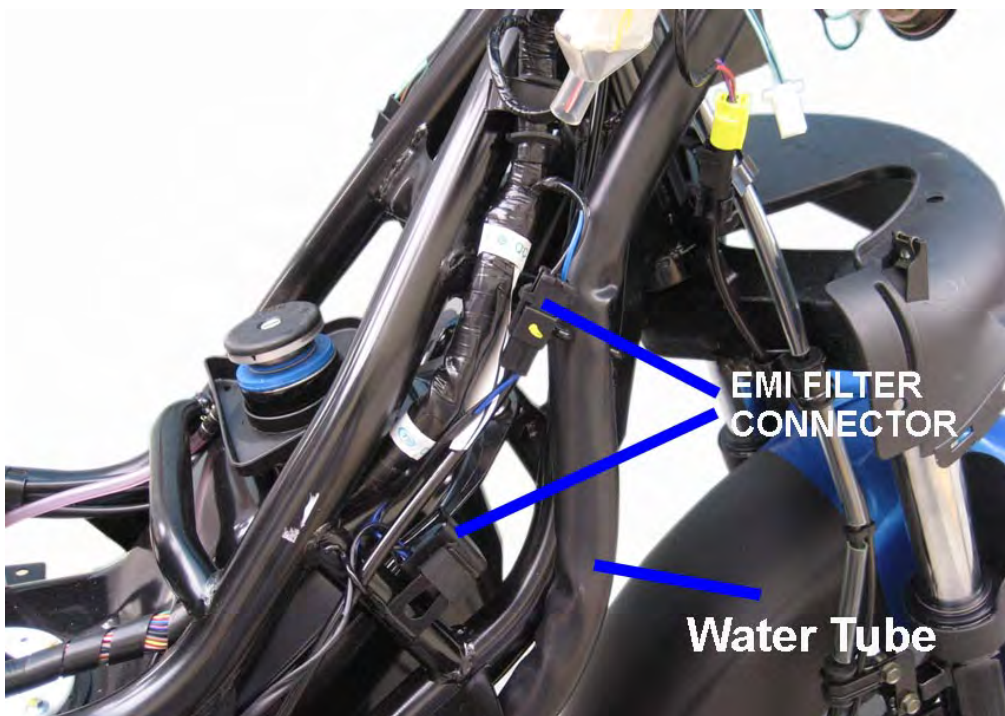
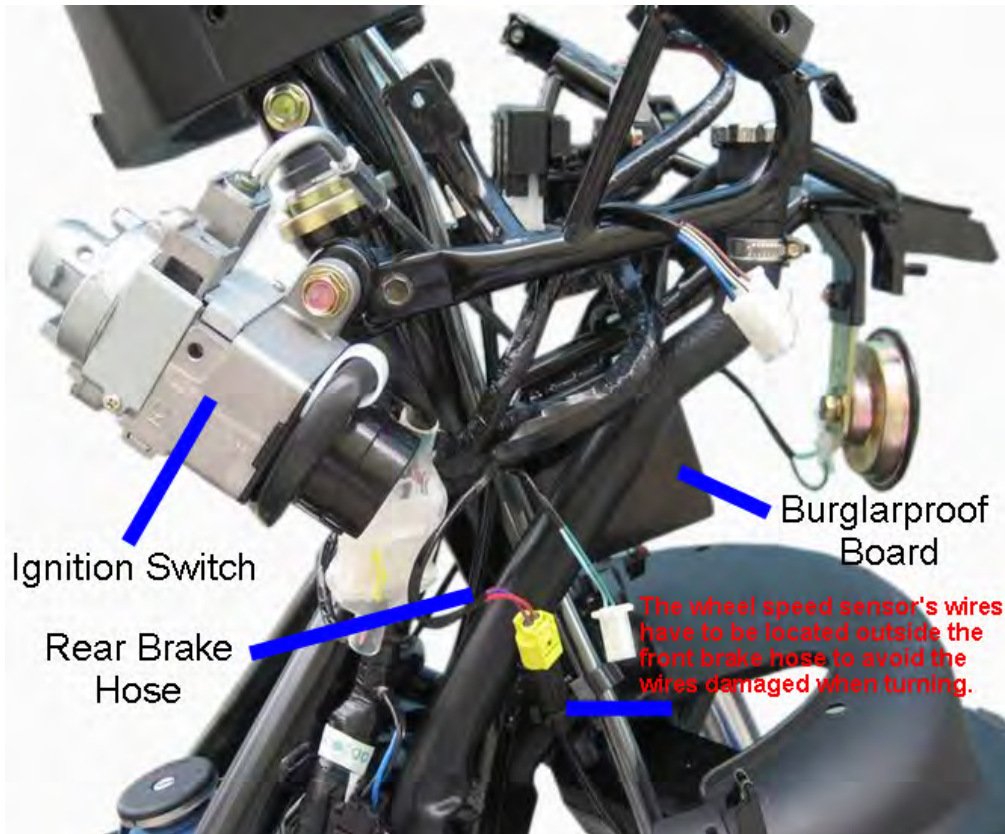

14. Quick Reference > Component Location

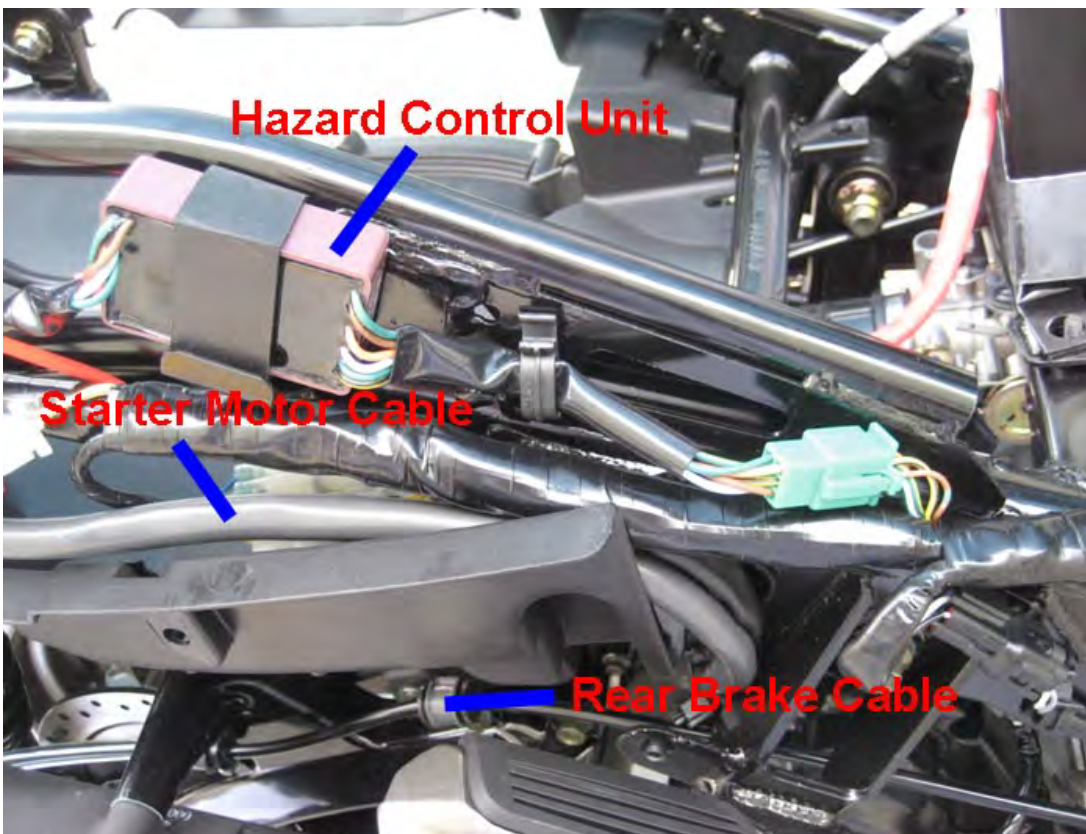
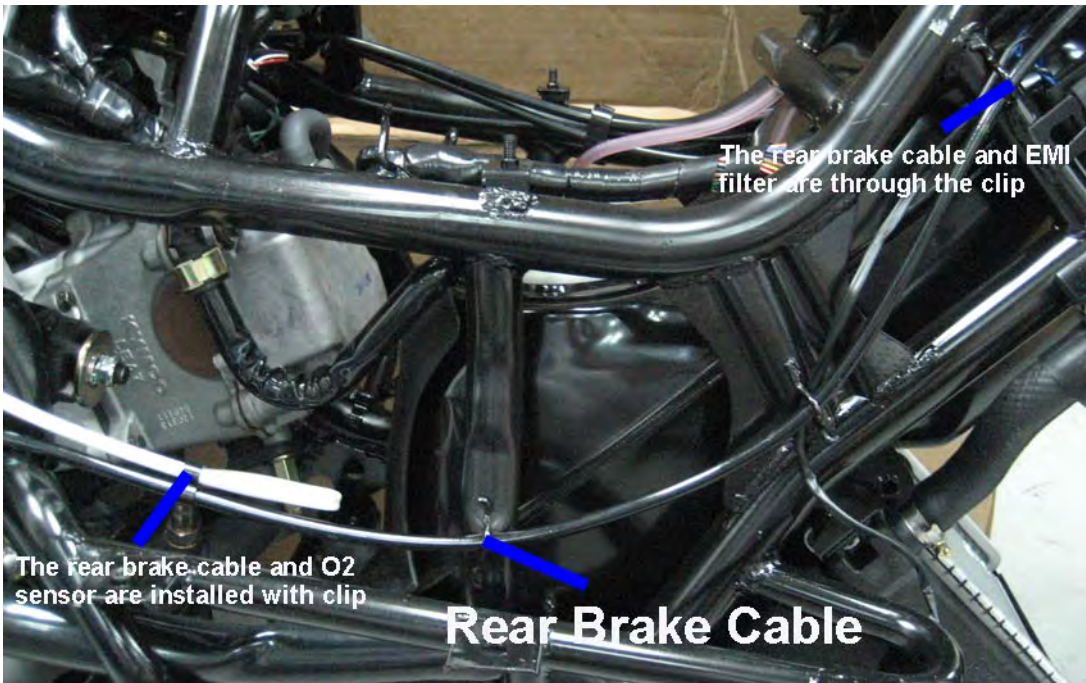

14. Quick Reference > Component Location

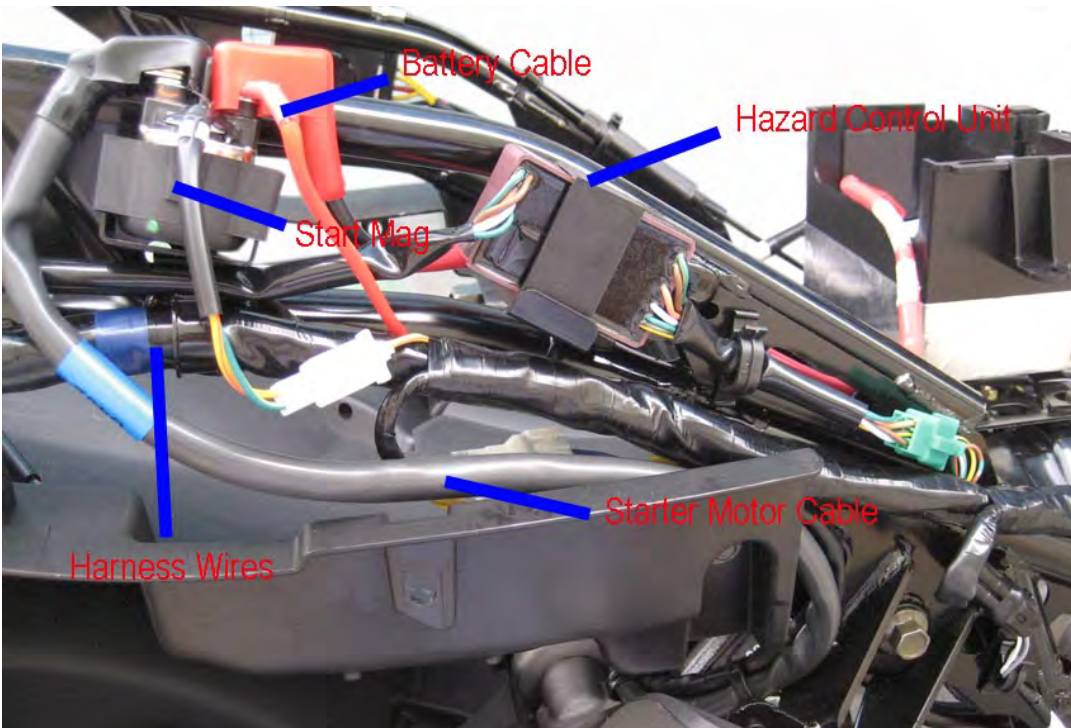
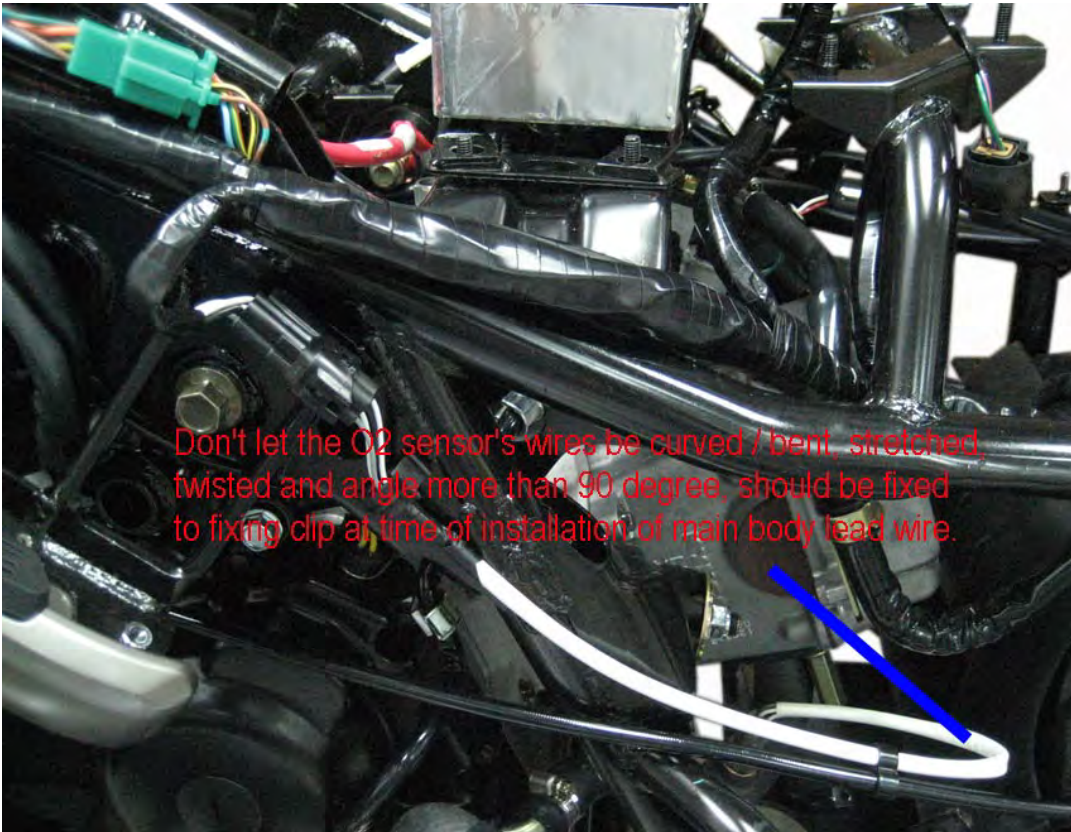

14. Quick Reference > Component Location

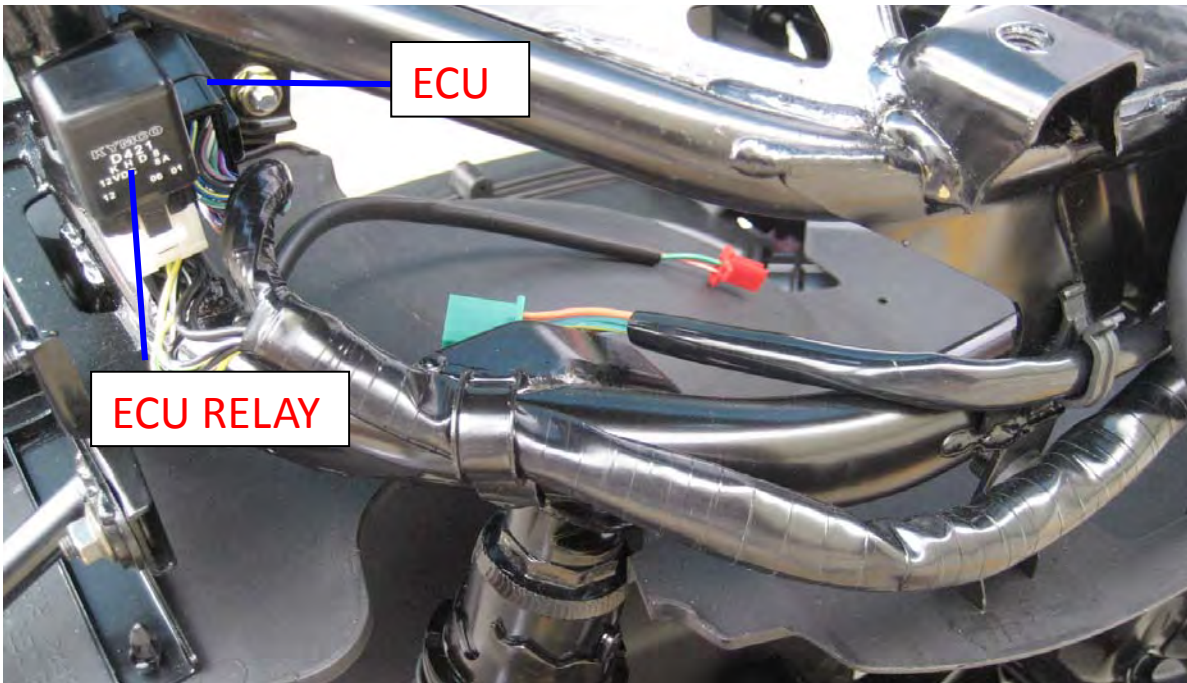

Special Tools

ITEM	TOOL NO	DESCRIPTION
FLYWHEEL PULLER	A120E00003	Flywheel removal
Puller (M28x1) TAPPET ADJUSTER	A120E00012	Adjusting valve clearance
OIL SEAL & BEARING DRIVER	A120E00014	General Driver Set
UNIVERSAL HOLDER	A120E00021	Holding clutch pulley and flywheel
#41 NUT AND FITTING TOOL	A120E00028	Clutch disassembly
THREAD PROTECTOR	A120E00029	Crankshaft thread protector
CYLINDER COMPRESSION GAUGE	A120E00039	Engine cylinder compression measure
FUEL PRESSURE GAUGE	A120E00048	Fuel pump output pressure measure
VALVE COTTER INSTALLER	A120E00051	Valve cotter installation
CLUTCH SPRING COMPRESSOR	A120E00053	Clutch disassembly
SHAFT COLLAR PULLER	A120E00088	Bearing crankcase installation
WIRES INJECTOR CONNECTOR	A120E00090	Injector cleaning for Keihin system
SHAFT COLLAR DRIVER	A120E00091	Bearing crankcase removal
SHAFT COLLAR INSTALLER	A120E00092	Bearing crankcase installation
BEARING PULLER	A120E00093	General Puller Set
VALVE CLEAN TOOL SET	A120E00096	Valve & Valve seat cleaning
STEERING STEM LOCK NUT WRENCH (32 mm)	A120F00002	Steering stem removal & installation
LOWER/UPPER RACE REMOVER & INSTALLER	A120F00008	Lower/Upper outer race installation
LOWER/UPPER OUTER RACE SEPARATOR	A120F00009	Lower/Upper outer race removal
STEERING STEM TOP THREAD WRENCH (46.5mm)	A120F00029	Steering stem removal & installation
PLIERS FUEL PIPE	A120F00031	Fuel pump output pressure measure & Injector cleaning
ELECTRIC REPAIR KIT	A120F00032	Troubleshooting electric system
DIGITAL ELECTRIC GAUGE	A120F00033	Troubleshooting electric system
RADIATOR PRESSURE GAUGE	A120F00035	Radiator pressure measure
USB LINKER	3620A-LGJ9-E00	Diagnostic tool software upgraded
POWER WIRES	32143-LGJ9-E00	Diagnostic tool power connection
INJECTOR CLEANER	32143-LEA7-9000	Injector cleaning

14. Quick Reference > Specifications
General Information

Name & Model No.		LKG7		
Motorcycle Name & Type		K-XCT300i		
Overall length (mm)		2145		
Overall width (mm)		800		
Overall height (mm)		1290		
Wheel base (mm)		1450		
Engine type		4 stroke OHC		
Displacement (cc)		298.9		
Fuel recommended		90 # unleaded gasoline		
Curb weight (kg)	Front wheel	76		
	Rear wheel	106.5		
	Total	182.5		
Max. weight capacity (kg)	Front wheel	138		
	Rear wheel	220		
	Total	358		
Tires	Front wheel	120/70-14		
	Rear wheel	150/70-13		
Ground clearance (mm)		140		
Performance	Braking distance (m)	7.9m / 40 km/hr		
	Min. turning radius (m)	2.6		
Engine	Starting system		Starting motor	
	Type		Gasoline, 4-stroke	
	Cylinder arrangement		SINGLE CYLINDER	
	Combustion chamber type		Semi-sphere	
	Valve arrangement		O.H.C. Chain drive	
	Bore x stroke (mm)		72.7 x 72	
	Compression ratio		10.8:1	
	Compression pressure		16 (kg/cm ²), 228 (psi)	
	Max. Horsepower		28 / 7750 PS/rpm	
	Max. Torque		2.7 / 6500 Kg-m/rpm	
	Valve timing	Intake	Open	9.5° BTDC
			Close	37.5° ABDC
		Exhaust	Open	40° BBDC
			Close	10° ATDC
	Valve clearance (cold) (mm)		Intake	0.10
			Exhaust	0.10
	Idle speed (rpm)		1600 ± 100	
Lubrication System	Lubrication type		Forced pressure & Wet pump	
	Oil pump type		Inner/outer rotor type	
	Oil filter type		Full-flow filtration	
	Oil capacity		1.5 liter	
Cooling Type		Liquid cooling		

14. Quick Reference > Specifications

Fuel System	Air cleaner type & No		Paper element, wet	
	Fuel capacity		12.5 liter	
	Injection	Brand	Keihin	
		Type	Throttle body	
		Venturi dia.(mm)	34	
Fuel pump pressure		3.0 Bar		
Electrical Equipment	Ignition System	Type	ECU	
		Ignition timing	10° BTDC at idle to 33° at 6500 rpm	
		Spark plug	Spec	CR7E (NGK)
	Gap		0.6-.7mm	
Battery Capacity		12V10AH		
Power Drive System	Clutch Type		Dry multi-clutch	
	Transmission Gear	Type	CVT	
		Operation	Automatic centrifugal type	
	Reduction Gear	Type	Two-stage reduction	
		Reduction ratio	1st	2.24 ~ 0.72
2nd			7.222	
Moving Device	Tire type		Tubeless	
	Wheel material		Aluminum	
	Tire pressure Kg/cm2 (psi)	Front	2.0 (28.4)	
		Rear	2.25 (32)	
	Handle turning angle(L/R)	Left	40°	
Right		40°		
Brake system type		Front	Wavy Disc brake	
		Rear	Disc brake	
Damping Device	Suspension type	Front	Telescope	
		Rear	Swing arm	
	Shock absorber stroke	Front	110 mm	
		Rear	93 mm	
Frame type		UNDER BONE		

ENGINE		
Throttle grip free play	2 ~ 6 mm	
Spark plug	NGK: CR7E	
Spark plug gap	0.6 mm ~ 0.7 mm	
Valve clearance	IN: 0.10 mm	EX: 0.10 mm
Idle speed	1600 ± 100 rpm	
Cylinder compression	16 ± 2 kg/cm2	228 ± 28.4 psi
Ignition timing	ECU	
Coolant type	Coolant type	
Engine oil capacity		
At disassembly	1.50 Liter	
At change with element oil filter	1.35 Liter	
Engine oil type:	SAE 5W50	
Gear oil capacity		
At disassembly	0.23 Liter	
At change	0.21 Liter	
Gear oil type:	SAE 90	

14. Quick Reference > Specifications

Coolant capacity	
Radiator	766 cc
Hose with cool coolant	169 cc
Hose with hot coolant	194 cc
Reserve tank	590 cc
Total capacity	1719 cc

Engine

Item		Standard (mm)
Valve clearance (cold)	IN	0.10
	EX	0.10
Cylinder head compression pressure		16 kg/cm ² , 228 psi
Camshaft cam heigh	IN	34.2987
	EX	34.1721
Valve rocker arm I.D	IN	10.00 - 10.015
	EX	10.00 - 10.015
Valve rocker arm shaft O.D	IN	9.972 - 9.987
	EX	9.972 - 9.987
Valve seat width	IN	1.2
	EX	1.2
Valve stem O.D	IN	4.990 - 4.975
	EX	4.970 - 4.955
Valve guide I.D	IN	5.00 - 5.012
	EX	5.00 - 5.012
Valve stem-to-guide clearance	IN	0.010 - 0.037
	EX	0.030 - 0.057

Item		Standard (mm)	
Cylinder	I.D.	72.7	
	Taper limit	0.05	
	Out of round limit	0.05	
Piston piston ring	Ring-to-groove clearance	Top	0.015 - 0.055
		Second	0.015 - 0.055
	Ring end gap	Top	0.10 - 0.25
		Second	0.10 - 0.25
		Oil side rail	0.2 - 0.7
	Piston O.D		
	Piston O.D. measuring point		9 mm from bottom of skirt
	Piston-to-cylinder clearance		0.101 - 0.040
Piston pin hole I.D.		15.002 - 15.008	
Piston pin O.D		14.994 - 15.000	
Piston-to-piston pin clearance		0.002 - 0.014	
Connecting rod small end I.D. Bore		15.016 - 15.034	

Item		Standard (mm)	Service Limit (mm)
Crankshaft	Connecting rod big end side clearance	0.15 - 0.35	0.6
	Connecting rod big end radial clearance	0 - 0.008	0.05

14. Quick Reference > Specifications

Bearing Color				
Crankcase mark				
Crankshaft mark	A	B	C	D
A	black	green	green	red
B	green	green	red	---

Item	Service Limit (mm)
Starter drive gear I.D	22.15
Starter drive gear O.D.	41.50

CVT

Item	Standard (mm)	Service Limit (mm)
Clutch lining thickness	4.0	2.0
Clutch outer I.D.	152.1 - 152.2	152.2
Weight roller O.D (Drive Pulley)	19.92 - 20.08	20.08

Cooling System

Radiator cap relief pressure	0.9 ± 0.15 kg/cm ² (12.8 ± 2.1 psi)	
Thermostat temperature	Begins to open	71 °C
	Full-open	80 °C
	Valve lift	3.5 - 4.5 mm
Coolant capacity	Total 1719 cc	Radiator: 766 cc Reserve tank: 590 cc Hose: 363 cc

COOLANT MIXTURE (WITH ANTI-RUST AND ANTI-FREEZING EFFECTS)			
Freezing Point	Mixing Rate	KYMCO SIGMA Coolant Concentrate	Distilled Water
-9°C	20%	344 cc	1375 cc
-15°C	30%	516 cc	1203 cc
-25°C	40%	688 cc	1031 cc
-37°C	50%	860 cc	859 cc
-44.5°C	55%	945 cc	774 cc

14. Quick Reference > Specifications

COOLANT GRAVITY CHART						
Temp. C° Coolant concentration	0	5	10	15	20	25
5%	1.009	1.009	1.008	1.008	1.007	1.006
10%	1.018	1.107	1.017	1.016	1.015	1.014
15%	1.028	1.027	1.026	1.025	1.024	1.022
20%	1.036	1.035	1.034	1.033	1.031	1.029
25%	1.045	1.044	1.044	1.042	1.040	1.038
30%	1.053	1.051	1.051	1.049	1.047	1.045
35%	1.063	1.065	1.060	1.058	1.056	1.054
40%	1.072	1.070	1.068	1.066	1.064	1.062
45%	1.080	1.078	1.076	1.074	1.072	1.069
50%	1.086	1.084	1.082	1.080	1.077	1.074
55%	1.095	1.093	1.091	1.088	1.085	1.082
60%	1.100	1.098	1.095	1.092	1.089	1.086

Temp. C° Coolant concentration	30	35	40	45	50
5%	1.005	1.003	1.001	0.009	0.99
10%	0.013	1.011	1.009	1.007	1.005
15%	1.020	1.018	1.016	1.014	1.012
20%	1.027	1.025	1.023	1.021	1.019
25%	1.036	1.034	1.031	1.028	1.025
30%	1.043	1.041	1.038	1.035	1.032
35%	1.052	1.049	1.046	1.043	1.040
40%	1.059	1.056	1.053	1.050	1.047
45%	1.056	1.063	1.062	1.057	1.054
50%	1.071	1.068	1.065	1.062	1.059
55%	1.079	1.076	1.073	1.070	1.067
60%	1.083	1.080	1.077	1.074	1.071

14. Quick Reference > Specifications

Fuel Injection System

ITEM		SPECIFICATIONS
Throttle body identification number		LKG7
Idle speed		1600 ± 100 rpm
Throttle grip free play		2 - 6 mm (1/16 - 1/4 in)
Fuel injector resistance (at 20°C/68°F)		11.7 ± 0.6 Ω
Fuel pump resistance(at 20°C/68°F)	Float at full position	1100 ± 33 Ω
	Float at empty position	100 ± 3 Ω
Fuel pump standard pressure (at 40L/Hr)		294 ± 6 kPa (3 Bar)
Water temperature sensor resistance	At -20°C/-4°F	18.8 KΩ
	At 40°C/104°F	1.136 KΩ
	At 100°C/212°F	0.1553 KΩ
Intake pressure sensor (MAP) pressure(at 1 - 4.2 V)	13.332 kPa (0.13332 kgf/ cm ² , 1.89 psi) - 119.99 KPa (1.1999 kgf/ cm ² , 17.04 psi)	
Inductive ignition coil		Primary: 3.57 - 4.83Ω Secondary: 10.42~14.49KΩ
Throttle position sensor (TPS) resistance (at 20°C/68°F)		3500 - 6500
Crank position sensor voltage (at 200rpm)		100 - 130
O2 heater sensor resistance (at 20C/68°F)		6.7 - 9.5 (engine warming condition)
Tilt switch voltage	Standard	0.4 - 1.4 V
	Over 65° (fall down)	3.7 - 4.4 V

14. Quick Reference > Specifications

CELP FAILURE CODES LIST				
Failure	Codes	Contents	Causes	Symptoms
06	P0120	Faulty TPS	<ul style="list-style-type: none"> • Faulty TPS voltage range (0.3 -4.5 V) • Loose or poor connection on TPS Sensor • Open or short circuit on the TP Swire • Faulty TPS itself 	Engine operates normally
09	P0105	Faulty MAP	<ul style="list-style-type: none"> • Faulty MAP voltage range (1 - 4.2V) • Loose or poor connection on MAP Sensor • Open or short circuit on MAP wire • Faulty MAP itself 	Engine operates normally
12	P0115	Faulty WTS (water temp.)	<ul style="list-style-type: none"> • Faulty ECT range (-20°C: 18.8 /40°C: 1.136/100°C: 0.1553) • Loose or poor connection on ECT • Open or short circuit on ECT wire • Faulty ECT 	Engine operates normally
15	P1630	Faulty Tilt switch (Roll)	<ul style="list-style-type: none"> • Faulty Tilt switch voltage range (inclined angle <65°: 0.4 - 1.4 V/ Inclined angle >65°: 3.7 - 4.4 V) • Loose or poor connection on Tilt switch • Open or short circuit in Tilt switch wire • Faulty tilt switch 	Engine operates normally
17	P0130	Faulty O2 sensor	<ul style="list-style-type: none"> • Faulty O2 sensor voltage range(A/F below 14.7: > 0.7V/ A/F over14.7: < 0.18 V) • Loose or poor connection on O2 sensor • Open or short circuit on O2 sensor wire • Faulty O2 sensor 	Engine operates normally
33	P0201	Faulty injector (Nozzle)	<ul style="list-style-type: none"> • Faulty Fuel injector range(9.945 - 13.5) • Loose or poor connection on injector • Open or short circuit on injector wire • Faulty fuel injector 	Engine fails to be operated
37	P0351	Faulty inductive ignition coil	<ul style="list-style-type: none"> • Faulty Inductive ignition coil !range (4.2 ! ± 15%) • Loose or poor connection on inductive ignition coil • Open or short circuit on inductive ignition coil wire • Faulty inductive ignition coil 	Engine fails to be operated
41	P0230	Faulty fuel pump	<ul style="list-style-type: none"> • Faulty Fuel pump fl range (F:1100 ± 33 ! E: 100 + 3 !) • Loose or poor connection on fuel pump • Open or short circuit on fuel pump wire • Faulty fuel pump 	Engine fails to be operated
45	P0135	Faulty O2 sensor heater	<ul style="list-style-type: none"> • Faulty O2 sensor heater ! range(6.7 -9.5 !) • Loose or poor connection on O2 sensor heater • Open or short circuit on O2 sensor heater wire • Faulty O2 sensor heater 	Engine starts normally but not smooth
49	P1505	Faulty ISC	<ul style="list-style-type: none"> • Loose or poor contacts on ISC • Open or short circuit in ISC wire • Faulty ISC 	Engine operates normally
66	P0335	Faulty CPS	<ul style="list-style-type: none"> • Loose or poor connection on CPS sensor • Open or short circuit on CPS wire • Faulty CPS sensor 	Engine starts normally but not smooth

14. Quick Reference > Specifications

Axle/Brakes/Wheels

Item	Standard mm (in)	Service Limit
Axle shaft run out	–	0.2 mm(0.008 in)
Brake disk thickness (front)	3.8 - 4.2(0.15 - 0.165)	0.3 mm(0.012 in)
Brake disk thickness (rear)	5.0 (0.2	–
Brake disk run out	–	0.4 mm
Brake master cylinder I.D	12.7 - 12.74(0.508 - 0.5096)	–
Brake master cylinder piston O.D.	12.65 - 12.68(0.506 - 0.5072)	–
Front brake caliper piston O.D	26.93 - 26.96(1.0602 - 1.0614)	–
Front brake caliper cylinder I.D	27 - 27.05(1.063 - 1.065)	–

Item	Standard (mm)
Wheel rim run out service limit	max 5
Rear brake disk thickness	5.0
Rear brake disk run out	max 0.4
Rear brake caliper piston O.D.	25.33 - 25.36
Rear brake caliper cylinder I.D.	25.40 - 25.45

Electrical

Item		Standard	
Battery	Capacity	12V 10AH	
	Voltage (20°C)	Fully charged	13.2V
		Insufficient charged	< 12.3V
	Charging current	1.2A* 5 - 10H	

14. Quick Reference > Specifications

Item		Standard
Spark plug	Standard type	NGKCR7E
Spark plug gap		0.6 - 0.7 mm
Inductive Ignition Coil	Primary coil	3.57 - 4.83 Ω
	Secondary coil without plug cap	10.42 - 14.49 KΩ
Throttle Position Sensor		3500 - 6500 Ω
Fuel Injector		1.9 9 approx.
Water Temperature Sensor		2.076 K9 ± 10% (25°C)
Oxygen Sensor (engine warming condition)		6.7 9 - 9.5 Ω
Crank Position Sensor		115 9 ± 15 Ω
Tilt Switch		0.4V - 1.4V(normal) 3.7V - 4.4V (fall down)
Water temperature sensor resistance	At -20°C/-4°F	18.8 KΩ
	At 40°C/104°F	1.136 KΩ
	At 100°C/212°F	0.1553 KΩ

Item	Standard	Service Limit
Starter motor brush length	12.5 mm	8.5 mm
Fuse	10A,15A,30A	
Headlight bulb	12V 35W/35W *2	
Turn signal light bulb	12V 21 W(Front) / 10W(Rear)	
Stoplight/taillight	12V2W/0.2W LED	

14. Quick Reference > Torque Specifications

Torque Specifications

ENGINE					
Item	Qty	Thread size (mm)	Torque		Remarks
			kgf-m	lb-ft	
Cylinder head stud bolt					
1. Stud bolt (Inlet pipe side)	2	6	0.7-1.1	5.06-7.96	Double end bolt
2. Stud bolt (EX pipe side)	2	8	0.7-1.1	5.06-7.96	Double end bolt
Cylinder head stud nut	4	10	3.4-3.8	24.59-27.48	
Right crankcase cover bolt	15	6	1.0-1.4	7.23-10.13	
Left crankcase cover bolt	15	6	1.0-1.4	7.23-10.13	
Transmission case bolts	9	8	0.8-1.2	1.7-2.6	
Bolt B stud 10*180	4	10	1.0-1.4	7.23-10.	Apply oil to
thread Valve adjusting lock nut	4	5	0.7-1.1	5.06-7.96	Apply oil to
thread Cam sprocket bolt	2	6	1.0-1.4	7.23-10	Apply thread
lock Camshaft set plate bolt	1		1.2	2.0	Apply thread lock
Final drive oil check\drain bolt	2	8	0.8-1.2	5.79-8.68	
Engine oil drain bolt	1	12	2.0-3.0	14.47-21.70	
Engine oil strainer cap	1		1.02	7.2	
Clutch outer nut (driven pulley)	1	12	5.0-6.0	36.17-43.40	
Starter motor mounting bolt	2	6	1.0-1.4	7.23-10.13	
Mission case bolt	6	8	1.8-2.2	13.02-15.91	
Drive face nut	1	14	9.0-10.0	65.10-72.33	Apply oil to thread
Clutch drive plate nut	1		7.5	55.32	
Drive plate comp	1	28	5.0-6.0	36.17-43.40	
Cam chain tensioner bolt	2	6	1.0-1.4	7.23-10.13	
Cam chain tensioner pivot	1	8	0.8-1.2	5.79 - 8.68	
One way clutch bolt	3	8	1.8-2.2	13.02-15.91	Apply thread lock
ACG flywheel nut	1	14	5.5-6.5	39.78-47.01	
Spark plug	1	12	1.5-2.0	10.84-14.47	
Water pump impeller	1	7	1.0-1.4	7.23-10.13	Left thread
Water pump cover bolts	4	6	1.0-1.4	7.23-10.13	

14. Quick Reference > Torque Specifications

K- XCT 300i

FRAME					
Item	Qty	Thread size (mm)	Torque		Remarks
			kgf-m	lb-ft	
Steering:					
1. Stem lock nut	1	BC1	6.0-6.5	43.20-46.8	
2. Handle post bolt	1	10	4.0-5.0	28.93-36.17	U-nut
3. Bridge bolt	1	8	2.4-3.0	17.36-21.70	
4. Race nut (head)	1	BC1	1.8-2.2	13.02-15.91	
Brake:					
1. Front/Rear caliper bolt	1	10	3.0-4.0	21.70-28.93	
2. Brake hose bolt	1	10	3.0-4.0	21.70-28.93	
3. Disk bolt	5	8	3.2-3.8	23.15-27.48	
Engine hanger:					
1. Frame side	2	14	6.0-7.0	43.40-50.63	U-nut
2. Engine side	1	10	4.5-5.5	32.55-39.78	U-nut
Rear fork bolt	2	10	3.0-4.0	21.70-28.93	
Speed sensor cable	1	6	1.0-1.4	7.23-10.13	
O2 sensor	1	12	2.0-3.0	14.47-21.70	
Rear carrier	4	8	2.0-2.8	14.47-20.25	
Front axle	1	14	1.5-2.5	10.84-18.08	
Rear axle nut	1	16	11-13	79.56-94.03	U-nut
Rear cushion upper/lower bolt	2	10	3.5-4.5	25.32-32.55	
Suspension:					
Shock absorber mounting bolt			4	28.93	
Fuel Pump Bolts	6		0.35	2.5	

General Torque Specifications

Item	Torque	
	kgf-m	lb-ft
5 mm bolt, nut	0.45 - 0.6	3.25 - 4.34
6 mm bolt, nut	0.8 - 1.2	5.79 - 8.68
8 mm bolt, nut	1.8 - 2.5	13.02 - 18.08
10 mm bolt, nut	3.0 - 4.0	21.70 - 28.93
12 mm bolt, nut	5.0 - 6.0	36.17 - 43.40
5 mm screw	0.45 - 0.6	3.25 - 4.34
6 mm screw, SH bolt	0.7 - 1.1	5.06 - 7.96
6 mm flange bolt, nut	1.0 - 1.4	7.23 - 10.13
8 mm flange bolt, nut	2.4 - 3.0	17.36 - 21.70
10 mm flange bolt, nut	3.0 - 4.5	21.70 - 32.55

Troubleshooting

Vehicle can not be started

Preliminary 6 Step Inspection

1. Is the battery fully charged (12V or higher). See the Battery topic for more information.
2. Key-On and listen for any action with Fuel Pump / Fuel Pump Relay (It will turn off automatically in 5-10 seconds)
3. Key-On to check for any failure lamp light up on dashboard. See the Self-Diagnosis topic for more information.
4. Is the Idle screw of Throttle Valve being changed or loosed?
5. Has the vehicle under regular service? Is the gas station a good one?
6. Is the spark plug the correct model of specified by the vehicle builder?

Troubleshooting by section

- Brakes
- Cooling System
- CVTContinuouslyVariable Transmission
- Electrical Systems
- Engine
- FinalDrive
- FrontSuspension
- FuelInjectionSystem
- Rear Suspension
- Steering
- Wheels

14. Troubleshooting

General Troubleshooting

ENGINE WILL NOT START OR IS HARD TO START

Possible cause

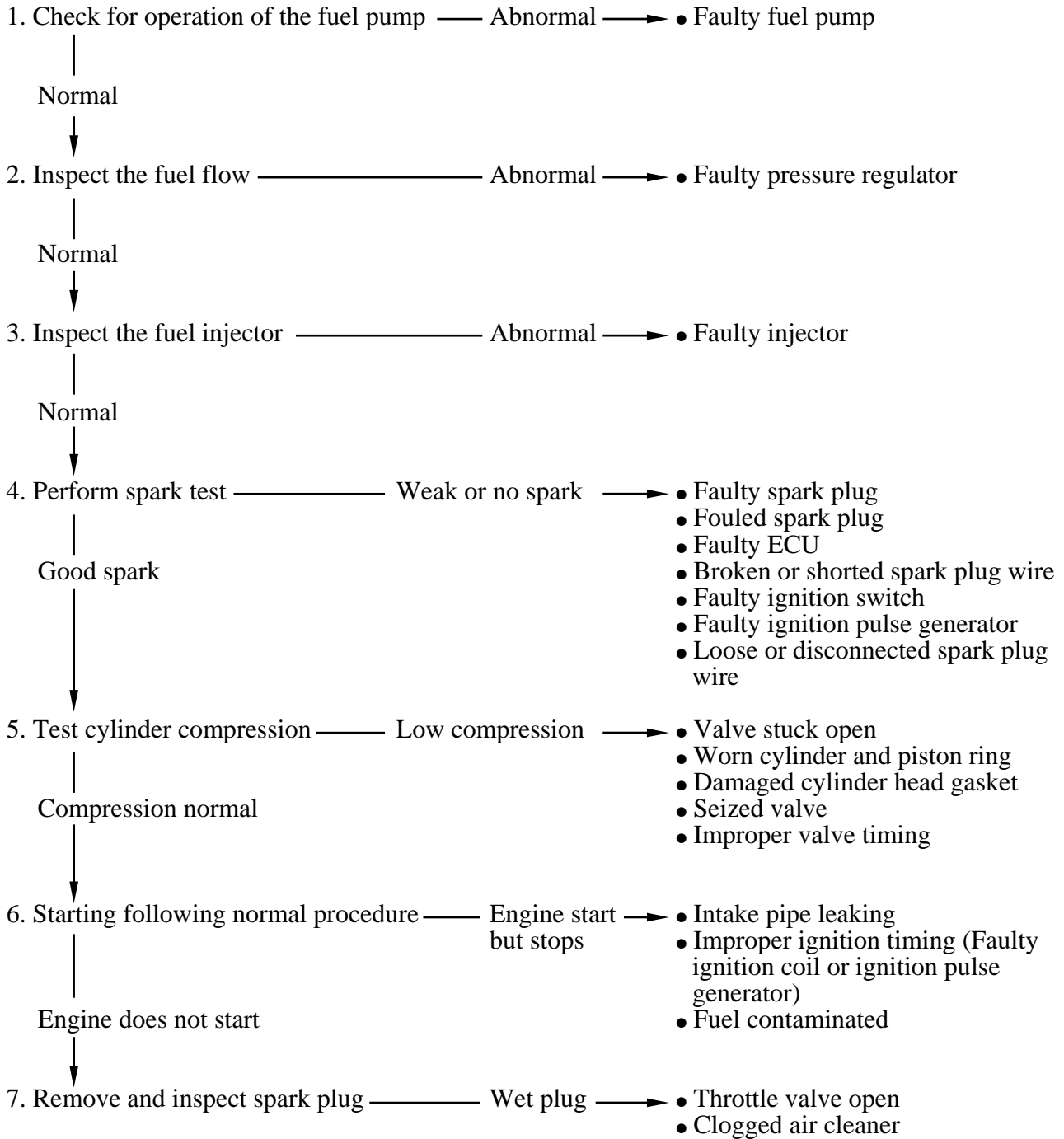

14. Troubleshooting

ENGINE LACKS POWER

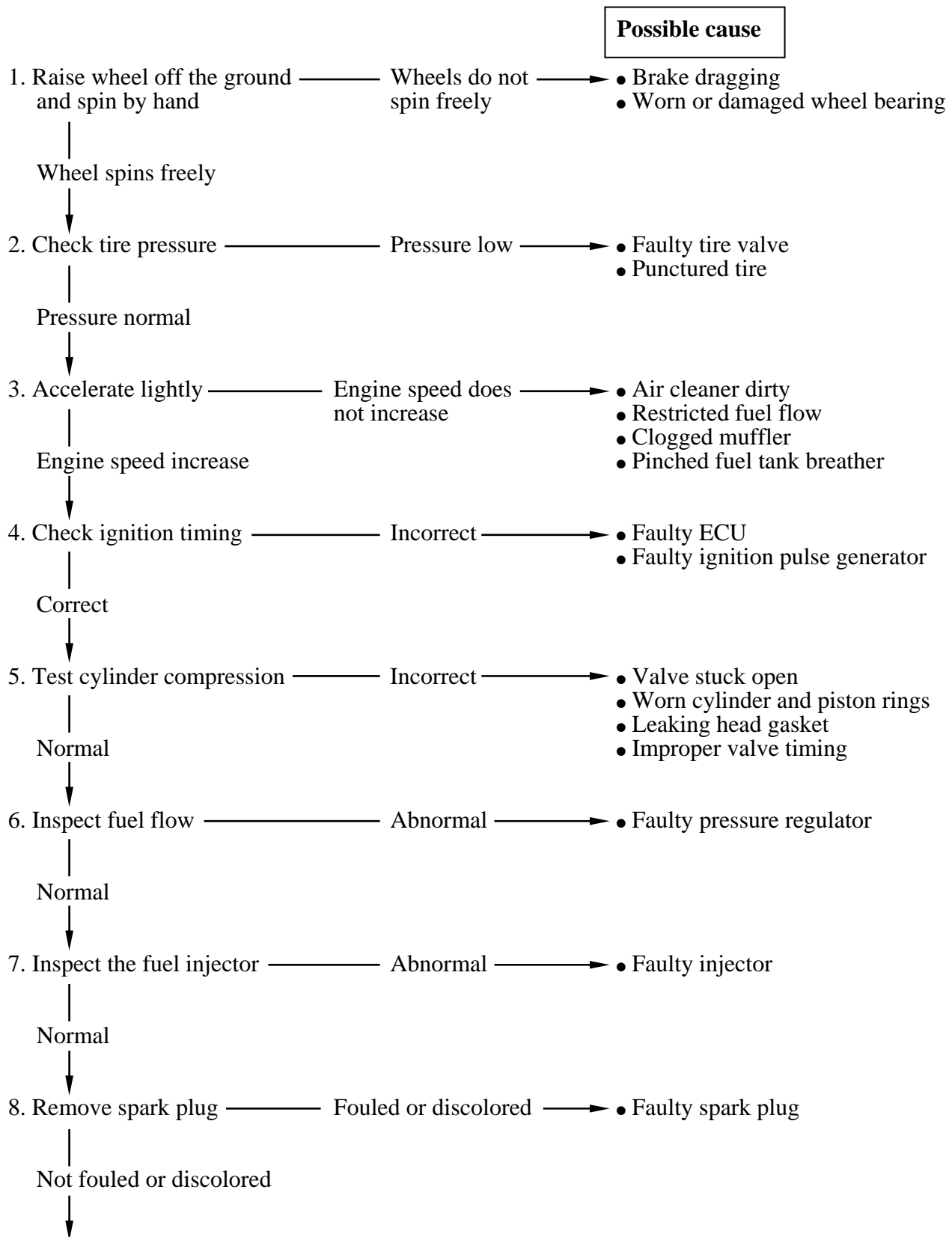

14. Troubleshooting

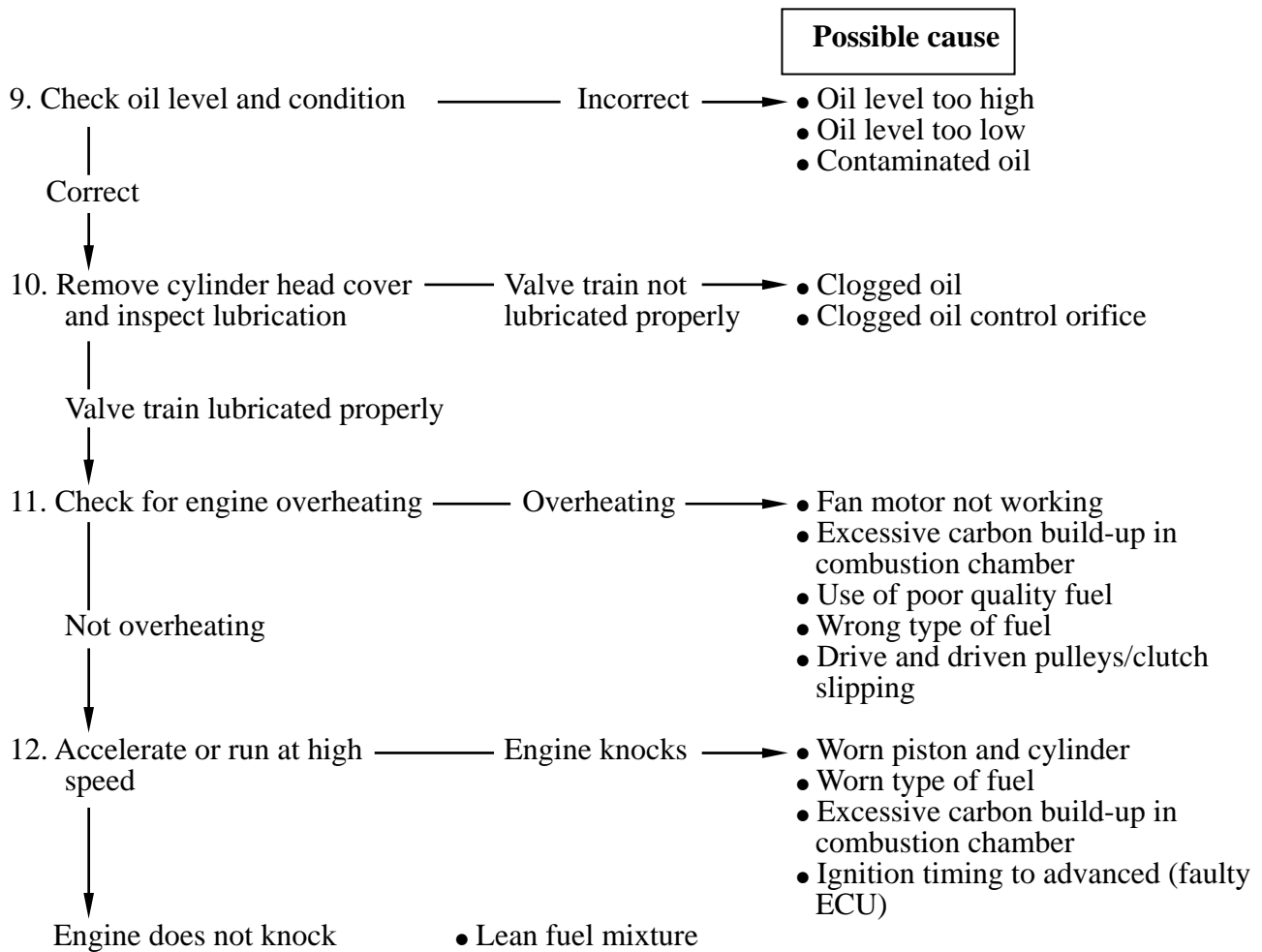

14. Troubleshooting

POOR PERFORMANCE AT LOW AND IDLE SPEED

Possible cause

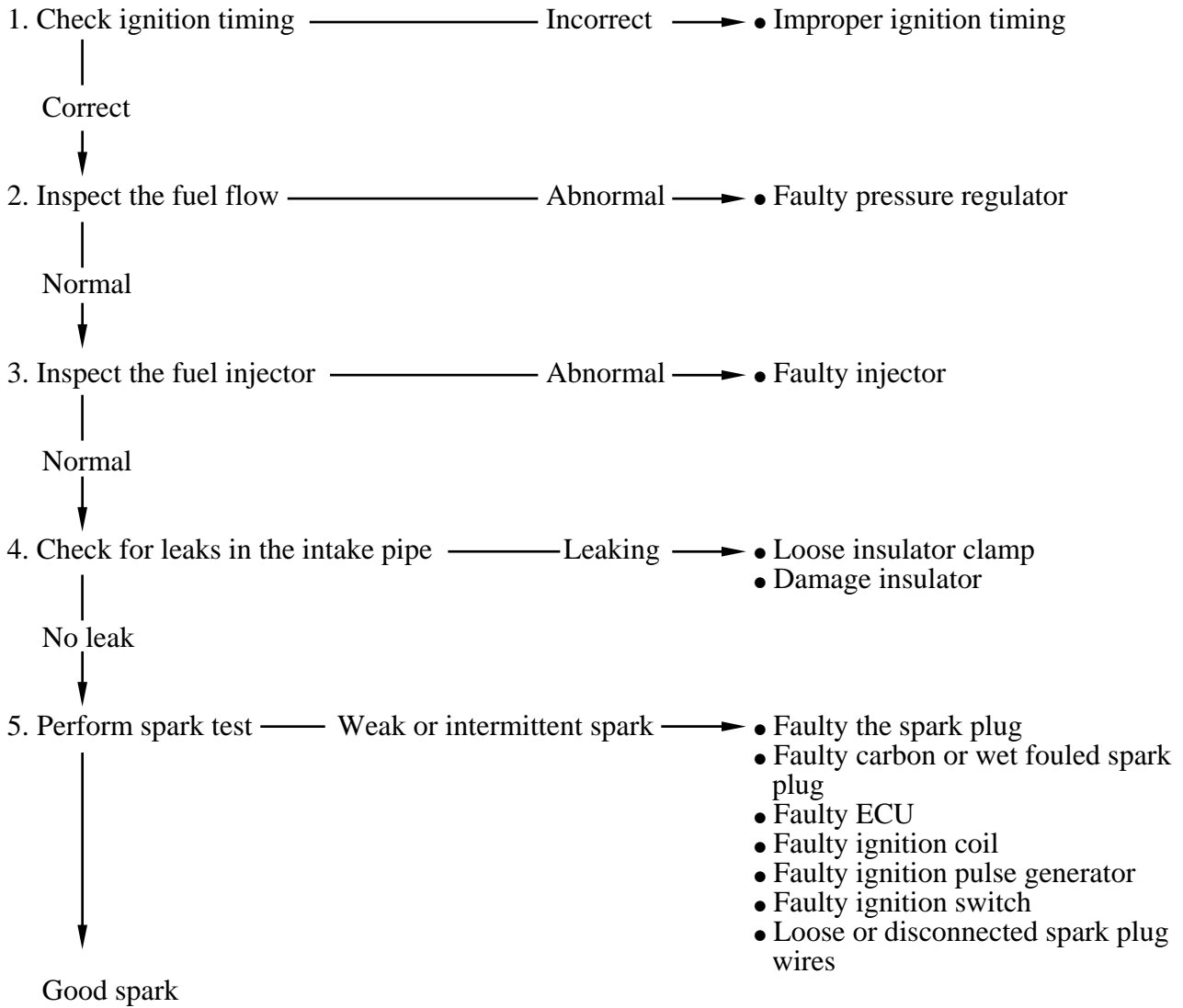

14. Troubleshooting
POOR PERFORMANCE AT HIGH SPEED

Possible cause

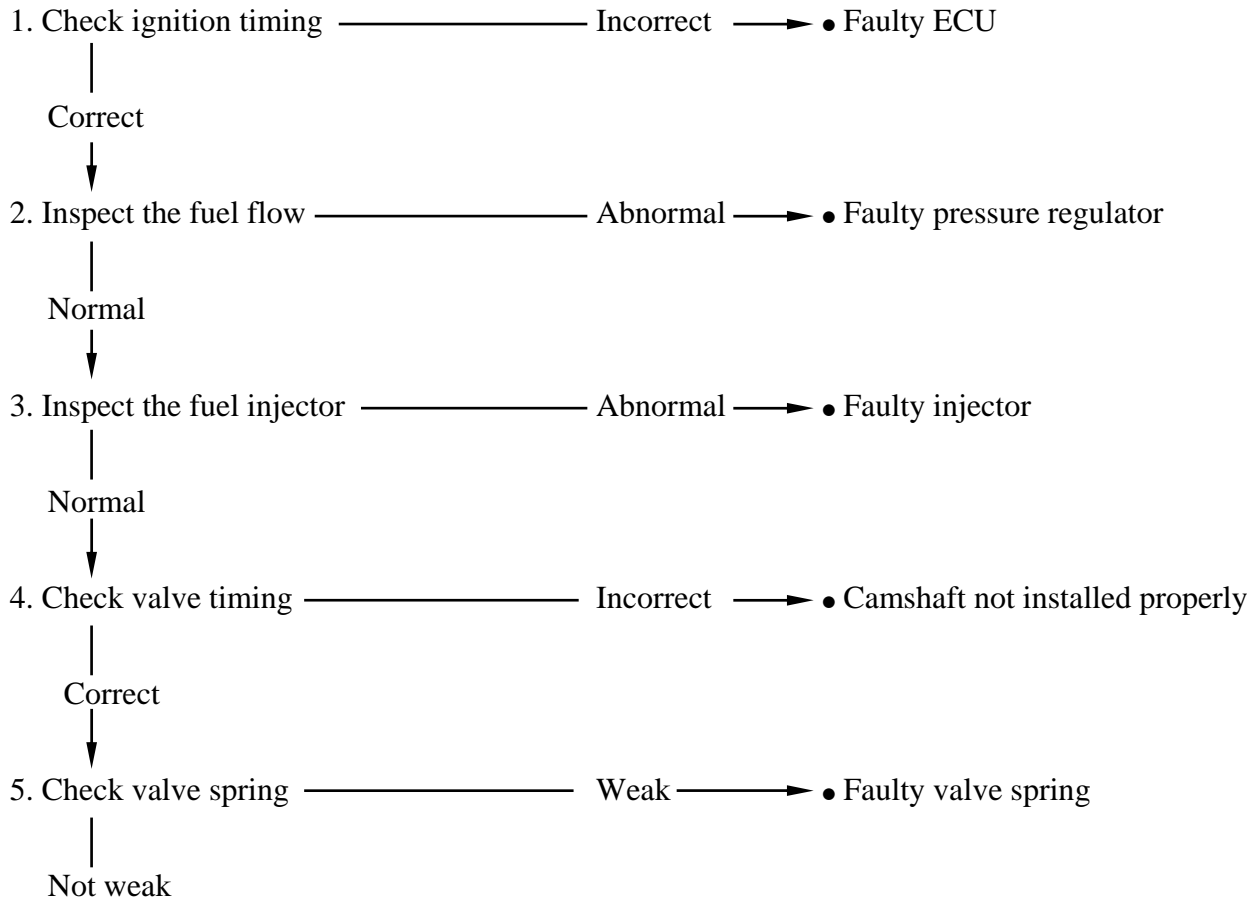
POOR HANDLING

Possible cause

- | | |
|--|--|
| 1. If steering is heavy —————> | • Steering stem adjusting nut too tight
• Damaged steering head bearings |
| 2. If either wheel is wobbling —————> | • Excessive wheel bearing play
• Bent rim
• Improper installed wheel hub
• Swing arm pivot bearing excessively worn
• Bent frame |
| 3. If the motorcycle pulled to one side —————> | • Faulty the shock absorber
• Front and rear wheel not aligned
• Bent fork
• Bent swing arm
• Bent axle |

14. Quick Reference > VIN and Engine Number Location

VIN and Engine Number Location



The VIN is stamped on a plate on the lower right side.



The engine serial number is stamped on bottom of the left crankcase.

14. Quick Reference > VIN and Engine Number Location



The VIN is also stamped on the frame inside of the luggage box.