**By KWANG YANG Motor Co., Ltd.
First Edition, Jan 2006
All rights reserved. Any reproduction or
unauthorized use without the written permission of
KWANG YANG Motor Co., Ltd.
is expressly prohibited.
T100LB10DE**

PREFACE

This Service Manual describes the technical features and servicing procedures for the KYMCO *MXU 50 REVERSE/MXU 50/MX'ER 50*.

Section 1 contains the precautions for all operations stated in this manual. Read them carefully before starting any operation.

Section 2 is the removal/installation procedures for the frame covers which are subject to higher removal/installation frequency during maintenance and servicing operations.

Section 3 describes the inspection/adjustment procedures, safety rules and service information for each part, starting from periodic maintenance.

Sections 4 through 19 give instructions for disassembly, assembly and inspection of engine, chassis frame and electrical equipment.

Most sections start with an assembly or system illustration and troubleshooting for the section. The subsequent pages give detailed procedures for the section.

The information and contents included in this manual may be different from the ATV in case specifications are changed. KYMCO reserves the right to make changes at any time without notice and without incurring any obligation.

TABLE OF CONTENTS

ENGINE	GENERAL INFORMATION	1
	FRAME COVERS/EXHAUST MUFFLER	2
	INSPECTION/ADJUSTMENT	3
	LUBRICATION SYSTEM	4
	FUEL SYSTEM	5
	ENGINE REMOVAL/INSTALLATION	6
	CYLINDER HEAD/CYLINDER/PISTON	7
	A.C. GENERATOR	8
	KICK STARTER/DRIVE PULLEY/CLUTCH/DRIVEN PULLEY	9
	FINAL REDUCTION (MXU 50/MX'ER 50)	10
	FINAL REDUCTION/TRANSMISSION SYSTEM (MXU 50 REVERSE)	11
	CRANKCASE/CRANKSHAFT	12
CHASSIS	FRONT WHEEL/FRONT BRAKE/FRONT SUSPENSION/STEERING SYSTEM	13
	REAR WHEEL /SWING ARM/HYDRAULIC BRAKE	14
ELECTRICAL EQUIPMENT	BATTERY/CHARGING SYSTEM/A.C. GENERATOR	15
	IGNITION SYSTEM	16
	STARTING SYSTEM	17
	LIGHTS/SWITCHES	18
	ONLY ATV ON ROAD AVAILABLE	19

KWANG YANG MOTOR CO., LTD.
OVERSEAS SALES DEPARTMENT
OVERSEAS SERVICE SECTION

1. GENERAL INFORMATION

1. GENERAL INFORMATION

SERIAL NUMBER

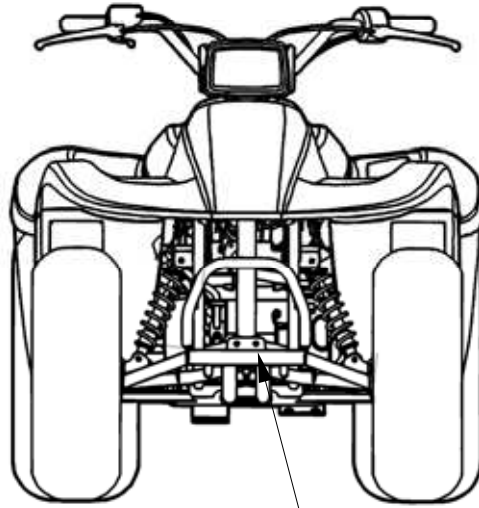

Location of Frame Serial Number



Location of Engine Serial Number

1. GENERAL INFORMATION

Engine	e		Semi-sphere	
	Valve arrangement		Reed valve & piston	
	Bore x stroke		39 x 41.4 mm (1.56 x 1.656 in)	
	Compression ratio		7.2:1	
	Compression pressure		12 kgf/cm ² (1200 kPa, 170.4 psi)	
	Port timing	Intake	Open	Automatic controlled
			Close	
	Port timing	Exhaust	Open	Automatic controlled
			Close	
	Valve clearance	Intake	—	
		Exhaust	—	
	Idle speed (rpm)		1800	
	Lubrication type		Separate type	
	Oil pump type		Plunger type	
	Oil filter type		Full-flow filtration	

Fuel System	Air cleaner type		Sponge	
	Fuel capacity		8.1 liters	
	Carburetor	Type		PB
		Main jet No.		80
		Venturi dia		φ14 mm (φ0.56 in)
Throttle type		Valve piston		
Electrical Equipment	Ignition System	Type		CDI
		Ignition timing		22°/2000 rpm
		Spark plug		NGK-BR8HAS
		Spark plug gap		0.6~0.7mm
	Battery	Capacity		12V4AH
Power Drive System	Clutch	Type		CVT
	Operation		Automatic centrifugal Type	
	Reduction Gear	Type		Chain drive
		Reduction ratio	1st	—
			2nd	—
	Final gear ratio		23.678	
Moving Device	Front Axle	Caster angle		—
	Front Axle	Trail length		—
	Tire pressure	Front	0.35 kgf/cm ² (35 kPa, 4.97 psi)	
		Rear	0.35 kgf/cm ² (35 kPa, 4.97 psi)	
	Turning angle	Left	44°	
Right		44°		
Brake system type	Rear	Disk brake		
	Front	Drum brake		
Damping Device	Suspension type	Front	Swing	
		Rear	Swing arm	
	Shock type	Front	Swing	
		Rear	Swing arm	
Frame type		SP pipe		

1. GENERAL INFORMATION

Engine			e	Semi-sphere
	Valve arrangement		Reed valve & piston	
	Bore x stroke		39 x 41.4 mm (1.56 x 1.656 in)	
	Compression ratio		7.2:1	
	Compression pressure		12 kgf/cm ² (1200 kPa, 170.4 psi)	
	Port timing	Intake	Open	Automatic controlled
			Close	
	Exhaust	Open	Automatic controlled	
		Close		
	Valve clearance		Intake	—
			Exhaust	—
	Idle speed (rpm)		1800	
	Lubrication type		Separate type	
	Oil pump type		Plunger type	
Oil filter type		Full-flow filtration		

Fuel System	Air cleaner type		Sponge		
	Fuel capacity		8.1 liters		
	Carburetor	Type		PB	
		Main jet No.		80	
		Venturi dia		φ14 mm (φ0.56 in)	
Throttle type		Valve piston			
Electrical Equipment	Ignition System	Type		CDI	
		Ignition timing		22°/2000 rpm	
		Spark plug		NGK-BR8HAS	
		Spark plug gap		0.6~0.7mm	
	Battery	Capacity		12V8AH	
Power Drive System	Clutch	Type		CVT	
	Operation		Automatic centrifugal Type		
	Reduction Gear	Type		Chain drive	
		Reduction ratio	1st	—	
			2nd	—	
	Final gear ratio		23.678		
Moving Device	Front Axle	Caster angle		—	
		Trail length		—	
	Tire pressure		Front	0.28 kgf/cm ² (28 kPa, 4 psi)	
			Rear	0.28 kgf/cm ² (28 kPa, 4 psi)	
	Turning angle	Left	40°		
Right		40°			
Brake system type		Rear	Disk brake		
		Front	Drum brake		
Damping Device	Suspension type		Front	Swing	
			Rear	Swing arm	
	Shock type		Front	Swing	
Rear			Swing arm		
Frame type		SP pipe			

1. GENERAL INFORMATION

Engine	e		Semi-sphere	
	Valve arrangement		Reed valve & piston	
	Bore x stroke		39 x 41.4 mm (1.56 x 1.656 in)	
	Compression ratio		7.2:1	
	Compression pressure		12 kgf/cm ² (1200 kPa, 170.4 psi)	
	Port timing	Intake	Open	Automatic controlled
			Close	
	Exhaust	Open	Automatic controlled	
				Close
	Valve clearance		Intake	—
			Exhaust	—
	Idle speed (rpm)		1800	
	Lubrication type		Separate type	
	Oil pump type		Plunger type	
Oil filter type		Full-flow filtration		

Fuel System	Air cleaner type		Sponge	
	Fuel capacity		8.1 liters	
	Carburetor	Type		PB
		Main jet No.		80
		Venturi dia		φ14 mm (φ0.56 in)
Throttle type		Valve piston		
Electrical Equipment	Ignition System	Type		CDI
		Ignition timing		13.5°/1500 rpm
		Spark plug		NGK-BR8HAS
		Spark plug gap		0.6~0.7mm
	Battery	Capacity		12V8AH
Power Drive System	Clutch	Type		CVT
	Operation		Automatic centrifugal Type	
	Primary reduction system		Helical gear/spur gear	
	Secondary reduction system		Chain drive	
	Primary reduction ratio		1.2 – 3.5	
	Secondary reduction ratio		20.12	
	Reverse ratio		46.11	
Moving Device	Front Axle	Caster angle		—
	Axle	Trail length		—
	Tire pressure	Front	0.28 kgf/cm ² (28 kPa, 4 psi)	
		Rear	0.28 kgf/cm ² (28 kPa, 4 psi)	
	Turning angle	Left	40°	
Right		40°		
Brake system type	Rear	Disk brake		
	Front	Drum brake		
Damping Device	Suspension type	Front	Swing	
		Rear	Swing arm	
	Shock type	Front	Swing	
		Rear	Swing arm	
Frame type		SP pipe		

1. GENERAL INFORMATION

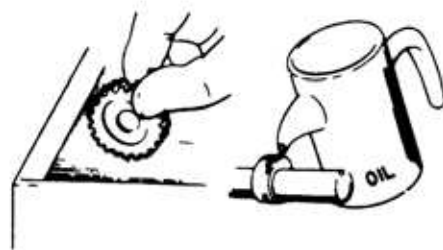
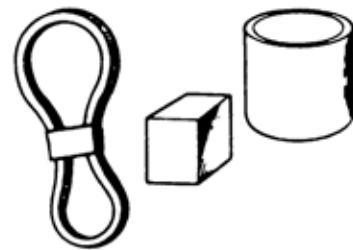
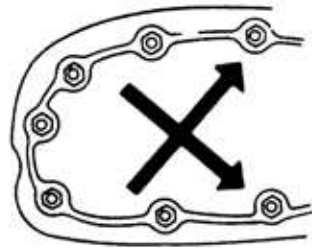
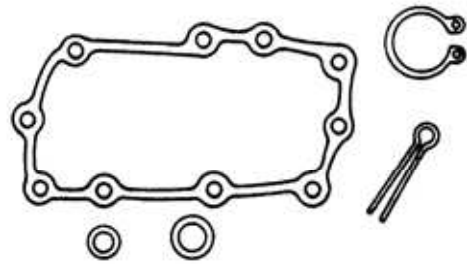

1. GENERAL INFORMATION

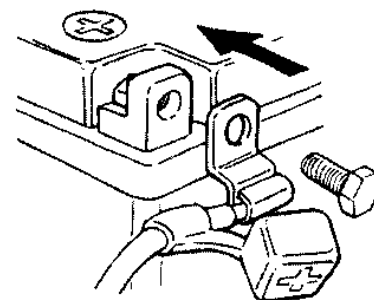
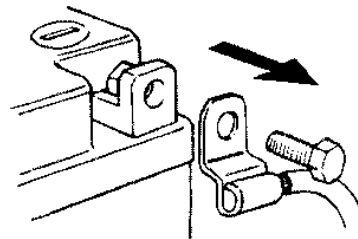
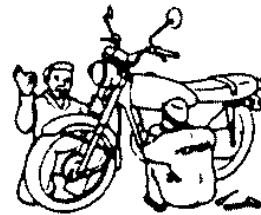
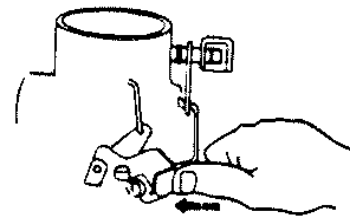
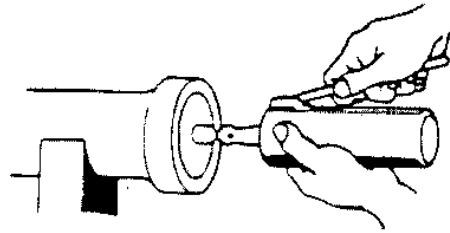

1. GENERAL INFORMATION

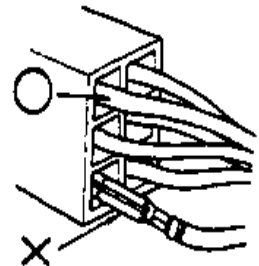
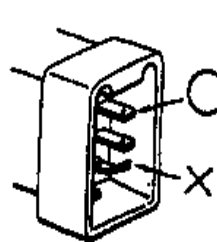
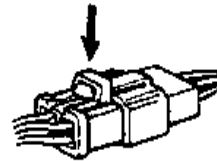
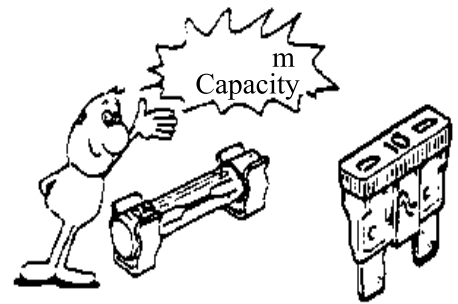

1. GENERAL INFORMATION

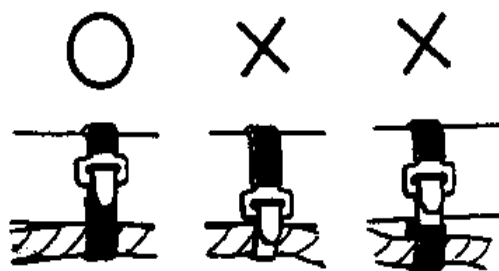
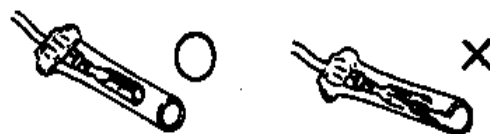
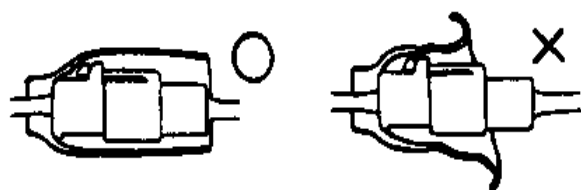
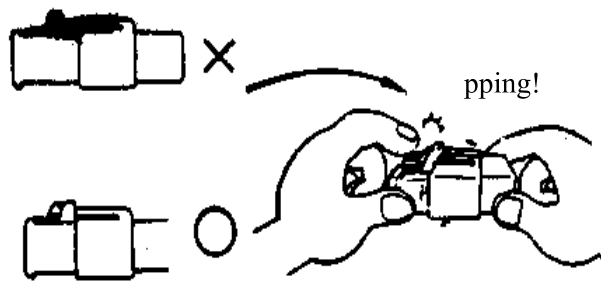

1. GENERAL INFORMATION

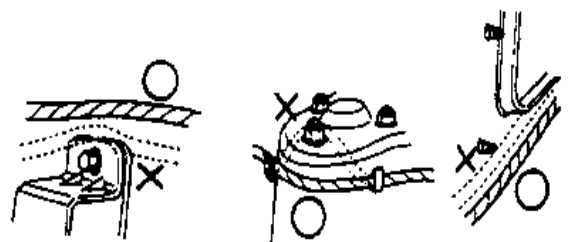
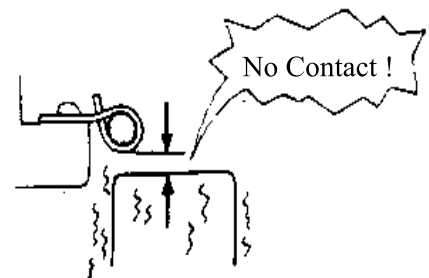
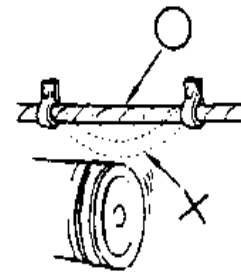
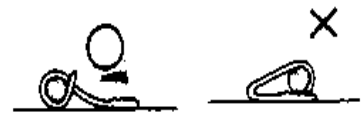
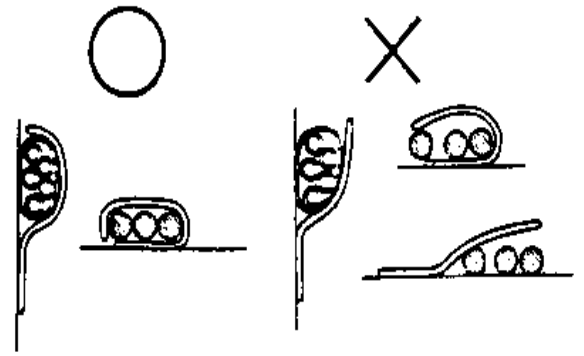

1. GENERAL INFORMATION

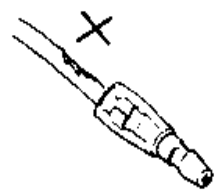
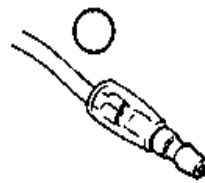
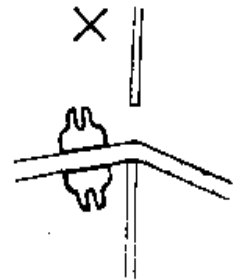
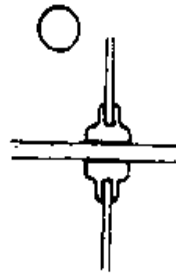
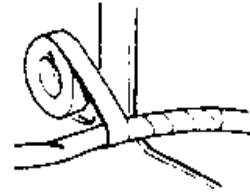
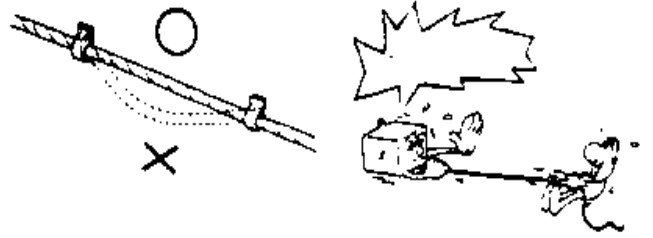

1. GENERAL INFORMATION

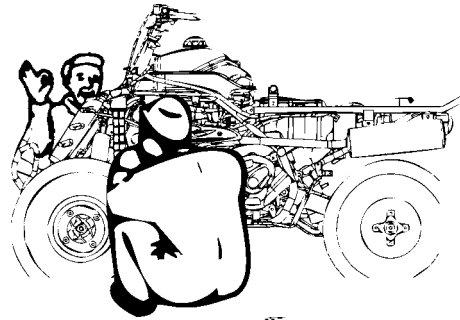
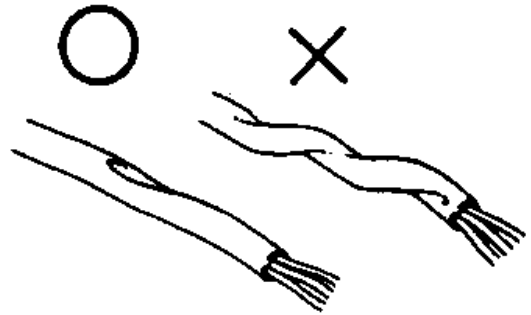

1. GENERAL INFORMATION



1. GENERAL INFORMATION

1. GENERAL INFORMATION

1. GENERAL INFORMATION

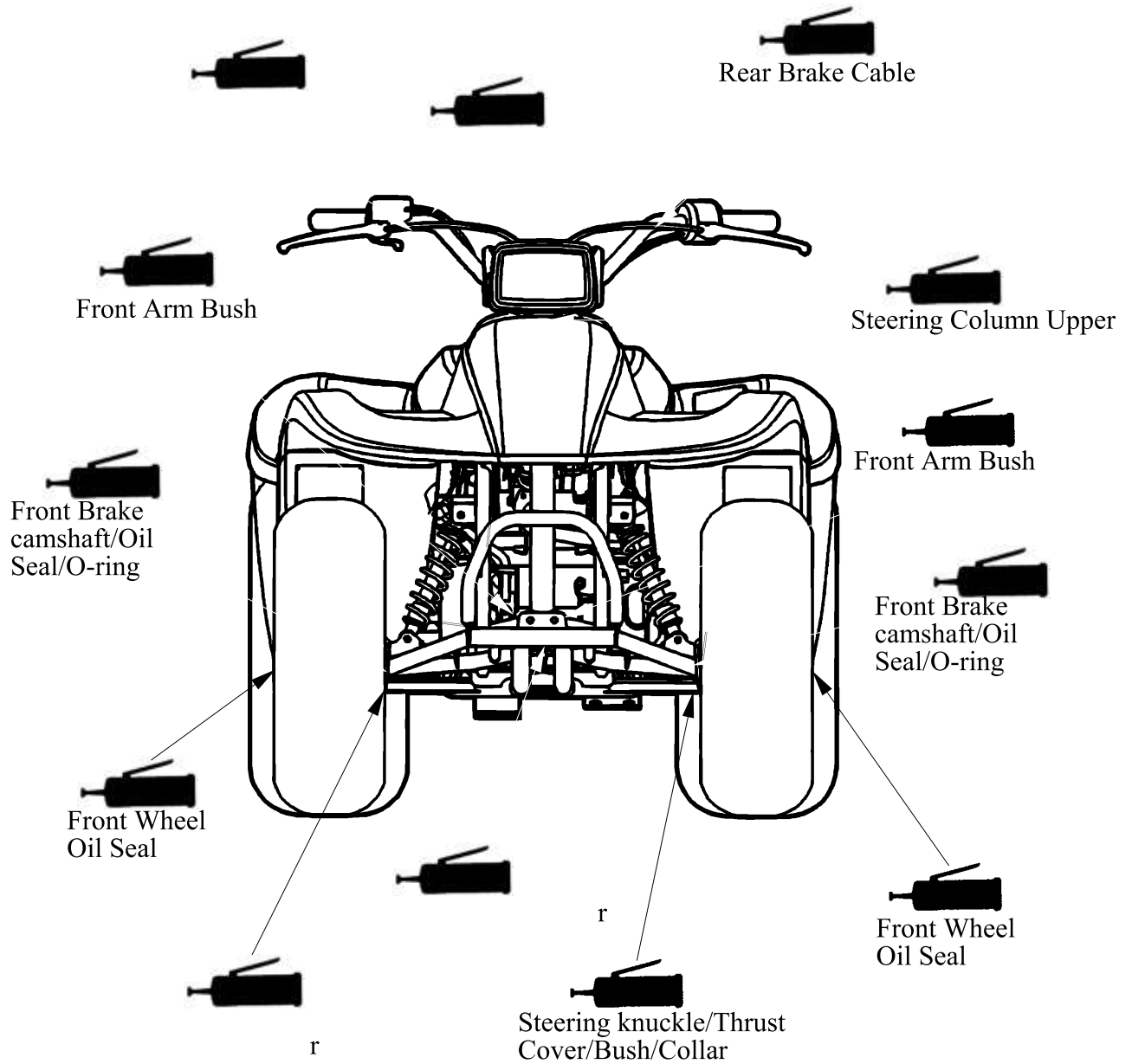

1. GENERAL INFORMATION

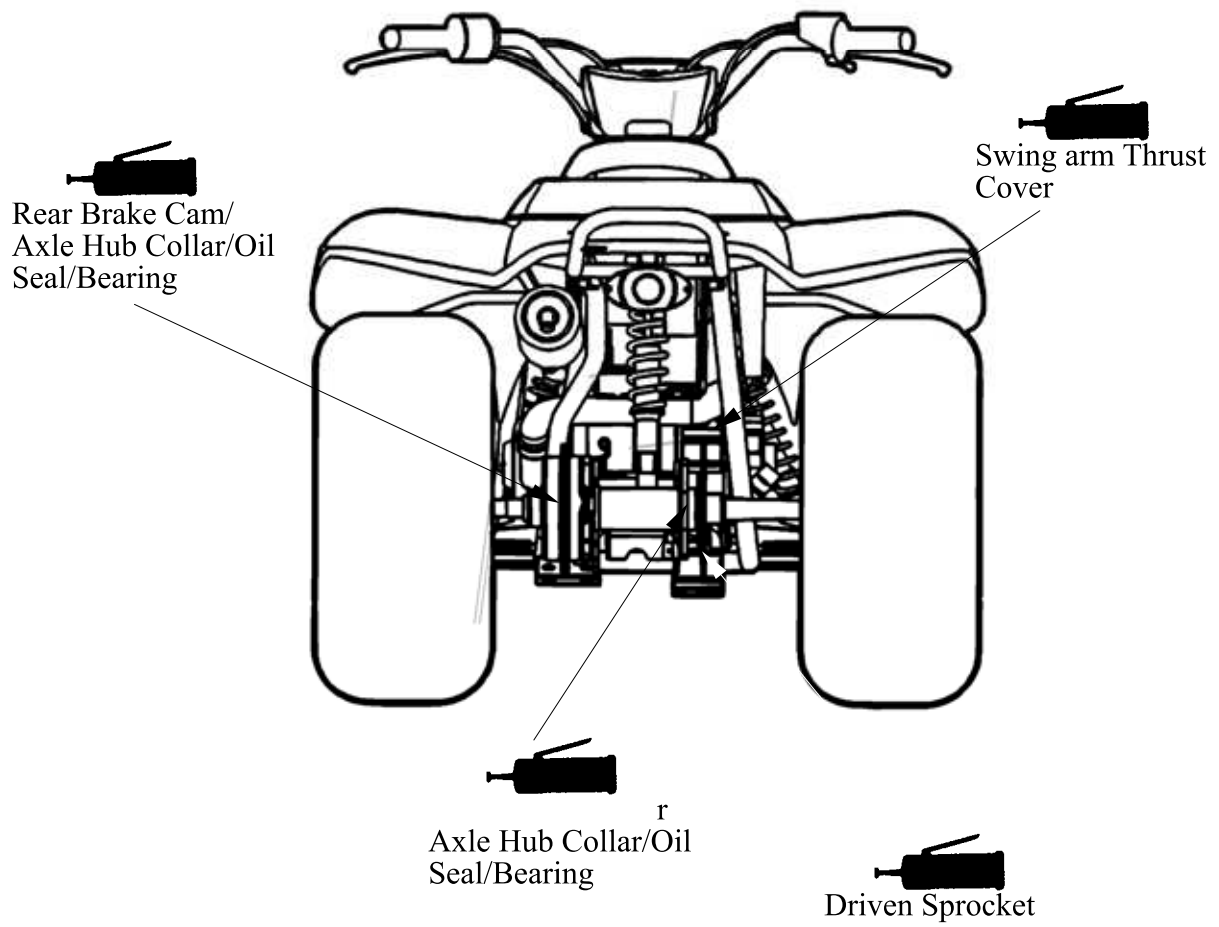

1. GENERAL INFORMATION



1. GENERAL INFORMATION

r

Oil Meter Wire

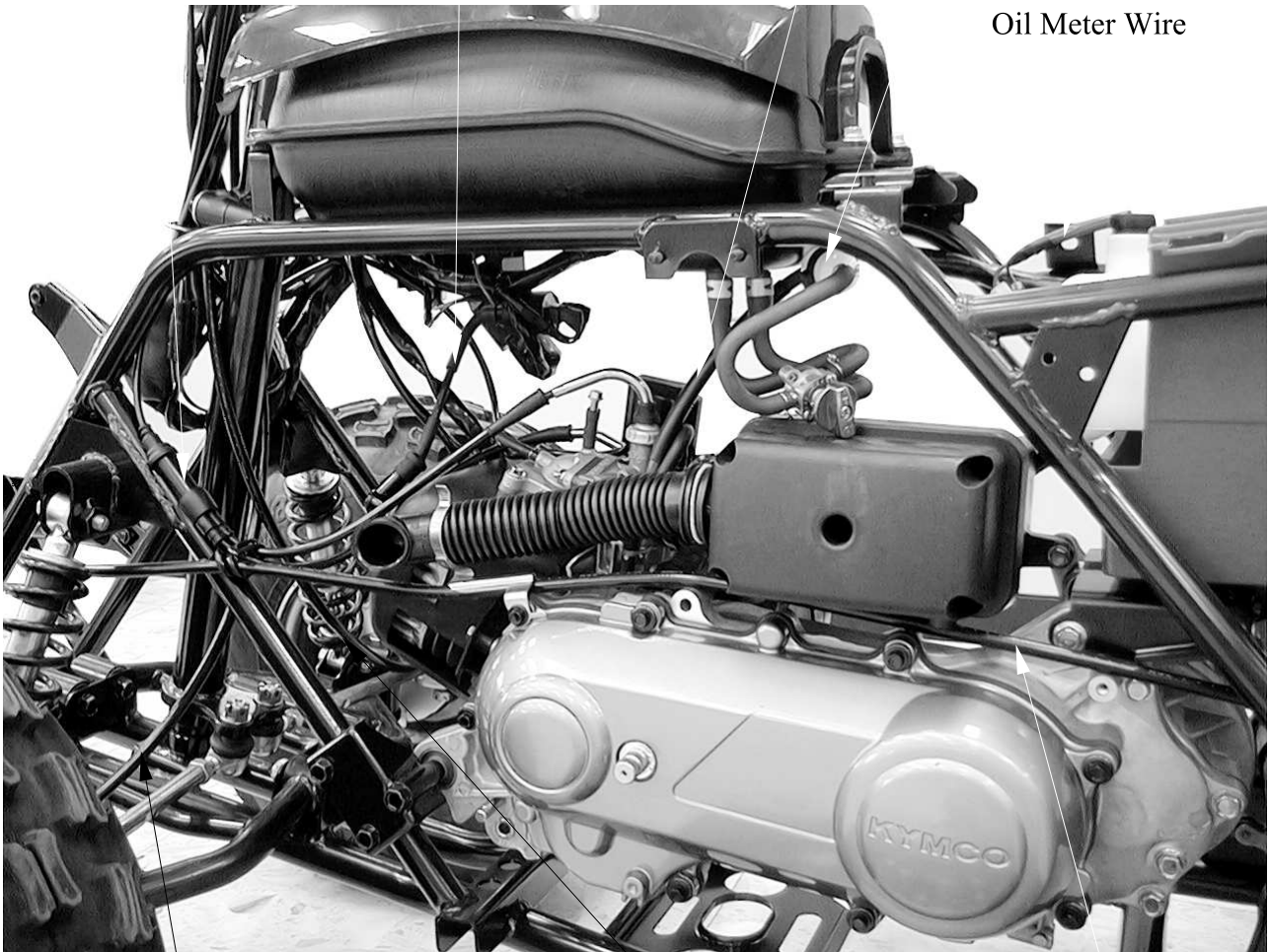

Left Front Brake Cable

Right Front Brake Cable

1. GENERAL INFORMATION



1. GENERAL INFORMATION

Main Switch

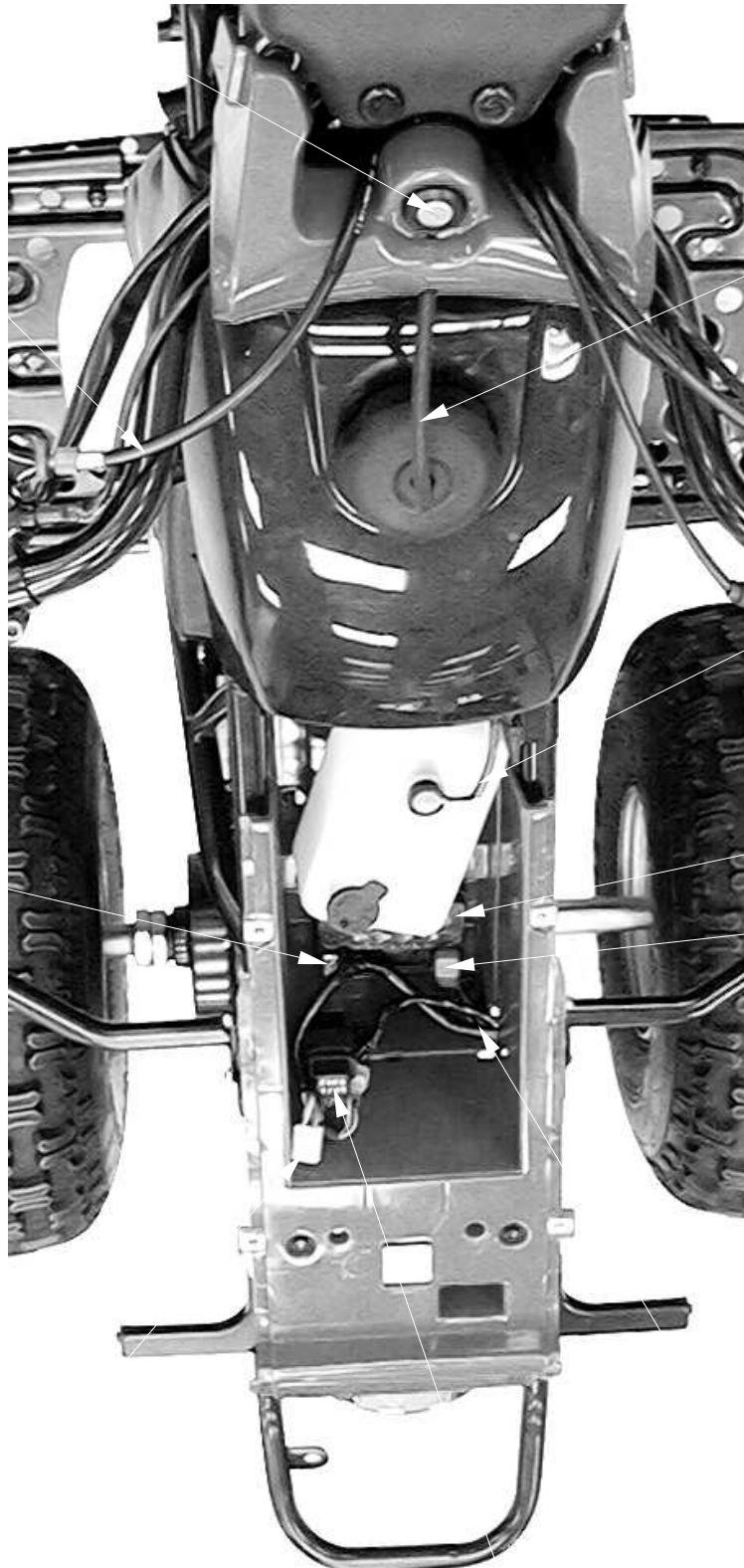

Negative Cable

1. GENERAL INFORMATION

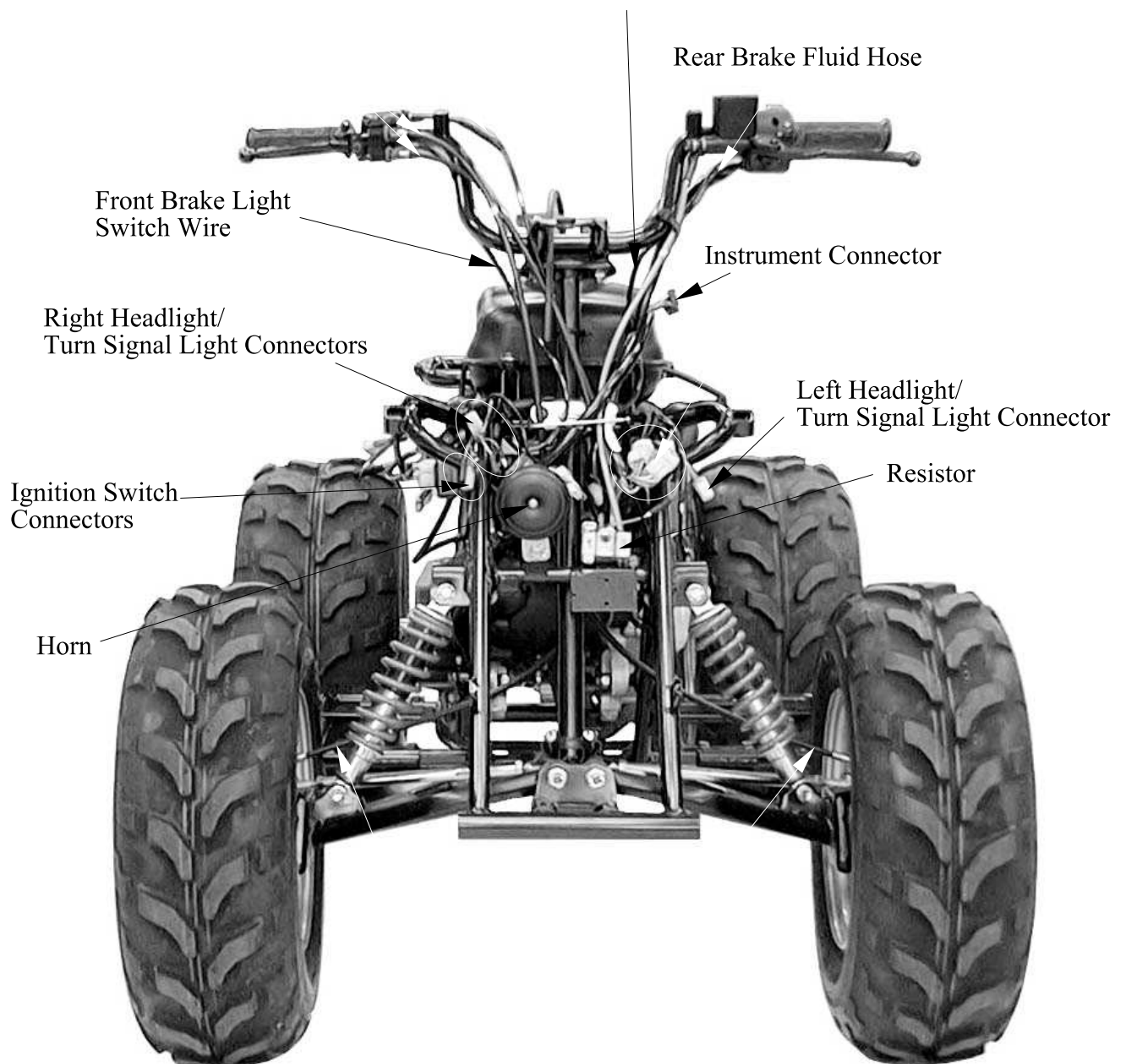

1. GENERAL INFORMATION

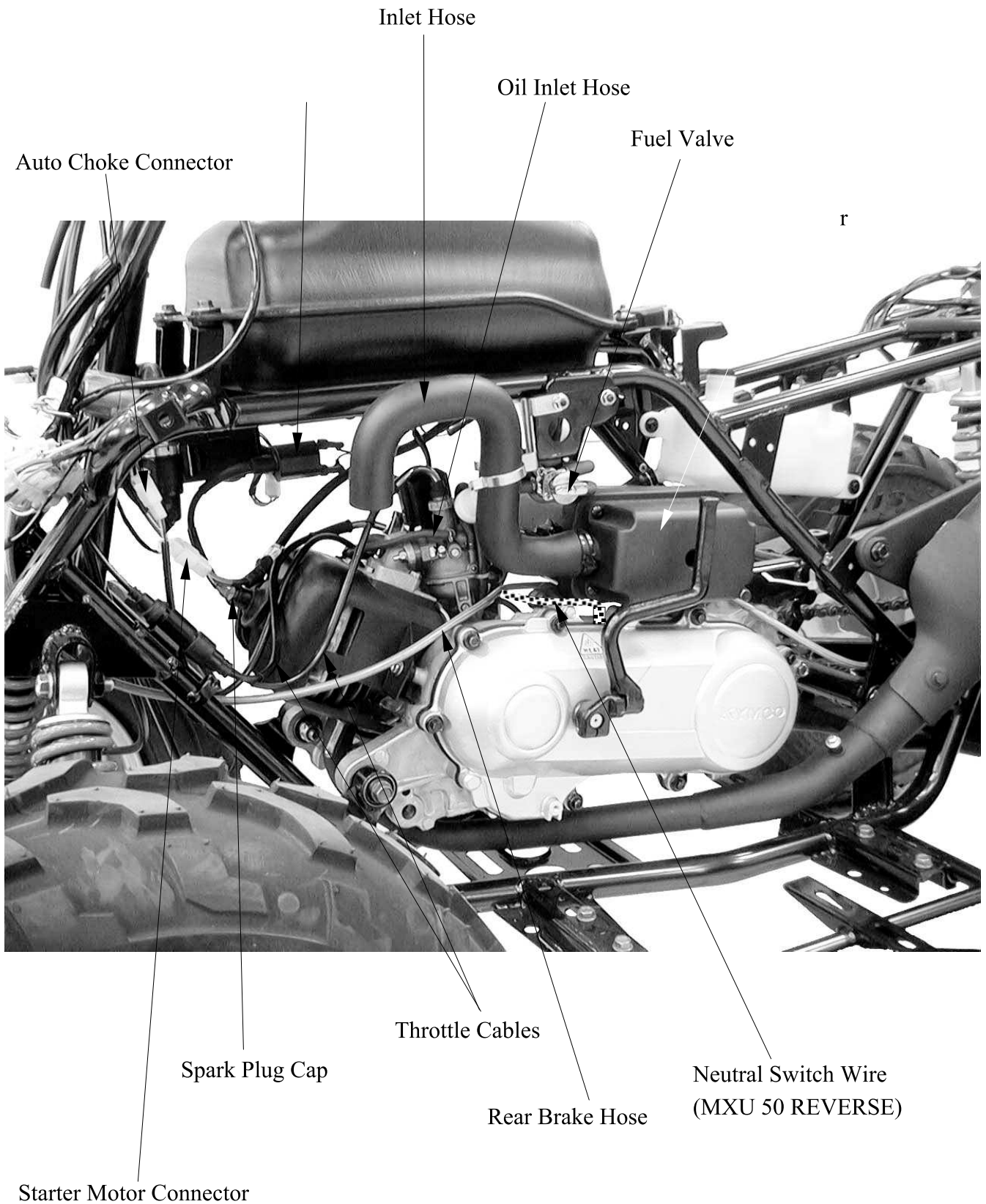

1. GENERAL INFORMATION

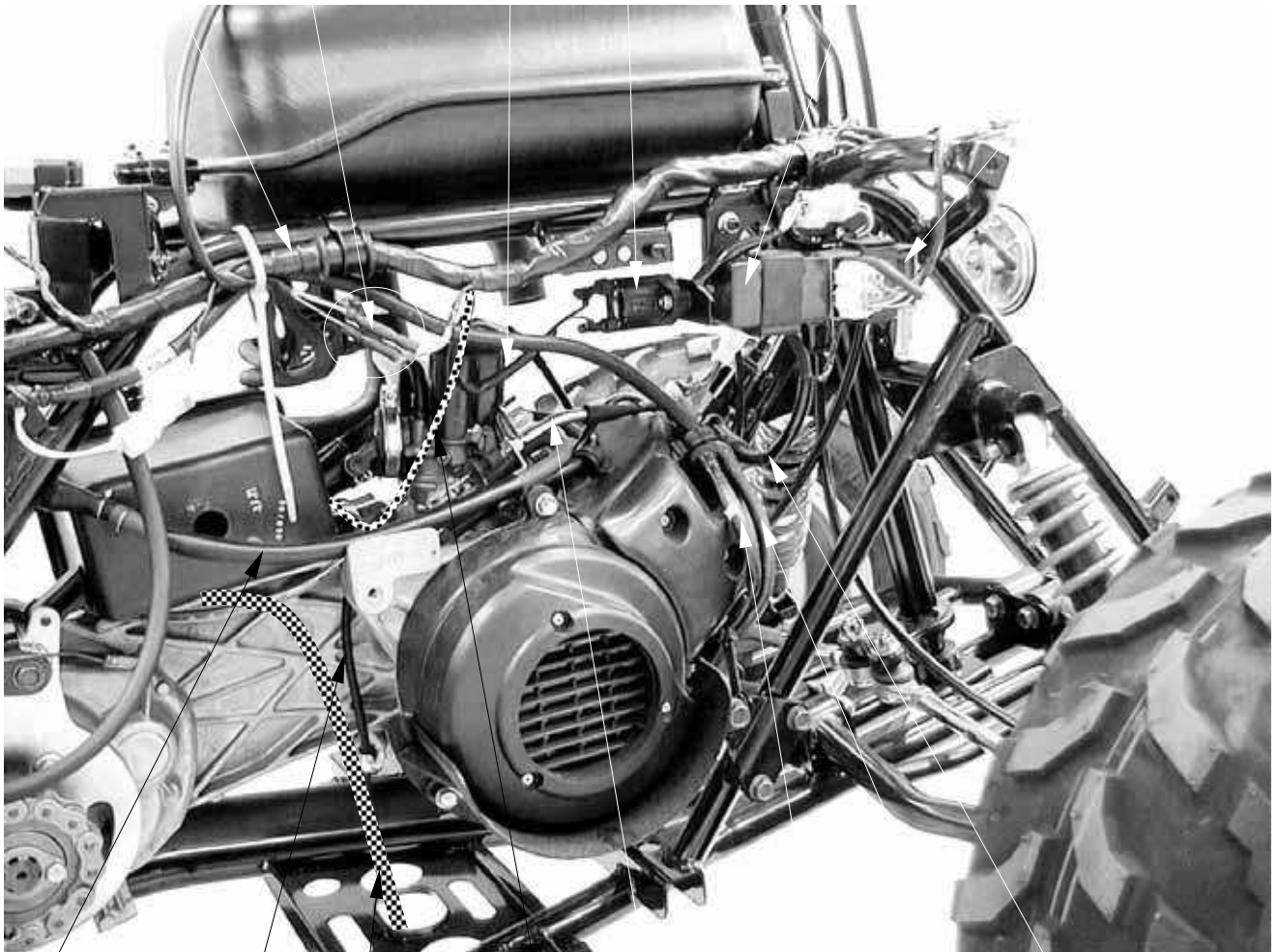

Oil Outlet Hose

Transmission Case Breather
Hose (MXU 50 REVERSE)

Neutral Switch Wire (MXU 50 REVERSE)

1. GENERAL INFORMATION

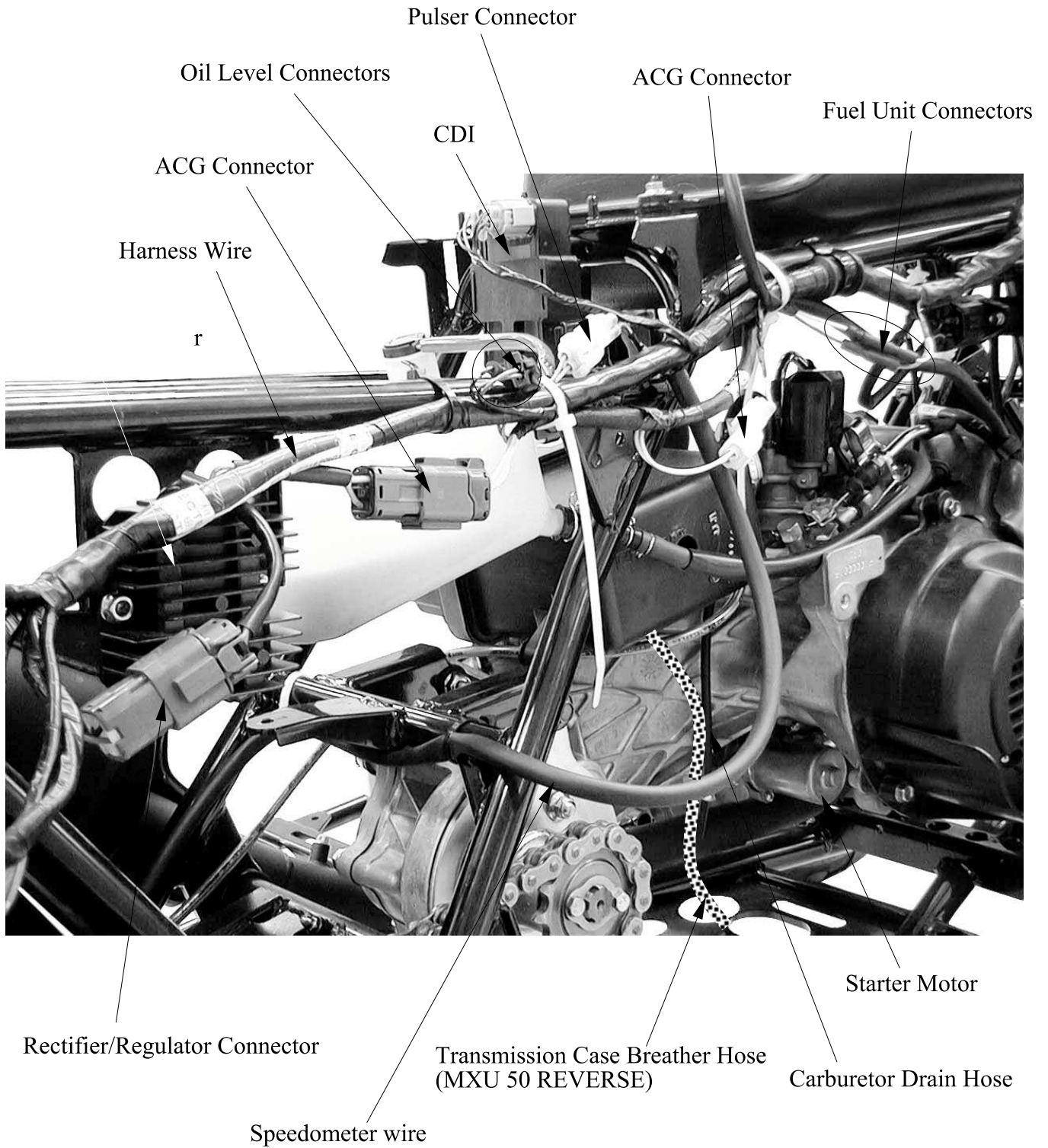

1. GENERAL INFORMATION

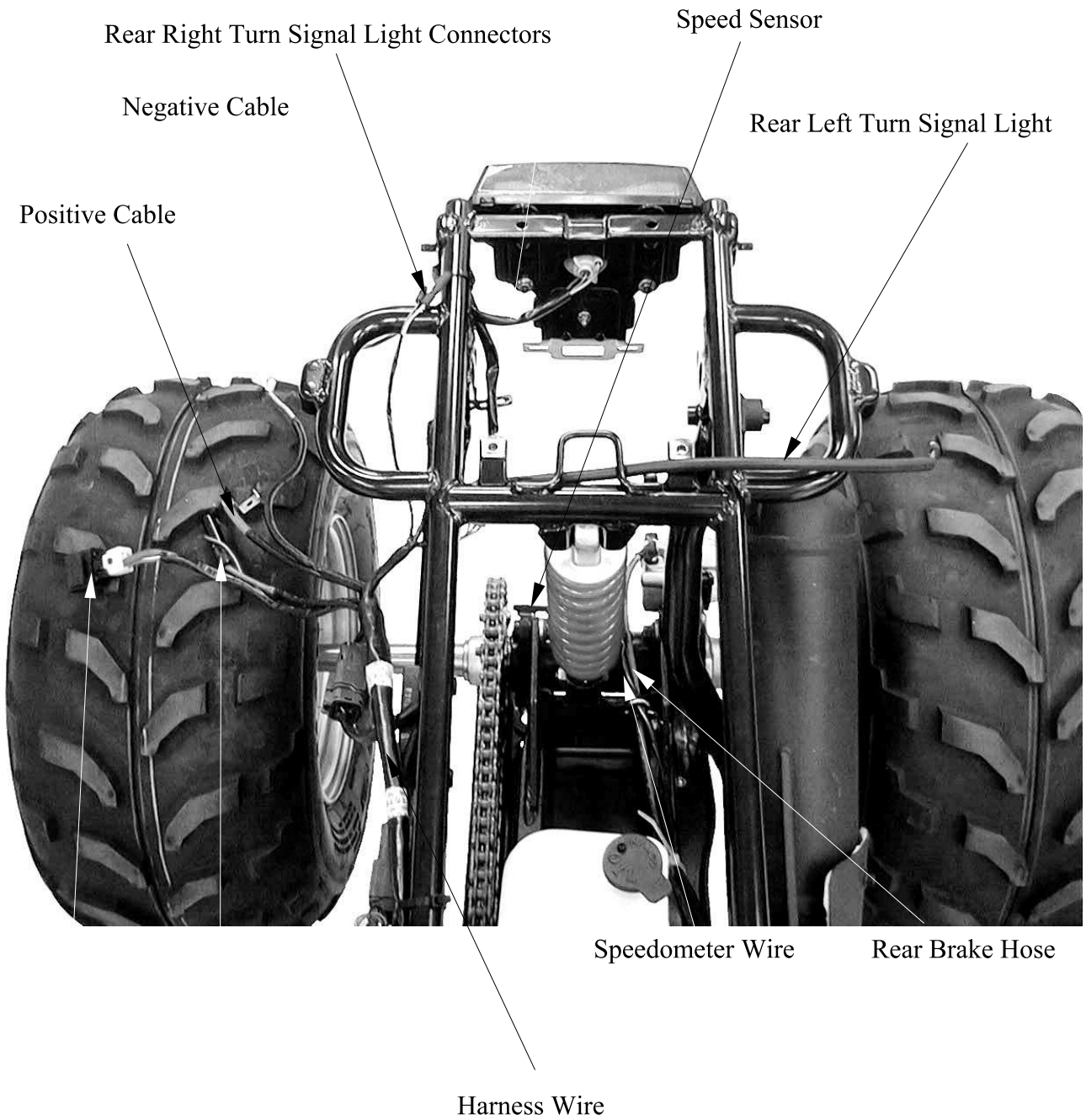

1. GENERAL INFORMATION

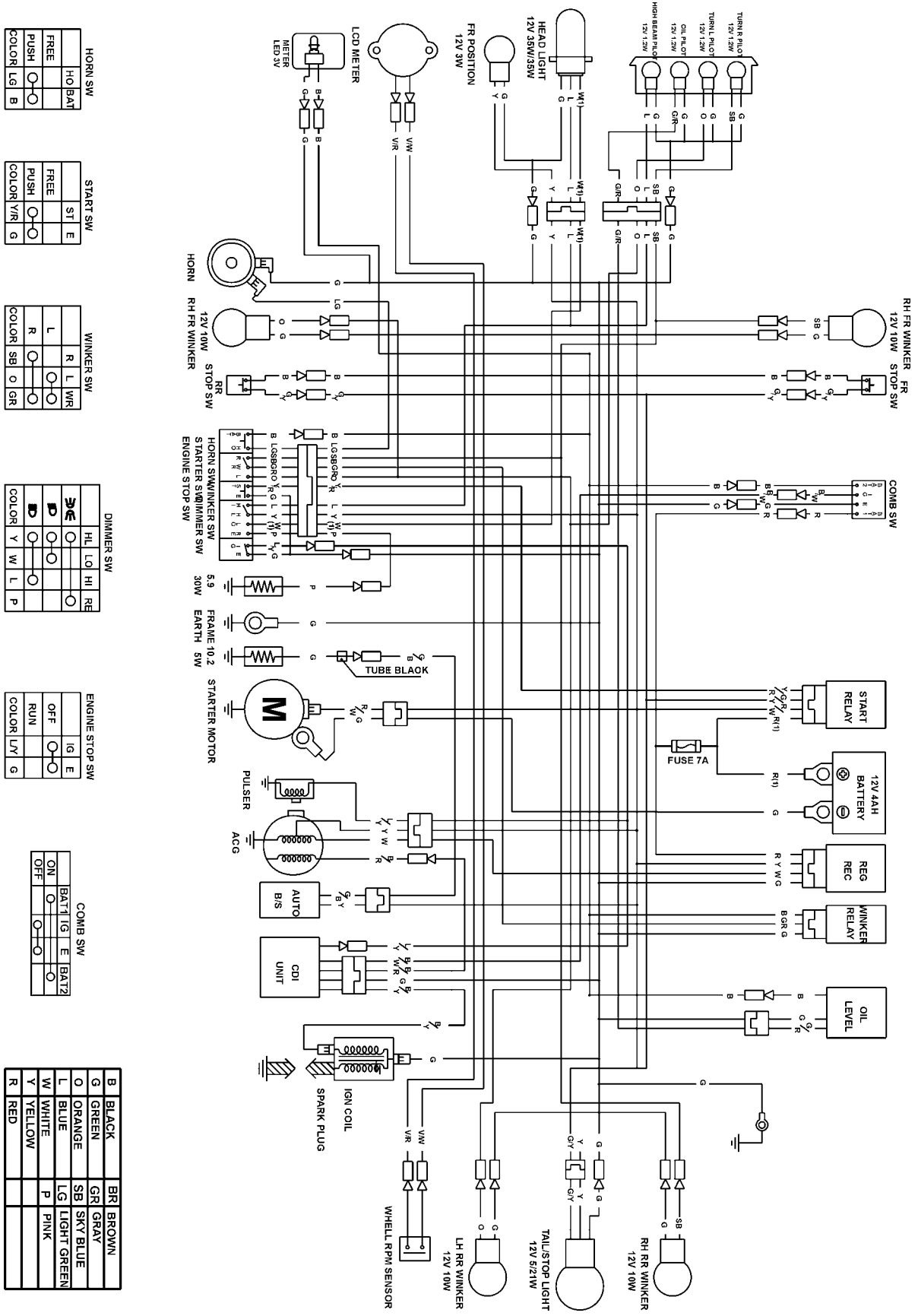

HORN SW

HO	BAT
FREE	
PUSH	
COLOR	LG B

START SW

ST	E
FREE	
PUSH	
COLOR	Y/R G

WINKER SW

R	L	WR
COLOR	SB	O GR

DIMMER SW

HL	LO	HI	RE
COLOR	Y	W	L P

ENGINE STOP SW

IG	E
OFF	
RUN	
COLOR	LV G

COMB SW

BAT1	IG	E	BAT2
ON			
OFF			

B	BLACK	BR	BROWN
G	GREEN	GR	GRAY
O	ORANGE	SB	SKY BLUE
L	BLUE	LG	LIGHT GREEN
W	WHITE	P	PINK
Y	YELLOW		
R	RED		

1. GENERAL INFORMATION

COLOR COMB GROUND/MARKING

B	BLACK	BR	BROWN
Y	YELLOW	O	ORANGE
L	BLUE	SB	SKY BLUE
G	GREEN	LG	LIGHT GREEN
R	RED	P	PINK
W	WHITE	GR	GRAY

STARTER SW

FREE	E	ST
PUSH	○	○
COLOR	G	Y/R

ENGINE STOP SW

OFF	E	IG
RUN	○	○
COLOR	G	L/Y

COMB SW

ON	BATT	IG	E	BATT2
OFF	○	○	○	○

LIGHTING SW

●	CI	RE	TL	LO	HI
(N)	○	○	○	○	○
L	○	○	○	○	○
(N)	○	○	○	○	○
H	○	○	○	○	○
COLOR	Y	P	BR	W	L

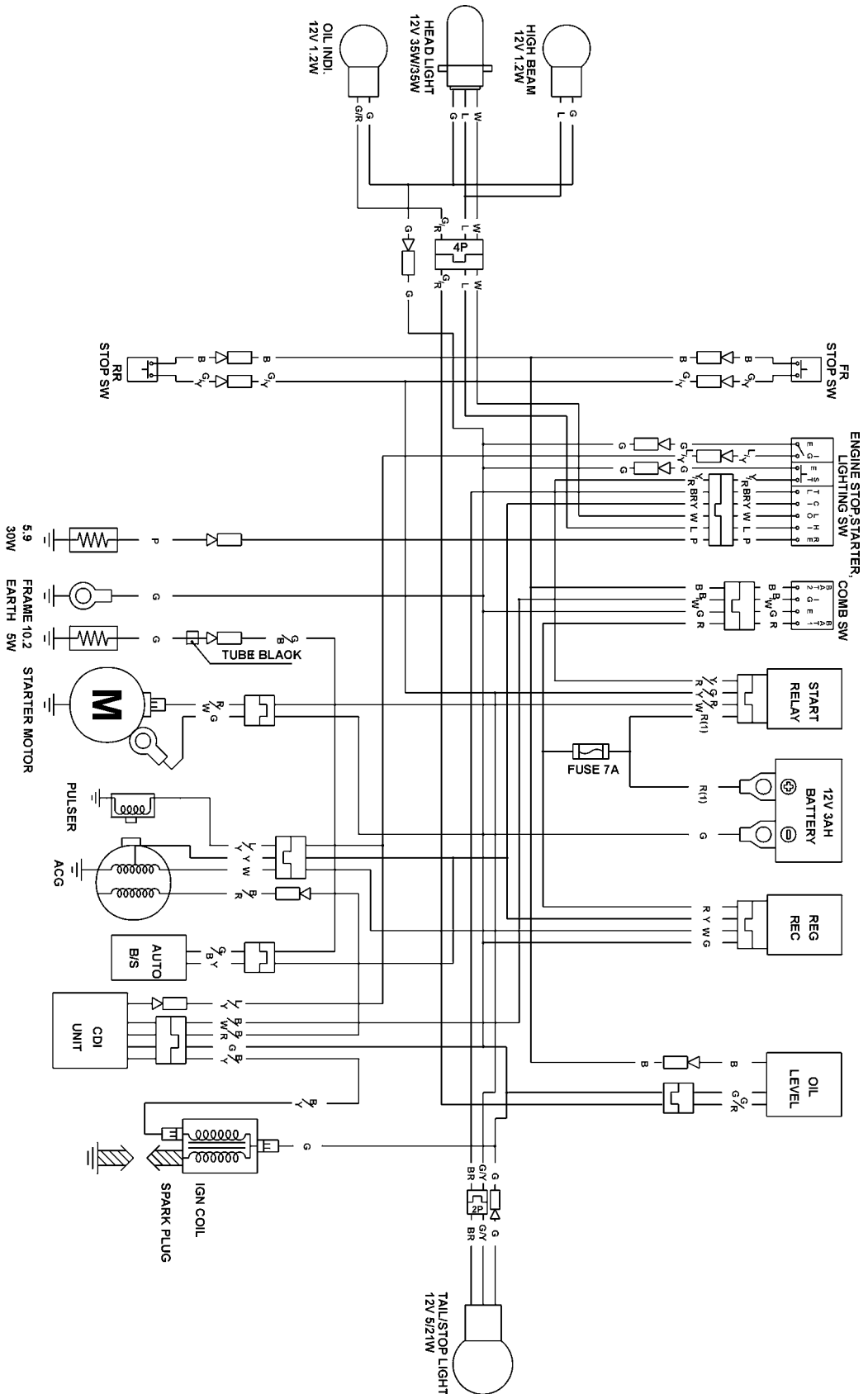

1. GENERAL INFORMATION

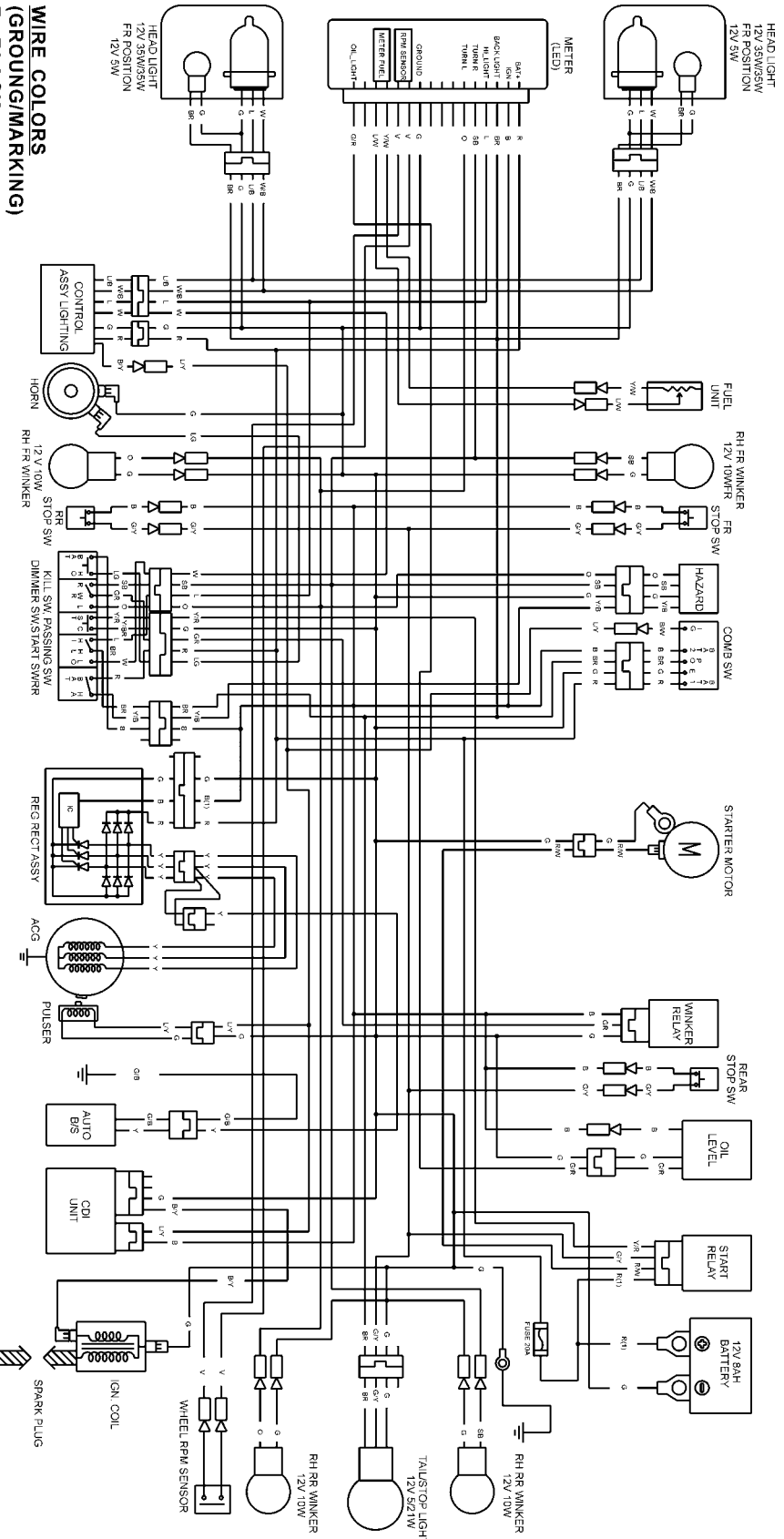

WIRE COLORS (GROUND/MARKING)

- B: BLACK
- Y: YELLOW
- L: BLUE
- O: ORANGE
- G: GREEN
- R: RED
- W: WHITE
- P: PINK
- V: VIOLET
- BR: BROWN
- LG: LIGHT GREEN
- GR: GRAY
- SB: SKY BLUE

HORNS SW	
FREE	ON
FLASH	OFF
COLO	LO
	HI

START SW	
FREE	ON
FLASH	OFF
COLO	LO
	HI

WINKER SW	
L	R
FLASH	OFF
COLO	LO
	HI

DIMMER SW	
200%	ON
100%	OFF
COLO	LO
	HI

HAZARD SW	
FLASH	ON
COLO	LO
	HI

COMB SW	
ON	OFF
FLASH	ON
COLO	LO
	HI

1. GENERAL INFORMATION

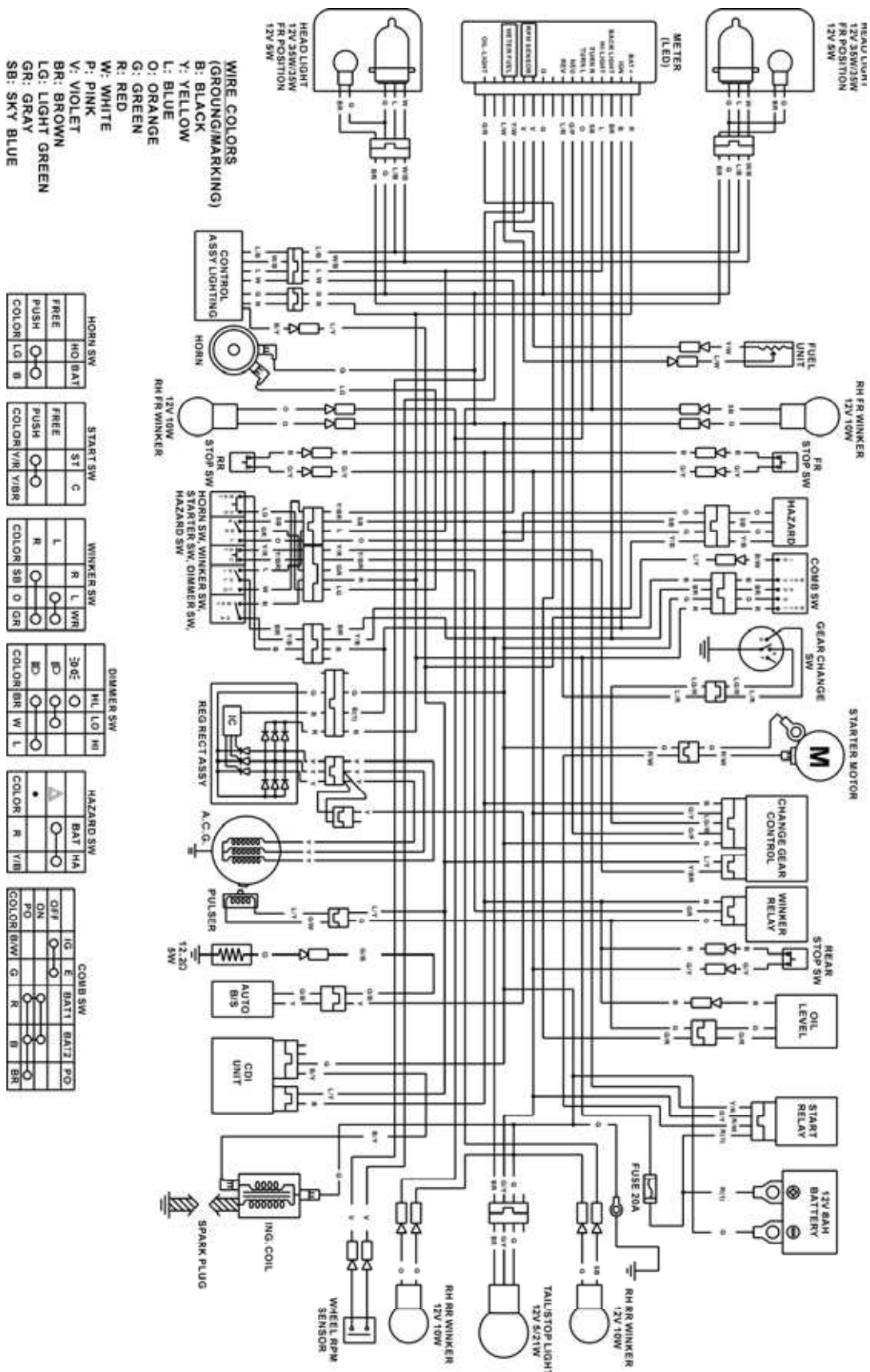

1. GENERAL INFORMATION

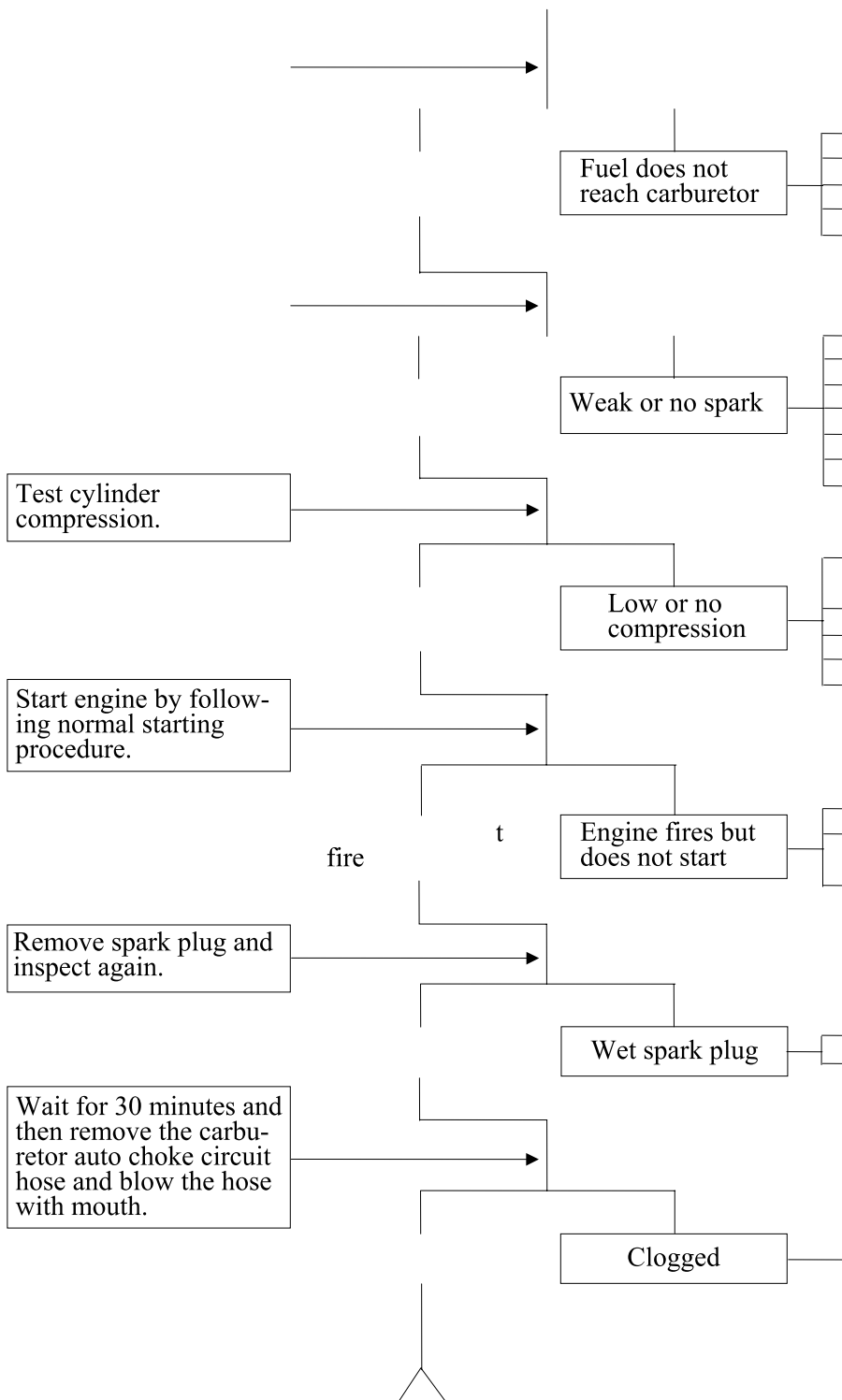

1. GENERAL INFORMATION

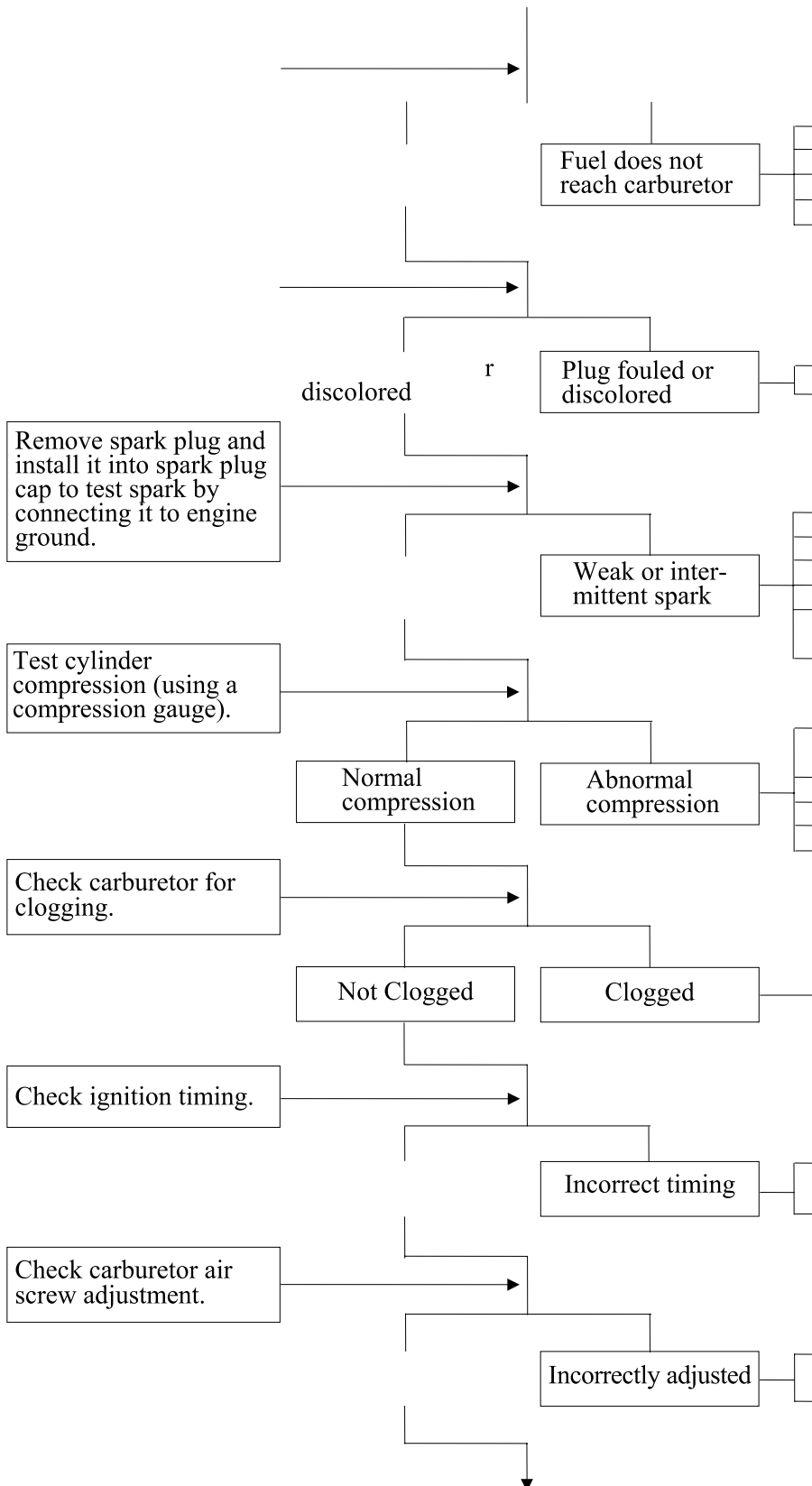

1. GENERAL INFORMATION

for air leaks. t →

Remove auto bystarter connecting wire and check if bypass fuel line is clogged. →

Connect auto bystarter wire to battery. Wait for 5 minutes, then connect a hose to fuel enriching circuit and then blow the hose with mouth. →

1. GENERAL INFORMATION

	Correct timing	Incorrect timing	
Check carburetor air screw adjustment.			

	Correctly adjusted	Incorrectly adjusted	
Check carburetor gasket for air leaks.			

No air leak	Air leaks
-------------	-----------

	Good spark	Weak or intermittent spark
Remove auto bystarter connecting wire and check if bypass fuel line is clogged.		

Not clogged	Clogged
-------------	---------

bystarter wire to battery. Wait for 5 minutes, then connect a hose to fuel enriching circuit and then blow the hose with mouth.



1. GENERAL INFORMATION

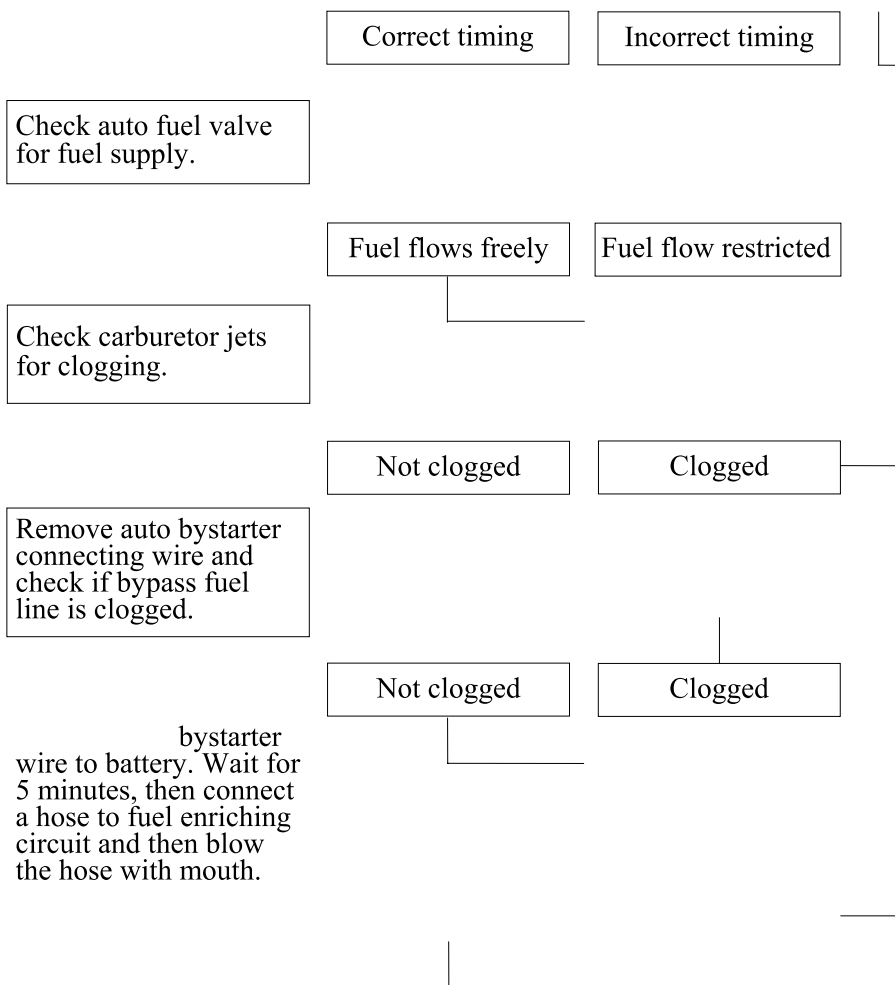

1. GENERAL INFORMATION

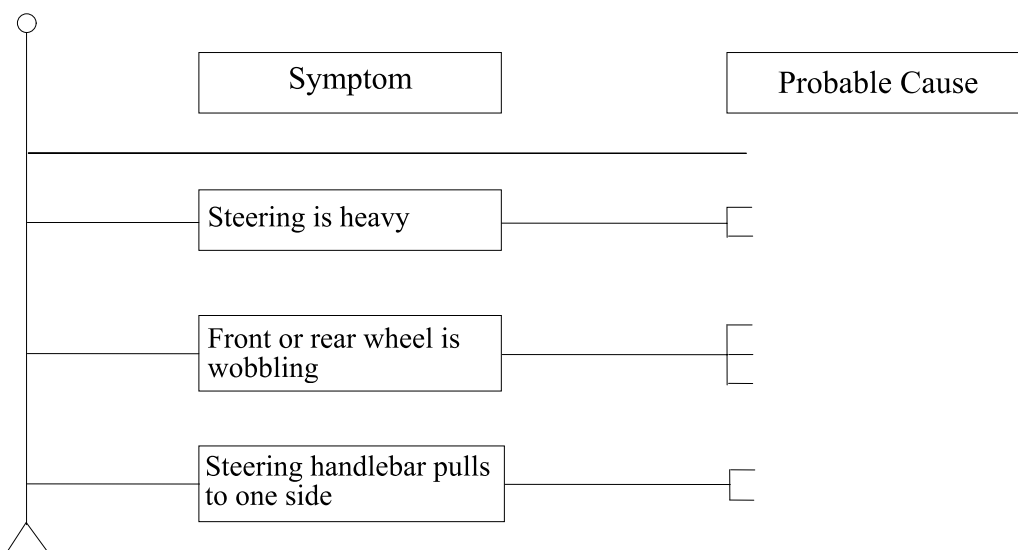
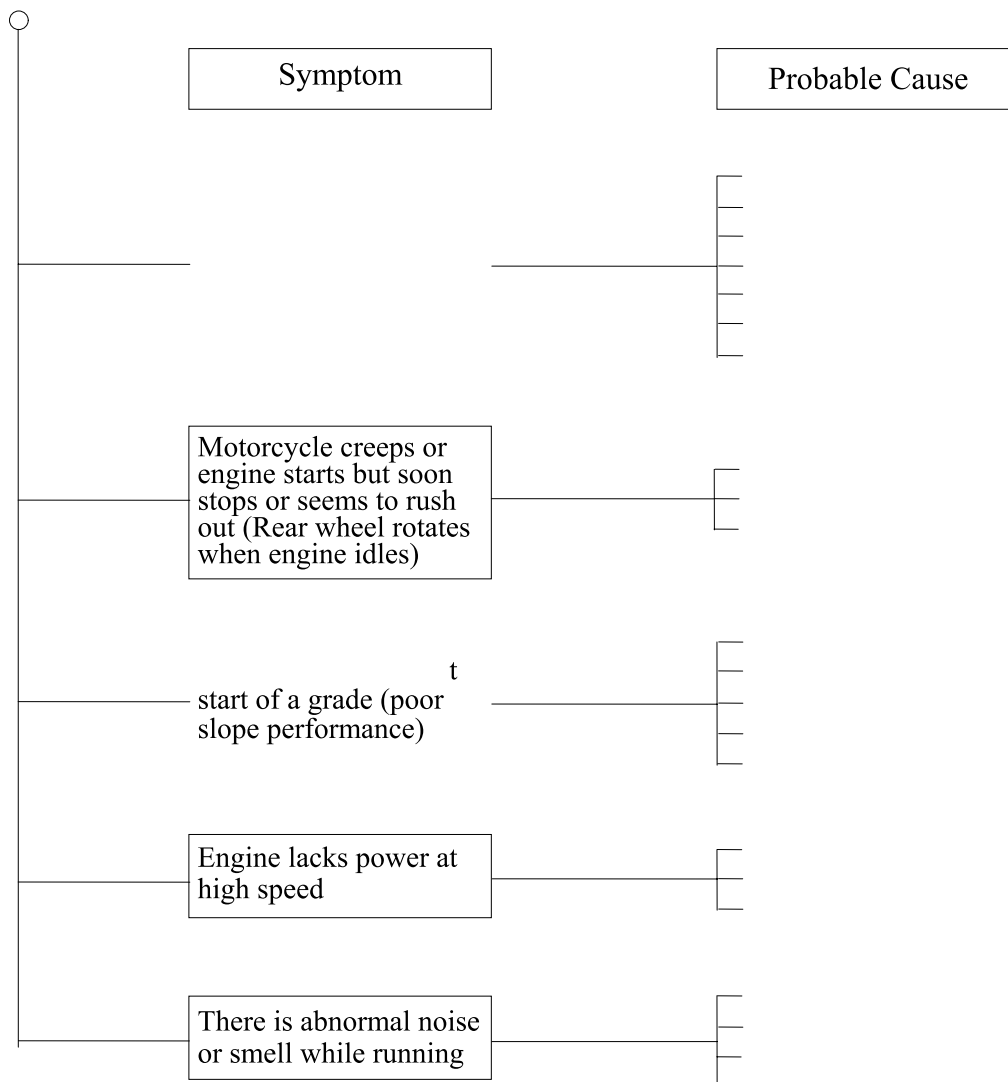

1. GENERAL INFORMATION

○

○

Index mark on brake panel aligns with wear indicator arrow

—
—

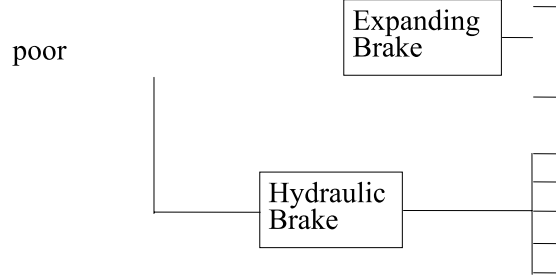

1. GENERAL INFORMATION

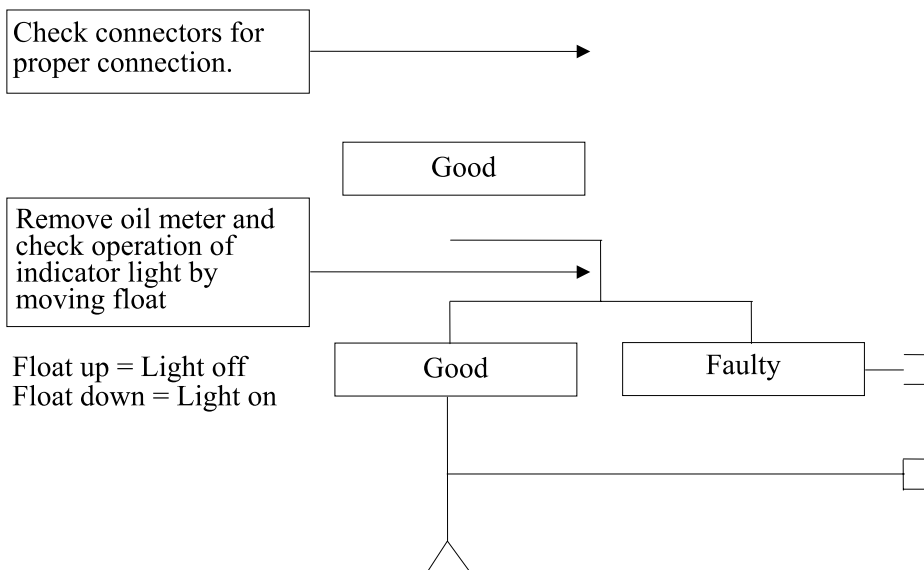
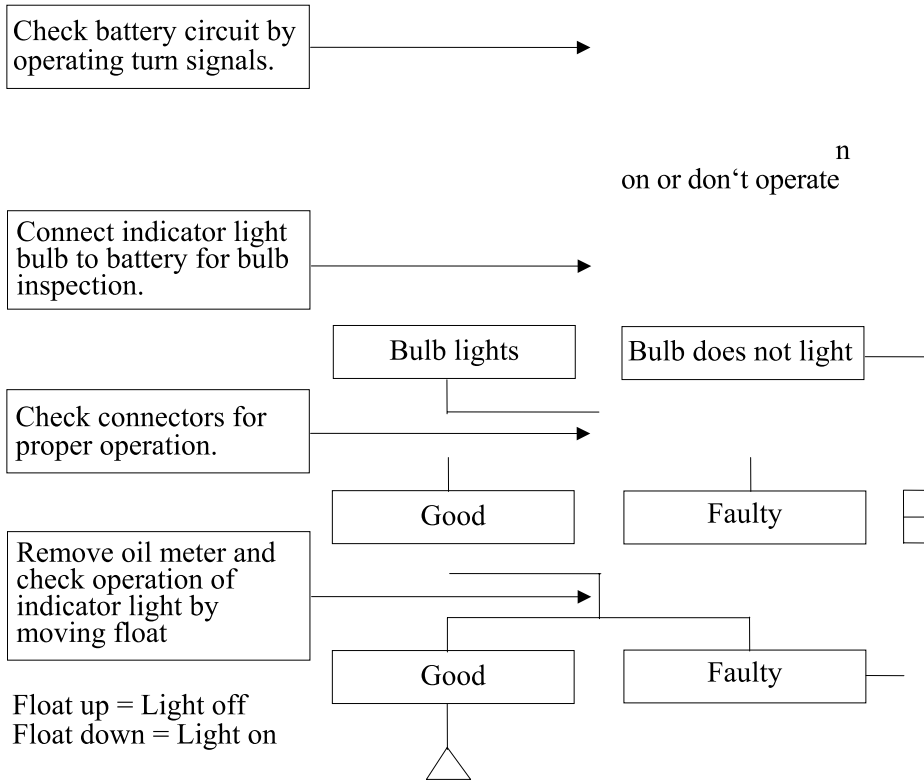

1. GENERAL INFORMATION

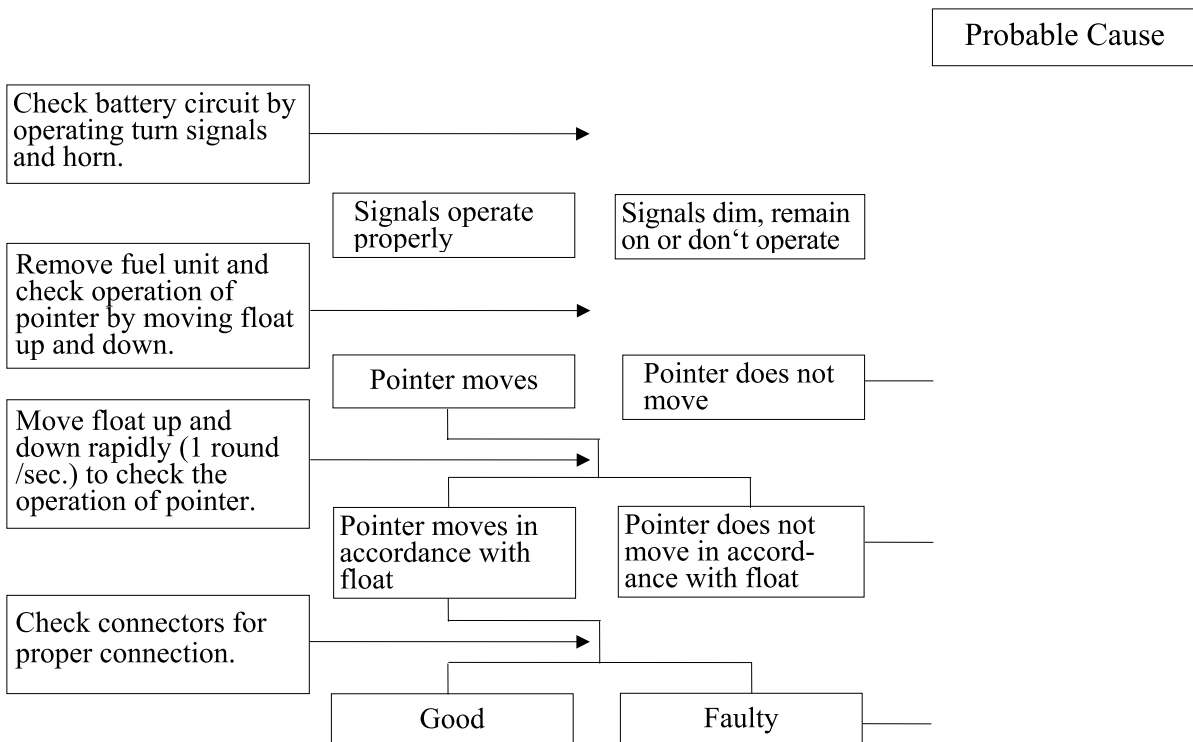
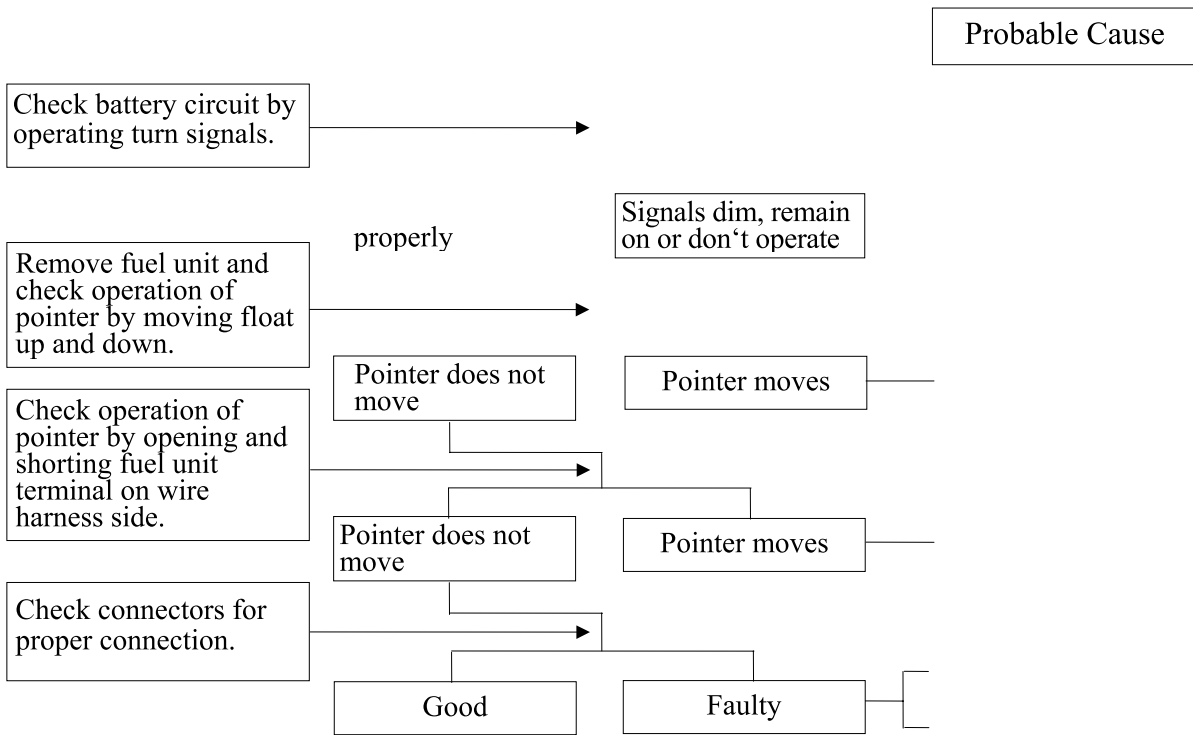

1. GENERAL INFORMATION

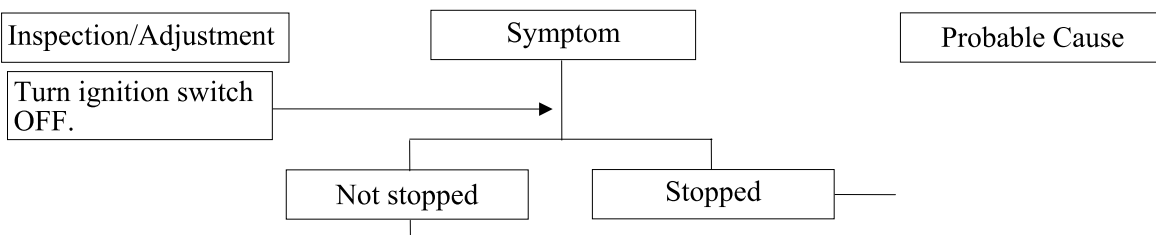
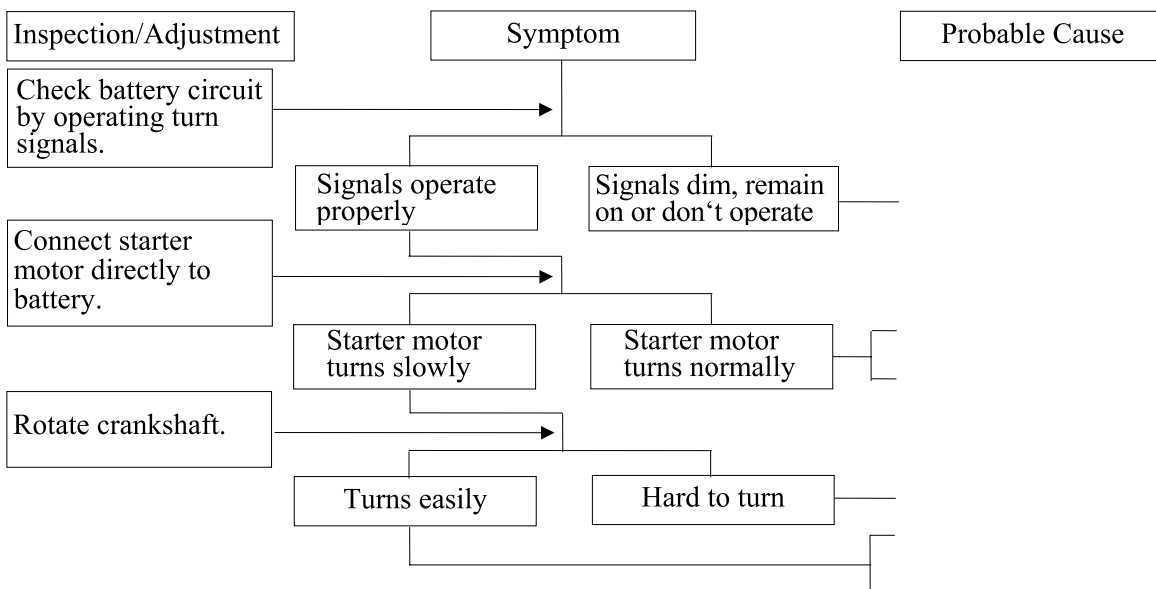
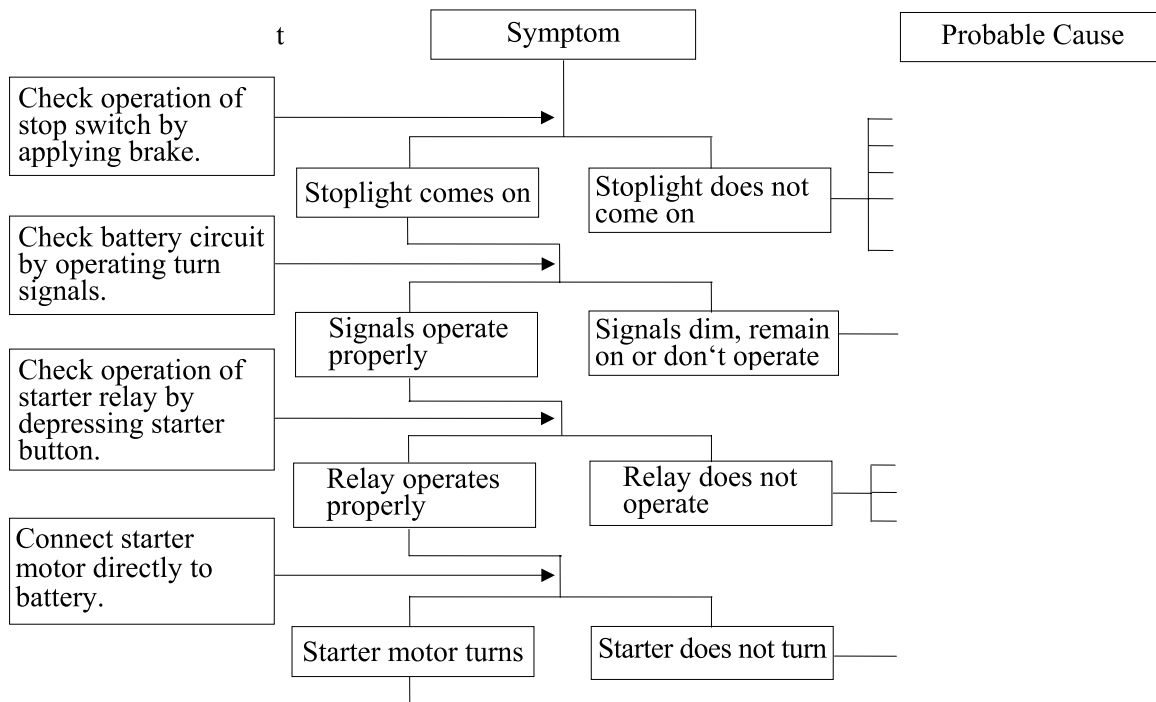

2. FRAME COVERS/EXHAUST MUFFLER

2. FRAME COVERS/EXHAUST MUFFLER

2. FRAME COVERS/EXHAUST MUFFLER

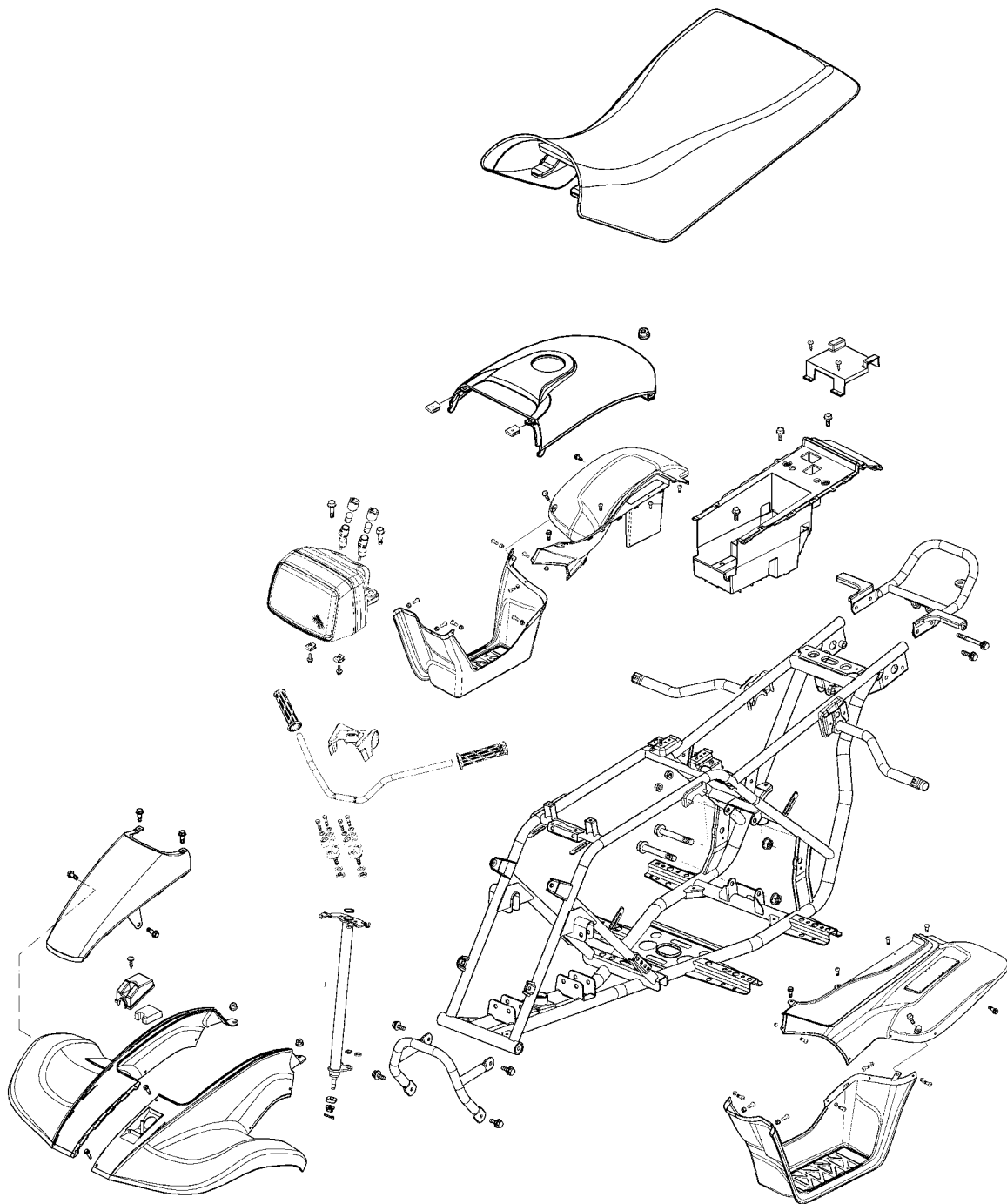

2. FRAME COVERS/EXHAUST MUFFLER

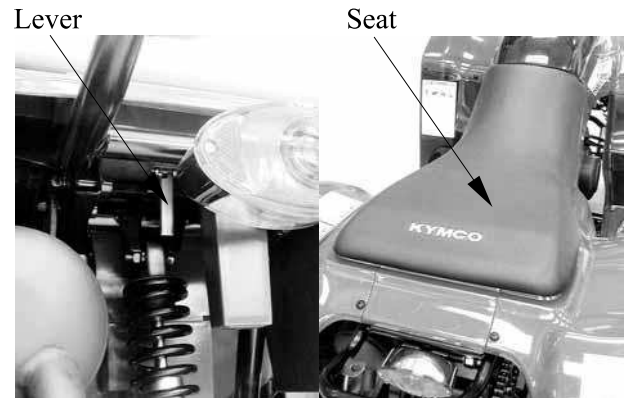

During removal, do not pull the joint claws forcedly to avoid damage.

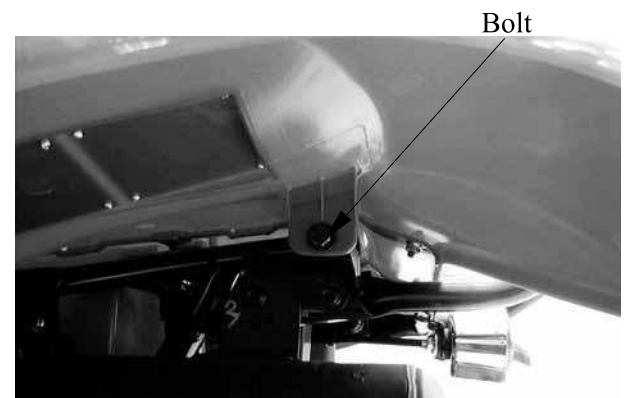
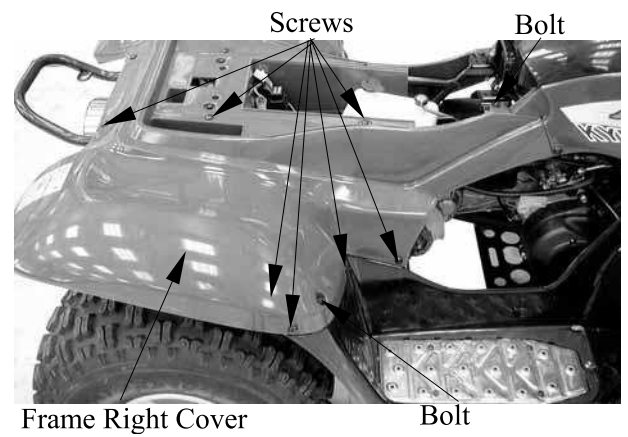

2. FRAME COVERS/EXHAUST MUFFLER

Front Cover

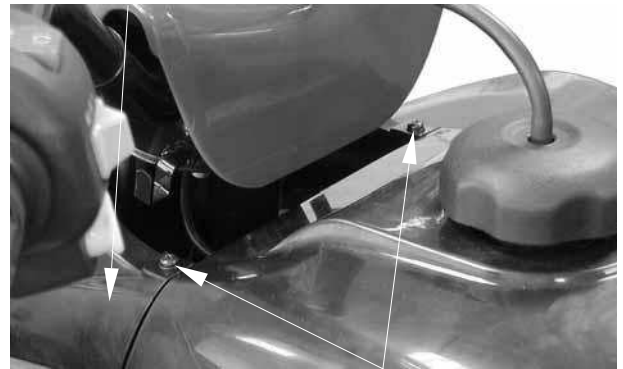

Screws



ts

Right Front Cover



Screws

During removal, be careful not to damage the joint claws.



Left Front Cover

Screws

2. FRAME COVERS/EXHAUST MUFFLER

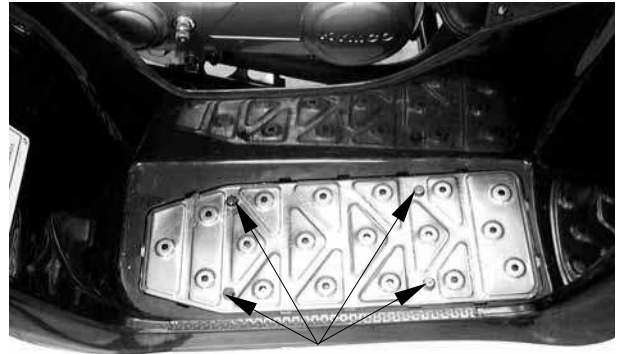

Floor Board



ts

2. FRAME COVERS/EXHAUST MUFFLER

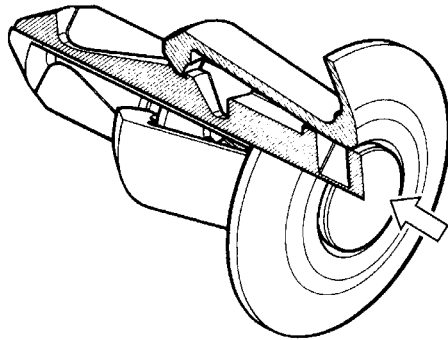
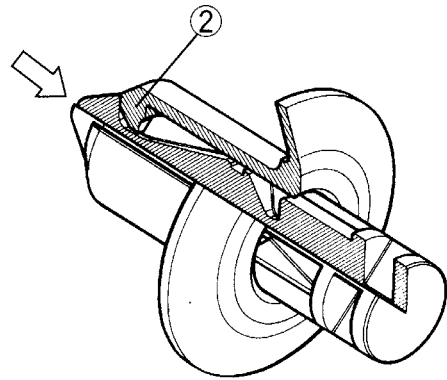
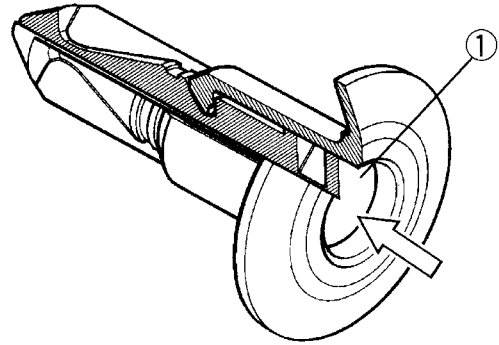

2. FRAME COVERS/EXHAUST MUFFLER

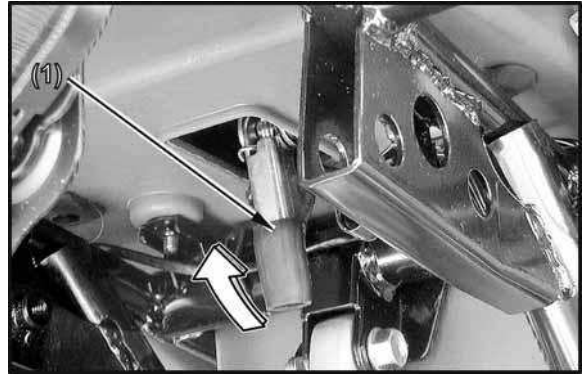

Mounting Bolts

2. FRAME COVERS/EXHAUST MUFFLER

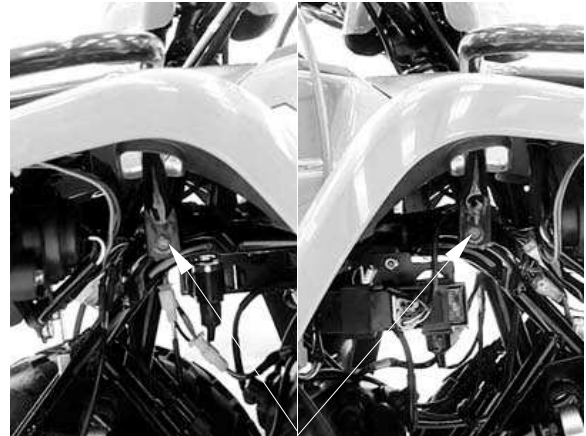

Right/Left Signal Light Connectors

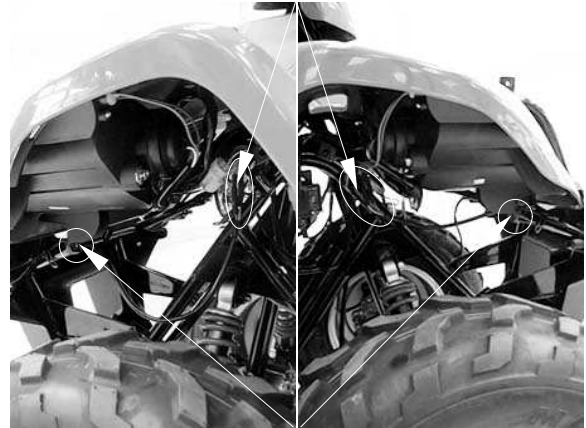

Bolts

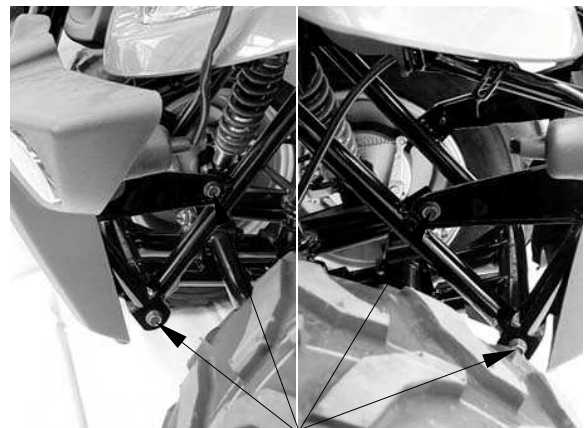

Mounting Bolts

2. FRAME COVERS/EXHAUST MUFFLER

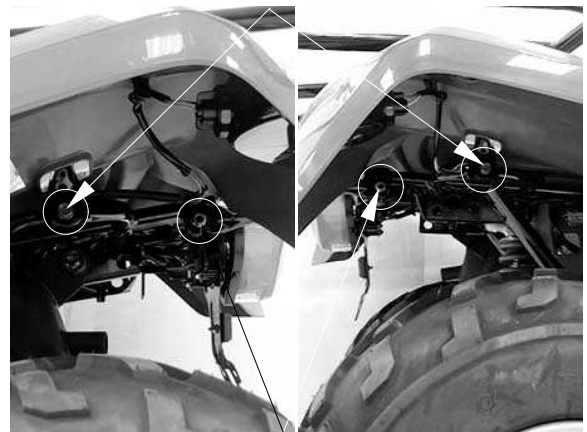

Mounting Nuts

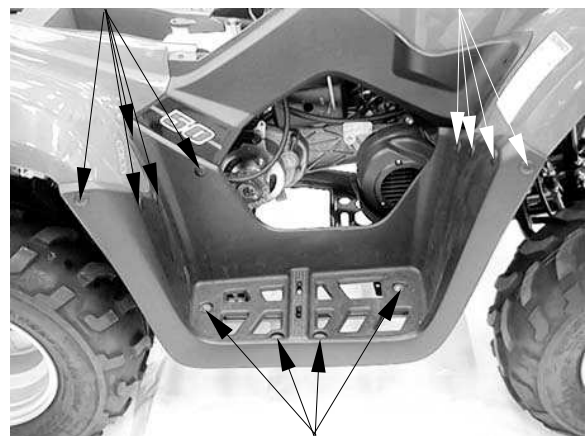

2. FRAME COVERS/EXHAUST MUFFLER

During removal, do not pull the joint claws forcedly to avoid damage.

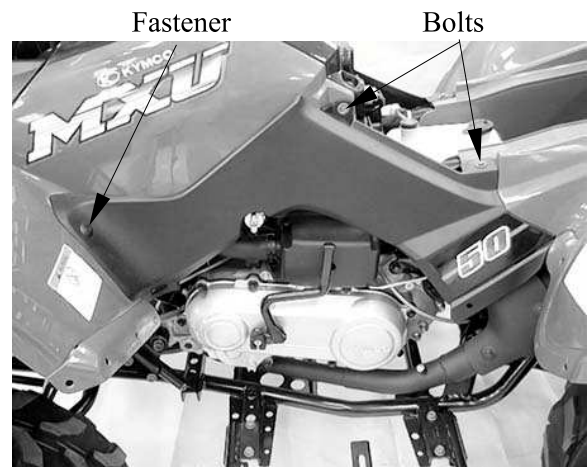
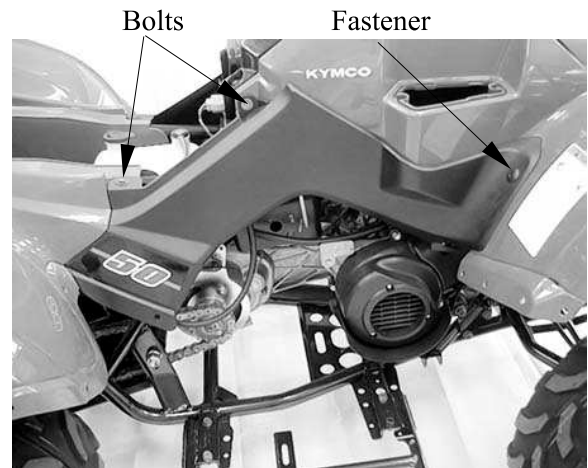
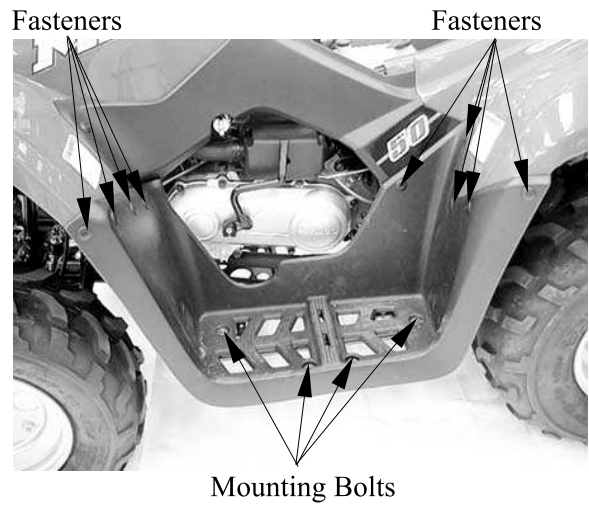

2. FRAME COVERS/EXHAUST MUFFLER

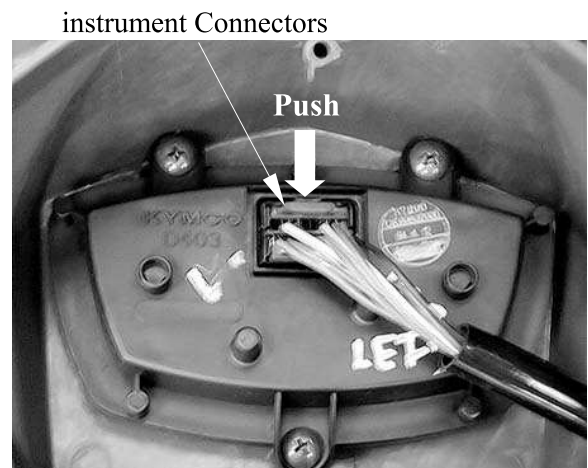
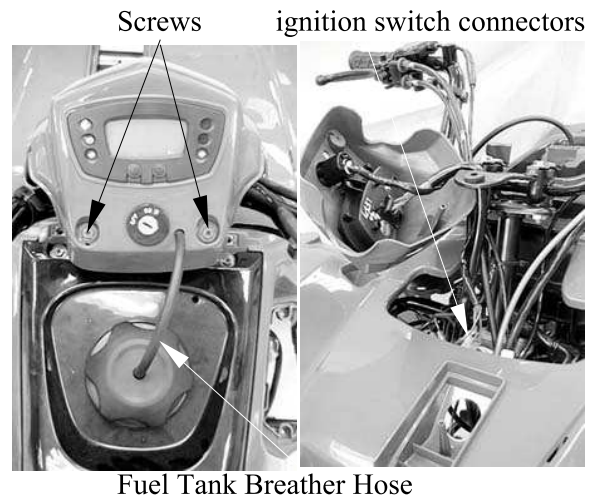
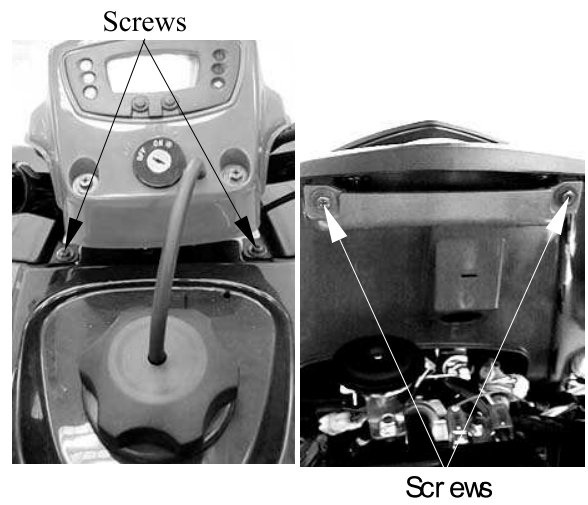

2. FRAME COVERS/EXHAUST MUFFLER

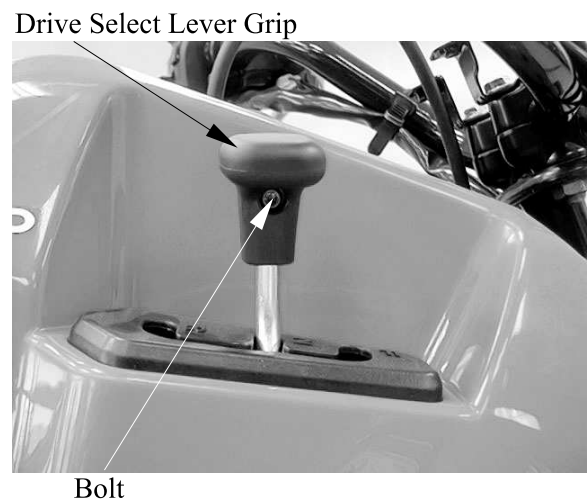
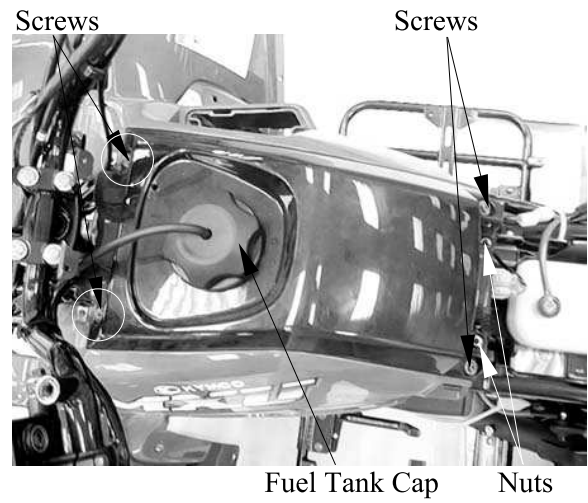

2. FRAME COVERS/EXHAUST MUFFLER

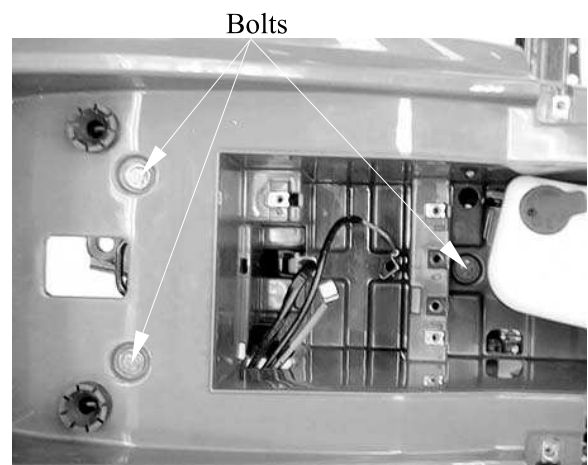
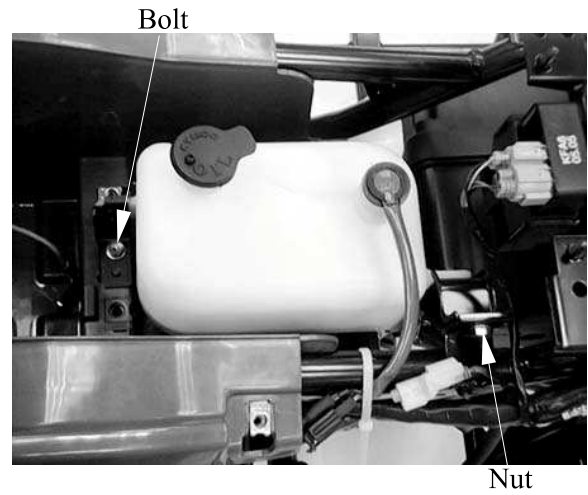

2. FRAME COVERS/EXHAUST MUFFLER

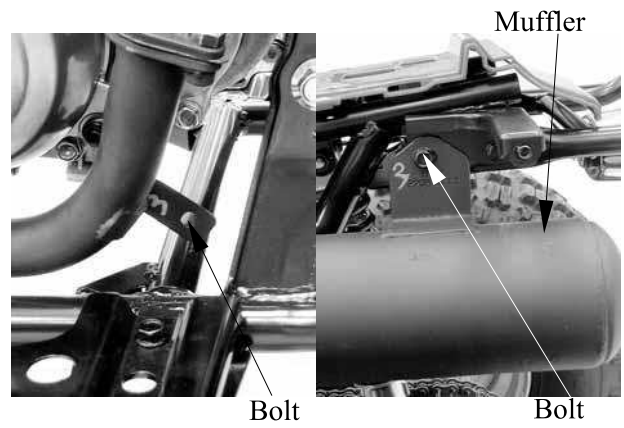
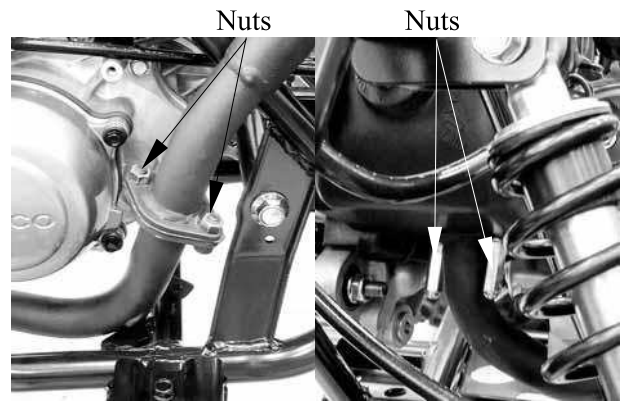

Be sure to install a new exhaust muffler gasket.

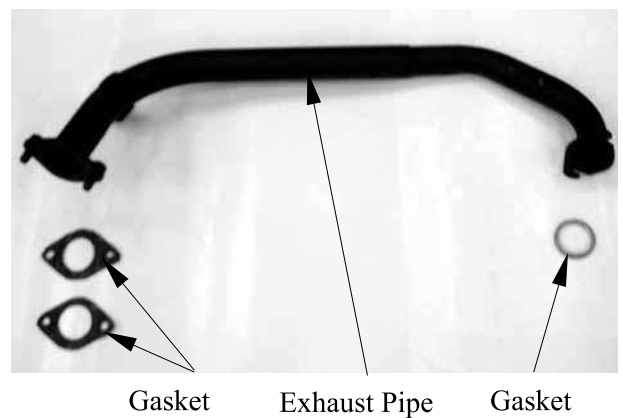

2. FRAME COVERS/EXHAUST MUFFLER

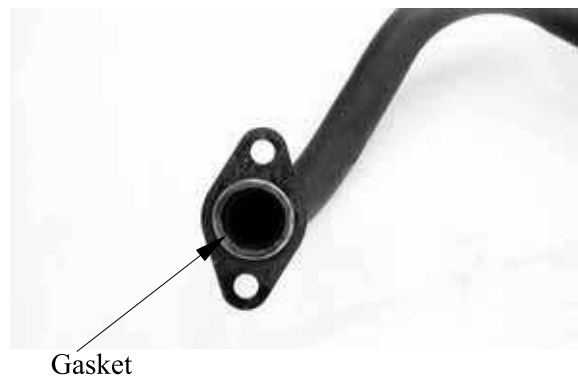
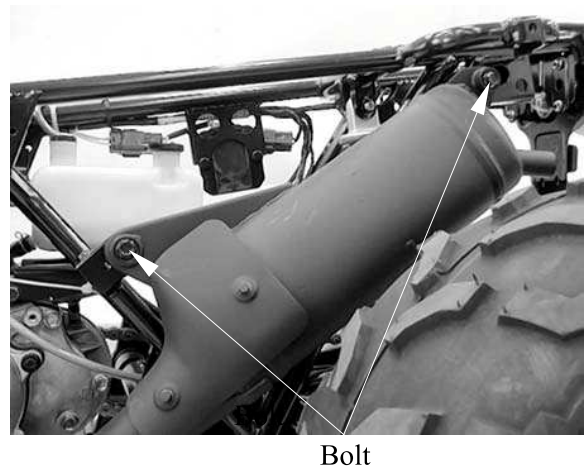
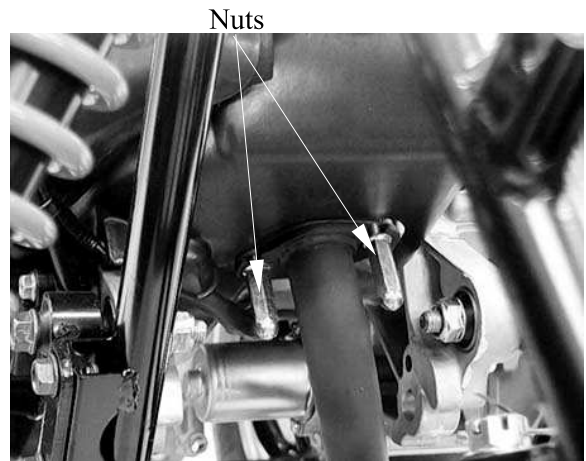

Be sure to install a new exhaust gasket.

3. INSPECTION/ADJUSTMENT

3. INSPECTION/ADJUSTMENT

3. INSPECTION/ADJUSTMENT

ITEM	WHICHEVER COMES FIRST	ROUTINE			
		mi	100	600	1200
		Km	150	1000	2000
		MONTH	1	6	12
Transmission oil	<ul style="list-style-type: none"> •Check oil level/oil leakage •Replace every 12 months. 		<input type="radio"/>		<input type="radio"/>
*V-belt	<ul style="list-style-type: none"> •Check operation. •Replace if damage or excessive wear. 		<input type="radio"/>		<input type="radio"/>
Air filter element	<ul style="list-style-type: none"> •Clean. •Replace if necessary. 	Every 20~40 hours (150~300km, 100~200mi) (More often in wet or dusty areas.)			
*Carburetor	<ul style="list-style-type: none"> •Check idle speed/starter operation. •Adjust if necessary. 		<input type="radio"/>	<input type="radio"/>	<input type="radio"/>
*Fuel line	<ul style="list-style-type: none"> •Check fuel hose for cracks or damage. •Replace if necessary. 			<input type="radio"/>	<input type="radio"/>
Spark plug	<ul style="list-style-type: none"> •Check condition. •Adjust gap and clean. •Replace if necessary. 		<input type="radio"/>	<input type="radio"/>	<input type="radio"/>
*Wheels	<ul style="list-style-type: none"> •Check balance/damage/runout. •Replace if necessary. 		<input type="radio"/>	<input type="radio"/>	<input type="radio"/>
*Wheel bearings	<ul style="list-style-type: none"> •Check bearing assembly for looseness/damage •Replace if damage. 		<input type="radio"/>	<input type="radio"/>	<input type="radio"/>
*Brake	<ul style="list-style-type: none"> •Check operation and brake fluid. •Replace brake pad if necessary. 		<input type="radio"/>	<input type="radio"/>	<input type="radio"/>
Drive chain	<ul style="list-style-type: none"> •Check slack/alignment/clean/lube. •Adjust slack if necessary. 		<input type="radio"/>	<input type="radio"/>	<input type="radio"/>
Battery	<ul style="list-style-type: none"> •Check specific gravity. •Check breather hose for proper operation. •Correct if necessary. 		<input type="radio"/>	<input type="radio"/>	<input type="radio"/>
*Exhaust system	<ul style="list-style-type: none"> •Check leakage. •Retighten if necessary. •Replace gasket if necessary. 			<input type="radio"/>	<input type="radio"/>
*Steering system	<ul style="list-style-type: none"> •Check operation. •Replace if damaged. •Check toe-in. •Adjust if necessary. 		<input type="radio"/>	<input type="radio"/>	<input type="radio"/>
*Knuckle shafts/ Steering shaft	<ul style="list-style-type: none"> •Lubricate every 6 months. 			<input type="radio"/>	<input type="radio"/>
*Fittings and Fasteners	<ul style="list-style-type: none"> •Check all chassis fittings and fasteners. •Correct if necessary. 		<input type="radio"/>	<input type="radio"/>	<input type="radio"/>

3. INSPECTION/ADJUSTMENT

*

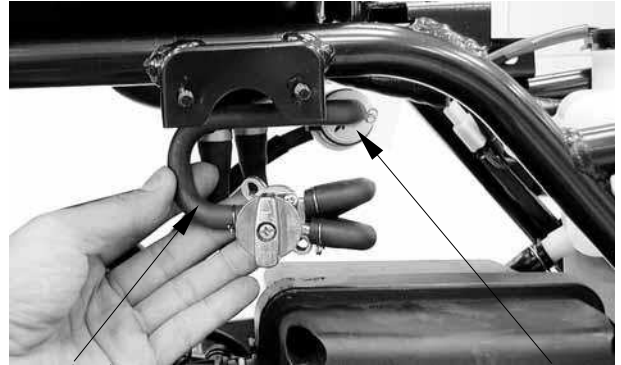

Fuel tube

Fuel Filter



Adjusting Nut

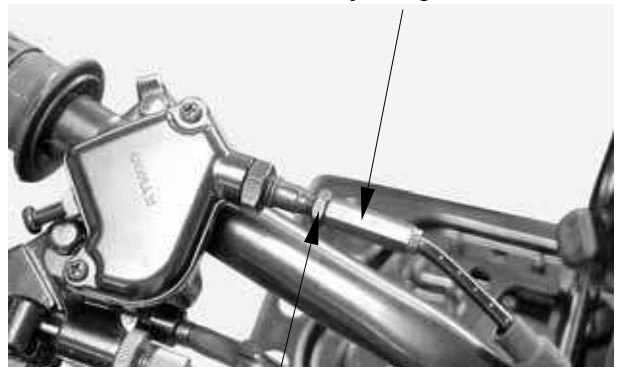

Lock Nut

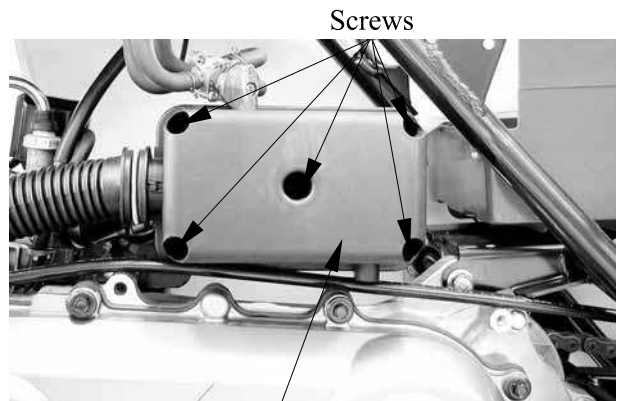

Screws

Air Cleaner Case Cover

3. INSPECTION/ADJUSTMENT

- * ^r use gasoline or low flash point solvents which may lead to a fire or explosion.

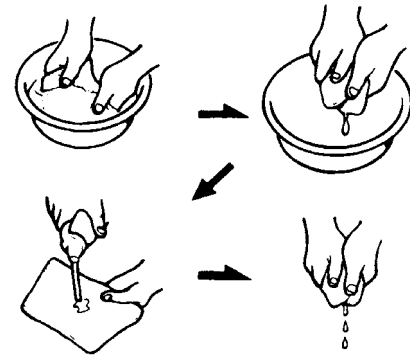

- * Do not twist or wring out the foam element. This could damage the foam material.

- * The element should be wet but not dripping.



3. INSPECTION/ADJUSTMENT

SPARK PLUG

Remove the spark plug
 Check the spark plug for wear and fouling deposits.
 Clean any fouling deposits with a spark plug cleaner or a wire brush.
Specified Spark Plug: NGK-BR8HAS



Measure the spark plug gap.

Spark Plug Gap:

0.6~0.7 mm (0.024 – 0.028)

* When installing, first screw in the spark plug by hand and then tighten it with a spark plug wrench.

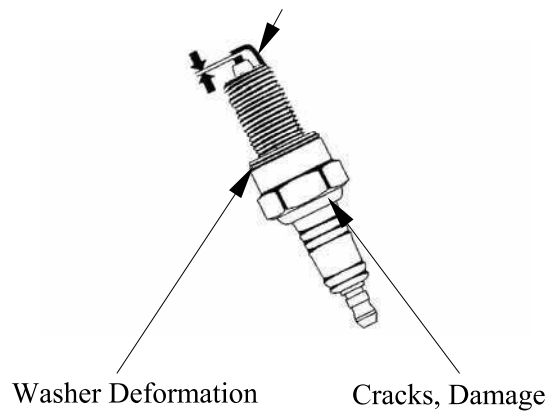

LUBRICATION SYSTEM

《Oil Filter Cleaning》

Disconnect the oil tube at the oil pump side and allow oil to drain into a clean container.
 Remove the tube clip at the oil tank side and disconnect the oil tube.
 Remove the oil filter.

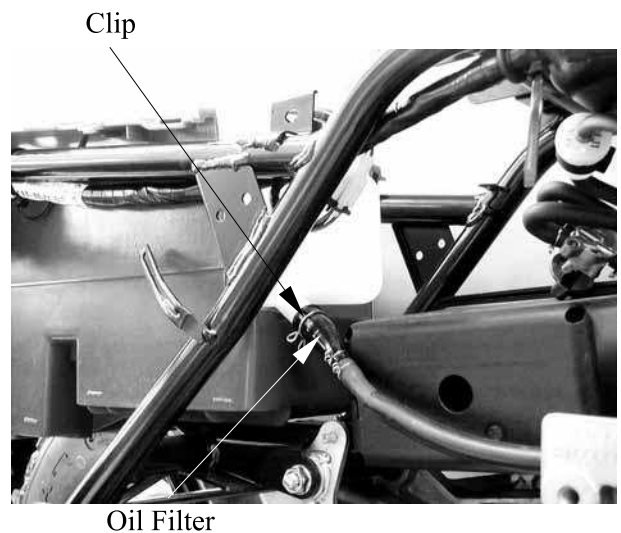

3. INSPECTION/ADJUSTMENT

*

- Connect the oil tubes securely.
- Install the tube clip at the oil tank side and also install the clip to the lower oil tube that goes to the oil pump.
- Check for oil leaks.

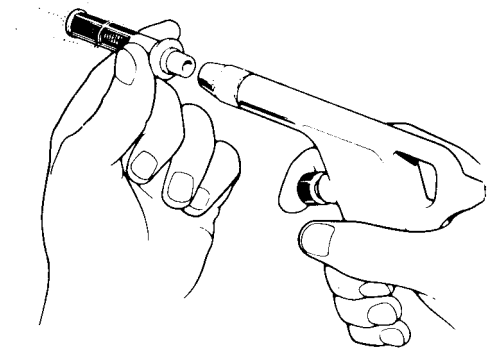

*

Adjust oil pump control cable after the throttle grip free play is adjusted.



*

Reference tip alignment within 1mm of index mark on open side is acceptable. However, the aligning mark on the control lever must never be on the closed side of the index mark, otherwise engine damage will occur because of insufficient lubrication.

3. INSPECTION/ADJUSTMENT

- * The engine must be warm for accurate idle speed inspection and adjustment.



r Screw

- * The CDI ignition timing is not adjustable. If the timing is incorrect, check the CDI unit, ignition coil and A.C. generator and replace any faulty parts.

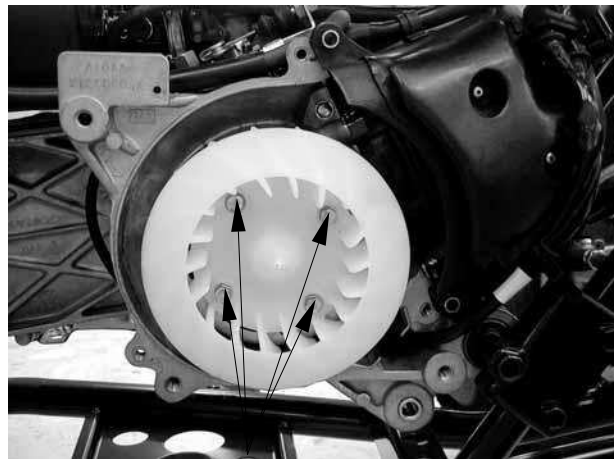

Bolts



Index Mark

"F" Mark

3. INSPECTION/ADJUSTMENT

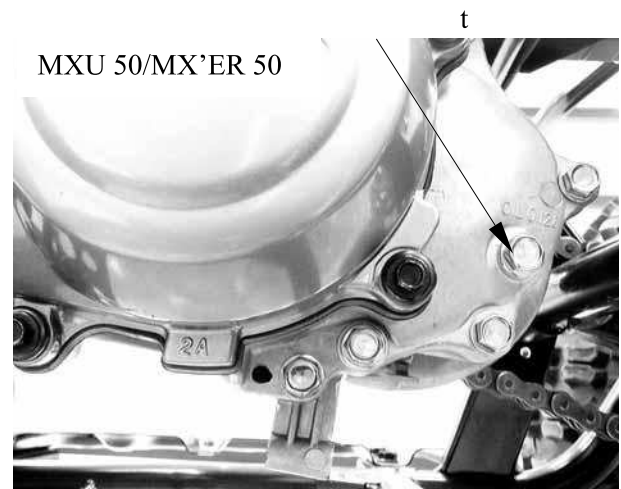

3. INSPECTION/ADJUSTMENT

* Make sure that the sealing washer is in good condition.

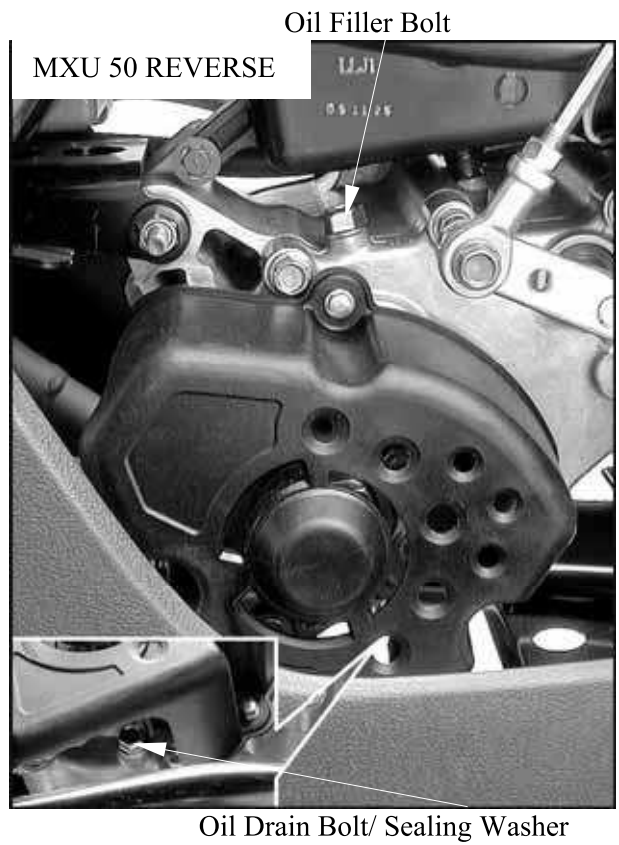
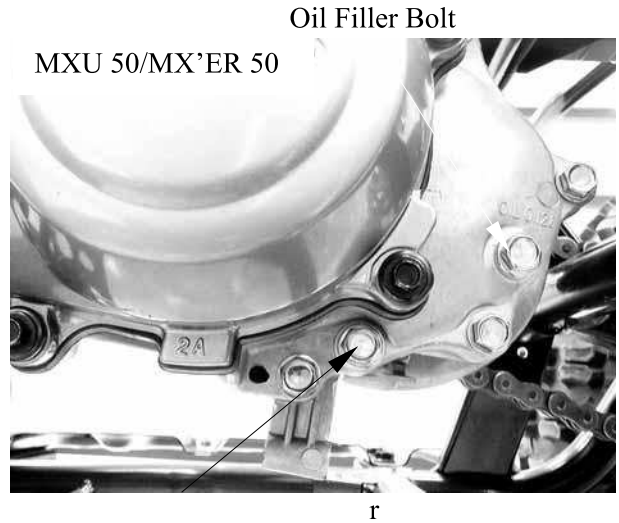

3. INSPECTION/ADJUSTMENT

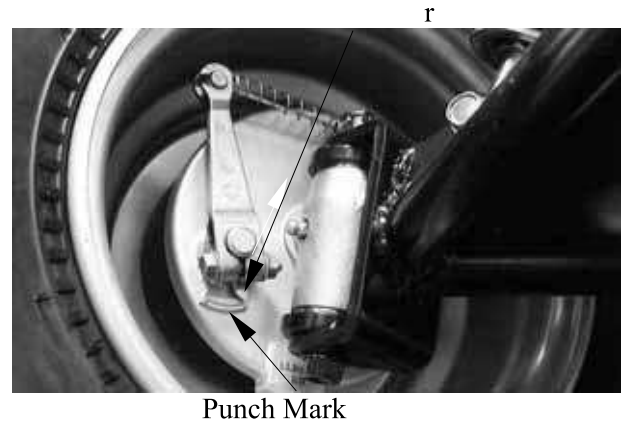
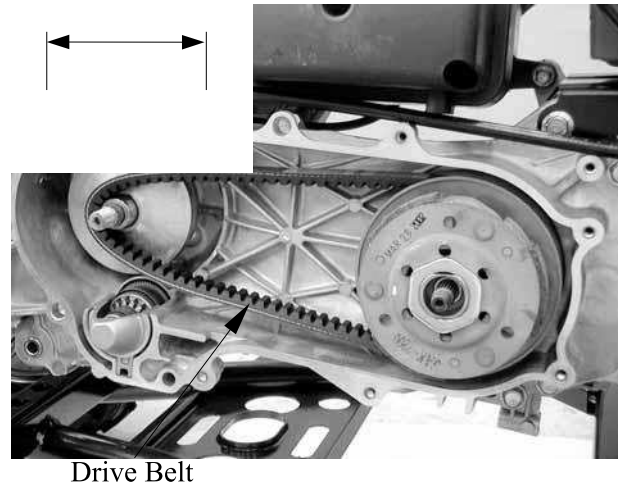

3. INSPECTION/ADJUSTMENT

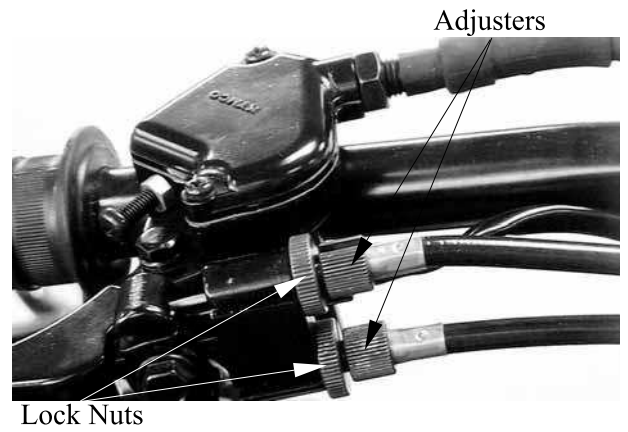

* Make sure that the brake does not drag after adjusting.

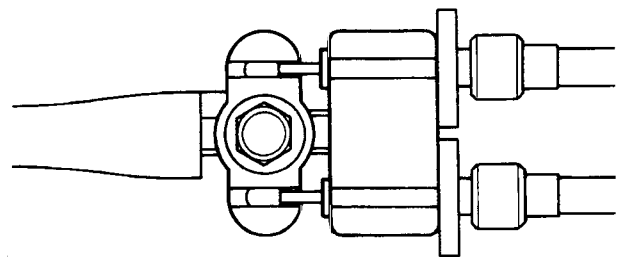

t

3. INSPECTION/ADJUSTMENT



Adjust Screws

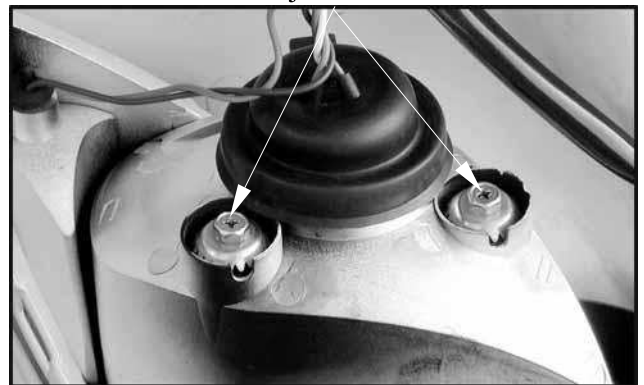

3. INSPECTION/ADJUSTMENT

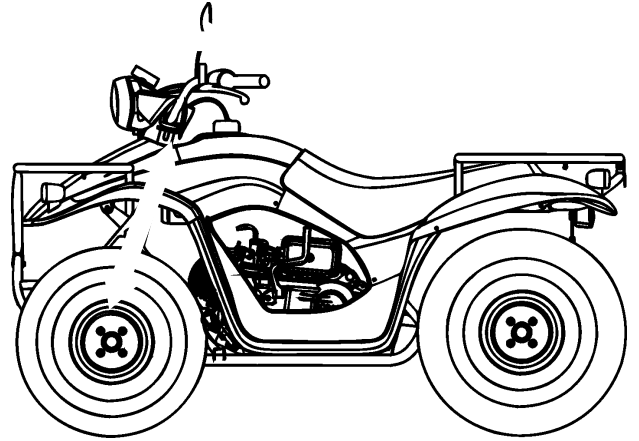

3. INSPECTION/ADJUSTMENT

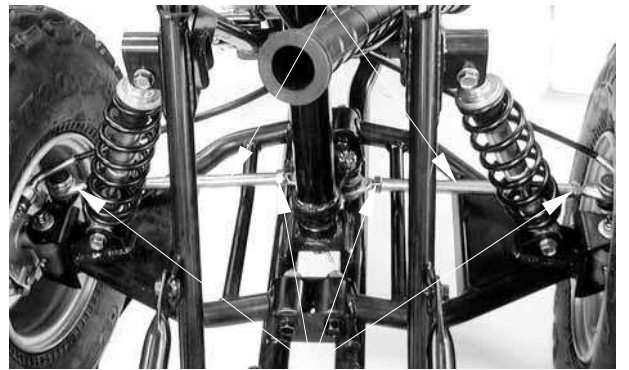
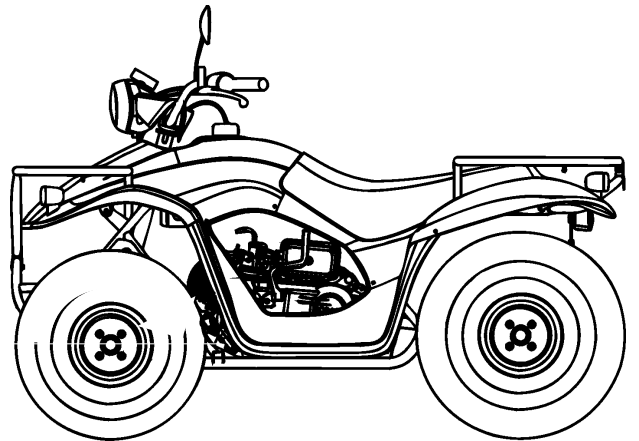
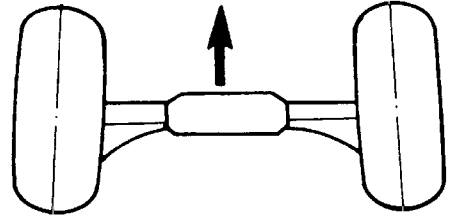

*

3. INSPECTION/ADJUSTMENT

* Tire pressure should be checked when tires are cold.



t



Rear Axle Nut



*

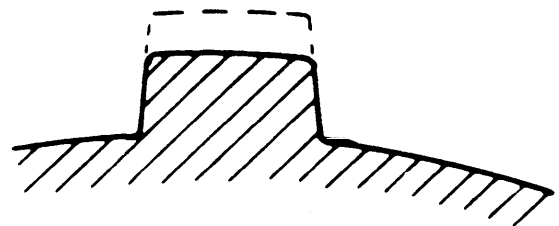

3. INSPECTION/ADJUSTMENT

*

* Too little of chain slack will overload the engine and other vital parts; keep the slack within the specified limits.



* Wheels should be on the ground without the rider on it.

* Support the machine securely so there is no danger of it falling over.

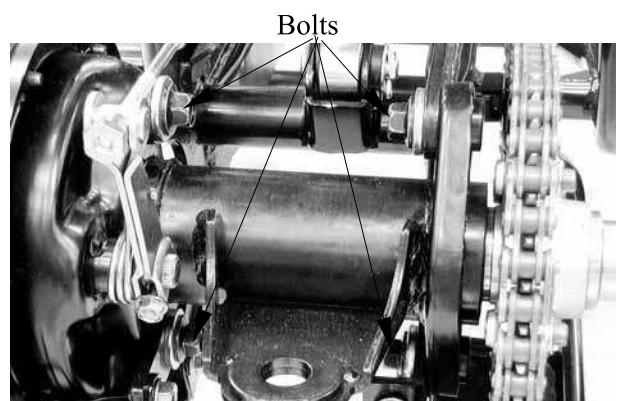

3. INSPECTION/ADJUSTMENT

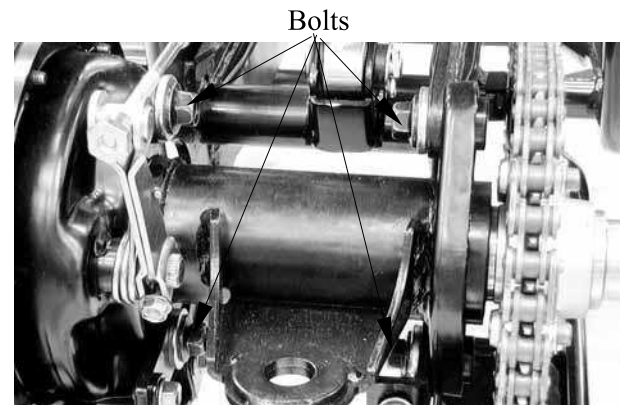
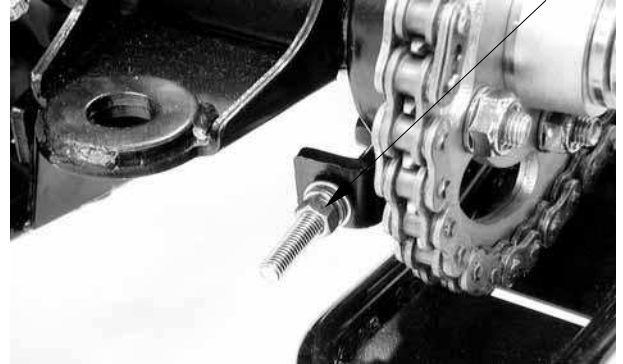

3. INSPECTION/ADJUSTMENT

* Damaged cable sheath may cause corrosion and interfere with the cable movement. An unsafe condition may result so replace such cable as soon as possible.

* Hold cable end high and apply several drops of lubricant to cable.

* Wipe off the excess grease.

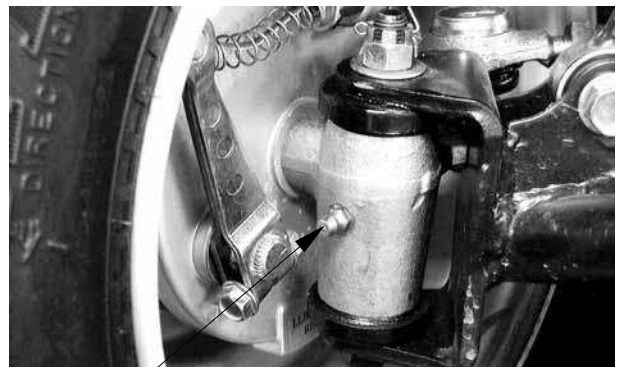

Nipple

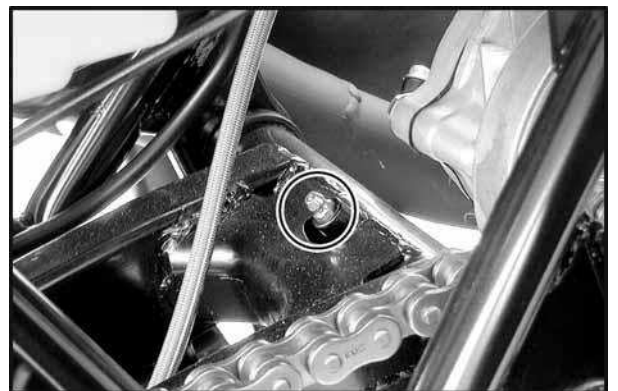

4. LUBRICATION SYSTEM

LUBRICATION SYSTEM

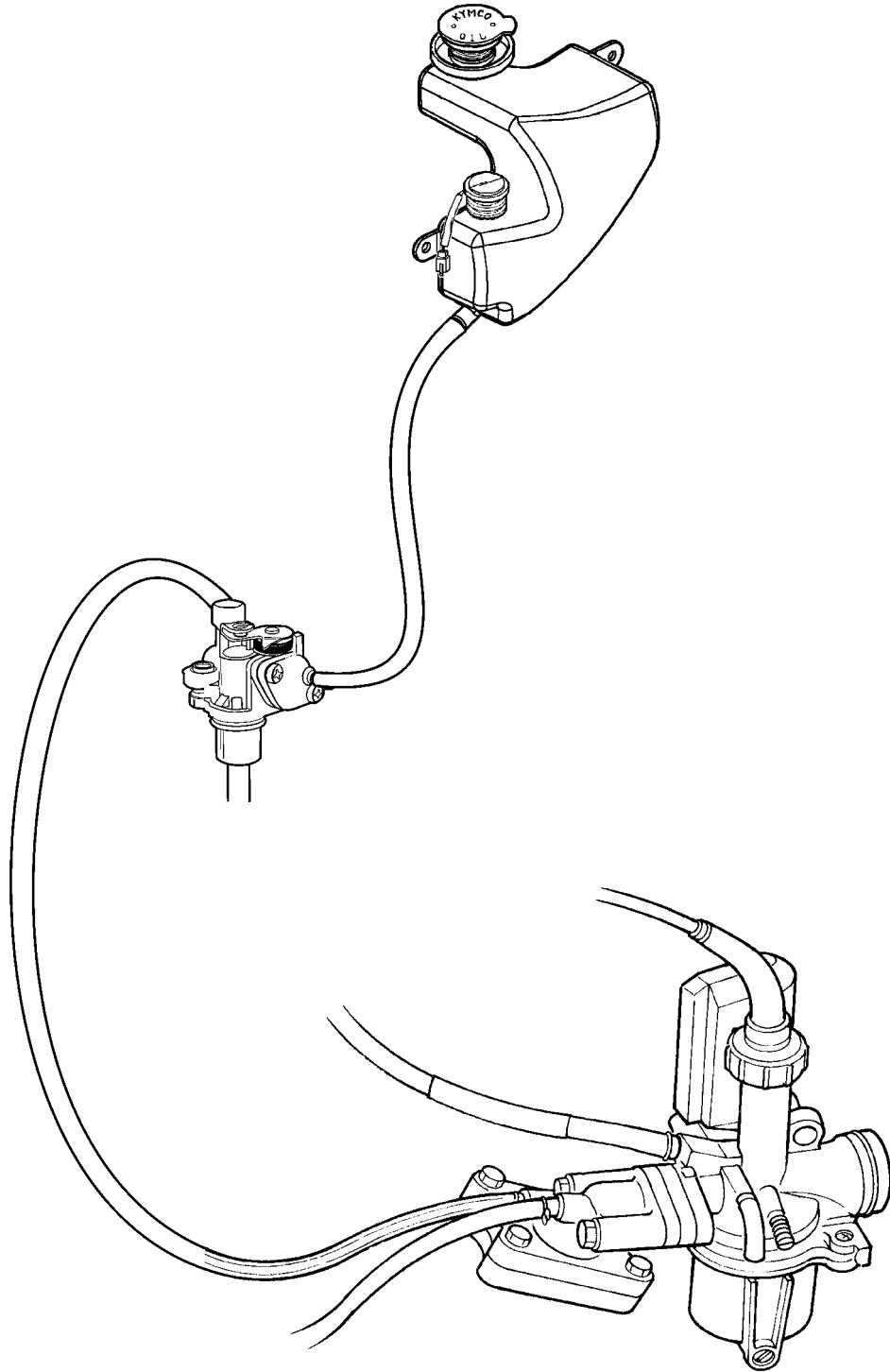

4. LUBRICATION SYSTEM

SERVICE INFORMATION

GENERAL INSTRUCTIONS

- Use care when removing and installing the oil pump not to allow dust and dirt to enter the engine and oil line.
- Do not attempt to disassemble the oil pump.
- Bleed air from the oil pump if there is air between the oil pump and oil line.
- If the oil is disconnected, refill the oil line with motor oil before connecting it.

SPECIFICATIONS

- Recommended Motor Oil: SAE20W20# 2-stroke Motor Oil
- Oil Capacity : 1 liter (0.88 Imp qt, 1.06 Us qt)
Light comes on : 0.25 liter (0.22 Imp qt, 0.27 Us qt)

TROUBLESHOOTING

Excessive white smoke or carbon deposits on spark plug

- Oil pump not properly synchronized (excessive oil)
- Poor quality oil

Engine overheating

- Oil pump not properly adjusted (insufficient oiling)
- Poor quality oil

Seized piston

- No oil in tank or clogged oil line
- Oil pump not properly adjusted (insufficient oiling)
- Air in oil line
- Faulty oil pump

Oil not flowing out of tank to engine

- Clogged oil tank cap breather hole
- Clogged oil filter

4. LUBRICATION SYSTEM

OIL PUMP REMOVAL

Do not allow foreign matters to enter the crankcase. Before removing the oil pump, clean the oil pump and crankcase surfaces.

Disconnect the oil pump control cable from the pump body.
 Disconnect the oil inlet line from the oil pump.
 Then, disconnect the oil outlet line.

Before disconnecting the oil line, clip the oil line to avoid oil flowing out and then plug the oil line after it is disconnected.

Remove the oil pump control cable plate bolt.
 Remove the oil pump from the crankcase.

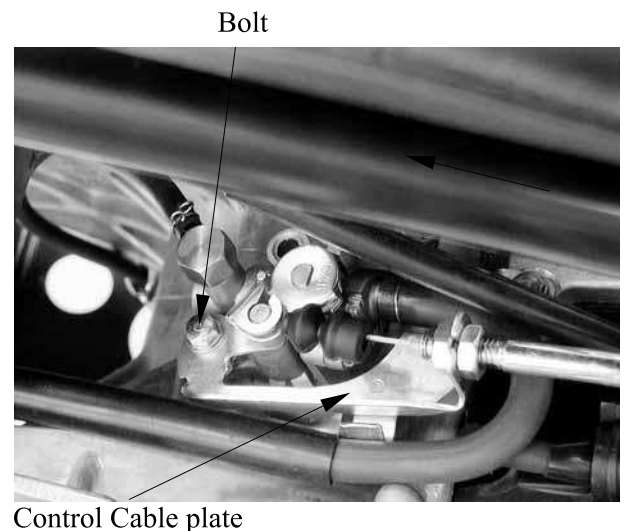
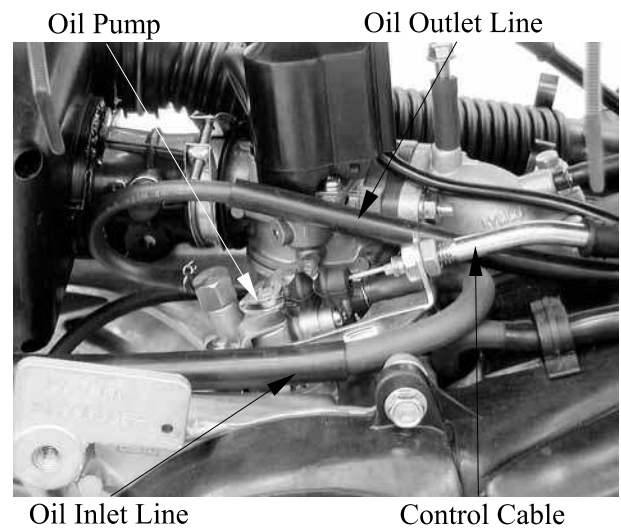

OIL PUMP INSPECTION

Remove the oil pump and inspect the following items:

- Weakened O-ring
- Damage to crankcase mating surface
- Damage to pump body
- Control lever operation
- Oil leaks through oil seals
- Worn or damaged pump pinion

Do not disassemble the oil pump which cannot be used after disassembly.

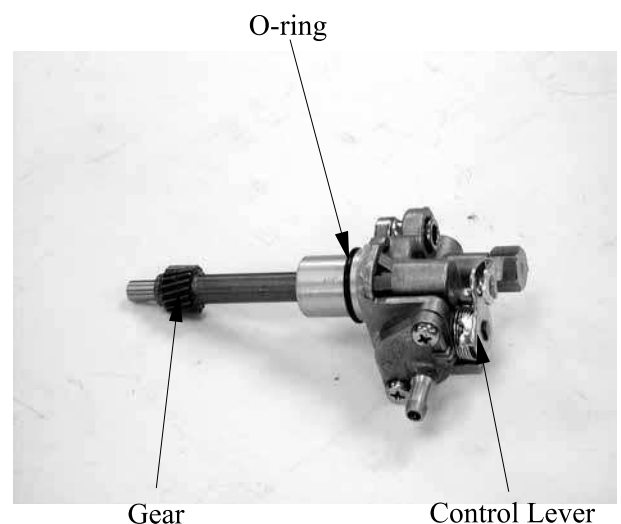

4. LUBRICATION SYSTEM

OIL PUMP INSTALLATION

- Lubricate the O-ring with grease or engine oil before installation.
- Make sure that the oil pump is inserted into the crankcase.
- Apply molybdenum disulfide or grease to the pump pinion.

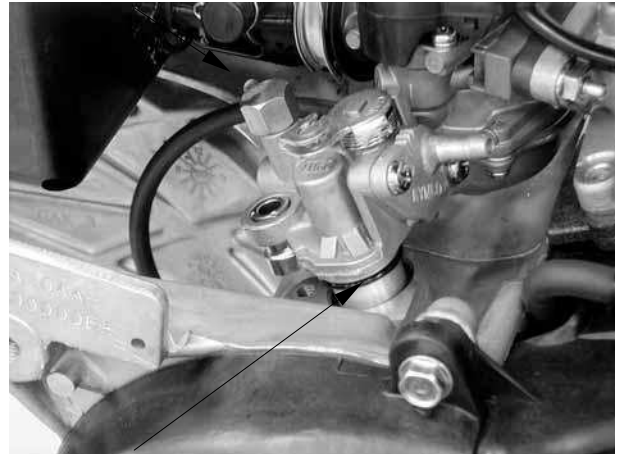

Grease or Engine Oil

Install the oil pump onto the crankcase.



Install the oil pump control cable plate.
Connect the oil inlet line and oil outlet line properly.
Connect the oil pump control cable.
Bleed air from the oil pump.



Oil Inlet Line

Control Cable

4. LUBRICATION SYSTEM

OIL PUMP BLEEDING

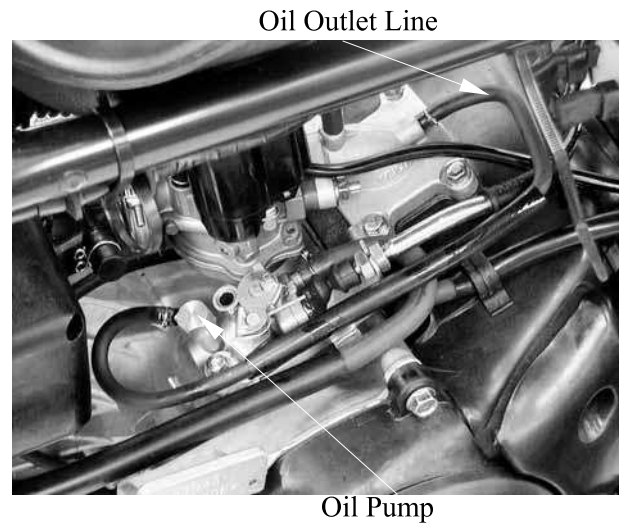

OIL INLET LINE/OIL PUMP BLEEDING

Fill the oil tank with recommended oil.
Place a shop towel around the oil pump.
Disconnect the oil inlet line from the oil pump and clip it.
Fill the oil pump with oil by squirting clean oil through the joint. (About 3cc, 0.003 Imp qt, 0.003 Us qt)
Fill the oil line with oil and connect it to the oil pump.

Bleed air from the oil inlet line first, then bleed air from the oil outlet line.

OIL OUTLET LINE BLEEDING

1. Disconnect the oil outlet line and bend it into U shape. Force air out of the tube by filling it with oil.
2. Start the engine and allow it to idle with the oil control lever in the fully open position. Visually check the oil flow.
3. If there is no oil flowing out within 1 minute, bleed air from the oil inlet line and oil pump.

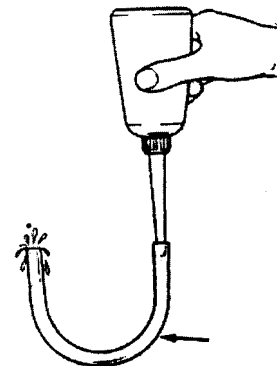

- Never run the engine in a closed area.
- Do not increase the engine speed at will.

4. LUBRICATION SYSTEM

OIL TANK

OIL TANK REMOVAL

Remove the seat. (⇒2-3 or 2-8)
Remove the oil meter connector.
Remove the one bolt and one nut from the oil tank. (see page 2-14)
Disconnect the oil inlet line.
Drain the oil inside the oil tank into a clean container.
Remove the oil tank.
The installation sequence is the reverse of removal.



- Connect the oil line properly.
- Bleed air from the oil pump after installation.
- The oil tube clip (at the oil tank side) must be locked from inside of the oil tube joint.

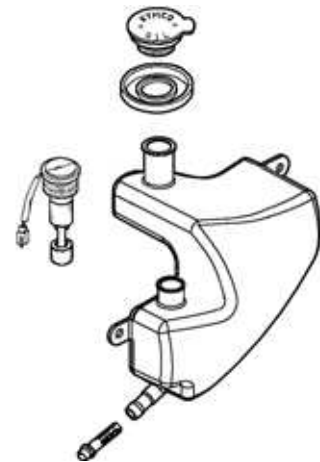

5. FUEL SYSTEM

5

FUEL SYSTEM

SERVICE INFORMATION-----	5- 2
TROUBLESHOOTING-----	5- 2
THROTTLE VALVE DISASSEMBLY/CARBURETOR REMOVAL--	5- 3
AUTO BYSTARTER -----	5- 6
FLOAT/FLOAT VALVE/JETS/FLOAT CHAMBER-----	5- 8
CARURETOR INSTALLATION -----	5-11
AIR SCREW ADJUSTMENT -----	5-12
REED VALVE -----	5-13
FUEL TANK -----	5-14
FUEL VALVE REMOVAL -----	5-15
AIR CLEANER -----	5-15

5. FUEL SYSTEM

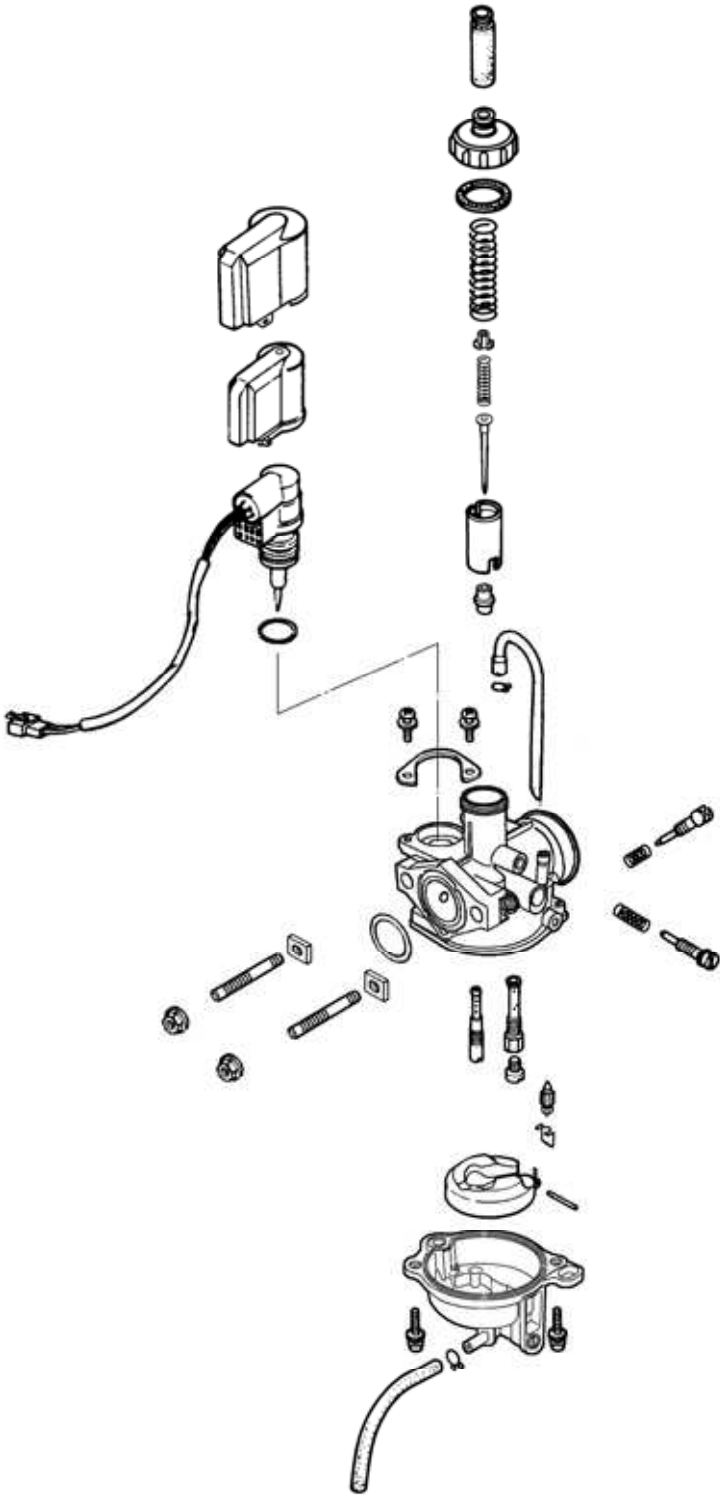

5. FUEL SYSTEM

SERVICE INFORMATION

GENERAL INSTRUCTIONS

- When working with gasoline, keep away from sparks and flames..
- Note the locations of O-rings when disassembling and replace them with new ones during assembly.
- All cables, fuel lines and wires must be routed and secured at correct locations.
- Bleed air from the oil lines whenever they are disconnected.

SPECIFICATIONS

SPECIFICATIONS	ATV 50
Venturi dia.	14 mm (0.56 in)
Identification number	PB
Float level	8.6 mm (0.34 in)
Main jet	# 80
Slow jet	# 38S
Air screw opening	2 ± 1/2
Idle speed	1800±100 rpm
Throttle grip free play	1 ~ 4 mm (0.04 – 0.16 in)

SPECIAL TOOL

Float level gauge

TROUBLESHOOTING

Engine does not start

- No fuel in tank
- Too much fuel getting to cylinder
- Clogged fuel filter
- Clogged air cleaner

Lean mixture

- Clogged fuel jets
- Clogged fuel cap vent
- Clogged fuel filter
- Bent, kinked or restricted fuel line

- Faulty float valve
- Float level too low
- Clogged air cleaner

Engine idles roughly, stalls or runs poorly

- Incorrect idle speed
- Ignition malfunction
- Compression too low
- Incorrectly adjusted air screw
- Incorrect float level
- Clogged air cleaner
- Intake air leaks
- Fuel contaminated
- Faulty reed valve
- Clogged fuel jets

Rich mixture

- Faulty float valve
- Float level too high
- Clogged air jets

5. FUEL SYSTEM

THROTTLE VALVE DIS-ASSEMBLY/CARBURETOR REMOVAL

Loosen the carburetor cap and remove the throttle valve.

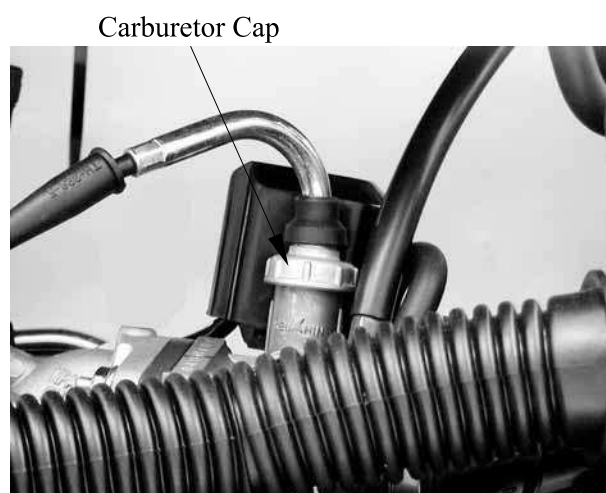

Disconnect the throttle cable from the throttle valve.

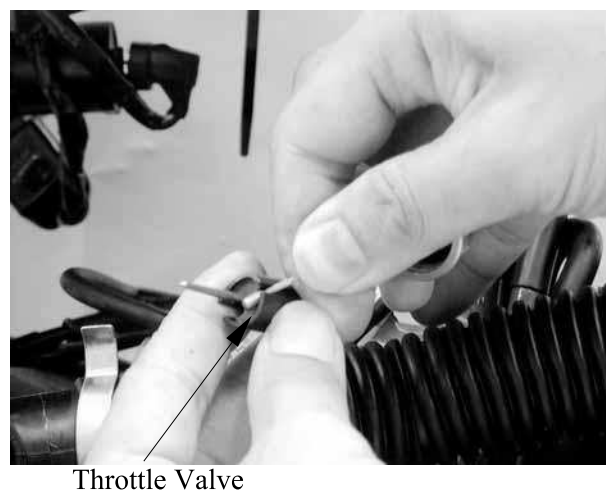

Remove the throttle valve spring, carburetor cap and rubber seal.

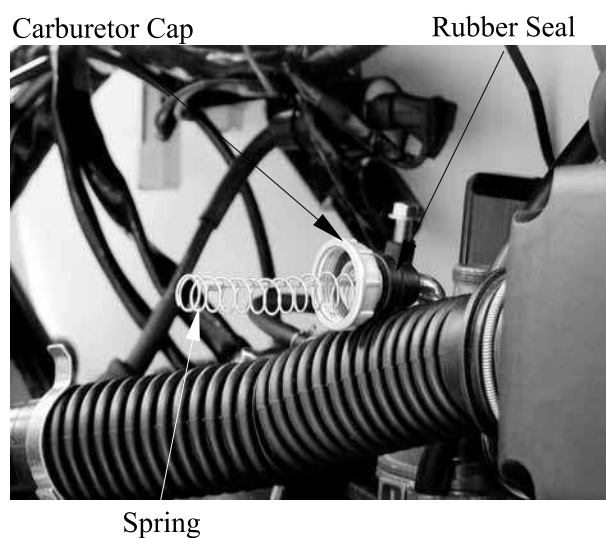

5. FUEL SYSTEM

Remove the jet needle by removing the needle clip.
Check the jet needle and throttle valve for wear or damage.

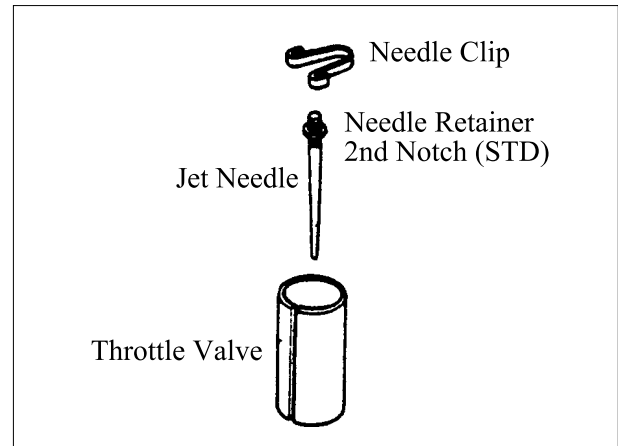

THROTTLE VALVE INSTALLATION

Install the jet needle on the throttle valve and secure with the needle clip.

Install the rubber seal on the throttle cable and then install the carburetor cap and throttle valve spring.

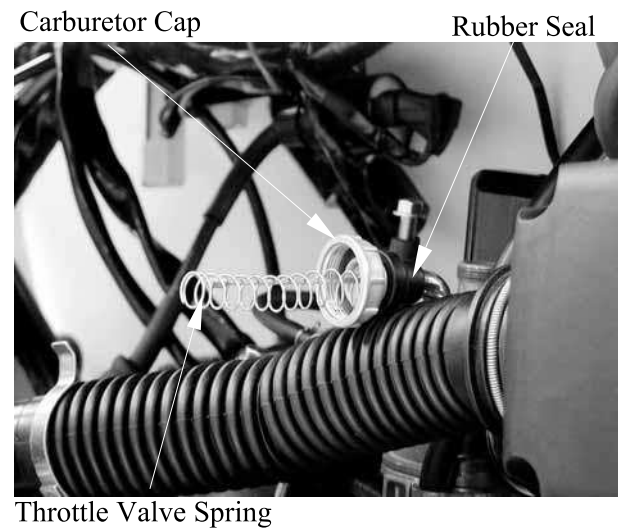

Connect the throttle cable to the throttle valve.

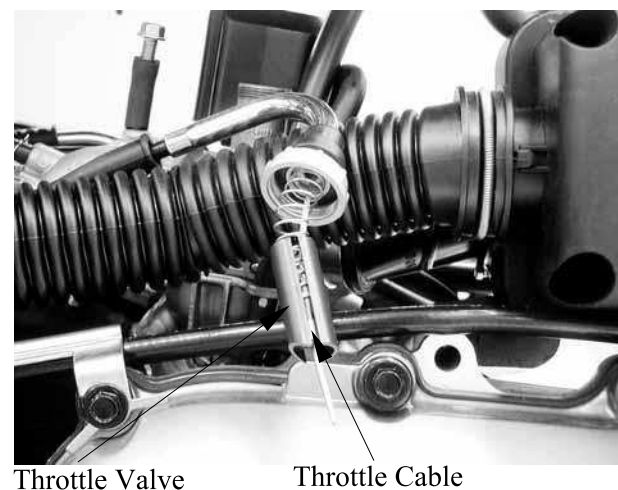

5. FUEL SYSTEM

Install the throttle valve by aligning the groove in the throttle valve with the throttle stop screw.

Groove



Tighten the carburetor cap.
After installation, perform the following adjustments and inspections.

- Throttle cable free play (⇒3-3)
- Idle speed adjustment (⇒3-7)

Carburetor Cap



CARBURETOR REMOVAL

Remove the air cleaner by removing the air cleaner band screw and attaching bolts.
Disconnect the fuel tube.
Loosen the drain bolt to drain fuel from the carburetor.
Disconnect the auto bystarter wire connector.

Throttle Cable Bystarter Fuel Tube



Drain Bolt

Band

5. FUEL SYSTEM

Remove the two carburetor lock nuts.
Remove the carburetor.



Nuts

AUTO BYSTARTER

AUTO BYSTARTER INSPECTION

Measure the resistance between the auto bystarter wire terminals.

Resistance: 5Ω (10 minutes minimum after stopping the engine)

If the resistance exceeds 5Ω , replace the auto bystarter with a new one.



After the engine stops for 30 minutes, connect a hose to the fuel enriching circuit and blow the hose with mouth.

If air cannot be blown into the hose (clogged), the auto bystarter is faulty. Replace it with a new one.

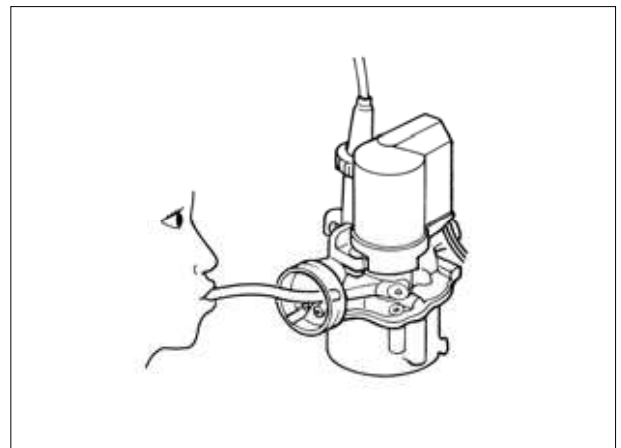

5. FUEL SYSTEM

Connect the auto bystarter yellow wire to the battery positive (+) terminal and green/ black wire to the battery negative (-) terminal and wait 5 minutes.

Connect a hose to the fuel enriching circuit and blow the hose with mouth.

If air can be blown into the hose, the auto bystarter is faulty and replace it with a new one.

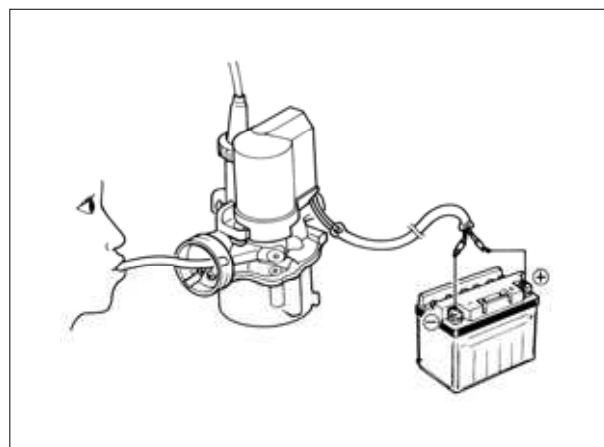

AUTO BYSTARTER REMOVAL

Remove the auto bystarter cover.

Remove the two auto bystarter set plate screws to remove the auto bystarter.

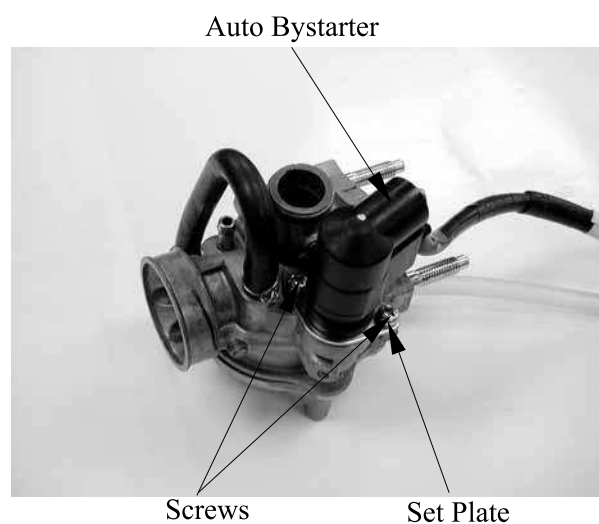

Check the auto bystarter valve and needle for wear or damage.

Check the O-ring for wear or damage.

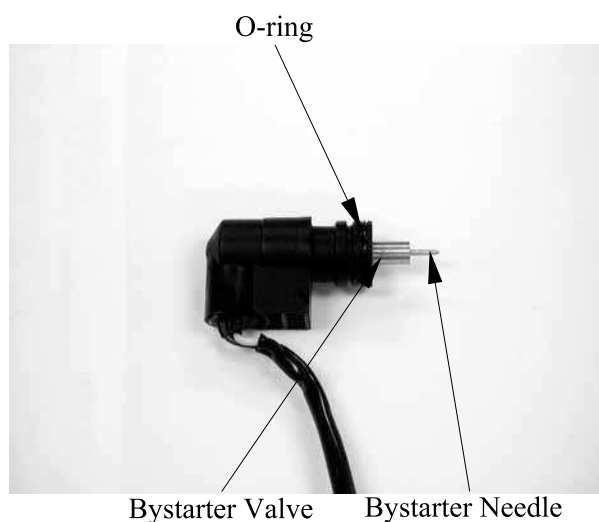

5. FUEL SYSTEM

AUTO BYSTARTER INSTALLATION

Install the auto bystarter into the carburetor body until it bottoms..
Install the set plate and then tighten the two screws.

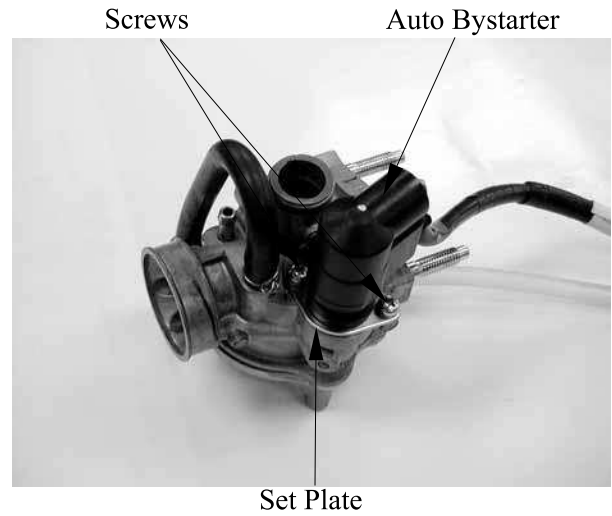

FLOAT/FLOAT VALVE/JETS FLOAT CHAMBER

Remove the two float chamber screws and the float chamber.

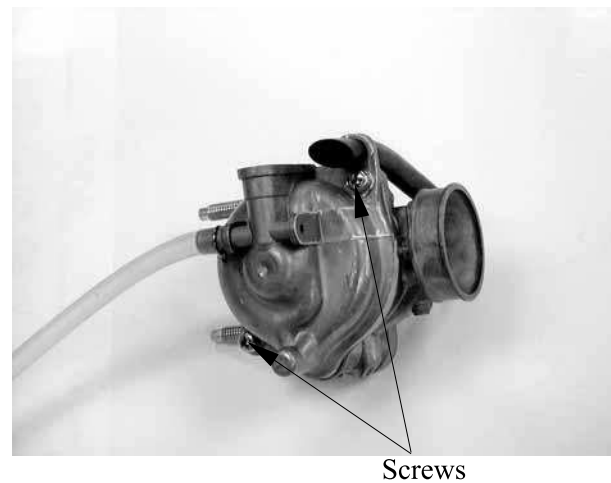

Remove the screw and O-ring.
Remove the float pin, float and float valve.

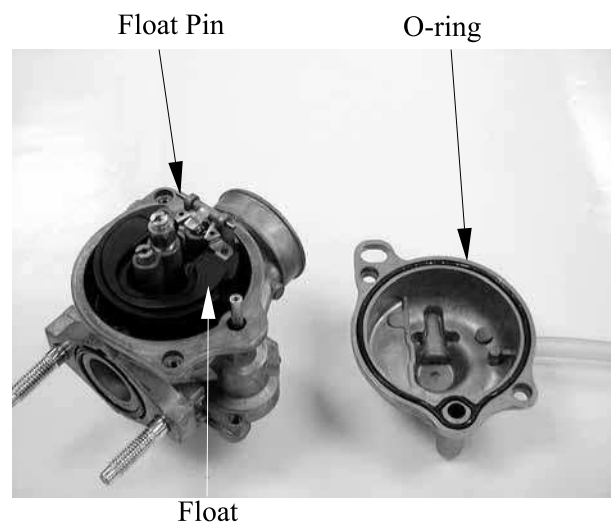

5. FUEL SYSTEM

FLOAT/FLOAT VALVE INSPECTION

Inspect the float for damage or fuel inside the float.
Check the float valve seat for wear or damage.

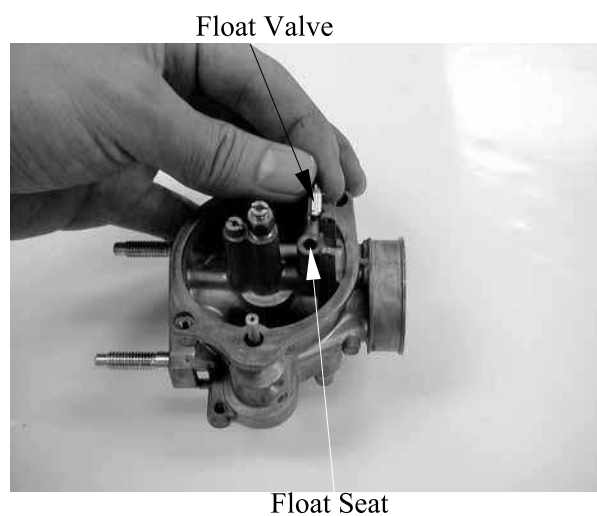

JETS/SCREWS REMOVAL

Before removing the throttle stop screw or air screw, record the number of rotations until it seats lightly. Then, remove them.

* Do not force the air screw against its seat to prevent damage.

Remove the main jet and needle jet holder.

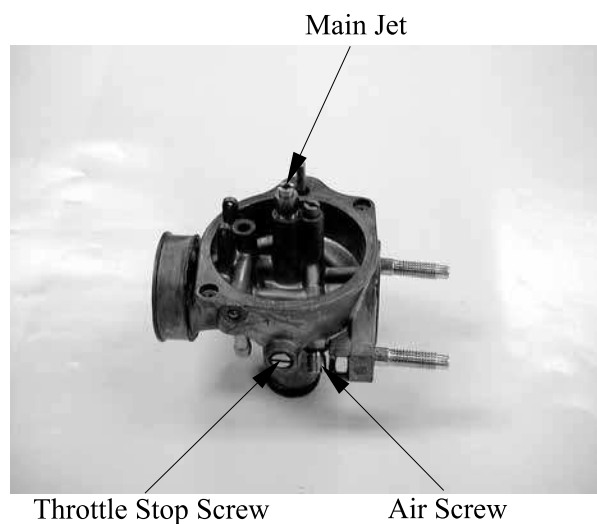

CARBURETOR PASSAGES CLEANING

Blow compressed air through all passages of the carburetor body with an air gun.



5. FUEL SYSTEM

FLOAT CHAMBER ASSEMBLY

Install the main jet and needle jet holder.
Install the air screw and throttle stop screw according to the rotations recorded.

* If the air screw must be replaced, be sure to perform the air screw adjustment again.

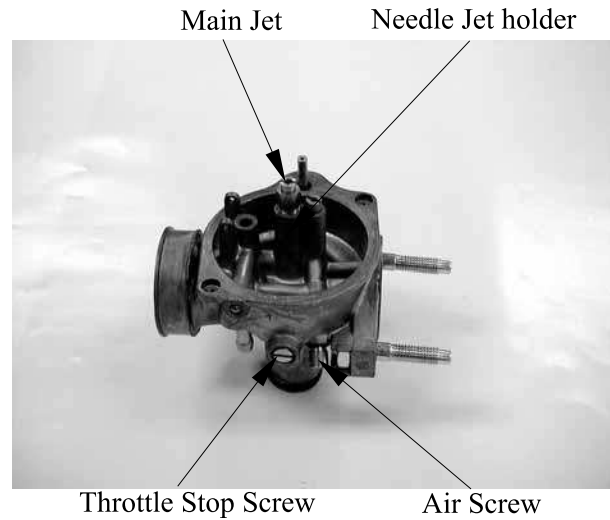

Install the float valve, float and float pin.
Tighten the float screw securely.

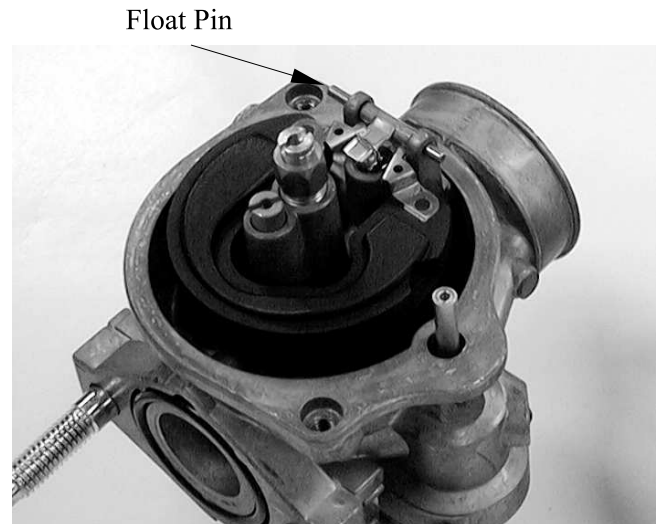

FLOAT LEVEL INSPECTION

Slightly tilt the carburetor and measure the float level with the float valve just connecting the float arm.

Float Level: 8.6 mm (0.34 in)

Replace the float if the level is out of the specified level range.

Install the O-ring.

Check the operation of the float and install the float chamber.

Tighten the screws.



5. FUEL SYSTEM

CARBURETOR INSTALLATION

* When installation, do not allow foreign particles to enter the carburetor.

Check the carburetor insulator and O-ring for wear or damage.

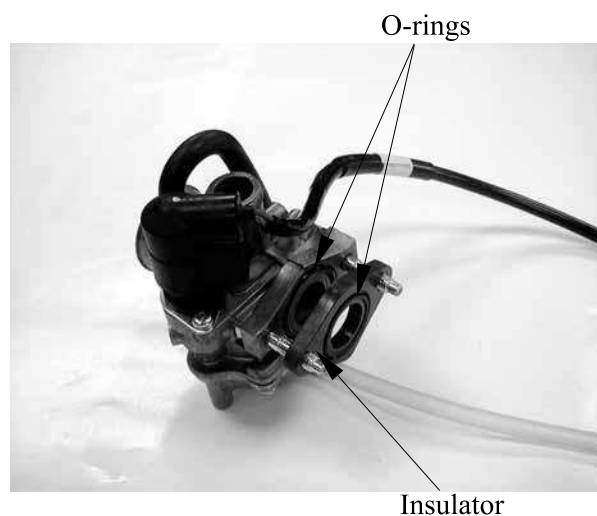

Install the carburetor and insulator onto the intake manifold and tighten the two lock nuts.

Connect the fuel tube and auto bystarter wire connector.

* Route the auto bystarter wire correctly and properly.

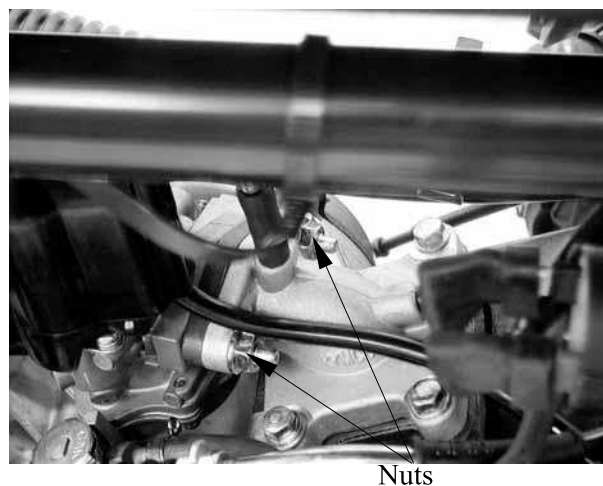

Install the carburetor cap. (⇒5-3)
Install the fuel tube
Install the air cleaner onto the carburetor and tighten the band screw.

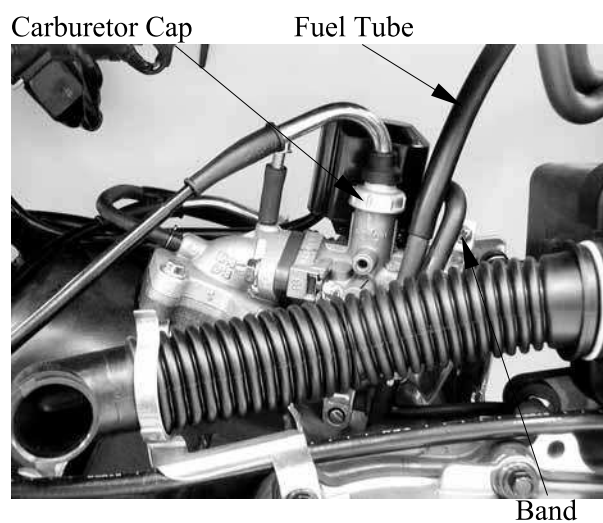

5. FUEL SYSTEM

AIR SCREW ADJUSTMENT

Turn the air screw clockwise until it seats lightly and back it to the specification given.

* Do not force the air screw against its seat to prevent damage.

Start the engine and turn the air screw in or out slowly to obtain the highest engine speed.



Throttle Stop Screw

Turn the throttle stop screw to obtain the specified idle speed.

Idle Speed: 1800±100 rpm

Air Screw Opening: 2 ± 1/2 turns

Slightly increase the engine speed and make sure that the engine does not miss or run erratic.

If the adjustment of the air screw within the range of ±1/2 turn makes no difference to the engine performance, check other related items.

5. FUEL SYSTEM

REED VALVE

REMOVAL

Remove the four intake manifold bolts and gasket.

Remove the reed valve and gasket.

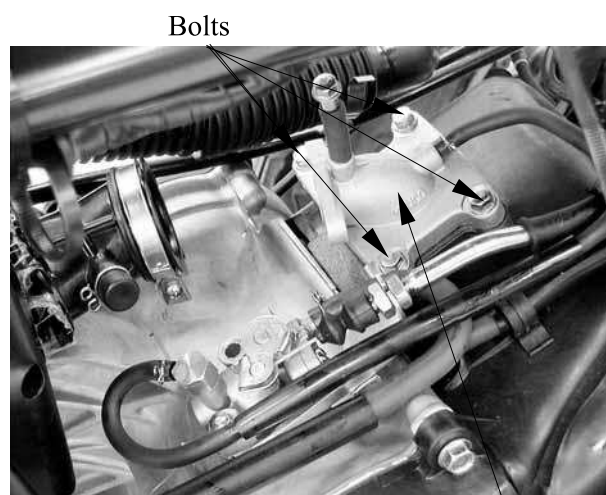

Intake Manifold

INSPECTION

Check the reed valve for damaged or weak reeds.

Check the reed valve seat for cracks, damage or clearance between the seat and reed.

Replace the valve if necessary.

*

Do not disassemble or bend the reed stopper. To do so can cause loss of engine power and engine damage. If any of the stopper, reed or valve seat is faulty, replace them as unit.

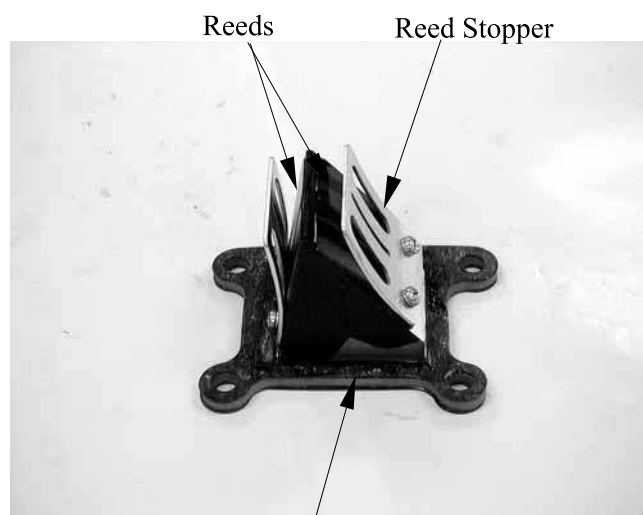

Reed Valve Seat

INSTALLATION

Install the reed valve in the reverse order of removal.

*

Install a new gasket with the gasket indentation aligned with the reed valve. After installation, check for intake air leaks.

5. FUEL SYSTEM

FUEL TANK

FUEL TANK REMOVAL

Warning

- Keep sparks and flames away from the work area.
- Wipe off any spilled gasoline.

Remove the seat.
Remove the center cover.
Remove the right and left front fender.

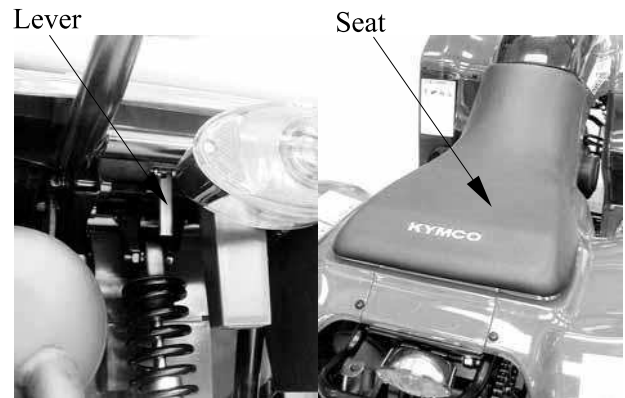

Remove two bolts and two nuts on the end of the fuel tank.

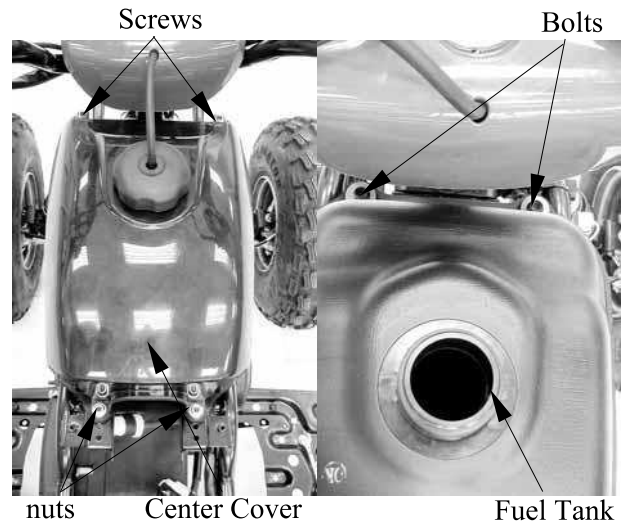

Switch the fuel valve "OFF".
Disconnect the fuel tubes.
Remove the fuel tank and fuel valve.

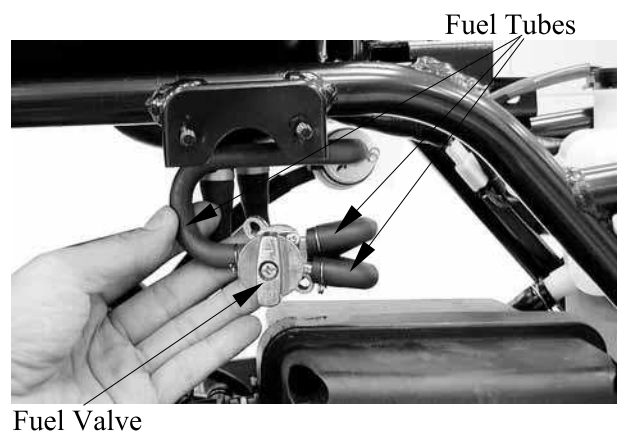

5. FUEL SYSTEM

FUEL VALVE REMOVAL

Disconnect the fuel tubes and remove the bolts.



Fuel Valve

Remove the fuel valve and fuel cup.

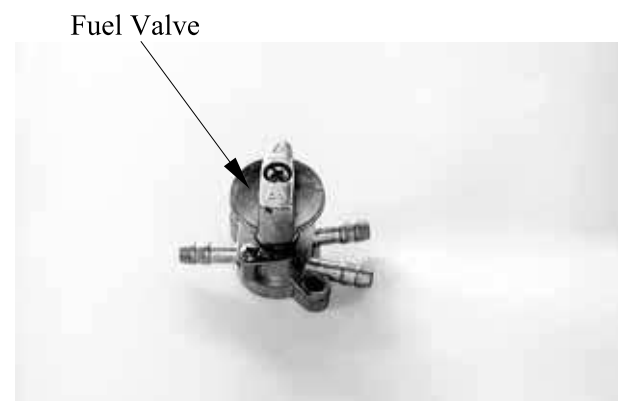

Remove the screw on the fuel valve control switch.
Remove the two screws on the fuel valve body.

INSPECTION

Inspect the fuel valve strainer for dirt and clog. Clean if necessary.

Replace the O-rings with new ones if they are damaged or deteriorated.

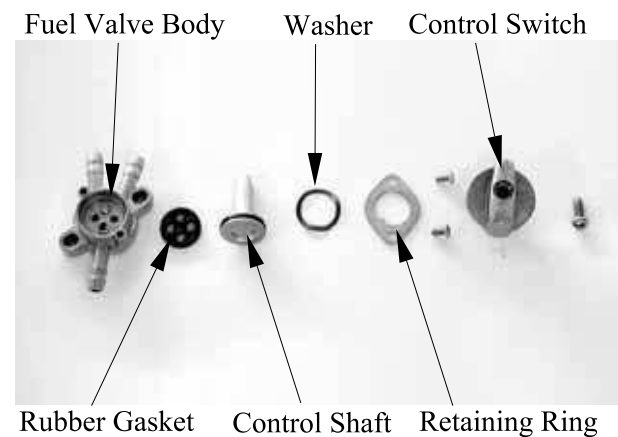

AIR CLEANER

REMOVAL

Remove the five screws on the air cleaner case cover and the cover.
Remove the air cleaner screen and element.

Refer to chapter 3 to clean air filter element.



6. ENGINE REMOVAL/INSTALLATION

ENGINE REMOVAL/INSTALLATION



SERVICE INFORMATION-----	6- 1
ENGINE REMOVAL -----	6- 2
ENGINE INSTALLATION -----	6- 5

6. ENGINE REMOVAL/INSTALLATION

SERVICE INFORMATION

GENERAL INSTRUCTIONS

- A floor jack or other adjustable support is required to support and maneuver the engine.
Be careful not to damage the machine body, cables and wires during engine removal.
- Use shop towels to protect the motorcycle body during engine removal.
- Parts requiring engine removal for servicing:
 - Crankcase
 - Crankshaft

6. ENGINE REMOVAL/INSTALLATION

ENGINE REMOVAL

Remove the frame covers (see chapter 2).
 Remove the exhaust muffler (see chapter 2).
 Remove the oil tank (see chapter 4)
 Remove the fuel tank (see chapter 5).

Remove the two bolts attaching the air cleaner case.
 Loosen the band between the air cleaner and carburetor to remove the air cleaner case.
 Remove the carburetor cap.

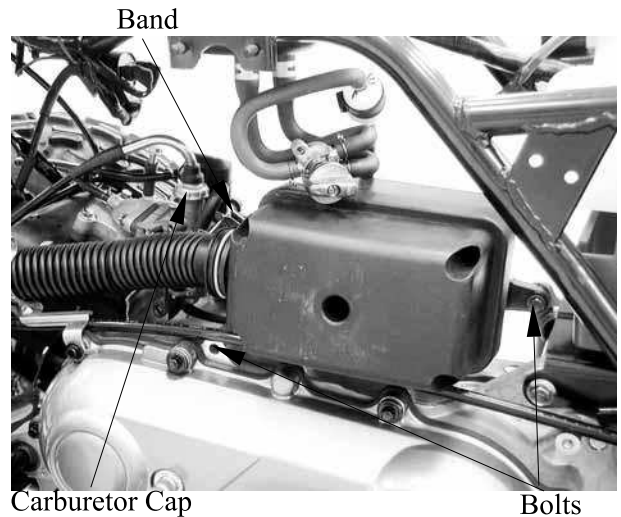

Disconnect the auto bystarter, A.C. generator/pulser and starter motor wire connectors.

A.C. Generator/Pulser Wire Connector

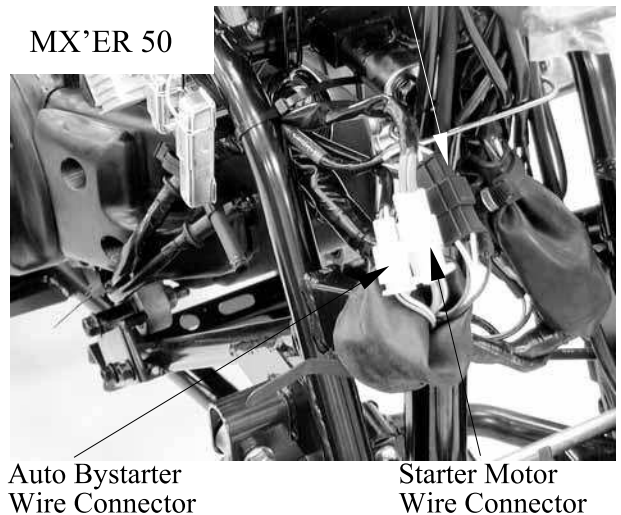

A.C. Generator Wire Connectors

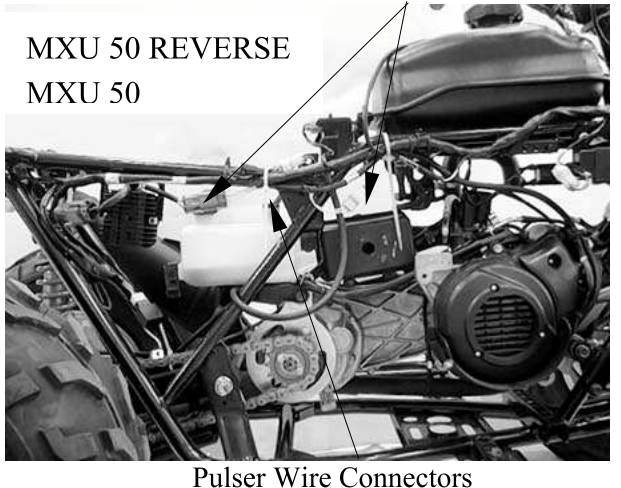

6. ENGINE REMOVAL/INSTALLATION

Starter Motor Wire Connector

MXU 50 REVERSE
MXU 50

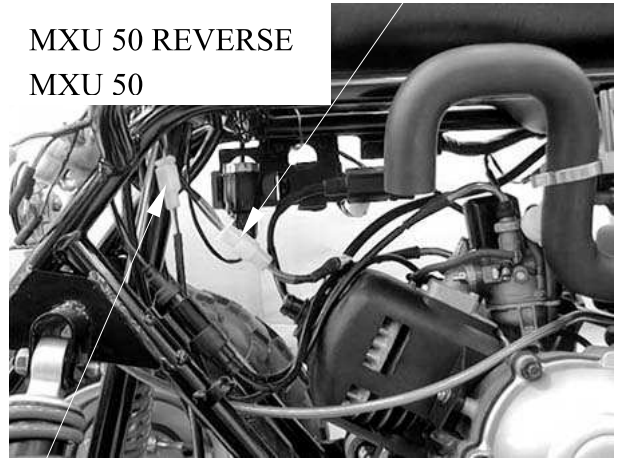

Auto Bystarter Wire Connector

Remove the spark plug cap.

Spark Plug Cap



Disconnect the oil pump control cable from the pump body.
Disconnect the oil inlet and outlet line from the oil pump.

After the oil inlet line is disconnected, plug the oil line opening to prevent oil from flowing out.

Remove the two carburetor lock nuts.
Remove the carburetor.

Oil Outlet Line Carburetor Lock Nuts

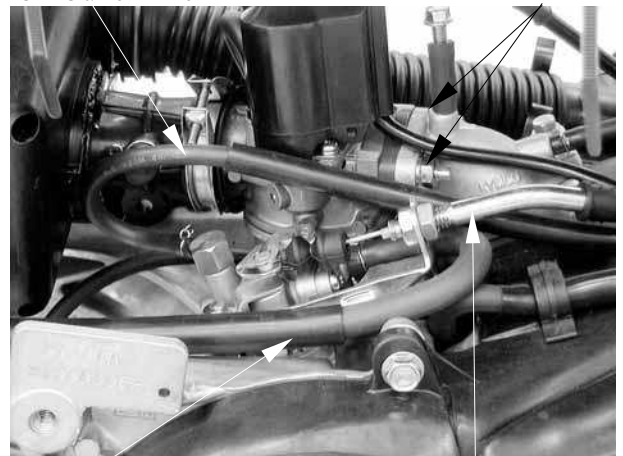

Oil Inlet Line

Control Cable

6. ENGINE REMOVAL/INSTALLATION

MXU 50 REVERSE:

Disconnect the neutral switch connectors.
Remove the bolt/nut at drive select rod, then remove the drive select rod from drive select arm.

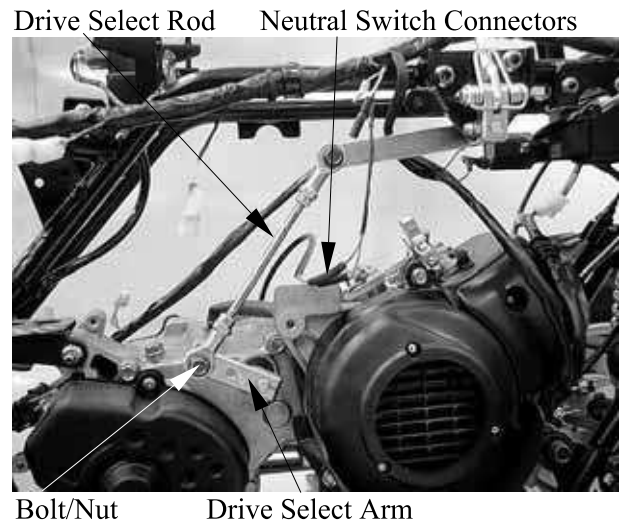

MXU 50 REVERSE:

Remove the three bolts at the drive sprocket cover, then remove the protector cover.

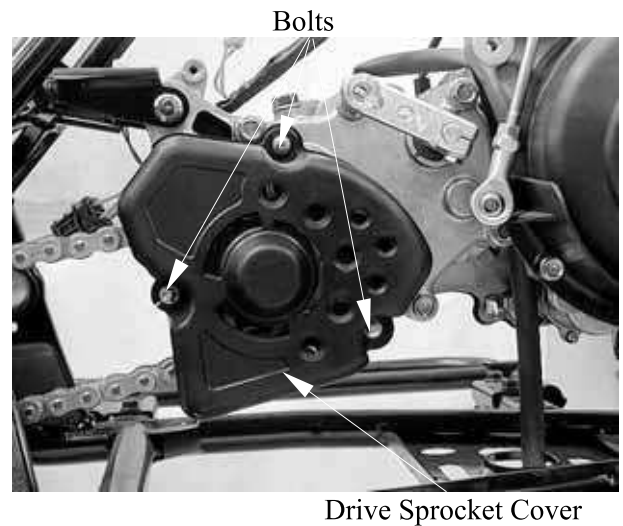

Remove the rear drive chain gear on the bolts.
Remove the drive chain gear.

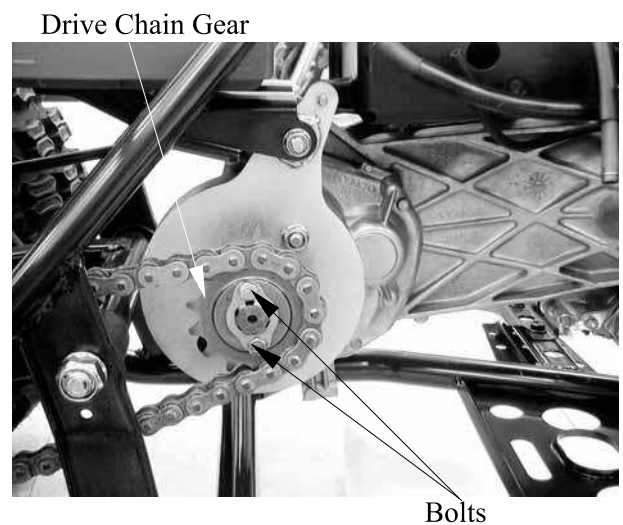

6. ENGINE REMOVAL/INSTALLATION

Remove the engine any connector thing.

Remove the rear right engine bracket bolt/nut (MXU 50/MX'ER 50).

Remove the front right engine bracket bolt/nut.

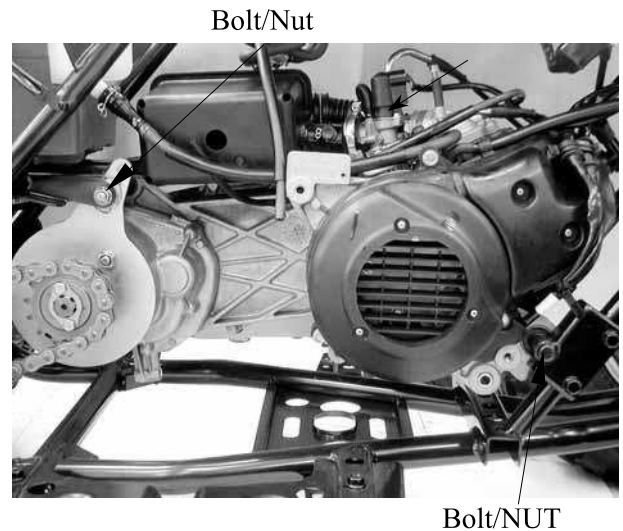

Remove the front left engine bracket bolt/nut.

Remove the rear left engine bracket bolt/nut.

Remove the engine to the right side of the frame.

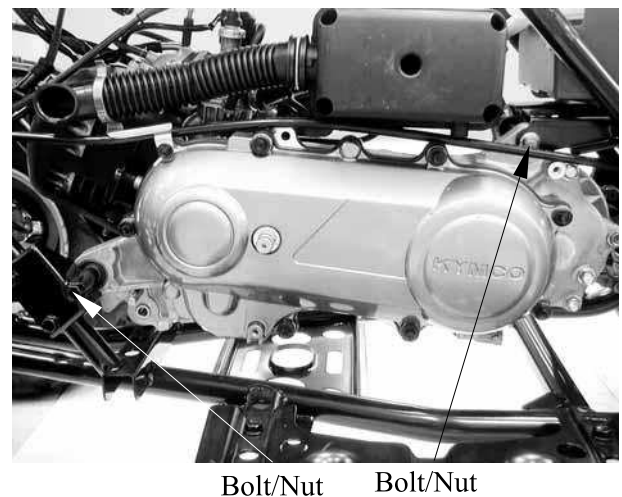

ENGINE INSTALLATION

Install the engine and tighten the engine mounting bolts/nuts.

Torque: 4 kgf-m (40 N-m, 29 lbf-ft)

Install the removed parts in the reverse order of removal.

Route the wires and cables properly.



7. CYLINDER HEAD/CYLINDER/PISTON

CYLINDER HEAD/CYLINDER/PISTON

SERVICE INFORMATION-----	7-2
TROUBLESHOOTING-----	7-2
CYLINDER HEAD-----	7-3
CYLINDER/PISTON -----	7-6

7. CYLINDER HEAD/CYLINDER/PISTON

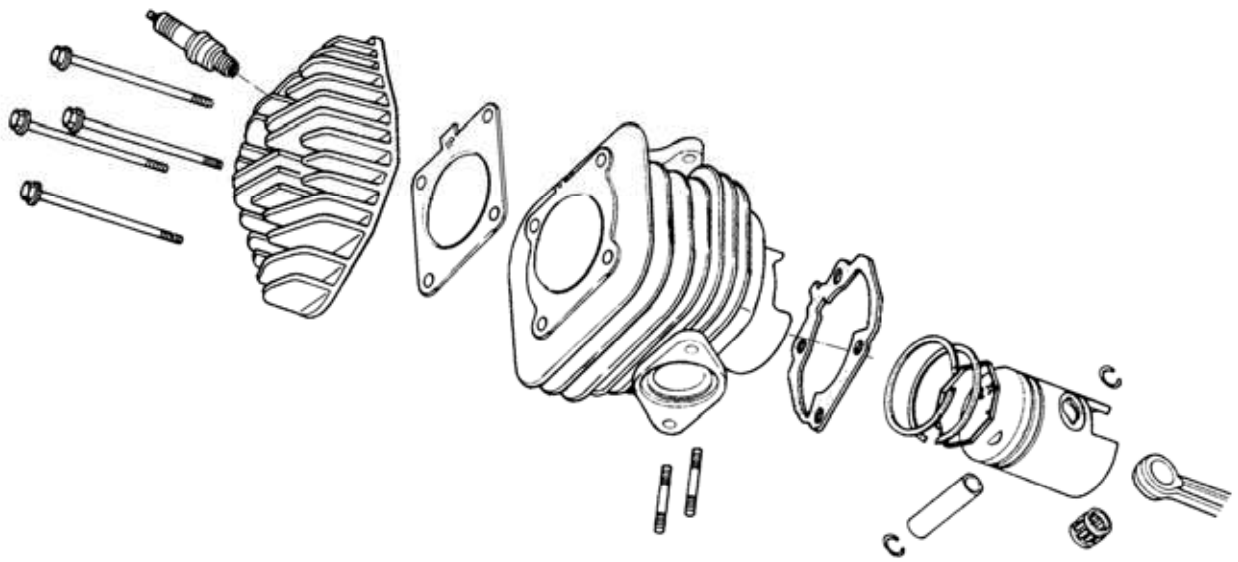

7. CYLINDER HEAD/CYLINDER/PISTON

SERVICE INFORMATION

GENERAL INSTRUCTIONS

- The cylinder head, cylinder and piston can be serviced with the engine installed in the frame.
- Before disassembly, clean the engine to prevent dust from entering the engine.
- Remove all gasket material from the mating surfaces.
- Do not use a driver to pry between the cylinder and cylinder head, cylinder and crankcase.
- Do not damage the cylinder inside and the piston surface.
- After disassembly, clean the removed parts before inspection. When assembling, apply the specified engine oil to movable parts.

SPECIFICATIONS

Unit: mm (in)

Item	Standard	Service Limit
Cylinder head warpage	—	0.1 (0.004)
Piston O.D.(5mm from bottom of piston skirt)	38.97 (1.5588)~38.955 (1.5582)	38.9 (1.556)
Cylinder-to- piston clearance	0.03 (0.0012)~0.07 (0.0028)	0.1 (0.004)
Piston pin hole I.D.	12.002 (0.48008)~12.008 (0.48032)	12.03 (0.4812)
Piston pin O.D.	11.994 (0.47976)~12 (0.48)	11.98 (0.4792)
Piston-to-piston pin clearance	0.002 (0.00008)~0.014 (0.00056)	0.03 (0.0012)
Piston ring end gap (top/second)	0.1 (0.004)~0.25 (0.01)	0.4 (0.016)
Connecting rod small end I.D.	17.005 (0.6802)~17.017 (0.68068)	17.03 (0.6812)
Cylinder bore	39 (1.56)~39.025 (1.561)	39.05 (1.562)

TORQUE VALUES

Cylinder head bolt	1.6 kgf-m (16 N-m, 11.5 lbf-ft)
Exhaust muffler joint lock nut	1.2 kgf-m (12 N-m, 8.6 lbf-ft)
Exhaust muffler lock bolt	3.3 kgf-m (33 N-m, 23.8 lbf-ft)
Spark plug	1.4 kgf-m (14 N-m, 10.1 lbf-ft)

TROUBLESHOOTING

Compression too low, hard starting or poor performance at low speed

- Leaking cylinder head gasket
- Loose spark plug
- Worn, stuck or broken piston and piston rings
- Worn or damaged cylinder and piston

Compression too high, overheating or knocking

- Excessive carbon build-up in cylinder head or on piston head

Abnormal noisy piston

- Worn cylinder and piston
- Worn piston pin or piston pin hole
- Worn connecting rod small end bearing

Abnormal noisy piston rings

- Worn, stuck or broken piston rings
- Worn or damaged cylinder

7. CYLINDER HEAD/CYLINDER/PISTON

CYLINDER HEAD

REMOVAL

Remove the spark plug cap.
 Remove the exhaust muffler. (⇒2-15 or 2-16)

Spark Plug Cap



Remove the three bolts attaching the fan cover to remove the fan cover.
 Remove the bolt attaching the engine hood to remove the engine hood.
 The installation sequence is the reverse of removal.

Bolts

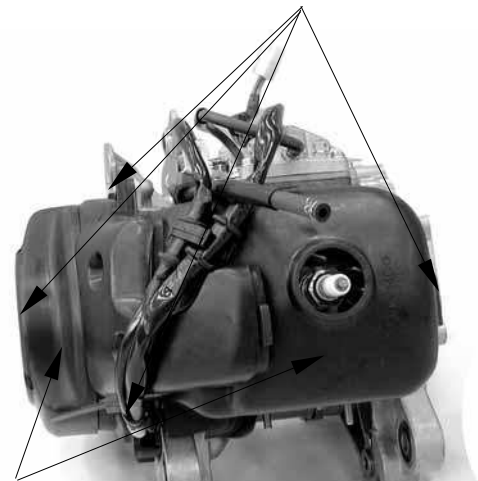

Fan Cover/Engine Hood

Remove the spark plug.
 Remove the cylinder head bolts and the cylinder head.

* Loosen the bolts diagonally in 2 or 3 times.

Remove the cylinder head gasket.

Cylinder Head Cylinder head Bolts

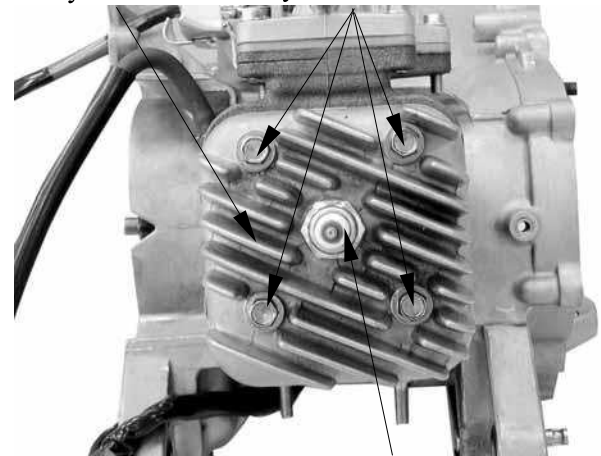

Spark Plug

7. CYLINDER HEAD/CYLINDER/PISTON

COMBUSTION CHAMBER DECARBONIZING

Remove the carbon deposits from the combustion chamber

- * Avoid damaging the combustion chamber wall and cylinder mating surface.

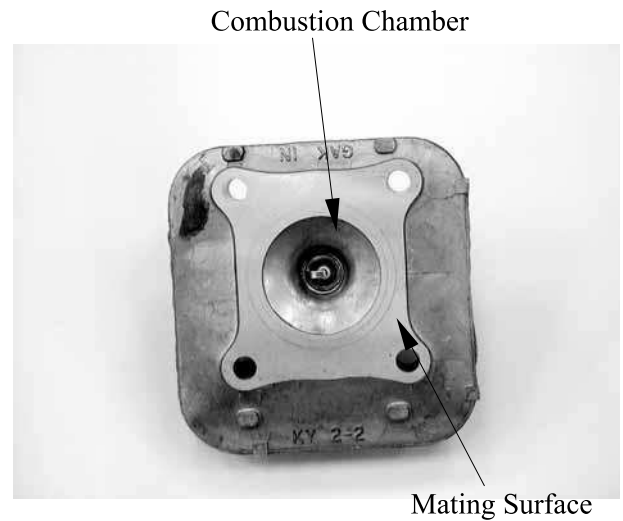

CYLINDER HEAD INSPECTION

Check the cylinder head for warpage with a straight edge and feeler gauge.

Service Limit:

0.1 mm (0.004 in) replace if over

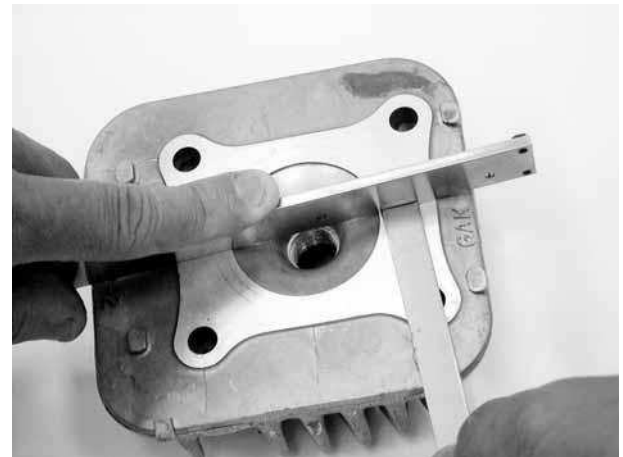

CYLINDER HEAD INSTALLATION

Install the cylinder head on the cylinder properly.

- * Be careful not to damage the mating surfaces.

Install a new cylinder head gasket onto the cylinder.



7. CYLINDER HEAD/CYLINDER/PISTON

Cylinder Head Bolts Installation

Install and tighten the cylinder head bolts diagonally in 2 or 3 times.

Torque: 1.6 kgf-m (16 N-m, 11.5 lbf-ft)

Install the spark plug.

Torque: 1.4 kgf-m (14 N-m, 10.1 lbf-ft)

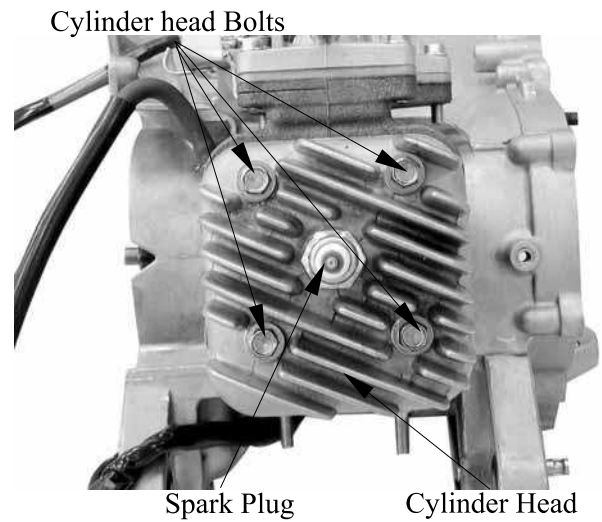

Engine Hood Installation

Install the engine hood. (⇒7-3)

Install the spark plug cap. (⇒7-3)

Install the exhaust muffler. (⇒12-15 or 12-16)

Perform the following inspections after installation:

- Compression test
- Abnormal engine noise
- Cylinder air leaks

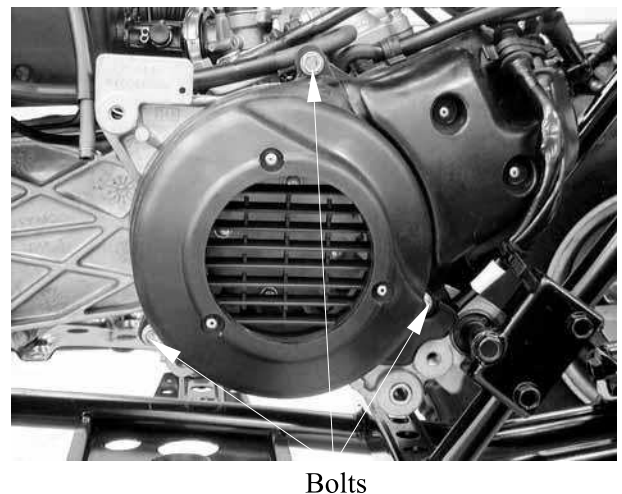
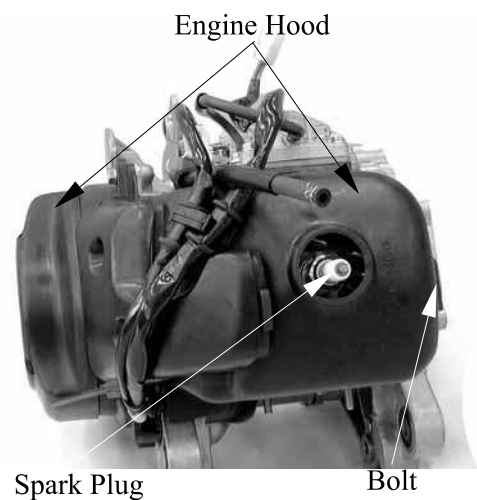

7. CYLINDER HEAD/CYLINDER/PISTON

CYLINDER/PISTON

CYLINDER REMOVAL

Remove the reed valve (see page 5-13).

Remove the cylinder head.

Remove the cylinder.

Remove the cylinder gasket.

*

Do not pry between the cylinder and crankcase or strike the fins.

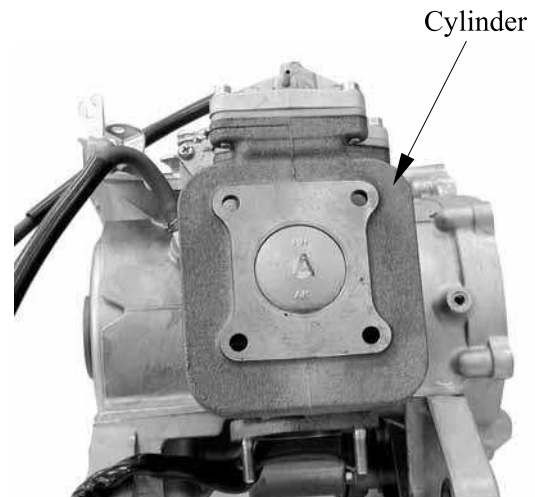

PISTON REMOVAL

Remove the piston pin clip to remove the piston pin and piston.

*

- Do not damage or scratch the piston.
- Do not apply side force to the connecting rod when removing the piston pin.
- Place clean shop towels in the crankcase to keep the piston pin clip from falling into the crankcase.

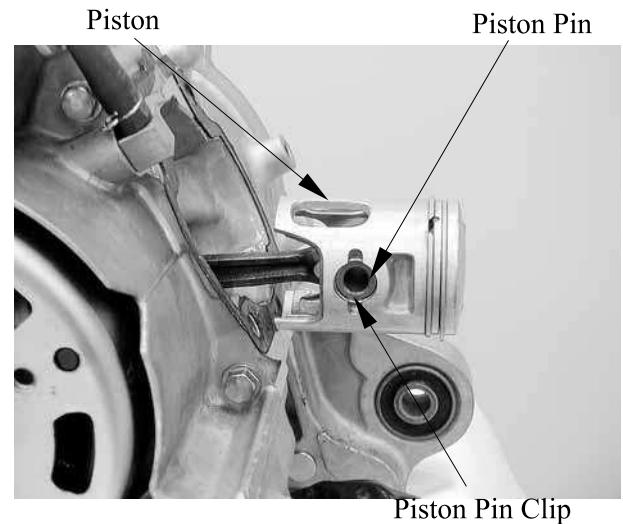

Spread each piston ring and remove by lifting it up at a point just opposite the gap.
Remove the expander.



7. CYLINDER HEAD/CYLINDER/PISTON

CYLINDER/PISTON INSPECTION

Check the cylinder and piston for wear or damage.

Clean carbon deposits from the exhaust port area.

* Be careful not to damage the cylinder inside wall.



Measure the cylinder bore at three levels of A, B and C in both X and Y directions. Avoid the port area. Take the maximum figure measured to determine the cylinder bore.

Service Limit:

39.05 mm (1.56 in) replace if over

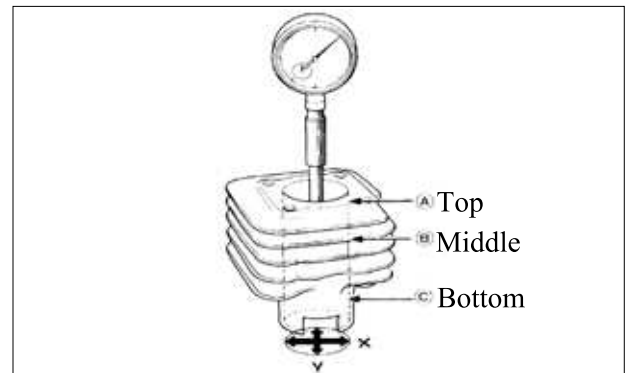

Inspect the top of the cylinder for warpage.

Service Limit:

0.1 mm (0.004 in) replace if over



7. CYLINDER HEAD/CYLINDER/PISTON

*

The cylinder has an “A” mark or no mark on it. When replacing the cylinder with a new one, use a cylinder having the same mark as the old one.

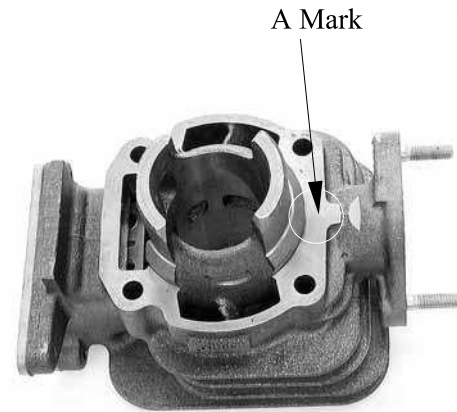

Measure the piston O.D. at a point 5 mm (0.2 in) from the bottom of the piston skirt.

Service Limit:

38.9 mm (1.56 in) replace if below



Measure the piston-to-cylinder clearance.

Service Limit:

0.1 mm (0.004 in) replace if over

Measure the piston pin hole I.D.

Service Limit:

12.03 mm (0.481 in) replace if over

Measure the piston pin O.D.

Service Limit:

11.98 mm (0.479 in) replace if below

Measure the piston-to-piston pin clearance.

Service Limit:

0.03 mm (0.0012 in) replace if over



7. CYLINDER HEAD/CYLINDER/PISTON

PISTON RING INSPECTION

Measure each piston ring end gap.

Service Limits: Top/Second:

0.4 mm (0.016 in) replace if over

* Set each piston ring squarely into the cylinder using the piston and measure the end gap.



CONNECTING ROD SMALL END INSPECTION

Install the piston pin and bearing in the connecting rod small end and check for excessive play.

Measure the connecting rod small end I.D.

Service Limit:

17.03 mm (0.6812 in) replace if over

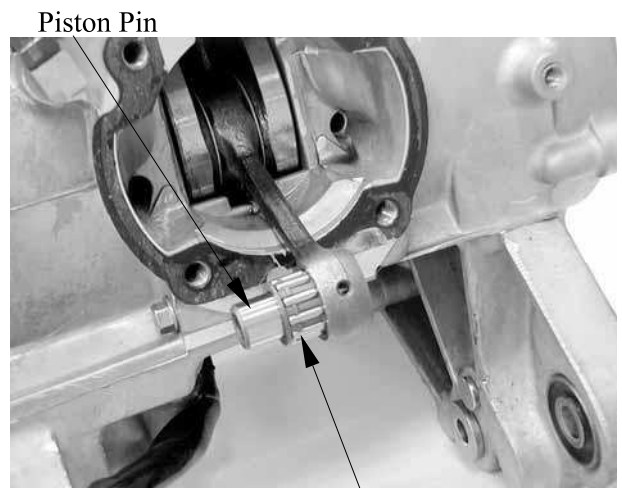

PISTON/CYLINDER INSTALLATION

First install the expander in the second ring groove.

Then install the top and second rings in their respective ring grooves.

The piston rings should be pressed into the grooves with even force.

After installation, check and make sure that each ring is flush with the piston at several points around the ring.

A ring that will not compress means that the ring groove has carbon deposits in it and should be cleaned.

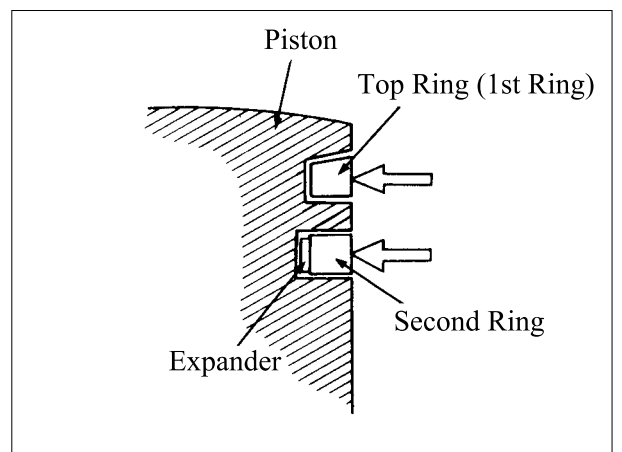

7. CYLINDER HEAD/CYLINDER/PISTON

Install a new cylinder gasket on the mating surface between the cylinder and crankcase. Position the piston "IN" mark on the intake valve side.

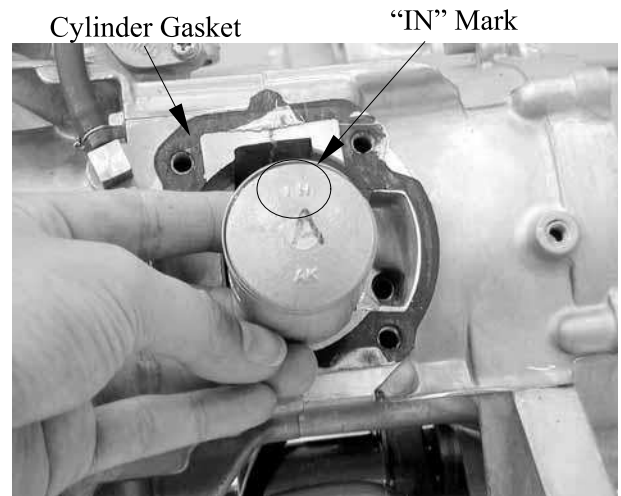

Make sure that the ring end gaps are aligned with the piston ring pins in the ring grooves. Lubricate the cylinder inside and piston rings with engine oil and install the piston into the cylinder while compressing the piston rings.

*

Be careful not to damage the piston.



Install the cylinder head.

Torque: 1.6 kgf-m (16 N-m, 11.5 lbf-ft)

The installation sequence is the reverse of removal.



8. A.C. GENERATOR



A.C. GENERATOR

SERVICE INFORMATION 8-2
A.C. GENERATOR REMOVAL..... 8-3
A.C. GENERATOR INSTALLATION 8-4



8. A.C. GENERATOR

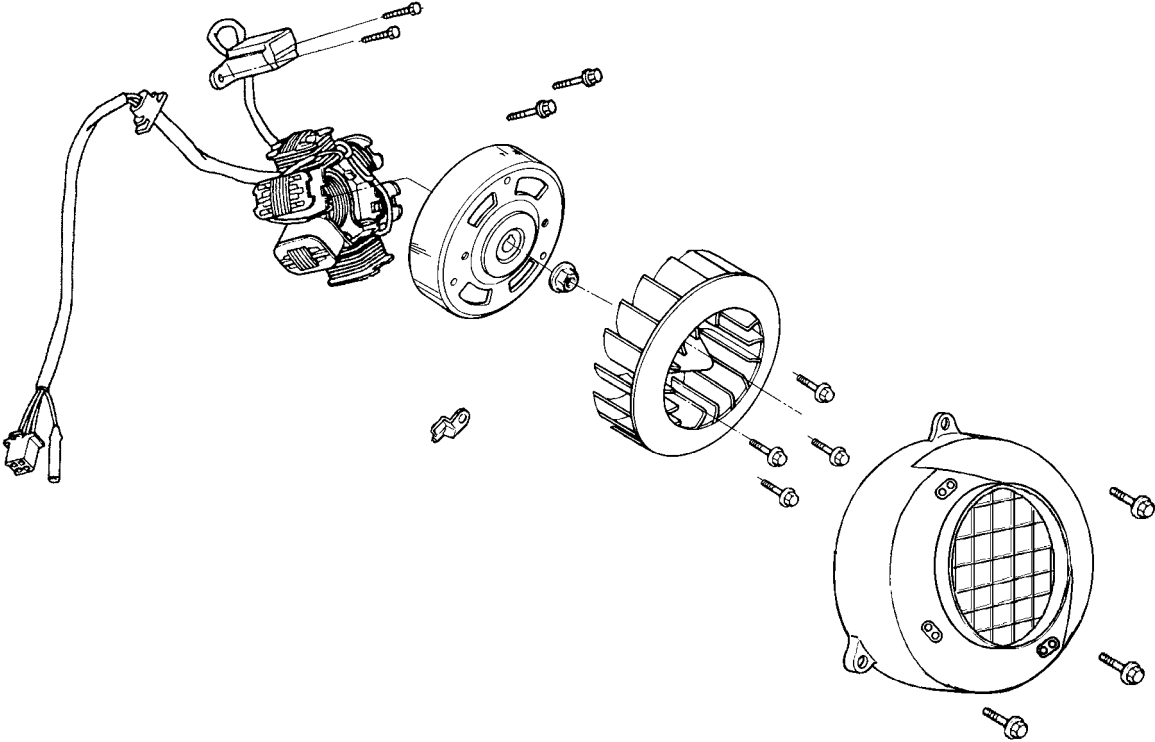

8. A.C. GENERATOR

SERVICE INFORMATION

GENERAL INSTRUCTIONS

- All A.C. generator maintenance and inspection can be made with the engine installed.
- Refer to Section 15, 16 for A.C. generator inspection.

TORQUE VALUE

Flywheel nut : 3.8 kgf-m (38 N-m, 27.4 lbf-ft)

SPECIAL TOOLS

Flywheel puller	A120E00001
Universal holder	A120E00017

8. A.C. GENERATOR

A.C. GENERATOR REMOVAL

Remove the three bolts attaching the fan cover to remove the fan cover.

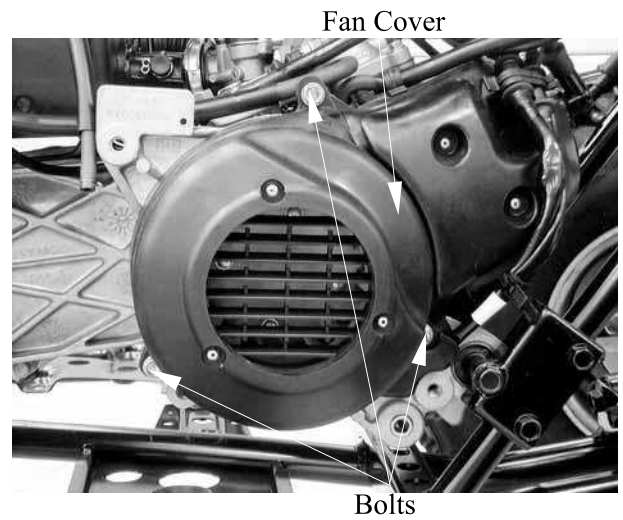

Remove the cooling fan by removing the four bolts.

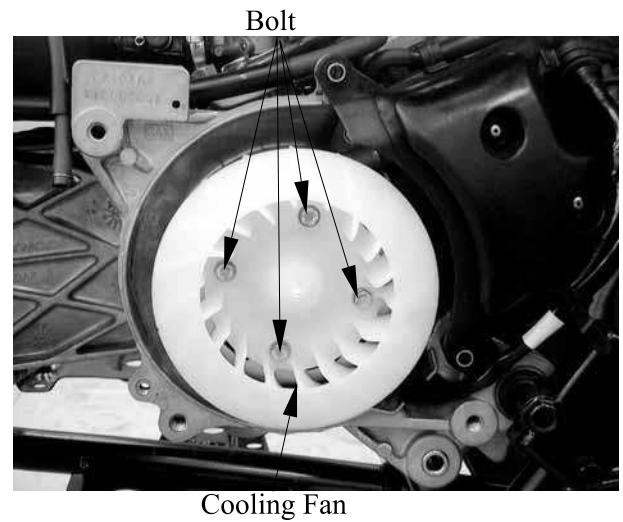

Hold the flywheel with an universal holder and then remove the flywheel nut.

Special tool:
Universal holder **A120E00017**

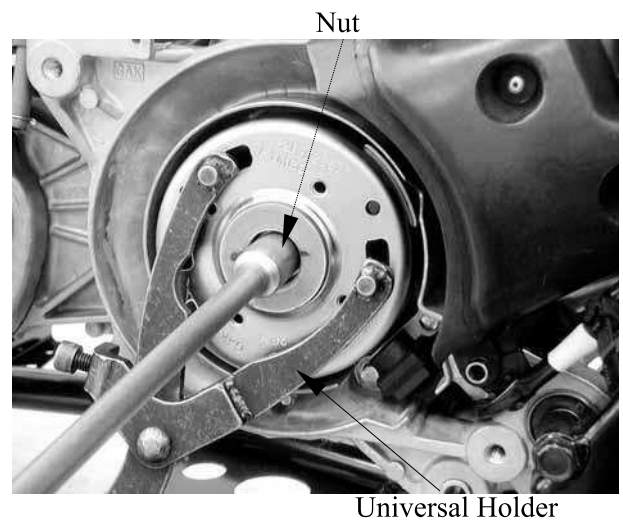

8. A.C. GENERATOR

Remove the A.C. generator flywheel using the flywheel puller.

Special tool:

Flywheel puller A120E00001



Flywheel Puller

Lock Nut Wrench

Remove the A.C. generator wire connector.

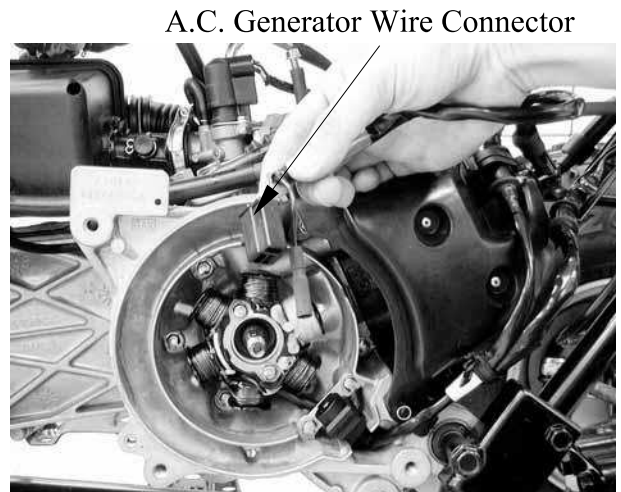

A.C. Generator Wire Connector

Remove the two pulser coil bolts and pulser coil from the right crankcase.
Remove the two bolts attaching the A.C. generator stator.

Be careful not to damage the disconnected wire.

A.C. GENERATOR INSTALLATION

Install the A.C. generator stator and pulser coil wire clamp onto the right crankcase, and then install the pulser coil.

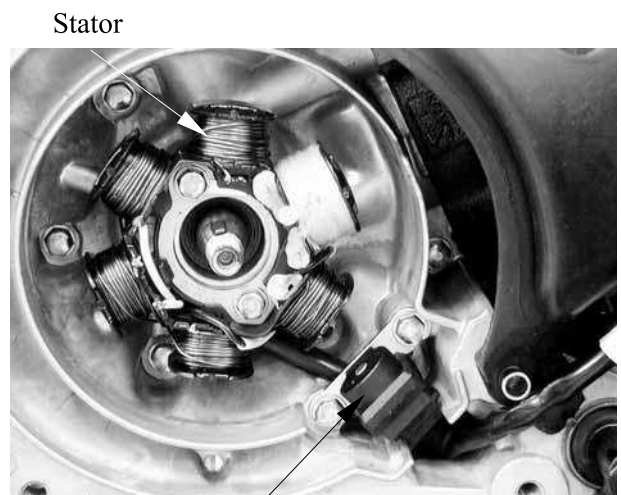

Stator

Pulser Coil

8. A.C. GENERATOR

Connect the A.C. generator wire connector.

A.C. Generator Wire Connector

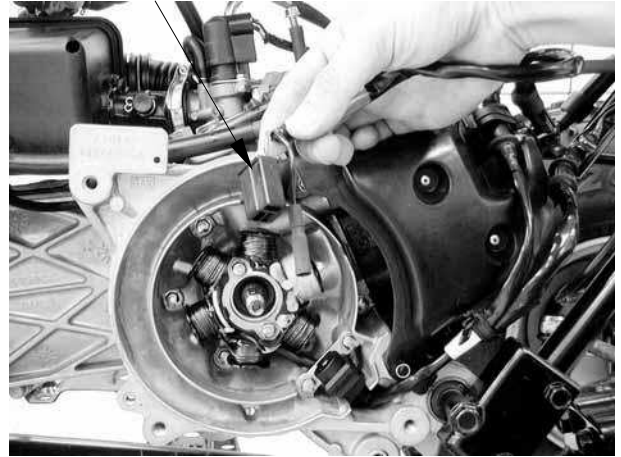

Clean the taper hole in the flywheel off any burrs and dirt.
Install the woodruff key in the crankshaft key way.

Woodruff Key



Install the flywheel onto the crankshaft with the flywheel groove aligned with the crankshaft woodruff key.
Hold the flywheel with the universal holder and install the 10 mm (0.4 in) flywheel flange nut.

Torque: 3.8 kgf-m (38 N-m, 27.4 lbf-ft)

Start the engine and check the ignition timing. (⇒3-7)

Install other removed parts in the reserve order of removal.

Universal Holder

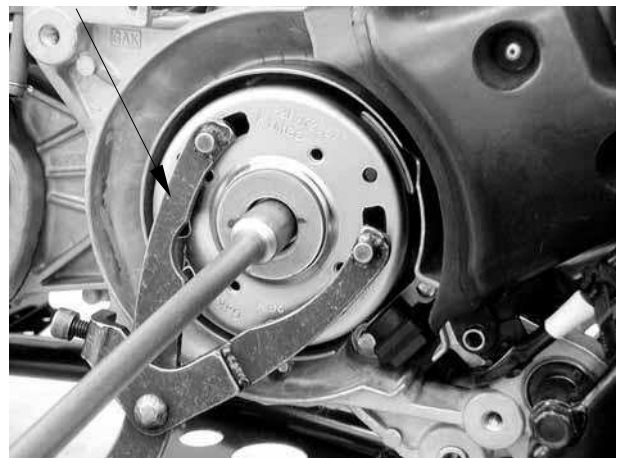

9. KICK STARTER/DRIVE PULLEY/ CLUTCH/DRIVEN PULLEY



ATV 50

KICK STARTER/DRIVE PULLEY/ CLUTCH/DRIVEN PULLEY

SERVICE INFORMATION.....	9 - 2
TROUBLESHOOTING.....	9 - 2
KICK STARTER.....	9 - 3
DRIVE BELT	9 - 7
DRIVE PULLEY	9 - 9
STARTER PINION	9-11
CLUTCH/DRIVEN PULLEY	9-12



9. KICK STARTER/DRIVE PULLEY/ CLUTCH/DRIVEN PULLEY

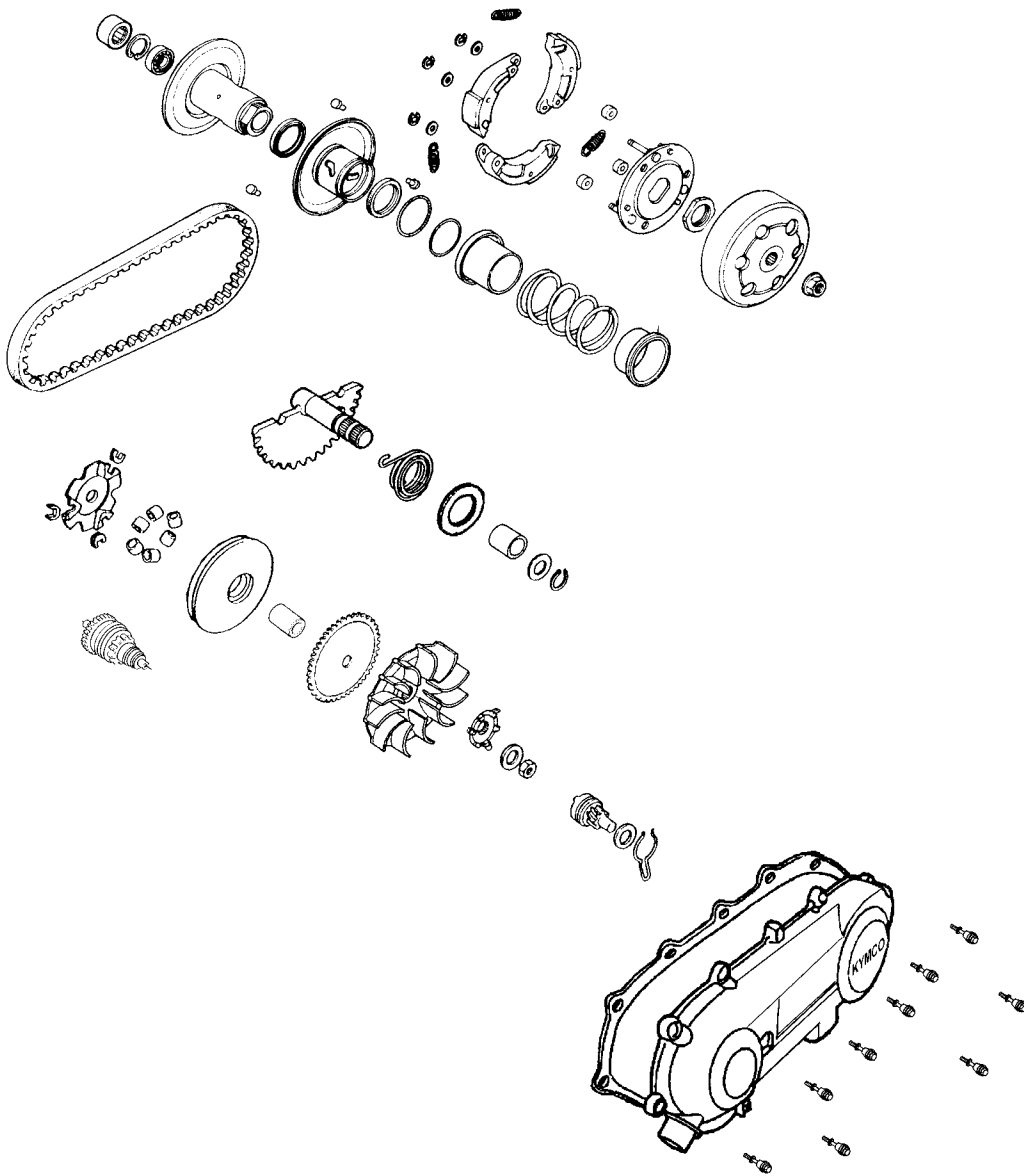

9. KICK STARTER/DRIVE PULLEY/ CLUTCH/DRIVEN PULLEY



ATV 50

SERVICE INFORMATION

GENERAL INSTRUCTIONS

- Avoid getting grease and oil on the drive belt and pulley faces.

SPECIFICATIONS

Unit: mm (in)

Item	Standard	Service Limit
Drive pulley collar O.D.	20.01 (0.8004)~20.025 (0.801)	19.97 (0.7988)
Movable drive face I.D.	20.035 (0.8014)~20.085 (0.8034)	20.24 (0.8096)
Weight roller O.D.	13 (0.52)	12.4 (0.496)
Clutch outer I.D.	107 (4.28)~107.2 (4.288)	107.5 (4.3)
Driven face spring free length	98.1 (3.924)	92.8 (3.712)
Driven face O.D.	33.965 (1.3586)~33.985 (1.3594)	33.94 (1.3576)
Movable driven face I.D.	34 (1.36)~34.25 (1.37)	34.4 (1.376)
Drive belt width	17.5 (0.7)	16.5 (0.66)

TORQUE VALUES

Drive face nut	3.8 kgf-m (38 N-m, 27.4 lbf-ft)
Clutch outer nut	3.8 kgf-m (38 N-m, 27.4 lbf-ft)
Clutch drive plate nut	5.5 kgf-m (55 N-m, 39.6 lbf-ft)

SPECIAL TOOLS

Universal holder	A120E00017
Clutch spring compressor	A120E00034
Bearing outer driver	A120E00037
Bearing driver pilot	A120E00014

TROUBLESHOOTING

Engine starts but motorcycle won't move

- Worn drive belt
- Broken ramp plate
- Worn or damaged clutch lining

Engine stalls or motorcycle creeps

- Broken clutch weight spring

Poor performance at high speed or lack of power

- Worn drive belt
- Weak driven face spring
- Worn weight roller
- Faulty driven face

9. KICK STARTER/DRIVE PULLEY/ CLUTCH/DRIVEN PULLEY

KICK STARTER

LEFT CRANKCASE COVER REMOVAL

Remove the left crankcase cover bolts, left crankcase cover and dowel pins.

Inspect the left crankcase cover seal rubber for damage or deterioration.

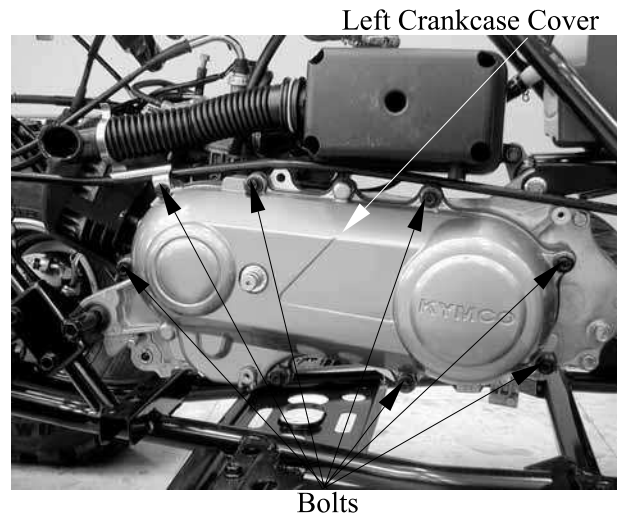

KICK STARTER SPINDLE REMOVAL

Remove the kick lever from the kick starter spindle.

Remove the snap ring and washer from the kick starter spindle.



Slightly rotate the kick starter spindle to remove the kick starter driven gear together with the friction spring.

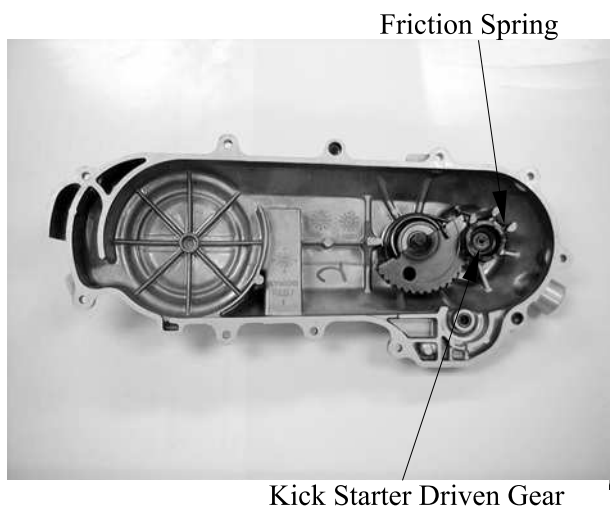

9. KICK STARTER/DRIVE PULLEY/ CLUTCH/DRIVEN PULLEY

Remove the kick starter spindle and return spring from the left crankcase cover.
Remove the kick starter spindle bushing.

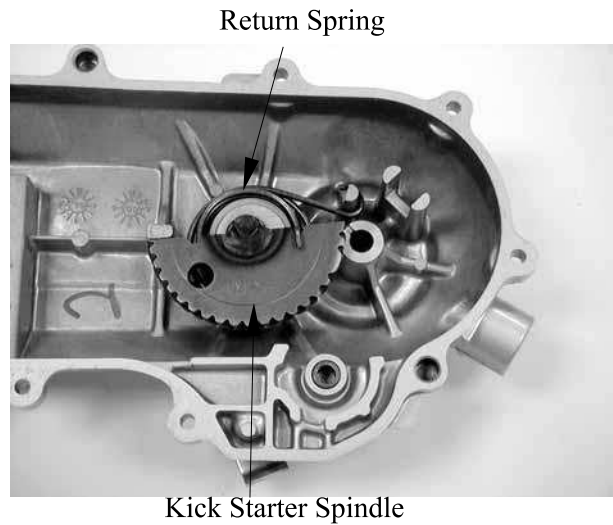

KICK STARTER SPINDLE INSPECTION

Inspect the kick starter spindle and gear for wear or damage.
Inspect the return spring for weakness or damage.
Inspect the kick starter spindle bushing for wear or damage.

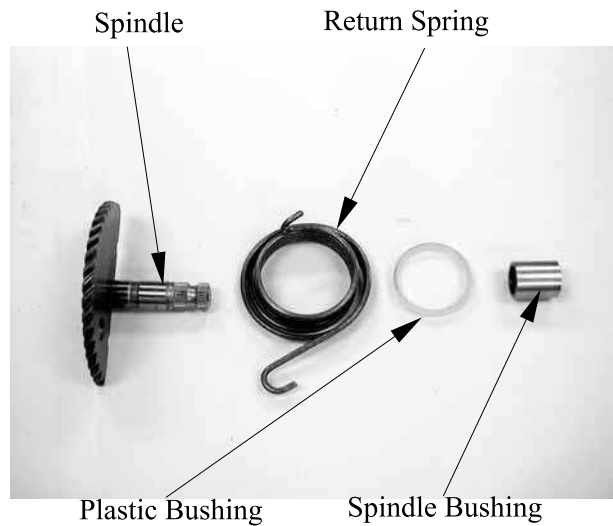

Check the kick starter driven gear for wear or damage.
Check the friction spring for wear or damage.



9. KICK STARTER/DRIVE PULLEY/ CLUTCH/DRIVEN PULLEY

Inspect the kick starter spindle and driven gear forcing parts for wear or damage.

Kick Starter Spindle Forcing Part

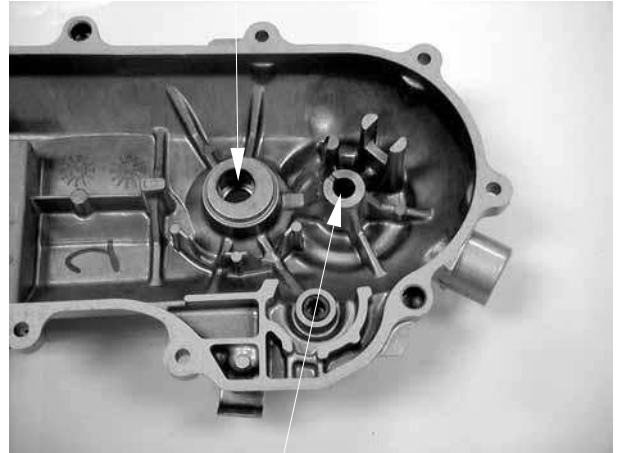

Kick Starter Driven Gear Forcing Part

KICK STARTER INSTALLATION

Install the kick starter spindle bushing and return spring onto the left crankcase cover.

* If the hooks of the return spring can not be installed properly, use a screw driver to press them into their locations respectively.

Friction Spring

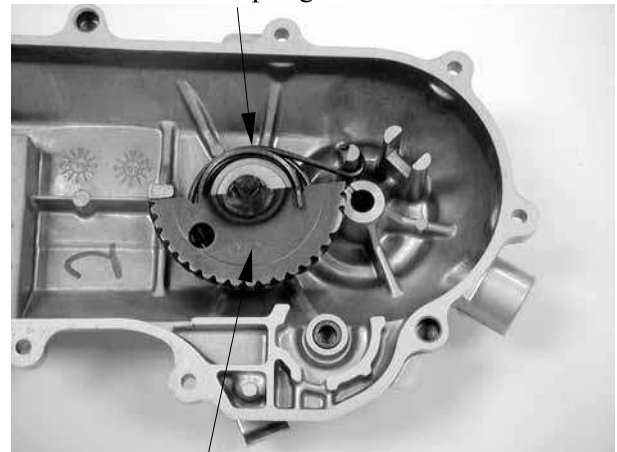

Kick Starter Spindle

Properly install the kick starter driven gear and friction spring as the figure shown.

Friction Spring

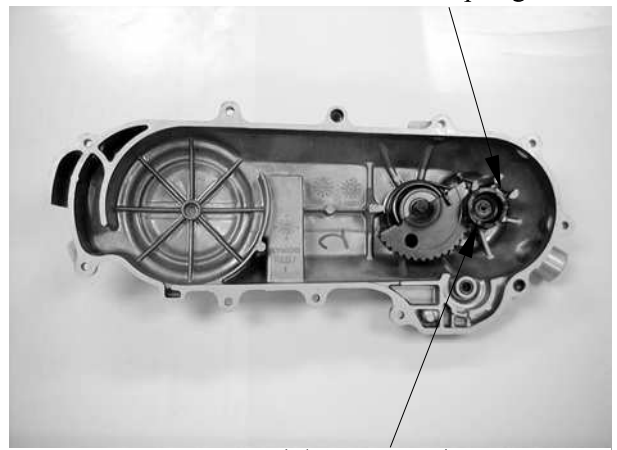

Kick Starter Driven Gear

9. KICK STARTER/DRIVE PULLEY/ CLUTCH/DRIVEN PULLEY

First install the washer and then the snap ring onto the kick starter spindle.
Install the kick lever.

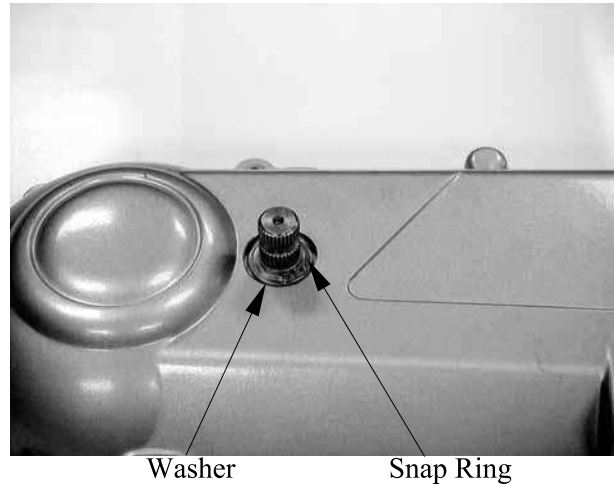

LEFT CRANKCASE COVER INSTALLATION

First install the dowel pins and then the seal gasket.

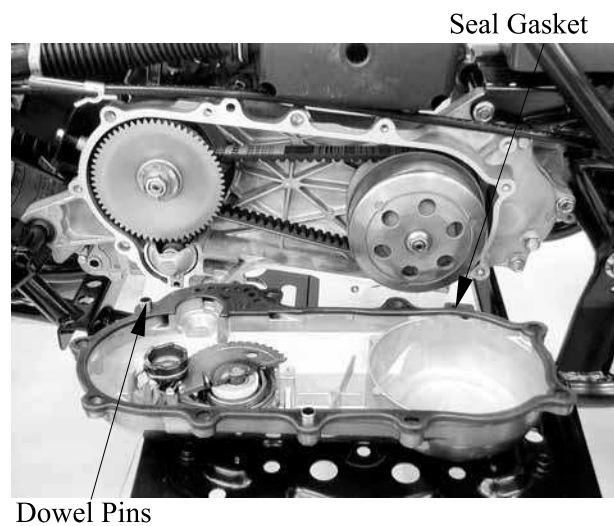

Install the left crankcase cover and tighten the ten bolts diagonally.

* For drum brake, note the location of the brake cable clamp and install the rear brake cable in place with the clamp.



9. KICK STARTER/DRIVE PULLEY/ CLUTCH/DRIVEN PULLEY

* Use specified genuine parts for replacement.

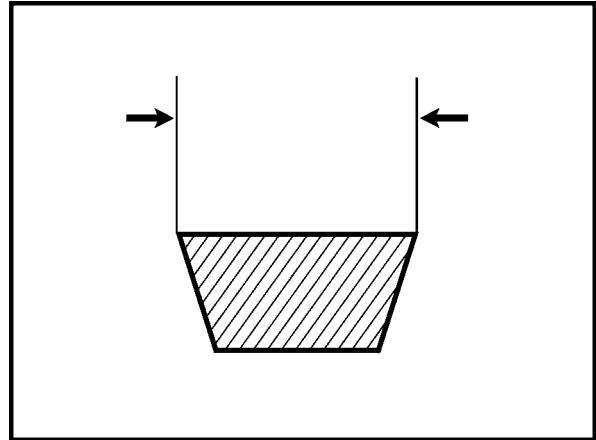

(⇒9-3)

Hold the clutch outer with the universal holder and remove the clutch outer nut and clutch outer.

Special tool:

Universal holder A120E00017

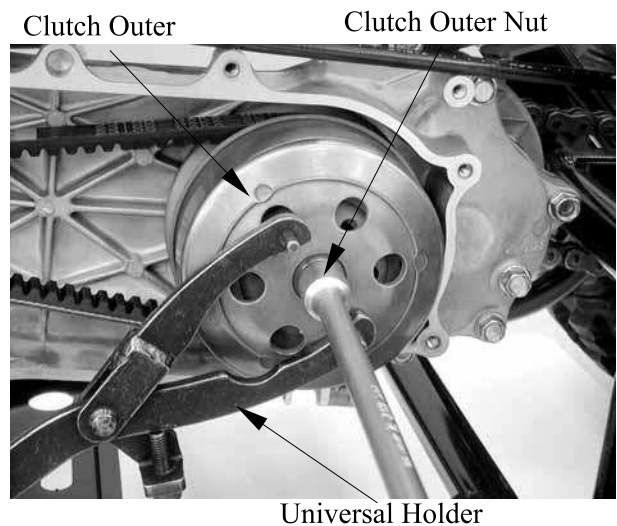

Hold the flywheel with the universal holder (see page 8-3) and remove the drive face nut and washer. Remove the drive pulley face.

Special tool:

Universal holder A120E00017

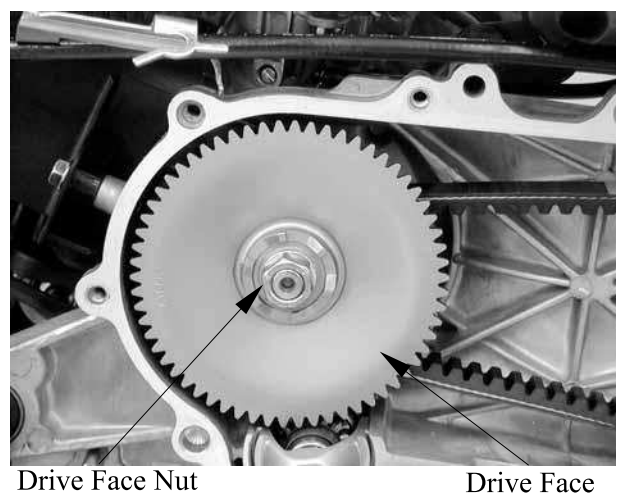

9. KICK STARTER/DRIVE PULLEY/ CLUTCH/DRIVEN PULLEY

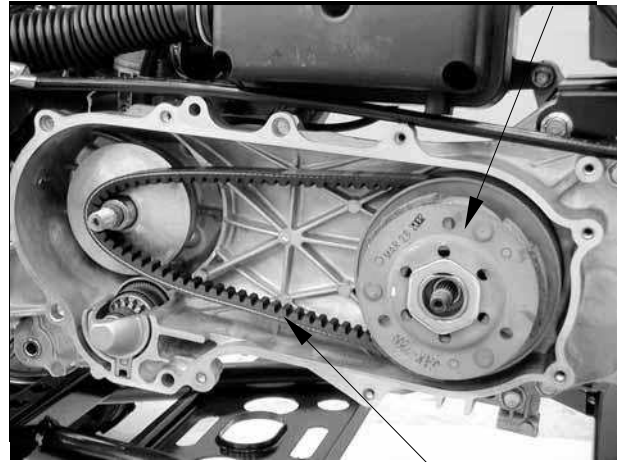

t

Drive Belt

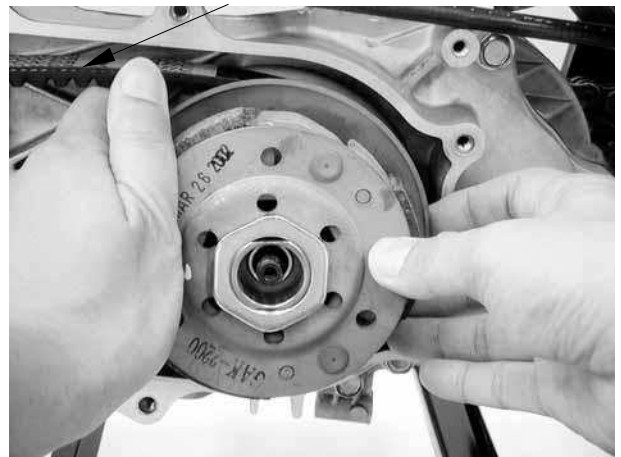

Drive Pulley Face



Drive Face Nut

Drive Belt

9. KICK STARTER/DRIVE PULLEY/ CLUTCH/DRIVEN PULLEY

DRIVE PULLEY

REMOVAL

Hold the flywheel with the universal holder (see page 8-3) and remove the drive face nut and washer.

Remove the drive pulley face.

Special tool:

Universal holder A120E00017



Drive Face Nut

Drive Pulley Face

MOVABLE DRIVE FACE DISASSEMBLY

Remove the movable drive face and drive pulley collar from the crankshaft.

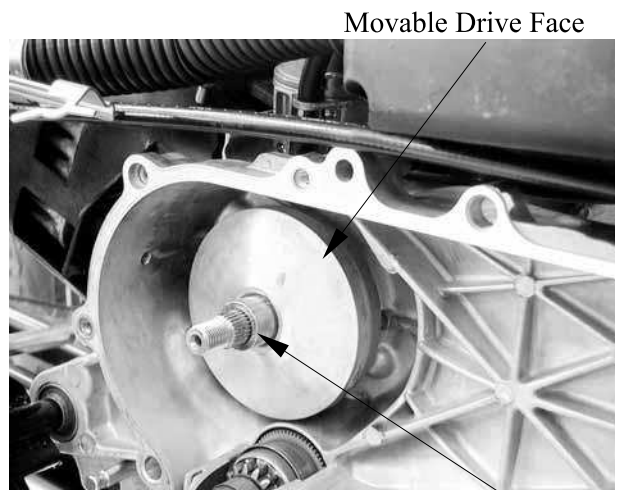

Movable Drive Face

Drive Pulley Collar

Remove the ramp plate.

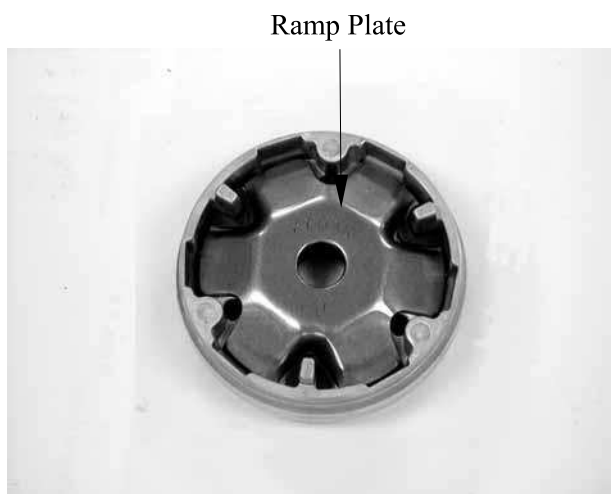

Ramp Plate

9. KICK STARTER/DRIVE PULLEY/ CLUTCH/DRIVEN PULLEY

Remove the weight rollers.

Weight Roller

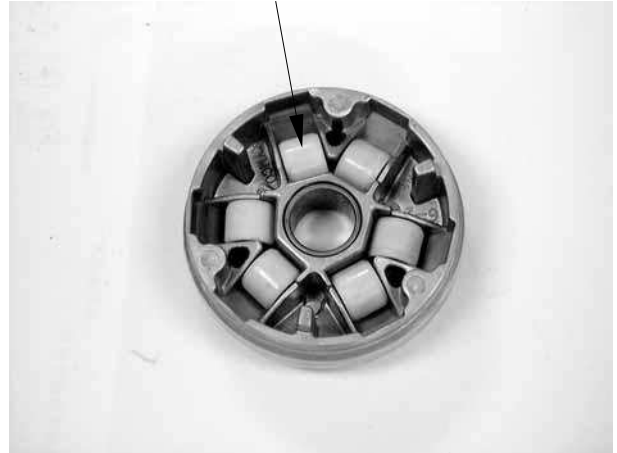

Remove the weight rollers.
Check each weight roller for wear or damage.
Measure each roller O.D.

Service Limit:

12.4 mm (0.496 in) replace if below

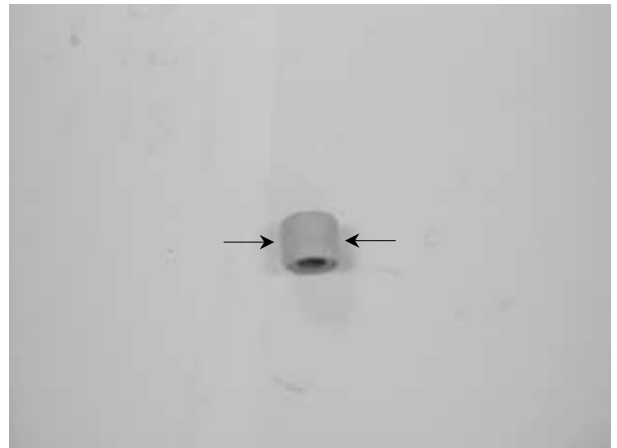

DRIVE PULLEY INSTALLATION

Install the drive pulley collar and movable
drive face onto the crankshaft.

Movable Drive Face

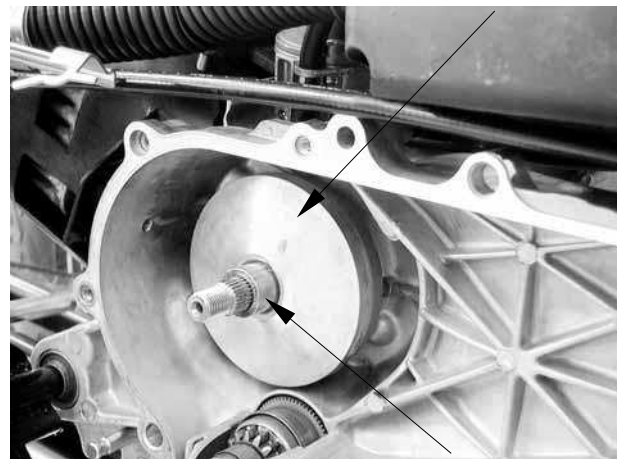

Drive Pulley Collar

9. KICK STARTER/DRIVE PULLEY/ CLUTCH/DRIVEN PULLEY

Install the drive belt on the crankshaft.
Install the drive pulley face and washer, then hold the flywheel with the universal holder (see page 8-3) and tighten the drive face nut to the specified torque.

Torque: 3.8 kgf-m (38 N-m, 27.4 lbf-ft)

Special tool:

Universal holder E017

* Keep grease or oil off the drive belt and drive pulley faces.

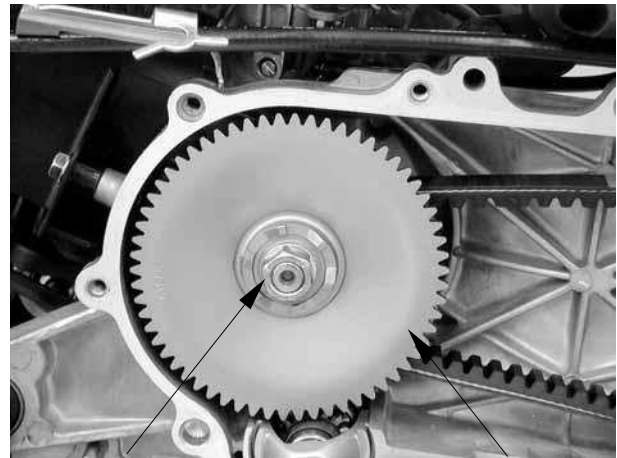

Drive Face Nut

Drive Pulley Face

STARTER PINION

REMOVAL

Remove the left crankcase cover. (⇒9-3)

Remove the drive pulley. (⇒9-9)

Remove the starter pinion cover.

Remove the starter pinion.



Starter Pinion Cover

INSPECTION

Inspect the starter pinion seat for wear.

Inspect the starter pinion for smooth operation.

Inspect the starter pinion shaft forcing parts for wear and damage.

INSTALLATION

Apply a small amount of grease to the starter pinion teeth.

Install the starter pinion in the reverse order of removal.



Starter Pinion

9. KICK STARTER/DRIVE PULLEY/ CLUTCH/DRIVEN PULLEY

CLUTCH/DRIVEN PULLEY CLUTCH/DRIVEN PULLEY REMOVAL

Remove the drive pulley. (⇒9-9)

Hold the clutch outer with the universal holder and remove the clutch outer nut

Remove the clutch outer.

Special tool:

Universal holder A120E00017

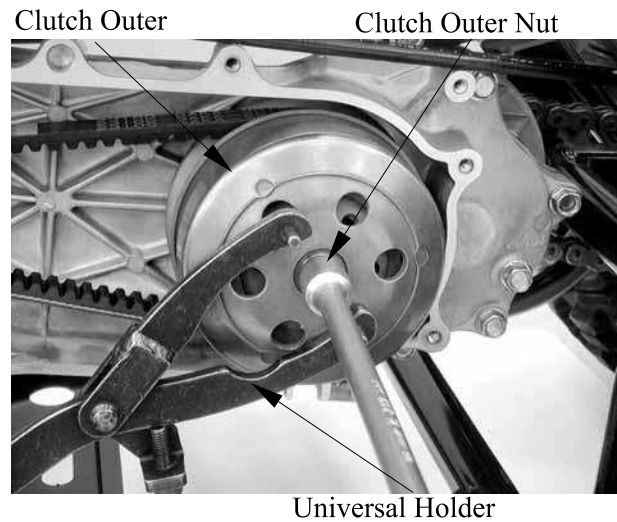

Remove the clutch/driven pulley.
Remove the drive belt from the clutch/driven pulley.

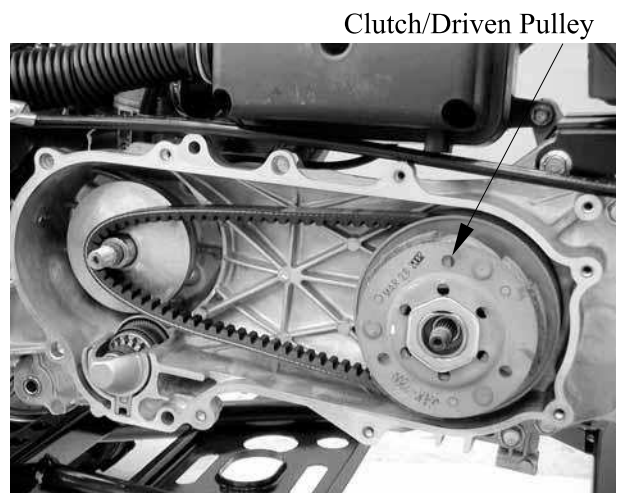

CLUTCH/DRIVEN PULLEY DIS- ASSEMBLY

Compress the clutch/driven pulley spring with the clutch spring compressor and remove the 39 mm (1.56 in) drive plate nut.

Remove the driven face spring.

Special tool:

Clutch spring compressor A120E00034

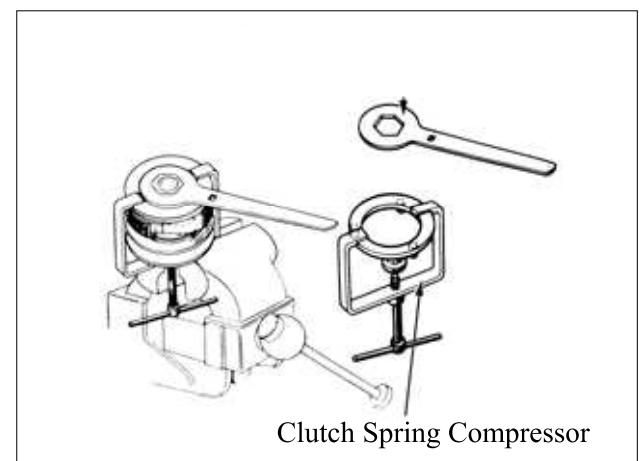

9. KICK STARTER/DRIVE PULLEY/ CLUTCH/DRIVEN PULLEY

Remove the seal collar.



Seal Collar

Pull out the guide roller pins from the driven pulley and then remove the O-rings and oil seal from the driven pulley.

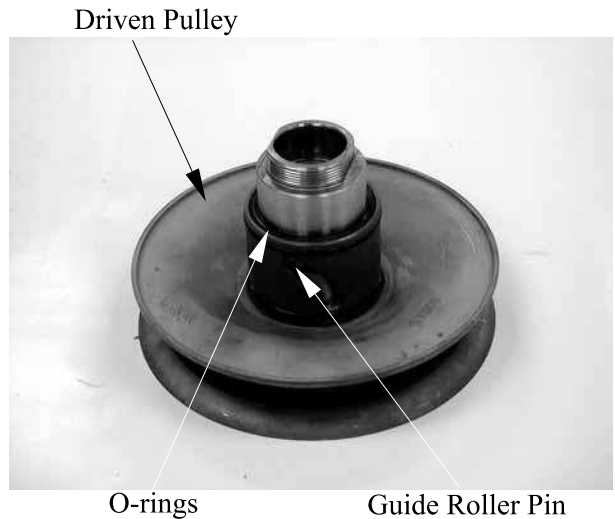

Driven Pulley

O-rings

Guide Roller Pin

CLUTCH/DRIVEN PULLEY INSPECTION

Inspect the clutch outer for wear or damage.
Measure the clutch outer I.D.

Service Limit:

107.5 mm (4.3 in) replace if over

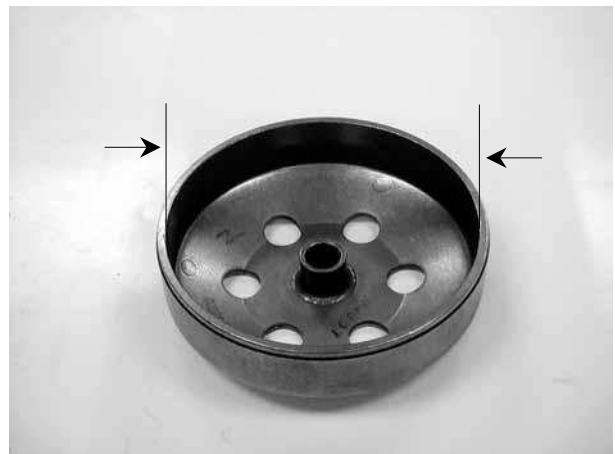

9. KICK STARTER/DRIVE PULLEY/ CLUTCH/DRIVEN PULLEY

Check the clutch shoes for wear or damage.
Measure the clutch lining thickness.

Service Limit:

2 mm (0.08 in) replace if below

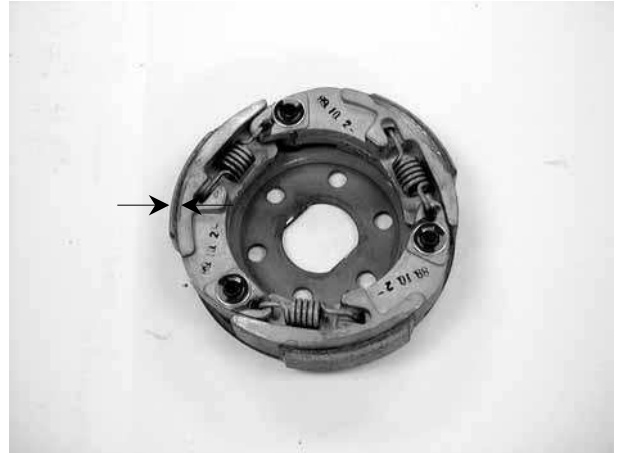

Measure the driven face spring free length.

Service Limit:

92.8 mm (3.712) replace if below

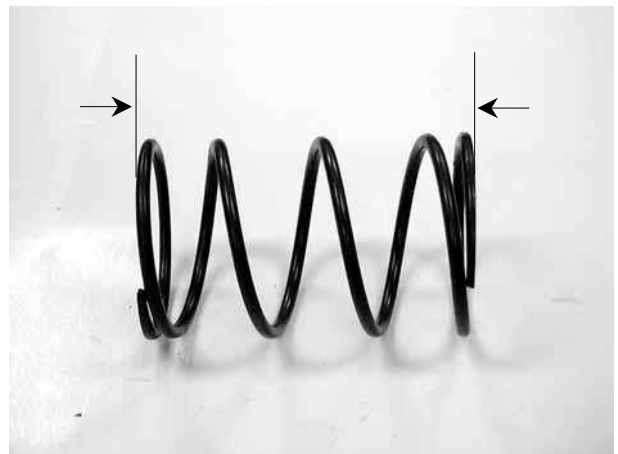

Check the driven face assembly for wear or damage.

Measure the driven face O.D.

Service Limit:

33.94 mm (1.3576 in) replace if below

Check the movable driven face for wear or damage.

Measure the movable driven face I.D.

Service Limit:

34.4 mm (1.376 in) replace if over

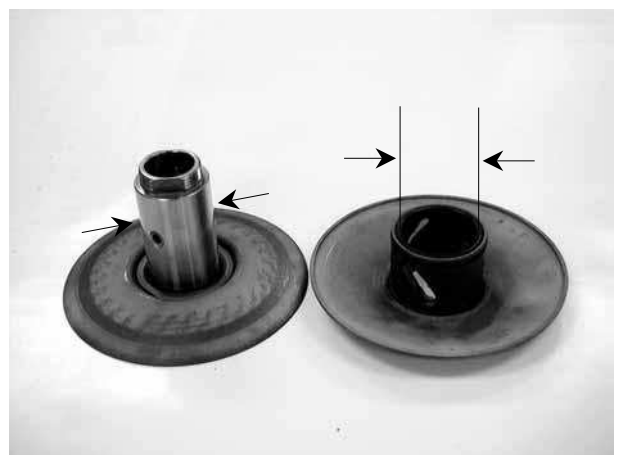

Check the guide roller pins for stepped wear.

9. KICK STARTER/DRIVE PULLEY/ CLUTCH/DRIVEN PULLEY

DRIVEN PULLEY FACE BEARING REPLACEMENT

Check the needle bearings in the driven face and replace them if they have excessive play, damage or abnormal noise.

Drive the inner bearing out of the driven pulley face.

Inner Bearing



Remove the snap ring and drive the outer bearing out of the driven face.



Outer Bearing

Drive a new outer bearing into the driven face with the sealed end facing up.

Seat the snap ring in its groove.

- * Pack all bearing cavities with 6 g (0.02 lb) grease.
Specified grease:
230°C Heat-resistant grease

Bearing Outer Driver



9. KICK STARTER/DRIVE PULLEY/ CLUTCH/DRIVEN PULLEY

Drive in a new needle bearing into the driven face with the mark facing up

Bearing Driver Pilot



CLUTCH/DRIVEN PULLEY ASSEMBLY

First install the movable driven face onto the driven face. Then, install the guide roller pins, O-rings and a new oil seal.

Driven Pulley

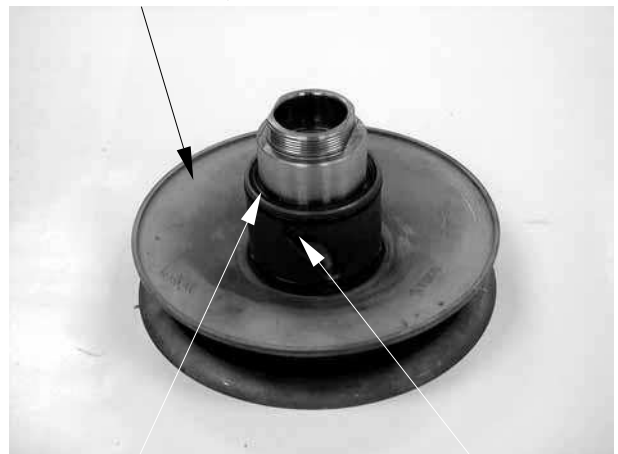

O-rings

Guide Roller Pin

Install the seal collar.



Seal Collar

9. KICK STARTER/DRIVE PULLEY/ CLUTCH/DRIVEN PULLEY

Set the driven pulley, driven face spring and clutch assembly onto the clutch spring compressor. Compress the tool and install the 39 mm (1.56 in) drive plate nut.

Tighten the 39 mm (1.56 in) nut to the specified torque.

Torque: 5.5 kgf-m (55 N-m, 39.6 lbf-ft)

Special tool:

Clutch spring compressor **A120E00034**

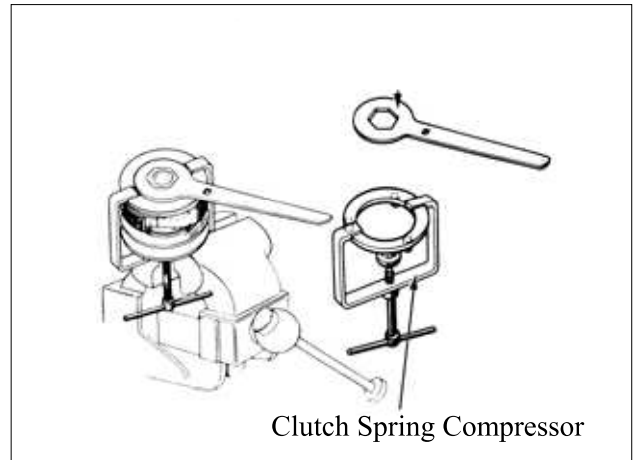

CLUTCH/DRIVEN PULLEY INSTALLATION

Install the drive belt on the clutch/driven pulley and then install the clutch/driven pulley onto the drive shaft.

Clutch/Driven Pulley

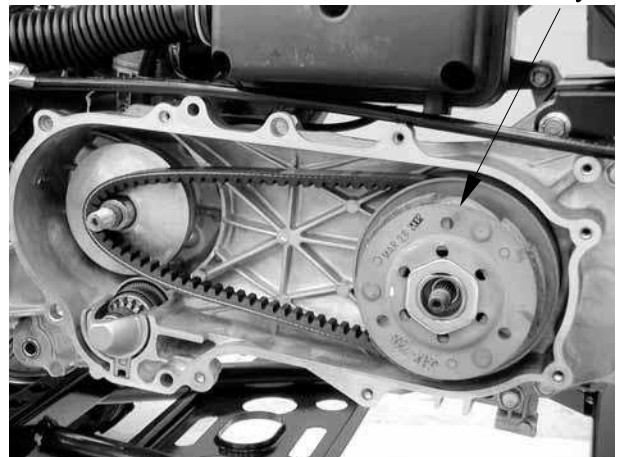

Install the clutch outer.

Hold the clutch outer with the universal holder.

Install and tighten the clutch outer nut.

Torque: 3.8 kg-m (38 N-m, 27.4 lbf-ft)

Special tool:

Universal holder **A120E00017**

Install the left crankcase cover. (⇒9-6)

Clutch Outer



Universal Holder

FINAL REDUCTION (MXU 50/MX'ER 50)

SERVICE INFORMATION 10-2
TROUBLESHOOTING 10-2
FINAL REDUCTION DISASSEMBLY 10-3
FINAL REDUCTION INSPECTION 10-3
FINAL REDUCTION ASSEMBLY 10-6

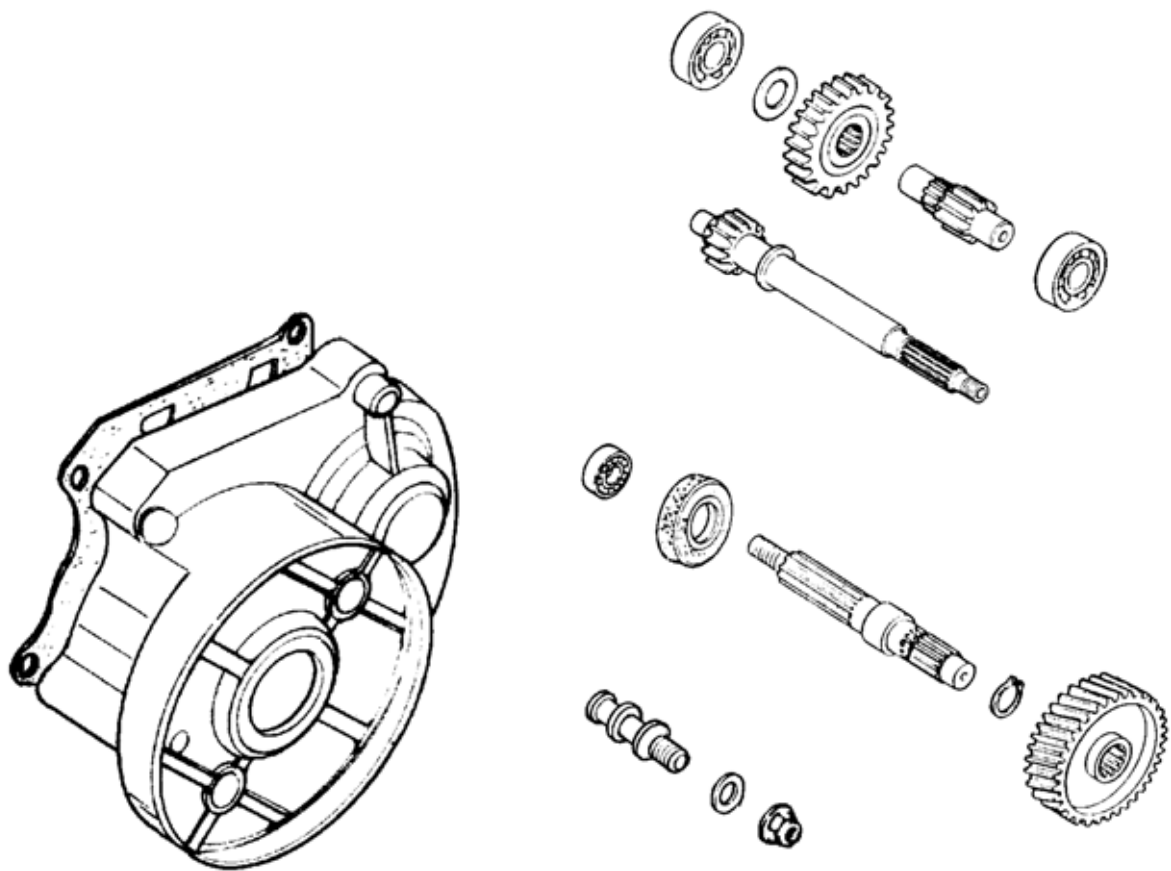

10. FINAL REDUCTION (MXU 50/MX'ER 50)

SERVICE INFORMATION

Specified Oil: SAE90#

At disassembly: 0.12 liter (0.11 Imp qt, 0.13 Us qt)

At change: 0.09 liter (0.08 Imp qt, 0.1 Us qt)

SPECIAL TOOLS

Oil seal and bearing installer A120E00014

Bearing puller A120E00037

TROUBLESHOOTING

Engine starts but motorcycle won't move

- Damaged transmission
- Seized or burnt transmission

Abnormal noise

- Worn, seized or chipped gears
- Worn bearing

Oil leaks

- Oil level too high
- Worn or damaged oil seal

10. FINAL REDUCTION (MXU 50/MX'ER 50)

FINAL REDUCTION DISASSEMBLY

- Remove the left crankcase cover. (⇒9-3)
- Remove the clutch/driven pulley. (⇒9-12)
- Drain the transmission gear oil into a clean container. (⇒3-8)
- Remove the transmission case cover attaching bolts.
- Remove the transmission case cover.
- Remove the gasket and dowel pins.

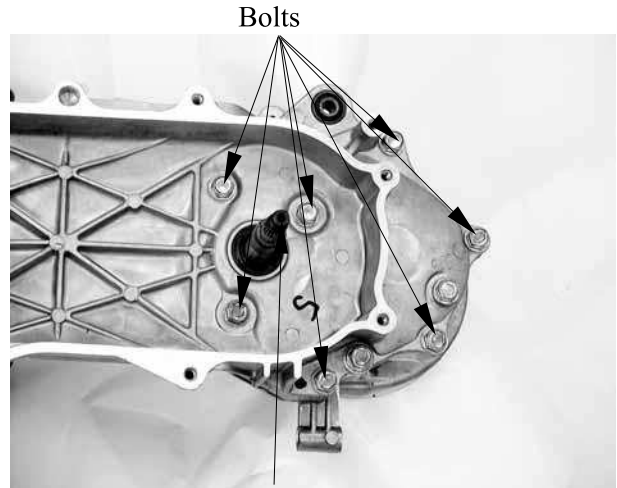

Driver shift

Remove the final gear and countershaft.

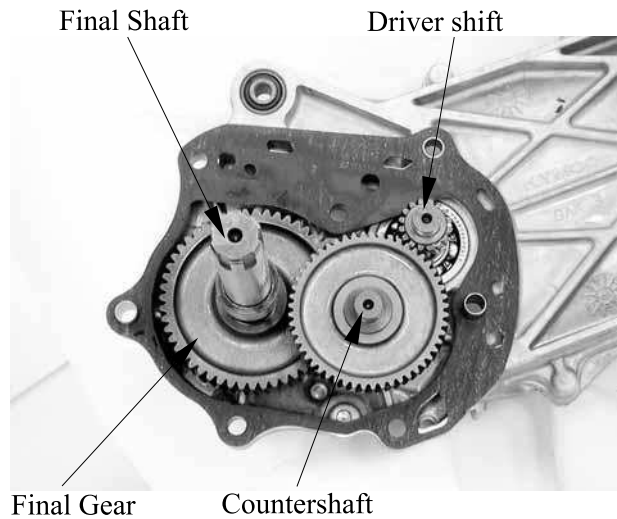

Final Gear Countershaft

FINAL REDUCTION INSPECTION

Inspect the countershaft and gear for wear or damage.

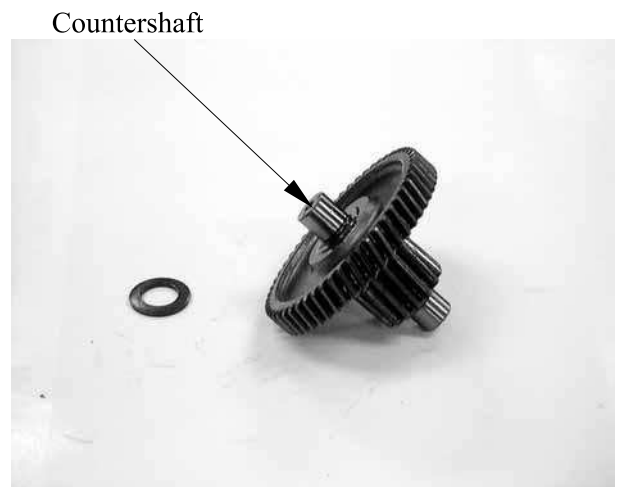

10. FINAL REDUCTION (MXU 50/MX'ER 50)

Inspect the final gear and final shaft for wear, damage or seizure.



Check the left crankcase bearings for excessive play and inspect the oil seal for wear or damage.

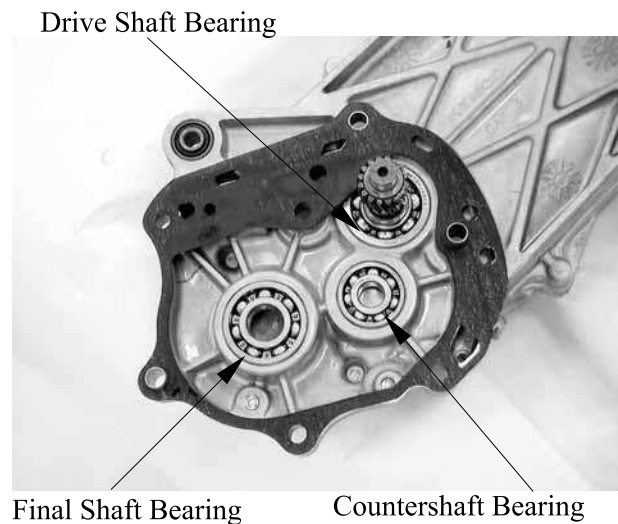

Inspect the drive shaft and gear for wear or damage.
Check the transmission case cover bearings for excessive play and inspect the final shaft bearing oil seal for wear or damage.

Do not remove the transmission case cover except for necessary part replacement. When replacing the drive shaft, also replace the bearing and oil seal.

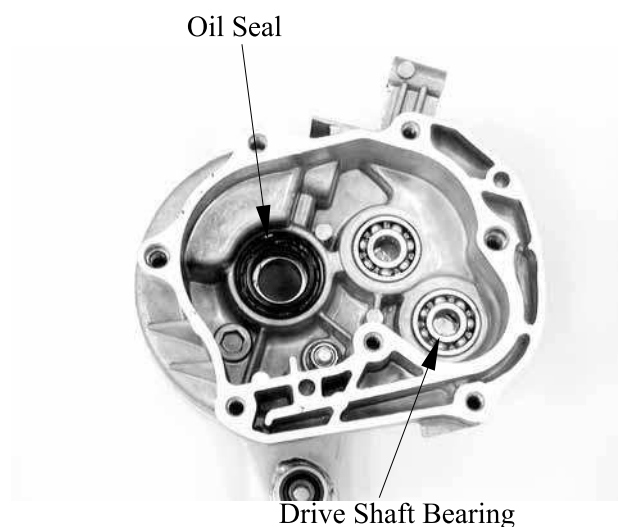

10. FINAL REDUCTION (MXU 50/MX'ER 50)

BEARING REPLACEMENT (Transmission Case Cover)

Remove the transmission case cover bearings using the bearing remover.
Remove the final shaft oil seal.

Special tool:

Bearing puller A120E00037

Drive Shaft Bearing

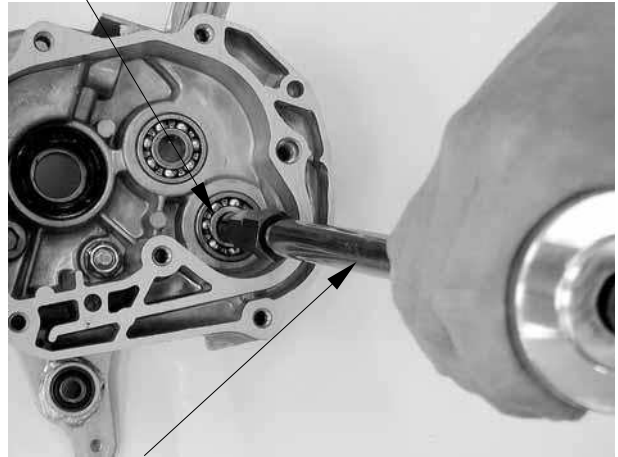

Bearing Remover Set

Drive new bearings into the transmission case cover.

Special tool:

Oil seal and bearing installer A120E00014

Bearing Outer Driver Handle



BEARING REPLACEMENT (Left Crankcase Cover)

Remove the drive shaft.
Remove the drive shaft oil seal.
Remove the left crankcase bearings using the bearing remover.

Special tool:

Bearing puller A120E00037



Bearing Remover Set, 15mm

10. FINAL REDUCTION (MXU 50/MX'ER 50)

Drive new bearings into the left crankcase.
Install a new drive shaft oil seal.

Special tool:

Oil seal and bearing installer A120E00014



Bearing Outer Driver

FINAL REDUCTION ASSEMBLY

Install the drive shaft into the left crankcase.

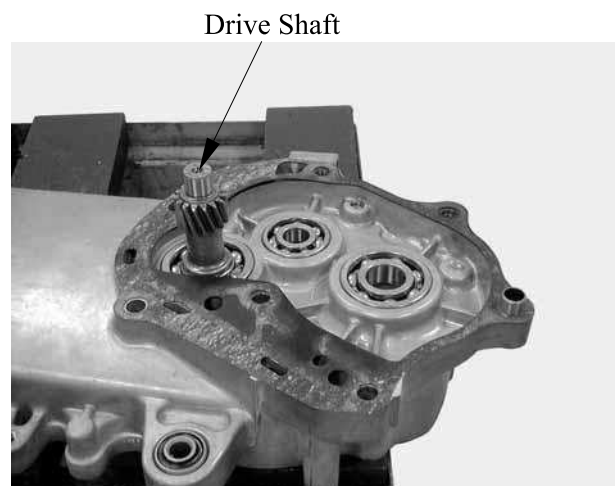

Install the final gear and final shaft into the left crankcase.



10. FINAL REDUCTION (MXU 50/MX'ER 50)

Install the countershaft and gear into the left crankcase.
 Install the resin washer onto the counter-
 shaft.
 Install the dowel pins and a new gasket.

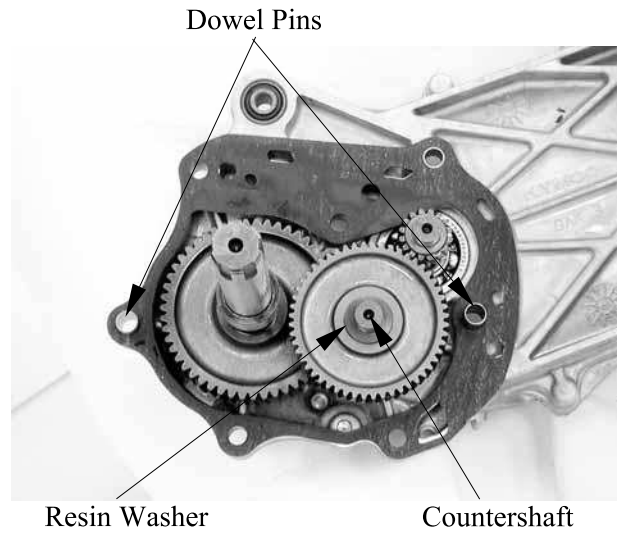

Install the transmission case cover.



Install and tighten the transmission case cover bolts.
 Install the clutch/driven pulley. (⇒9-17)
 Install other removed parts in the reverse order of removal.

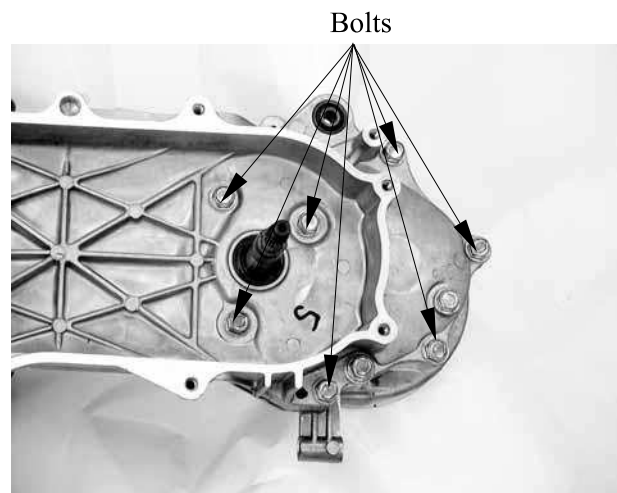

10. FINAL REDUCTION (MXU 50/MX'ER 50)

After installation, fill the transmission case with the specified oil.

- Place the motorcycle on its main stand on level ground.
- Check the sealing washer for wear or damage.

Specified Gear Oil: SAE90#

Oil Capacity:

at disassembly:

0.12 liter (0.11 Imp qt, 0.13 Us qt)

at change:

0.09 liter (0.08 Imp qt, 0.1 Us qt)

Install and tighten the oil check bolt.

Torque: 1.3 kg-m (13 N-m, 9.4 lbf-ft)

Start the engine and check for oil leaks. Check the oil level from the oil check bolt hole and add the specified oil to the proper level if the oil level is low.

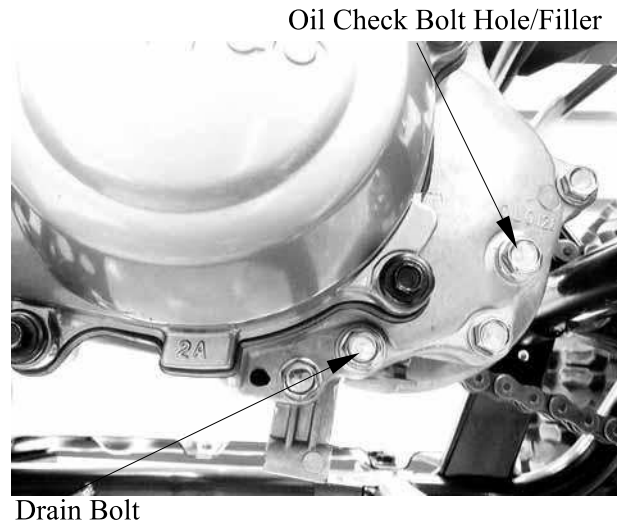

**FINAL REDUCTION/TRANSMISSION SYSTEM
(MXU 50 REVERSE)**

SERVICE INFORMATION----- 11- 2
TROUBLESHOOTING----- 11- 2
TRANSMISSION CASE COVER----- 11- 3
TRANSMISSION----- 11- 6

11.FINAL REDUCTION/ TRANSMISSION SYSTEM (MXU 50 REVERSE)

SERVICE INFORMATION

GENERAL INSTRUCTIONS

- The MXU 50 REVERSE transmission system can be serviced with the engine installed in the frame.

SPECIFICATIONS

Specified Oil: GEAR OIL SAE 90#

Oil Capacity: At change : 0.25 liter (0.22 imp qt, 0.26 US qt)
 At disassembly : 0.3 liter (0.26 imp qt, 0.32 US qt)

TORQUE VALUES

Transmission case cover bolt 2.7 kgf-m (27 Nm, 20 lbf-ft)

SPECIAL TOOLS

Oil seal & bearing driver A120E00014
Bearing puller A120E00037

TROUBLESHOOTING

Engine starts but motorcycle won't move

- Damaged transmission
- Seized or burnt transmission

Oil leaks

- Oil too rich
- Worn or damaged oil seal

TRANSMISSION CASE COVER

REMOVAL

Drain transmission gear oil into a clean container. (Refer to the “TRANSMISSION OIL REPLACEMENT” section in the chapter 3)

Remove the three bolts and then remove the drive sprocket cover (see page 6-4).
Remove the two bolts and then remove the washer and drive sprocket (see page 6-4).

Remove the bolt and then disconnect the drive shift arm from the shift shaft.

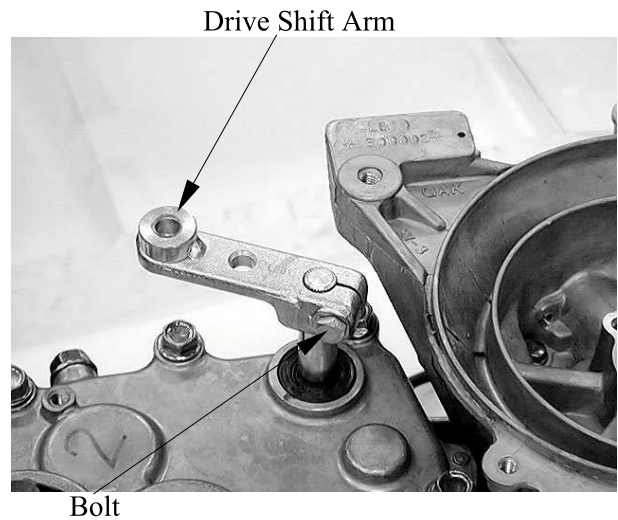

Remove eight bolts from transmission case cover.

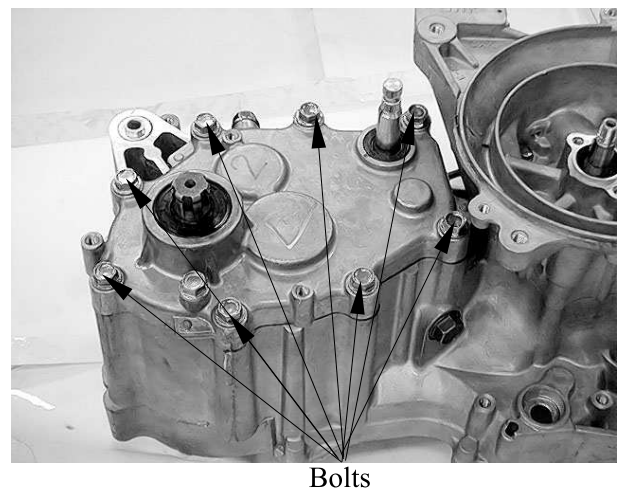

Remove the transmission case cover, dowel pins and gasket.

Inspect the bearings for allow play in the transmission case cover or the bearings turn roughly.
If any defects are found, replace the bearing with a new one.

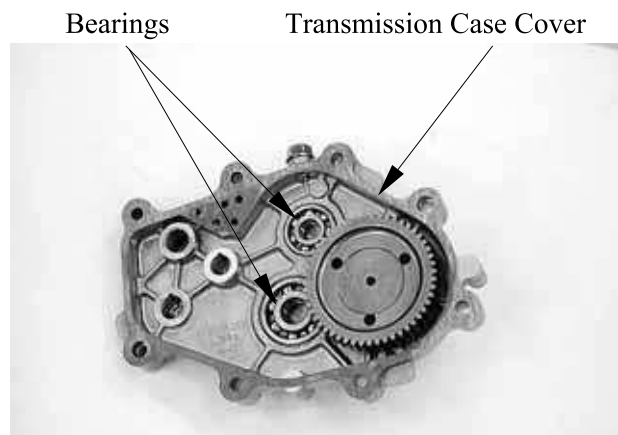

11.FINAL REDUCTION/ TRANSMISSION SYSTEM (MXU 50 REVERSE)

Remove the transmission case cover bearings using the special tool.

Special tools:

Bearing puller A120E00037

Install the new bearings using the special tool.

Special tool:

Oil seal & bearing driver A120E00014

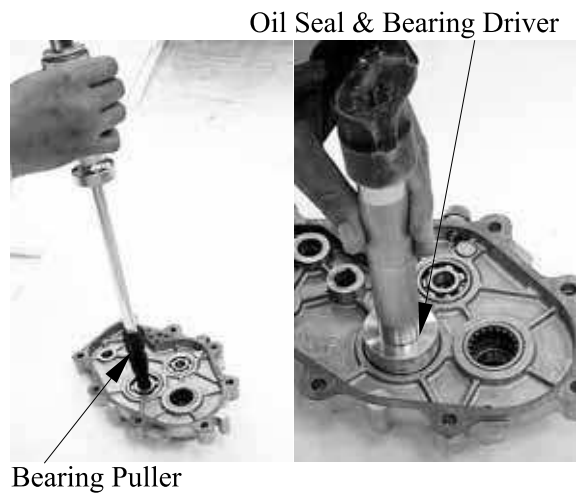

TRANSMISSION CASE COVER DISASSEMBLY

Inspect the oil seal for wear or damage.

If any defects are found, replace the oil seal with a new one.

Remove the oil seal.

Remove the drive axle snap ring.

Remove the drive axle from the transmission case cover.

Remove the bearing snap ring for remove the bearing.

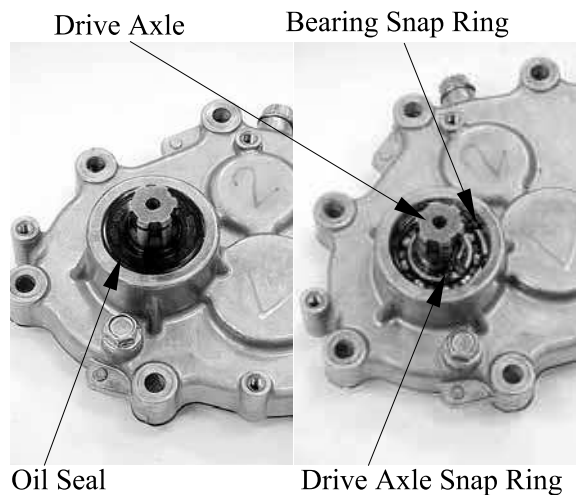

Inspect the bearing and needle bearing for allow play in the transmission case cover or the bearing turns roughly.

If any defects are found, replace the bearing with a new one.

11.FINAL REDUCTION/ TRANSMISSION SYSTEM (MXU 50 REVERSE)

Inspect the drive axle gear teeth for wear or damage.



Remove the bearing from transmission case cover.

Remove the needle bearing from transmission case cover.

Bearing



Needle Bearing



ASSEMBLY

Install a new needle bearing using the special tool.

Special tool:

Oil seal & bearing driver A120E00014

Install a new bearing using the special tool.

Special tool:

Oil seal & bearing driver A120E00014

Needle Bearing

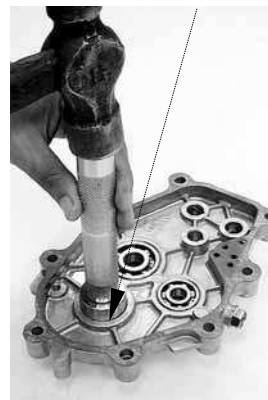

Bearing

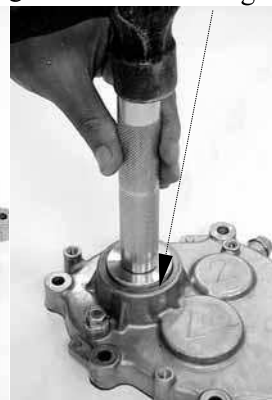

11.FINAL REDUCTION/ TRANSMISSION SYSTEM (MXU 50 REVERSE)

Install the drive axle.

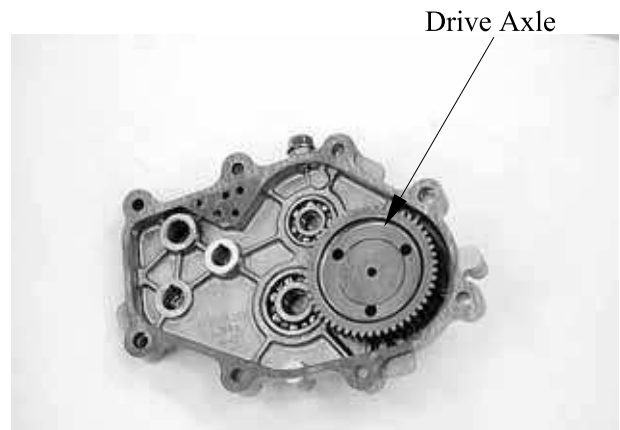

Install the drive axle snap ring.
Install the bearing snap ring.
Install a new oil seal using the special tool.

Special tool:
Oil seal & bearing driver A120E00014

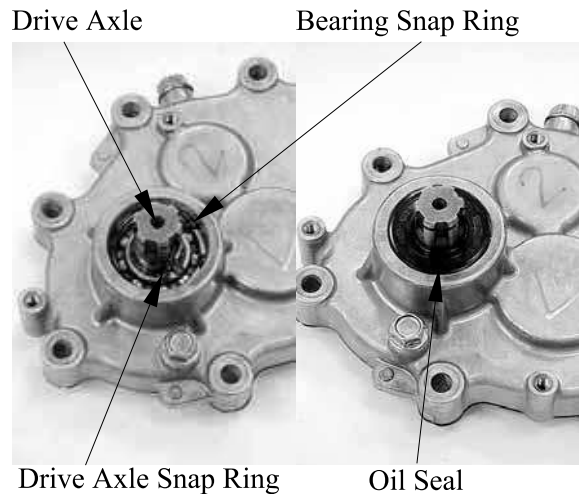

TRANSMISSION REMOVAL

Remove the transmission cover. (Refer to the "TRANSMISSION CASE COVER REMOVAL" in the chapter 11)

Check the transmission operation.
Unsmooth operation → Repair.

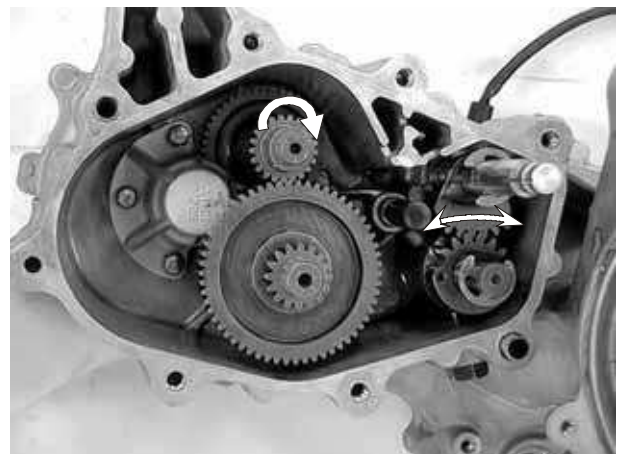

11.FINAL REDUCTION/ TRANSMISSION SYSTEM (MXU 50 REVERSE)

Remove the shift shaft.

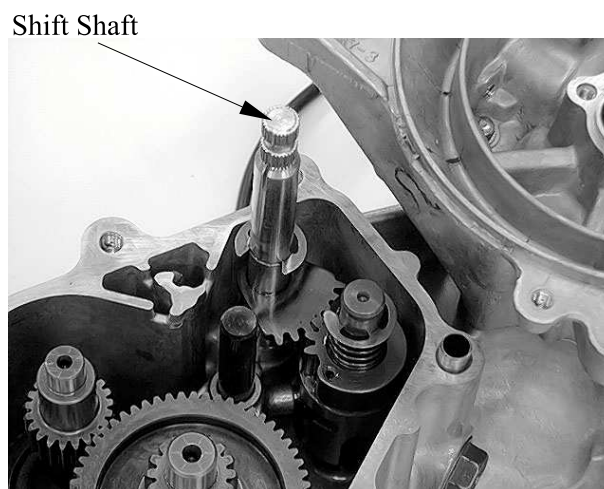

Remove the stopper plug.

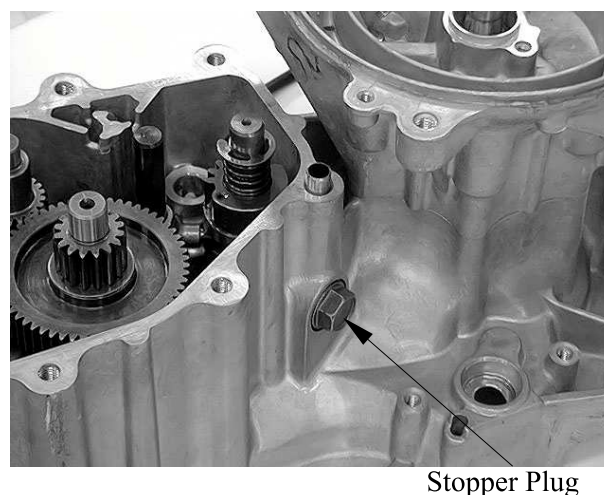

Remove spring, washer and shift cam stopper.

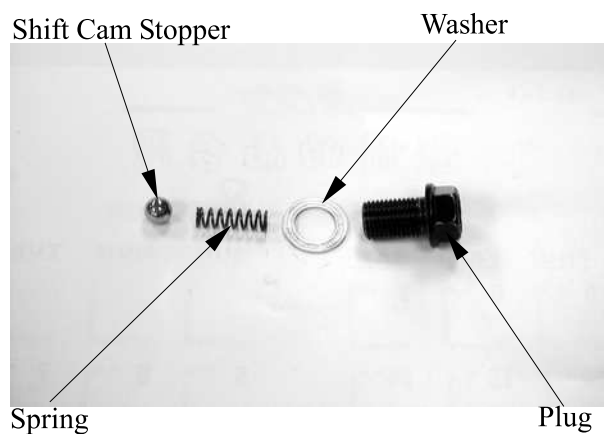

11.FINAL REDUCTION/ TRANSMISSION SYSTEM (MXU 50 REVERSE)

Remove the transmission guide bar.

Guide Bar

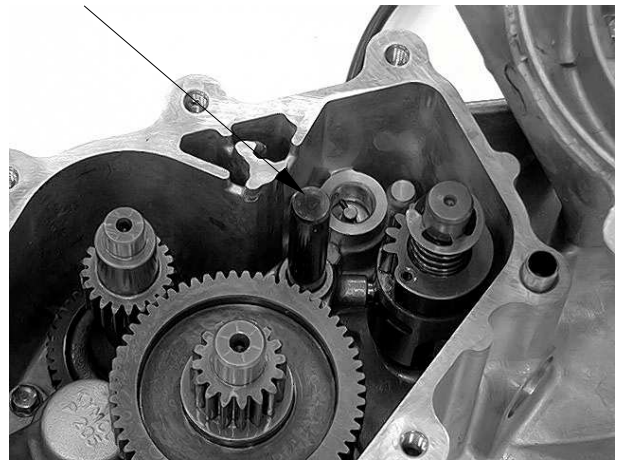

Remove shift cam.

Shift Cam

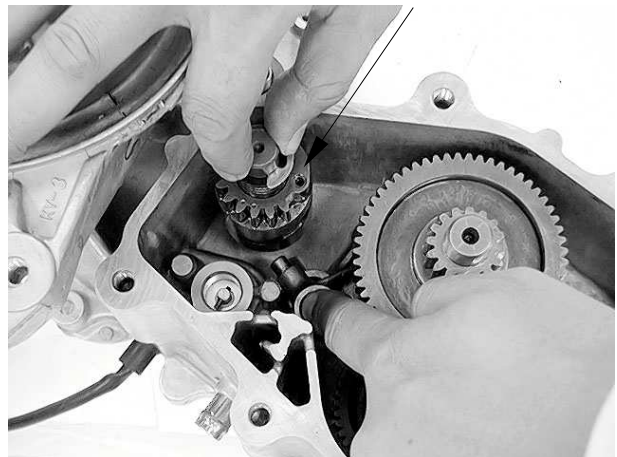

Remove the shift fork.

Shift Fork

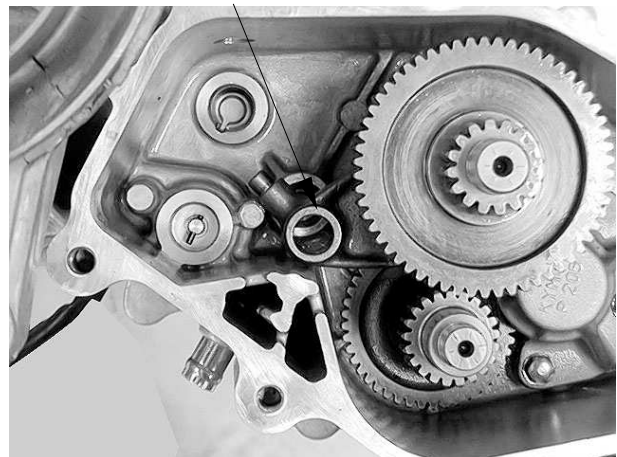

11.FINAL REDUCTION/ TRANSMISSION SYSTEM (MXU 50 REVERSE)

Measure the guide bar runout.
Out of specification → Replace.

Service Limit:

Less than 0.03 mm (0.0012 in)

Do not attempt to straighten a bent guide bar.

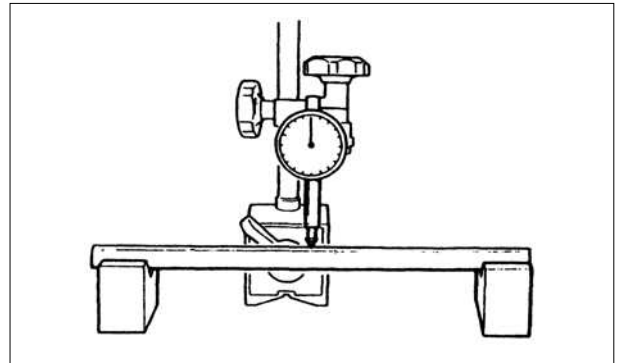

Inspect the shift fork cam follower and shift fork pawl.
Scoring/beads/wear → Replace.

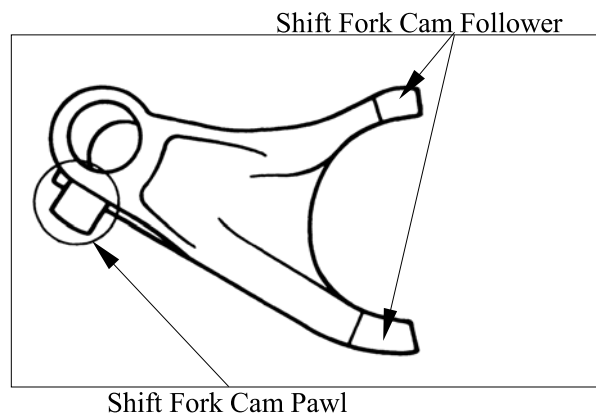

Check the shift cam groove and shift cam gear.
Wear or damage → Replace.



11.FINAL REDUCTION/ TRANSMISSION SYSTEM (MXU 50 REVERSE)

Inspect shift shaft gear.
Damage → Replace.
Inspect shift shaft.
Damage/bends/wear → Replace.

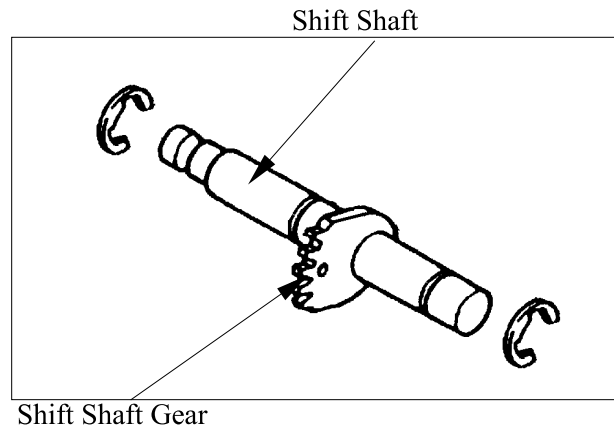

Remove three bolts from primary drive axle cover.
Remove the primary drive axle cover, dowel pins and washer.

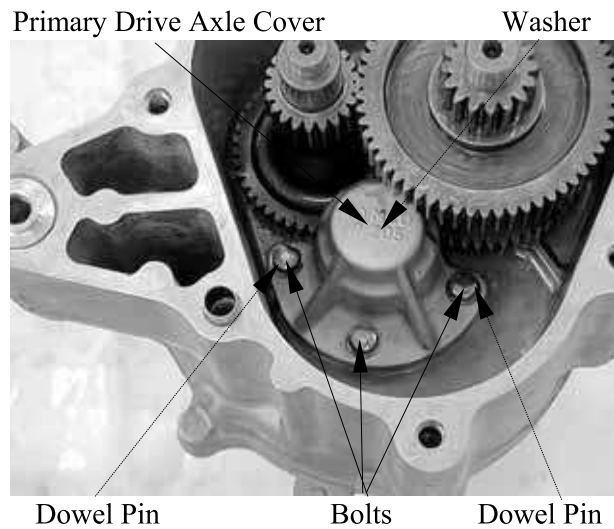

Remove the main axle.

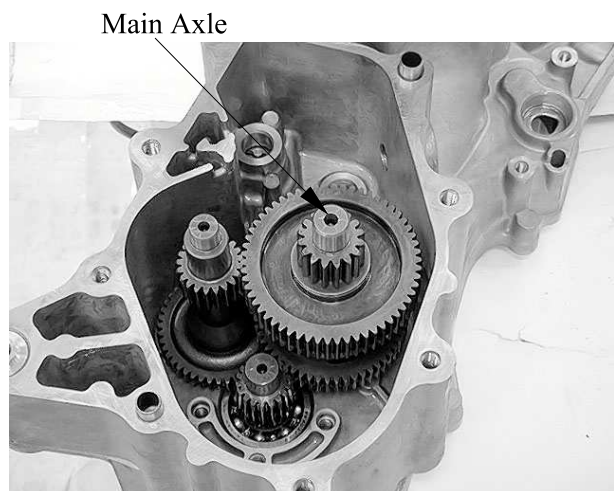

11.FINAL REDUCTION/ TRANSMISSION SYSTEM (MXU 50 REVERSE)

MAIN AXLE DISASSEMBLY

Remove the collar, washers, primary driven gear.

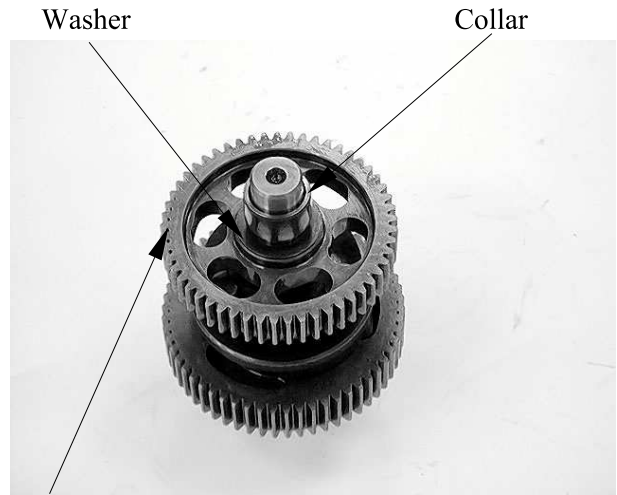

Primary Driven Gear

Remove the bush, washer and clutch dog.

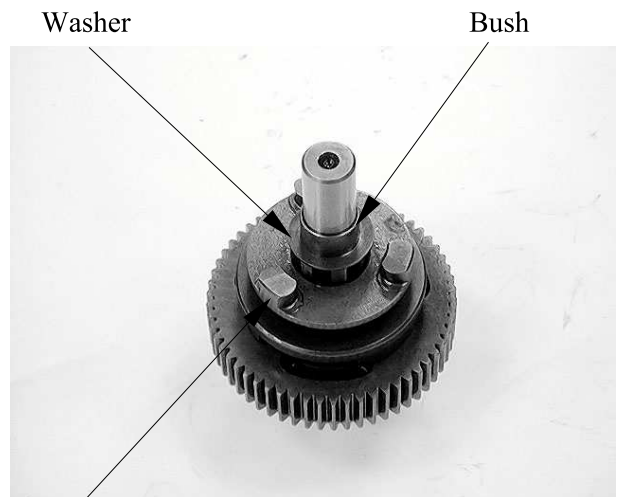

Clutch Dog

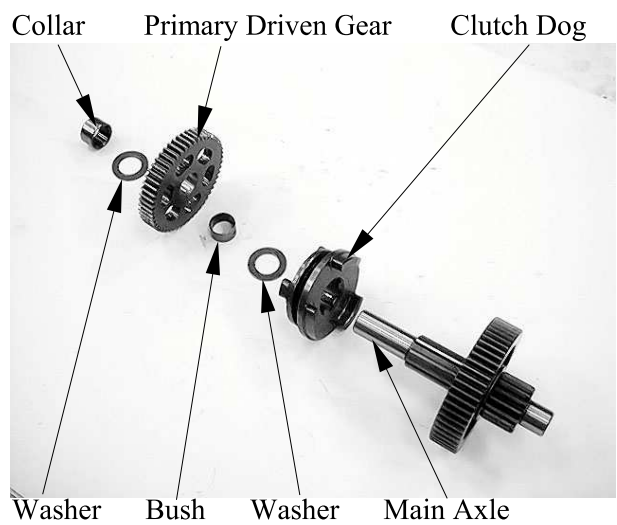

11.FINAL REDUCTION/ TRANSMISSION SYSTEM (MXU 50 REVERSE)

Remove the snap ring and then remove the washers, reverse wheel gear.

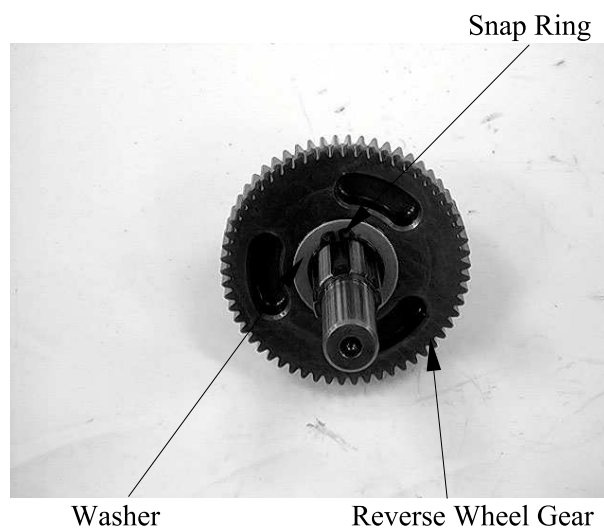

11.FINAL REDUCTION/ TRANSMISSION SYSTEM (MXU 50 REVERSE)

Inspect the gear teeth.
Blue discoloration/pitting/wear → Replace.

Inspect the mated dogs.
Rounded edges/cracks/missing portions
→ Replace.

Inspect the needle bearing for allow play in
the reverse wheel gear or the bearing turns
roughly.
If any defects are found, replace the bearing
with a new one.

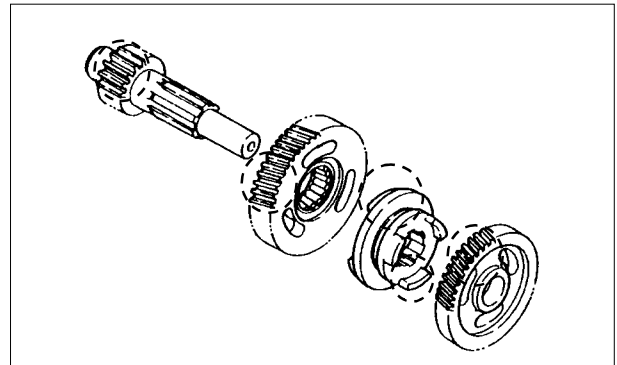

MAIN AXLE ASSEMBLY

Reverse the “MAIN AXLE
DISASSEMBLY” procedures.

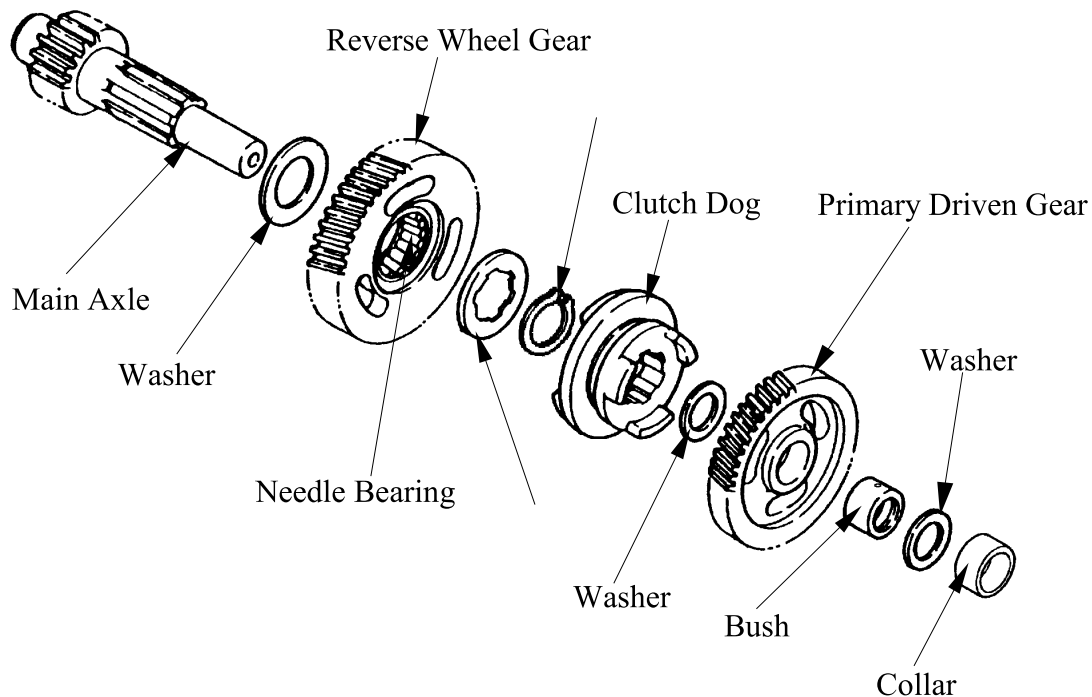

11.FINAL REDUCTION/ TRANSMISSION SYSTEM (MXU 50 REVERSE)

Remove the counter axle and washer.

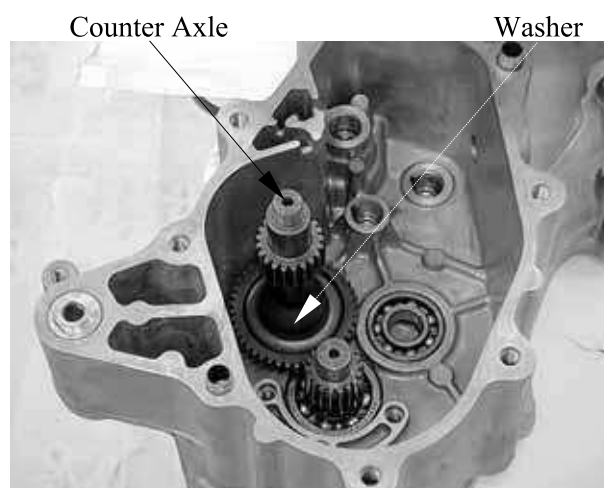

Inspect the gear teeth.
Blue discoloration/pitting/wear → Replace.



PRIMARY DRIVE AXLE REMOVAL

Remove the clutch/driven pulley. (Refer to the chapter 9)

Remove the oil seal.
Remove the primary drive axle.

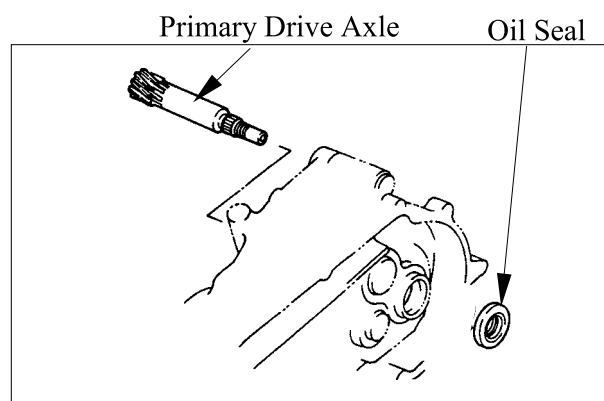

11.FINAL REDUCTION/ TRANSMISSION SYSTEM (MXU 50 REVERSE)

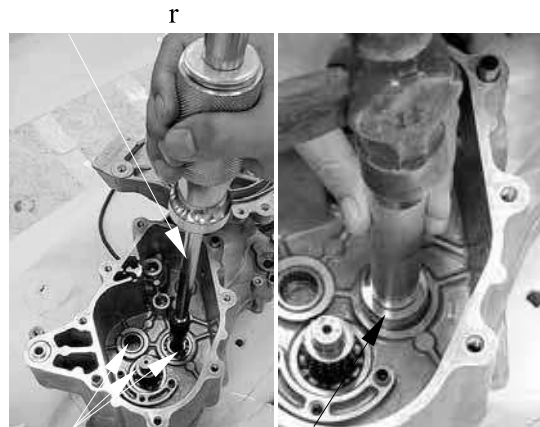

Oil Seal & Bearing Driver

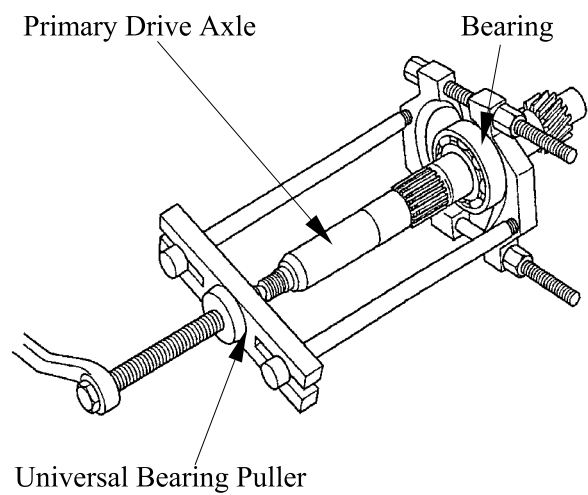

11.FINAL REDUCTION/ TRANSMISSION SYSTEM (MXU 50 REVERSE)

INSTALLATION

Reverse the “TRANSMISSION REVOVAL” section procedures.

Install the main drive axle. (Reverse the “MAIN DRIVE AXLE” procedures.)

Install the washer and counter axle.

Install the main axle washer.

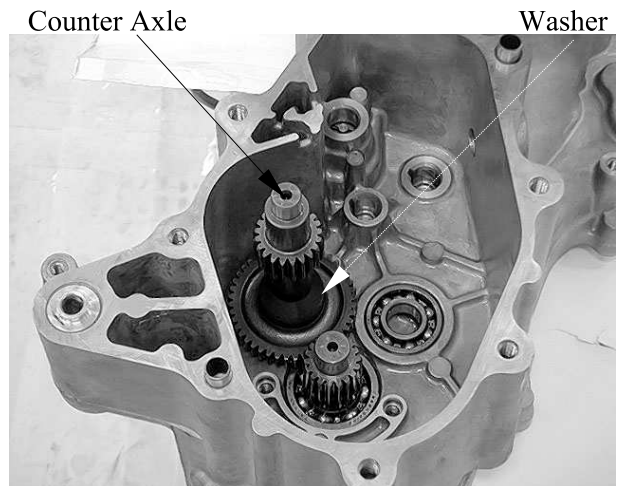

Install the main axle.

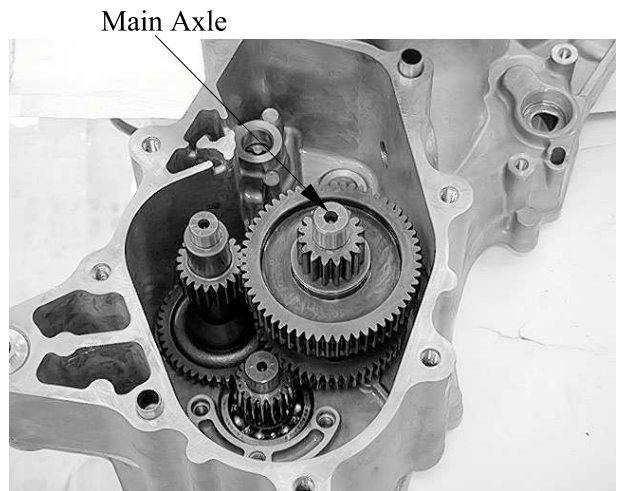

Install the two dowel pins.

Install the washer onto the primary drive axle.

Install the primary drive axle cover.

Install and tighten the three bolts securely.

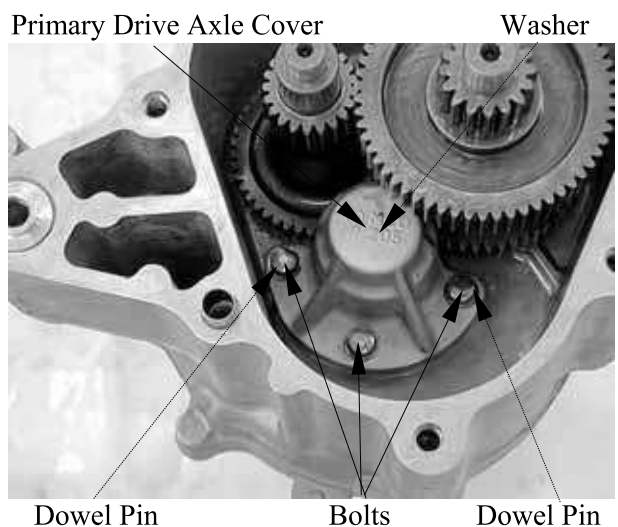

11.FINAL REDUCTION/ TRANSMISSION SYSTEM (MXU 50 REVERSE)

Install the shift fork.

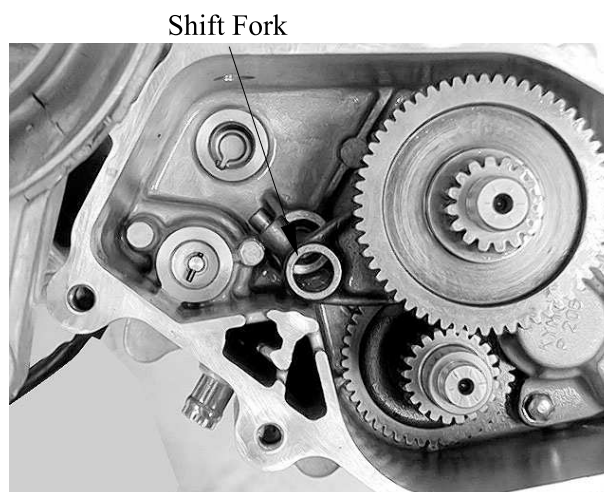

Install the shift cam.



Install the guide bar.

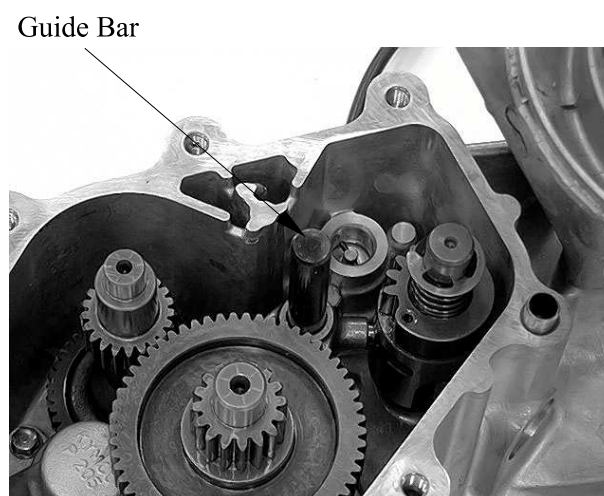

11.FINAL REDUCTION/ TRANSMISSION SYSTEM (MXU 50 REVERSE)

Install the shift shaft.

Make sure that the lever on the gear change switch correctly engages with the locating slot on the shift shaft.
Align the mark on the shift shaft gear with the mark on the shift cam gear.

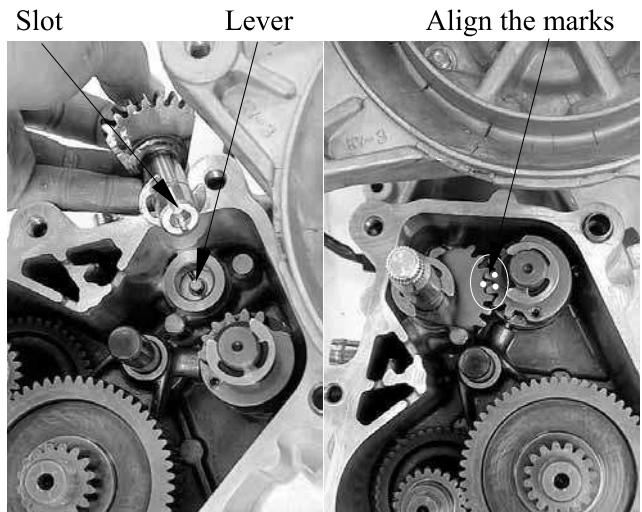

Install the shift cam stopper and tighten the plug.

Torque: 4.8 kgf-m (48 Nm, 35 lbf-ft)

Check the transmission operation (see page 11-6).

Install the dowel pins and a new gasket onto the transmission case.

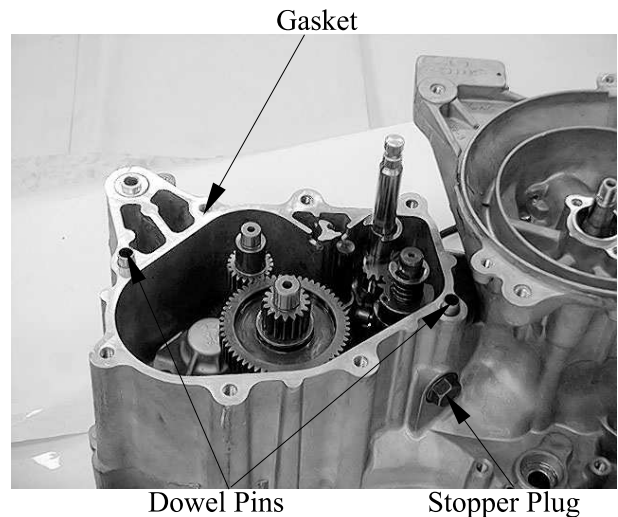

Install the transmission case cover and tighten the transmission case cover bolts.

Torque: 2.7 kgf-m (27 Nm, 20 lbf-ft)

Fill the engine with oil and install the oil filler bolt. (Refer to the "TRANSMISSION OIL REPLACEMENT" section in the chapter 3)

Specified Gear Oil:
KYMCO SIGMA GEAR OIL 90#
Oil Capacity:

At disassembly:
0.3 liter (0.26 Imp qt, 0.32 US qt)

At change:
0.25 liter (0.22 Imp qt, 0.26 US qt)

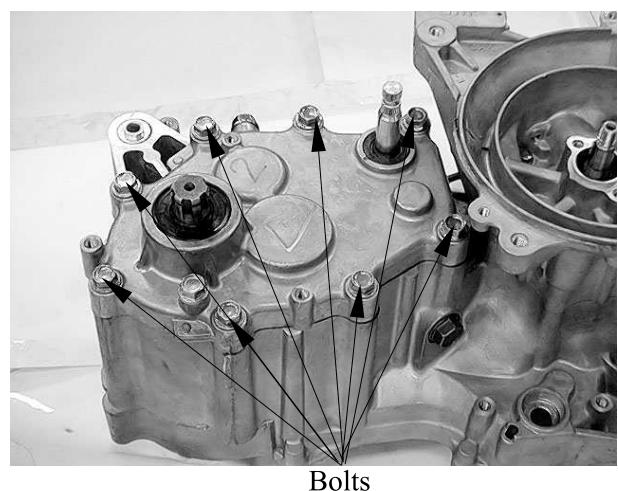

12. CRANKCASE/CRANKSHAFT

CRANKCASE/CRANKSHAFT

SERVICE INFORMATION 12-2
TROUBLESHOOTING 12-2
CRANKCASE SEPARATION 12-3
CRANKSHAFT REMOVAL..... 12-3
CRANKSHAFT INSPECTION 12-4
CRANKSHAFT INSTALLATION 12-5
CRANKCASE ASSEMBLY..... 12-7

12. CRANKCASE/CRANKSHAFT

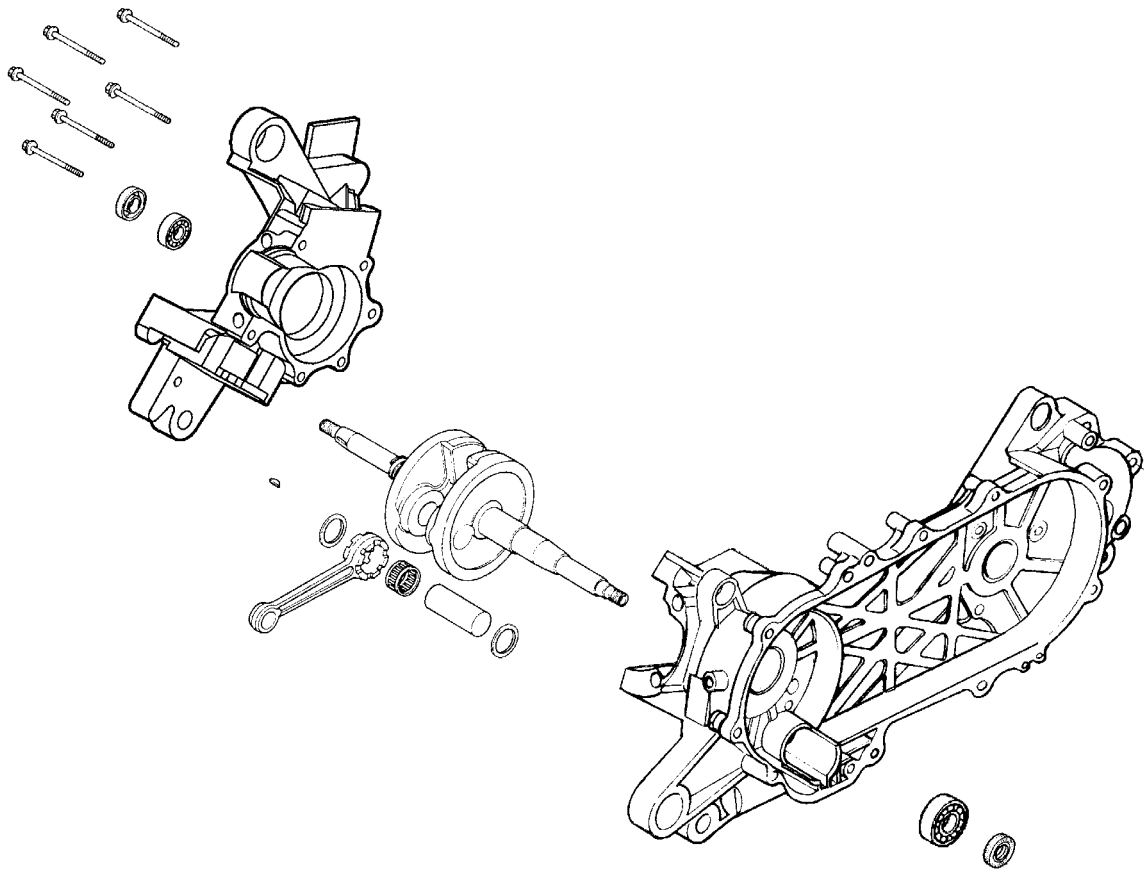

12. CRANKCASE/CRANKSHAFT

SERVICE INFORMATION

GENERAL INSTRUCTIONS

- This section covers crankcase separation to service the crankshaft.
- The following parts must be removed before separating the crankcase.

Engine (⇒Section 6)	Driven pulley (⇒Section 9)
Carburetor (⇒Section 5)	A.C. generator (⇒Section 8)
Oil pump (⇒Section 4)	Cylinder head/cylinder (⇒Section 7)
Reed valve (⇒Section 5)	
- When the left crankcase must be replaced, remove the following part in addition to the above.
Final reduction removal
- Special tools must be used for crankshaft and crankcase assembly. When separating the crankcase, the bearing will remain in the crankcase and it should be removed. When assembling, drive a new bearing into the crankcase and install a new oil seal.

SPECIFICATIONS

mm (in)

Item	Standard	Service Limit
Connecting rod big end side clearance	—	0.6 (0.024)
Connecting rod big end radial clearance	—	0.04 (0.0016)
Crankshaft runout A/B	—	0.15 (0.006)/0.1 (0.004)

SPECIAL TOOLS

Crankcase puller	A120E00026
Universal bearing puller	A120E00030
Crankcase assembly tool (left crankcase)	A120E00024
Crankcase assembly tool (right crankcase)	A120E00016
Oil seal & bearing driver	A120E00014

TROUBLESHOOTING

Abnormal engine noise

- Excessive crank journal bearing play
- Excessive crankpin bearing play
- Excessive transmission bearing play

12. CRANKCASE/CRANKSHAFT

CRANKCASE SEPARATION

Remove the crankcase attaching bolts.

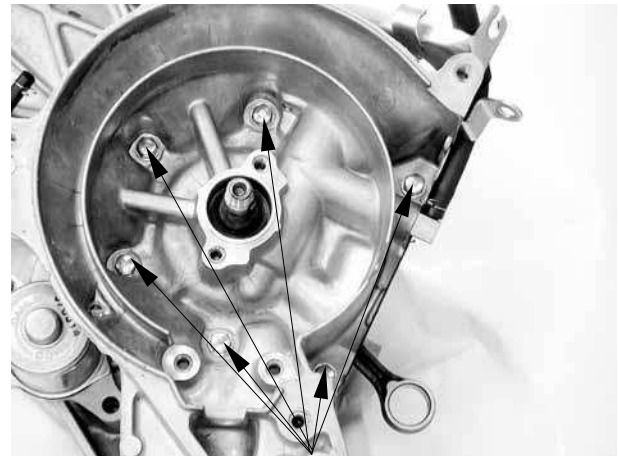

Bolt

Attach the crankcase puller on the right crankcase and remove the right crankcase from the left crankcase.

Special tool:

Crankcase puller A120E00026

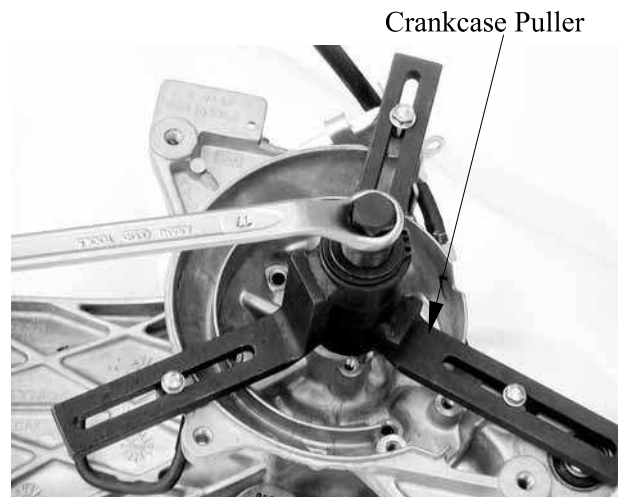

Crankcase Puller

CRANKSHAFT REMOVAL

Attach the crankcase puller on the left crankcase and remove the crankshaft from the left crankcase.

When removing the crankshaft, do it slowly and gently.

Special tool:

Crankcase puller A120E00026

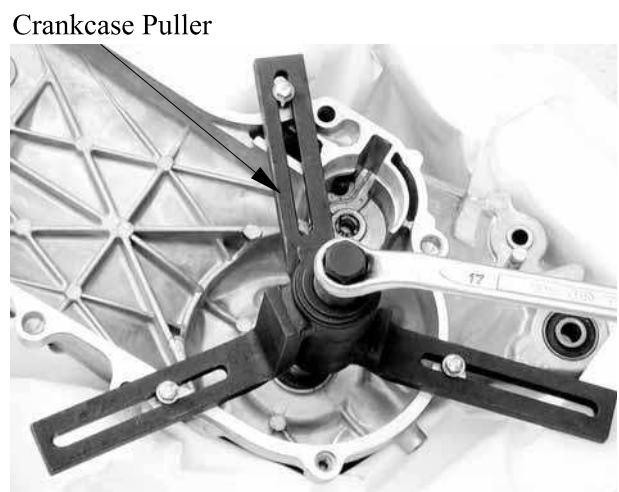

Crankcase Puller

12. CRANKCASE/CRANKSHAFT

When separating the crankcase, the oil seals must be removed. Replace the oil seals with new ones.

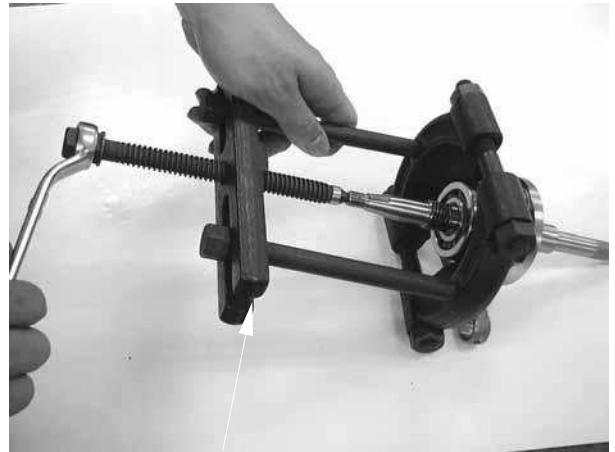

r

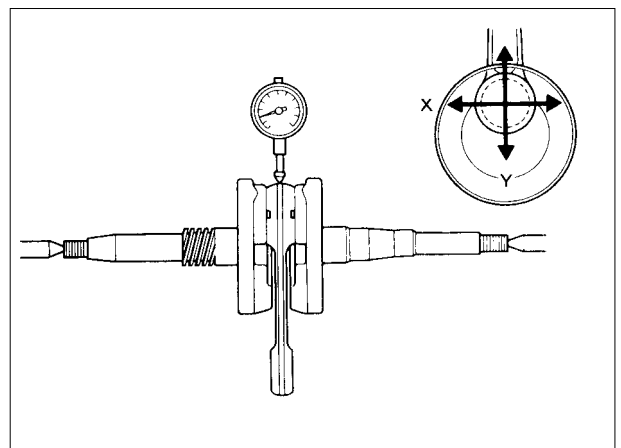

12. CRANKCASE/CRANKSHAFT

Measure the crankshaft runout.

Service Limit	
A	B
0.15 mm (0.006 in) replace if over	0.1 mm (0.004 in) replace if over

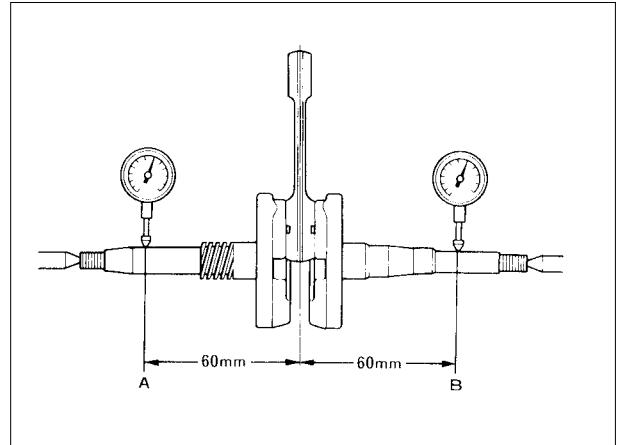

Check the crankshaft bearings for excessive play. The bearings must be replaced if they are noisy or have excessive play.

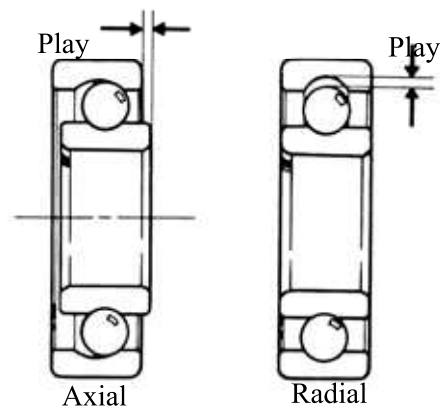

CRANKSHAFT INSTALLATION

Wash the crankshaft in cleaning solvent and then check for cracks or other faults.

- After check, apply clean engine oil to all moving and sliding parts.
- Remove all gasket material from the crankcase mating surfaces. Dress any roughness or irregularities with an oil stone.



12. CRANKCASE/CRANKSHAFT

Drive a new crankshaft bearing into the right crankcase.

Special tool:

Oil seal & bearing driver A120E00014

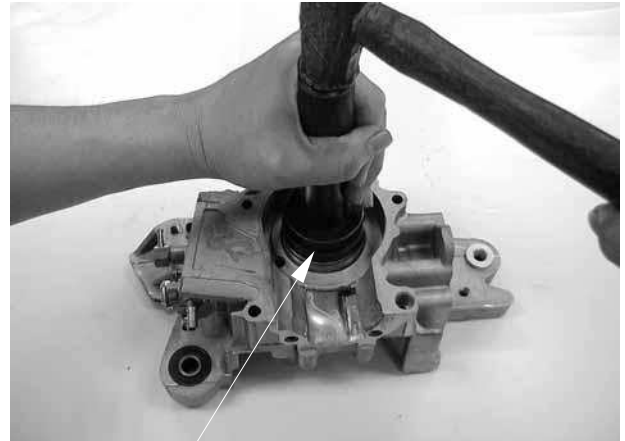

Oil Seal & Bearing Driver

Drive a new crankshaft bearing into the left crankcase.

Special tool:

Oil seal & bearing driver A120E00014



Oil Seal & Bearing Driver

Install the crankshaft into the left crankcase.

- Apply KYMCO ULTRA motor oil or molybdenum disulfide to the crankshaft bearings and connecting rod big end.
- Apply grease to the lip of the oil seal and then install it.

Special tool:

Crankcase assembly tool (left crankcase)
A120E00024



Crankcase Assembly Tool

12. CRANKCASE/CRANKSHAFT

CRANKCASE ASSEMBLY

Install the dowel pins and a new gasket to the crankcase mating surface.

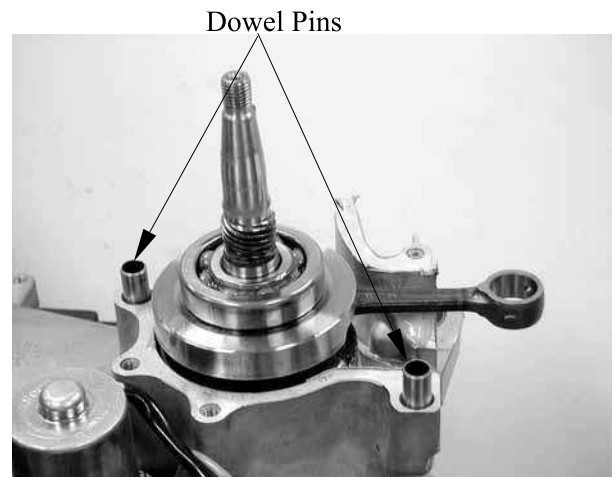

Assemble the crankcase halves.

Special tool:

Crankcase assembly tool
(Right crankcase) A120E00016



Crankcase Assembly Tool

The distance between the right crankcase oil seal and crankcase surface is about 12.5 ± 0.5 mm (0.5 ± 0.02 in).

When installing the oil seal, be careful to press it with even force.

12. CRANKCASE/CRANKSHAFT

The distance between the left crankcase oil seal and crankcase surface is about 1 mm (0.04 in).

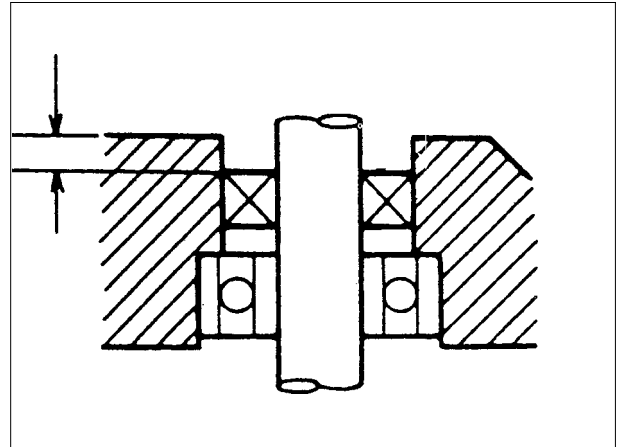

Install and tighten the crankcase attaching bolts.



**FRONT WHEEL/FRONT BRAKE/
FRONT SUSPENSION\STEERING SYSTEM**

SERVICE INFORMATION-----	13- 2
TROUBLESHOOTING-----	13- 3
FRONT WHEEL-----	13- 4
FRONT BRAKE-----	13- 7
FRONT SUSPENSION-----	13-10
STEERING SYSTEM-----	13-14

13. FRONT WHEEL/FRONT BRAKE/FRONT SUSPENSION/STEERING SYSTEM



ATV 50



13. FRONT WHEEL/FRONT BRAKE/FRONT SUSPENSION/STEERING SYSTEM



ATV 50

SERVICE INFORMATION

GENERAL INSTRUCTIONS

- Remove the machine frame covers before removing the front wheel. Jack the machine front wheel off the ground and be careful to prevent the machine from falling down.
- During servicing, keep oil or grease off the brake drum and brake linings.
- Inspect the brake system before riding.

SPECIFICATIONS

mm
(in)

Item		Standard	Service Limit
Front wheel rim run out	Radial	—	2 (0.08)
	Axial	—	2 (0.08)
Front brake drum I.D		110 (4.4)	111 (4.44)
Front brake lining thickness		4 (0.16)	1.5 (0.06)
Tie rod length		266.5 (10.66)	—
Rod-end (tie rod) angle		180°	—

TORQUE VALUES

Steering stem nut	7 kgf-m (70 N-m, 50 lbf-ft)
Swing arm nut	4.5 kgf-m (45 N-m, 32 lbf-ft)
Front wheel nut	4.5 kgf-m (45 N-m, 32 lbf-ft)
Front wheel hub nut	7 kgf-m (70 N-m, 50 lbf-ft)
Front shock absorber upper mount bolt	4 kgf-m (40 N-m, 29 lbf-ft)
Front shock absorber lower mount bolt	4 kgf-m (40 N-m, 29 lbf-ft)

SPECIAL TOOLS

Oil seal and bearing install A120E00014

TROUBLESHOOTING

Hard steering (heavy)

- Insufficient tire pressure

Steers to one side or does not track straight

- Uneven front shock absorbers
- Bent front arm
- Bent steering knuckle

Poor brake performance

- Incorrectly adjusted brake
- Worn brake linings
- Contaminated brake lining surface
- Worn brake shoes at cam contacting area
- Worn brake drum
- Poorly connected brake arm

Front wheel wobbling

- Bent rim
- Excessive wheel bearing play
- Bent spoke plate
- Faulty tire
- Improperly tightened axle nut

Soft front shock absorber

- Weak shock springs
- Insufficient damper oil

Front shock absorber noise

- Slider bending
- Loose arm fasteners
- Lack of lubrication

13. FRONT WHEEL/FRONT BRAKE/FRONT SUSPENSION/STEERING SYSTEM

FRONT WHEEL

REMOVAL

Place the machine on a level place.
 Remove four nuts attaching the wheel panel and front wheel.
 Elevate the front wheels by placing a suitable stand under the frame.

* Support the machine securely so there is no danger of it falling over.

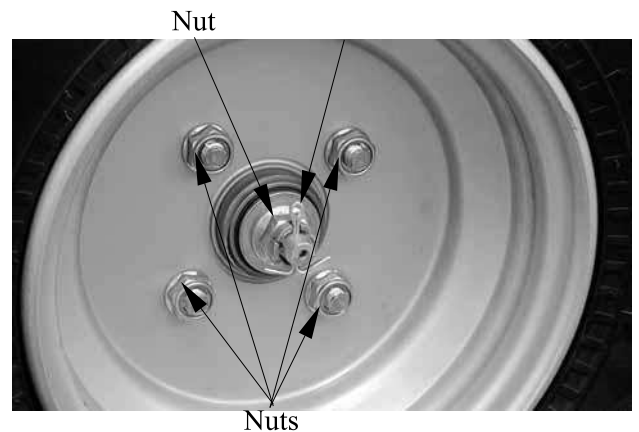

Remove the nut cap (MXU 50 REVERSE/MXU 50)

Remove the cotter pin.
 Remove nut attaching the wheel hub and washer.
 Remove the collar and wheel hub.

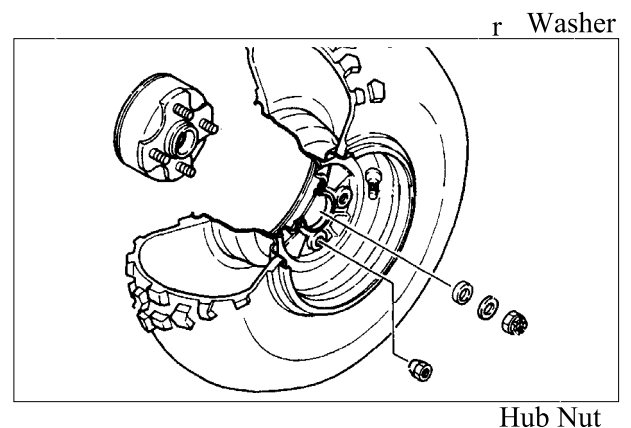

FRONT BRAKE DISASSEMBLY

Loosen the lock nut and tighten the adjuster nut at brake lever. (Refer to the "FRONT BRAKE ADJUSTMENT" section in the CHAPTER 3.).
 Disconnect the front brake cable from brake cam lever and remove the brake panel.
 Remove the brake shoes.

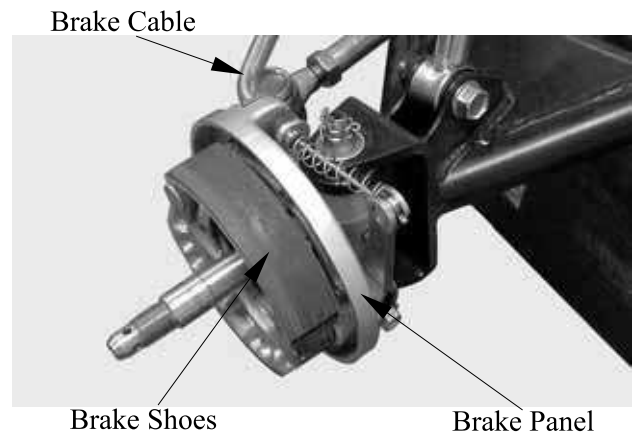

REMOVE

Remove brake shoes and springs.
 Remove the bolt attaching camshaft lever and remove camshaft lever.
 Remove the wear indicator, camshaft and O-rings

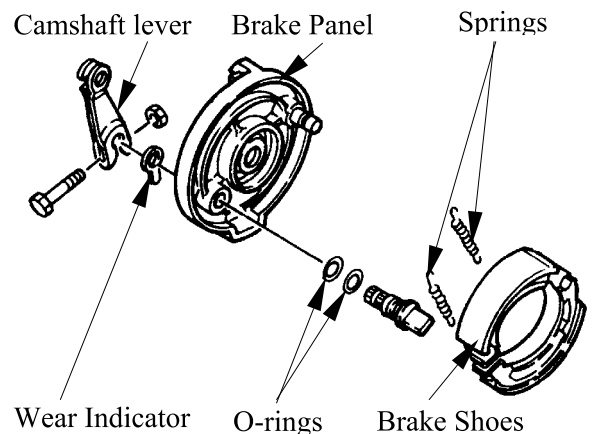

13. FRONT WHEEL/Front BRAKE/Front SUSPENSION/STEERING SYSTEM



ATV 50

Measure the wheel run out.
Replace wheel or check bearing play if out of specification

Rim run out limits:

Vertical: 2 mm (0.08 in)

Lateral: 2 mm (0.08 in)

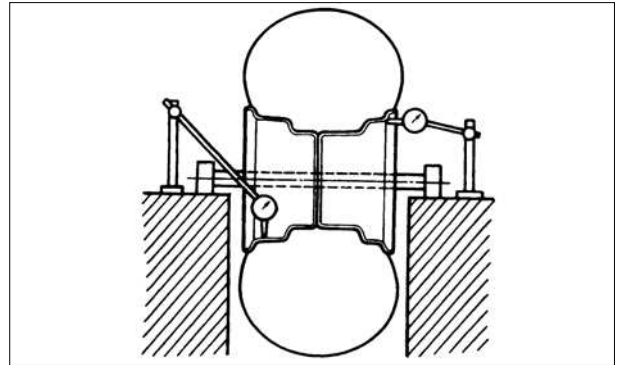

Inspect the front wheel hub.
Replace if cracks or damage.

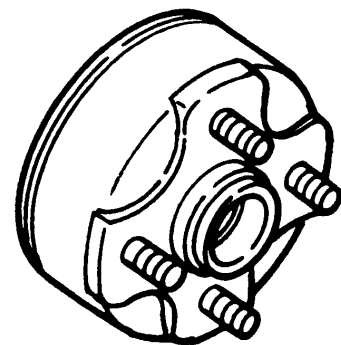

Inspect the front brake drum.
Measure the front brake drum I.D.
Service limits: 111 mm (4.44 in)

*

brake drum.

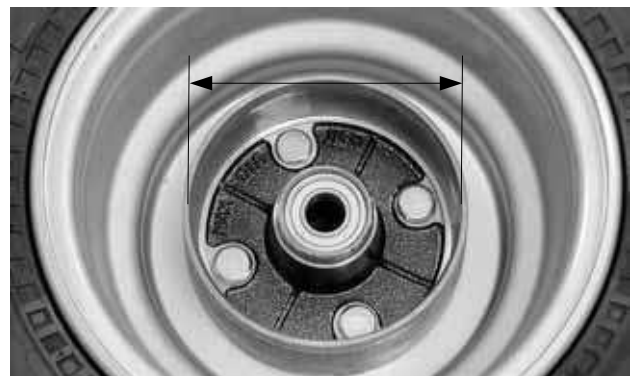

FRONT WHEEL BEARING

Remove the side collar.



13. FRONT WHEEL/FRONT BRAKE/FRONT SUSPENSION/STEERING SYSTEM

Remove the dust seal.

Turn the inner race of each bearing with your finger to see if they turn smoothly and quietly. Also check if the outer race fits tightly in the hub.



BEARING REPLACEMENT

Remove the front wheel bearings and distance collar.



Replace the bearings if the races do not turn smoothly, quietly, or if they fit loosely in the hub.

Apply grease to a new dust seal lip and install the dust seal.

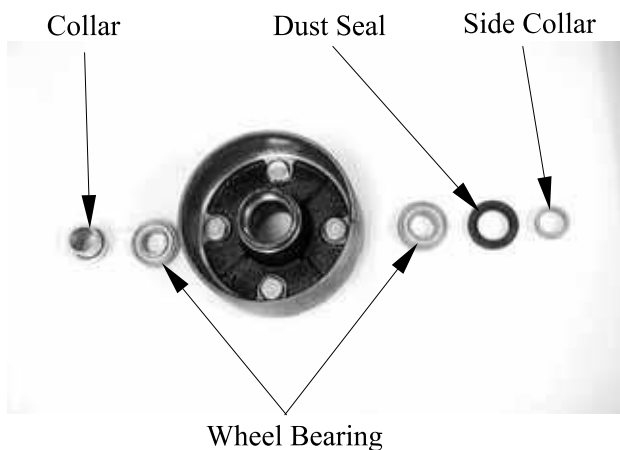

Pack all bearing cavities with grease.
Drive in the left bearing.
Install the distance collar.
Drive in the right bearing.

- *
 - Do not allow the bearings to tilt while driving them in.
 - Drive in the bearing squarely with the sealed end facing out.

Special tool:

Oil seal and bearing install A120E00014



Outer Driver

FRONT BRAKE

FRONT BRAKE LINING INSPECTION

Measure the front brake lining thickness.

Service limit: 2 mm (0.08 in) replace if below

* Keep oil or grease off the brake linings.



REMOVAL

Inspect the shoe springs, O-rings, camshaft lever and wear indicator.

Replace if damage.

Inspect the brake shoe plate.

Replace if cracks or damage.

Inspect the brake shoe pivot pin.

Replace if wear or damage.

Inspect the camshaft hole and camshaft.

Replace if scratches or excessive wear.

INSTALLATION

Reverse the "REMOVAL" procedures.

*

- Install the camshaft to the brake shoe plate with the slot of the camshaft placing at bass line of the wear indicator scale.
- Align the projection with the slot of the camshaft when installing the wear indicator to the camshaft.
- Align the cut-out of the camshaft lever with the slot of the camshaft when installing the camshaft lever to the camshaft.

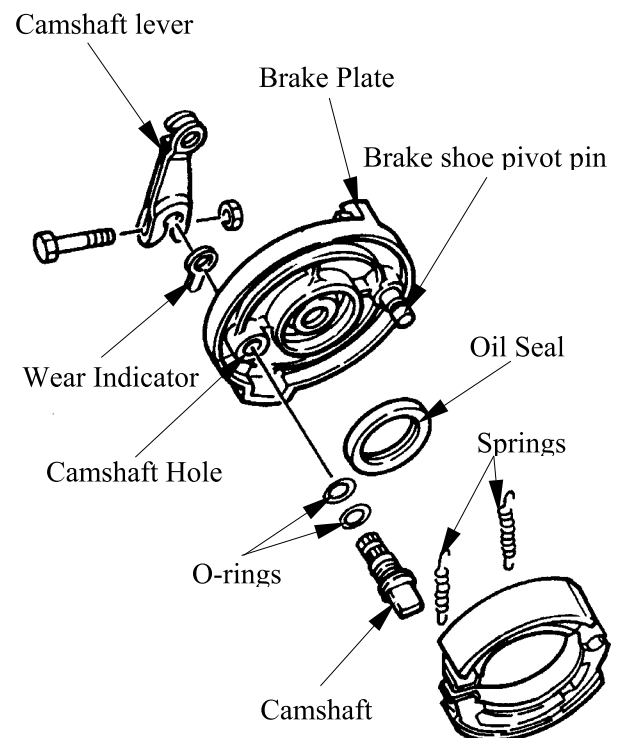

Tighten the bolt for camshaft lever.

Torque: 2.2 kgf-m (22 N-m, 16 lbf-ft)

*

camshaft.

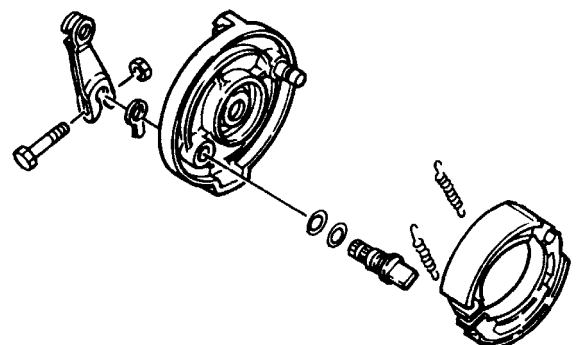

13. FRONT WHEEL/FRONT BRAKE/FRONT SUSPENSION/STEERING SYSTEM

Install the brake shoe plate.

*

on the brake shoe plate.

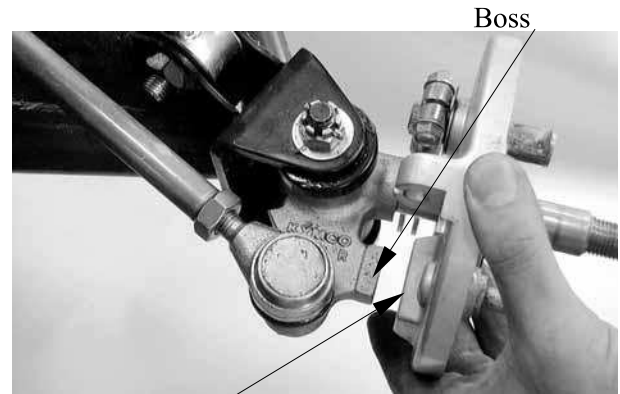

Locating Slot

Apply the grease onto the bearings and oil seal lips of the wheel hub.
Install wheel hub, plate washer and tight the nut (wheel hub).

Torque: 7 kgf-m (70 N-m, 50 lbf-ft)

Install cotter pins.

*

Always use a new cotter pin.

*

Do not loosen the axle nut after torque tightening. If the axle nut groove is not aligned with the cotter pin hole, align groove with the hole by tightening up on the axle nut.

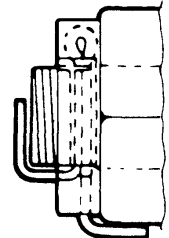
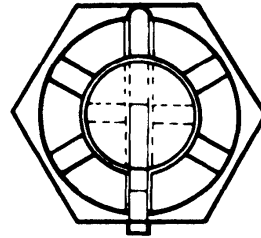

13. FRONT WHEEL/Front BRAKE/Front SUSPENSION/STEERING SYSTEM

Install the front wheel and tighten the nuts (wheel).

Torque: 4.5 kgf-m (45 N-m, 32 lbf-ft)



*

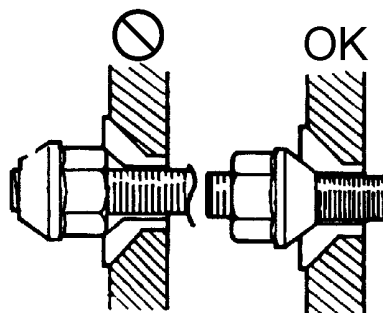

Adjust the front brake cable free play.

Refer to the “FRONT BRAKE
ADJUSTMENT” section in the
CHAPTER 3.

Brake lever free play:

10~20 mm (0.4~0.8 in) at lever end.

13. FRONT WHEEL/Front BRAKE/Front SUSPENSION/STEERING SYSTEM

FRONT SUSPENSION

REMOVAL

Elevate the front wheels by placing a suitable stand under the frame.

*

ger of it falling over.

Remove the front wheel, wheel hub, brake shoe plate.

Remove the upper and lower bolt, then remove the shock absorber.

Remove the cotter pin and nut, then remove tie-rod from steering knuckle.

Remove cotter pin, nut, washer and bolt, then remove the steering knuckle, covers, collar and bush from the front arm.

Upper Bolt



Lower Bolt

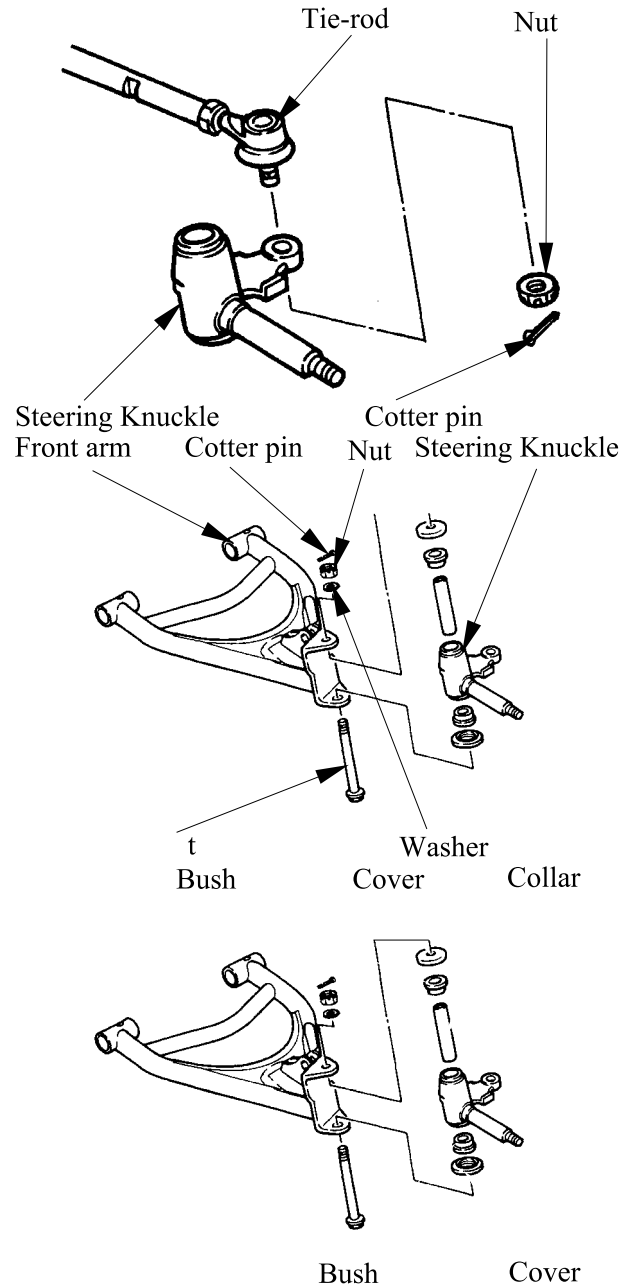

13. FRONT WHEEL/Front BRAKE/Front SUSPENSION/STEERING SYSTEM

INSPECTION

Check the front arm brackets of the frame.

If bent, cracked or damaged, repair or replace the frame.

Check the tightening torque of the front arms securing nuts.

Torque: 4.5 kgf-m (45 N-m, 32 lbf-ft)

Check the front arm side play by moving it from side to side.

If side play noticeable, replace the inner collar, bushings and thrust covers as a set.

Check the front arm vertical movement by moving it up and down.

If vertical movement is tight, binding or rough, replace the inner collar, bushings and thrust covers as a set.

Remove the two nut and two bolt attaching the front arm, then remove the front arm.

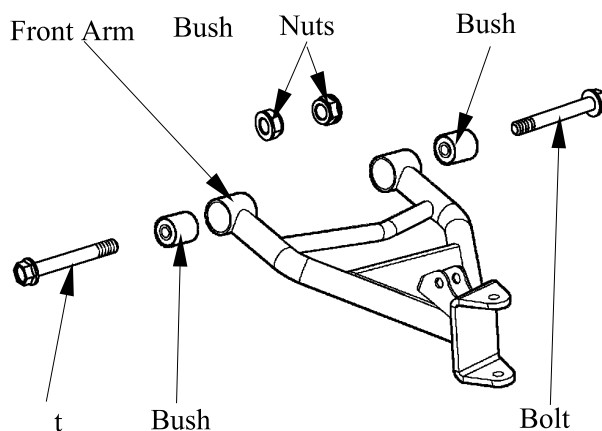
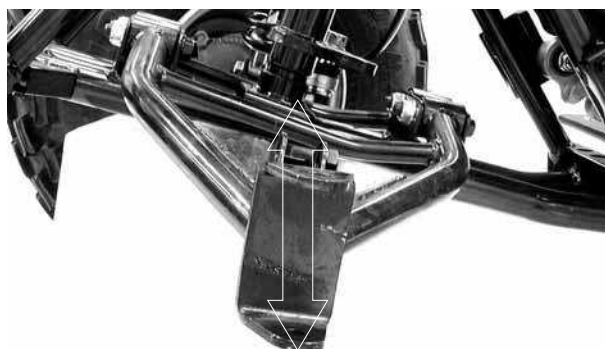
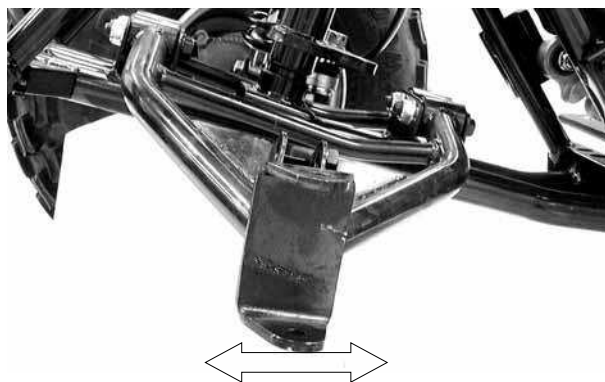

INSPECTION

Inspect the shock absorber rod.

Replace the shock absorber assembly if bends or damage.

Inspect the shock absorber.

Replace the shock absorber assembly if oil leaks.

Inspect the spring of the shock absorber by move the spring up and down.

Replace the shock absorber assembly if fatigue.

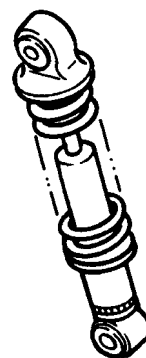

13. FRONT WHEEL/Front BRAKE/Front SUSPENSION/STEERING SYSTEM

Inspect the steering knuckle.
Replace if cracks, pitting or damage.

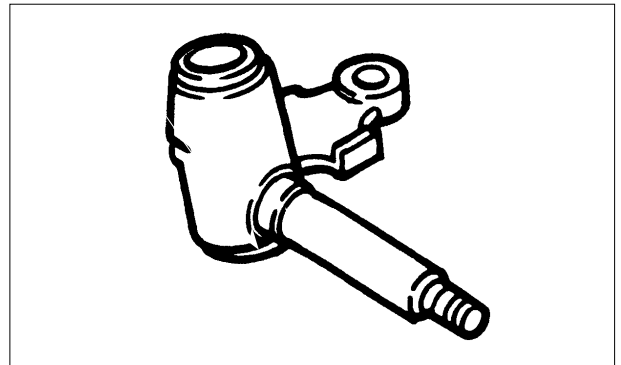

Inspect the front arm.
Replace if cracks, bends or damage.

* Do not attempt to straighten a bent arm, this may dangerously weaken the arm.

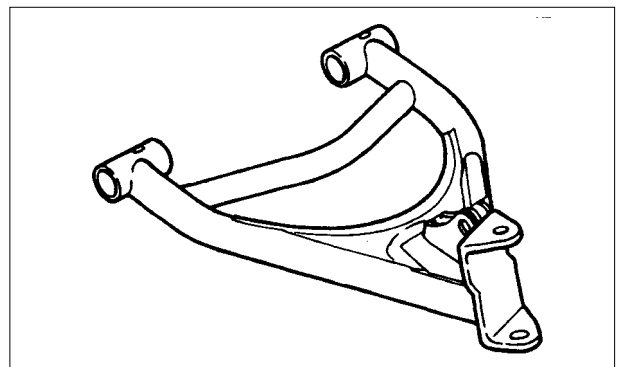

Inspect bushes.
Replace if wear or damage.

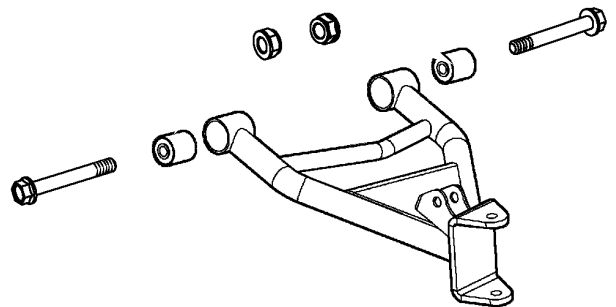

INSTALLATION

Reverse the "REMOVAL" procedures.

* Apply the grease onto the bushes, collars and covers.

Install the front arm nut onto the frame and tighten the nuts.

Torque: 4.5 kgf-m (45 N-m, 32 lbf-ft)

13. FRONT WHEEL/Front BRAKE/Front SUSPENSION/STEERING SYSTEM

Apply the grease onto the bush, collars and covers, then install the steering knuckle onto the front arm and tighten the nut.

Torque: 4.5 kgf-m (45 N-m, 32 lbf-ft)

Install the cotter pin and band ends of cotter pin.

*

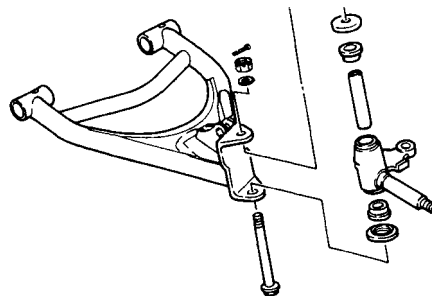

Install the tie-rod onto the steering knuckle and tighten the nut.

Torque: 3 kgf-m (30 N-m, 22 lbf-ft)

Install the cotter pin and band ends of cotter pin.

*

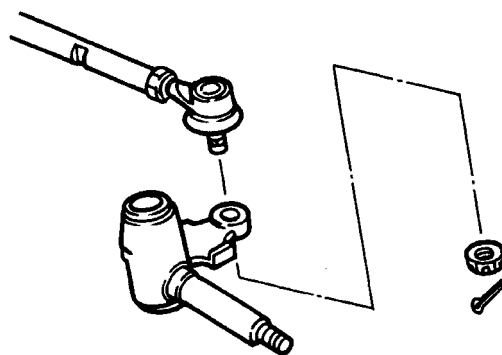

Install the shock absorber and tighten the upper and lower bolts.

Torque: 4 kgf-m (40 N-m, 29 lbf-ft)



Install the brake shoe plate, wheel hub and front wheel.

Refer to the “FRONT WHEEL INSTALLATION” section.

13. FRONT WHEEL/FRONT BRAKE/FRONT SUSPENSION/STEERING SYSTEM

STEERING SYSTEM

REMOVAL

Remove the following parts:

Seat, Front cover, Center cover and Front fender

Refer to the "FENDERS" section in the CHAPTER 2

Disconnect the main switch lead (MX'ER 50).

Remove the handlebar cover with main switch (MX'ER 50).

Disconnect the front brake cables from the brake lever.

Remove the rear brake cable from the brake lever and brake switch from the bracket of the brake lever (drum brake).

Remove the master cylinder (see page 14-20) (hydraulic brake).

*

Disconnect the brake switch from the bracket of the brake lever while pushing the hook of the brake switch with a driver.

Remove the two screws to remove the cover of the throttle housing.

Disconnect the throttle cable from the lever.

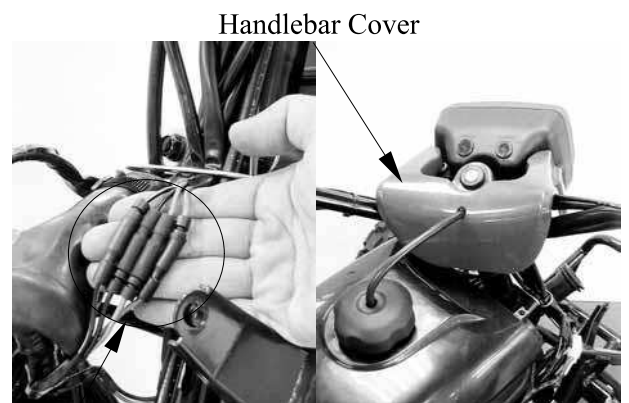

Handlebar Cover

Main Switch Lead

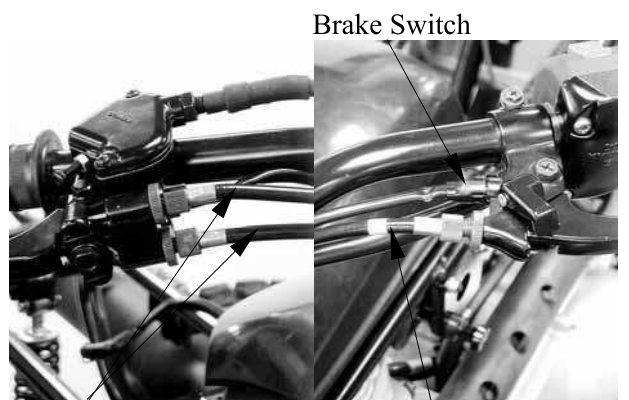

Brake Switch

Front Brake Cables

Rear Brake Cable



Hook

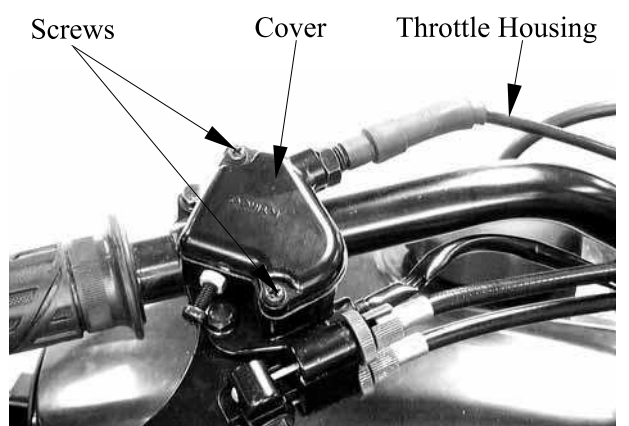

Screws

Cover

Throttle Housing

13. FRONT WHEEL/Front BRAKE/Front SUSPENSION/STEERING SYSTEM

Remove the two screws and remove the handlebar switch.

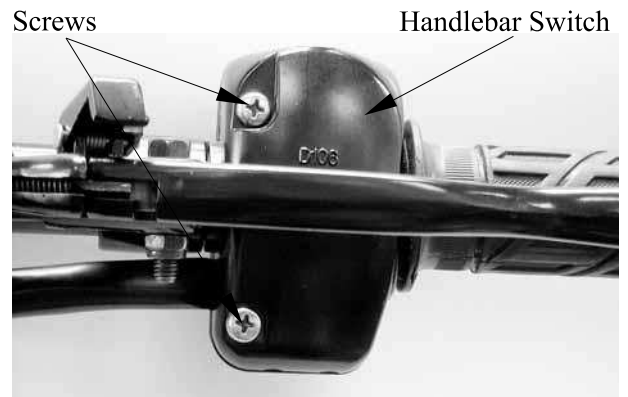

Remove the two bolts and remove headlight unit (MX'ER 50).
Remove the four handlebar holder bolts and remove the handlebar.

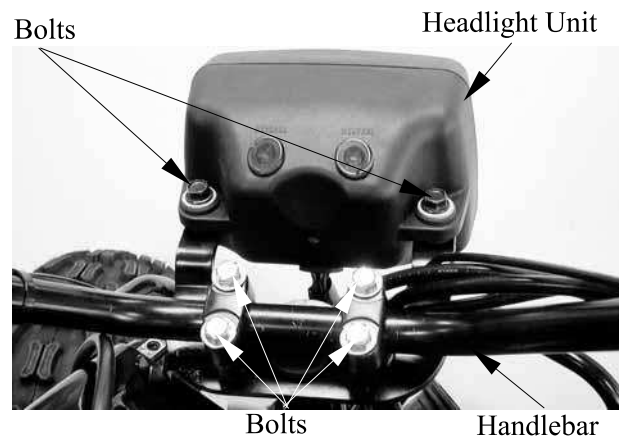

Remove the cotter pins and nuts attaching the tie-rods, then remove tie-rods.

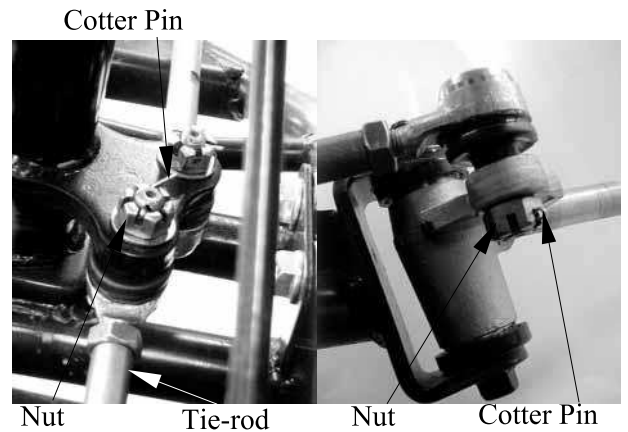

Remove the cotter pin and nut attaching the steering column, then remove steering column and collar.

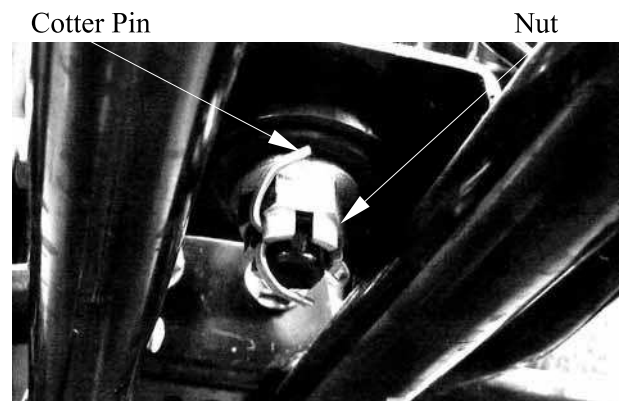

13. FRONT WHEEL/FRONT BRAKE/FRONT SUSPENSION/STEERING SYSTEM

Remove the two bolts to remove the cable holder, steering bracket, collars and steering column.

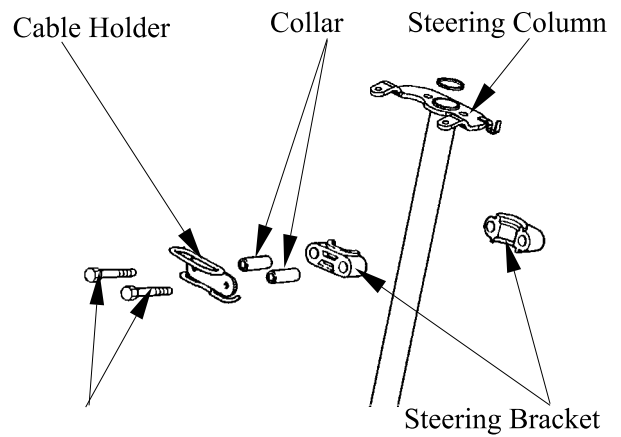

INSPECTION

Inspect the handlebar.
Replace if cracks, bends or damage.

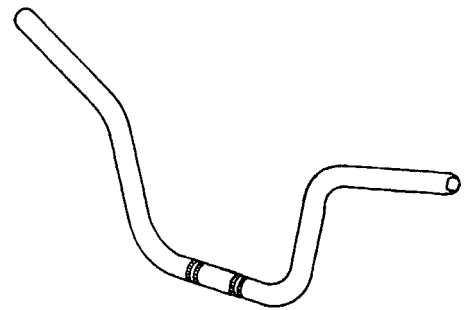

Inspect the steering column.
Replace if bends or damage.

*

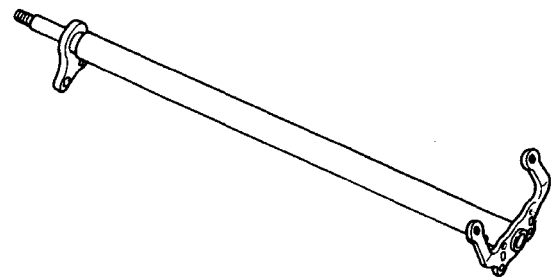

Inspect the steering brackets and oil seal.
Replace if wear or damage.

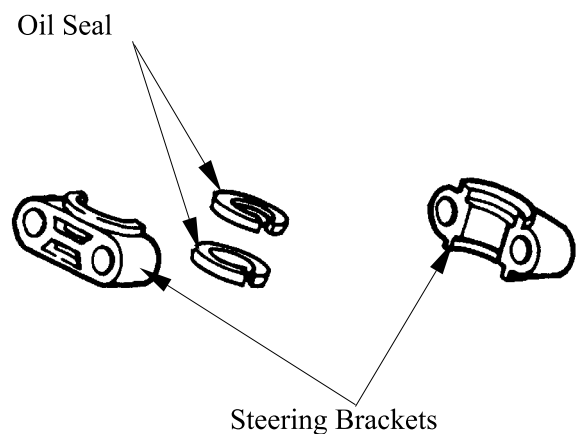

13. FRONT WHEEL/Front BRAKE/Front SUSPENSION/STEERING SYSTEM

Inspect the tie-rod.
Replace if bend or damage.

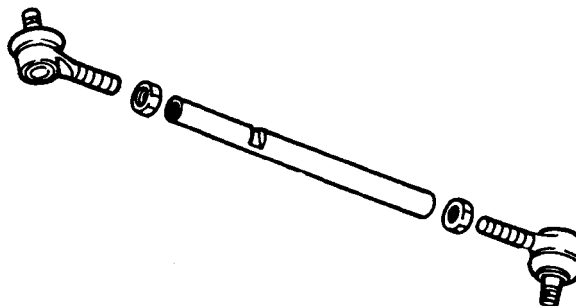

Check the tie-rod end movement.
Replace if the tie-rod end exists free play or turns roughly.
Check the tapered surface of the tie-rod end.
Replace if pitting, wear or damage.

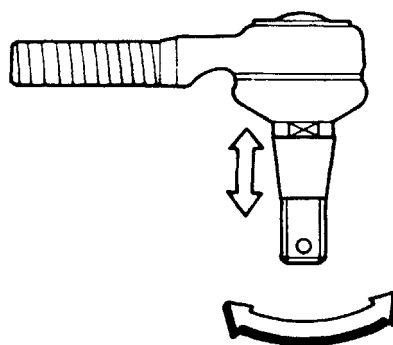

Adjust the tie-rod length.
Adjustment steps:
(The following procedures are done on both tie-rods, right and left.)
Loosen the lock nuts.
Adjust the tie-rod length by tuning both tie-rod ends.

Tie rod length: 266.5 mm (10.66 in)

Set the rod-end (steering column side) in an angle where the indentation surface of the tie-rod is parallel to the rod-end shaft, and then tighten the lock nut.

Torque: 3 kgf-m (30 N-m, 22 lbf-ft)

Set the other rod-end (knuckle arm side) in an angle as shown (right-hand tie-rod and left-hand tie-rod), and then tighten the lock nut.

Rod-end (tie rod) angle: 180°

Torque: 3 kgf-m (30 N-m, 22 lbf-ft)

* After making adjustment on both tie rods be sure to mark them R and L for identification.

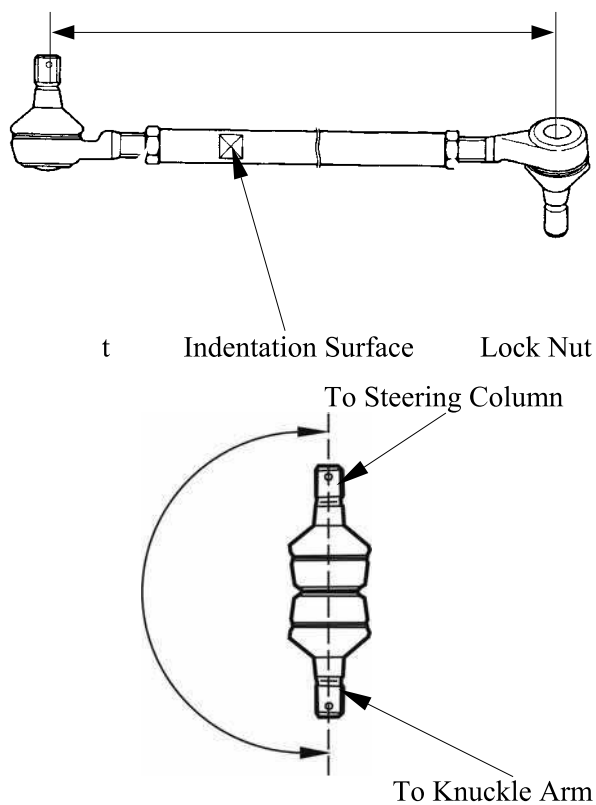

13. FRONT WHEEL/Front BRAKE/Front SUSPENSION/STEERING SYSTEM

*

gth.

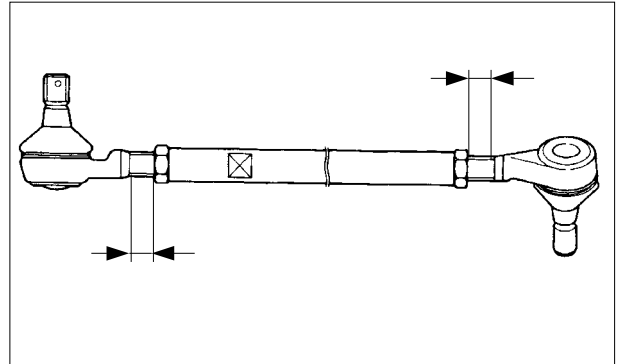

Inspect the collar, duty seal, snap ring and bearing.
Replace if wear or damage.

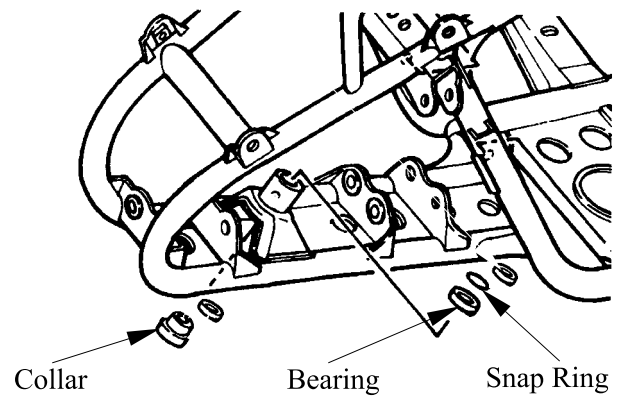

INSTALLATION

Reverse the "REMOVAL" procedures.

*

Apply the grease onto the collar, duty seal, and bearing.

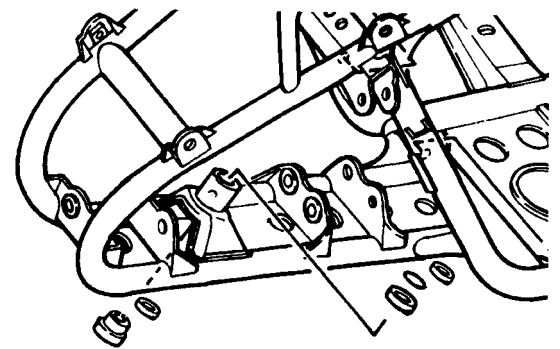

Assembly the steering column and tighten the two bolts.

Torque: 2.2 kgf-m (22 N-m, 15.8 lbf-ft)

Band the lock washer tabs.

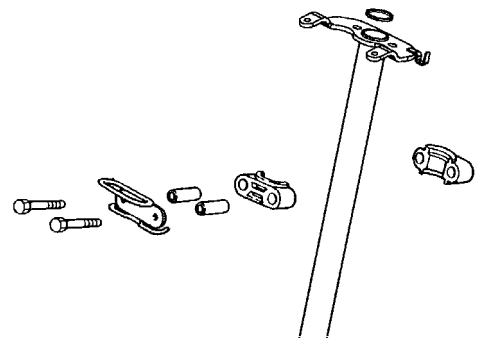

13. FRONT WHEEL/Front BRAKE/Front SUSPENSION/STEERING SYSTEM

Install the steering column and collar, then tighten the nut.
Torque: 7 kgf-m (70 N-m, 50 lbf-ft)
 Install the cotter pin and band ends of cotter pin.

* Always use a new cotter pin.

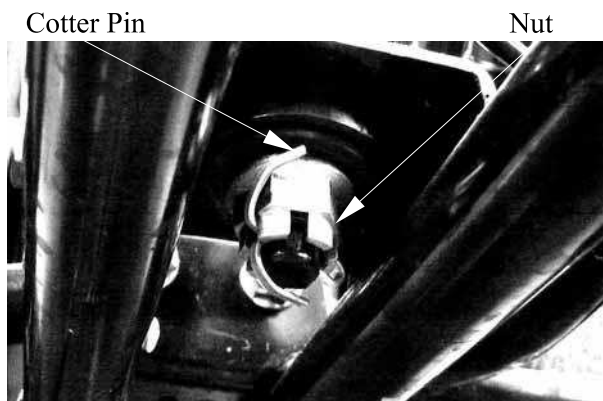

Install the tie rods and tighten the nut.
Torque: 4.5 kgf-m (45 N-m, 32 lbf-ft)
 Install the cotter pin and band ends of cotter pin.

* Always use a new cotter pin.

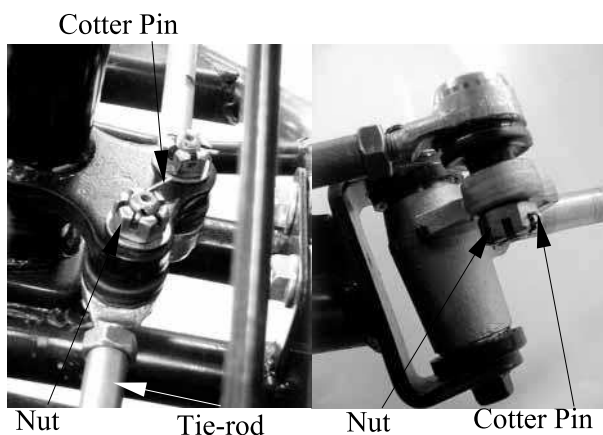

*

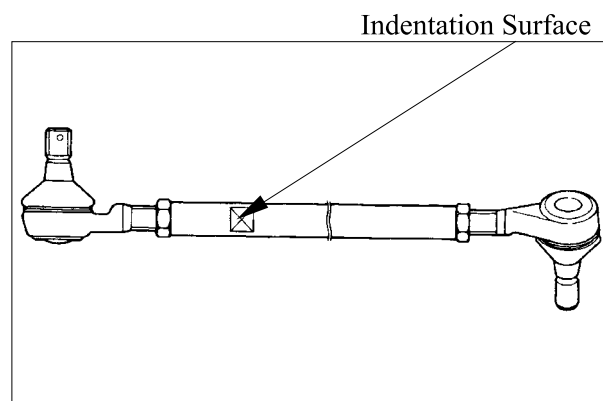

Install handlebar and handlebar holder, then tighten the four bolts.
Torque: 2.2 kgf-m (22 N-m, 15.8 lbf-ft)

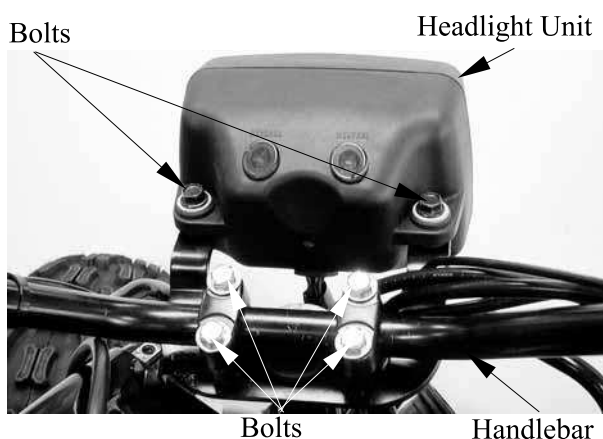

*

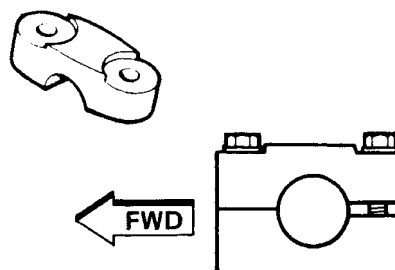

Apply the grease onto the end of the throttle cable and end of the brake cable.

Refer to the “TOE-IN ADJUSTMENT” section in the CHAPTER 3 to adjust toe-in.

Refer to the “FRONT BRAKE ADJUSTMENT” section in the CHAPTER 3 to adjust front brake.

Refer to the “REAR BRAKE ADJUSTMENT” section in the CHAPTER 3 to adjust rear brake.

**REAR WHEEL/SWING ARM/
HYDRAULIC BRAKE**

SERVICE INFORMATION-----	14- 2
TROUBLESHOOTING-----	14- 3
REAR WHEEL-----	14- 4
SWING ARM -----	14-14
HYDRAULIC BRAKE -----	14-18

14. REAR WHEEL/SWING ARM/ HYDRAULIC BRAKE

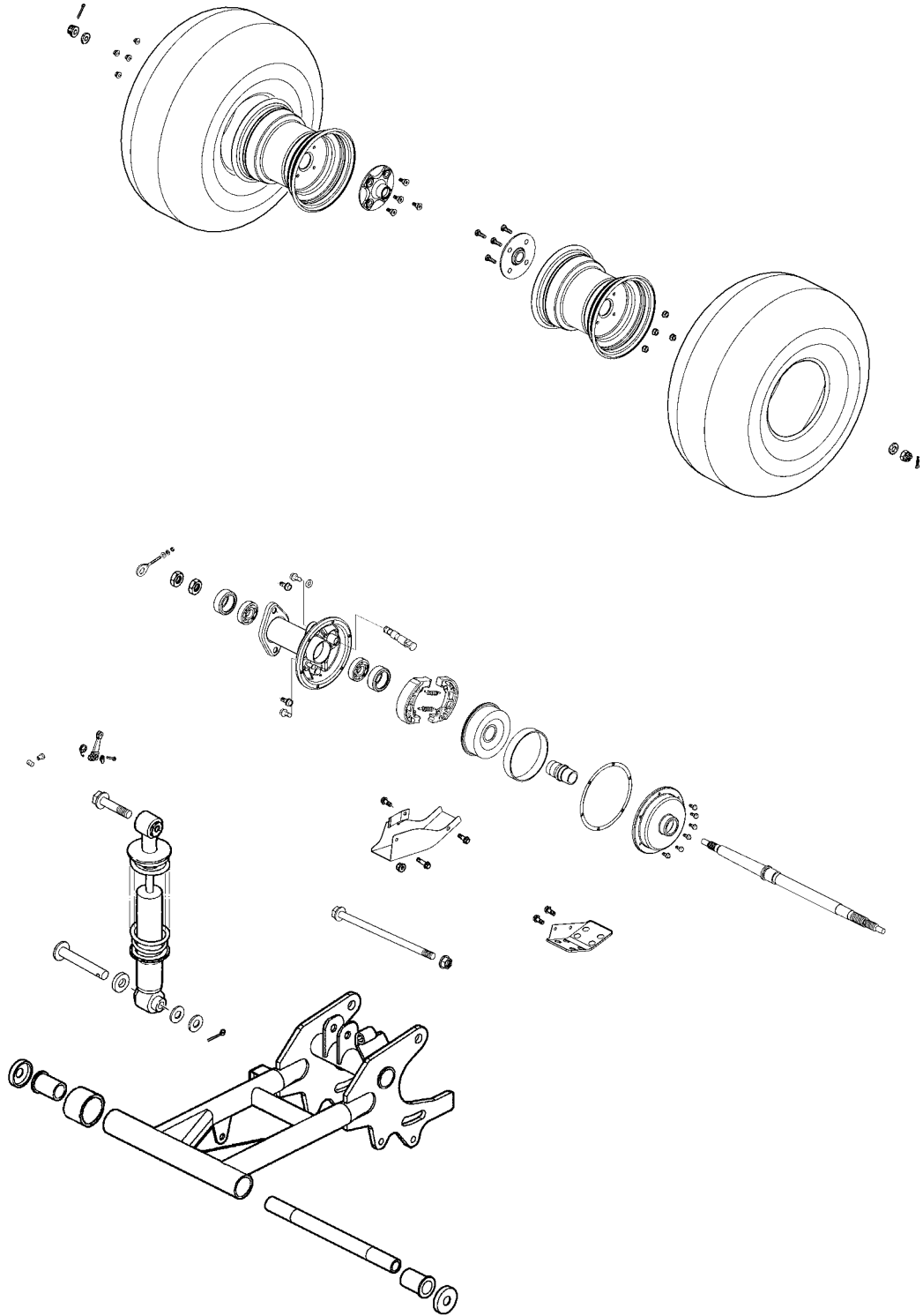

SERVICE INFORMATION

GENERAL INSTRUCTIONS

- During servicing, keep oil or grease off the brake drum and brake linings.
- Drain the brake fluid from the hydraulic brake system before disassembly.
- Contaminated brake disk or brake pads reduce stopping power. Clean the contaminated brake disk with high-performance brake degreaser and replace the brake pads.
- Do not use brake fluid for cleaning.
- Bleed air from the brake system if the brake system is removed or the brake is soft.
- Do not allow any foreign matters entering the brake reservoir when filling the brake reservoir with brake fluid.
- Brake fluid will damage painted, coated surfaces and plastic parts. When working with brake fluid, use shop towels to cover and protect painted, rubber and plastic parts. Wipe off any splash of brake fluid with a clean towel. Do not wipe the motorcycle with a towel contaminated by brake fluid.
- Make sure to use recommended brake fluid. Use of other unspecified brake fluids may cause brake failure.
- Inspect the brake operation before riding.

SPECIFICATIONS

mm (in)

Item		Standard	Service Limit
Rear wheel	Rim run out	Radial	— 2 (0.08)
		Axial	— 2 (0.08)
	Rear brake drum I.D		130 (5.2)
Rear brake lining thickness		4.5 (0.18)	2 (0.08)

mm (in)

Item	Standard Limit	Service Limit
Brake disk thickness	3.7 (0.148)	3 (0.03)
Brake disk runout	0.15 (0.006)	0.3 (0.003)
Brake master cylinder I.D.	12.7 (0.508)~12.743 (0.5097)	12.75 (0.51)
Brake master cylinder piston	12.657 (0.5063)~12.684 (0.5074)	12.64 (0.5056)
Brake caliper piston I.D.	33.95 (1.358)~33.99 (1.3596)	34.05 (1.362)
Brake caliper cylinder O.D.	33.88 (1.3552)~33.92 (1.3568)	33.85 (1.354)

TORQUE VALUES

Rear wheel nut	4.5 kgf-m (45 N-m, 32 lbf-ft)
Rear shock absorber upper/lower mount bolt	4 kgf-m (40 N-m, 29 lbf-ft)
Rear swing arm axle	7 kgf-m (70 N-m, 50 lbf-ft)
Rear wheel hub nut	7 kgf-m (70 N-m, 50 lbf-ft)
Rear wheel shaft nut	12 kgf-m (120 N-m, 86 lbf-ft)
Brake arm bolt	2.2 kgf-m (22 N-m, 16 lbf-ft)
Caliper holder bolt	2.7 kgf-m (27 N-m, 19 lbf-ft)
Brake fluid tube bolt	3 kgf-m (30 N-m, 22 lbf-ft)
Caliper bleed valve	0.6 kgf-m (6 N-m, 4 lbf-ft)
Master cylinder bolt	1.2 kgf-m (12 N-m, 9 lbf-ft)

SPECIAL TOOLS

Nut wrench A120F00010

TROUBLESHOOTING

Rear wheel wobbling

- Bent rim
- Faulty tire
- Axle not tightened properly

Soft rear shock absorber

- Weak shock absorber spring
- Faulty damper

Loose brake lever

- Air in hydraulic brake system
- Brake fluid level too low
- Hydraulic brake system leakage

Hard braking

- Seized hydraulic brake system
- Seized piston

Brake noise

- Contaminated brake pad surface
- Excessive brake disk run out
- Incorrectly installed caliper
- Brake disk or wheel not aligned

Poor brake performance (Disk Brake)

- Air in brake system
- Deteriorated brake fluid
- Contaminated brake pads and brake disk
- Worn brake pads
- Worn brake master cylinder piston oil seal
- Clogged brake fluid line
- Deformed brake disk
- Unevenly worn brake caliper

Poor brake performance

- Brake not adjusted properly
- Worn brake linings
- Worn brake shoes at cam contacting area
- Worn brake cam
- Worn brake drum

Tight brake lever

- Seized piston
- Clogged hydraulic brake system
- Smooth or worn brake pad

Poor brake performance

Contaminated brake pad surface

14. REAR WHEEL/SWING ARM/ HYDRAULIC BRAKE

REAR WHEEL

REMOVAL

Place the machine on a level place.
Use the nut wrench to loosen two nuts
(inner and outer) of the rear axle.

Special tool

Nut wrench A120F00010

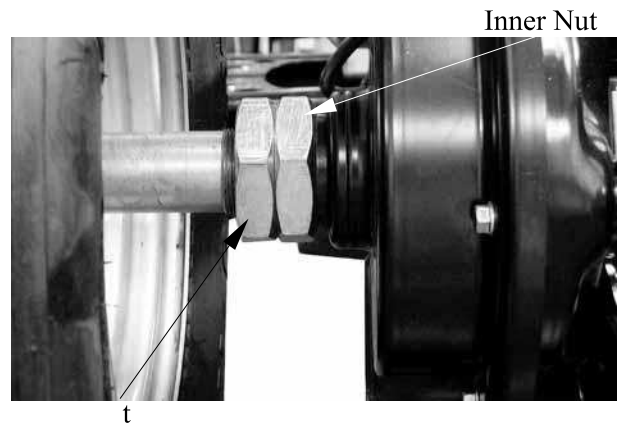

Remove the cotter pin.

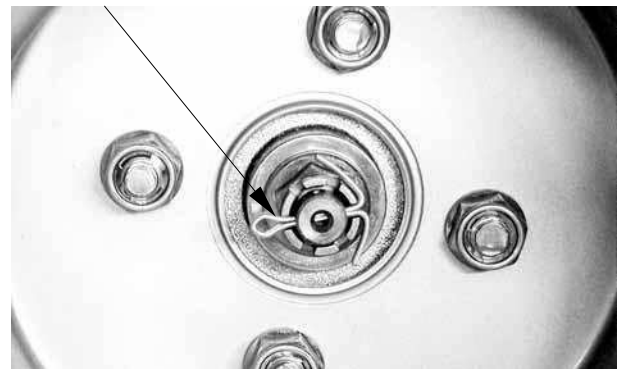

Remove four nuts attaching the wheel panel
of the both rear wheels.
Loosen nut attaching the wheel hub of the
both rear wheels.

* Elevate the rear wheels by placing a
suitable stand under the rear of frame.
Support the machine securely so there is
no danger of it falling over.

Nut Attaching The Wheel Hub

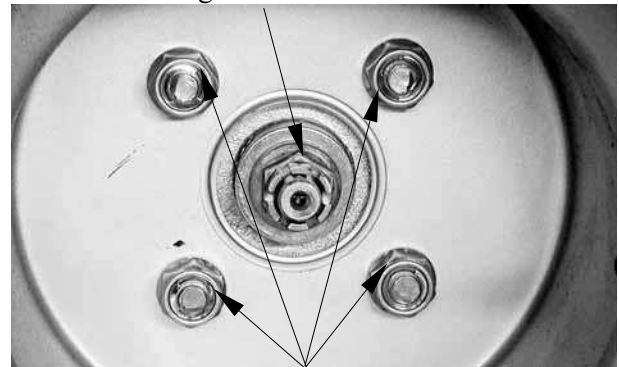

Nuts Attaching The Wheel Panel

Remove

Remove four nuts attaching the wheel panel
and rear wheel.
Remove nut attaching the wheel hub and
washer.
Remove the wheel hub.

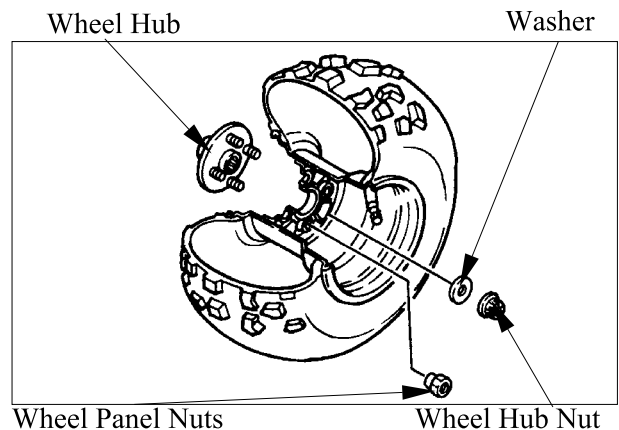

14. REAR WHEEL/SWING ARM/ HYDRAULIC BRAKE

Inspection

Measure the wheel runout.

Service Limit:

Vertical: 2 mm (0.08 in)

Lateral: 2 mm (0.08 in)

Replace wheel or check bearing play if out of specification.

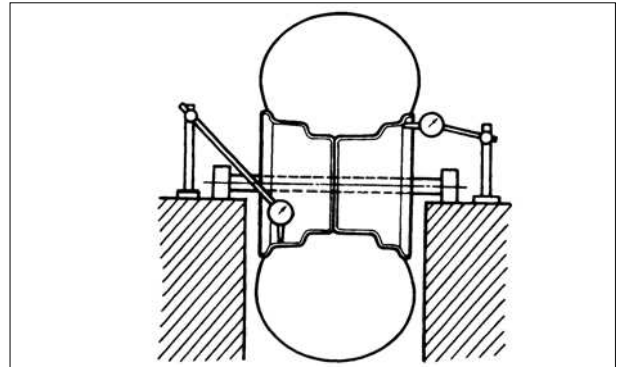

Remove two nuts of the rear axle (outer and inner).

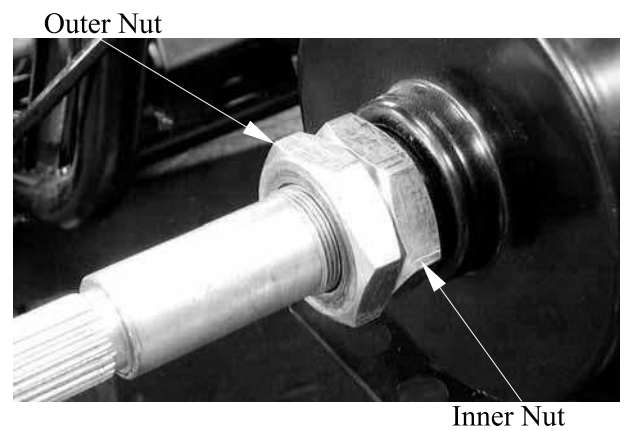

Remove five bolts attaching left and right lower guard.

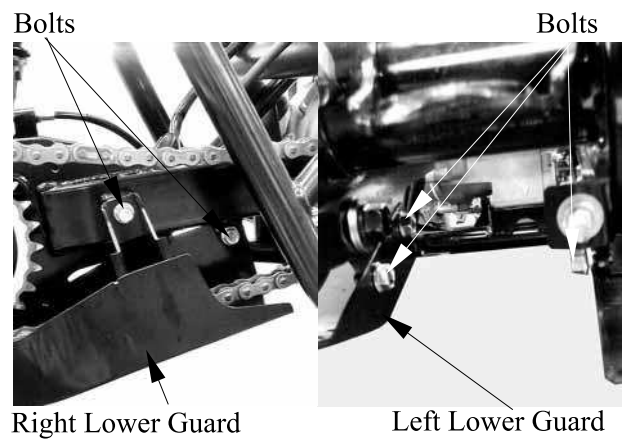

Loosen the lock nut for the adjuster of the drive chain slack.

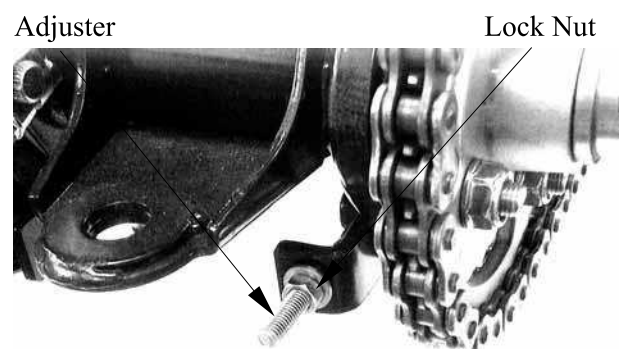

14. REAR WHEEL/SWING ARM/ HYDRAULIC BRAKE

Loosen four bolts attaching rear axle hub.

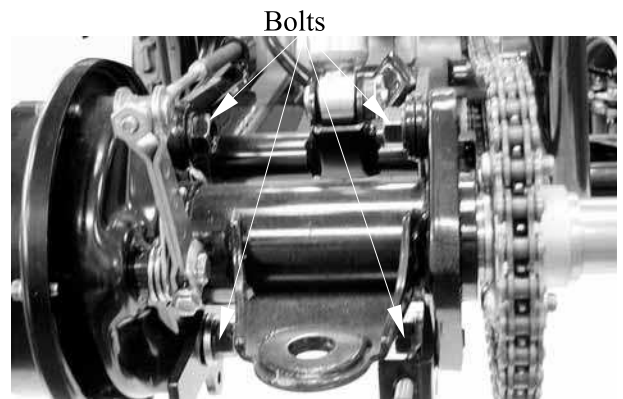

Remove the drive chain from driven sprocket.



Remove six bolts attaching brake drum cover.

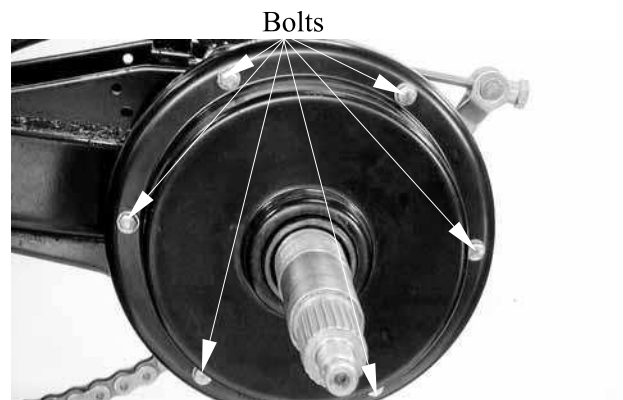

Remove brake drum cover and rubber spacer.

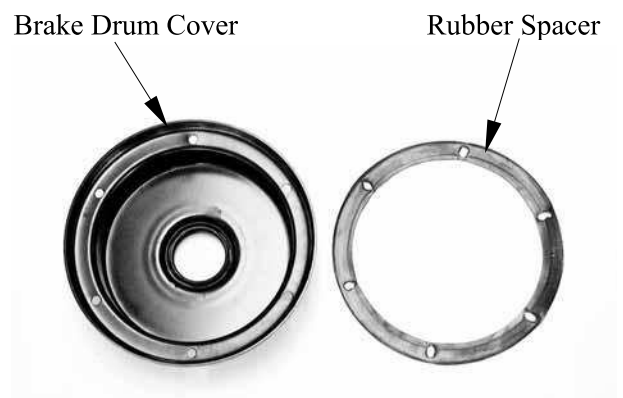

14. REAR WHEEL/SWING ARM/ HYDRAULIC BRAKE

Inspection

Inspect the inner surface of the brake drum is scratches, polish brake drum lightly and evenly with emery cloth.

Measure the inside diameter of the brake drum.

Service limit: 131 mm (5.24 in)

Replace if it is out of specification.



Disconnect the rear brake cable from the camshaft lever.

Brake Cable



Remove the brake shoes.

INSPECTION

Measure lining thickness of the brake shoes.

Service limit: 2 mm (0.08 in)

Replace if it is out of specification.

Brake Shoes



Remove the rear axle from left side.

* Tap the axle and with a rubber hammer, this will avoid damage the axle thread.

Rear Axle



14. REAR WHEEL/SWING ARM/ HYDRAULIC BRAKE

Remove four bolts and the rear axle hub.

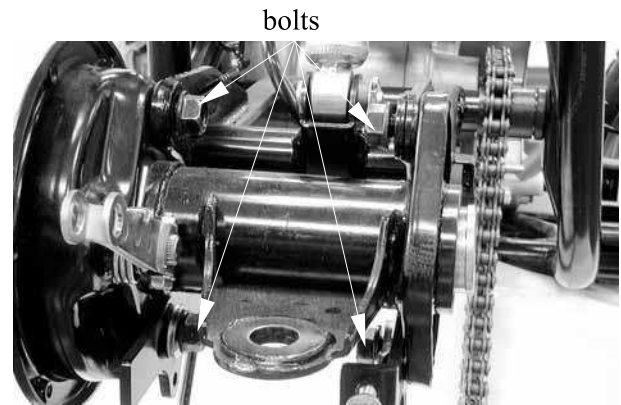

INSPECTION

Replace if the wheel hub is cracked or damaged.

Replace if splines of the wheel hub is wear or damaged.



Replace if the rear axle is scratched (excessively) or damaged.

Replace if splines and threads of the rear axle is wear or damaged.

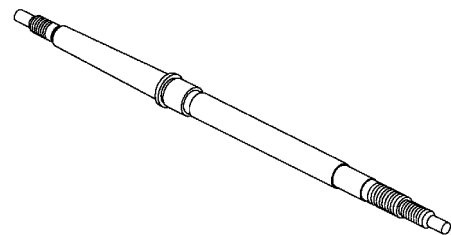

Measure the rear axle run out.

Service limit: less than 1.5 mm (0.06 in)

Replace if it is out of specification.

* Do not attempt to straighten a bent axle.



14. REAR WHEEL/SWING ARM/ HYDRAULIC BRAKE

DRIVE CHAIN INSPECTION

Remove rear wheels, rear hub (with rear axle) and swing arm.

Refer to the “REAR WHEEL — REMOVAL” and “SWING ARM REMOVAL” section.

Remove right foot board.

Remove the drive sprocket.

Remove the drive chain.

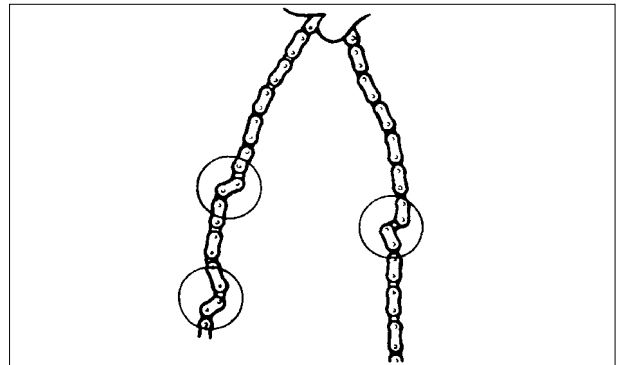

Inspect the drive chain stiffness.
Clean and lubricate or replace if stiff.

Inspect the drive sprocket and the driven sprocket.

Replace sprocket if more than 1/4 teeth wear or bent teeth.

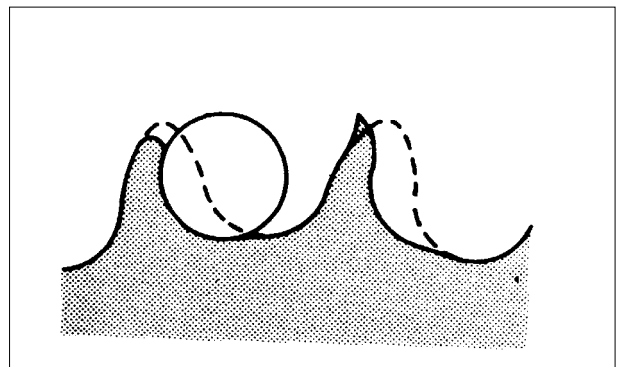

CLEAN

Place it in kerosene, and brush off as much dirt as possible. Then remove the chain from the kerosene and dry the chain.

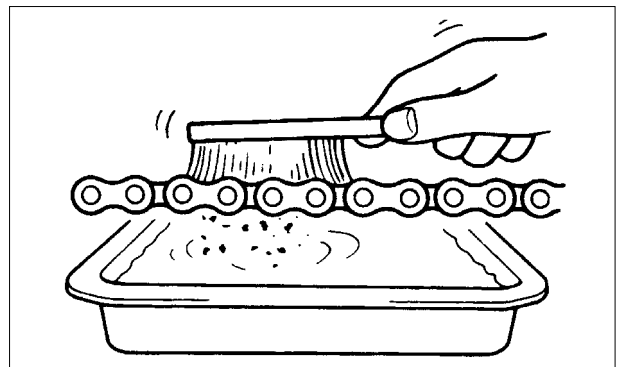

*

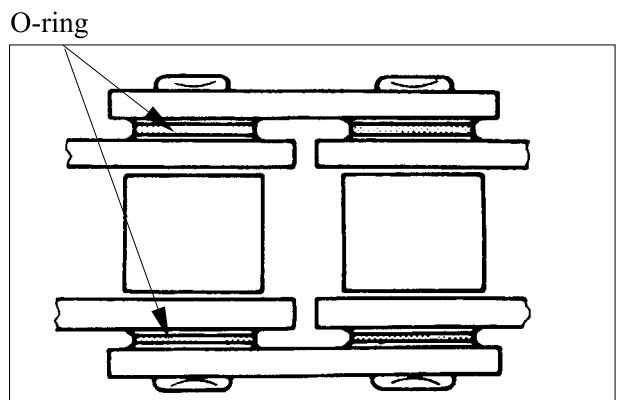

14. REAR WHEEL/SWING ARM/ HYDRAULIC BRAKE

Inspect rear axle hub.

Replace if bearings allow play in the axle hub or the bearing turns roughly.

Replace if oil seals is wear or damage.

Replace if rear axle hub is cracks, bend or damage.

Bearing and oil seal replacement steps:

Clean the outside of the rear axle.

Remove the oil seal by a flat-head screw driver.

- *

Place a wood block against the outer edge to protect this edge.

Remove the bearing by a general bearing puller.

Install the new bearings and oils seal by reversing the previous steps.

- *

Do not strike the center race or balls of the bearing.
Contact should be made only with the outer race.

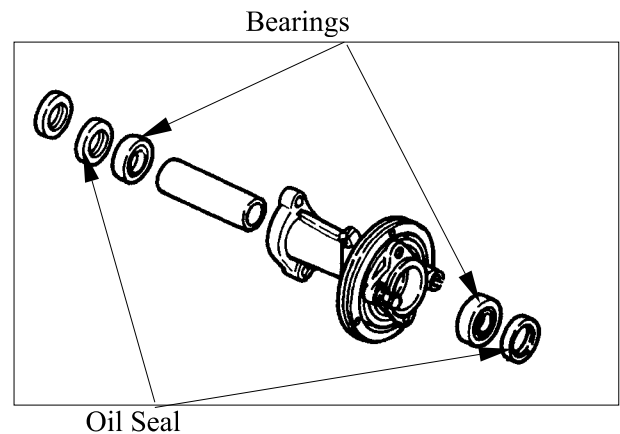

INSTALLATION

Reverse the “REMOVAL” procedures.

- *

Apply grease onto the oil seal lips, bearings and bushes.

Install the rear axle hub.

- *

At this time, the rear axle hub should not be tightened completely.
Final tightening is done after the chain slack adjustment.

Install the rear axle.

- *

Tap the axle and with a rubber hammer, this will avoid damage the axle thread.

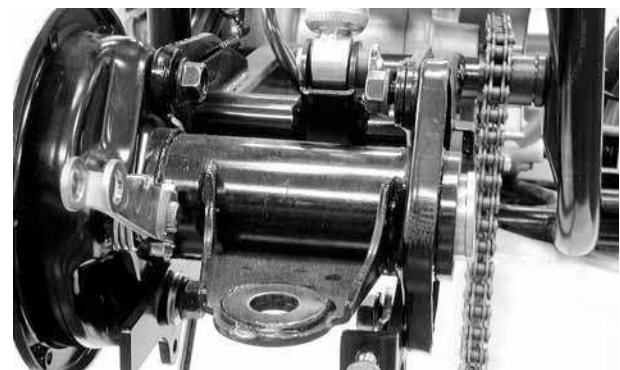

14. REAR WHEEL/SWING ARM/ HYDRAULIC BRAKE

Install the brake drum.
Install the rubber spacer and brake drum cover.
Torque: 1 kgf-m (10 N-m, 7.2 lbf-ft)

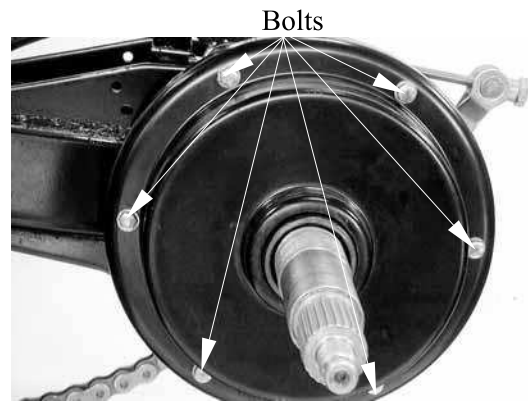

Adjust drive chain slack (see chapter 3).
Drive chain slack: 10-20 mm (0.4 – 0.8 in)



Tighten the bolts.
Torque: 7 kgf-m (70 N-m, 50 lbf-ft)
Torque: 7 kgf-m (70 N-m, 50 lbf-ft)

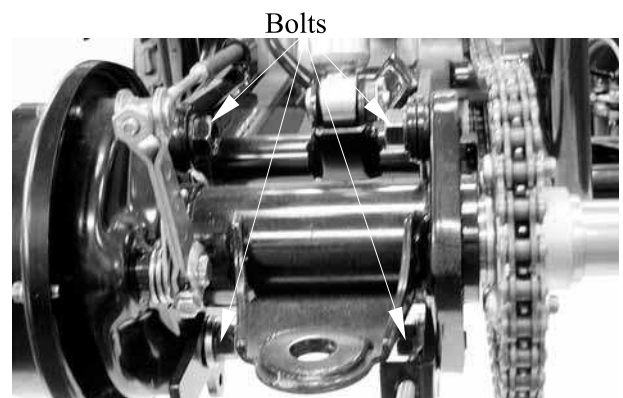

Tighten the lock nut.
Torque: 2.2 kgf-m (22 N-m, 16 lbf-ft)

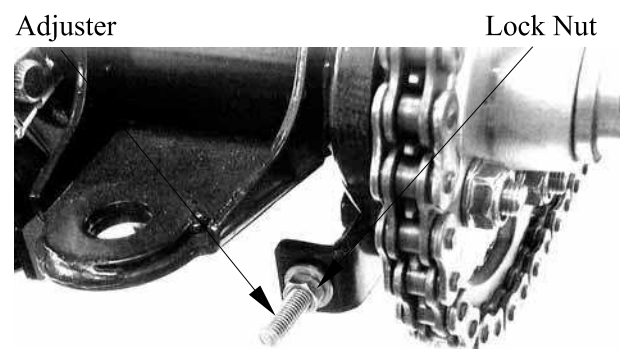

14. REAR WHEEL/SWING ARM/ HYDRAULIC BRAKE

Tighten the two nuts with the nut wrench.

Special tool

Nut wrench A120F00010

Torque: 12 kgf-m (120 N-m, 86 lbf-ft)

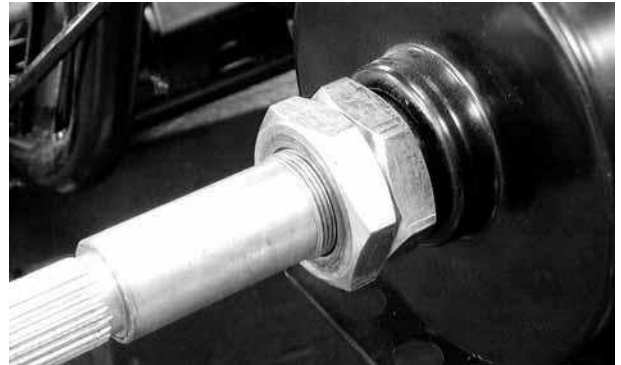

Install wheel hub, plate washer and nut (wheel hub).

Torque: 7 kgf-m (70 N-m, 50 lbf-ft)

Install cotter pins.

* Always use a new cotter pin.

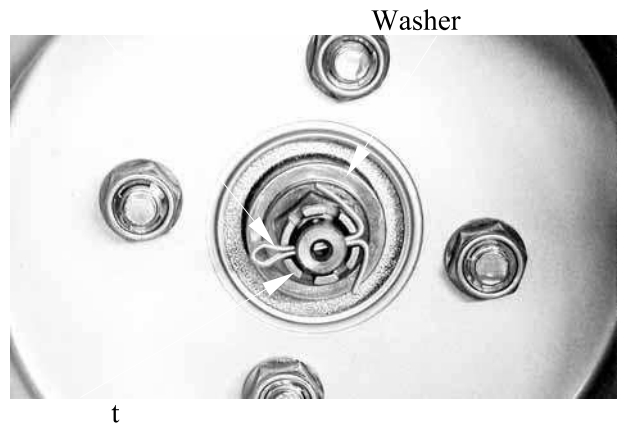

* Do not loosen the axle nut after torque tightening. If the axle nut groove is not aligned with the cotter pin hole, align groove with the hole by tightening it on the axle nut.

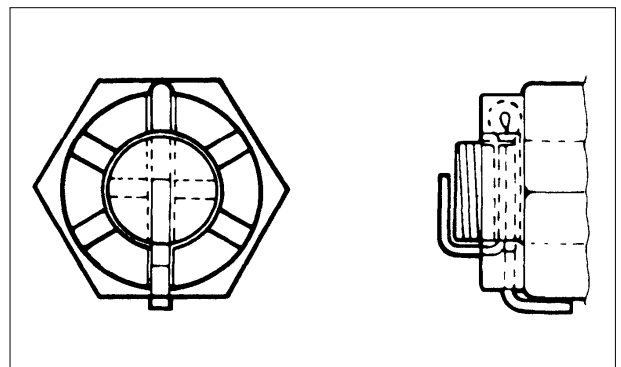

14. REAR WHEEL/SWING ARM/ HYDRAULIC BRAKE

Install the rear wheel and tighten the nuts (wheel).

Torque: 4.5 kgf-m (45 N-m, 32 lbf-ft)

* Tapered wheel nuts are used for rear wheels.
Install the nuts with its tapered side towards the wheel.

Nut Attaching The Wheel Hub

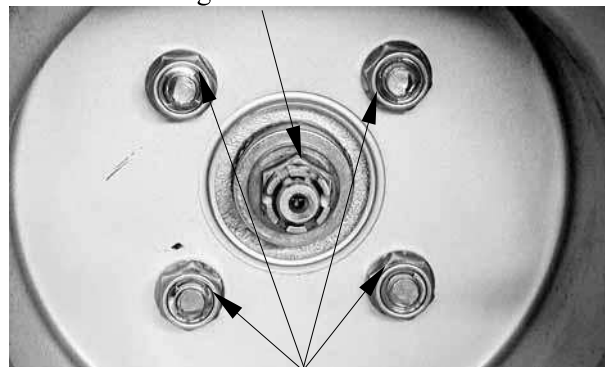

Nuts Attaching The Wheel Panel

*

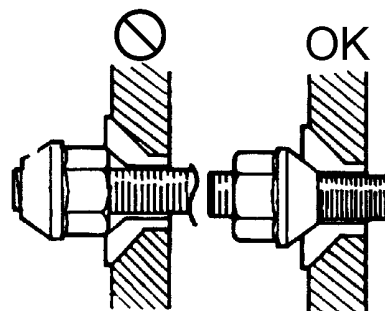

14. REAR WHEEL/SWING ARM/ HYDRAULIC BRAKE

SWING ARM

Place the machine on a level place.

Elevate the rear wheels by placing a suitable stand under the rear of frame.

* Support the machine securely so there is no danger of it falling over.

Remove the rear wheels, rear hub with rear axle.

Refer to the “REAR WHEEL – REMOVAL” section

Remove the cotter pin, washer and shaft (MX’ER 50).

Remove the lower mounting bolt/nut (MXU 50 REVERSE/MXU 50).

* When removing the lower shaft, hold the swing arm so that it does not drop downwards when the shaft is removed.

Remove the upper mounting bolt/nut, then remove the shock absorber.

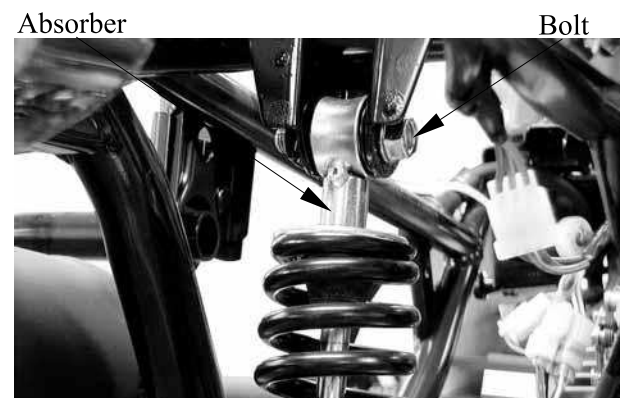
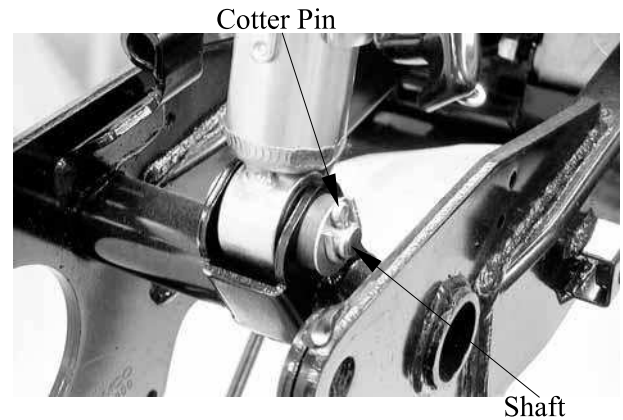

Check the tightening torque of the pivot shaft (swingarm) securing nut.

Torque: 7 kgf-m (70 N-m, 50 lbf-ft)



14. REAR WHEEL/SWING ARM/ HYDRAULIC BRAKE

Check the swing arm side play by moving it from side to side.

If side play noticeable, check the inner collar, bearing, bushing and thrust cover, or adjust the shim.

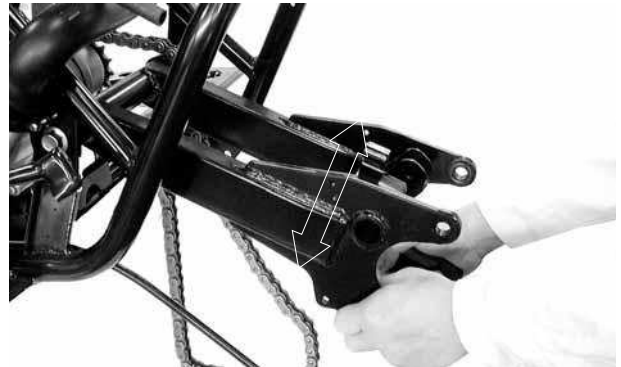

Check the swing arm vertical movement by moving it up and down.

If vertical movement is tight, binding or rough, check the inner collar, bearing, bushing and thrust cover, or adjust the shim.

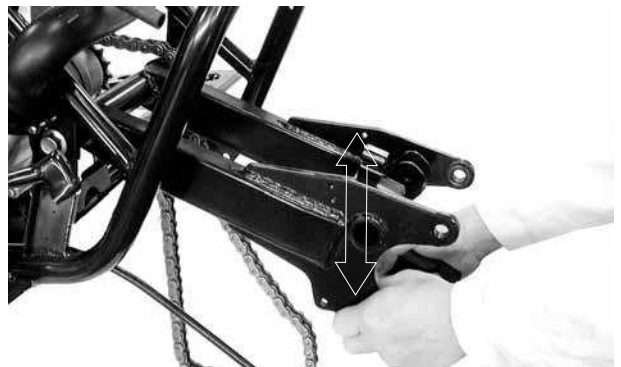

Remove the nut and pivot shaft, then remove swing arm.



Swing arm

Remove the thrust covers.

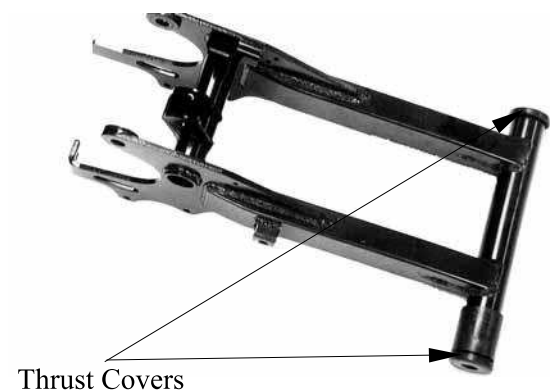

Thrust Covers

14. REAR WHEEL/SWING ARM/ HYDRAULIC BRAKE

INSPECTION

- Inspect the shock absorber rod.
- Replace the shock absorber assembly if bends or damage.
- Inspect the shock absorber.
- Replace the shock absorber assembly if oil leaks
- Inspect the spring.
- Replace the shock absorber assembly if fatigue.
- Move the spring up and down.

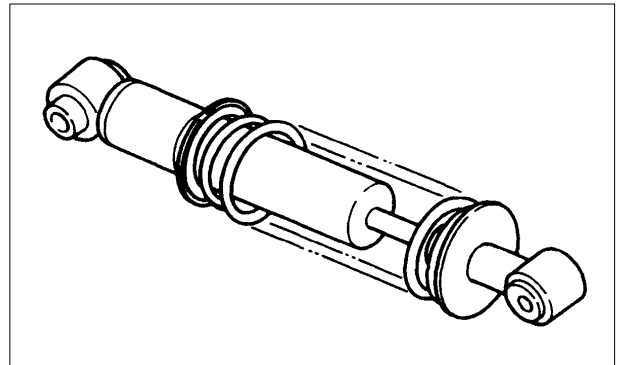

- Inspect the swing arm.
- Replace if crack, bend or damage.
- Roll the axle on a flat surface to inspect the pivot shaft.
- Replace if bends.

*

- Inspect the thrust cover, chain guard, collar and bush.
- Replace if wear or damage.

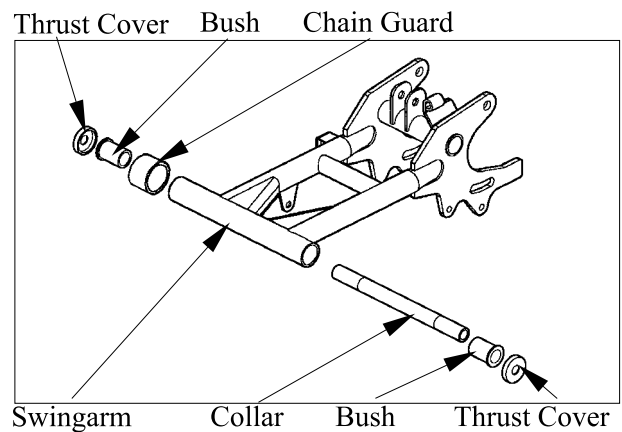

14. REAR WHEEL/SWING ARM/ HYDRAULIC BRAKE

INSTALLATION

Reverse the “REMOVAL” procedure.
Apply grease onto the collar, bush, pivot shaft and thrust cover.
Install the swing arm and tightening the nut.
Torque: 7 kgf-m (70 N-m, 50 lbf-ft)

Pivot Shaft



Install the shock absorber and tightening the upper mounting bolt/nut.
Torque: 4 kgf-m (40 N-m, 29 lbf-ft)



Install the shaft, washer and cotter pin (MX^{ER} 50).

*

Always use a new cotter pin.

Install the lower mounting bolt/nut to specified torque (MXU 50 REVERSE/MXU 50).

Torque: 4 kgf-m (40 N-m, 29 lbf-ft)



Install the rear hub and rear wheels.
Refer to the “REAR WHEEL INSTALLATION” section.

Adjust the drive chain slack.
Refer to the “DRIVE CHAIN SLACK ADJUSTMENT” section in the CHAPTER 3.

Drive chain slack: 10-20 mm (0.4 – 0.8 in)

HYDRAULIC BRAKE

BRAKE FLUID CHANGE/AIR BLEED

Place the motorcycle on its main stand on level ground and set the handlebar upright. Remove the two screws attaching the brake fluid reservoir cap.

Use shop towels to cover plastic parts and coated surfaces to avoid damage caused by splash of brake fluid.

Screws



Connect a transparent hose to the brake caliper bleed valve and then loosen the bleed valve nut. Use a syringe to draw the brake fluid out through the hose.

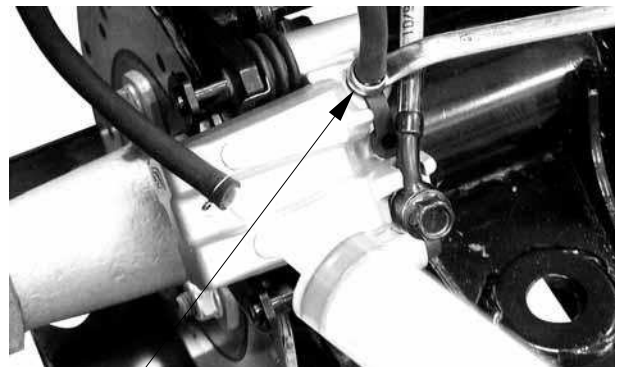

Bleed Valve

Brake fluid refilling

Connect a transparent hose and syringe to the brake caliper bleed valve and then loosen the bleed valve nut. Fill the brake reservoir with brake fluid and use the syringe to draw brake fluid into it until there is no air bubbles in the hose. Then, tighten the bleed valve nut.

Torque: 0.6 kgf-m (6 N-m, 4.3 lbf-ft)

- When drawing brake fluid with the syringe, the brake fluid level should be kept over 1/2 of the brake reservoir height.
- Use only the recommended brake fluid.

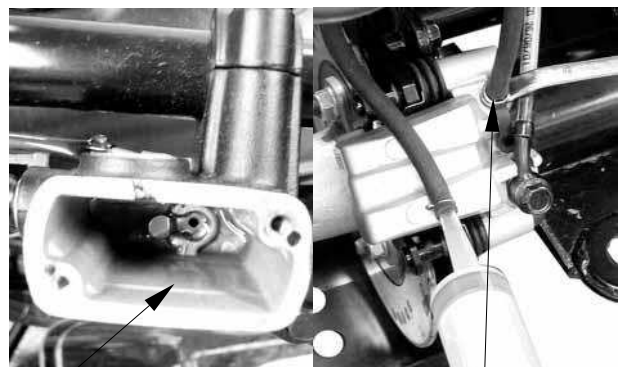

Brake Reservoir

Bleed Valve

Recommended Brake Fluid: DOT-4

14. REAR WHEEL/SWING ARM/ HYDRAULIC BRAKE

Brake system bleeding

Connect a transparent hose to the bleed valve and fully apply the brake lever after continuously pull it several times. Then, loosen the bleed valve nut to bleed air from the brake system. Repeat these steps until the brake system is free of air.

When bleeding air from the brake system, the brake fluid level should be kept over 1/2 of the brake reservoir height.

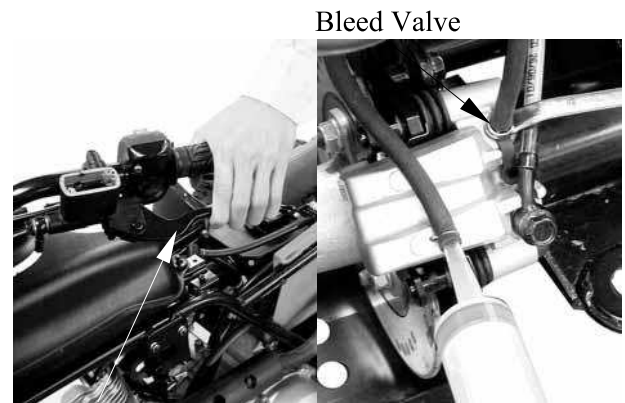

BRAKE PAD/DISK

Brake pad replacement

Remove the two bolts attaching the brake caliper holder.

The brake pads can be replaced without removing the brake fluid tube.

Remove the brake caliper.

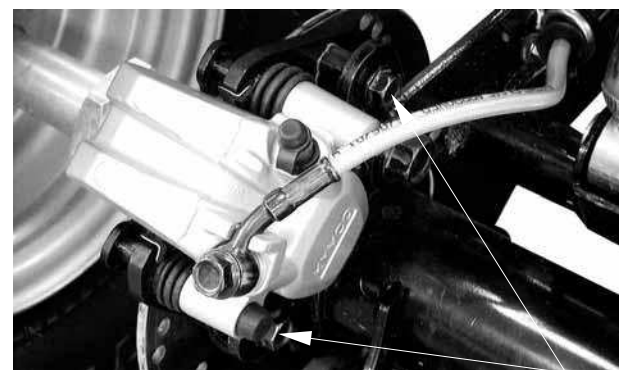

Push the brake caliper holder and then remove brake pad.

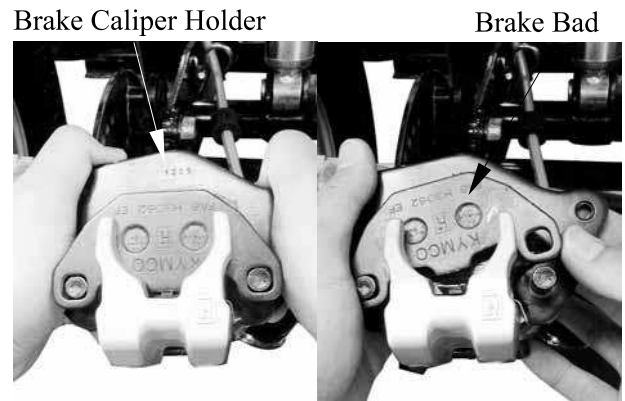

Remove the other brake pad and pad springs.

Assembly

Assemble the brake pads in the reverse order of removal.

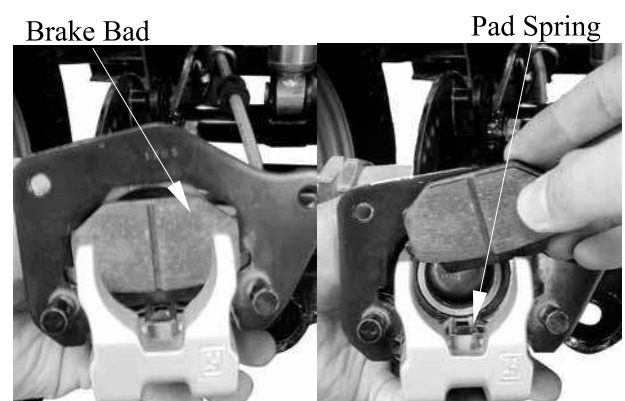

14. REAR WHEEL/SWING ARM/ HYDRAULIC BRAKE

Brake disk

Measure the brake disk thickness.

Service Limit: 3 mm (0.12 in)

Measure the brake disk run out.

Service Limit: 0.3 mm (0.012 in)

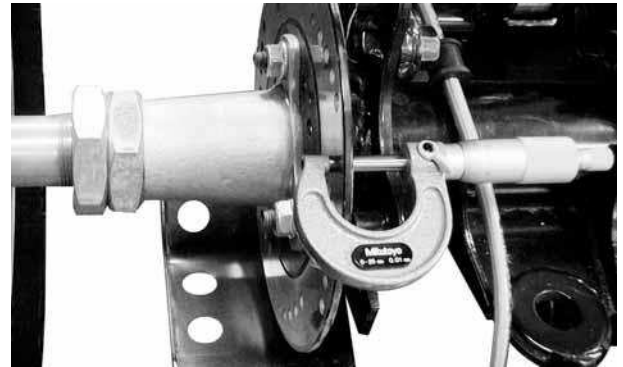

BRAKE MASTER CYLINDER

Removal

Drain the brake fluid from the hydraulic brake system.

Do not splash brake fluid onto any rubber, plastic and coated parts. When working with brake fluid, use shop towels to cover these parts.

Remove the two master cylinder holder bolts and remove the master cylinder.

When removing the brake fluid tube bolt, be sure to place towels under the tube and plug the tube end to avoid brake fluid leakage and contamination.

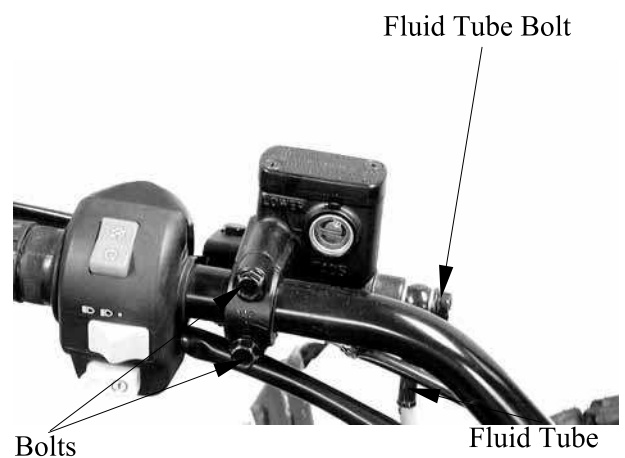

14. REAR WHEEL/SWING ARM/ HYDRAULIC BRAKE

Disassembly

Remove the piston rubber cover and snap ring from the brake master cylinder.



Snap Ring Pliers

Remove the washer, main piston and spring from the brake master cylinder.
Clean the inside of the master cylinder and brake reservoir with brake fluid.

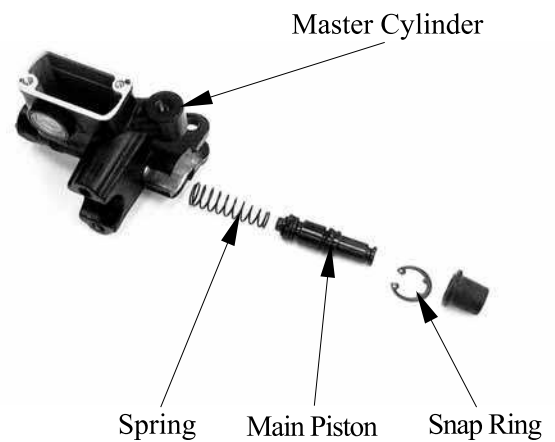

Inspection

Measure the brake master cylinder I.D.
Inspect the master cylinder for scratches or cracks.

Service Limit:

12.75 mm (0.51 in) replace if over



Measure the brake master cylinder piston O.D.

Service Limit:

12.64 mm (0.5056 in) replace if below



14. REAR WHEEL/SWING ARM/ HYDRAULIC BRAKE

Assembly

Before assembly, apply brake fluid to all removed parts.

Install the spring together with the 1st rubber cup.

- During assembly, the master cylinder, main piston and spring must be installed as a unit without exchange.
- When assembling the piston, soak the cups in brake fluid for a while.



Install the main piston and snap ring.
Install the rubber cover.
Install the brake lever.
Install the brake fluid tube with the bolt and two sealing washers. Then, install the rearview mirror.
Fill the brake reservoir with recommended brake fluid to the upper level.
Bleed air from the hydraulic brake system.
(Refer to 14-18.)



Place the brake master cylinder on the handlebar and install the master cylinder holder with the "UP" mark facing up, aligning the tab on the holder with the hole in the handlebar.
First tighten the upper bolt and then tighten the lower bolt.

Torque: 1.2 kgf-m (12 N-m, 8.6 lbf-ft)



14. REAR WHEEL/SWING ARM/ HYDRAULIC BRAKE

BRAKE CALIPER

Removal

Remove the brake caliper, brake pads and pad spring.
Place a clean container under the brake caliper and disconnect the brake fluid tube from the brake caliper.

Be careful not to splash brake fluid on any coated surfaces.



Disassembly

Remove the brake caliper holder from the brake caliper.

Brake Caliper Holder

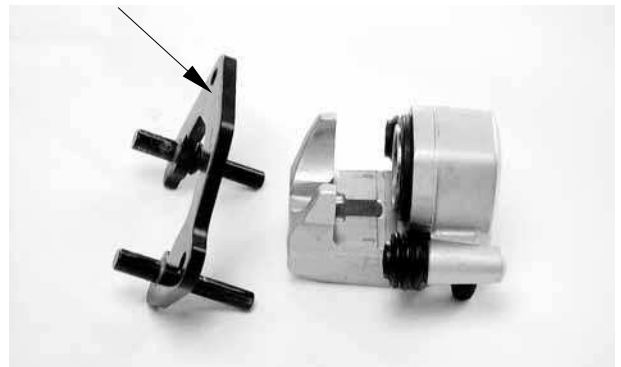

Remove the pistons from the brake caliper.
Use compressed air to press out the pistons through the brake fluid inlet opening and place a shop towel under the caliper to avoid contamination caused by the removed pistons.



Push the piston oil seals inward to remove them.
Clean each oil seal groove with brake fluid.

Be careful not to damage the piston surface.

Piston Oil Seals



14. REAR WHEEL/SWING ARM/ HYDRAULIC BRAKE

Inspection

Check the piston for scratches or wear.
Measure the piston O.D. with a micrometer gauge.

Service limit:

33.85 mm (1.354 in) replace if below



Check the caliper cylinder for scratches or wear and measure the caliper cylinder I.D.

Service limit:

34.05 mm (1.362 in) replace if over



Assembly

Clean all removed parts.

Apply silicon grease to the pistons and oil seals. Lubricate the brake caliper cylinder inside wall with brake fluid.

Install the oil seals and then install the brake caliper pistons with the grooved side facing out.

Install the piston with its outer end protruding 3~5 mm (0.12~0.2 in) beyond the brake caliper.



Wipe off excessive brake fluid with a clean shop towel. Apply silicon grease to the brake caliper holder pin and caliper inside. Install the brake caliper holder.

14. REAR WHEEL/SWING ARM/ HYDRAULIC BRAKE

Installation

Connect the brake fluid tube to the brake caliper, aligning the fluid tube with groove in the caliper and tighten the fluid tube bolt.

Torque: 3.2 kgf-m (32 N-m, 23 lbf-ft)

Add the recommended brake fluid into the brake reservoir and bleed air from the brake system. (Refer to 14-18.)

Aligning The Fluid Tube With Groove

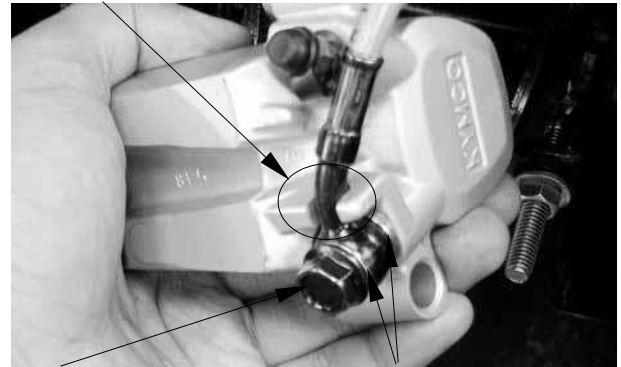

Fluid Tube Bolt

Washer

Install the brake caliper onto rear axle hub and tighten the bolts.

Torque: 2.7 kgf-m (27 N-m, 19 lbf-ft)



**BATTER/CHARGING SYSTEM/
A.C. GENERATOR**

SERVICE INFORMATION-----	15- 3
TROUBLESHOOTING-----	15- 4
BATTERY -----	15- 5
PERFORMANCE TEST -----	15- 6
A.C. GENERATOR CHARGING COIL (MX'ER 50)-----	15- 7
A.C. GENERATOR CHARGING COIL (MXU 50 REVERSE/MXU 50) -----	15- 9

15. BATTERY/CHARGING SYSTEM/ A.C. GENERATOR

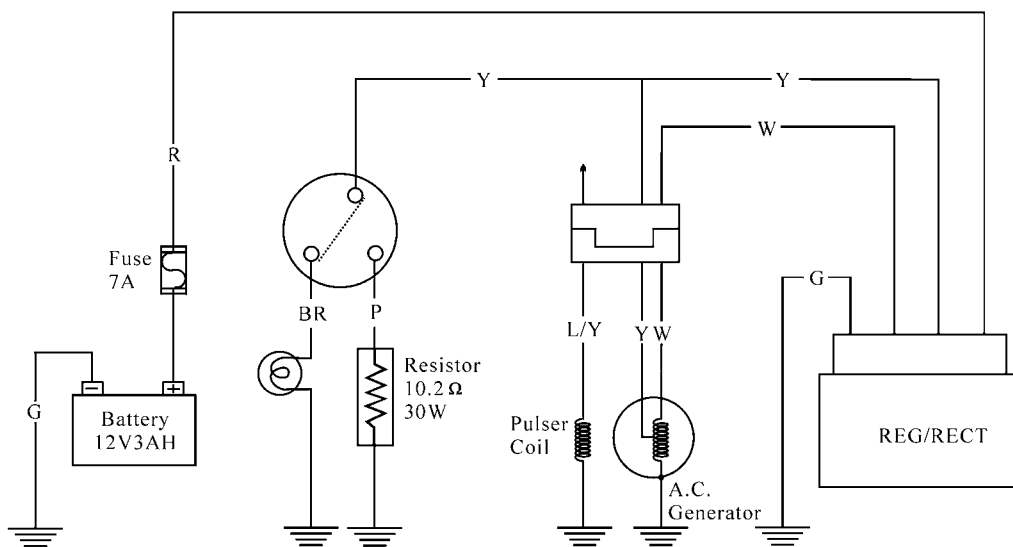
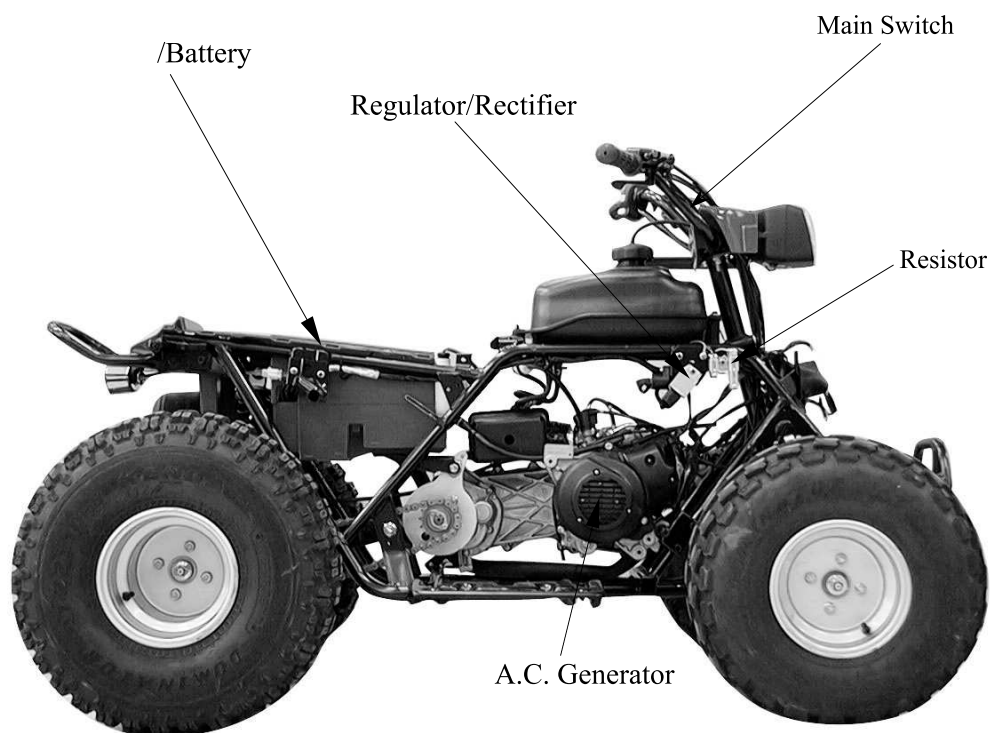

15. BATTERY/CHARGING SYSTEM/ A.C. GENERATOR

MXU 50 REVERSE/MXU 50

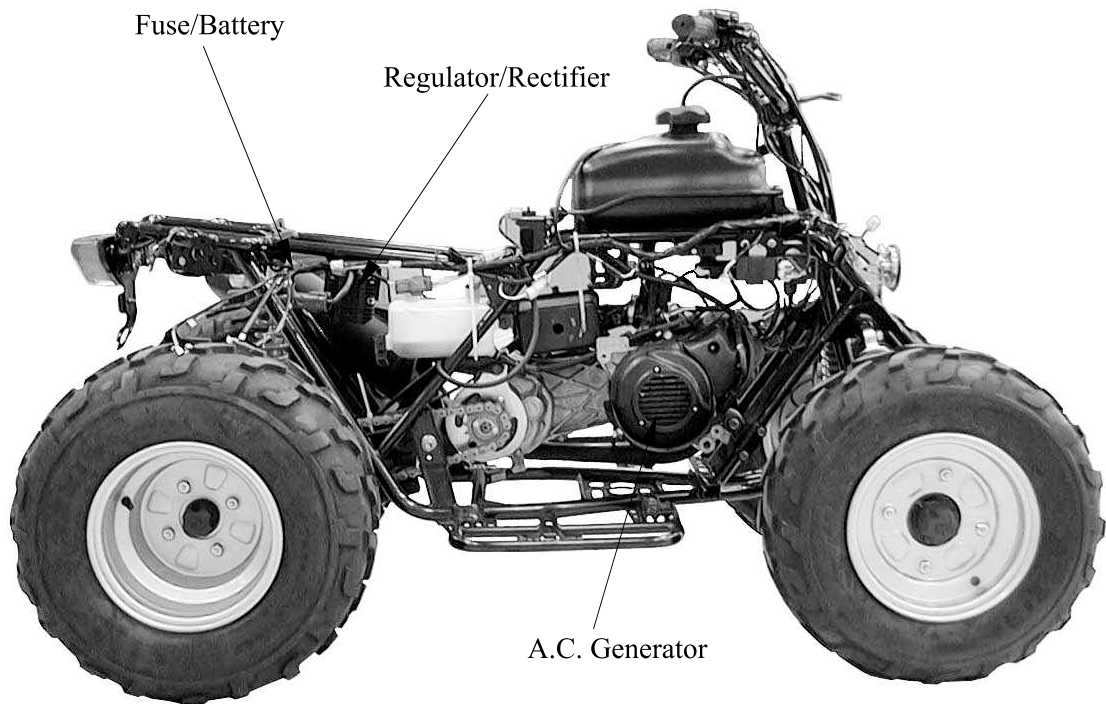

CHARGING CIRCUIT (MXU 50 REVERSE/MXU 50)

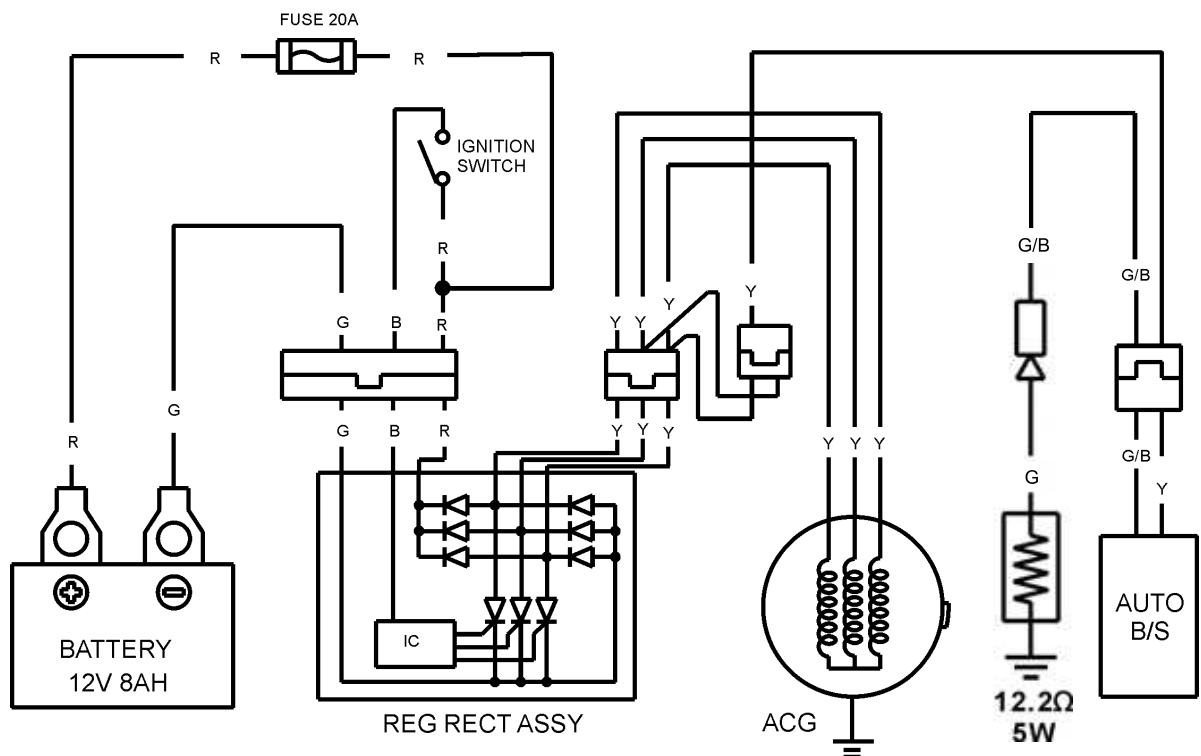

SERVICE INFORMATION

GENERAL INSTRUCTIONS

The battery electrolyte (sulfuric acid) is poisonous and may seriously damage the skin and eyes. Avoid contact with skin, eyes, or clothing. In case of contact, flush with water and get prompt medical attention

- The battery can be charged and discharged repeatedly. If a discharged battery is not used for a long time, its service life will be shortened. Generally, the capacity of a battery will decrease after it is used for 2~3 years. A capacity-decreased battery will resume its voltage after it is recharged but its voltage decreases suddenly and then increases when a load is added.
- When a battery is overcharged, some symptoms can be found. If there is a short circuit inside the battery, no voltage is produced on the battery terminals. If the rectifier won't operate, the voltage will become too high and shorten the battery service life.
- If a battery is not used for a long time, it will discharge by itself and should be recharged every 3 months.
- A new battery filled with electrolyte will generate voltage within a certain time and it should be recharged when the capacity is insufficient. Recharging a new battery will prolong its service life.
- Inspect the charging system according to the sequence specified in the Troubleshooting.
- Do not disconnect and soon reconnect the power of any electrical equipment because the electronic parts in the regulator/rectifier will be damaged. Turn off the ignition switch before operation.
- It is not necessary to check the MF battery electrolyte or fill with distilled water.
- Check the load of the whole charging system.
- Do not quick charge the battery. Quick charging should only be done in an emergency.
- Remove the battery from the motorcycle for charging.
- When replacing the battery, do not use a traditional battery.
- When charging, check the voltage with a voltmeter.

SPECIFICATIONS

		Item	Standard
Battery	Capacity/Model	MX'ER 50	12V-4AH
		MXU 50 REVERSE/MXU 50	12V-8AH
	Voltage (20°C)	Fully charged	13.1V
		Undercharged	12.3V
	Charging current		STD: 0.4A Quick: 4A
Charging time		STD: 5~10hr Quick: 30min	
A.C. Generator	Capacity		150W
	Charging coil resistance (20°C)		0.2~1.5 Ω

TORQUE VALUES

Regulator/Rectifier lock nut

0.9 kgf-m (9 N-m, 6.5 lbf-ft)

TESTING INSTRUMENTS

Kowa electric tester

Sanwa electric tester

TROUBLESHOOTING

No power

- Dead battery
- Disconnected battery cable
- Fuse burned out
- Faulty ignition switch

Low power

- Weak battery
- Loose battery connection
- Charging system failure
- Faulty regulator/rectifier

Intermittent power

- Loose battery cable connection
- Loose charging system connection
- Loose connection or short circuit in lighting system

Charging system failure

- Loose, broken or shorted wire or connector
- Faulty regulator/rectifier
- Faulty A.C. generator

BATTERY

BATTERY REMOVAL

Open the seat (see page 2-3 or 2-8) and battery cover .

Disconnect the battery cables .

- * First disconnect the battery negative (-) cable and then the positive (+) cable.

Remove the battery.

The installation sequence is the reverse of removal.

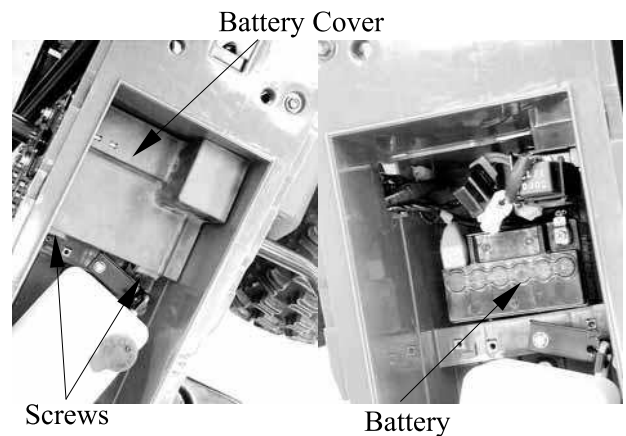

BATTERY CHARGING (OPEN CIRCUIT VOLTAGE) INSPECTION

Remove the battery cover and disconnect the battery cables.

Measure the voltage between the battery terminals.

Fully charged : 13.0V ~ 13.2V

Undercharged : 12.3V max.

- * Battery charging inspection must be performed with an electric tester.

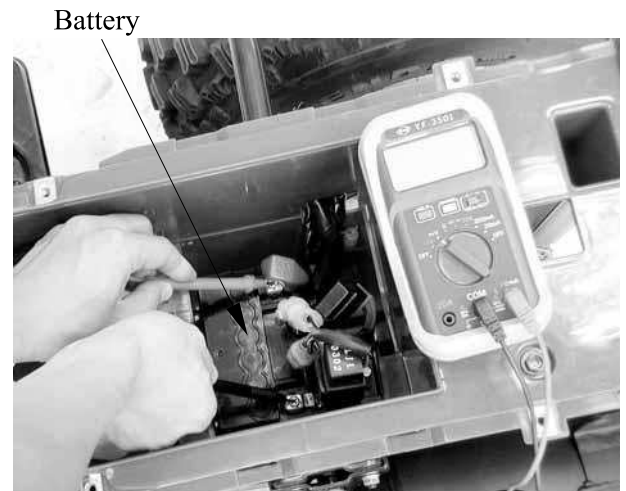

CHARGING METHOD

Connect the charger positive (+) cable to the battery positive (+) cable.

Connect the charger negative (-) cable to the battery negative (-) cable.

- *
 - Keep flames and sparks away from a charging battery.
 - Turn power ON/OFF at the charger, not at the battery terminals to prevent sparks near the battery.
 - Charge the battery according to the current specified on the battery surface.

Charging current: Standard : 0.4A

Quick : 4A

Charging time : Standard : 5 hours

Quick : 0.5 HOUR

After charging: Open circuit voltage:

12.8V min.

- *
 - Quick charging should only be done in an emergency.
 - During quick charging, the battery temperature should not exceed 45°C .
 - Measure the voltage 30 minutes after the battery is charged.

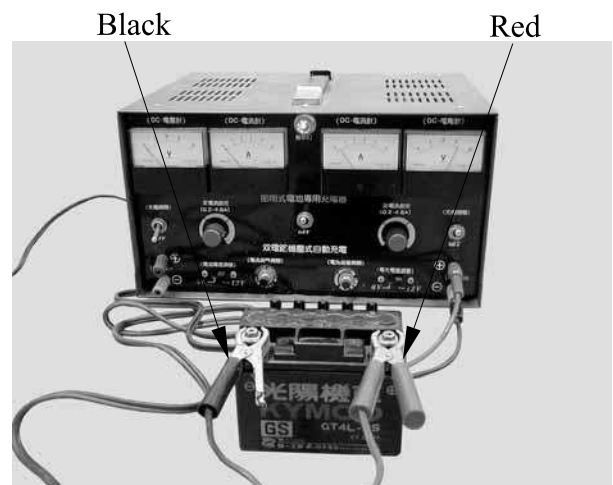

PERFORMANCE TEST

Warm up the engine.
Open the seat and battery cover.

Stop the engine and open the fuse box.
Disconnect the wire lead from the fuse terminal. Connect an ammeter between the wire lead and fuse terminal as shown.
Connect the battery positive (+) terminal to the voltmeter positive (+) probe and battery negative (-) terminal to the voltmeter negative (-) probe.
Start the engine, gradually increase engine speed to test the output:

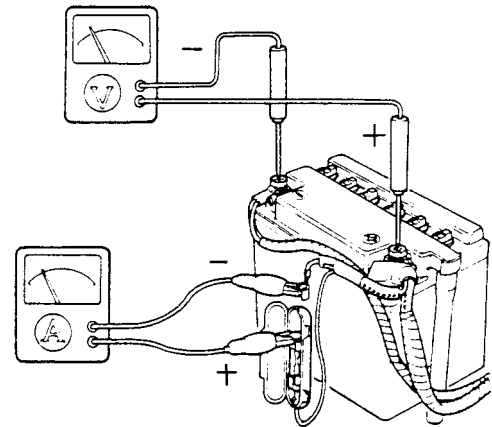

Position RPM	Day	Night
2500	0.7A min.	0.5A min.
6000	1.3A min.	1.3A min.

Charging Limit Voltage: $14.5 \pm 0.5V/8000rpm$
If the limit voltage is not within the specified range, check the regulator/rectifier.

CURRENT LEAKAGE TEST

Remove the seat (see page 2-3 or 2-8).
Turn the ignition switch "OFF", and disconnect the negative (-) cable from the battery.
Connect the ammeter (+) probe to the negative (-) cable and the ammeter (-) probe to the battery (-) terminal.
With the ignition switch "OFF", check for current leakage.

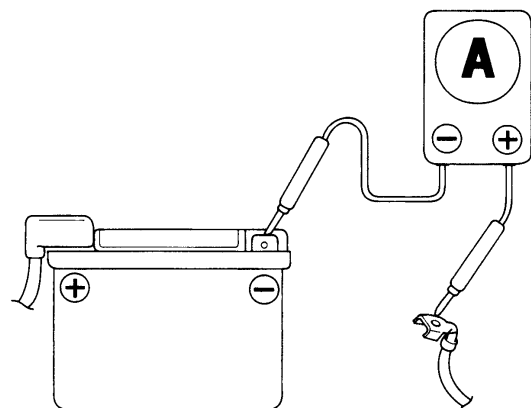

*

- When measuring current using a tester, set it to a high range, and then bring the range down to an appropriate level. current flow higher than the range selected may blow out the fuse in the tester.
- While measuring current, do not turn the ignition switch “ON”. A sudden surge of current may blow out the fuse in the tester.

Specified current leakage: 1 maximum

If current leakage exceeds the specified value, a shorted circuit is likely.

Locate the short by disconnecting connections one by one and measuring the current.

A.C. GENERATOR INSPECTION (MX'ER 50)

*

Inspect with the engine installed.

Disconnect the A.C. generator connector. Measure the resistances between the charging coil terminals (white-green) and lighting coil terminals (yellow-green).

Resistances:

Charging coil	White-green	0.2 ~ 1.2Ω
Lighting coil	Yellow-green	0.3 ~ 1.0Ω

Refer to 8-3 for A.C. generator removal.

A.C. Generator Connector



RESISTOR INSPECTION

Measure the resistance between the resistor B pink wire and ground.

Measure the resistance between the resistor A green/black wire and ground.

Resistances:

Resistor A:

MX'ER 50: 9.2~9.8Ω

MXU 50 REVERSE/MXU 50:
11.8~12.5Ω

Resistor B:

MX'ER: 5.6~6.2Ω

*

Faulty resistor is the cause of faulty operation of the auto bystarter.

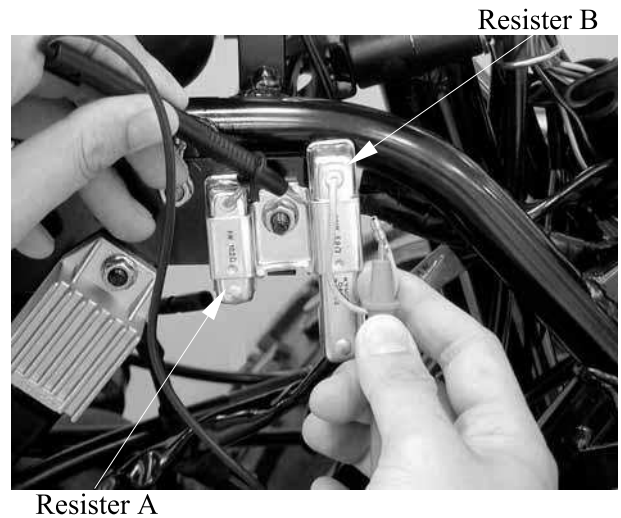

REGULATOR/RECTIFIER INSPECTION (MX'ER 50)

Disconnect the regulator/rectifier wire coupler and remove the nut to remove the regulator/rectifier.

Measure the resistances between the terminals.

Replace the regulator/rectifier if the readings are not within the specifications in the table below.

*

Due to the semiconductor in circuit, it is necessary to use a specified tester for accurate testing. Use of an improper tester in an improper range may give false readings.

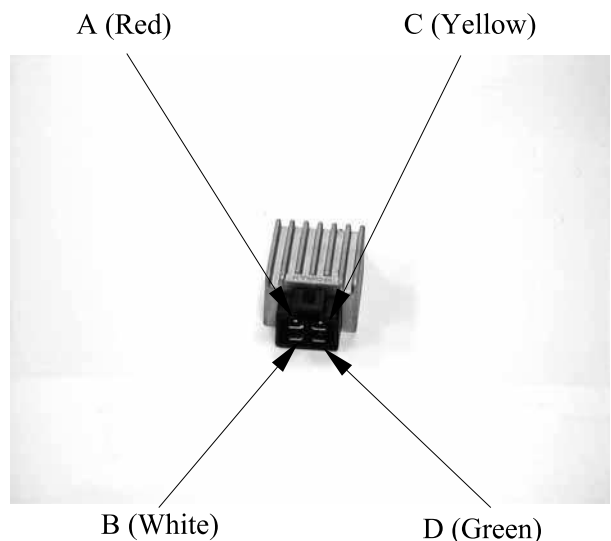
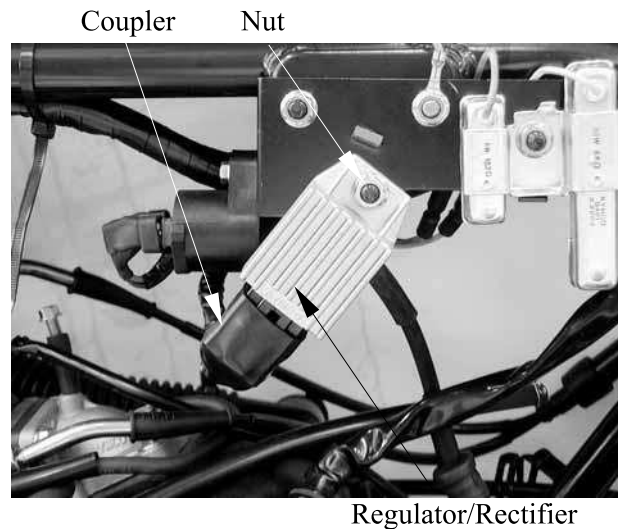

Model	Brand	Range
SP-10D	Sanwa	KΩ
TH-5H	Kowa	100Ω

Probe⊕ / Probe(-)	A (R)	B (W)	C (Y)	D (G)
A (R)		∞	∞	∞
B (W)	8-10KΩ		∞	∞
C (Y)	∞	∞		33-35KΩ
D (G)	∞	∞	33-35KΩ	

A.C.GENERATOR INSPECTION (MXU 50REVERSE/MXU 50)

Disconnect the A.C.Generator connector.
Measure the resistance between the yellow wire terminals of the alternator side connector.

Standard: 0.1-1 Ω (20°C/68°F)

Check for continuity between each yellow wire terminal of the alternator side connector and ground.

There should be no continuity.

Replace the alternator stator if resistance is out of specification, or if any wire has continuity to ground.

REGULATOR/RECTIFIER

Wire harness inspection

Disconnect the regulator/rectifier connector.
Check the connector for loose contacts or corroded terminals.

Battery line

Measure the voltage between the red wire terminal and ground.

There should be battery voltage at all times.

Ground line

Check the continuity between the green wire terminal and ground.

There should be continuity at all times.

Voltage feedback line

Measure the voltage between the black wire terminal and ground.

There should be battery voltage with the ignition switch "ON", and no voltage with the ignition switch "OFF".

REC/REG Connector

A.C.G Connector

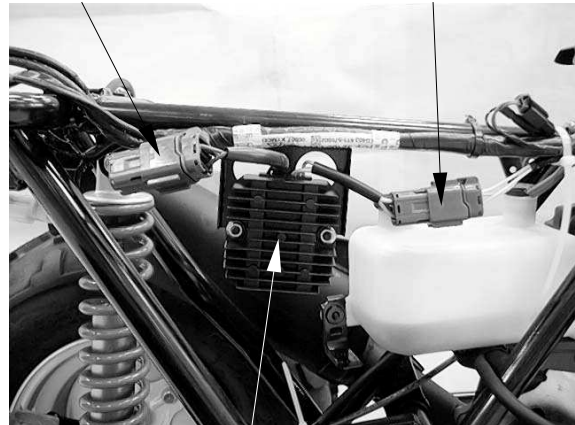

Rectifier/Regulator

IGNITION SYSTEM

SERVICE INFORMATION-----	16- 3
TROUBLESHOOTING-----	16- 4
IGNITION COIL INSPECTION -----	16- 5
PULSER UNIT-----	16- 6
CDI UNIT-----	16- 7

16. IGNITION SYSTEM

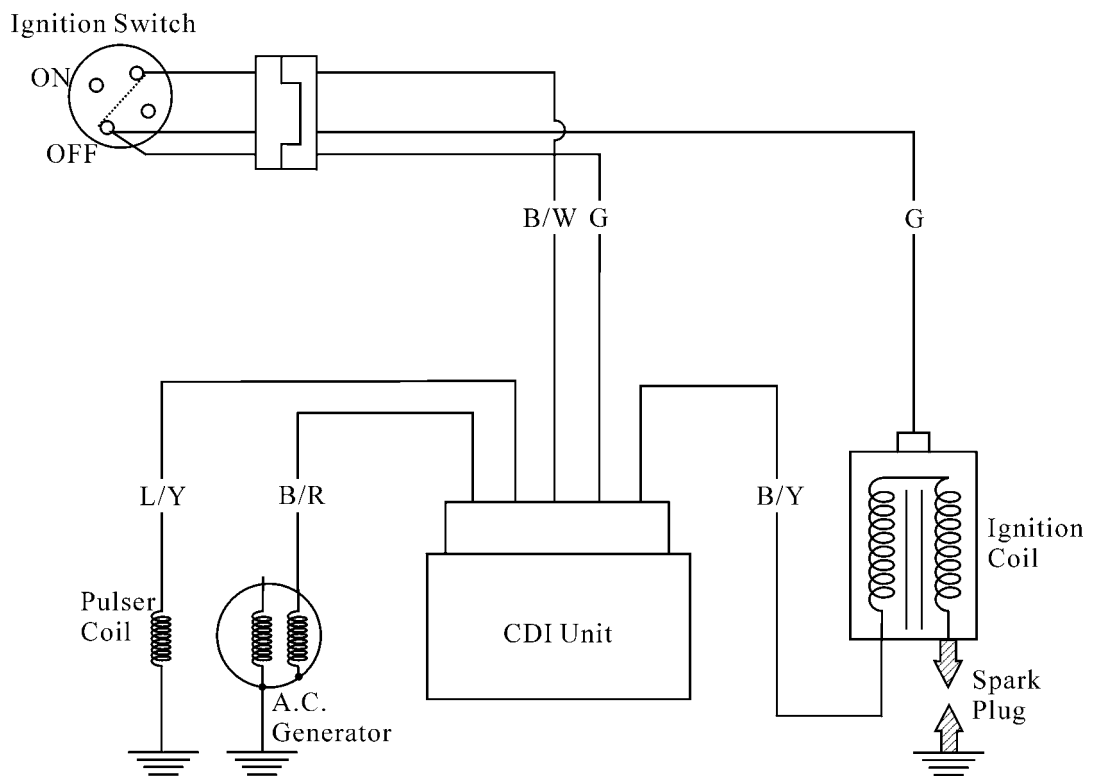
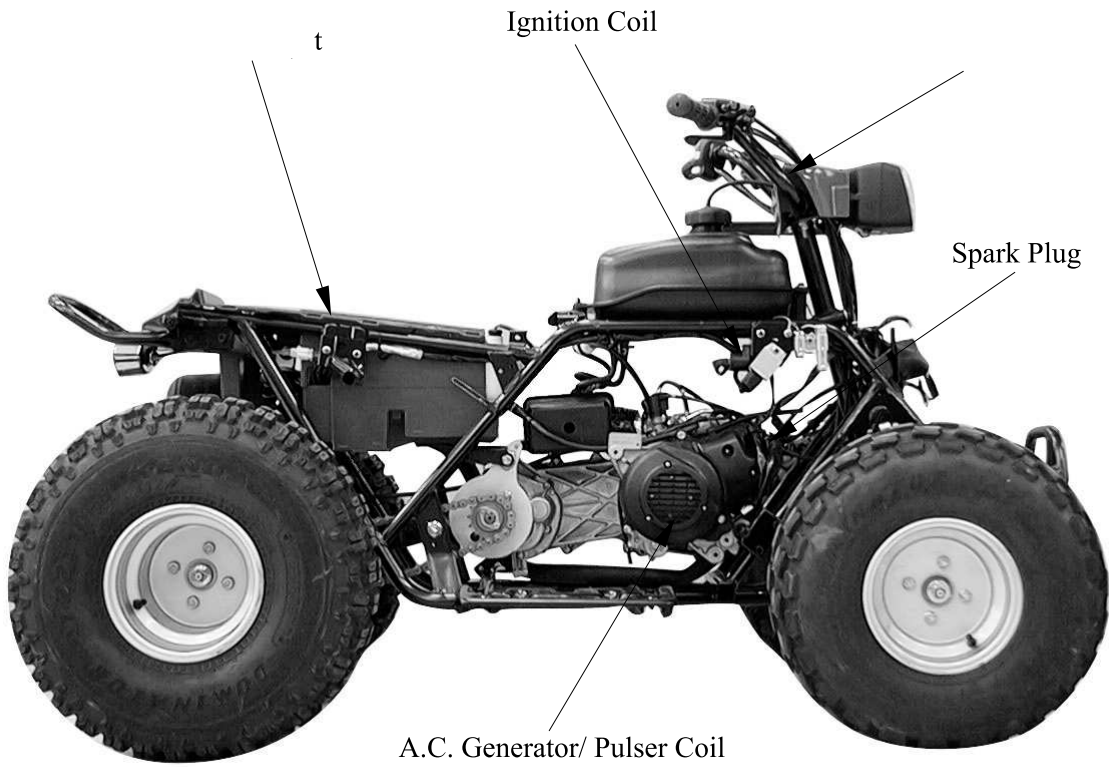

16. IGNITION SYSTEM

MXU 50 REVERSE/MXU 50

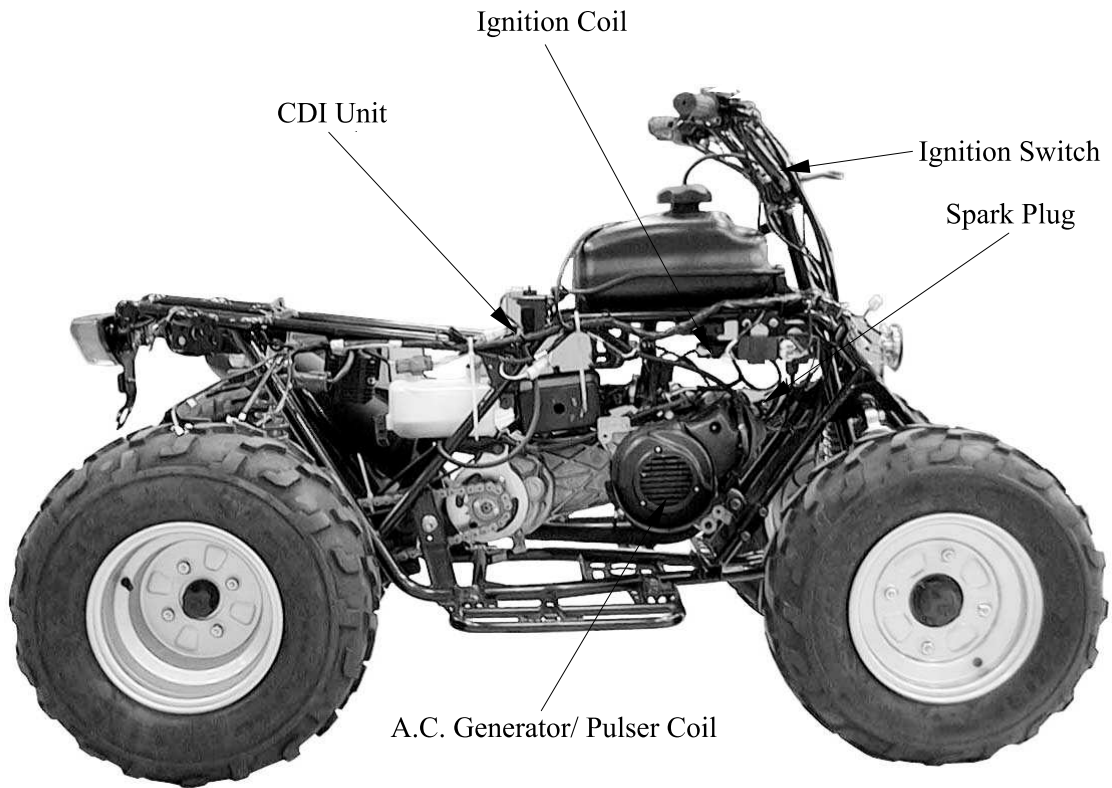

IGNITION CIRCUIT (MXU 50)

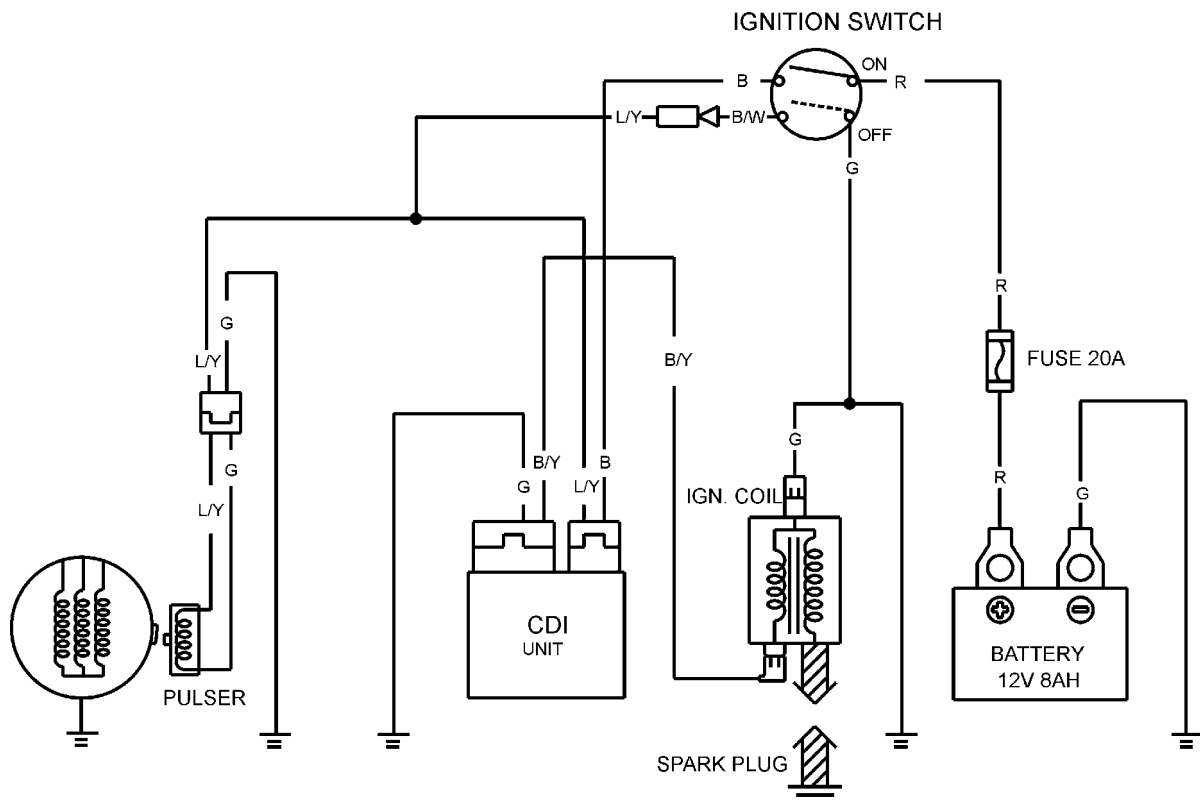

16. IGNITION SYSTEM

IGNITION CIRCUIT (MXU 50 REVERSE)

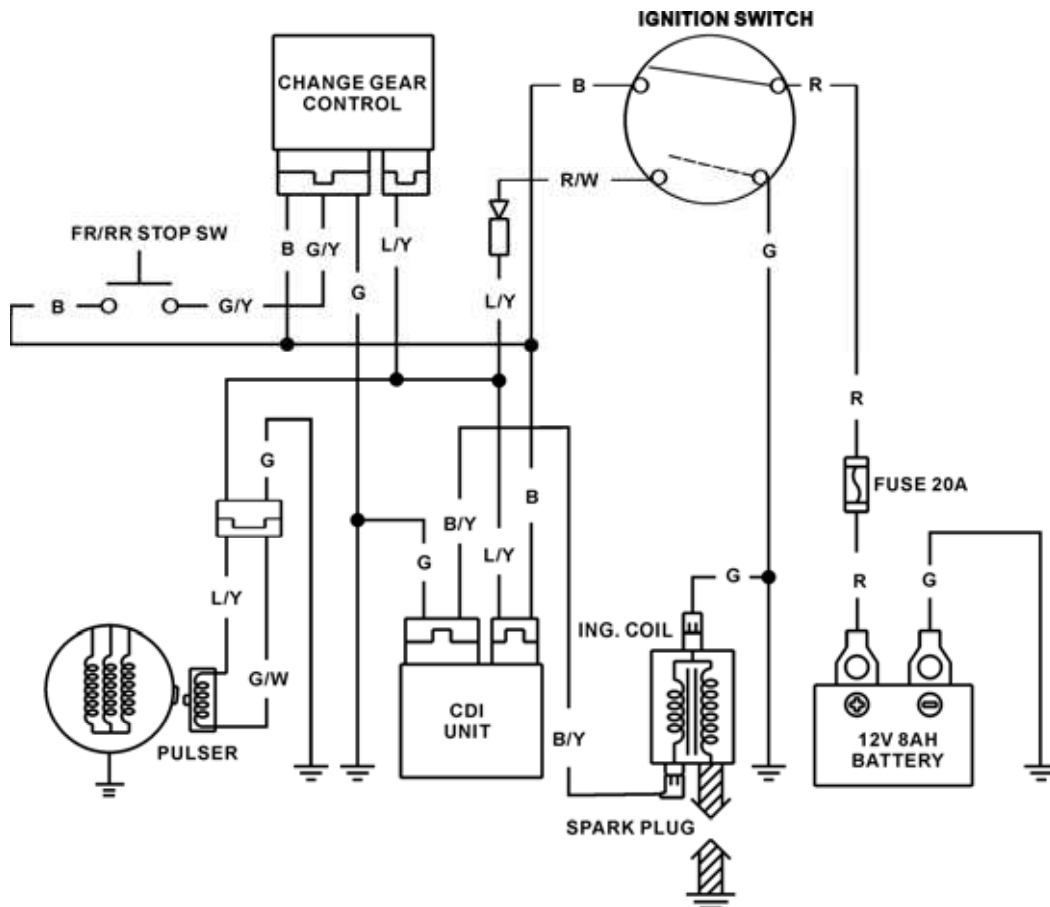

SERVICE INFORMATION

GENERAL INSTRUCTIONS

- Check the ignition system according to the sequence specified in the Troubleshooting.
- The ignition system adopts CDI unit, change gear control and the ignition timing cannot be adjusted.
- If the timing is incorrect, inspect the CDI unit, A.C. generator, change gear control and replace any faulty parts. Inspect the CDI unit with a CDI tester
- Loose connector and poor wire connection are the main causes of faulty ignition system. Check each connector before operation.
- Use of spark plug with improper heat range is the main cause of poor engine performance.
- The inspections in this section are focused on maximum voltage. The inspection of ignition coil resistance is also described in this section.
- Inspect the ignition switch according to the continuity table specified in page 18-6.
- Inspect the spark plug referring to Section 3.

16. IGNITION SYSTEM

SPECIFICATIONS

Item		Standard	
Spark plug	Standard type	BR8HAS	
	Hot type		
	Cold type		
Spark plug gap		0.6~0.7 mm (0.024~	
Ignition timing	“F” mark Full advance	MXU 50/MX’ER 50	22°BTDC/2000±100rpm
		MXU 50 REVERSE	13.5°BTDC/1500±100rpm
Ignition coil resistance (20°C)	Primary coil		0.2~0.3Ω
	Secondary coil	with plug cap	8.0~9.3KΩ
		without plug cap	3.0~4.2KΩ

TROUBLESHOOTING

High voltage too low

- Weak battery or low engine speed
- Loose ignition system connection
- Faulty CDI unit
- Faulty ignition coil
- Faulty pulser coil

Normal high voltage but no spark at plug

- Faulty spark plug
- Electric leakage in ignition secondary circuit
- Faulty ignition coil

Good spark at plug but engine won’t start

- Faulty CDI or incorrect ignition timing
- Faulty change gear control unit
- Improperly tightened A.C. generator flywheel

No high voltage

- Faulty ignition switch
- Faulty CDI unit
- Poorly connected or broken CDI ground wire
- Dead battery or faulty regulator/rectifier
- Faulty ignition coil connector
- Faulty pulser coil

16. IGNITION SYSTEM

IGNITION COIL INSPECTION

Continuity Test

*

This test is to inspect the continuity of ignition coil.

Measure the resistance between the ignition coil primary coil terminals.

Resistance (20°C/68°F): 0.2~0.3Ω



Measure the secondary coil resistance between the spark plug cap and the primary coil terminal as Figure A shown.

Resistance (20°C/68°F) (with plug cap):
8.0~9.3KΩ



Figure A

Measure the secondary coil resistance between the ignition coil terminal and the primary coil terminal as Figure B shown.

Resistance (20°C/68°F) (without plug cap):
3.0~4.2KΩ

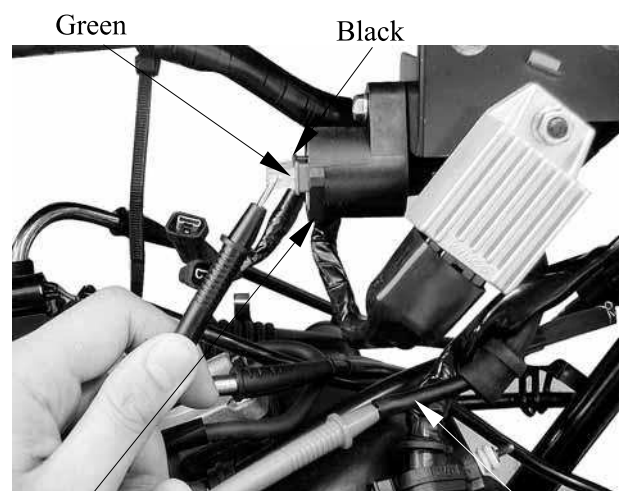

Ignition Coil

Figure B

16. IGNITION SYSTEM

Performance Test

Remove the ignition coil.

Ignition Coil

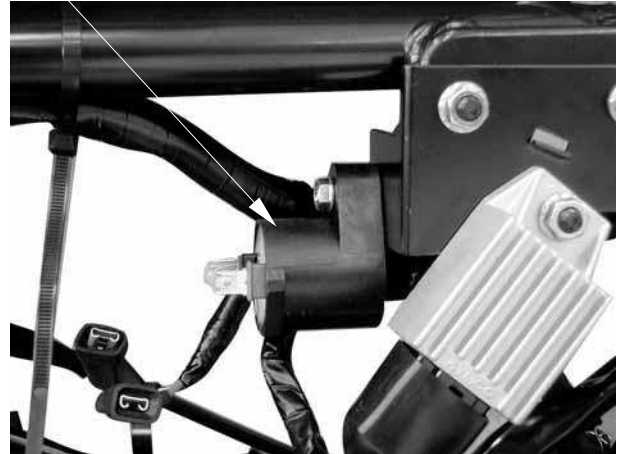

Inspect the ignition coil with an ignition coil tester.

* Follow the ignition coil tester manufacturer's instructions.

1. Turn the changeover switch to 12V and connect the ignition coil to the tester.
2. Turn the power switch ON and check the spark from the watch window.
 - Good : Normal and continuous spark
 - Faulty : Weak or intermittent spark

* The test is performed at both conditions that the ignition coil is cold and hot.

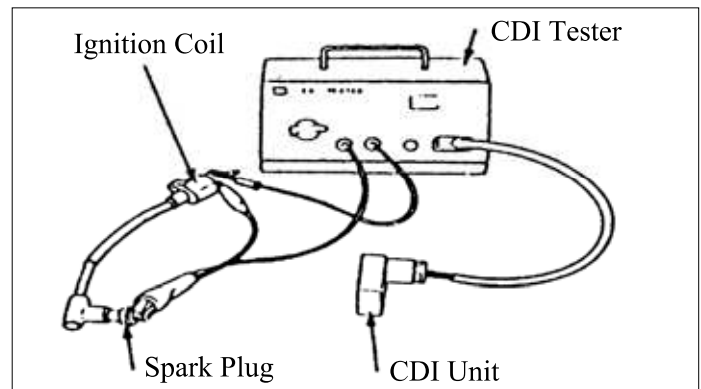

PULSER UNIT

WIRE HARNESS INSPECTION

Check the continuity between the Green wire terminal and ground.

There should be continuity at all times.

Pulser coil connector

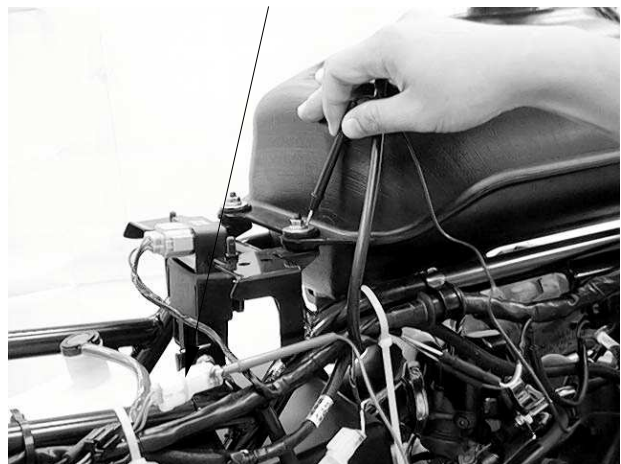

16. IGNITION SYSTEM

CDI UNIT

WIRE HARNESS INSPECTION

Measure the voltage between the black wire terminal and ground or between the black wire and green wire terminals. There should be battery voltage with the ignition switch "ON", and no voltage with the ignition switch "OFF"

CDI unit couple



CDI Unit

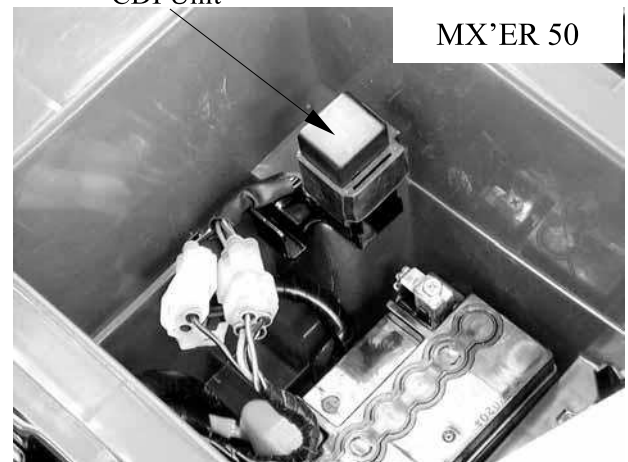

17. STARTING SYSTEM

STARTING SYSTEM

SERVICE INFORMATION-----	17- 2
TROUBLESHOOTING-----	17- 2
STARTER RELAY INSPECTION-----	17- 3
STARTER MOTOR REMOVAL -----	17- 3

17. STARTING SYSTEM

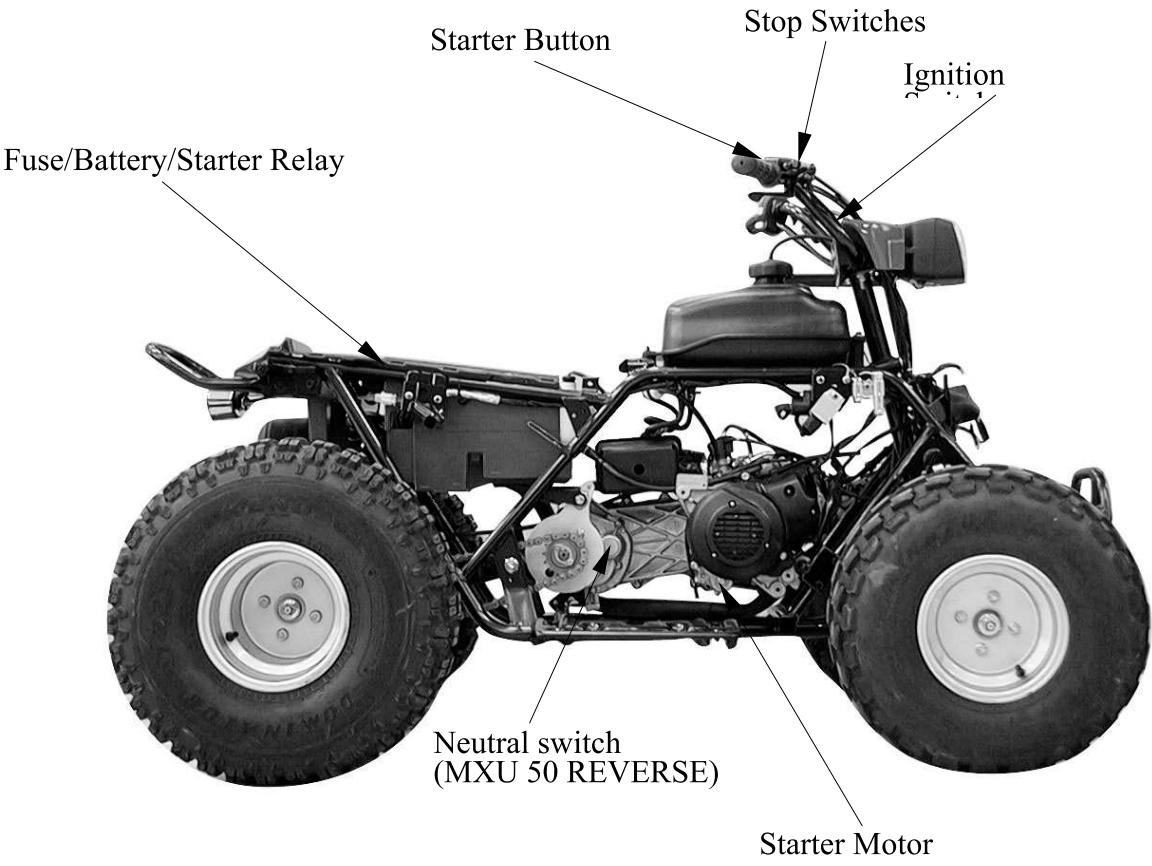

STARTING CIRCUIT (MXU 50/MXER 50)

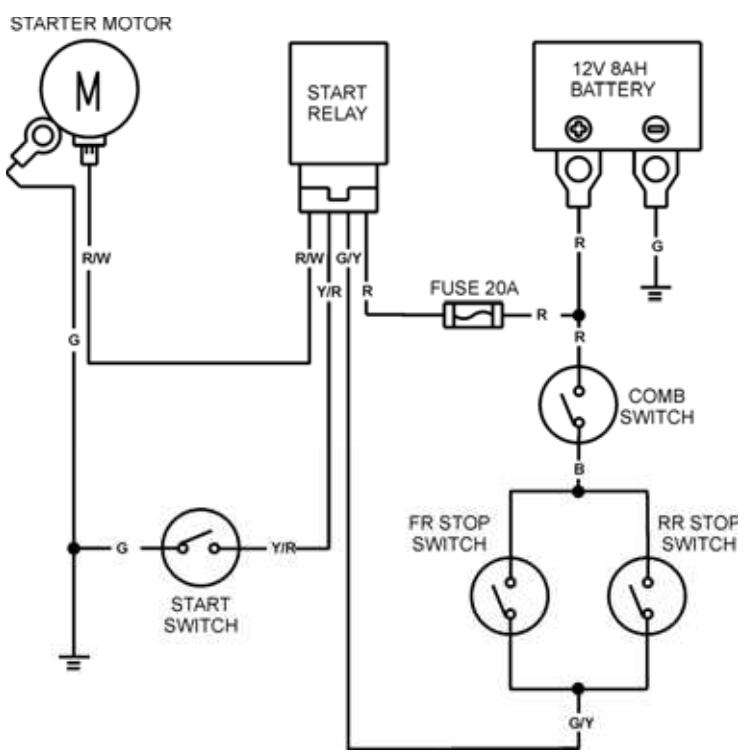

17. STARTING SYSTEM

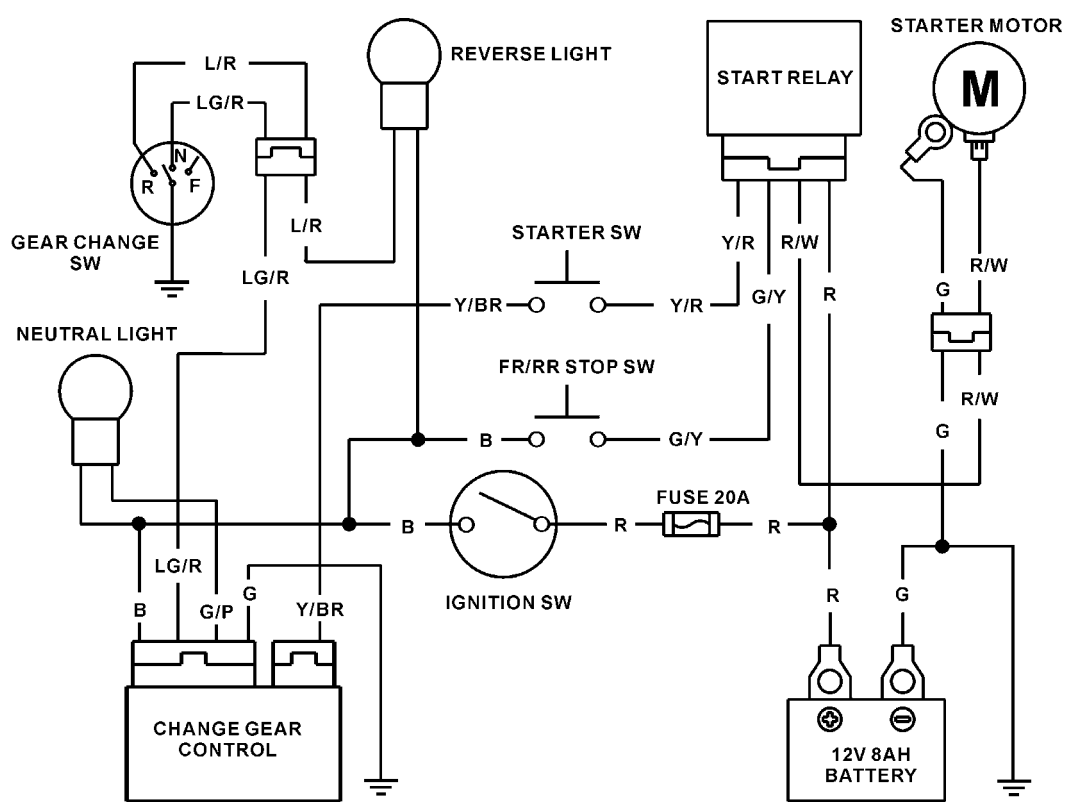

17. STARTING SYSTEM

STARTER RELAY INSPECTION

Remove the seat and battery cover.
Disconnect the starter relay coupler and
then remove the starter relay.



Connect the starter relay green/yellow terminal
to the 12V battery positive (+) terminal and the
relay yellow/red terminal to the battery
negative (-) terminal. Check for continuity
between the starter relay red and red/white
terminals. The relay is normal if there is
continuity.

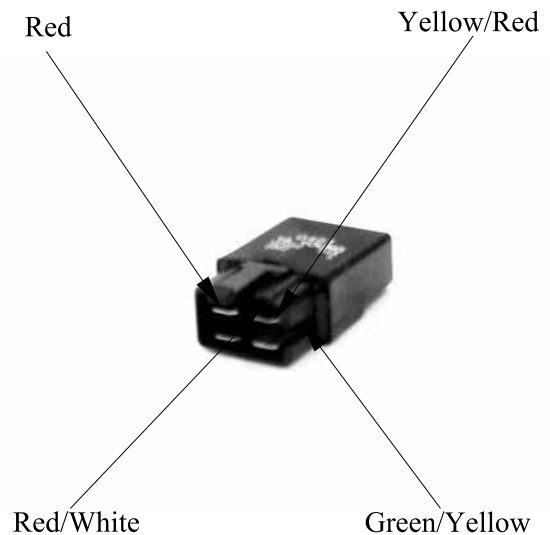

STARTER MOTOR REMOVAL

Disconnect the starter motor cable.
Remove the two bolts attaching the starter
motor and remove the starter motor.
The installation sequence is the reverse of
removal.

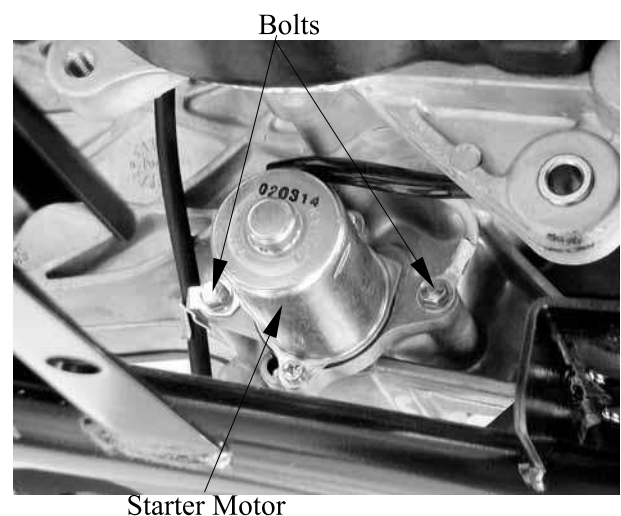

18. LIGHTS/ SWITCHES

18

LIGHTS/SWITCHES

SERVICE INFORMATION-----	18- 2
TROUBLESHOOTING-----	18- 2
HEADLIGHT (MX'ER 50) -----	18- 3
HEADLIGHT (MXU 50 REVERSE/MXU 50)-----	18- 4
POSITION LIGHT (MXU 50 REVERSE/MXU 50) -----	18- 5
INSTRUMENTS (MX'ER 50)-----	18- 5
STOP LIGHT/TAILLIGHT (MX'ER 50)-----	18- 5
IGNITION SWITCH -----	18- 6
STOP SWITCH/OIL LEVEL SWITCH -----	18- 7
HANDLEBAR SWITCH (MX'ER 50)-----	18- 8
NEUTRAL/REVERSE SWITCH (MXU 50 REVERSE) -----	18- 9

18. LIGHTS/ SWITCHES

ELECTRICAL EQUIPMENT LAYOUT

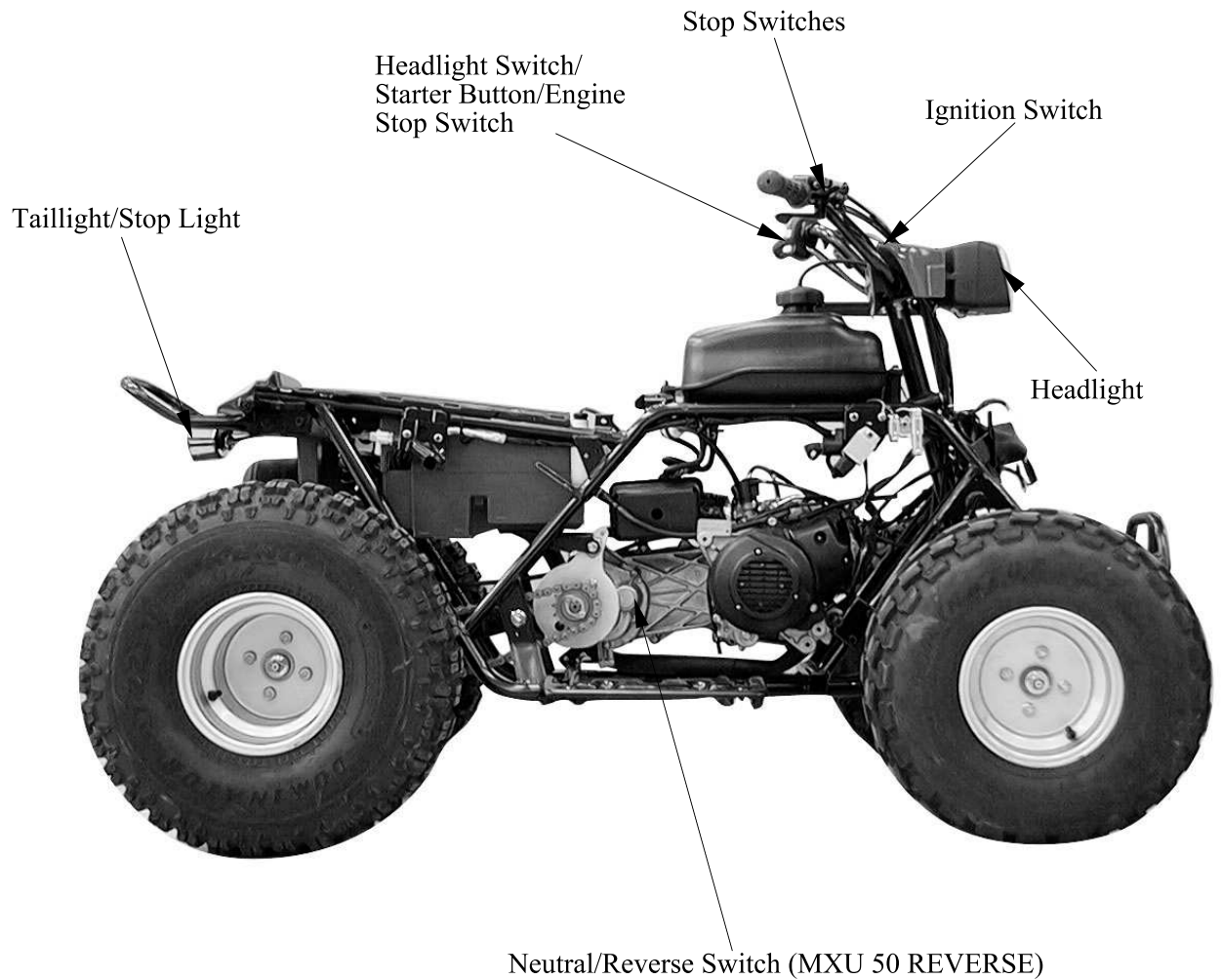

18. LIGHTS/ SWITCHES

SERVICE INFORMATION

GENERAL INSTRUCTIONS

- An electric tester is needed to measure or test the electric equipment.
- Be sure to use fuses and bulbs of the same specifications to avoid damage of electrical equipment.
- After installation of each switch, a continuity check must be performed. A continuity check can usually be made without removing the part from the motorcycle.

TROUBLESHOOTING

Lights do not come on when ignition switch is “ON”

- Faulty ignition switch
- Fuse burned out
- Weak battery
- Burned bulb
- Faulty switch
- Poorly connected, broken or shorted wire

Engine starts but stalls during idling

- Clogged carburetor

18. LIGHTS/ SWITCHES

HEADLIGHT(MX'ER 50)

BULB REPLACEMENT

Disconnect the cover of the ignition switch and remove the two headlight attaching bolts.

Remove the headlight and disconnect the headlight wire coupler.



Remove the two headlight case attaching screws and disconnect the headlight.



Check the bulb for damage and replace with a new one if necessary.
Disconnect the headlight wire coupler.

Headlight Wire Coupler



Remove the rubber boot.
Push and disconnect the spring from the headlight cover.

Rubber Boot

Spring

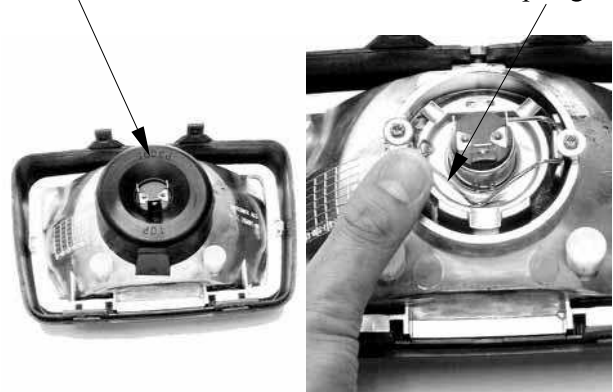

18. LIGHTS/ SWITCHES

Remove the headlight bulb

INSTALLATION

Install the headlight in the reverse order of removal.

* After installation, adjust the headlight beam.

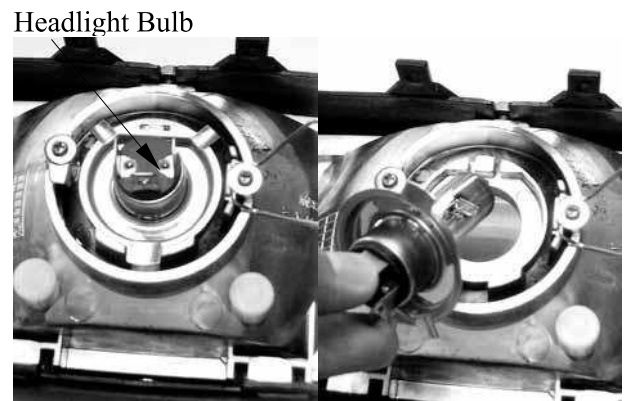

HEADLIGHT (MXU 50 REVERSE/MXU 50)

HEADLIGHT

Remove the front fender. (See page 2-13.)

Remove the rubber boot from the headlight case.

Disconnect the headlight wire connector.

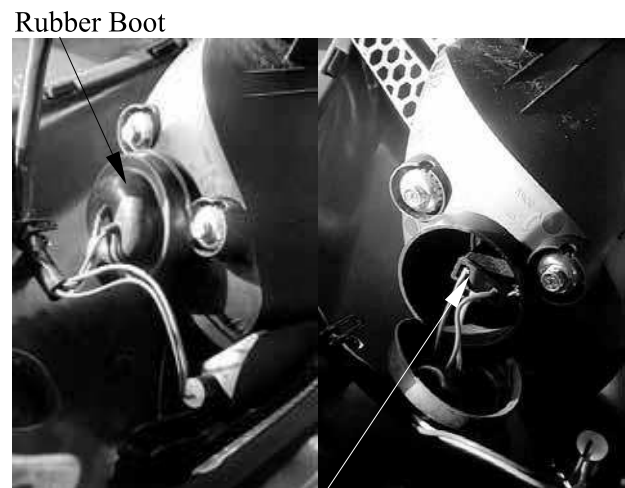

Headlight Connector

Relax the lock clips to remove the bulb and replace with a new one.

Install the bulb, aligning the bulb socket groove with the bulb tab and set the lock clips.

Connect headlight wire connector.

Install the rubber boot.

Install the front fender in the reverse order of removal.

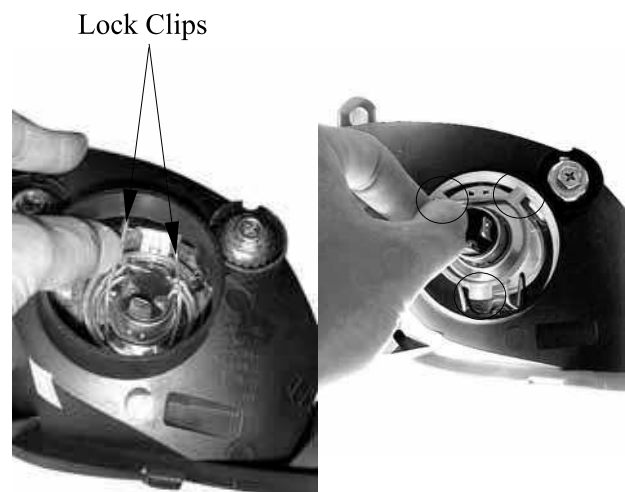

18. LIGHTS/ SWITCHES

POSITION LIGHT (MXU 50 REVERSE/MXU 50)

Remove the bulb socket by pulling it out.

Remove the bulb.

Install the bulb in the reverse order of removal



Bulb Socket

INSTRUMENTS (MX'ER 50)

REMOVAL

Remove the two headlight attaching bolts.
 Remove the headlight and disconnect the headlight wire coupler.
 Remove the two headlight case attaching screws and disconnect the headlight.

Remove the light shell, rubber boot and bulb socket.

Check the bulb for damage and replace with a new one if necessary.

INSTALLATION

The installation sequence is the reverse of removal.

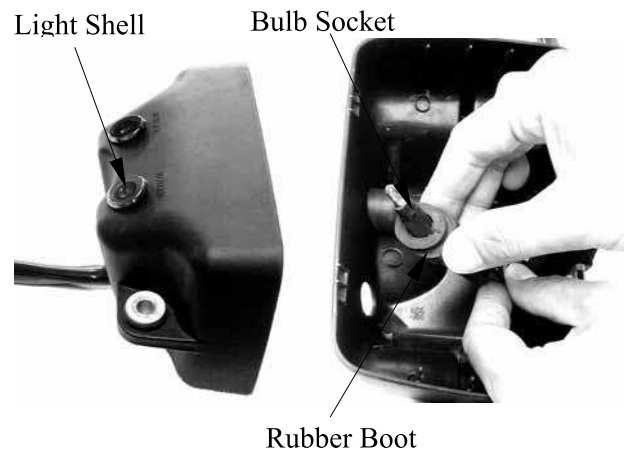

Light Shell

Bulb Socket

Rubber Boot

STOP LIGHT/TAILLIGHT

MX'ER 50

Remove the two taillight shell screws and the shell



Taillight Shell

Taillight Shell Screws

18. LIGHTS/ SWITCHES

Remove the bulb and check the bulb for damage. Replace with a new one if necessary.

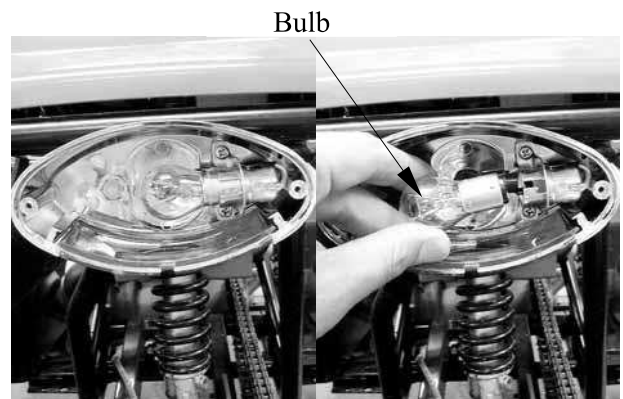

MXU 50 REVERSE/MXU 50:

Remove the bulb socket by turning it counterclockwise.
Remove the bulb.

Install the bulb in the reverse order of removal.

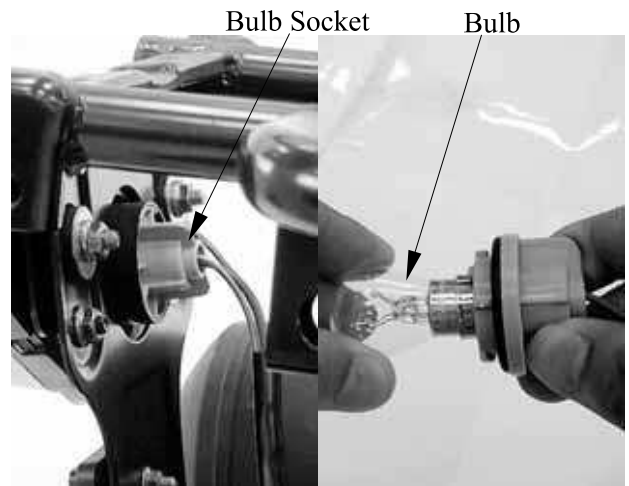

IGNITION SWITCH

MX'ER 50:

Check for continuity between the wires indicated below.

Color Position	Black	Red	Black/ White	Green
OFF			○ — ○	
ON	○ — ○			



18. LIGHTS/ SWITCHES

MXU 50 REVERSE/MXU 50: INSPECTION

Disconnect the ignition switch connectors. (Refer to the “HANDLEBAR COVER REMOVAL” section in chapter 2.)

Check for continuity between the switch side connector terminals in each switch position.

Continuity should exist between the color coded wires as right:

COMB SW

	IG	E	BAT1	BAT2	PO
OFF	○	○			
ON			○	○	
PO			○	○	○
COLOR	B/W	G	R	B	BR

REPLACEMENT

Release the switch wire from the wire clips on the steering shaft holder frame pipe.

Remove the handlebar cover (see page 2-12).

Remove the ignition switch from the cover while pushing in the two stoppers.

Install a new ignition switch by aligning the locating tab with the groove in the cover.

Install the removed parts in the reverse order of removal.

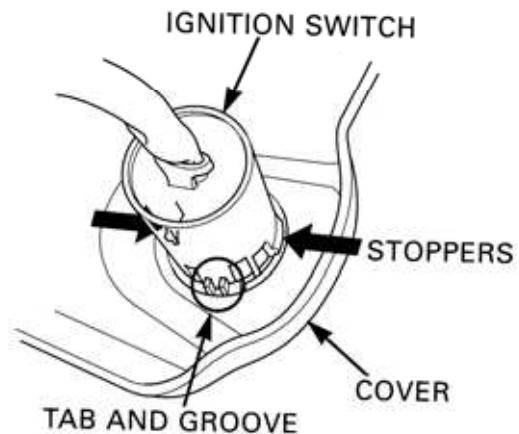

STOP SWITCH

Disconnect the front stop switch wire coupler.

Check for continuity between the front stop switch wires.

Brake lever applied: There is continuity.

Brake lever released: There is no continuity.



OIL LEVEL SWITCH

Remove the seat. (⇒2-3 or 2-8)

Disconnect the oil level switch wire connectors and remove the oil level switch. Keep the oil level switch float at the lower position (the oil meter is ON).

Measure the resistances between the connector.



18. LIGHTS/ SWITCHES

* Before removing the oil meter, be sure to drain the motor oil and do not allow sparks or flames near the working area.

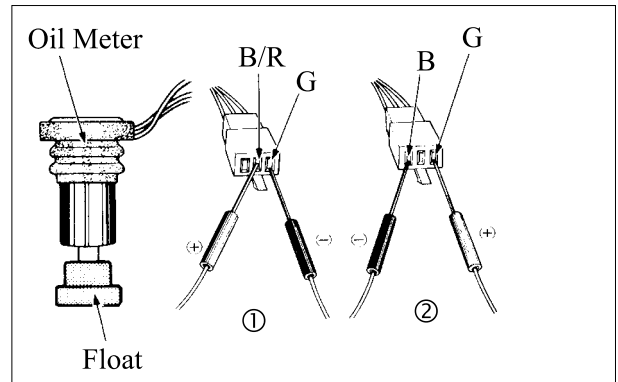

* Before performing the following test, operate the turn signals to determine that the battery circuit is normal.

Position \ r	Green	Yellow/Red
FREE		
PUSH	○	○

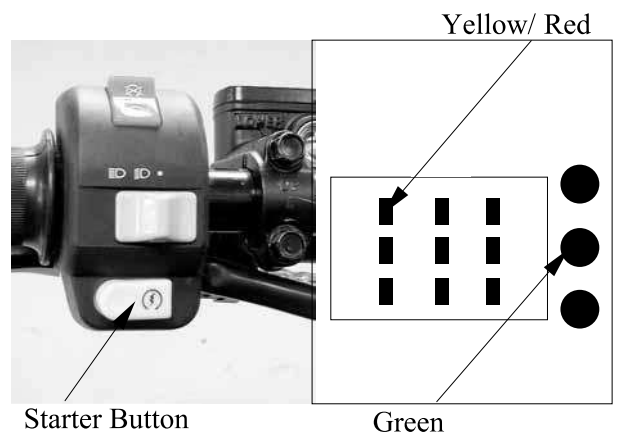

HEADLIGHT SWITCH

Remove the center cover. Disconnect the headlight switch wire coupler. Check for continuity between the headlight switch wires.

Color \ Position	Yellow	White	Blue	Pink
///	○			○
////	○	○		
	○		○	

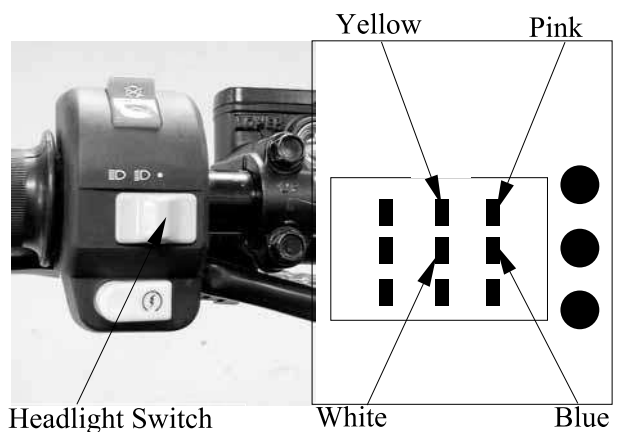

18. LIGHTS/ SWITCHES

ENGINE STOP SWITCH

Remove the center cover.
 Disconnect the headlight switch wire coupler. Check for continuity between the headlight switch wires.

Position	Color	Blue/Yellow	Green

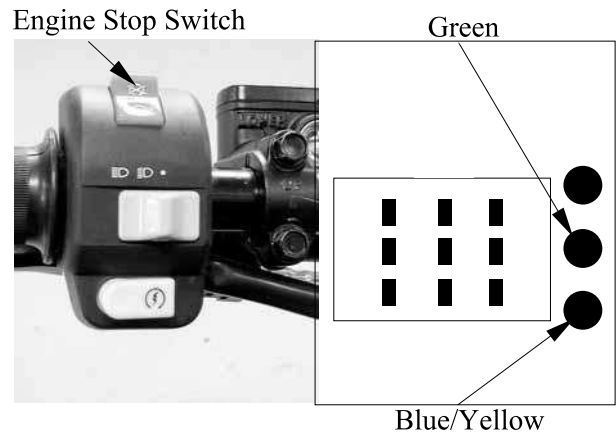

NEUTRAL/REVERSE SWITCHES (MXU 50 REVERSE) INSPECTION

Disconnect the neutral/reverse switch wire connector. (See page 6-4)

Check for continuity between the switch side connector terminal and engine ground.

NEUTRAL SWITCH

There should be continuity with the transmission in neutral and no continuity with it in any gear except neutral.

REVERSE SWITCH

There should be continuity with the transmission in reverse and no continuity with it in any gear except reverse.

REPLACEMENT

Remove drive and driven pulley. (Refer to chapter 9)

Remove the bolt from neutral/reverse switch.

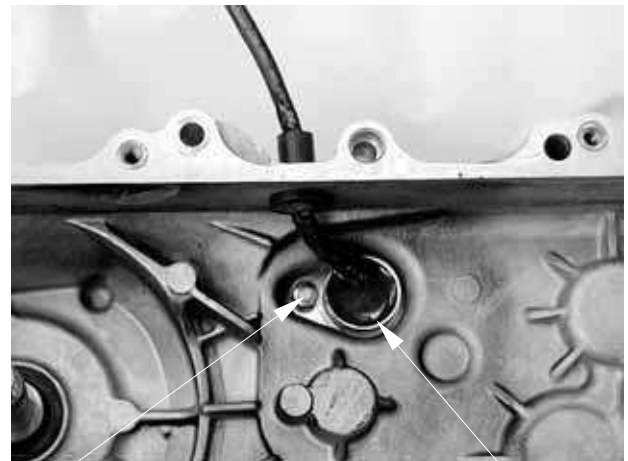

Neutral/Reverse Switch

18. LIGHTS/ SWITCHES

Remove the neutral/reverse switch from left crankcase.

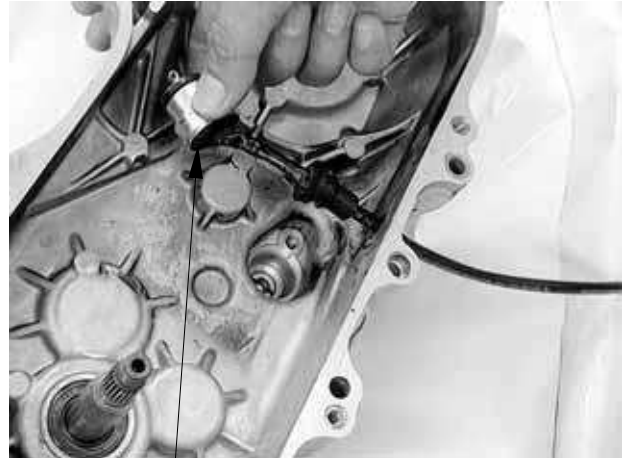

Neutral/Reverse Switch

Install a new switch and a new O-ring (apply engine oil to O-ring).

* Make sure that the lever on the neutral/reverse switch correctly engages with the locating slot on the shift shaft.



Slot

Lever

ONLY ATV ON ROAD AVAILABLE

19

INSTRUMENT (MX'ER 50) -----	19- 1
INDICATOR LIGHT-----	19- 1
HANDLEBAR SWITCH (MX'ER 50)-----	19- 2
HANDLEBAR SWITCH (MXU 50 REVERSE/MXU 50) -----	19- 3
TURN SIGNAL LIGHT (MXU 50 REVERSE/MXU 50) -----	19- 4

19. ONLY ATV ON ROAD AVAILABLE

INSTRUMENT (MX'ER 50)

Removal

Remove the two instrument attaching screws.

Disconnect the instrument.



Screws

SENSOR WHEEL

If the sensor is lost or worn, the speed will be not calculated on the instrument.

Speed Wheel

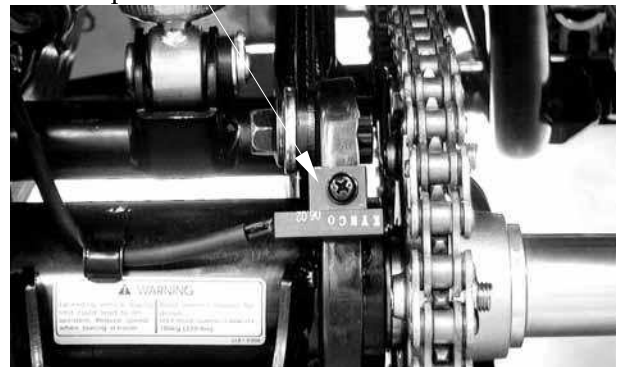

INDICATOR LIGHT

REMOVAL

Remove the screw and disconnect the cover of the ignition switch.

Screw



Remove the bulb socket and bulb.

Check the bulb for damage and replace with a new one if necessary.

Bulb Socket



Bulb

INSTALLATION

The installation sequence is the reverse of removal.

19. ONLY ATV ON ROAD AVAILABLE

HANDLEBAR SWITCH (MX'ER 50)

WINKER SWITCH

Check for continuity between the wires indicated below.

Color Position	Sky Blue	Orange	Brown
L		○ — ○	○
R	○ —		○



Hazard Switch

HORN SWITCH

Check for continuity between the wires indicated below.

Color Position	Light Green	Black
FREE		
PUSH	○ — ○	



Horn Switch

HORN

Removal

Disconnect the horn switch wire.
Remove the bolt and remove horn.

Installation

The installation sequence is the reverse of removal.



Bolt

Horn Switch wire

HAZARD SWITCH

Check for continuity between the wires indicated below.

Color Position	Yellow /Black	Black
	○ — ○	
●		



Hazard Switch

19. ONLY ATV ON ROAD AVAILABLE

HANDLEBAR SWITCH (MXU 50 REVERSE/MXU 50)

HORN SW

	HO	BAT
FREE		
PUSH	○	○
COLOR	LG	B

WINKER SW

	R	L	WR
L		○	○
R	○		○
COLOR	SB	O	GR

START SW

	ST	C
FREE		
PUSH	○	○
COLOR	Y/R	Y/BR

DIMMER SW

	PO	LO	HI
☰☯☰	○		
☰	○	○	
☰	○		○
COLOR	B	W	L

HAZARD SW

	BAT	HA
△	○	○
●		
COLOR	R	Y/B



Horn Switch

Winker Switch



19. ONLY ATV ON ROAD AVAILABLE

TURN SIGNAL LIGHT (MXU 50 REVERSE/MXU 50)

FRONT

Remove the rubber boot from the turn signal light case.
Remove the bulb socket by turning it counterclockwise.



Bulb Socket

Remove the bulb.

Install the bulb in the reverse order of removal.

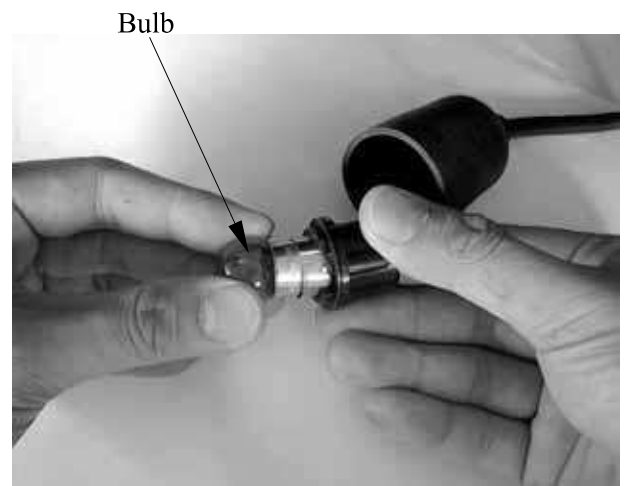

REAR

Remove the bulb socket by turning it counterclockwise.
Remove the bulb.

Install the bulb in the reverse order of removal.

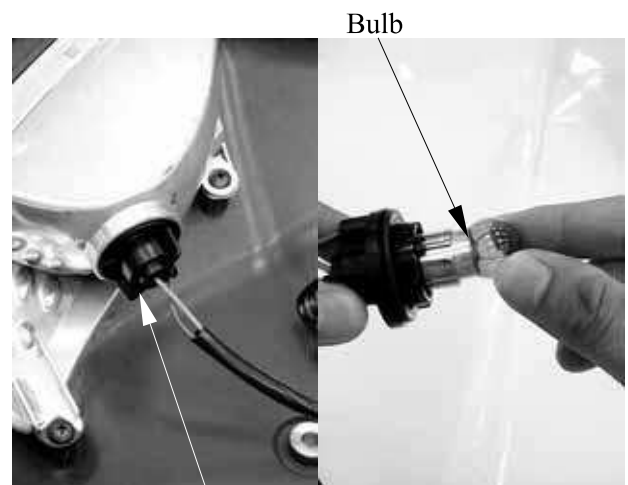

Bulb Socket