PREFACE

This Service Manual describes the technical features and servicing procedures for the KYMCO *PEOPLE 50*.

In this manual, many illustrations and drawings are used to help servicemen have better understanding.

Section 2 contains the service precautions for all operations and troubleshooting stated in this manual. Read them carefully before starting any operation.

Section 3 describes the inspection/adjustment procedures, safety rules and service information for each part, starting from periodic maintenance.

Sections 4 through 16 give instructions for disassembly, assembly and inspection of lubrication system, engine, fuel system and electrical equipment.

Section 17 is the maintenance and inspection directions for the evaporative/exhaust emission control system. Most sections start with an assembly or system illustration and troubleshooting for the section. The subsequent pages give detailed procedures for the section.

• •
The information, specifications, and illustrations included in this manual may be different from the motorcycle in case specifications are changed.

KWANG YANG MOTOR CO., LTD.
OVERSEAS SALES DEPARTMENT
OVERSEAS SERVICE SECTION
JANUARY 1999

TABLE OF CONTENTS

SPECIFICATIONS	1
GENERAL INFORMATION.....	2
INSPECTION/ADJUSTMENT.....	3
LUBRICATION SYSTEM	4
ENGINE REMOVAL/INSTALLATION.....	5
CYLINDER HEAD/CYLINDER/PISTON.....	6
A.C. GENERATOR.....	7
KICK STARTER/DRIVE PULLEY/CLUTCH/DRIVEN PULLEY	8
FINAL REDUCTION	9
CRANKCASE/CRANKSHAFT	10
CARBURETOR.....	11
FRAME COVERS	12
STEERING HANDLEBAR/FRONT WHEEL/FRONT BRAKE/ FRONT SHOCK ABSORBER/FRONT FORK	13
REAR WHEEL/REAR BRAKE/REAR SHOCK ABSORBER	14
ELECTRICAL EQUIPMENT	15
INSTRUMENT/SWITCHES/LIGHTS	16

1. SPECIFICATIONS

SPECIFICATIONS

Name & Model		BA10AB.AC	
Overall length (mm)		1850	
Overall width (mm)		685	
Overall height (mm)		1075	
Wheel base (mm)		1270	
Engine type		Air cooled 2-stroke	
Displacement (cc)		49.5 cc	
Net weight (kg)	Front wheel	37	
	Rear wheel	58.5	
	Total	95.5	
Seating capacity		2 riders (110kg)	
Gross weight(kg)	Front wheel	79	
	Rear wheel	126.5	
	Total	205.5	
Tires	Front wheel	70/90-16 42J	
	Rear wheel	90/90-16 54J	
Ground clearance (mm)		175	
Braking distance (m) (Initial speed Km/h)		4.4m (30km/h)	
Min. turning radius (mm)		1900	
Starting system		Starting motor & kick starter	
Fuel type		Gasoline, 2-stroke motor oil	
Cylinder arrangement		Single cylinder, flat	
Combustion chamber type		Semi-sphere	
Valve arrangement		Reed valve & piston	
Bore x stroke (mm)		39 x 41.4	
Compression ratio		10.3:1 ±0.2	
Compression pressure (kg/cm ² rpm)		11.8kg/cm ² ±2	
Max. output (kw/r/min)		1.765/5400 kw/r/min	
Max. torque (kg m/rpm)		0.33/4600 kg m/rpm	
Port timing	Intake	Open	Automatic controlled
		Close	Automatic controlled
	Exhaust	Open	—
		Close	—
	Scavenge	Open	—
		Close	—
Idle speed (rpm)		2000±100	
Lubrication type		Separate type	
Oil pump type		Plunger type	
Oil filter type		Full-flow filtration	

Lubrication oil capacity (liter)		1.1	
Air cleaner type & No.		Wet, single	
Fuel capacity (liter)		5.8	
Carburetor	Type	Plunger type	
	Piston dia. (mm)	—	
	Venturi dia. (mm)	16	
Ignition system type		CDI electromagnetic Ignition	
Ignition timing F mark		8°~14°±1.5°BTDC/2000 rpm	
Spark plug	NGK	BR8HSA	
	ND	-	
Spark plug gap (mm)		0.6~0.7	
Battery capacity		12V4AH	
Power to transmission gear		Power-transmission gear-clutch	
Reduction ratio of power to transmission		—	
Clutch type		Dry multi-disc clutch	
Transmission gear operation type		Automatic centrifugal type	
Transmission ratio	1 speed	—	
Reduction gear	Type	Two-stage reduction	
	1st reduction ratio	3.113~0.895	
	2nd reduction ratio	14.69	
Transmission gear type		Non-stage transmission	
Tire pressure (kg/cm ²)	Front wheel	1.75 kg/cm ²	
	Rear wheel	2.0 kg/cm ²	
Turning angle		Right & left 45°	
Brake system type	Front wheel	Expanding/hydraulic	
	Rear wheel	Expanding	
Suspension type	Front wheel	Telescope	
	Rear wheel	Unit swing	
Shock absorber type	Front wheel	Telescope	
	Rear wheel	Unit swing	
Frame type		Pipe under bone	

2. GENERAL INFORMATION

GENERAL INFORMATION

ENGINE SERIAL NUMBER/IDENTIFICATION	2- 1
SERVICE PRECAUTIONS	2- 2
SERVICE INFORMATION	2-10
TORQUE VALUES	2-12
SPECIAL TOOLS	2-13
LUBRICATION POINTS	2-15
WIRING DIAGRAM	2-16
CABLE & HARNESS ROUTING.....	2-18
TROUBLESHOOTING	2-22

2. GENERAL INFORMATION

ENGINE SERIAL NUMBER/IDENTIFICATION



Location of Engine Serial Number

2. GENERAL INFORMATION

SERVICE PRECAUTIONS

- Make sure to install new gaskets, O-rings, circlips, cotter pins, etc. when reassembling.

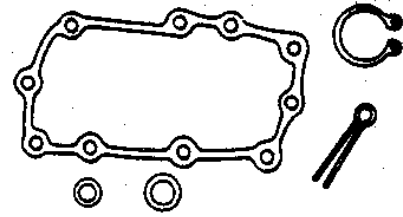

- When tightening bolts or nuts, begin with larger-diameter to smaller ones at several times, and tighten to the specified torque diagonally.

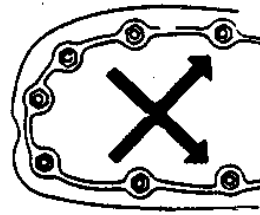

- Use genuine parts and lubricants.

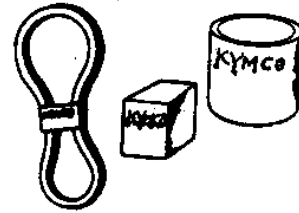

- When servicing the motorcycle, be sure to use special tools for removal and installation.



- After disassembly, clean removed parts. Lubricate sliding surfaces with engine oil before reassembly.

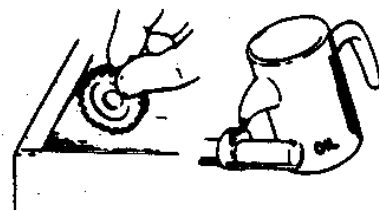

2. GENERAL INFORMATION

- Apply or add designated greases and lubricants to the specified lubrication points.

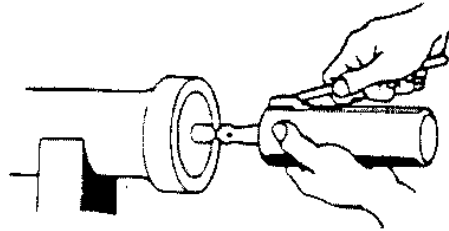

- After reassembly, check all parts for proper tightening and operation.

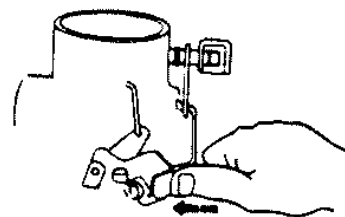

- When two persons work together, pay attention to the mutual working safety.

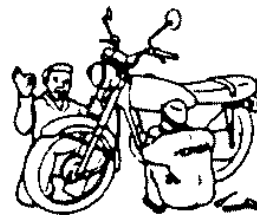

- Disconnect the battery negative (-) terminal before operation.
- When using a spanner or other tools, make sure not to damage the motorcycle surface.

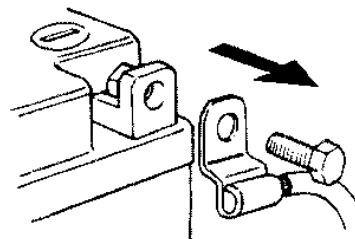

- After operation, check all connecting points, fasteners, and lines for proper connection and installation.
- When connecting the battery, the positive (+) terminal must be connected first.
- After connection, apply grease to the battery terminals.
- Terminal caps shall be installed securely.

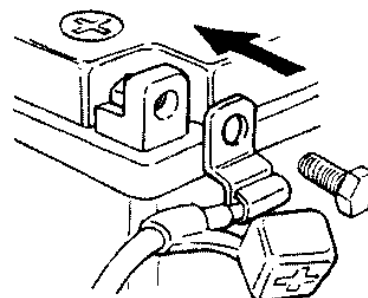

2. GENERAL INFORMATION

- If the fuse is burned out, find the cause and repair it. Replace it with a new one according to the specified capacity.

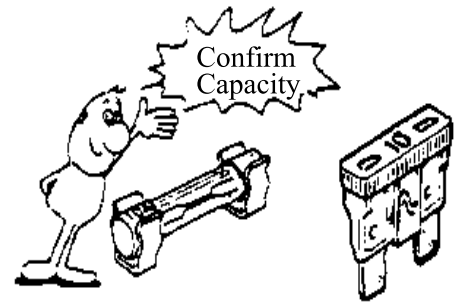

- After operation, terminal caps shall be installed securely.



- When taking out the connector, the lock on the connector shall be released before operation.

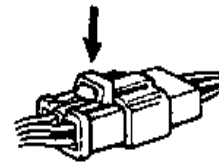

- Hold the connector body when connecting or disconnecting it.
- Do not pull the connector wire.

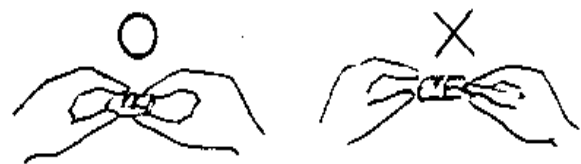

- Check if any connector terminal is bending, protruding or loose.

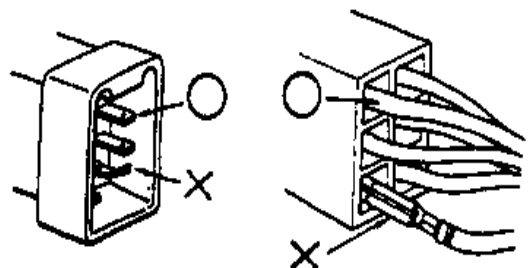

2. GENERAL INFORMATION

- The connector shall be inserted completely.
- If the double connector has a lock, lock it at the correct position.
- Check if there is any loose wire.

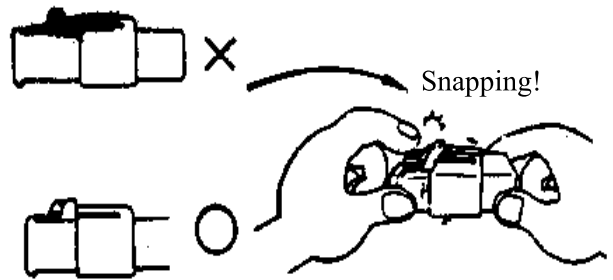

- Before connecting a terminal, check for damaged terminal cover or loose negative terminal.

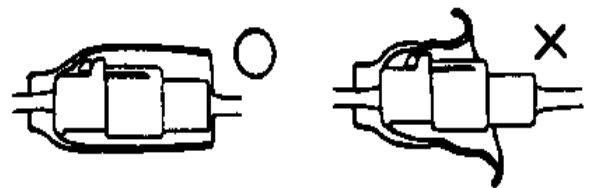

- Check the double connector cover for proper coverage and installation.

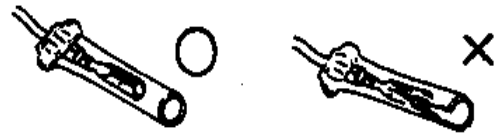

- Insert the terminal completely.
- Check the terminal cover for proper coverage.
- Do not make the terminal cover opening face up.



- Secure wire harnesses to the frame with their respective wire bands at the designated locations. Tighten the bands so that only the insulated surfaces contact the wire harnesses.

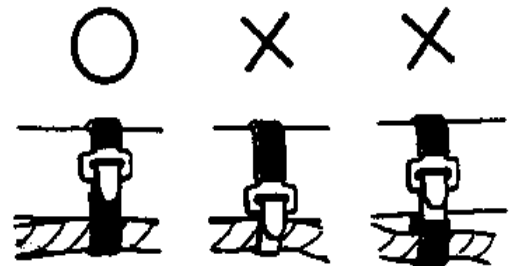

2. GENERAL INFORMATION

- After clamping, check each wire to make sure it is secure.

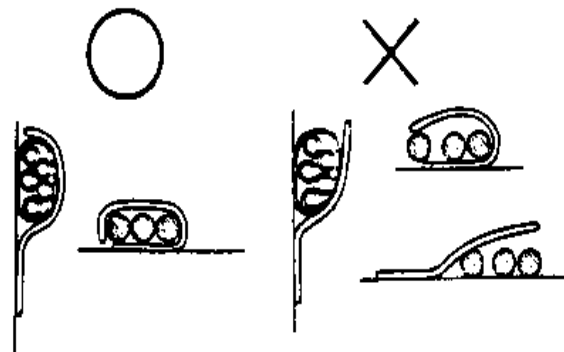

- Do not squeeze wires against the weld or its clamp.

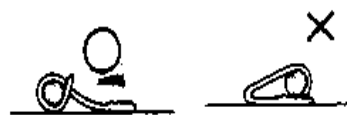

- After clamping, check each harness to make sure that it is not interfering with any moving or sliding parts.

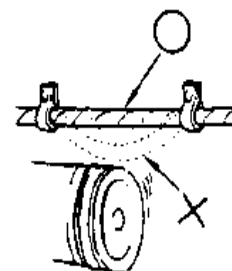

- When fixing the wire harnesses, do not make it contact the parts which will generate high heat.

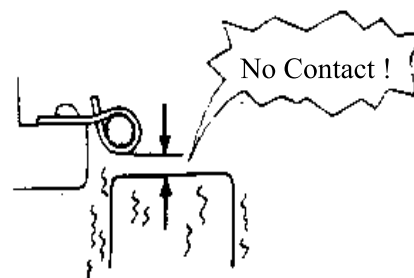

- Route wire harnesses to avoid sharp edges or corners. Avoid the projected ends of bolts and screws.
- Route wire harnesses passing through the side of bolts and screws. Avoid the projected ends of bolts and screws.



2. GENERAL INFORMATION

- Route harnesses so they are neither pulled tight nor have excessive slack.

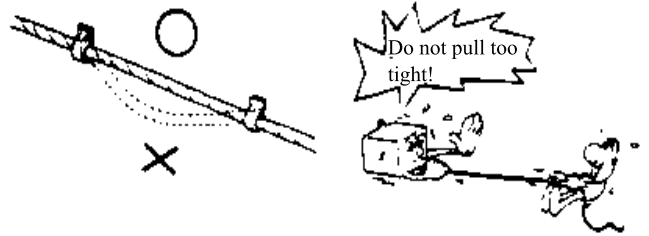

- Protect wires and harnesses with electrical tape or tube if they contact a sharp edge or corner.

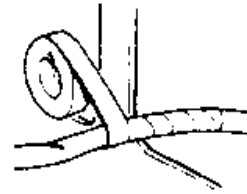

- When rubber protecting cover is used to protect the wire harnesses, it shall be installed securely.

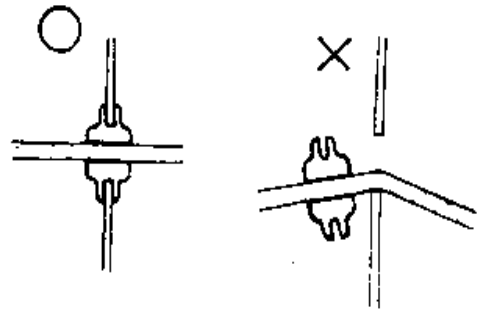

- Do not break the sheath of wire.
- If a wire or harness is with a broken sheath, repair by wrapping it with protective tape or replace it.

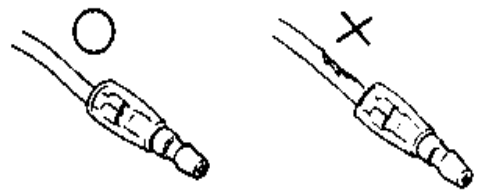

- When installing other parts, do not press or squeeze the wires.

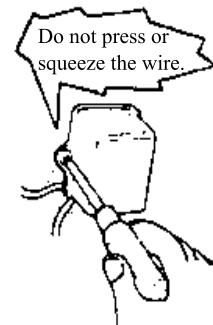

2. GENERAL INFORMATION

- After routing, check that the wire harnesses are not twisted or kinked.

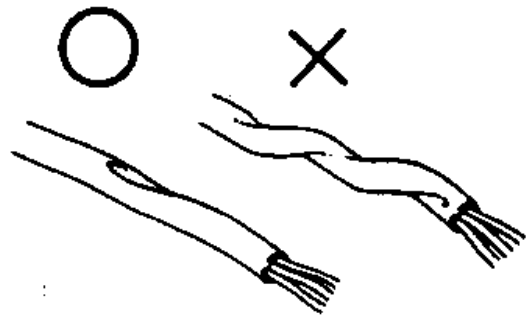

- Wire harnesses routed along with handlebar should not be pulled tight, have excessive slack or interfere with adjacent or surrounding parts in all steering positions.

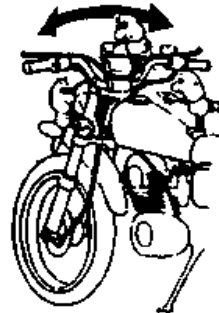

- When a testing device is used, make sure to understand the operating methods thoroughly and operate according to the operating instructions.

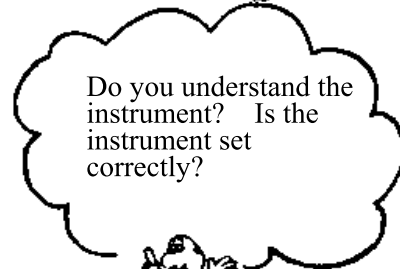

- Be careful not to drop any parts.



- When rust is found on a terminal, remove the rust with sand paper or equivalent before connecting.



2. GENERAL INFORMATION

■ Symbols:

The following symbols represent the servicing methods and cautions included in this service manual.



: Apply engine oil to the specified points. (Use designated engine oil for lubrication.)



: Apply grease for lubrication.



: Use special tool.



: Caution



: Warning

2. GENERAL INFORMATION

SERVICE INFORMATION

ENGINE	Standard (mm)	Service Limit (mm)
Item	BA10AB.AC.	BA10AB.AC.
Cylinder head warpage	—	0.10
Piston O.D.(5mm from bottom of piston skirt)	38.970~38.955	38.90
Cylinder-to- piston clearance		0.10
Piston pin hole I.D.	12.002~12.008	12.03
Piston pin O.D.	11.994~12.0	11.98
Piston-to-piston pin clearance	←	←
Piston ring end gap (top/second)	0.10~0.25	0.40
Connecting rod small end I.D.	17.005~17.017	17.03
Cylinder bore	39.0~39.025	39.05
Drive belt width	18	17
Drive pulley collar O.D.	20.01~20.025	←
Movable drive face ID.	20.035~20.085	19.97
Weight roller O.D.	13.0	12.4
Clutch outer I.D.	107~107.2	107.5
Driven face spring free length	87.9	82.6
Driven face O.D.	←	←
Movable driven face I.D.	←	←
Connecting rod big end side clearance	←	←
Connecting rod big end radial clearance	←	←
Crankshaft runout A/B	—	←

CARBURETOR	BA10AB.AC
Venturi dia.	14mm
Identification number	PB058[A]
Float level	8.6mm
Main jet	#85
Slow jet	#35
Air screw opening	1¼ ± ½
Idle speed	2000±100rpm
Throttle grip free play	2~6mm
Jet needle clip notch	1st notch

2. GENERAL INFORMATION

FRAME		Standard (mm)	Service Limit (mm)
Item		BA10AB.AC.	BA10AB.AC.
Axle shaft runout		—	0.2
Front wheel rim runout	Radial		
	Axial		
Front shock absorber spring free length		200.0	182.8
Rear wheel rim runout			2.0
Brake drum I.D.	Front/rear	110	111
Brake lining thickness	Front/rear	4.0/4.0	2.0/2.0
Brake disk runout	Front/rear	—	0.30
Rear shock absorber spring free length		235.7	218.7

ELECTRICAL EQUIPMENT			BA10AB.AC
Battery	Capacity		12V4AH
	Voltage		13.0~13.2V
	Charging current	Standard	0.4A/5H
		Quick	4A/0.5H
Spark plug	(NGK)		BR8HSA
Spark plug gap			0.6~0.7mm
Ignition coil resistance	Primary coil		0.153~0.187Ω
	Secondary coil (with plug cap)		6.99~10.21KΩ
	Secondary coil (without plug cap)		3.24~3.96KΩ
Pulser coil resistance (20°C)			80~160Ω
Ignition timing			8°~14°±1.5°BTDC/2000rpm

2. GENERAL INFORMATION

TORQUE VALUES

ENGINE

Item	Thread dia. (mm)	Torque (kg-m)	Remarks
Cylinder head bolt	BF7x115	1.5~1.7	(cold)
Clutch drive plate nut	10	3.5~4.0	
Clutch outer nut	NH10	3.5~4.5	
Drive face nut	NH12	5.0~6.0	
Oil check bolt	10	1.0~1.5	
Engine mounting bolt	BF10x95	4.5~5.5	
Engine hanger bracket bolt	BF10x50	3.5~4.5	
Exhaust muffler joint lock nut	NC6mm	1.0~1.4	
Exhaust muffler lock bolt	BF8x35	3.0~3.6	
Spark plug		1.1~1.7	(cold)

FRAME

Item	Thread dia. (mm)	Torque (kg-m)	Remarks
Handlebar lock nut	10	4.5~5.0	Flange bolt/U-nut
Steering stem lock nut	25.4	8.0~12.0	
Steering top cone race	25.4	0.5~1.3	
Front axle nut	12	5.0~7.0	Flange U-nut
Rear axle nut	16	11.0~13.0	Flange U-nut
Rear brake arm bolt			Flange nut
Front shock absorber:			
upper mount bolt	8	3.3	Flange bolt/U-nut
lower mount bolt		3.3	Cross head
hex bolt		1.5~3.0	Apply locking agent
Front damper nut	8	1.5~3.0	
Front pivot arm bolt			Flange screw/U-nut
Rear shock absorber:			
upper mount bolt	10	3.5~4.5	Flange nut
lower mount bolt	8	2.4~3.0	
lower joint nut	8	1.5~2.5	

Torque specifications listed above are for important fasteners. Others should be tightened to standard torque values below.

STANDARD TORQUE VALUES

SH bolt: 8mm

Flange 6mm bolt

Item	Torque (kg-m)	Item	Torque (kg-m)
5mm bolt, nut	0.45~0.6	5mm screw	0.35~0.5
6mm bolt, nut	0.8~1.2	6mm screw, SH bolt	0.7~1.1
8mm bolt, nut	1.8~2.5	6mm flange bolt, nut	1.0~1.4
10mm bolt, nut	3.0~4.0	8mm flange bolt, nut	2.4~3.0
12mm bolt, nut	5.0~6.0	10mm flange bolt, nut	3.5~4.5

2. GENERAL INFORMATION

SPECIAL TOOLS

Tool Name	Tool No.	Remarks
Universal bearing puller		Crankshaft bearing removal
Lock nut wrench, 39mm		Drive pulley disassembly/assembly
Lock nut socket wrench		Top cone race holding
Lock nut wrench,		Stem lock nut tightening
Crankcase puller		Crankcase disassembly
Bearing remover set, 12mm (Spindle assy, 15mm) (Remover weight)		Drive shaft bearing removal/installation
Bearing remover set, 15mm (Spindle assy, 15mm) (Remover head, 15mm) (Remover shaft, 15mm)		Drive shaft bearing removal/installation
Bearing outer driver, 28x30mm		Bearing installation
Bearing remover		Driven pulley outer bearing installation
Clutch spring compressor		Driven pulley disassembly/assembly
Crankcase assembly collar		Driven shaft, crankshaft & crankcase assembly
Crankcase assembly tool		Crankshaft & crankcase assembly
Rear shock absorber remover		Front shock absorber disassembly/assembly
Ball race remover		Steering stem bearing races
Rear shock absorber compressor		Rear shock absorber disassembly/assembly
Float level gauge		Carburetor fuel level check
Lock nut socket wrench, 32mm		One-way clutch lock nut removal/installation
Universal holder		Flywheel holding
Flywheel puller		Flywheel removal
Pilot, 12mm		Drive shaft bearing installation
Bearing outer driver, 32x35mm		Drive shaft bearing installation Final shaft bearing installation

2. GENERAL INFORMATION

Tool Name	Tool No.	Remarks
Bearing outer driver, 37x40mm		Drive shaft bearing installation Final shaft bearing installation Crankshaft bearing installation
Outer driver, 24x26mm		Driven pulley bearing installation
Pilot, 10mm		Front wheel bearing installation
Bearing driver pilot, 17mm		Drive shaft bearing installation
Snap ring pliers (close)		Circlip removal/installation
Bearing outer driver, 42x47mm		Crankshaft bearing installation
Pilot, 20mm		Crankshaft bearing installation
Bearing outer driver handle A		Bearing installation Drive in ball race
Bearing puller head, 10mm		Front wheel bearing removal
Universal bearing puller		Crankshaft bearing removal
Bearing puller		Front wheel bearing removal
Pressure tester set		Cylinder compression gauge

2. GENERAL INFORMATION

LUBRICATION POINTS

ENGINE

NO.	Lubrication Points	Lubricant	Remarks
1	Crankcase sliding & movable	JASO-FC or API-TC	
2	Cylinder movable parts		
3	Transmission gear (final gear)	SAE-90#	
4	Kick starter spindle bushing	Grease	
5	Drive pulley movable parts	Grease	
6	Starter pinion movable parts	Grease	

FRAME

Apply clean engine oil or grease to cables and movable parts not specified. This will avoid abnormal noise and rise the durability of the motorcycle.

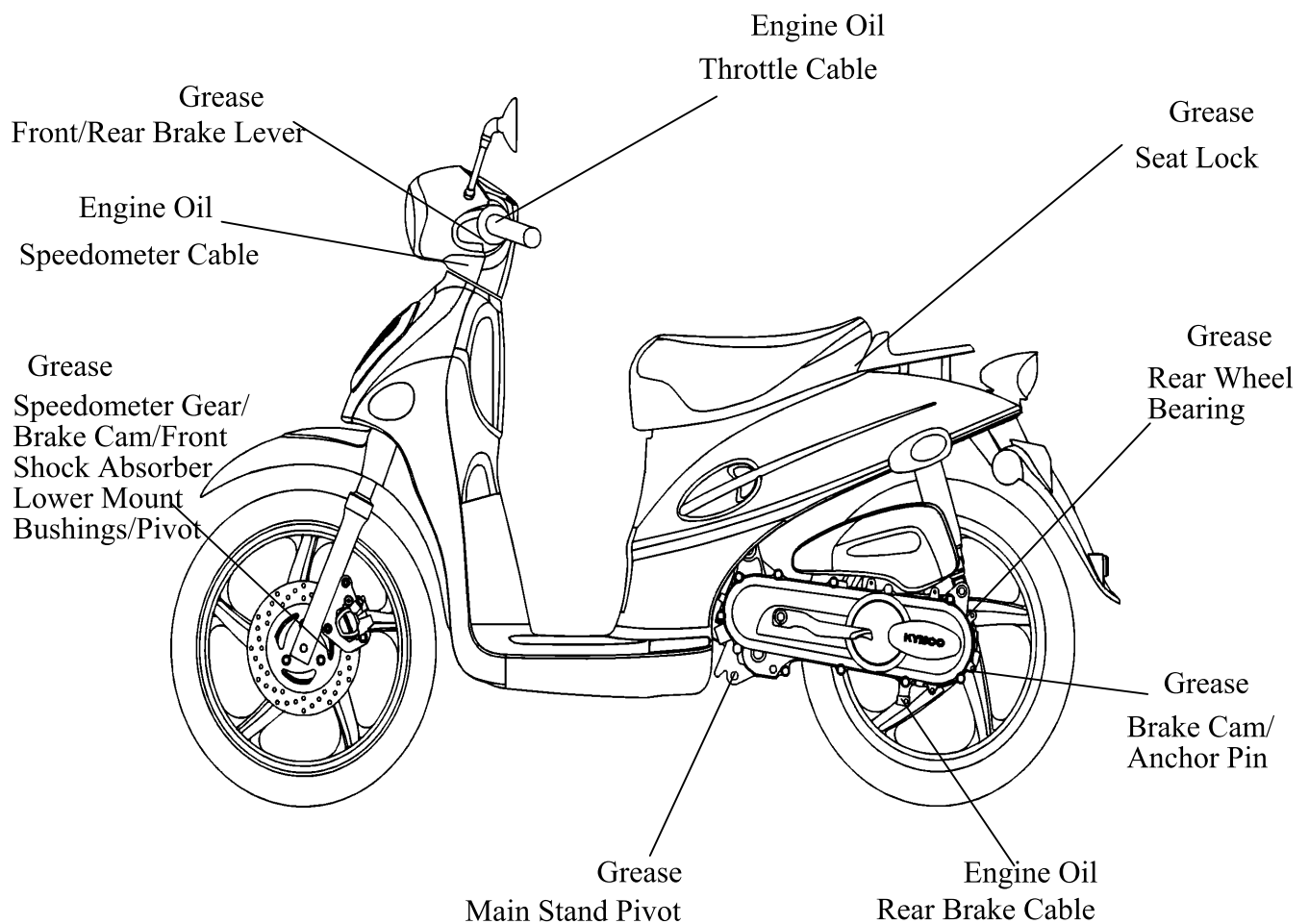

2. GENERAL INFORMATION

BA10AB.AC. WIRING DIAGRAM

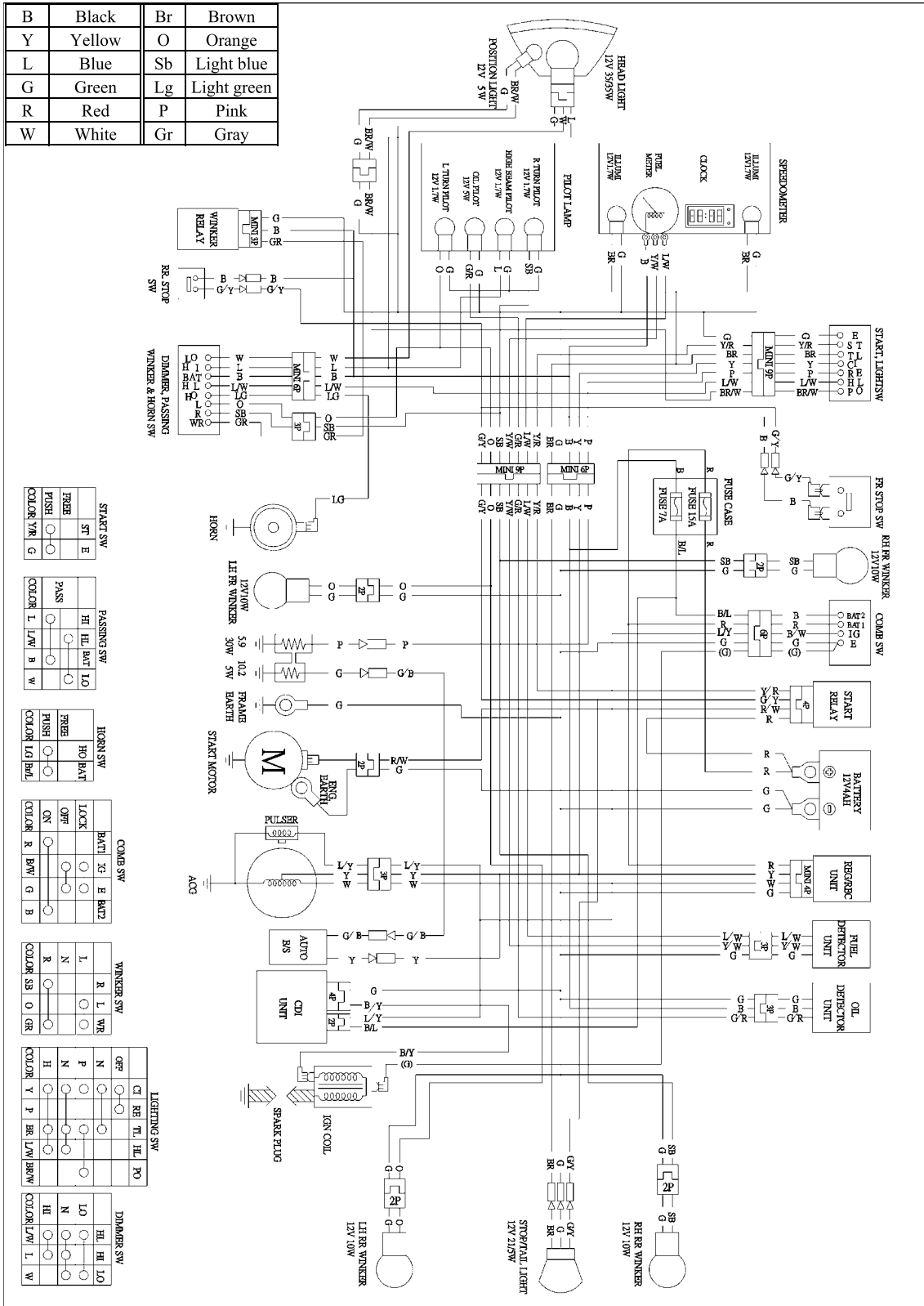

2. GENERAL INFORMATION

CABLE & HARNESS ROUTING

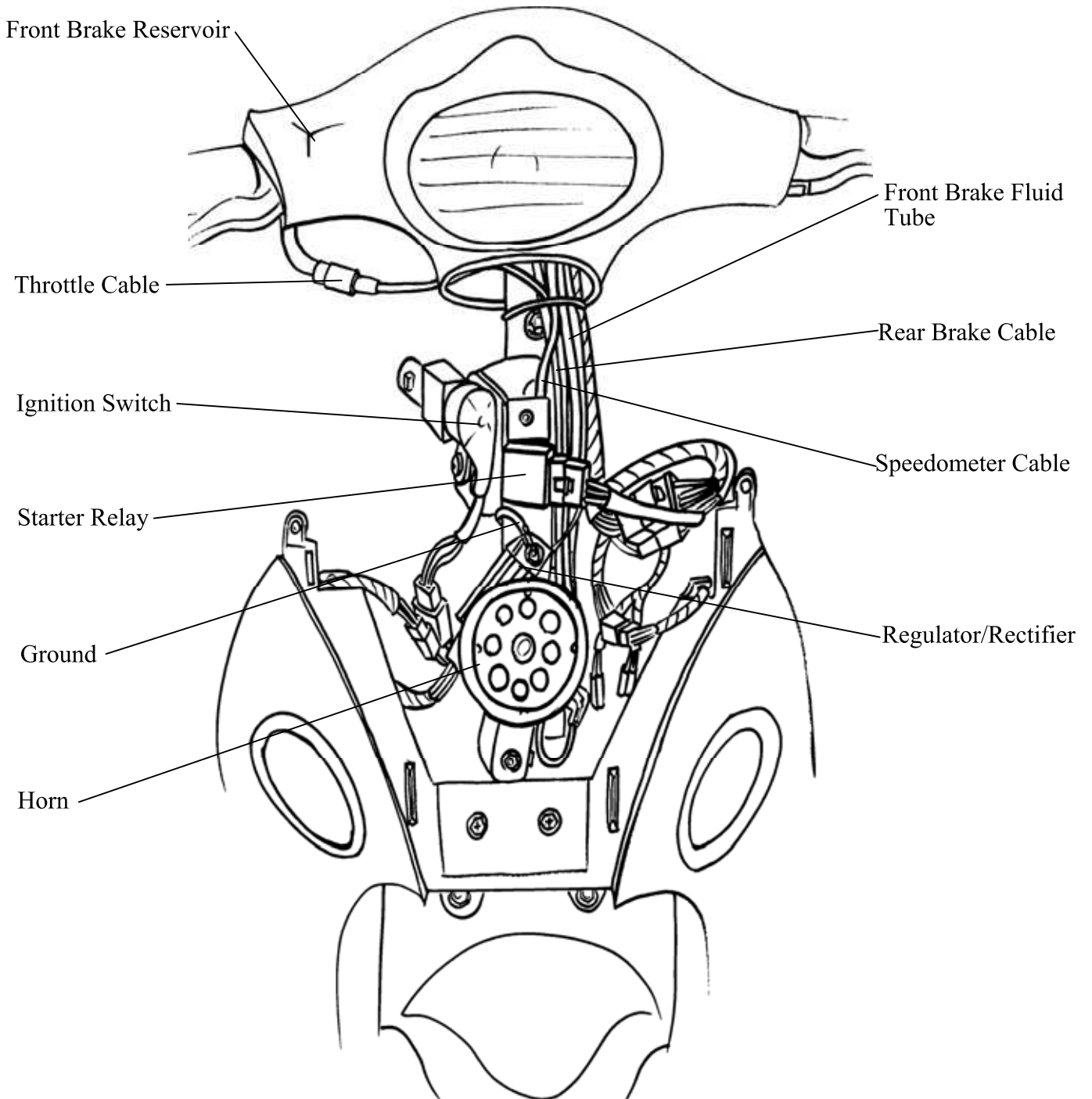

2. GENERAL INFORMATION

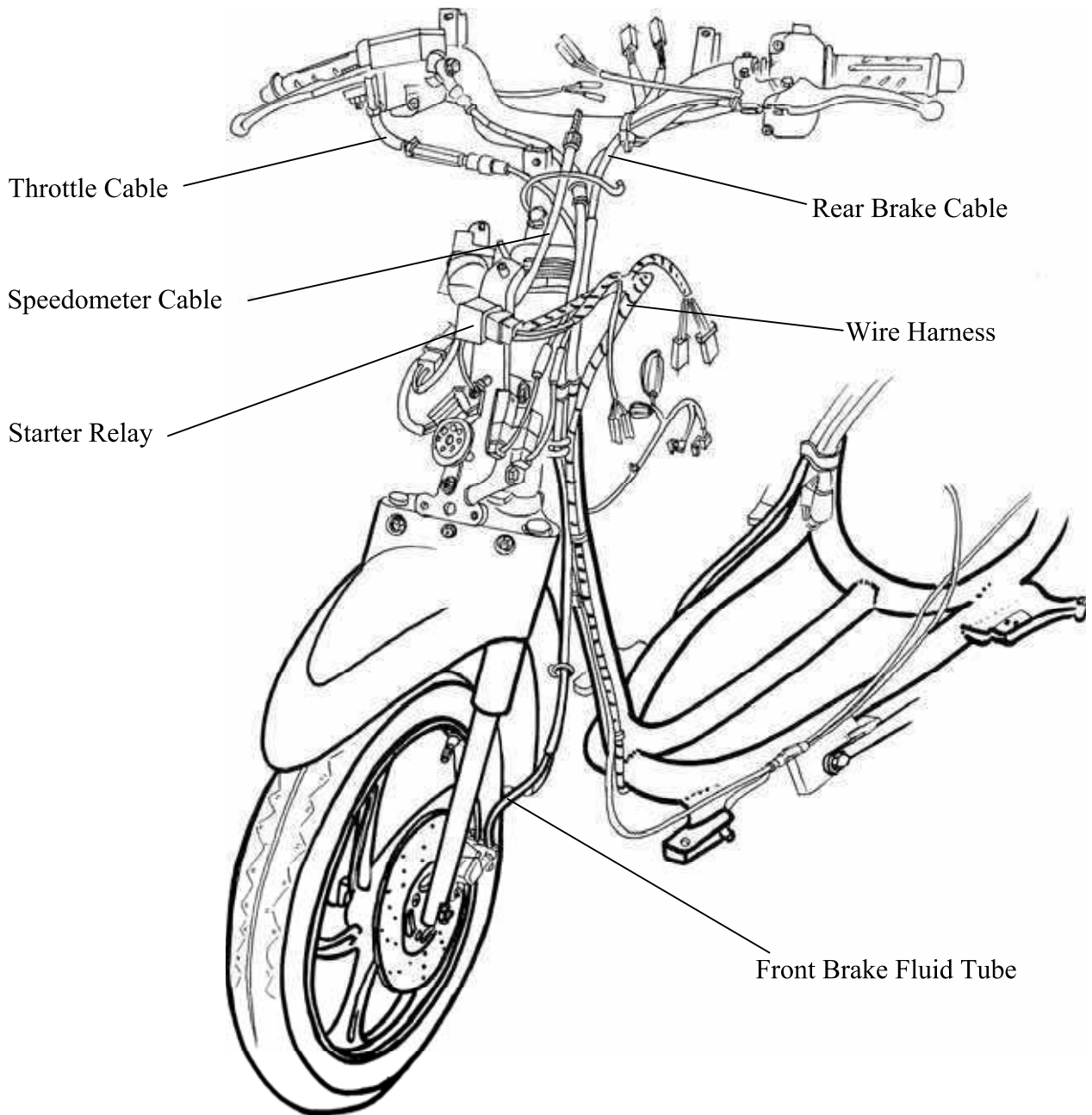

2. GENERAL INFORMATION

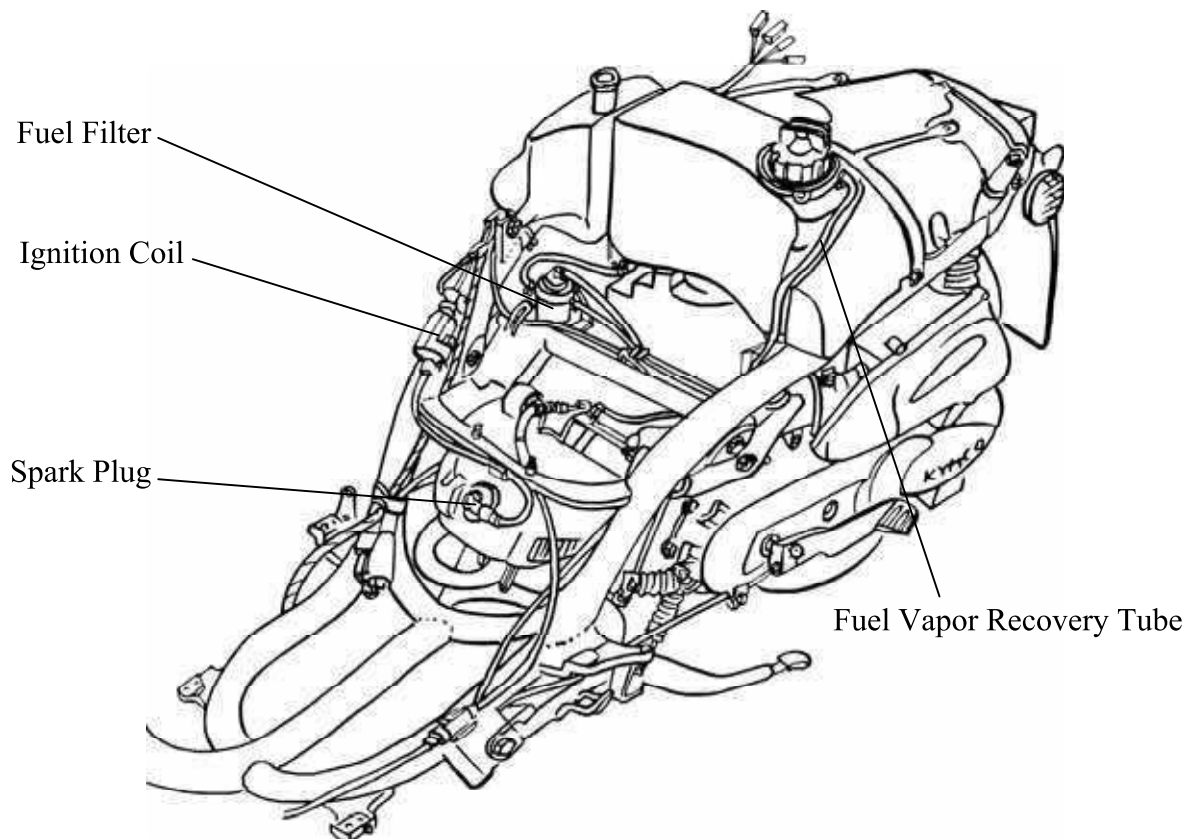
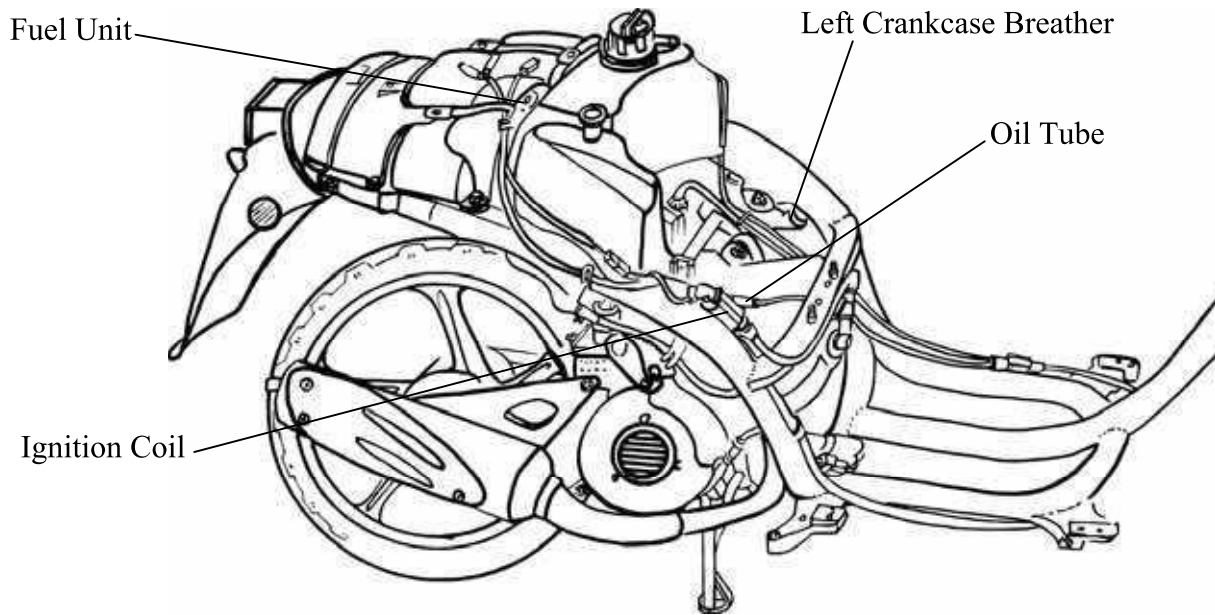

2. GENERAL INFORMATION

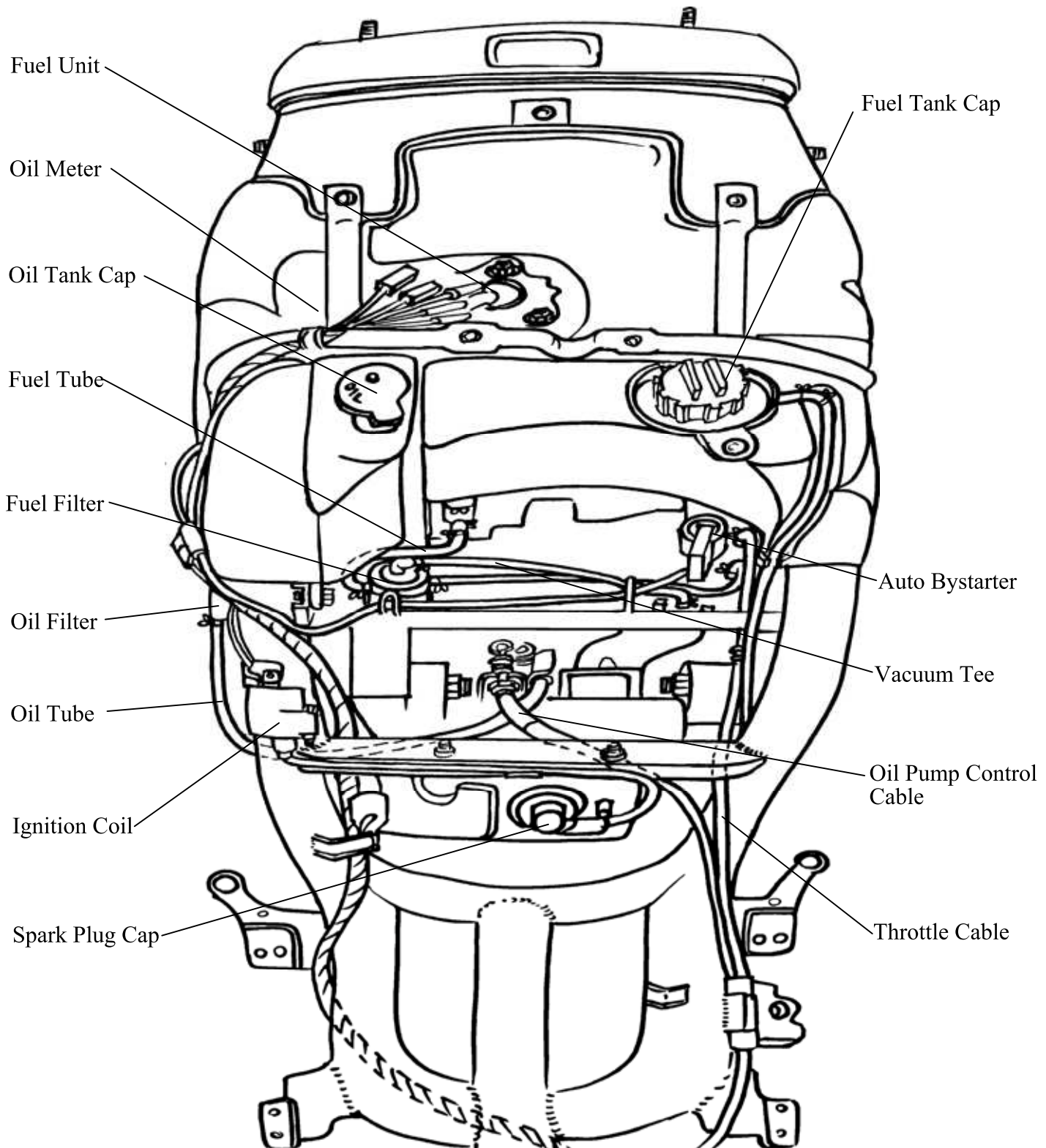

2. GENERAL INFORMATION

TROUBLESHOOTING

ENGINE WILL NOT START OR IS HARD TO START

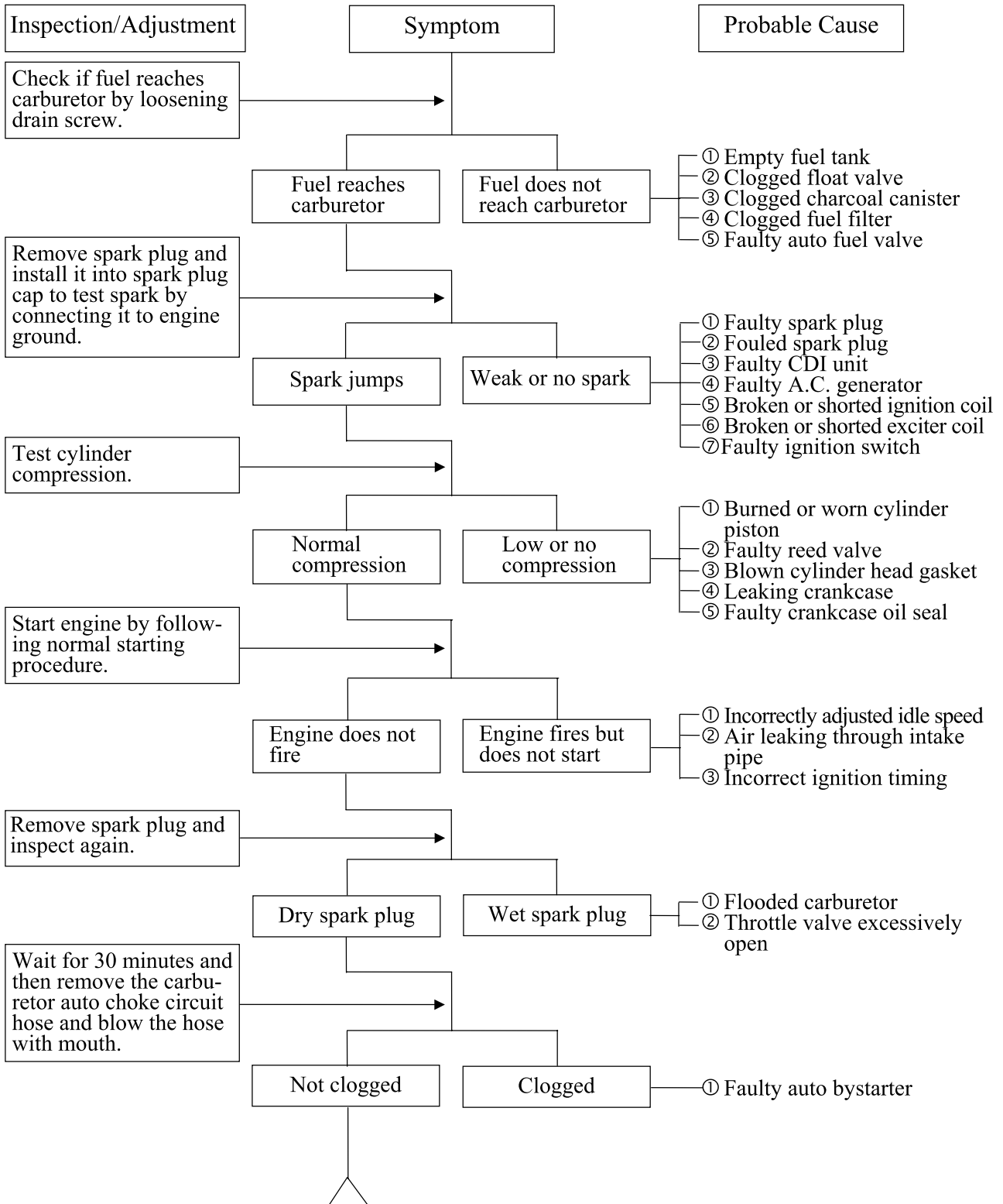

2. GENERAL INFORMATION

ENGINE STOPS IMMEDIATELY AFTER IT STARTS

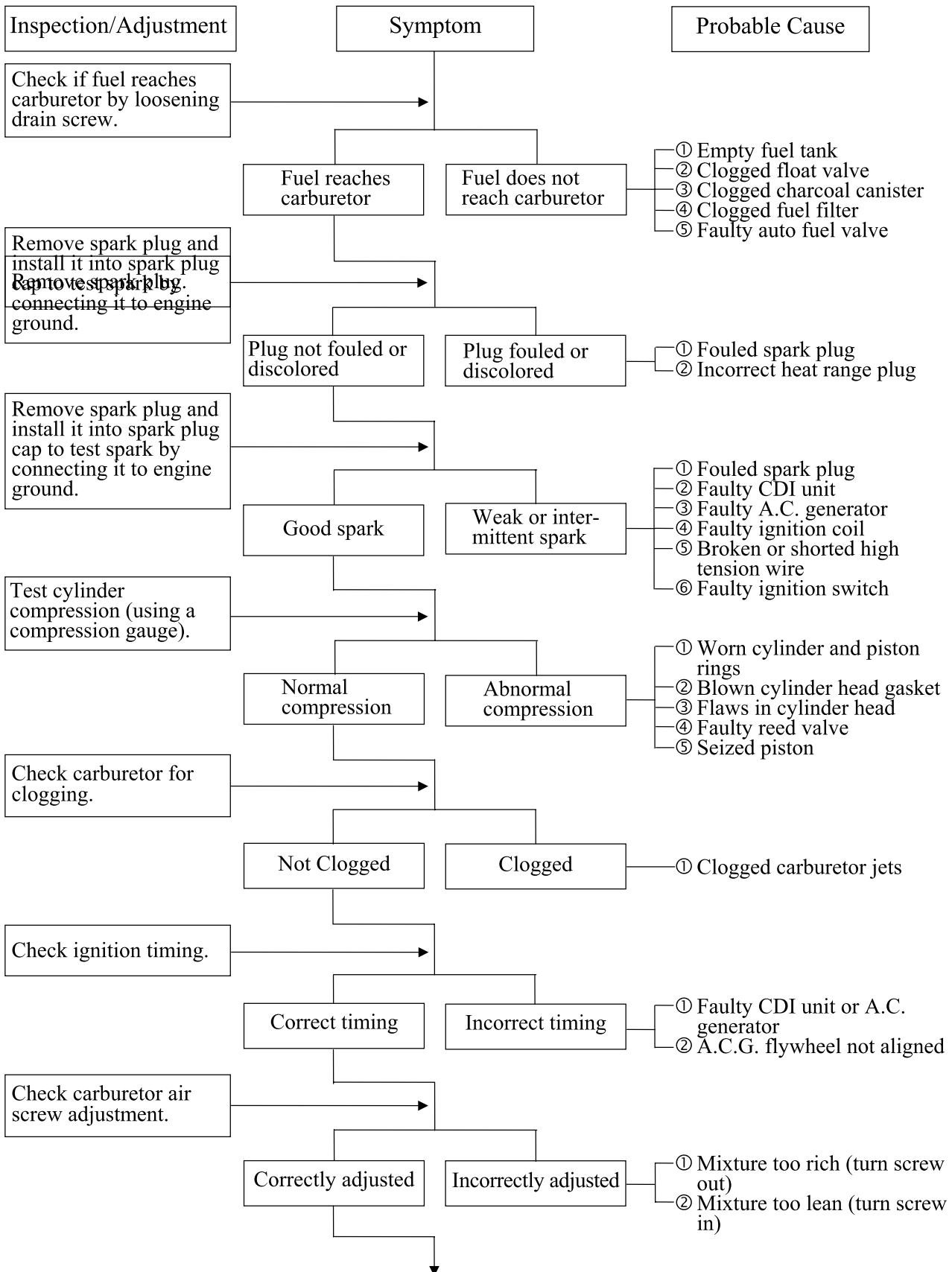

2. GENERAL INFORMATION

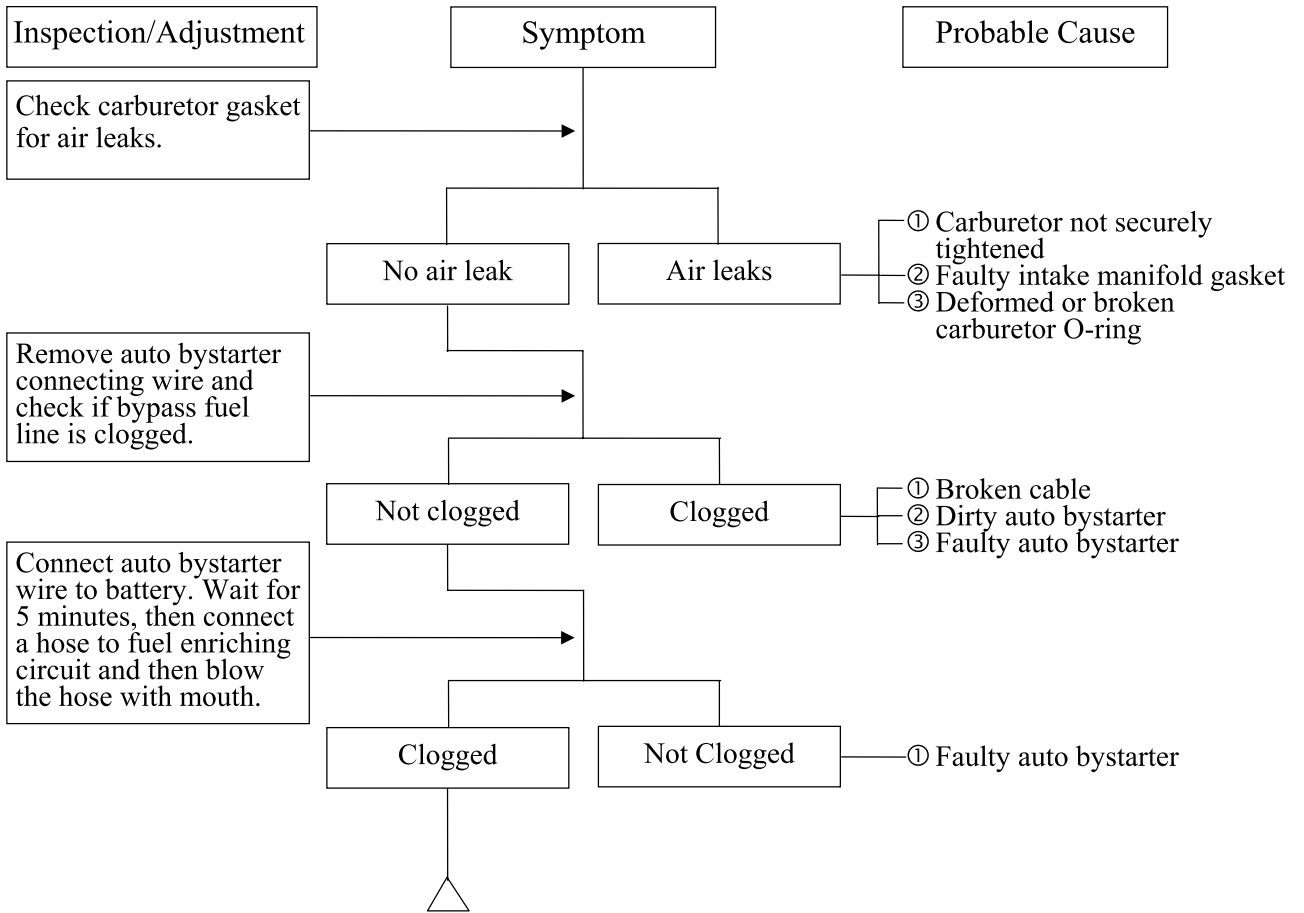

2. GENERAL INFORMATION

ENGINE LACKS POWER

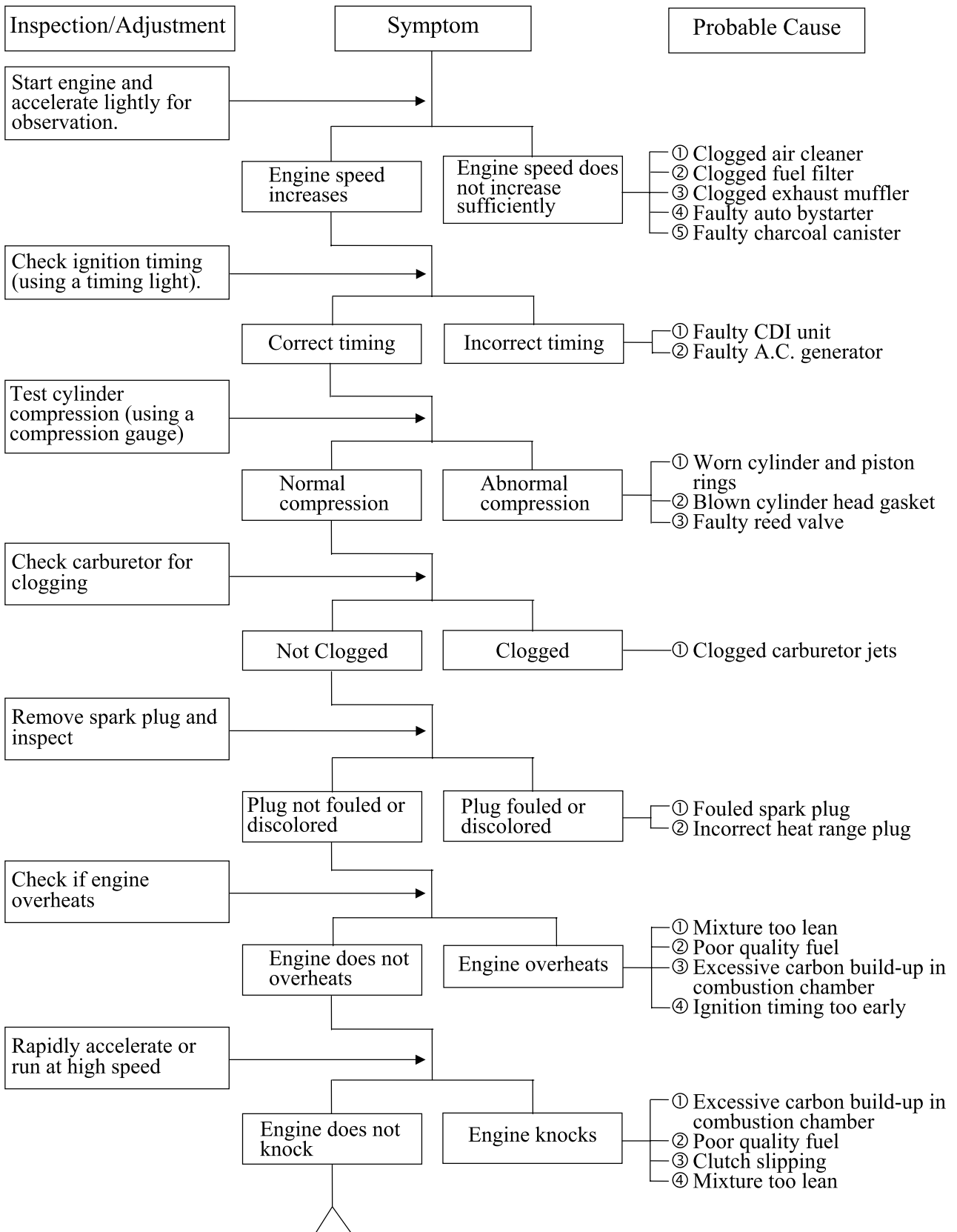

2. GENERAL INFORMATION

POOR PERFORMANCE (ESPECIALLY AT IDLE AND LOW SPEEDS)

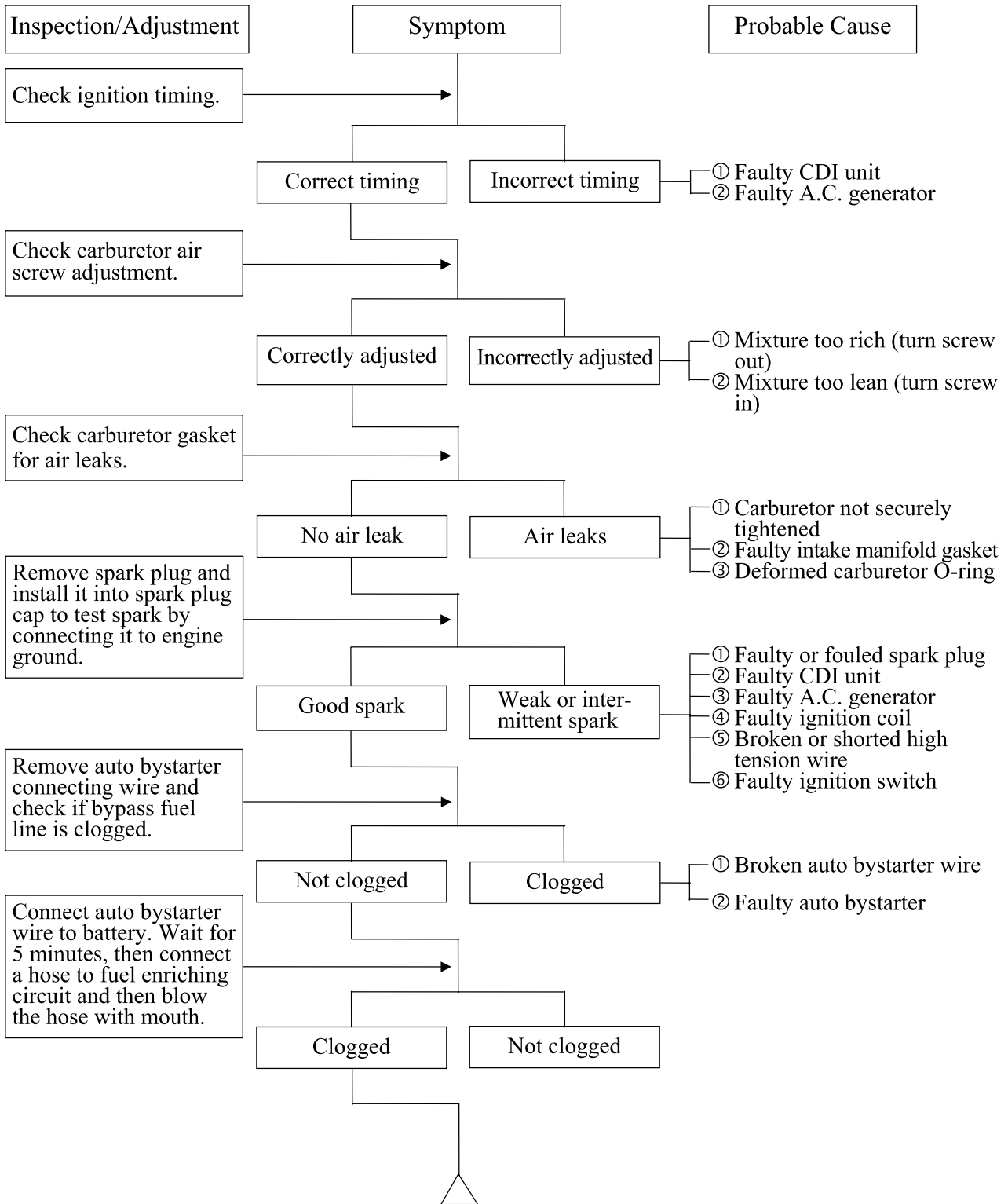

2. GENERAL INFORMATION

POOR PERFORMANCE (AT HIGH SPEED)

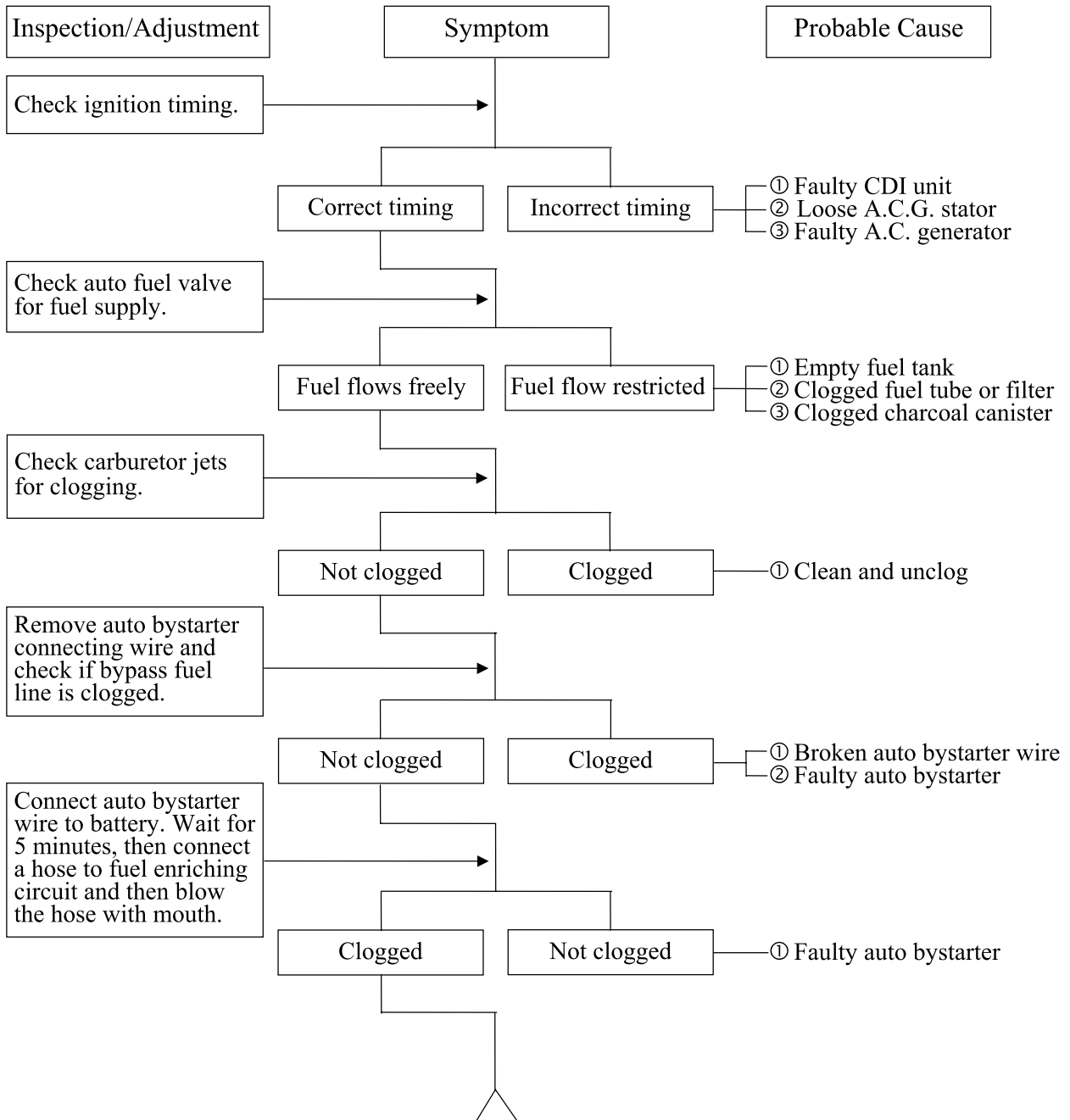

2. GENERAL INFORMATION

CLUTCH, DRIVE AND DRIVEN PULLEYS

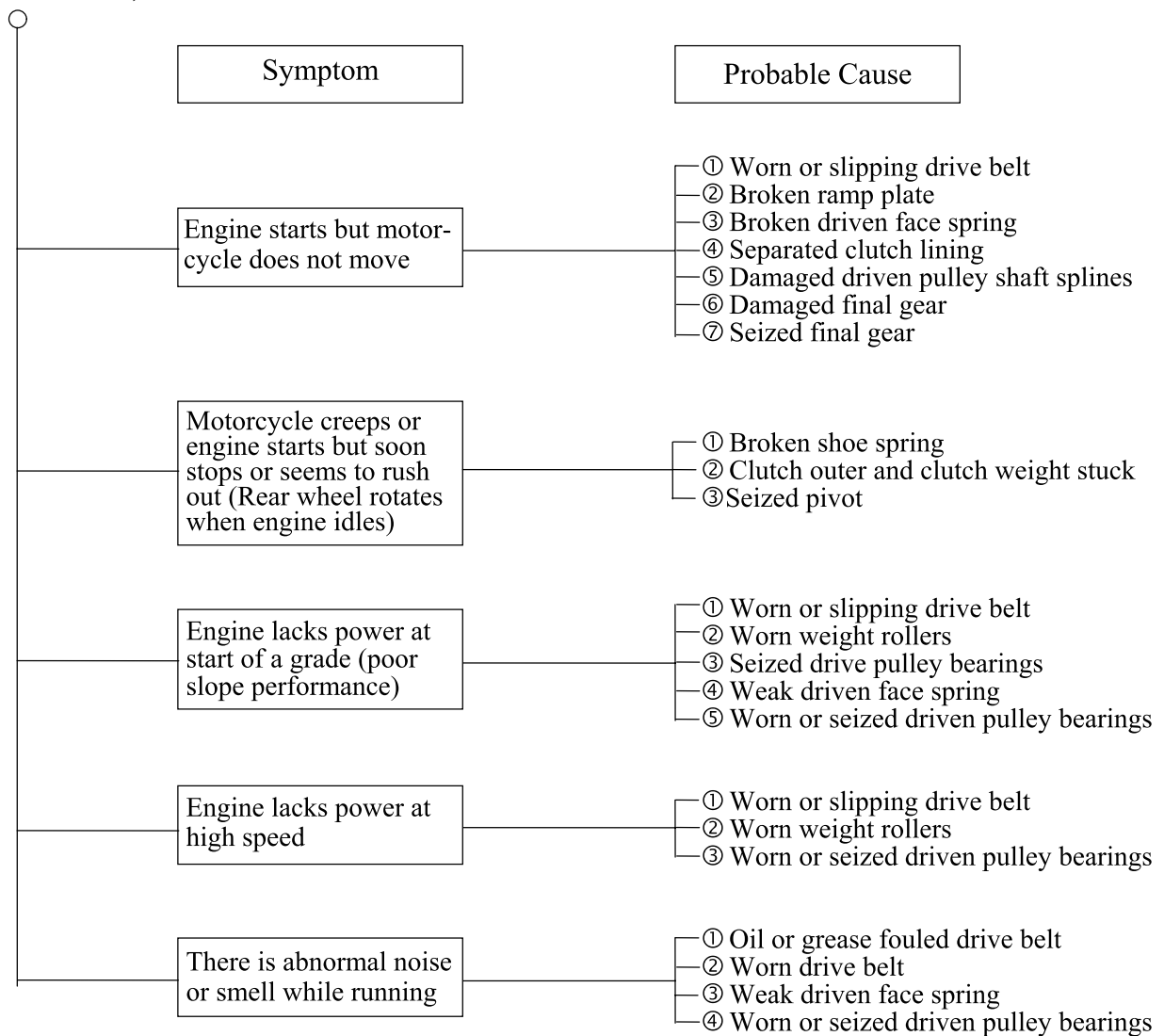

STEERING HANDLEBAR DOES NOT TRACK STRAIGHT

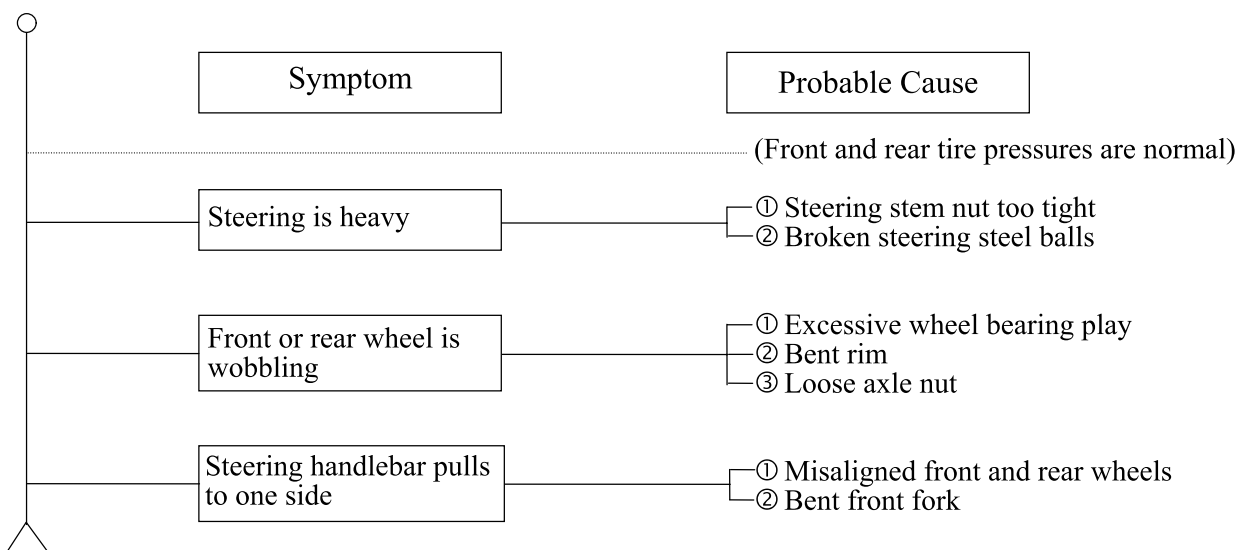

2. GENERAL INFORMATION

POOR SUSPENSION PERFORMANCE

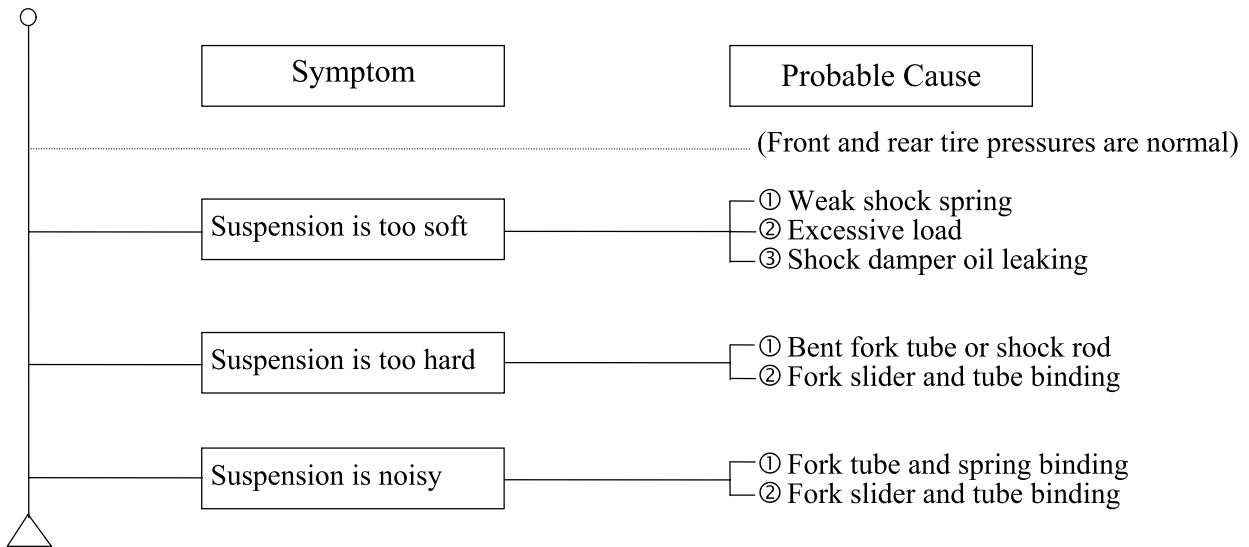

POOR BRAKE PERFORMANCE

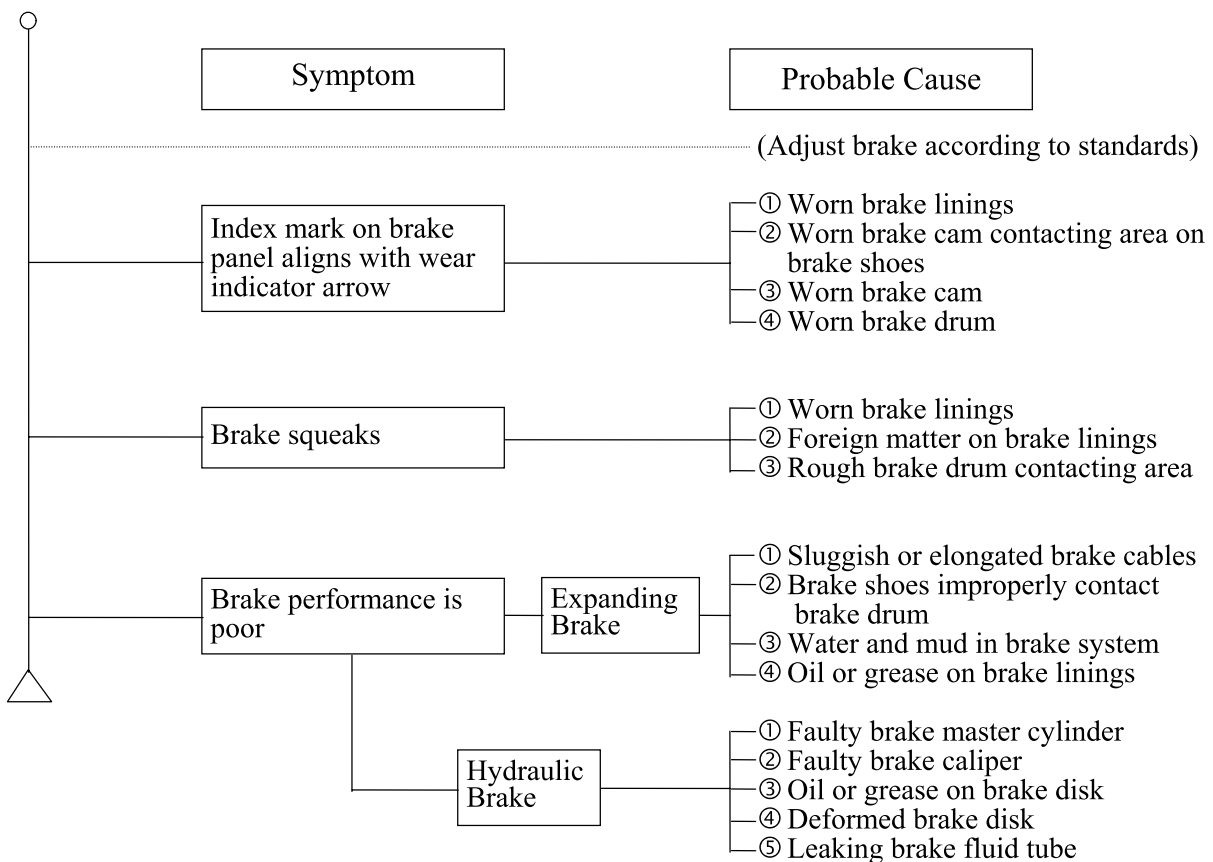

2. GENERAL INFORMATION

OIL METER

1. Motor oil indicator light does not come on when there is no motor oil (Ignition switch ON)

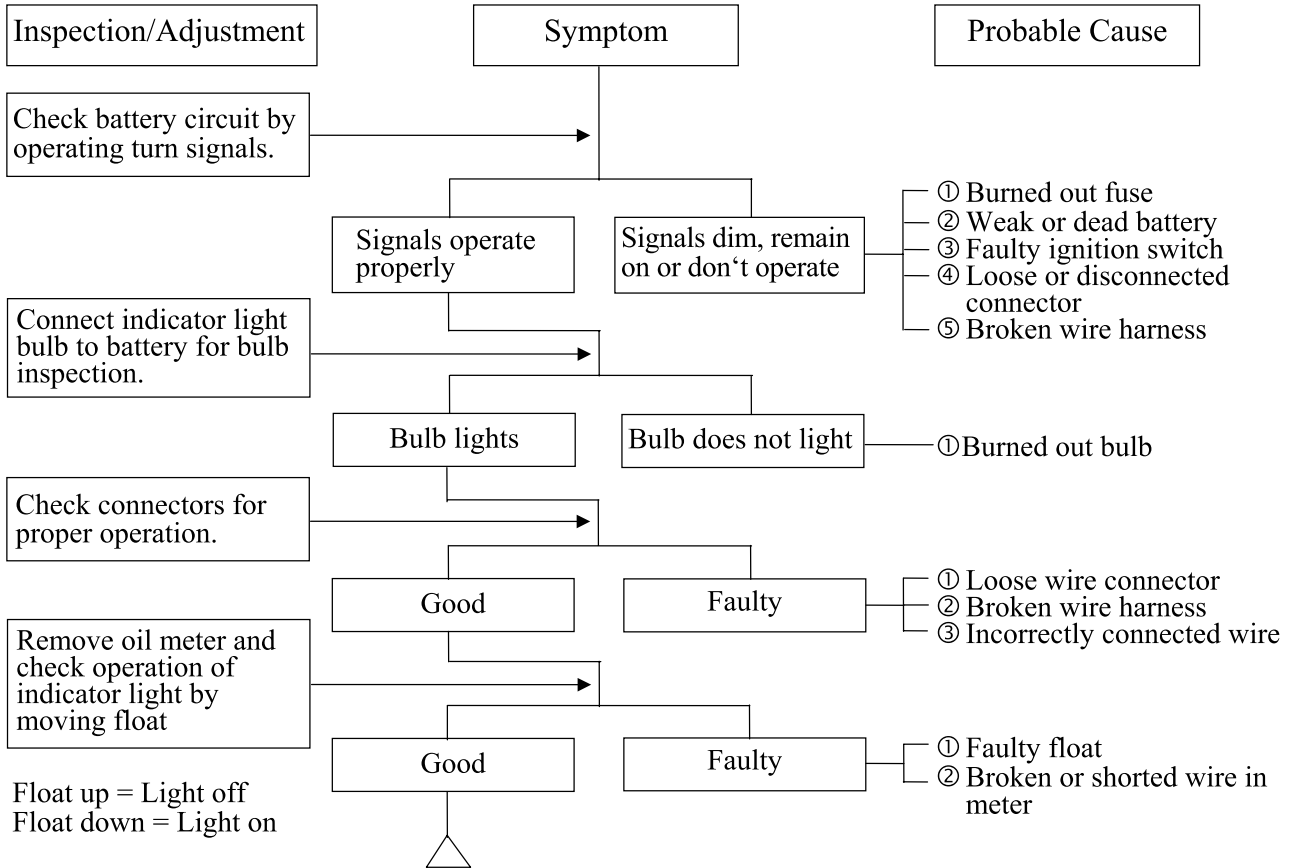

2. Motor oil is sufficient but the indicator light remains on (Ignition switch ON)

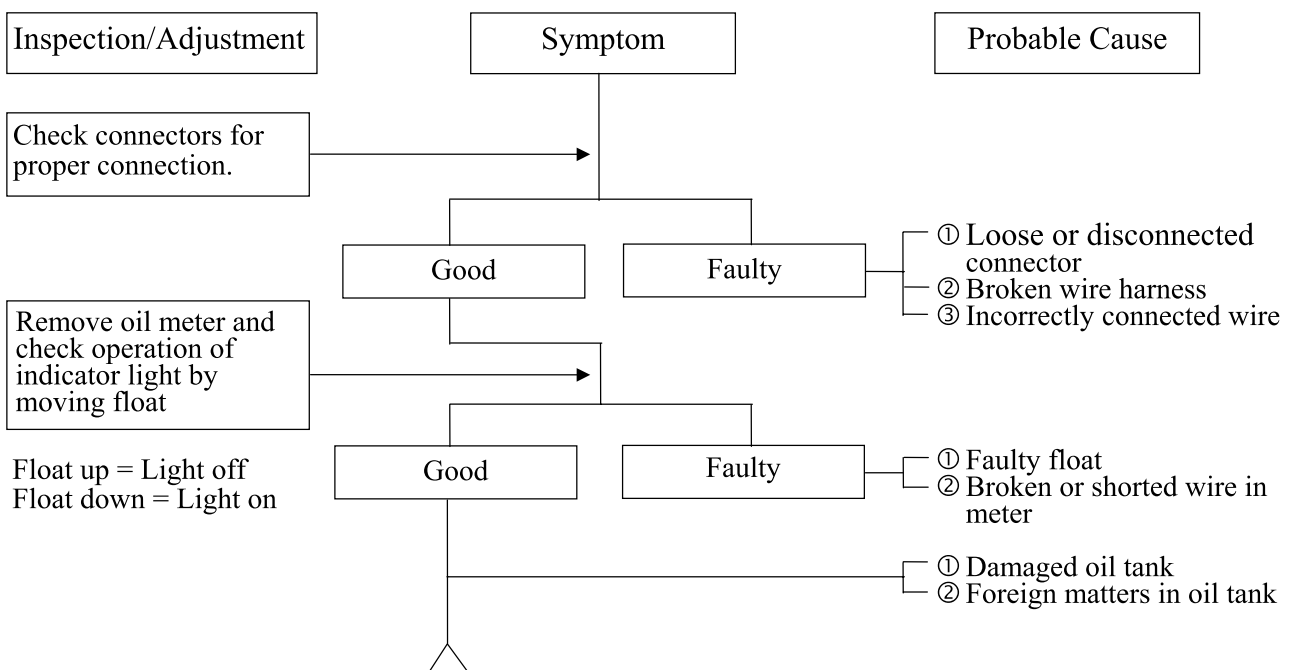

2. GENERAL INFORMATION

FUEL GAUGE

1. Pointer does not register correctly (Ignition switch ON)

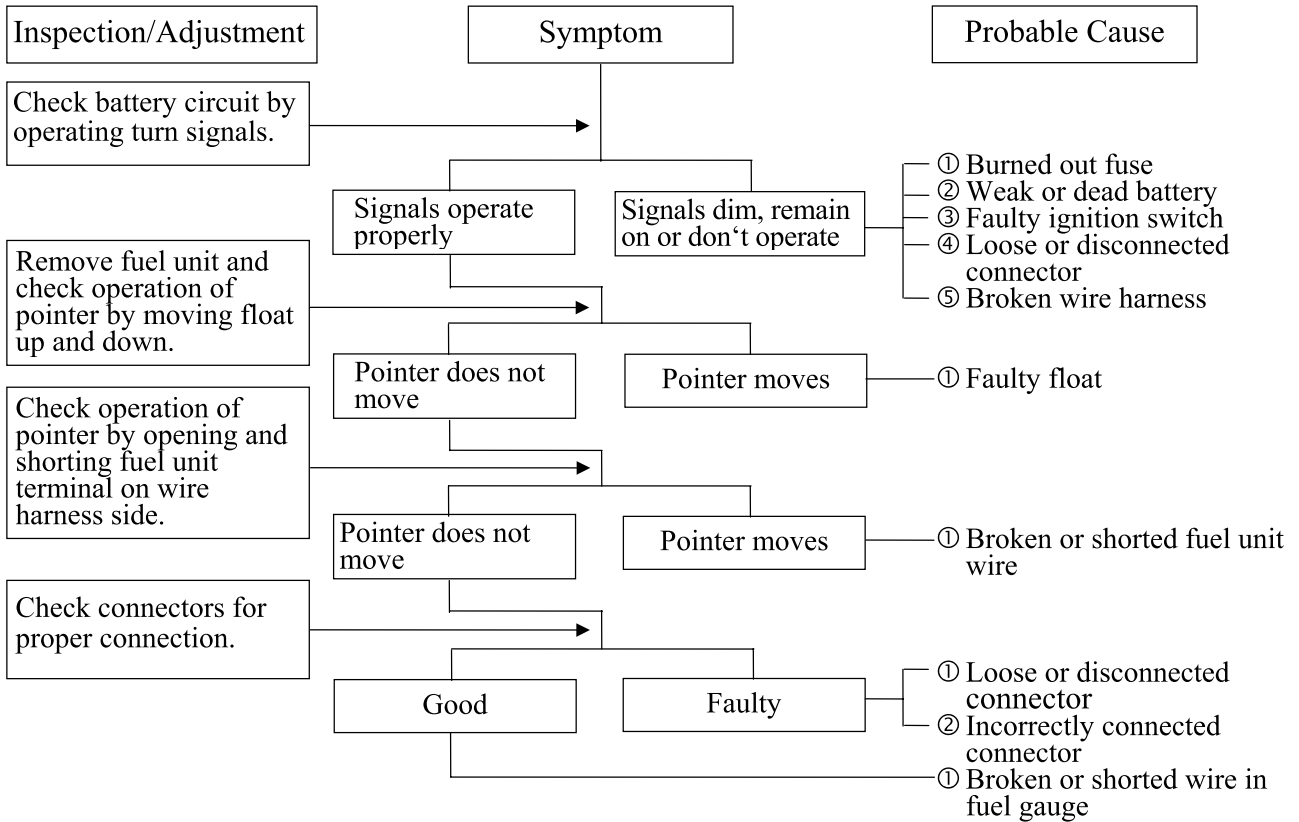

2. Pointer fluctuates or swings (Ignition switch ON)

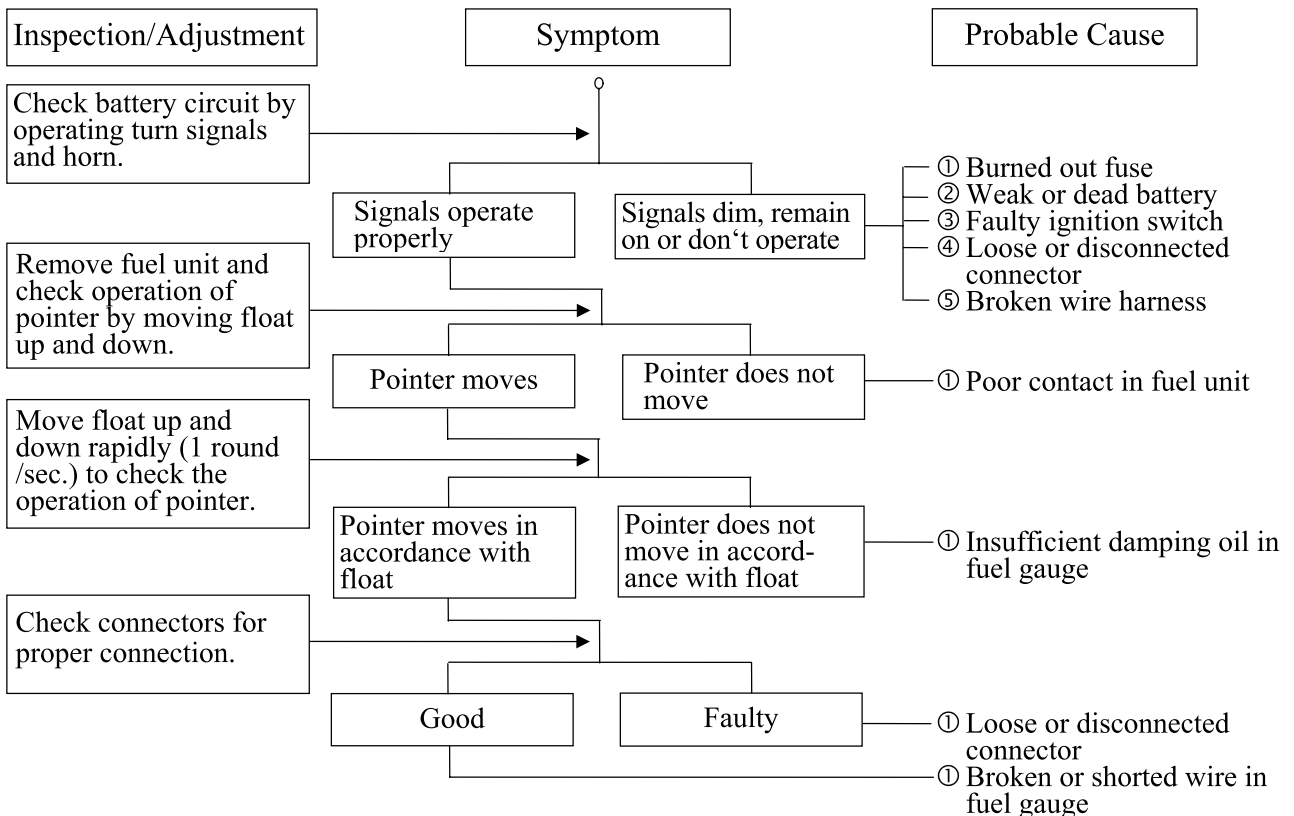

2. GENERAL INFORMATION

STARTER MOTOR

1. Starter motor won't turn

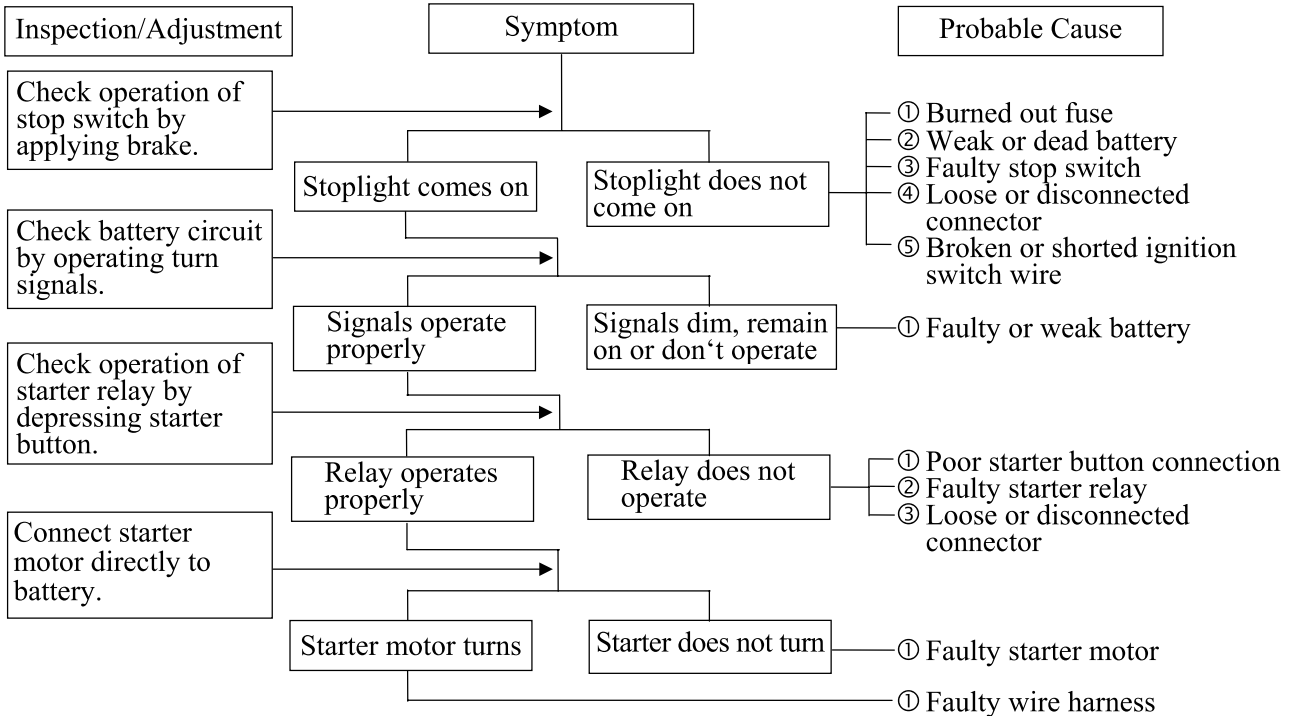

2. Starter motor turns slowly or idles

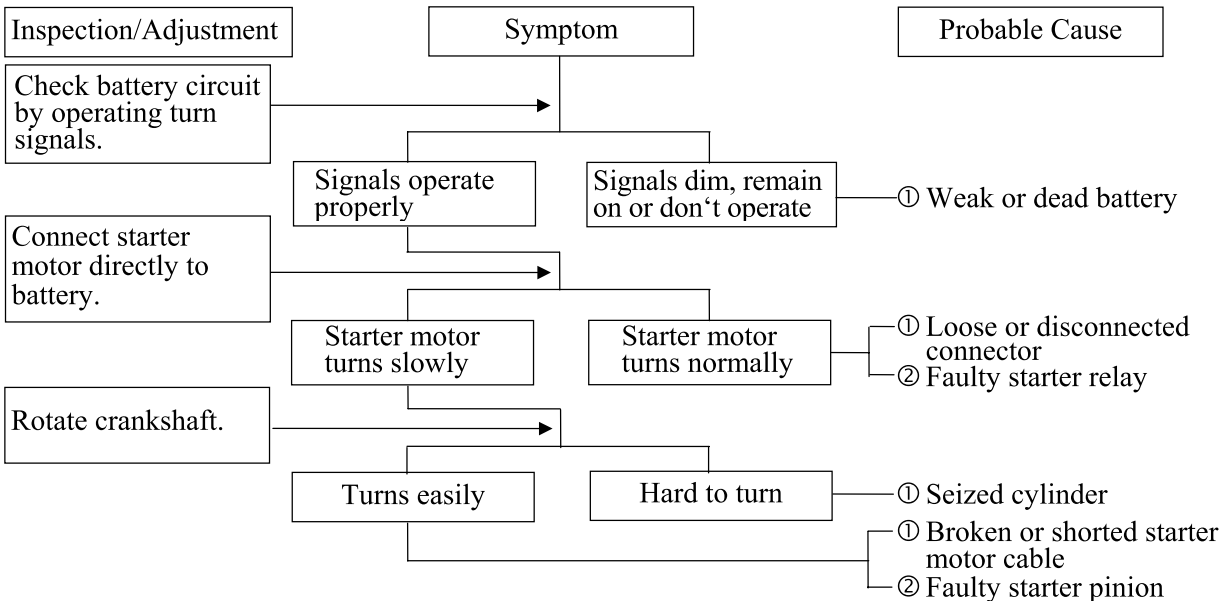

3. Starter motor does not stop turning

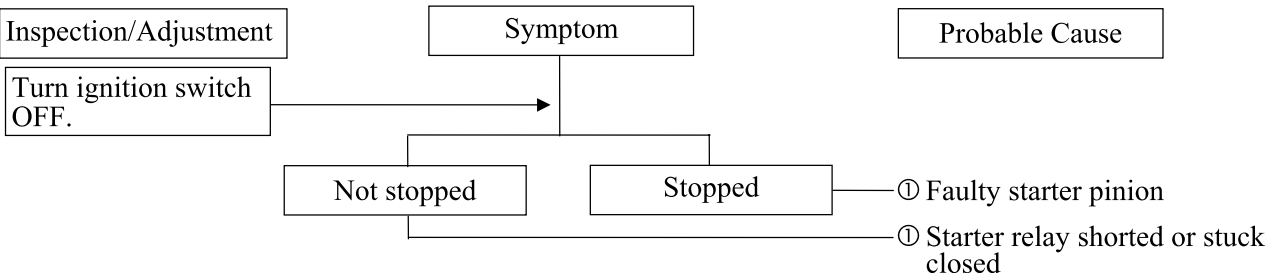

3. INSPECTION/ADJUSTMENT

INSPECTION/ADJUSTMENT

INSPECTION AND MAINTENANCE SCHEDULE.....	3- 1
BRAKE SYSTEM.....	3- 4
MOVING DEVICE	3- 6
DAMPING DEVICE.....	3- 7
POWER DRIVE SYSTEM.....	3- 7
ELECTRICAL EQUIPMENT.....	3- 8
ENGINE	3- 9
OTHERS.....	3-12

3. INSPECTION/ADJUSTMENT

INSPECTION AND MAINTENANCE SCHEDULE

(Note) 1. ○ means time for inspection.

2. ☆ means regular replacement for the specified parts.

This inspection and maintenance schedule is based upon average riding conditions.

Machines subjected to serve use, or ridden in unusually dusty areas, require more frequent servicing.

Inspection & Maintenance Item			Frequency				Judgment Standards	Remarks								
			Preride	1st month	Every 6 months	Every 12 months										
Suspension	Steering handlebar	Check for looseness and vertical play				○										
		Operating performance	○			○										
		Right/left turning angle				○										
	Front fork	Damage			○	○										
		Check for front fork pivot installation			○	○		Check steering stem								
		Check front fork pivot for looseness and abnormal noise				○		Check steering stem								
Brake System	Brake Lever	Front/rear brake lever free play			○	○	Free play: 10~20mm									
		Brake lever operation	○													
		Brake performance		○	○	○										
	Lever/Cable	Looseness, abnormal noise and damage		○		○										
	Brake drum/shoe	Drum-to-lining clearance			○	○										
		Brake shoe and lining wear				☆		Indicator type								
		Brake drum wear and damage				○	Standard: Rear : 110 mm Service Limits: Rear : 111 mm									
Moving Device	Tire	Tire pressure	○		○	○	<table border="1"> <thead> <tr> <th></th> <th>Front</th> <th>Rear</th> </tr> </thead> <tbody> <tr> <td>1 rider</td> <td>1.50 kg/cm²</td> <td>1.75 kg/cm²</td> </tr> <tr> <td>Tire Size</td> <td>70/90-16</td> <td>90/80-16</td> </tr> </tbody> </table>		Front	Rear	1 rider	1.50 kg/cm ²	1.75 kg/cm ²	Tire Size	70/90-16	90/80-16
	Front	Rear														
1 rider	1.50 kg/cm ²	1.75 kg/cm ²														
Tire Size	70/90-16	90/80-16														

3. INSPECTION/ADJUSTMENT

Inspection & Maintenance Item			Frequency				Judgment Standards	Remarks
			Preride	1st month	Every 6 months	Every 12 months		
Moving Device	Motor-cycle	Tire crack and damage	○		○	○		
		Tire groove and abnormal wear	○		○	○	Groove Depth: Front: 0.8mm Rear : 0.8mm	
		Imbedded objects, gravel, etc.	○		○	○		
		Axle nut looseness			○	○	Torque Values: Front axle nut 5.0~7.0kg-m Rear axle nut 11.0~13.0kg-m	Axle nut torque
		Check wheel rim, rim edge and spoke plate for damage		○		○	Rim runout at rim end: Front: Axial 2.0mm Radial 2.0mm Rear: Axial 2.0mm Radial 2.0mm	
		Check front wheel bearing for excessive play and abnormal noise				○		
		Check front wheel bearing for excessive play and abnormal noise				○		
Damping Device	Frame Spring	Damage					Shock spring free length	
	Suspension arm	Connecting parts looseness and arm damage				○		
	Shock absorber	Oil leakage and damage				○		
		Assembly parts looseness abnormal noise				○		
Power Drive System	Clutch	Operation		○	○	○		
	Transmission case	Oil leakage and oil level			○	○	Oil level: Oil check bolt hole at lower hole edge	Rear wheel transmission case
Electrical Equipment	Ignition device	Spark plug condition			○	○	Plug gap: 0.6~0.7mm	
	Battery	Terminal connection				○		
	Wires	Loose connection and damage				○		

3. INSPECTION/ADJUSTMENT

Inspection & Maintenance Item			Frequency				Judgment Standards	Remarks
			Preride	1st month	Every 6 months	Every 12 months		
Engine	Body	Performance and abnormal noise			○	○		
		Conditions at low and high speeds		○	○	○		
		Exhaust smoke			○	○		
		Air cleaner			○	○		
	Lubrication system	Oil quality and quantity			○	○	<input type="checkbox"/> Oil level indicator Indicator light comes on when oil is insufficient	
		Oil leakage			○	○		
		Oil level	○					
		Check oil filter for clogging				○		
	Fuel System	Fuel leakage						
		Carburetor, throttle valve and auto bystarter				○		
		Check fuel filter for clogging				○		
		Fuel level	○					
		Fuel tube replacement					☆Every 4 years	
	Lights & Winker	Operation						
Winking action, dirt and damage		○						
Buzzer & Steering Lock	Operation				○			
Rearview Mirror & Reflector	Rearview mirror position	○					Rearview Mirror	
Reflector & License Plate	Dirt and damage	○						
Counter	Operation				○			
Exhaust Muffler	Joint looseness and damage				○			
	Exhaust muffler performance				○			
Body & Frame	Looseness and damage				○			
Abnormal Conditions Happened Last Time	Check if the abnormal conditions occur again	○						
Others	Lubrication points			○	○			
	Remove carbon deposits on combustion chamber, breather hole and exhaust muffler				○			

3. INSPECTION/ADJUSTMENT

BRAKE SYSTEM

BRAKE LEVER

《Free Play》

Measure the front and rear brake lever free plays.

Free Play: Front: 10~20mm

Rear: 10~20mm

Front 10~20mm



Rear 10~20mm



If the free plays do not fall within the limits, turn the right and left adjusting nuts for adjustment.

<Rear>

“△” Marks



Adjusting Nuts

3. INSPECTION/ADJUSTMENT

BRAKE DRUM/SHOE

《 Brake Shoe Wear 》

Replace the brake shoes if the arrow on the brake arm aligns with reference mark“△” on the brake panel when the brake is fully applied.

《 Brake Drum Wear/Damage 》

Check the brake drum appearance for damage. Check if the brake lining wear is within the specified service limit. Check the brake operation for abnormal noise and brake drum inside for wear or damage.

<Rear>

“△” Marks



Adjusting Nuts

BRAKE DISK/LINING

《 Brake Disk Surface and Brake Pad Wear 》

Check the brake disk surface for scratch. Check if the brake pad wear is within the specified service limit.

《 Brake Disk Runout Inspection 》

Jack the motorcycle wheels off the ground and check if the brake disk runout is within the specified service limit.



Brake Disk

BRAKE FLUID LEVEL INSPECTION

《 Brake Master Cylinder Fluid Level Inspection 》

Turn the steering handlebar upright and check if the front brake fluid level is within the specified limits through the front brake master cylinder check hole.



Brake Master Cylinder

3. INSPECTION/ADJUSTMENT

MOVING DEVICE

TIRES

《Tire Pressure》

Check the tire pressure.

*

Tire pressure should be checked when tires are cold.
--

Tire Pressure (one rider)

Front: 1.50 kg/cm²

Rear: 1.75 kg/cm²

Tire Size

Front	70/90 – 16
Rear	90/80 – 16



《Axle Nut/Axle Shaft Looseness》

Check the front and rear axle nuts for looseness.

If the axle nuts are loose, tighten them to the specified torques.

Torques:

Front: 5.0~7.0kg-m

Rear: 11.0~13.0kg-m

《Wheel Rim/Spoke Plate Damage》

Check the wheel rim and spoke plate for wear or damage and measure the rim runout.



Axle Nut

Rear Wheel

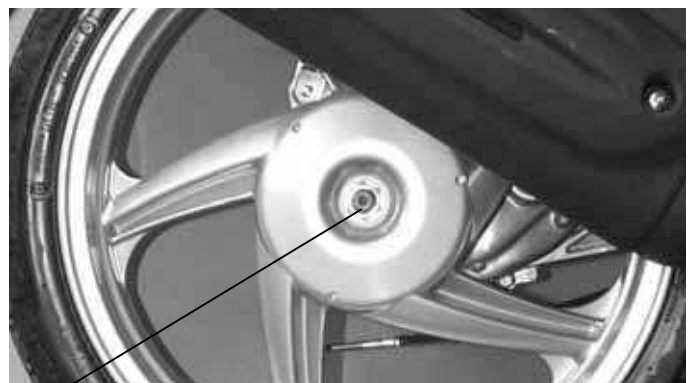

Axle Nut

3. INSPECTION/ADJUSTMENT

DAMPING DEVICE

SHOCK ABSORBERS

《Oil Leak/Damage》

Fully apply the front brake and check the action of the front shock absorber by compressing it several times.

Check the entire shock absorber assembly for looseness or damage.

Check the action of the rear shock absorber by compressing it several times.

Check the entire shock absorber assembly for looseness or damage.



POWER DRIVE SYSTEM

TRANSMISSION CASE

Check the rear wheel transmission case surrounding area for oil leaks.

Stop the engine and remove the oil check bolt.

* Place the motorcycle on its main stand on level ground.

The gear oil level shall be at the oil check bolt hole. If the oil level is low, add the specified oil to the proper level.

Specified Gear Oil: SAE10W90#

Install and tighten the oil check bolt.

Torque: 1.0~1.5kg-m

Start the engine and check for oil leaks.

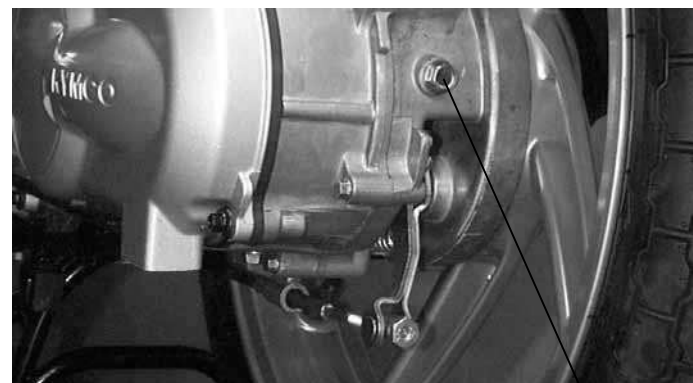

Oil Check Bolt

3. INSPECTION/ADJUSTMENT

ELECTRICAL EQUIPMENT

IGNITION APPARATUS

《Spark Plug》

Remove the frame center cover.
Remove the spark plug cap and spark plug.
Check the spark plug for wear, fouling and carbon deposits.
Remove the fouling and carbon deposits with a spark plug cleaner or wire brush.

Specified Spark Plug

NGK
BA10AB.AC.
BR8HSA

Spark Plug Gap: 0.6~0.7mm

《Ignition Apparatus》

* The CDI ignition timing is not adjustable. If the timing is incorrect, check the CDI unit, ignition coil and A.C. generator and replace any faulty parts.

Remove the right side rail. (⇒12-4)
Remove the A.C. generator fan cover. (⇒7-3)
Remove the four bolts attaching the fan and then remove the fan.
Warm up the engine and check the ignition timing with a timing light.

When the engine is running at the specified rpm, the ignition timing is correct if the “F” mark on the flywheel aligns with the index mark on the crankcase within $\pm 1.5^\circ$.

Ignition Timing:

BA10AB.AC.:
 $8^\circ \sim 14^\circ \pm 1.5^\circ \text{BTDC}/2000\text{rpm}$

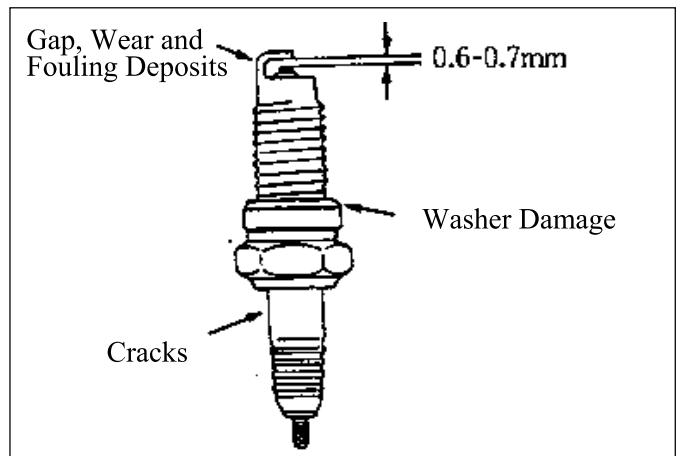

Bolt



F Mark

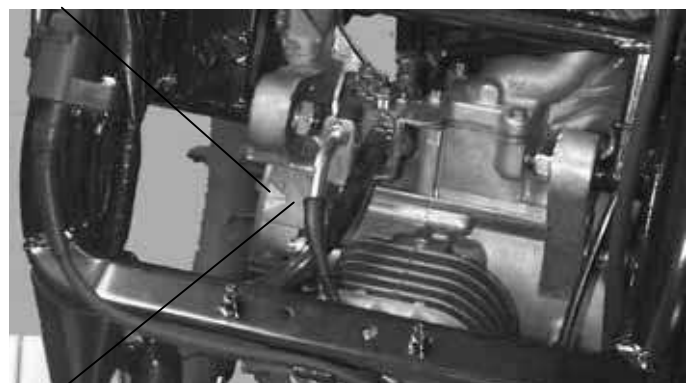

Index Mark

3. INSPECTION/ADJUSTMENT

ENGINE

BODY

《At High and Low Speeds》

* The engine must be warm for accurate idle speed adjustment.

Adjust the idle speed to the specified range by turning the throttle stop screw and air screw.

Idle Speed:

BA10AB.AC.50: 2000±100rpm

《Air Cleaner》

Remove the air cleaner cover by removing the five bolts cleaner cover screws.
Remove the air cleaner element.

Throttle Stop Screw



Air Screw

Screws

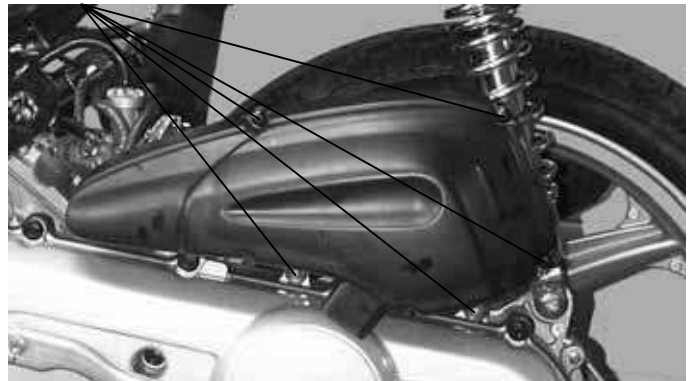

Air Cleaner



3. INSPECTION/ADJUSTMENT

Wash the air cleaner element in detergent oil, squeeze out and allow to dry.

* Never use gasoline or organic vaporable oil with acid or alkali for washing.

After washing, soak the element in clean engine oil SAE 15W-40# and squeeze out excess oil. Reinstall the element.

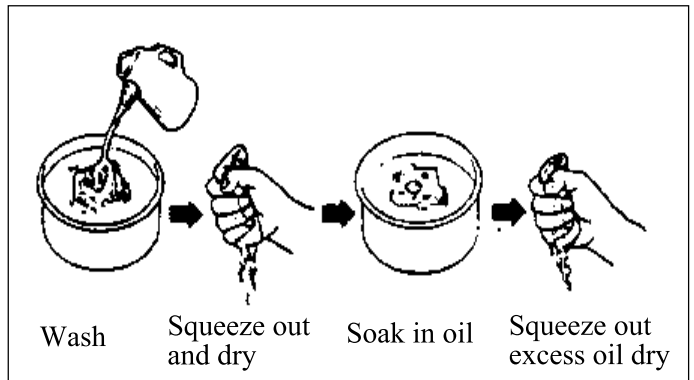

《Cylinder Compression》

* Warm up the engine before compression test.

Remove the spark plug and insert a compression gauge. Open the throttle valve fully and push the starter button for 7~8 seconds to test the compression.

Compression:

BA10AB.AC.50: 11.8kg/cm²

If the compression is low, check for the following:

- Leaking cylinder head gasket
- Worn piston/cylinder

If the compression is high, it indicates that carbon deposits have accumulated on the combustion chamber and the piston head.



LUBRICATION SYSTEM

《Oil Filter Cleaning》

Disconnect the oil tube at the oil pump side and allow oil to drain into a clean container. Remove the tube clip at the oil tank side and disconnect the oil tube. Remove the oil filter.

Clip



Oil Filter

3. INSPECTION/ADJUSTMENT

Clean the oil filter screen with compressed air.

Install the oil filter in the reverse order of removal and fill the oil tank with specified oil up to the proper level.

Bleed air from the oil pump and oil lines.

* _____

- Connect the oil tubes securely.
- Install the tube clip at the oil tank side and also install the clip to the lower oil tube that goes to the oil pump.
- Check for oil leaks.

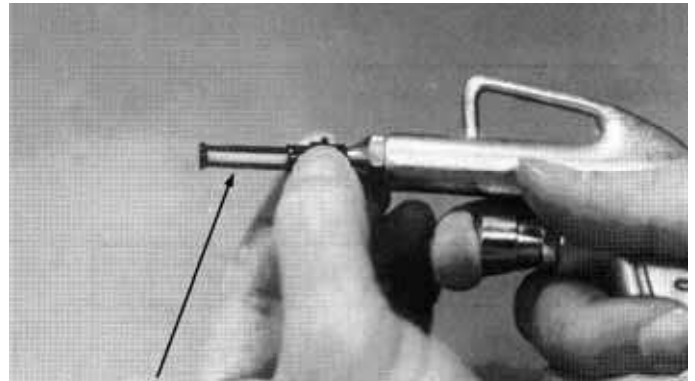

Filter Screen

《Oil Pump Condition》

* _____

Adjust oil pump control cable after the throttle grip free play is adjusted.

Open the throttle valve fully and check that the index mark on the pump body aligns with the aligning mark on the oil pump control lever.

Reference tip alignment within 1mm of index mark on open side is acceptable.

Start and idle the engine, then slowly open the throttle to increase engine rpm and check the operation of the oil pump control lever.

If adjustment is necessary, adjust the oil pump control cable by loosening the control cable lock nut and turning the adjusting nut. After adjustment, tighten the lock nut.

* _____

Reference tip alignment within 1mm of index mark on open side is acceptable. However, the aligning mark on the control lever must never be on the closed side of the index mark, otherwise engine damage will occur because of insufficient lubrication.

Lock Nut

Control Lever Aligning Mark



Adjusting Nut

Pump Body Index Mark

If the oil pump is not synchronized properly, the following will occur:

- Excessive white smoke or hard starting due to pump control lever excessively open
- Seized piston due to pump control lever insufficiently open

3. INSPECTION/ADJUSTMENT

FUEL SYSTEM

《Throttle Grip Free Play》

Measure the throttle grip free play.

Free Play: 2~6mm



If the throttle grip free play does not fall within the specified range, adjust by loosening the lock nut and turning the adjusting nut.

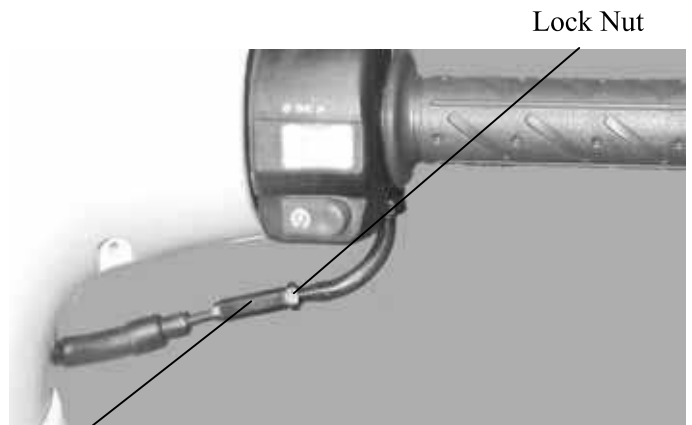

OTHERS

LIGHTS

《Headlight》

Adjust the headlight beam by loosening the headlight adjusting bolt and moving the adjusting bolt forward and backward to a proper position. Tighten the adjusting bolt.



4. LUBRICATION SYSTEM

LUBRICATION SYSTEM

SERVICE INFORMATION	4-2
TROUBLESHOOTING	4-2
OIL PUMP REMOVAL.....	4-3
OIL PUMP INSPECTION	4-3
OIL PUMP INSTALLATION	4-4
OIL PUMP BLEEDING.....	4-5
OIL TANK	4-6

4. LUBRICATION SYSTEM

LUBRICATION SYSTEM

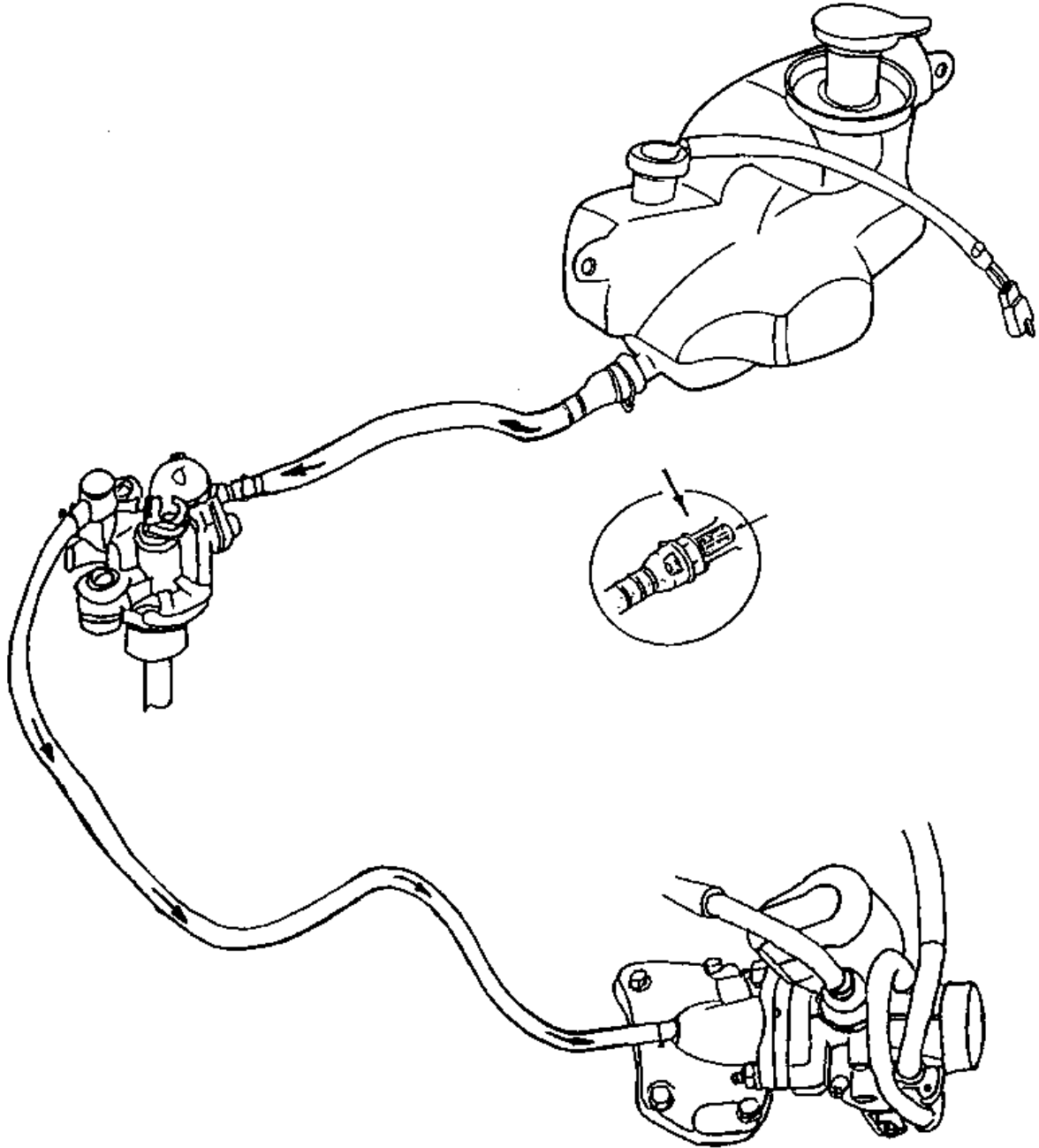

4. LUBRICATION SYSTEM

SERVICE INFORMATION

GENERAL INSTRUCTIONS

- Use care when removing and installing the oil pump not to allow dust and dirt to enter the engine and oil line.
- Do not attempt to disassemble the oil pump.
- Bleed air from the oil pump if there is air between the oil pump and oil line.
- If the oil is disconnected, refill the oil line with motor oil before connecting it.

SPECIFICATIONS

- Recommended Motor Oil: SAE20W20# 2-stroke Motor Oil
- Oil Capacity : 1.1 liter
Light comes on : 0.5 liter

TROUBLESHOOTING

Excessive white smoke or carbon deposits on spark plug

- Oil pump not properly synchronized (excessive oil)
- Poor quality oil

Engine overheating

- Oil pump not properly adjusted (insufficient oiling)
- Poor quality oil

Seized piston

- No oil in tank or clogged oil line
- Oil pump not properly adjusted (insufficient oiling)
- Air in oil line
- Faulty oil pump

Oil not flowing out of tank to engine

- Clogged oil tank cap breather hole
- Clogged oil filter

4. LUBRICATION SYSTEM

OIL PUMP REMOVAL

Do not allow foreign matters to enter the crankcase. Before removing the oil pump, clean the oil pump and crankcase surfaces.

Remove the met-in box. (⇒12-4)

Disconnect the oil pump control cable from the pump body.
Disconnect the oil inlet line from the oil pump.
Then, disconnect the oil outlet line.

Before disconnecting the oil line, clip the oil line to avoid oil flowing out and then plug the oil line after it is disconnected.

Remove the oil pump control cable plate bolt .
Remove the oil pump from the crankcase.

OIL PUMP INSPECTION

Remove the oil pump and inspect the following items:

- Weakened O-ring
- Damage to crankcase mating surface
- Damage to pump body
- Control lever operation
- Oil leaks through oil seals
- Worn or damaged pump pinion

Do not disassemble the oil pump which cannot be used after disassembly.

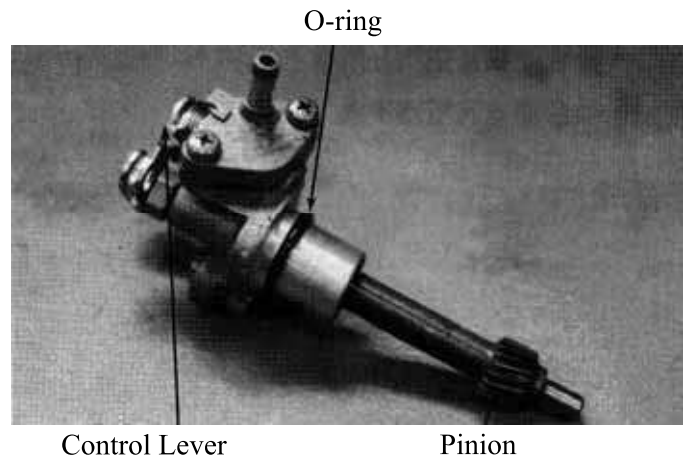
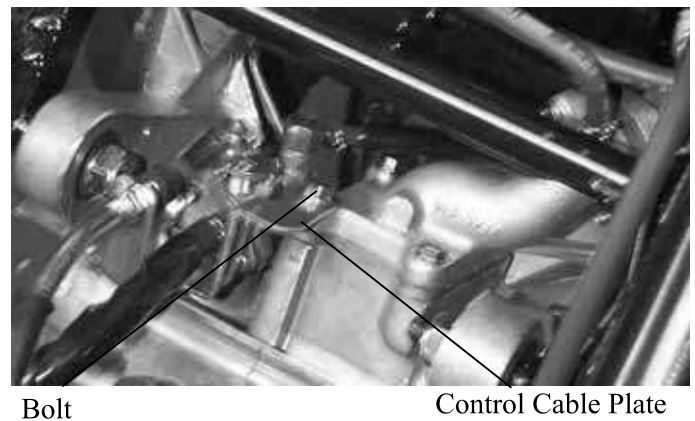
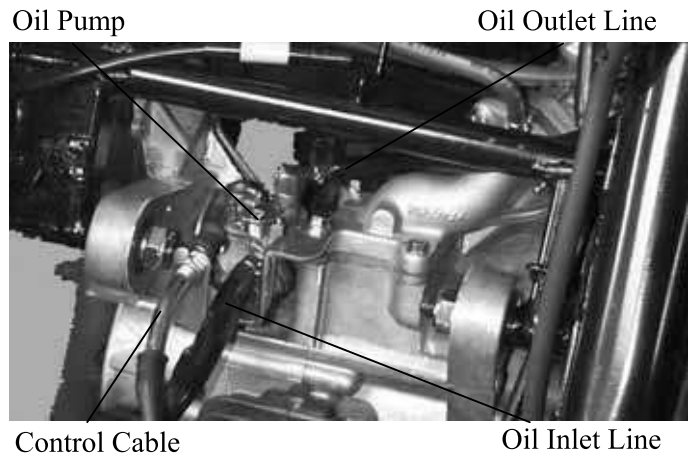

4. LUBRICATION SYSTEM

OIL PUMP INSTALLATION

- Lubricate the O-ring with grease or engine oil before installation.
- Make sure that the oil pump is inserted into the crankcase.
- Apply molybdenum disulfide or grease to the pump pinion.

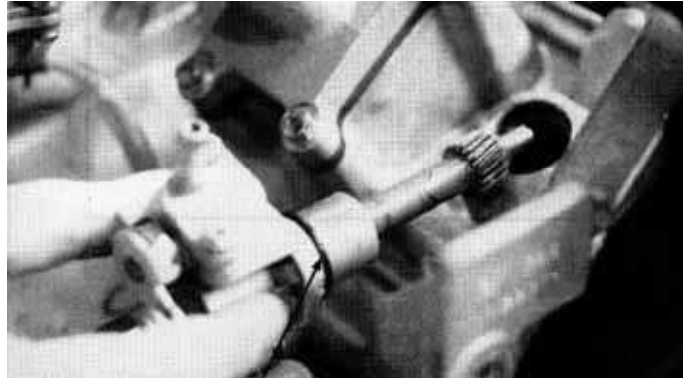

Grease or Engine Oil

Install the oil pump onto the crankcase.

Control Cable Plate



Bolt

Install the oil pump control cable plate.
Connect the oil inlet line and oil outlet line properly.
Connect the oil pump control cable.
Bleed air from the oil pump.

Oil Outlet Line



Control Cable

4. LUBRICATION SYSTEM

OIL PUMP BLEEDING

- - Air in the oil lines will block oil flow and result in severe engine damage.
 - Bleed air from the oil lines and oil pump whenever the oil lines or pump have been removed or there is air in the oil lines.

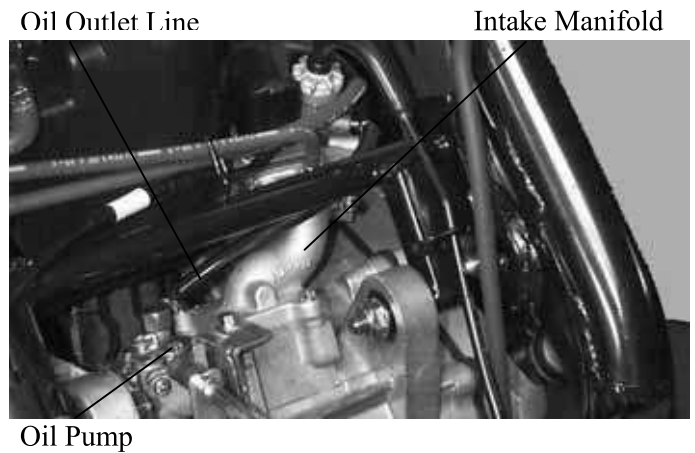

OIL INLET LINE/OIL PUMP BLEEDING

Fill the oil tank with recommended oil.
Place a shop towel around the oil pump.
Disconnect the oil inlet line from the oil pump and clip it.
Fill the oil pump with oil by squirting clean oil through the joint. (About 3cc)
Fill the oil line with oil and connect it to the oil pump.

- - Bleed air from the oil inlet line first, then bleed air from the oil outlet line.

OIL OUTLET LINE BLEEDING

1. Disconnect the oil outlet line and bend it into U shape. Force air out of the tube by filling it with oil.
2. Start the engine and allow it to idle with the oil control lever in the fully open position. Visually check the oil flow.
3. If there is no oil flowing out within 1 minute, bleed air from the oil inlet line and oil pump.

- - Never run the engine in a closed area.
 - Do not increase the engine speed at will.

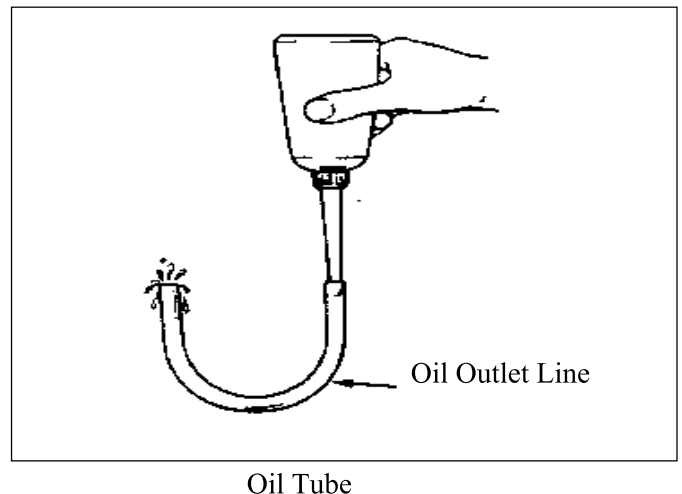

4. LUBRICATION SYSTEM

OIL TANK

OIL TANK REMOVAL

Remove the met-in box. (⇒12-5)
Remove the frame body cover. (⇒12-5)
Remove the rear carrier. (⇒12-5)
Remove the two bolts, four nuts attaching the stay comp fuel tank.
Remove the oil meter connector.
Remove the two bolts attaching the oil tank.
Disconnect the oil inlet line.
Drain the oil inside the oil tank into a clean container.
Remove the oil tank.
The installation sequence is the reverse of removal.

Oil Meter

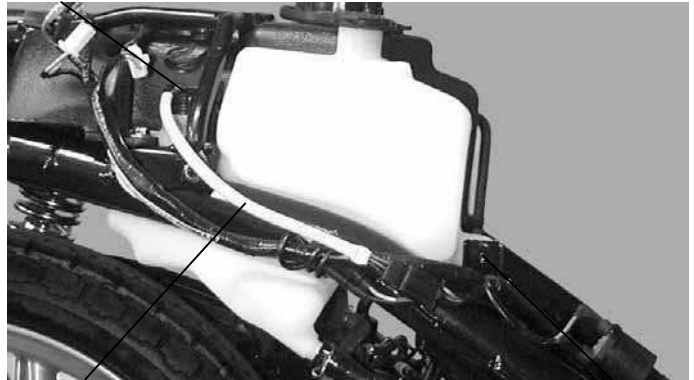

Wire Connector

Bolts

-
-
- Connect the oil line properly.
- Bleed air from the oil pump after installation.
- The oil tube clip (at the oil tank side) must be locked from inside of the oil tube joint.

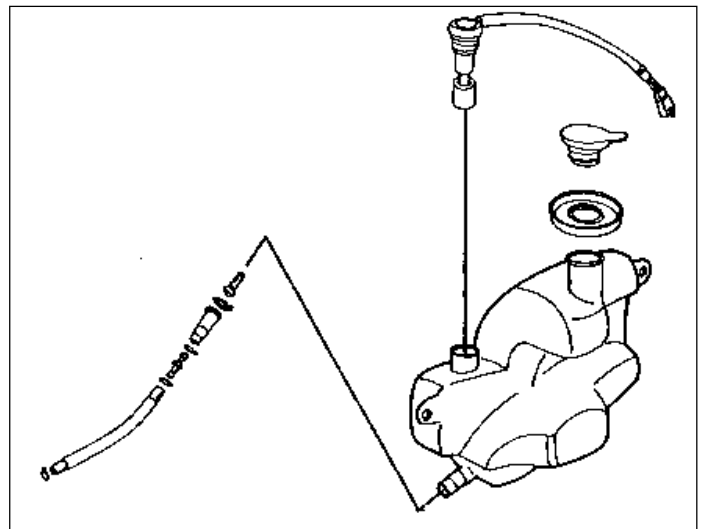

5. ENGINE REMOVAL/INSTALLATION

5

ENGINE REMOVAL/INSTALLATION

SERVICE INFORMATION	5-1
ENGINE REMOVAL	5-2
ENGINE INSTALLATION	5-4

5. ENGINE REMOVAL/INSTALLATION

SERVICE INFORMATION

GENERAL INSTRUCTIONS

- Parts requiring engine removal for servicing:

Crankcase
Crankshaft

TORQUE VALUES

Engine mounting bolt	4.5~5.5kg-m
Rear shock absorber lower mount bolt	2.4~3.0kg-m
Engine hanger bracket bolt	3.5~4.5kg-m

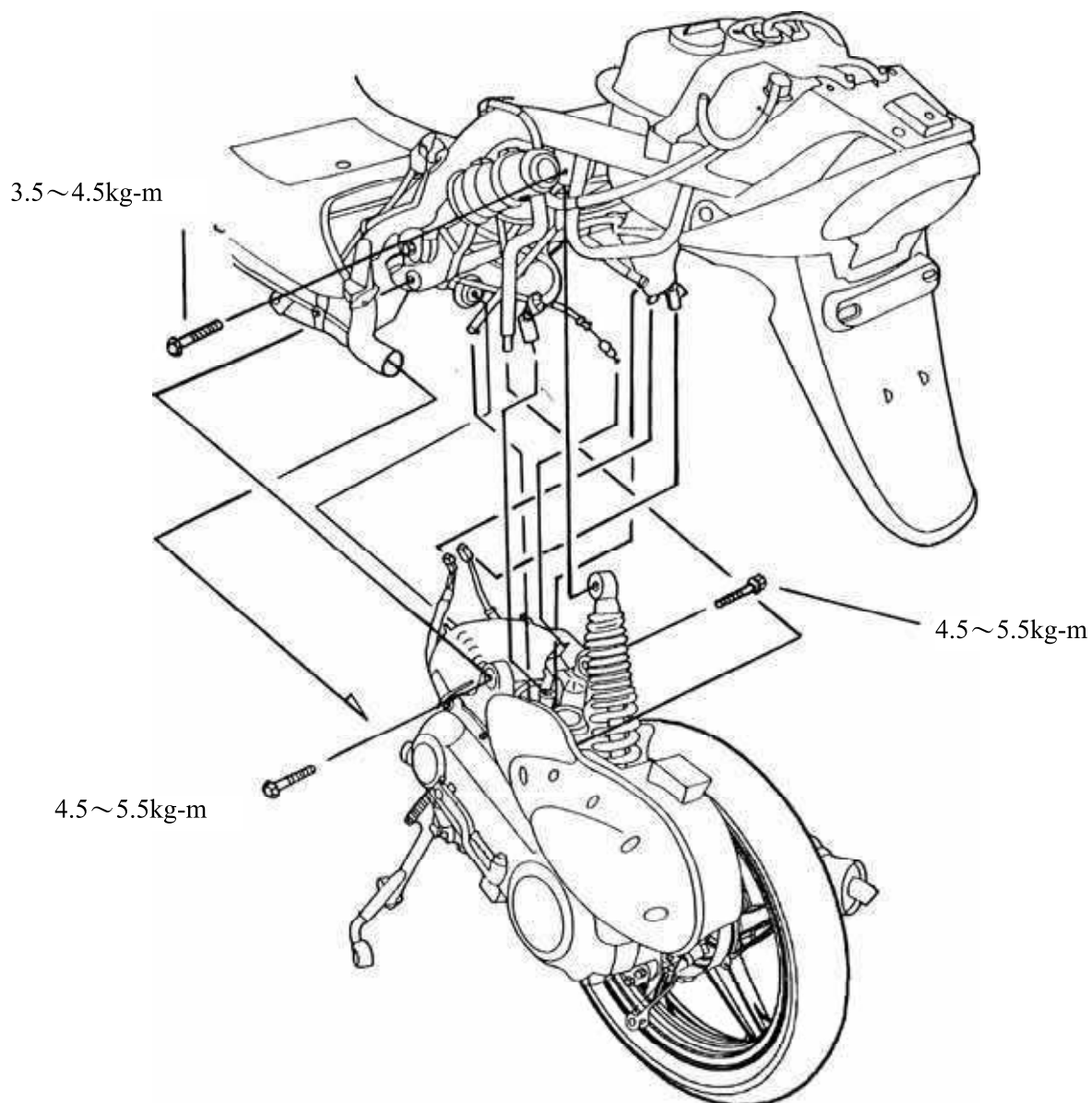

5. ENGINE REMOVAL/INSTALLATION

ENGINE REMOVAL

Remove the frame body cover. (⇒12-5)
Remove the two bolts attaching the air cleaner case.
Loosen the band between the air cleaner and carburetor to remove the air cleaner case.
Remove the carburetor cap.



Disconnect the oil pump control cable from the pump body.
Disconnect the oil inlet line from the oil pump.

* After the oil inlet line is disconnected, plug the oil line opening to prevent oil from flowing out.

Disconnect the auto bystarter, A.C. generator and starter motor wire connectors.

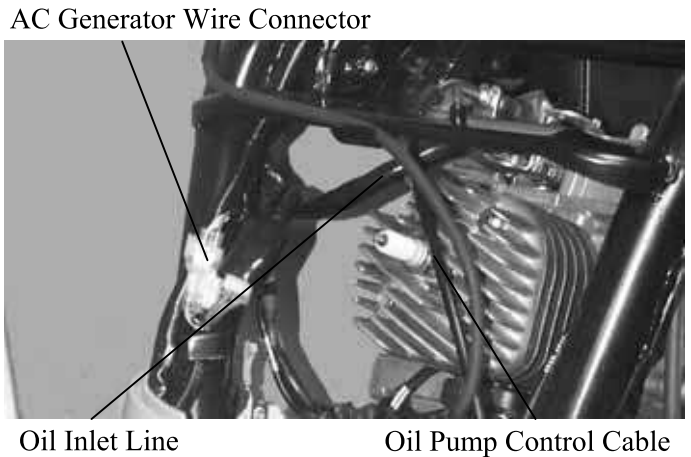

Remove the spark plug cap.

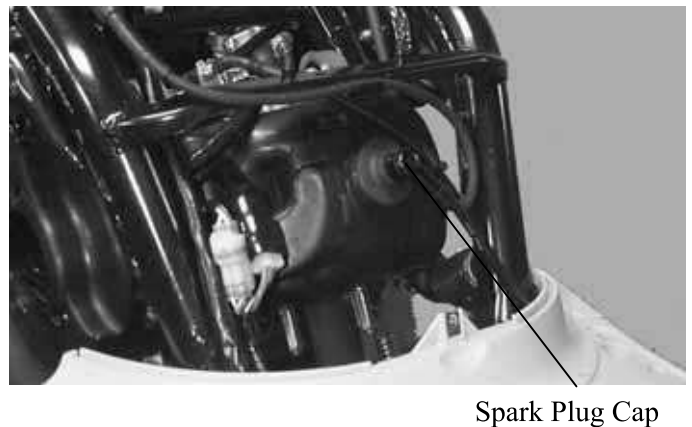

5. ENGINE REMOVAL/INSTALLATION

Remove the rear brake adjusting nut and disconnect the brake cable from the crankcase.

Remove the rear brake cable clamp and rear brake cable.

Remove the cooling air tube band on the left crankcase cover and disconnect the cooling air tube.

Remove the rear shock absorber lower mount bolt.

Rear Shock Absorber Lower Mount Bolt



Rear Brake Cable

Clamp

Remove the right and left engine mounting nuts.

Take out the right and left engine mounting bolts.

Lift the frame upward to separate it from the engine and be careful not to damage the rear fender.

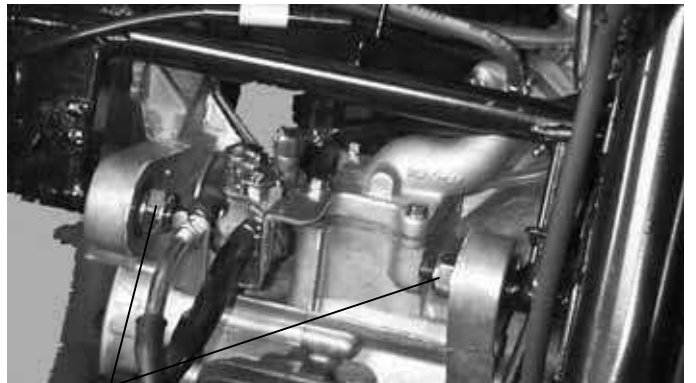

Engine Mounting Nuts

ENGINE HANGER BRACKET REMOVAL

Remove the engine hanger bracket bolt and engine hanger bracket.

The installation sequence is the reverse of removal.

Torque: 3.5~4.5kg-m

Engine Hanger Bracket



Engine Hanger Bracket Bolt

5. ENGINE REMOVAL/INSTALLATION

ENGINE HANGER BRACKET INSPECTION

Inspect the stopper rubbers and bushings for damage and replace with new ones if necessary.

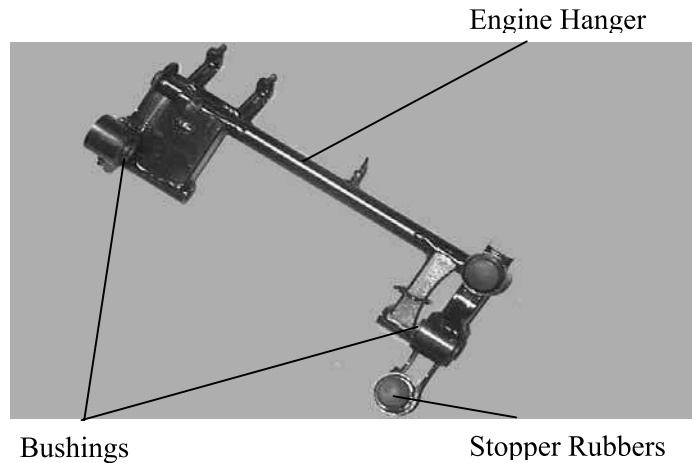

ENGINE INSTALLATION

Install the engine in the reverse order of removal.

* Cables and wires should be routed properly.

Torque Values:

Engine mounting bolt : 4.5~5.5kg-m
Rear shock absorber lower mount bolt:
: 2.4~3.0kg-m



Perform the following inspections and adjustments after installation.

- Throttle cable
- Oil pump control cable (⇒3-11)
- Rear brake cable (⇒3-5)
- Oil pump bleeding (⇒3-11)



6. CYLINDER HEAD/CYLINDER/PISTON

6

CYLINDER HEAD/CYLINDER/PISTON

SERVICE INFORMATION	6-2
TROUBLESHOOTING	6-2
CYLINDER HEAD	6-3
CYLINDER/PISTON	6-6

6. CYLINDER HEAD/CYLINDER/PISTON

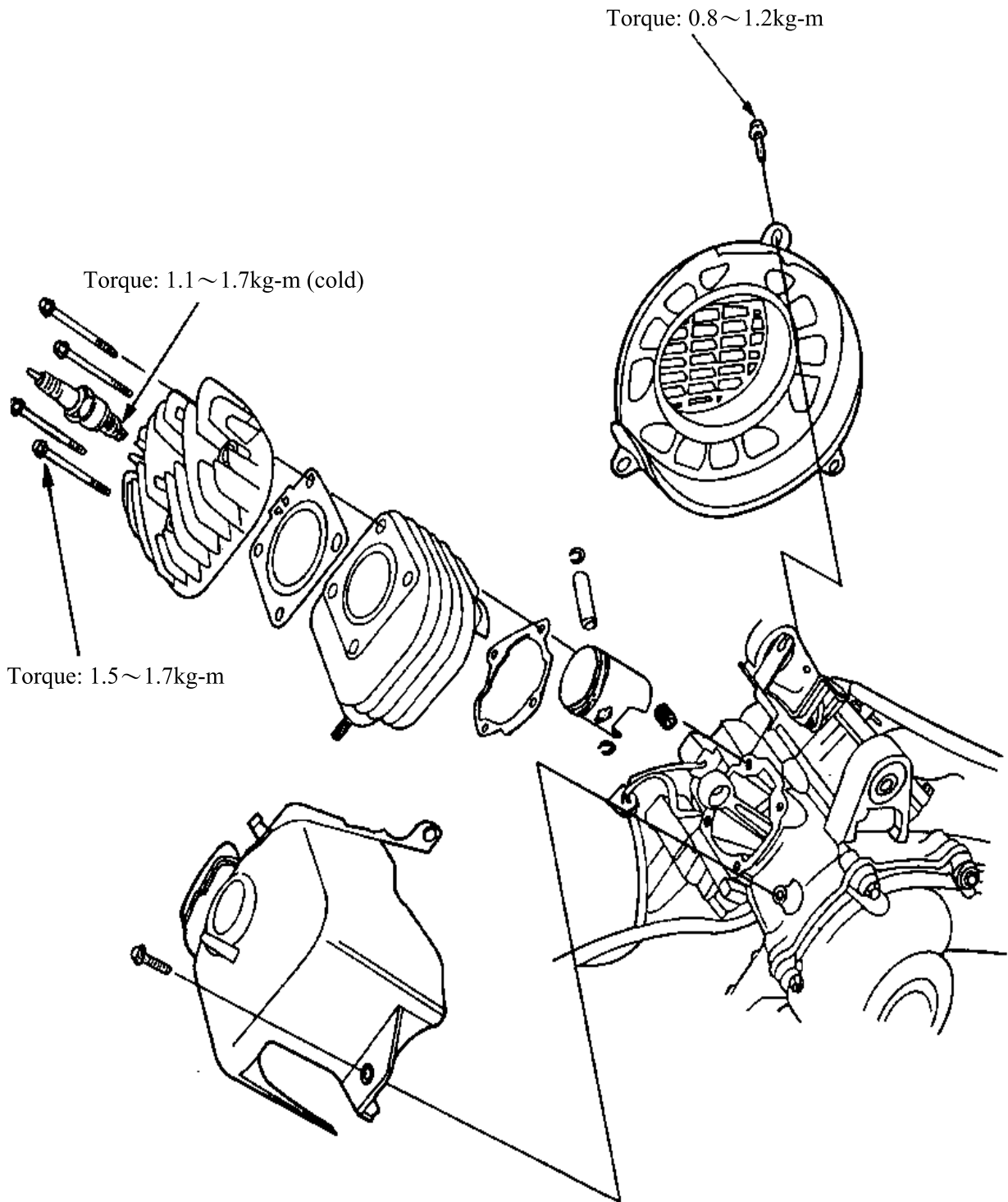

6. CYLINDER HEAD/CYLINDER/PISTON

SERVICE INFORMATION

GENERAL INSTRUCTIONS

- The cylinder head, cylinder and piston can be serviced with the engine installed in the frame.
- Before disassembly, clean the engine to prevent dust from entering the engine.
- Remove all gasket material from the mating surfaces.
- Do not use a driver to pry between the cylinder and cylinder head, cylinder and crankcase.
- Do not damage the cylinder inside and the piston surface.
- After disassembly, clean the removed parts before inspection. When assembling, apply the specified engine oil to movable parts.

SPECIFICATIONS	Standard (mm)	Service Limit (mm)
	BA10AB.AC.50	BA10AB.AC 50
Item		
Cylinder head warpage	—	0.10
Piston O.D.(5mm from bottom of piston)	38.970~38.955	38.90
Cylinder-to- piston clearance		0.10
Piston pin hole I.D.	12.002~12.008	12.03
Piston pin O.D.	11.994~12.0	11.98
Piston-to-piston pin clearance	←	←
Piston ring end gap (top/second)	0.10~0.25	0.40
Connecting rod small end I.D.	17.005~17.017	17.03
Cylinder bore	39.0~39.025	39.05

TORQUE VALUES

Cylinder head bolt	1.5~1.7kg-m
Exhaust muffler joint lock nut	1.0~1.4kg-m
Exhaust muffler lock bolt	3.0~3.6kg-m
Spark plug	1.1~1.7kg-m

● TROUBLESHOOTING

Compression too low, hard starting or poor performance at low speed

- Leaking cylinder head gasket
- Loose spark plug
- Worn, stuck or broken piston and piston rings
- Worn or damaged cylinder and piston

Compression too high, overheating or knocking

- Excessive carbon build-up in cylinder head or on piston head

Abnormal noisy piston

- Worn cylinder and piston
- Worn piston pin or piston pin hole
- Worn connecting rod small end bearing

Abnormal noisy piston rings

- Worn, stuck or broken piston rings
- Worn or damaged cylinder

6. CYLINDER HEAD/CYLINDER/PISTON

CYLINDER HEAD

REMOVAL

Remove the rear carrier.
Remove the frame body cover. (⇒12-5)

Spark Plug Cap



Remove the spark plug cap.
Remove the three bolts attaching the fan cover to remove the fan cover.
Remove the two joint lock nuts on the front of the exhaust muffler and then remove the two exhaust muffler lock bolts.
Remove the bolt attaching the engine hood to remove the engine hood.
The installation sequence is the reverse of removal.

Fan Cover/Engine Hood

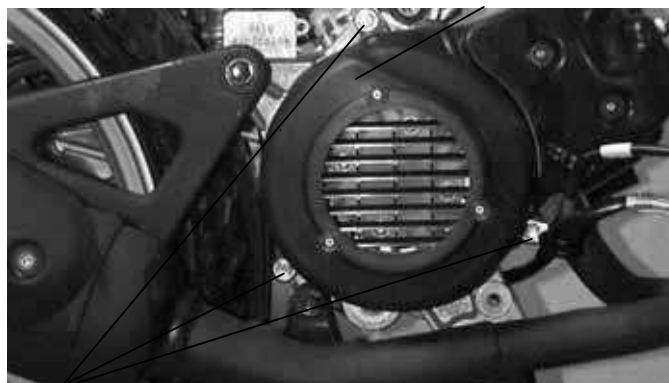

* When installing the exhaust muffler, first tighten the two nuts on the front and then tighten the two bolts.

Bolts

Remove the spark plug.
Remove the cylinder head bolts and the cylinder head.

* Loosen the bolts diagonally in 2 or 3 times.

Remove the cylinder head gasket.

Cylinder Head

Cylinder head Bolts

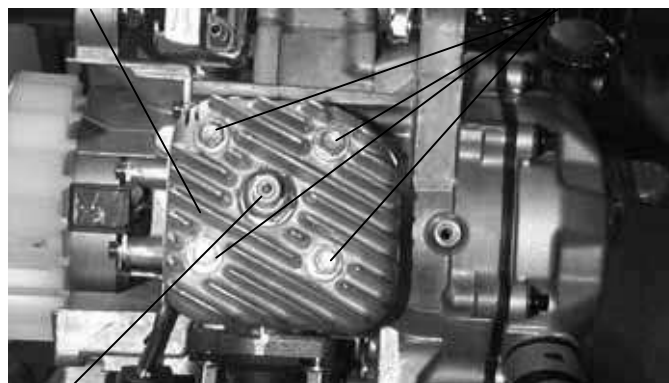

Spark Plug

6. CYLINDER HEAD/CYLINDER/PISTON

COMBUSTION CHAMBER DECARBONIZING

Remove the carbon deposits from the combustion chamber

- * Avoid damaging the combustion chamber wall and cylinder mating surface.

Combustion Chamber

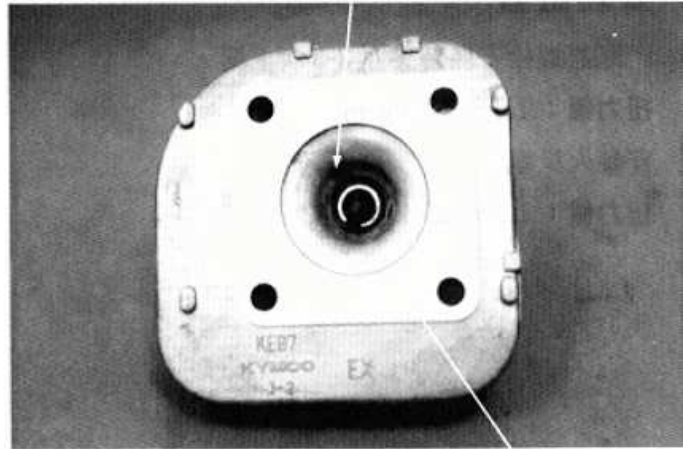

Mating Surface

CYLINDER HEAD INSPECTION

Check the cylinder head for warpage with a straight edge and feeler gauge.

Service Limit:

BA10AB.AC.50: 0.10mm replace if over

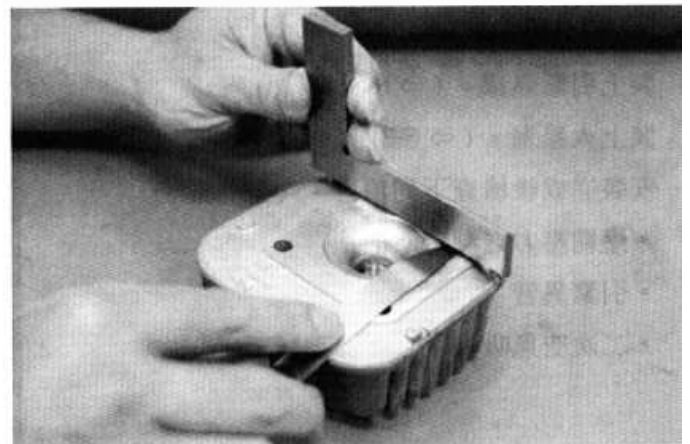

CYLINDER HEAD INSTALLATION

Install the cylinder head on the cylinder properly.

- * Be careful not to damage the mating surfaces.

Install a new cylinder head gasket onto the cylinder.

Cylinder head Gasket

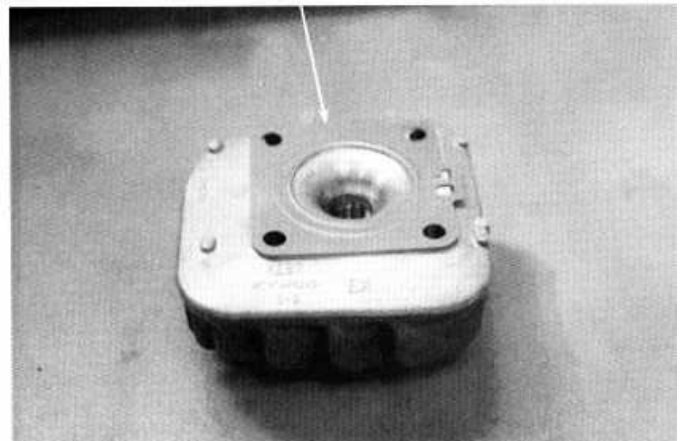

6. CYLINDER HEAD/CYLINDER/PISTON

Cylinder Head Bolts Installation

Install and tighten the cylinder head bolts diagonally in 2 or 3 times.

Torque: 1.5~1.7kg-m

Install the spark plug.

Torque: 1.1~1.7kg-m

Cylinder head Bolts

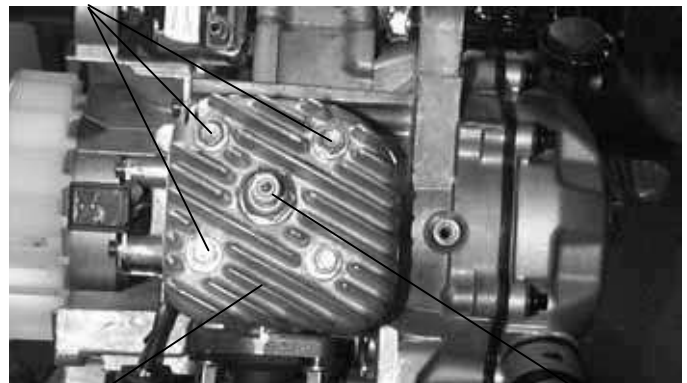

Cylinder Head

Spark Plug

Engine Hood Installation

Install the engine hood. (⇨6-3)

Install the spark plug cap. (⇨6-3)

Perform the following inspections after installation:

- Compression test
- Abnormal engine noise
- Cylinder air leaks

Spark Plug

Engine Hood

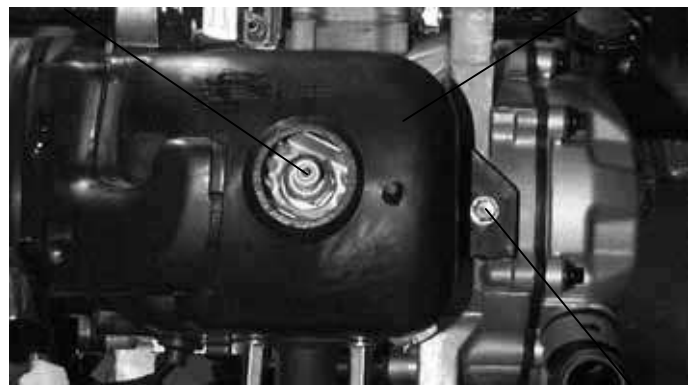

Bolt



Bolts

6. CYLINDER HEAD/CYLINDER/PISTON

CYLINDER/PISTON

CYLINDER REMOVAL

Remove the met-in box and seat.
Remove the frame body cover.
Remove the cylinder head.
Remove the two exhaust muffler joint lock nuts and two exhaust muffler lock bolts.
Remove the exhaust muffler.
Remove the cylinder.
Remove the cylinder gasket.

- * Do not pry between the cylinder and crankcase or strike the fins.

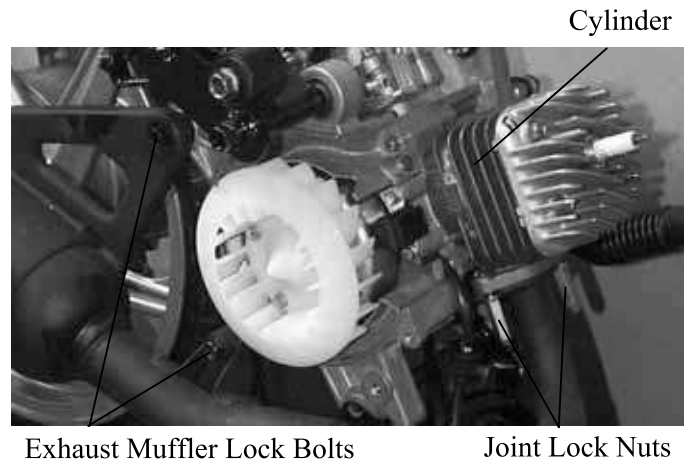

PISTON REMOVAL

Remove the piston pin clip to remove the piston pin and piston.

- *
- Do not damage or scratch the piston.
 - Do not apply side force to the connecting rod when removing the piston pin.
 - Place clean shop towels in the crankcase to keep the piston pin clip from falling into the crankcase.

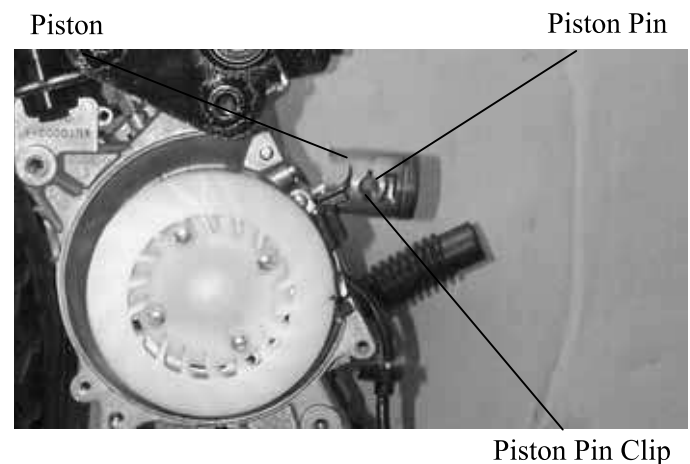

Spread each piston ring and remove by lifting it up at a point just opposite the gap.
Remove the expander.

6. CYLINDER HEAD/CYLINDER/PISTON

CYLINDER/PISTON INSPECTION

Check the cylinder and piston for wear or damage.

Clean carbon deposits from the exhaust port area.

*

Be careful not to damage the cylinder inside wall.

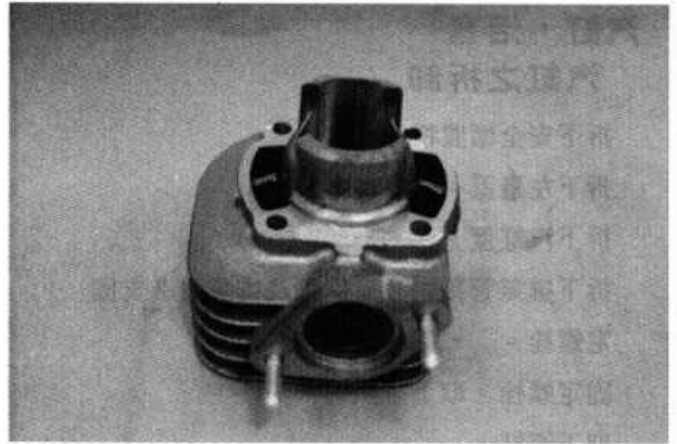

Measure the cylinder bore at three levels of A, B and C in both X and Y directions. Avoid the port area. Take the maximum figure measured to determine the cylinder bore.

Service Limit:

BA10AB.AC.50: 39.05mm replace if over

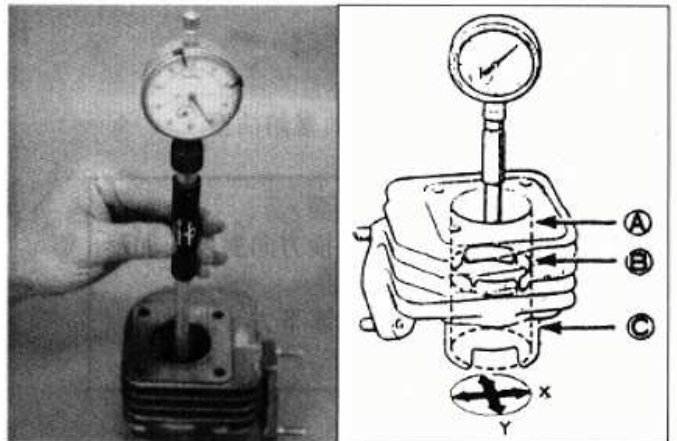

Inspect the top of the cylinder for warpage.

Service Limit:

BA10AB.AC.50: 0.10mm replace if over



6. CYLINDER HEAD/CYLINDER/PISTON

*

The cylinder has an A mark or no mark on it. When replacing the cylinder with a new one, use a cylinder having the same mark as the old one.

A Mark

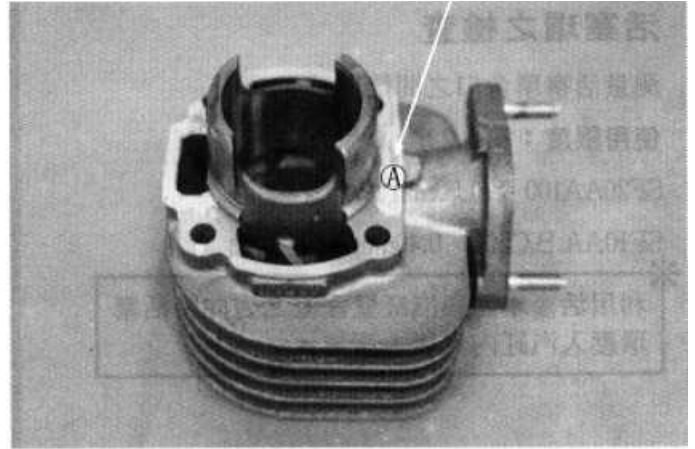

Measure the piston O.D. at a point 5mm from the bottom of the piston skirt.

Service Limit:

BA10AB.AC.50: 38.90mm replace if below

Measure the piston-to-cylinder clearance.

Service Limit:

BA10AB.AC.50: 0.10mm replace if over

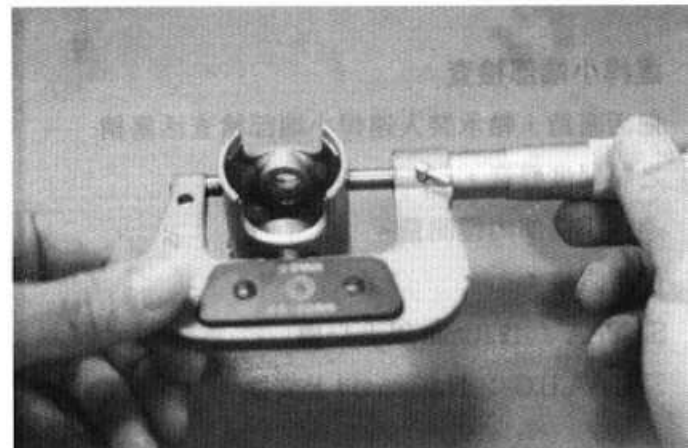

Measure the piston pin hole I.D.

Service Limit:

BA10AB.AC.50: 12.03mm replace if over

Measure the piston pin O.D.

Service Limit:

BA10AB.AC.50: 11.98mm replace if below

Measure the piston-to-piston pin clearance.

Service Limit:

BA10AB.AC.50: 0.03mm replace if over

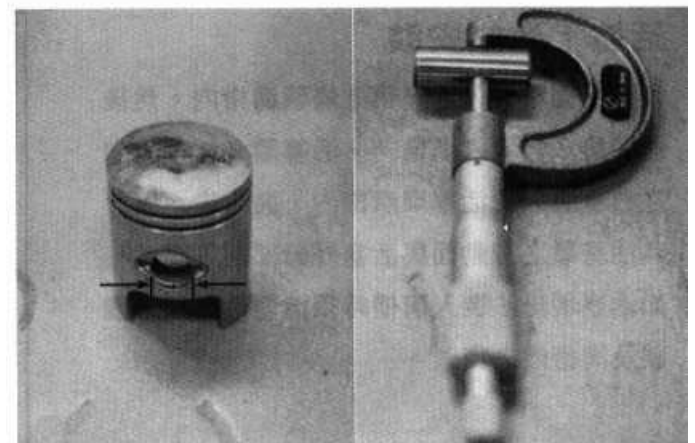

6. CYLINDER HEAD/CYLINDER/PISTON

PISTON RING INSPECTION

Measure each piston ring end gap.

Service Limits: Top/Second

BA10AB.AC.50: 0.40mm replace if over

* Set each piston ring squarely into the cylinder using the piston and measure the end gap.

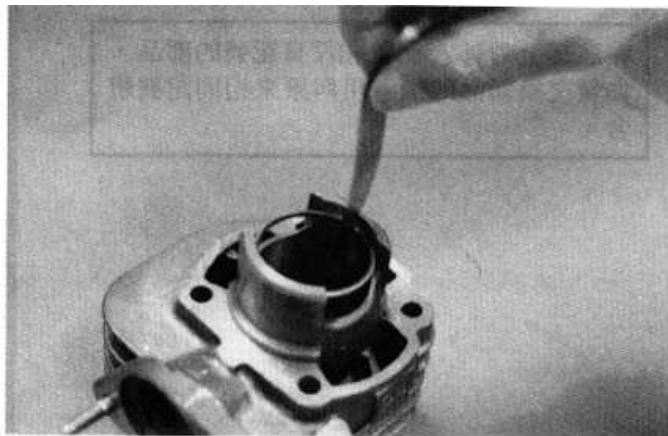

CONNECTING ROD SMALL END INSPECTION

Install the piston pin and bearing in the connecting rod small end and check for excessive play.

Measure the connecting rod small end I.D.

Service Limit:

BA10AB.AC.50: 17.03mm replace if over

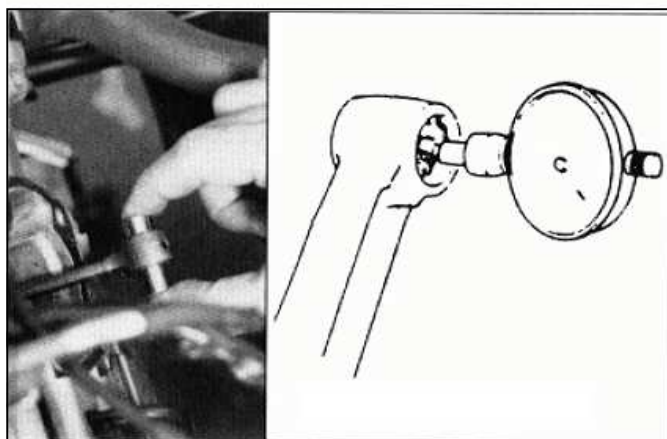

PISTON/CYLINDER INSTALLATION

First install the expander in the second ring groove.

Then install the top and second rings in their respective ring grooves.

The piston rings should be pressed into the grooves with even force.

After installation, check and make sure that each ring is flush with the piston at several points around the ring.

A ring that will not compress means that the ring groove has carbon deposits in it and should be cleaned.

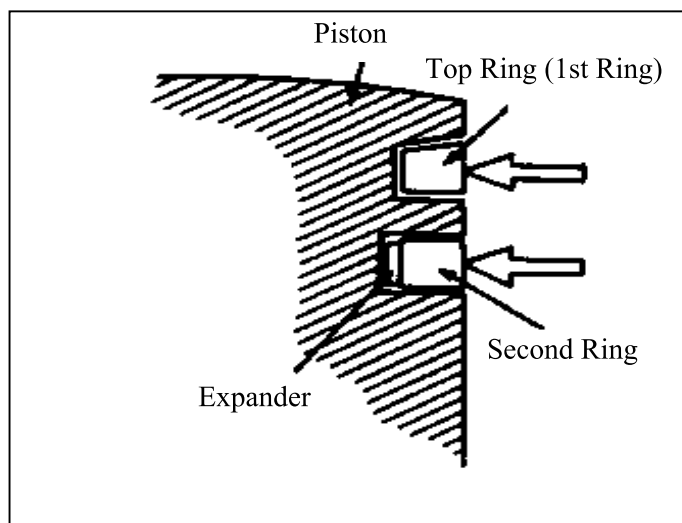

6. CYLINDER HEAD/CYLINDER/PISTON

Install a new cylinder gasket on the mating surface between the cylinder and crankcase.

Cylinder Gasket

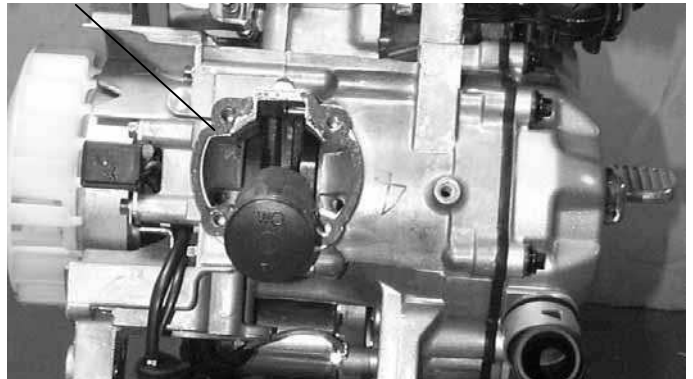

Make sure that the ring end gaps are aligned with the piston ring pins in the ring grooves.

Lubricate the cylinder inside and piston rings with engine oil and install the piston into the cylinder while compressing the piston rings.

Ring Pins

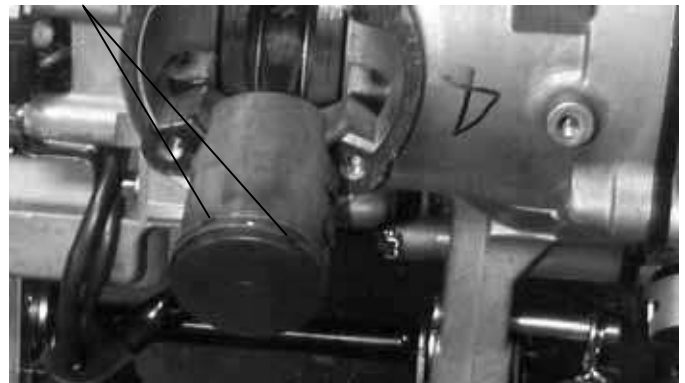

* Be careful not to damage the piston.

Install the cylinder head.

Torque: 1.5~1.7kg-m

Install the exhaust muffler and tighten the exhaust muffler joint lock nuts.

Torque: 1.0~1.4kg-m

Tighten the exhaust muffler lock bolts.

Torque: 3.0~3.6kg-m

Install the frame covers.

Install the met-in box.

The installation sequence is the reverse of removal .

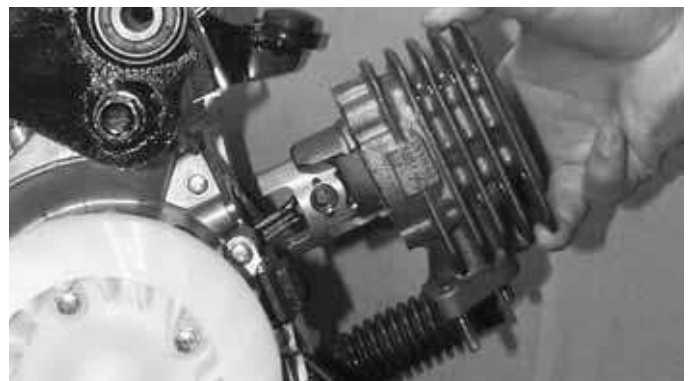

7. A.C. GENERATOR



A.C. GENERATOR

SERVICE INFORMATION	7-2
A.C. GENERATOR REMOVAL.....	7-3
A.C. GENERATOR INSTALLATION	7-4

7. A.C. GENERATOR

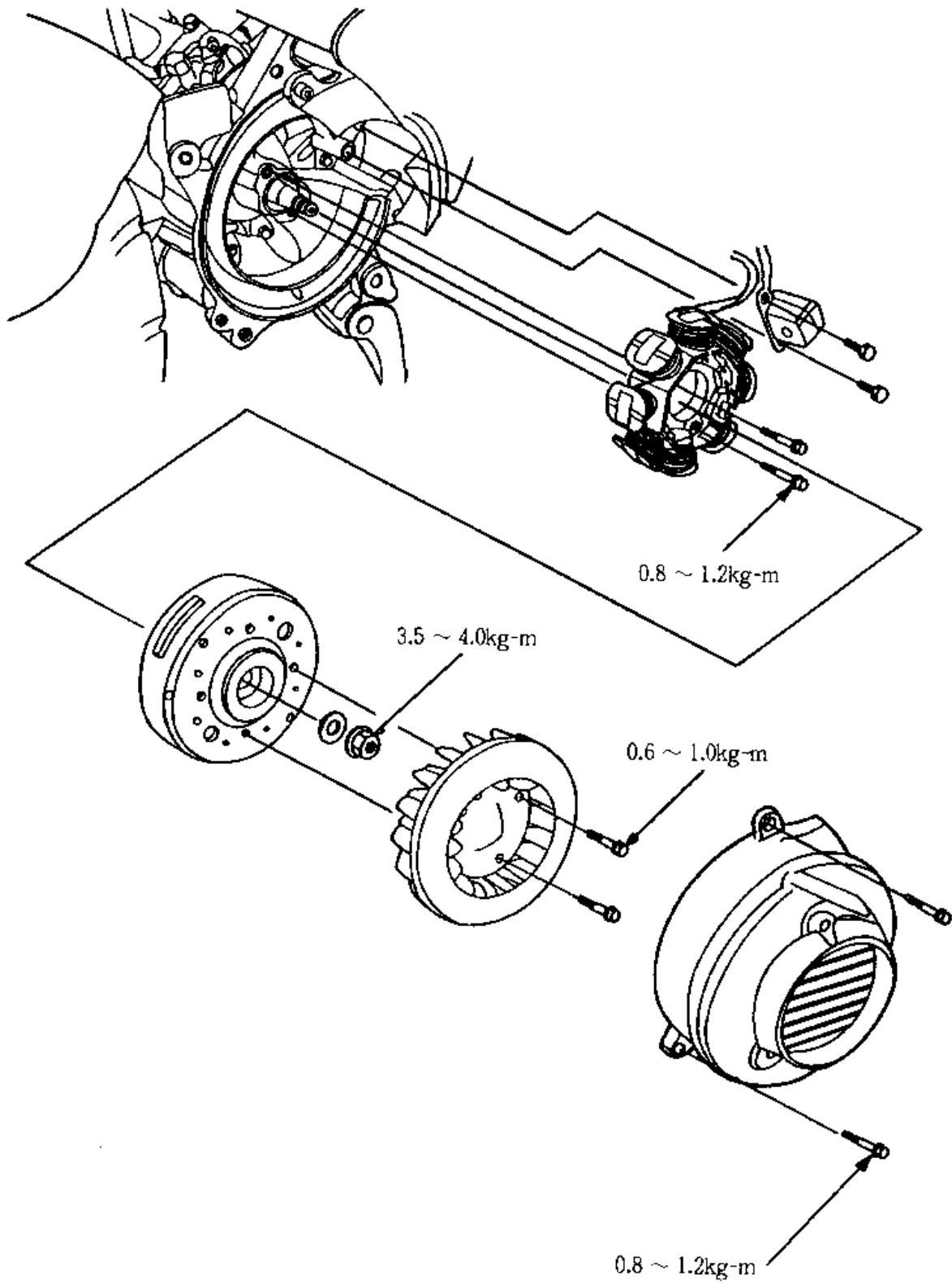

7. A.C. GENERATOR

SERVICE INFORMATION

GENERAL INSTRUCTIONS

- All A.C. generator maintenance and inspection can be made with the engine installed.
- Refer to Section 15 for A.C. generator inspection.

TORQUE VALUE

Flywheel nut : 3.5~4.0kg-m

SPECIAL TOOLS

Flywheel puller
Universal holder

7. A.C. GENERATOR

A.C. GENERATOR REMOVAL

Remove the three bolts attaching the fan cover to remove the fan cover.



Fan Cover

Bolts

Remove the cooling fan by removing the four bolts.

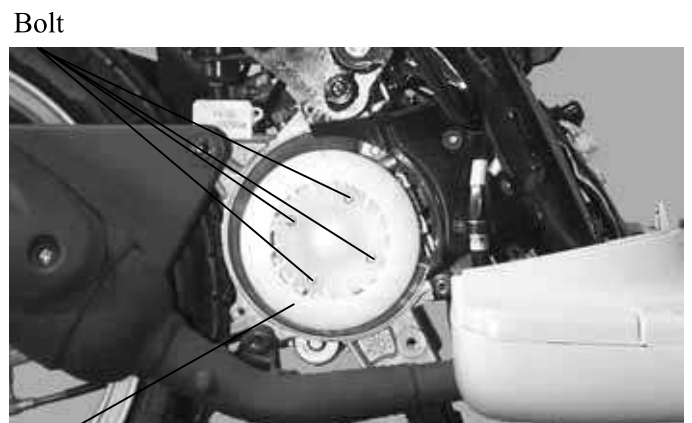

Bolt

Cooling Fan

Hold the flywheel with an universal holder and then remove the 10mm flywheel nut.



Universal Holder

Nut

7. A.C. GENERATOR

Remove the A.C. generator flywheel using the flywheel puller.

Lock Nut Wrench

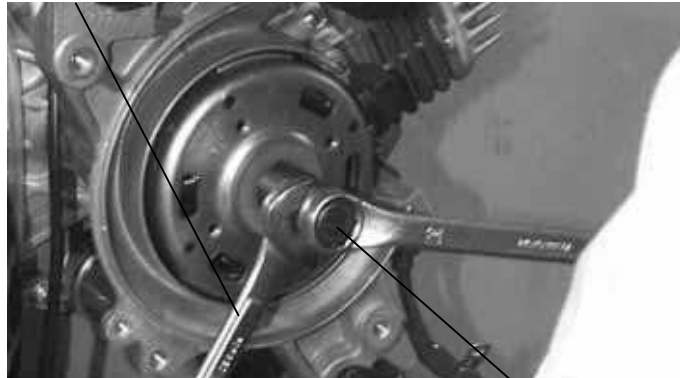

Flywheel Puller

Remove the A.C. generator wire connector.

A.C. Generator Wire Connector



Remove the two pulser coil bolts and pulser coil from the right crankcase.
Remove the pulser coil wire clamp from the right crankcase.
Remove the two bolts attaching the A.C. generator stator.

* Be careful not to damage the disconnected wire.

A.C. GENERATOR INSTALLATION

Install the A.C. generator stator and pulser coil wire clamp onto the right crankcase, and then install the pulser coil.

Stator

Wire Clamp

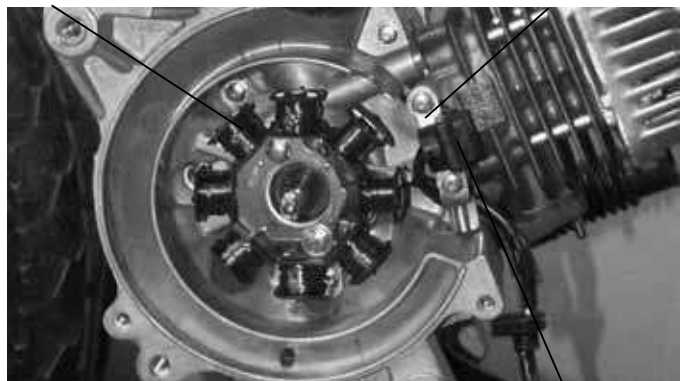

Pulser Coil

7. A.C. GENERATOR

Connect the A.C. generator wire connector.

A.C. Generator Wire Connector



Clean the taper hole in the flywheel off any burrs and dirt.
Install the woodruff key in the crankshaft keyway.

Woodruff Key

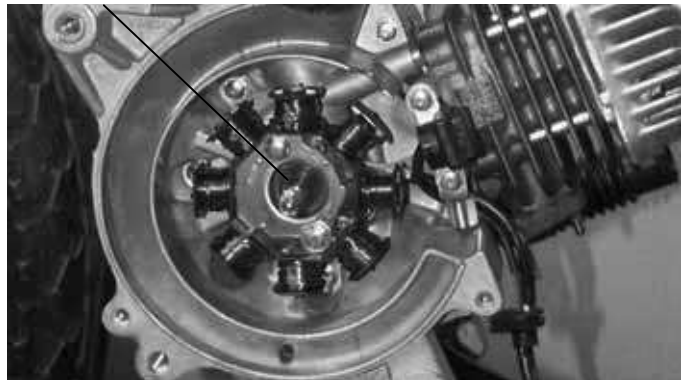

Install the flywheel onto the crankshaft with the flywheel groove aligned with the crankshaft woodruff key.
Hold the flywheel with the universal holder and install the 10mm flywheel flange nut.

Torque: 3.5~4.0kg-m

Start the engine and check the ignition timing. (⇒3-8)

Install other removed parts in the reserve order of removal.

Universal Holder



8. KICK STARTER/DRIVE PULLEY/ CLUTCH/DRIVEN PULLEY

KICK STARTER/DRIVE PULLEY/ CLUTCH/DRIVEN PULLEY

8

SERVICE INFORMATION	8- 3
TROUBLESHOOTING	8- 3
KICK STARTER.....	8- 4
DRIVE BELT	8- 8
DRIVE PULLEY	8-10
STARTER ONE-WAY CLUTCH DRIVE GEAR.....	8-12
CLUTCH/DRIVEN PULLEY.....	8-15

8. KICK STARTER/DRIVE PULLEY/ CLUTCH/DRIVEN PULLEY

MODEL BA10AB.AC.

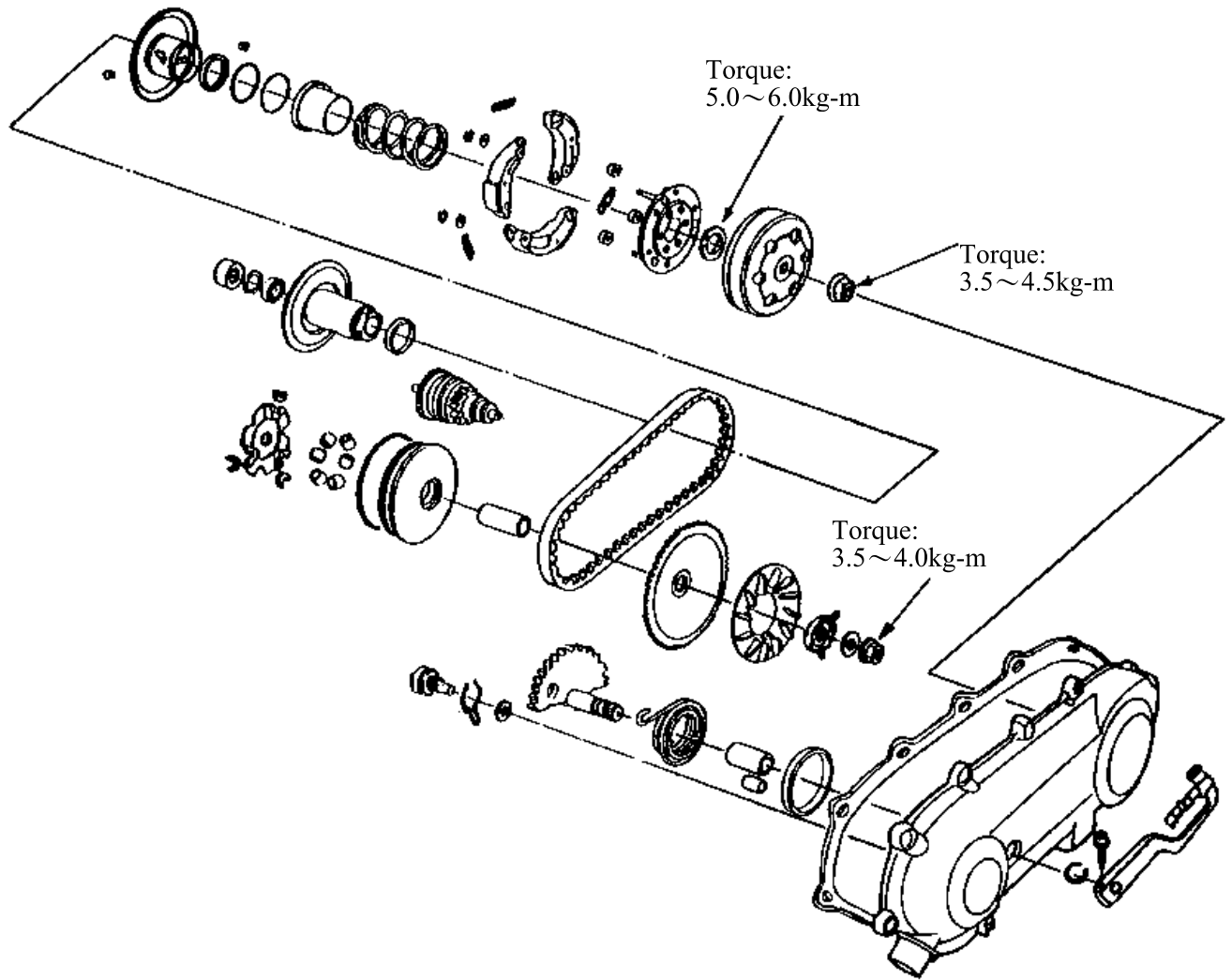

8. KICK STARTER/DRIVE PULLEY/ CLUTCH/DRIVEN PULLEY

SERVICE INFORMATION

GENERAL INSTRUCTIONS

- Avoid getting grease and oil on the drive belt and pulley faces.

SPECIFICATIONS	BA10AB.AC.50	
	Standard (mm)	Service Limit (mm)
Drive pulley collar O.D.	20.01~20.025	24.24
Movable drive face I.D.	20.035~20.085	19.97
Weight roller O.D.	13.0	12.4
Clutch outer I.D.	107~107.2	107.5
Driven face spring free length	87.9	82.6
Driven face O.D.	33.965~33.985	33.94
Movable driven face I.D.	34.0~34.25	34.06
Drive belt width	18	17

TORQUE VALUES

Drive face nut	3.5~4.0kg-m
Clutch outer nut	3.5~4.5kg-m
Clutch drive plate nut	5.0~6.0kg-m

SPECIAL TOOLS

Lock nut wrench, 39mm	Universal holder
Clutch spring compressor	Lock nut socket wrench, 32mm
Bearing outer driver 37x40mm	Bearing driver pilot, 17mm
One-way clutch puller	Outer driver, 24x26mm

TROUBLESHOOTING

Engine starts but motorcycle won't move

- Worn drive belt
- Broken ramp plate
- Worn or damaged clutch lining

Engine stalls or motorcycle creeps

- Broken clutch weight spring

Poor performance at high speed or lack of power

- Worn drive belt
- Weak driven face spring
- Worn weight roller
- Faulty driven face

8. KICK STARTER/DRIVE PULLEY/ CLUTCH/DRIVEN PULLEY

KICK STARTER

LEFT CRANKCASE COVER REMOVAL

Remove the drive belt cooling air tube connector circlip.
Remove the nine left crankcase cover bolts, left crankcase cover and dowel pins.
Inspect the left crankcase cover seal rubber for damage or deterioration.



Bolt

Left Crankcase Cover

KICK STARTER SPINDLE REMOVAL

Remove the kick lever from the kick starter spindle.
Remove the circlip and washer from the kick starter spindle.

Kick Starter Spindle

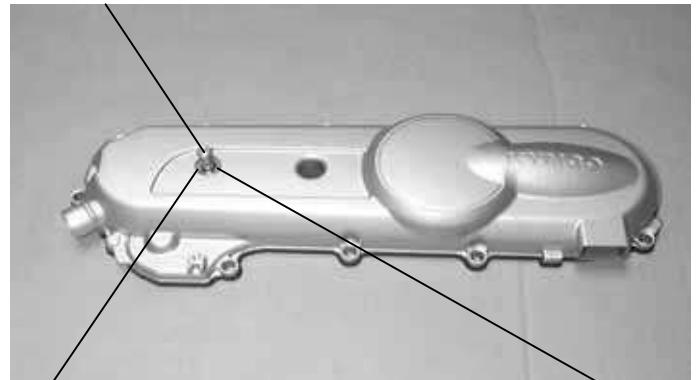

Washer

Circlip

Slightly rotate the kick starter spindle to remove the kick starter driven gear together with the friction spring.

Kick Starter Driven Gear

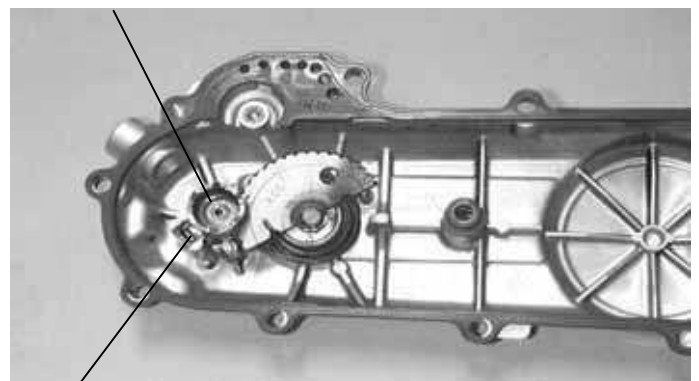

Friction Spring

8. KICK STARTER/DRIVE PULLEY/ CLUTCH/DRIVEN PULLEY

Remove the kick starter spindle and return spring from the left crankcase cover.
Remove the kick starter spindle bushing.

Kick Starter Spindle

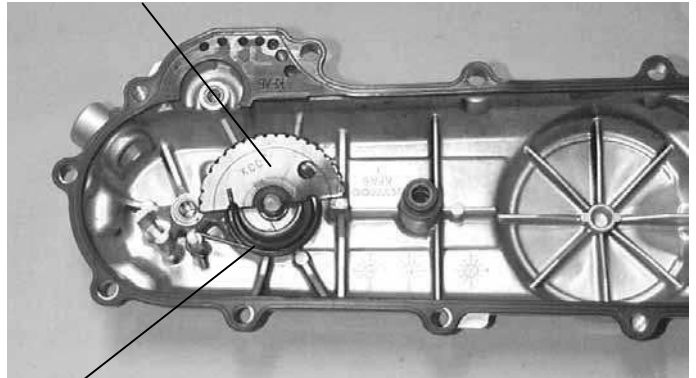

Return Spring

KICK STARTER SPINDLE INSPECTION

Inspect the kick starter spindle and gear for wear or damage.

Inspect the return spring for weakness or damage.

Inspect the kick starter spindle bushing for wear or damage.

Spindle

Return Spring



Plastic Bushing Spindle Bushing

Check the kick starter driven gear for wear or damage.

Check the friction spring for wear or damage.

Friction Spring



Kick Starter Driven Gear

8. KICK STARTER/DRIVE PULLEY/ CLUTCH/DRIVEN PULLEY

Inspect the kick starter spindle and driven gear forcing parts for wear or damage.

Kick Starter Spindle Forcing Part

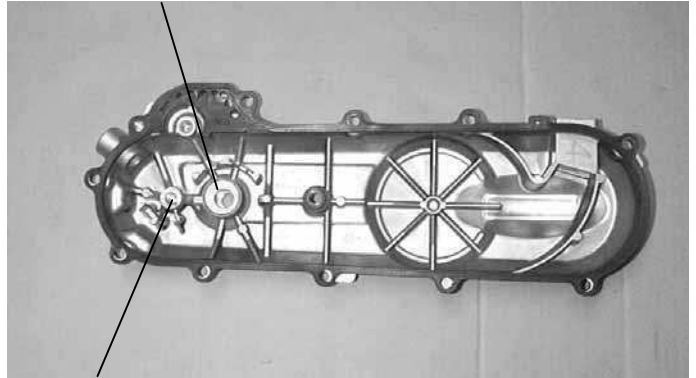

Kick Starter Driven Gear Forcing Part

KICK STARTER INSTALLATION

Install the kick starter spindle bushing and return spring onto the left crankcase cover.

*

If the hooks of the return spring can not be installed properly, use a screw driver to press them into their locations respectively.

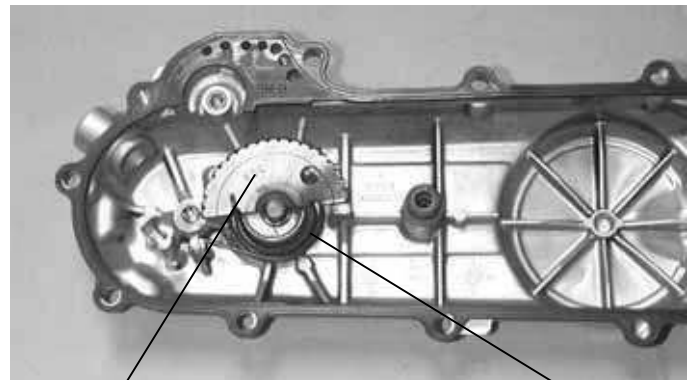

Kick Starter Spindle

Friction Spring

Properly install the kick starter driven gear and friction spring as the figure shown.

Kick Starter Driven Gear

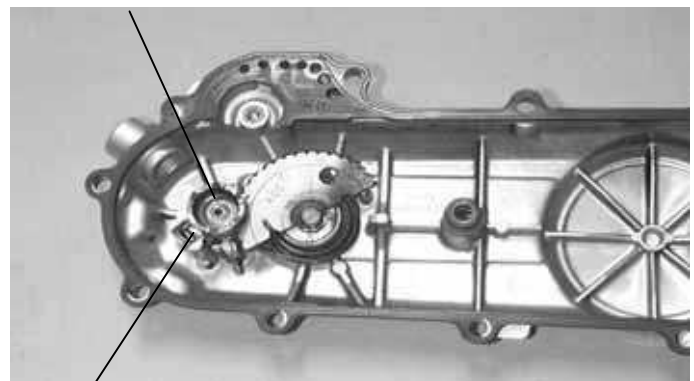

Friction Spring

8. KICK STARTER/DRIVE PULLEY/ CLUTCH/DRIVEN PULLEY

First install the washer and then the circlip onto the kick starter spindle.
Install the kick lever.

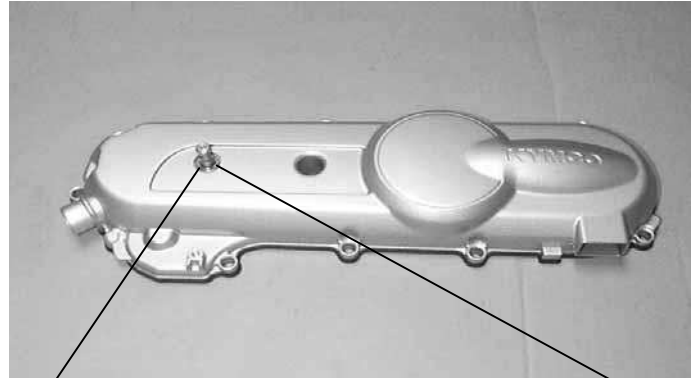

Washer

Circlip

LEFT CRANKCASE COVER INSTALLATION

First install the dowel pins and then the seal rubber.

Dowel Pins

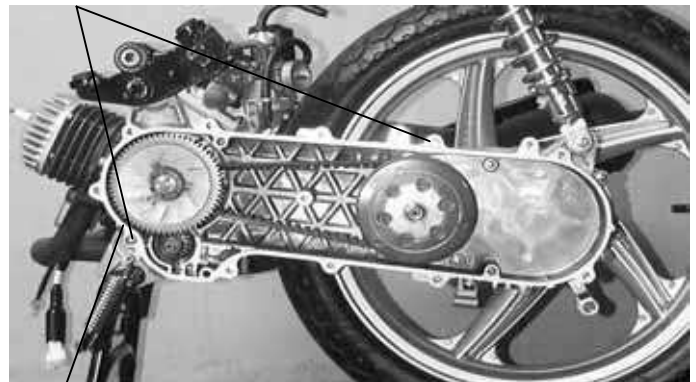

Seal Rubber

Install the left crankcase cover and tighten the ten bolts diagonally.
Connect the drive belt cooling air tube and install the circlip.

* For drum brake, note the location of the brake cable clamp and install the rear brake cable in place with the clamp.

Left Crankcase Cover



Rear Brake Cable Clamp

8. KICK STARTER/DRIVE PULLEY/ CLUTCH/DRIVEN PULLEY

DRIVE BELT

Remove the left crankcase cover.

INSPECTION

Check the drive belt for cracks, separation or abnormal or excessive wear.
Measure the drive belt width.

Service Limit:

BA10AB.AC.50: 16.5mm replace if below

*

Use specified genuine parts for replacement.

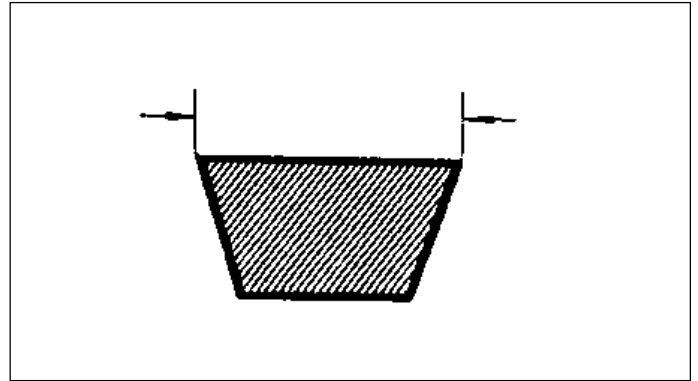

REPLACEMENT

Remove the ten left crankcase cover bolts and left crankcase cover. (⇒8-4)
Hold the clutch outer with the universal holder and remove the 10mm clutch outer nut and clutch outer.

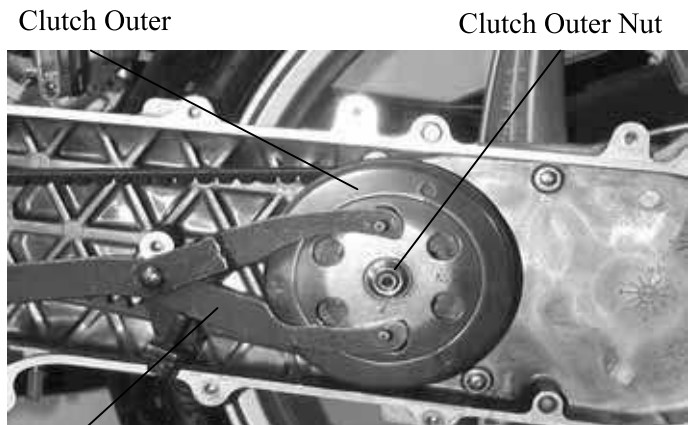

Universal Holder

Hold the drive pulley with the holder and remove the 12mm drive face nut.
Remove the starting ratchet.
Remove the drive pulley face.

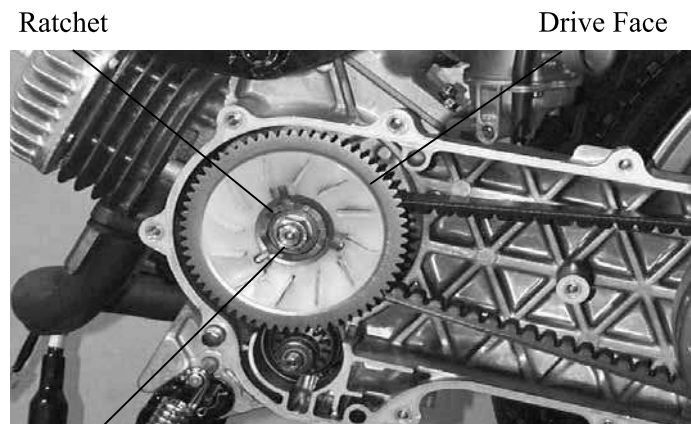

Drive Face Nut

8. KICK STARTER/DRIVE PULLEY/ CLUTCH/DRIVEN PULLEY

Remove the drive belt from the clutch/
driven pulley.

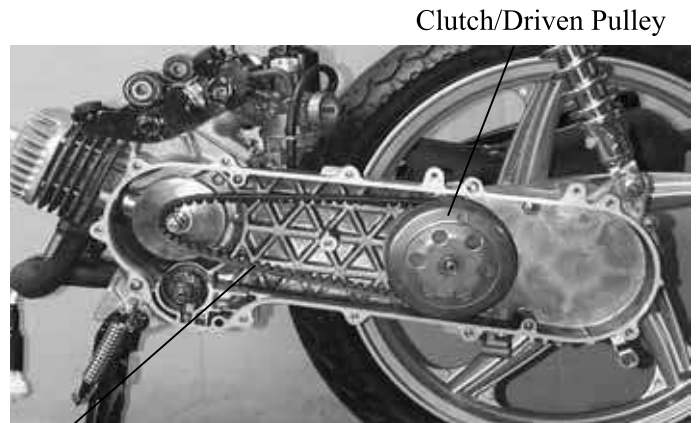

Drive Belt

DRIVE BELT INSTALLATION

Turn the driven pulley clockwise and lift it
up to expand the drive belt groove and then
install a new drive belt.

Drive Belt



Set the drive belt on the drive pulley.
Install the drive pulley face, starting ratchet
and 12mm washer, then tighten the drive
face nut.

Torque: 3.5~4.0kg-m

* When installing the drive face nut, make
sure that the tooth spaces of the drive
pulley face and starting ratchet align
with the teeth of the crankshaft.

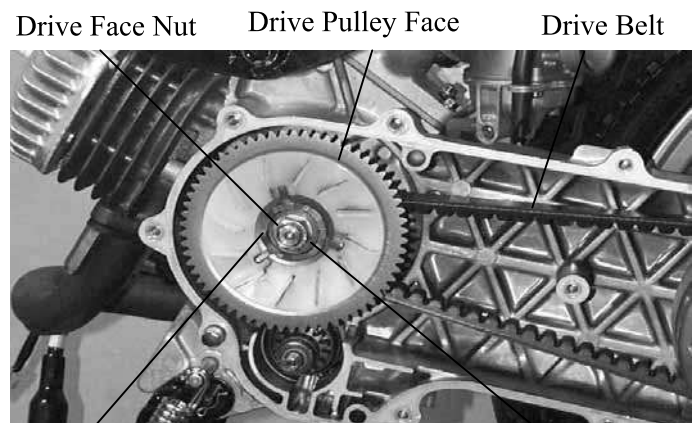

Starting Ratchet

12mm Washer

8. KICK STARTER/DRIVE PULLEY/ CLUTCH/DRIVEN PULLEY

DRIVE PULLEY

REMOVAL

Hold the drive pulley with the holder and remove the 12mm drive face nut. Remove the starting ratchet, 12mm washer and drive pulley face.

Drive Pulley Face

Starting Ratchet

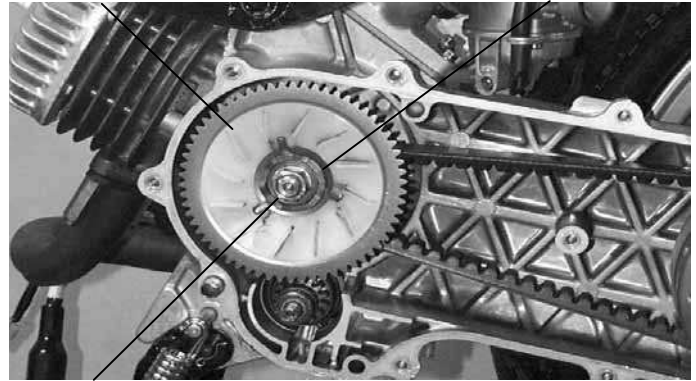

12mm Drive Face Nut

MOVABLE DRIVE FACE DISASSEMBLY

Remove the movable drive face and drive pulley collar from the crankshaft.

Drive Pulley Collar

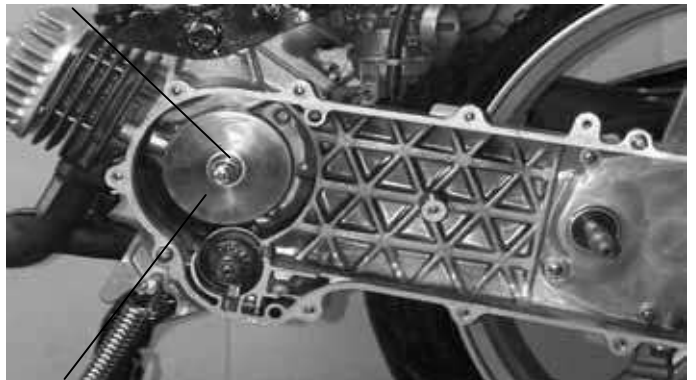

Movable Drive Face

Remove the ramp plate.

Ramp Plate

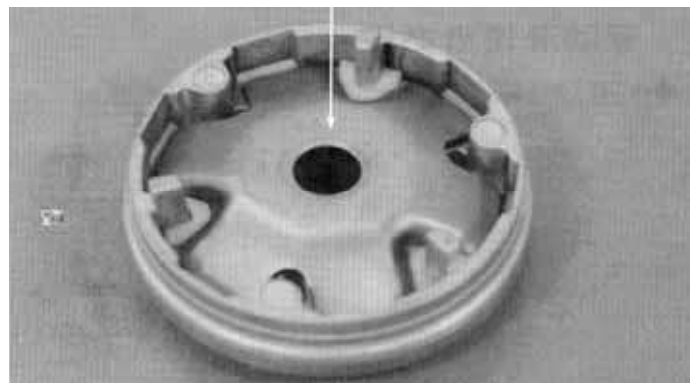

8. KICK STARTER/DRIVE PULLEY/ CLUTCH/DRIVEN PULLEY

Remove the weight rollers.

Weight Roller

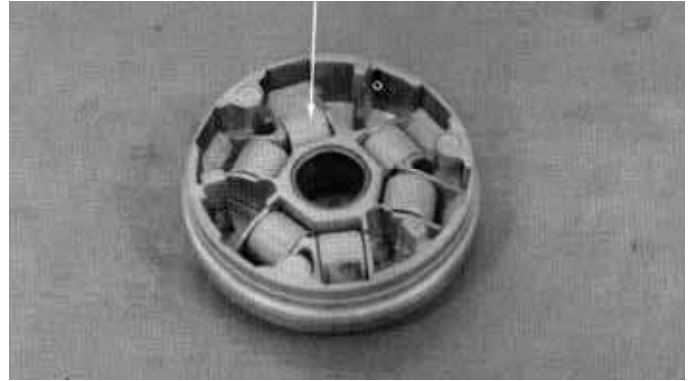

MOVABLE DRIVE FACE INSPECTION

Check each weight roller for wear or damage.

Measure each roller O.D.

Service Limit:

BA10AB.AC.50: 12.4mm replace if below

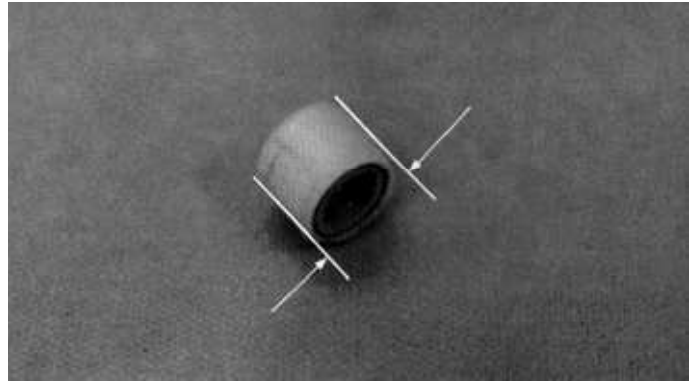

DRIVE PULLEY INSTALLATION

Install the drive pulley collar and movable drive face onto the crankshaft.

Movable Drive Face

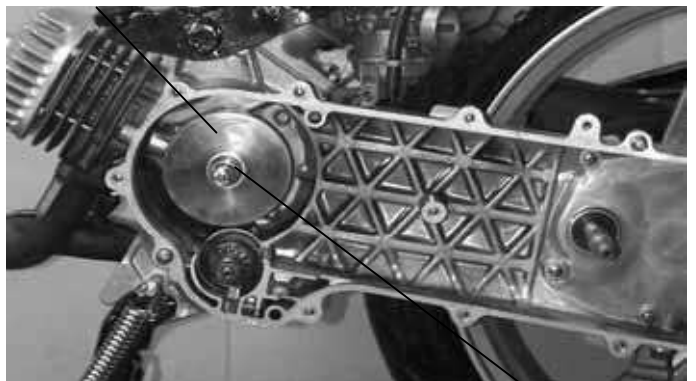

Drive Pulley Collar

8. KICK STARTER/DRIVE PULLEY/ CLUTCH/DRIVEN PULLEY

Install the drive belt on the crankshaft.
Install the drive face, starting ratchet and
washer, then tighten the 12mm drive face
nut.

Torque: 3.5~4.0kg-m

Keep grease or oil off the drive belt and
drive pulley faces.

Drive Pulley Face

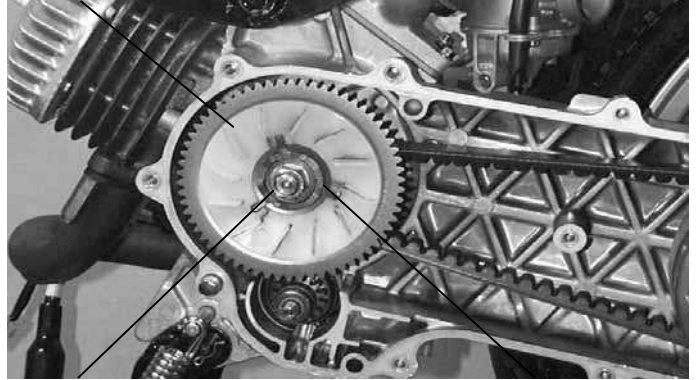

Drive Face Nut

Starting Ratchet

STARTER PINION REMOVAL

Remove the left crankcase cover. (⇒8-4)
Remove the drive pulley. (⇒8-8)
Remove the starter pinion.

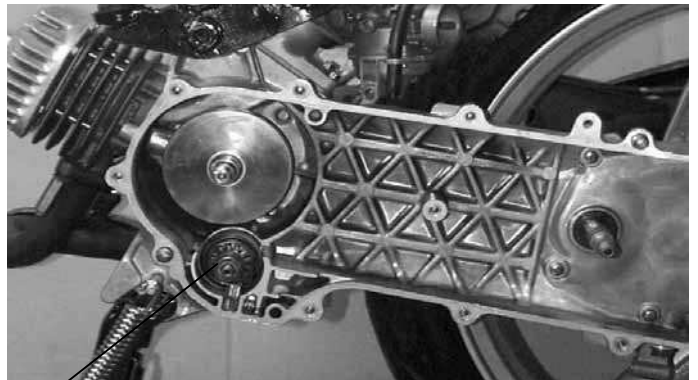

Starter Pinion

INSPECTION

Inspect the starter pinion seat for wear.
Inspect the starter pinion for smooth
operation.
Inspect the starter pinion shaft forcing parts
for wear and damage.

INSTALLATION

Apply a small amount of grease to the
starter pinion teeth.
Install the starter pinion in the reverse order
of removal.

Shaft Forcing Parts



Starter Pinion

8. KICK STARTER/DRIVE PULLEY/ CLUTCH/DRIVEN PULLEY

CLUTCH/DRIVEN PULLEY

CLUTCH/DRIVEN PULLEY REMOVAL

Remove the drive pulley. (⇒8-8)
Hold the clutch outer with the universal holder and remove the 10mm clutch outer nut.
Remove the clutch outer.

Universal Holder

Clutch Outer

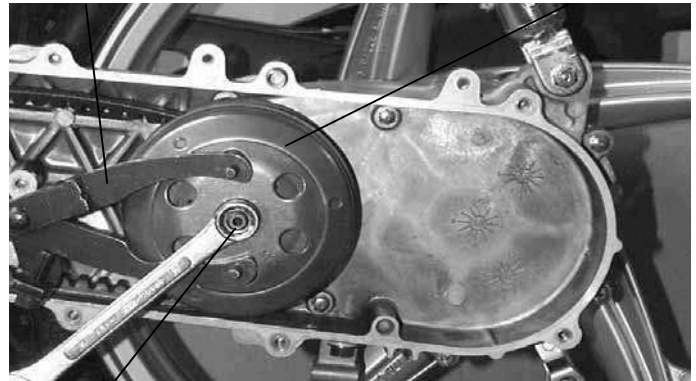

10mm Clutch Outer Nut

Remove the clutch/driven pulley.
Remove the drive belt from the clutch/driven pulley.

Clutch/Driven Pulley

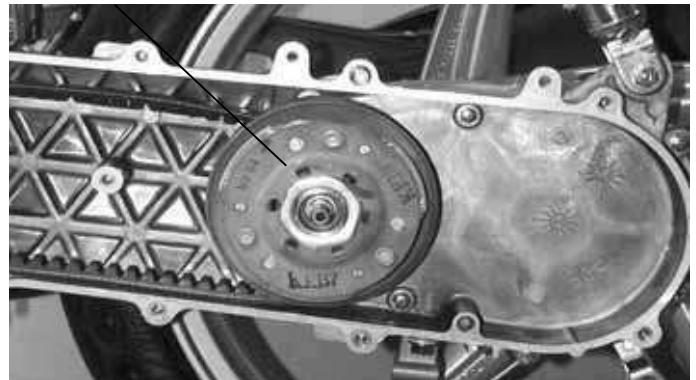

CLUTCH/DRIVEN PULLEY DIS- ASSEMBLY

Compress the clutch/driven pulley spring with the clutch spring compressor and remove the 28mm drive plate nut.
Remove the driven face spring.

Lock Nut Wrench, 39mm

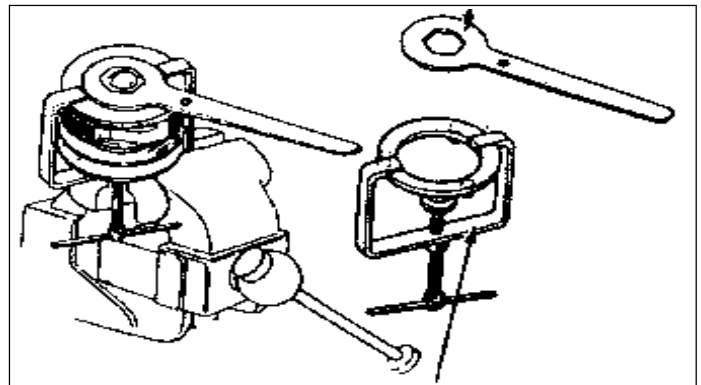

Clutch Spring Compressor

8. KICK STARTER/DRIVE PULLEY/ CLUTCH/DRIVEN PULLEY

Remove the seal collar.

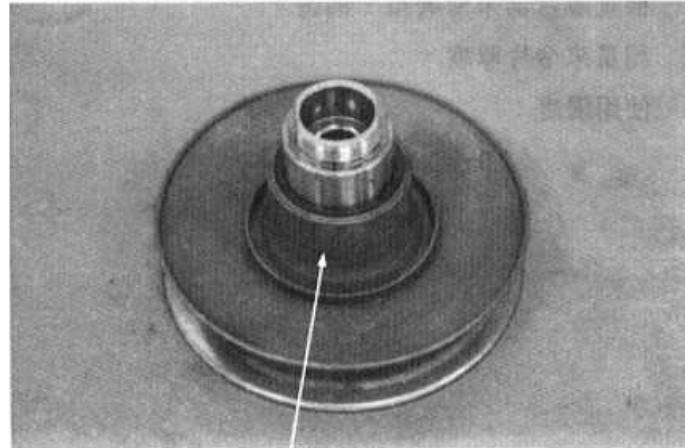

Seal Collar

Pull out the guide roller pins from the driven pulley and then remove the O-rings and oil seal from the driven pulley.

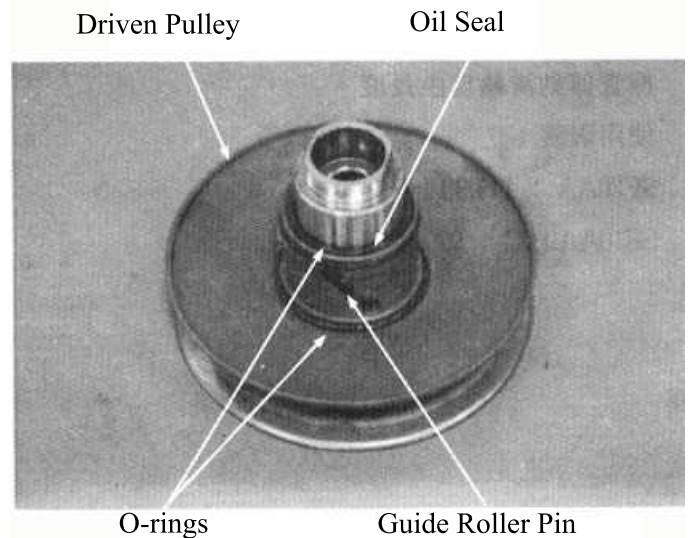

Driven Pulley

Oil Seal

O-rings

Guide Roller Pin

CLUTCH/DRIVEN PULLEY INSPECTION

Inspect the clutch outer for wear or damage.
Measure the clutch outer I.D.

Service Limit:

BA10AB.AC.50: 107.5mm replace if below

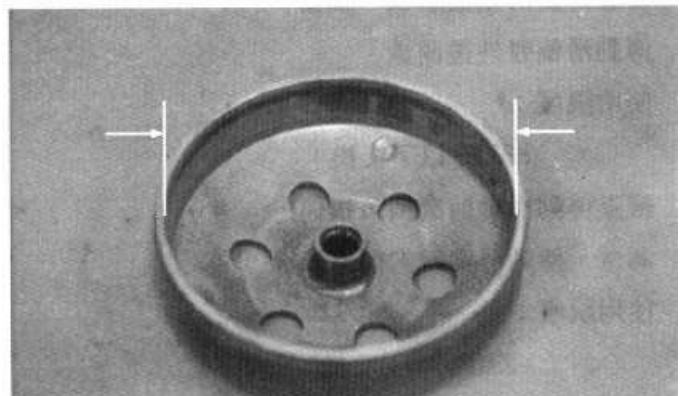

8. KICK STARTER/DRIVE PULLEY/ CLUTCH/DRIVEN PULLEY

Check the clutch shoes for wear or damage.
Measure the clutch lining thickness.

Service Limit: 2.0mm replace if below

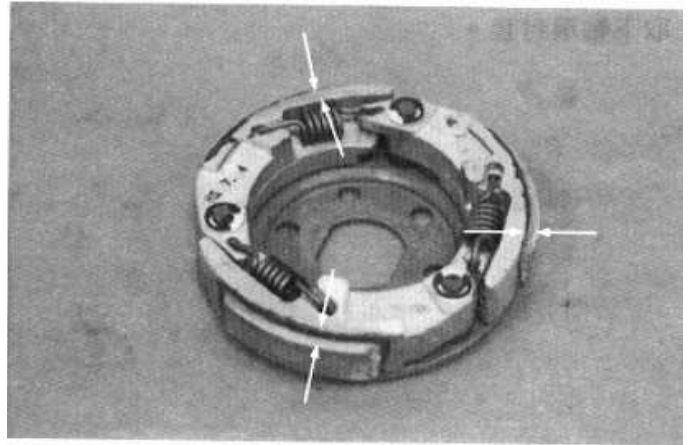

Measure the driven face spring free length.

Service Limit:

BA10AB.AC.50: 82.6mm replace if below

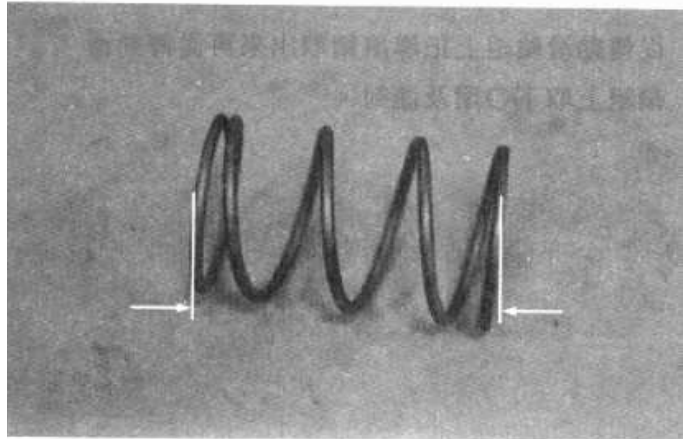

Check the driven face assembly for wear or damage.

Measure the driven face O.D.

Service Limit: 33.94mm replace if below

Check the movable driven face for wear or damage.

Measure the movable driven face I.D.

Service Limit: 34.06mm replace if below

Check the guide roller pins for stepped wear.

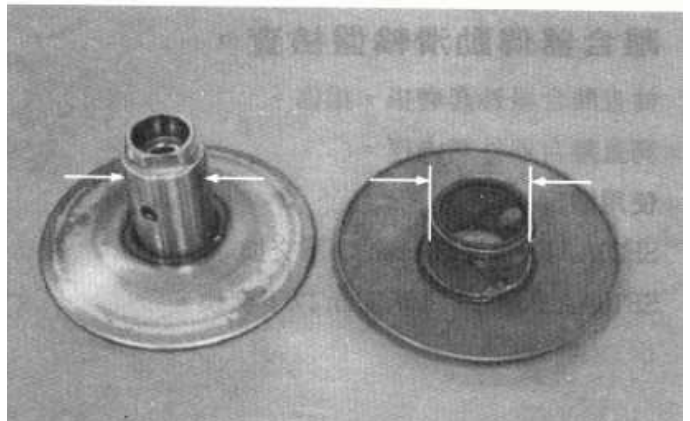

8. KICK STARTER/DRIVE PULLEY/ CLUTCH/DRIVEN PULLEY

DRIVEN PULLEY FACE BEARING REPLACEMENT

Check the needle bearings in the driven face and replace them if they have excessive play, damage or abnormal noise. Drive the inner bearing out of the driven pulley face.

Remove the snap ring and drive the outer bearing out of the driven face.

Drive a new outer bearing into the driven face with the sealed end facing up. Seat the snap ring in its groove.

* Pack all bearing cavities with 5.0~5.6g grease.
Specified grease: 230°C Heat-resistant grease

Inner Bearing

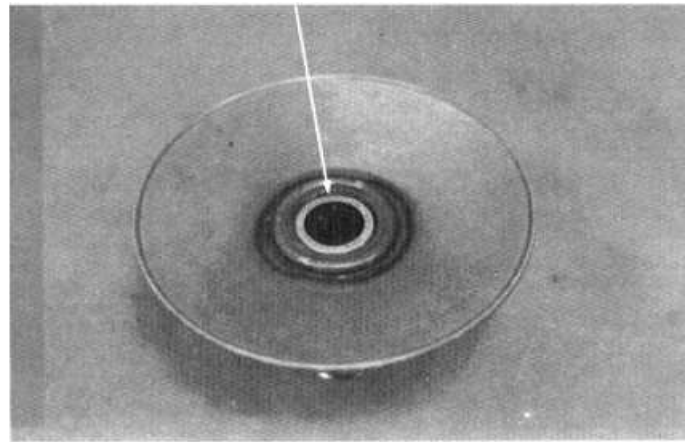

Snap Ring

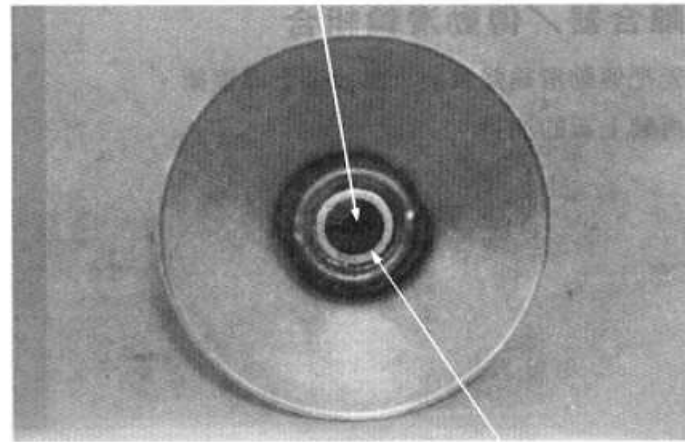

Outer Bearing

Bearing Outer Driver, 37x40mm

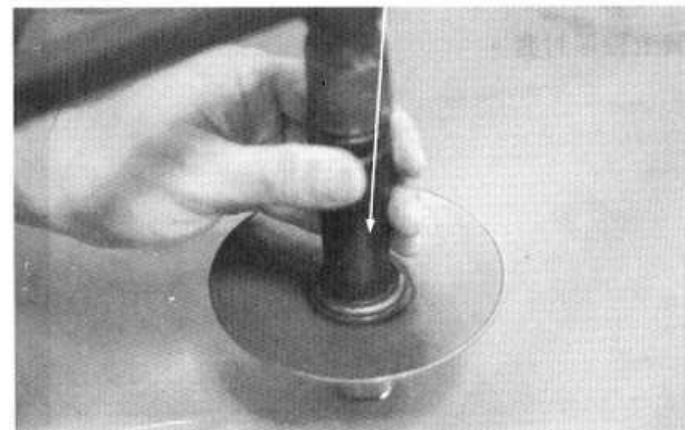

8. KICK STARTER/DRIVE PULLEY/ CLUTCH/DRIVEN PULLEY

Drive in a new needle bearing into the driven face with the mark facing up.

Bearing Driver Pilot

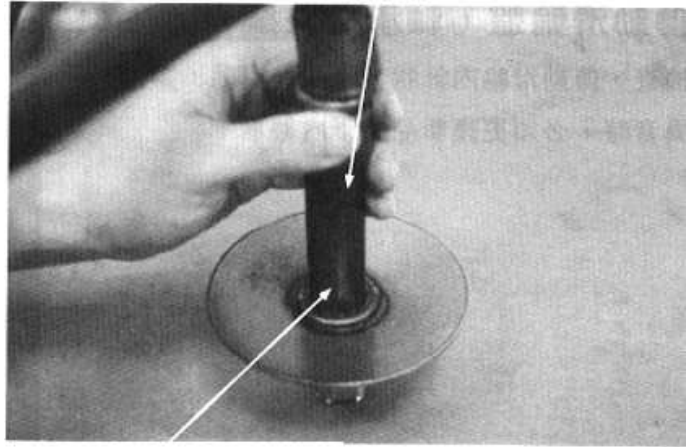

Outer Driver, 24x26mm

CLUTCH/DRIVEN PULLEY ASSEMBLY

First install the movable driven face onto the driven face. Then, install the guide roller pins, O-rings and a new oil seal.

Driven Pulley

Oil Seal

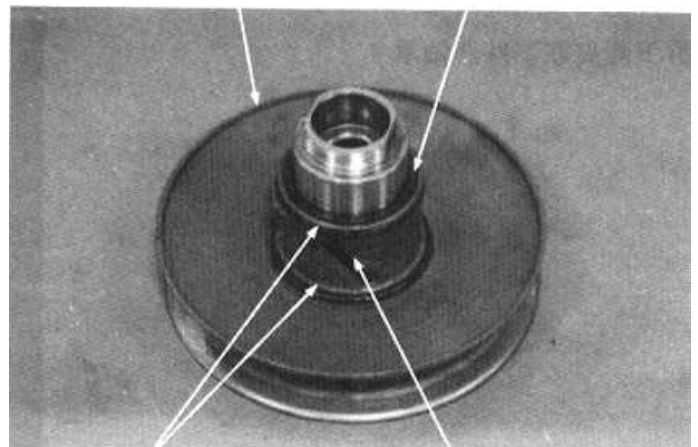

O-rings

Guide Roller Pin

Install the seal collar.

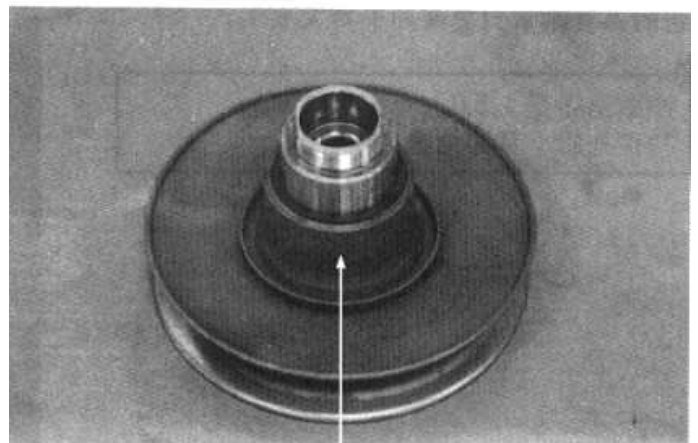

Seal Collar

8. KICK STARTER/DRIVE PULLEY/ CLUTCH/DRIVEN PULLEY

Set the driven pulley, driven face spring and clutch assembly onto the clutch spring compressor. Compress the tool and install the 28mm drive plate nut. Tighten the 28mm nut to the specified torque.

Torque: 5.0~6.0kg-m

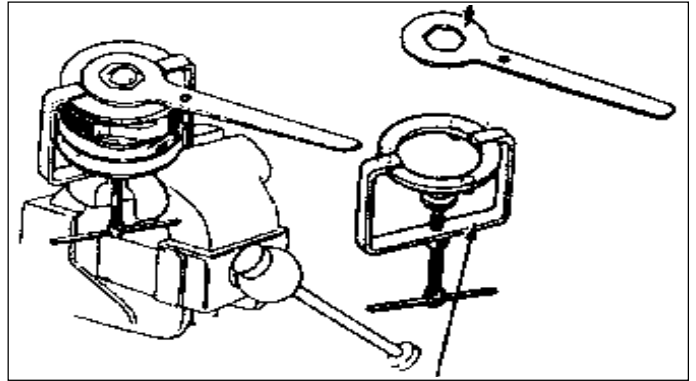

CLUTCH/DRIVEN PULLEY INSTALLATION

Install the drive belt on the clutch/driven pulley and then install the clutch/driven pulley onto the drive shaft.

Clutch/Driven Pulley

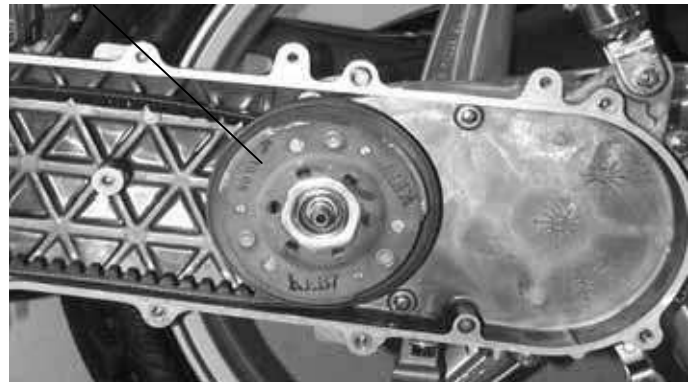

Install the clutch outer.
Hold the clutch outer with the universal holder.
Install and tighten the 10mm clutch outer nut.

Torque: 3.5~4.5kg-m

Install the left crankcase cover. (⇒8-7)

Universal Holder



Clutch Outer

9. FINAL REDUCTION

FINAL REDUCTION

SERVICE INFORMATION	9-2
TROUBLESHOOTING	9-2
FINAL REDUCTION DISASSEMBLY	9-3
FINAL REDUCTION INSPECTION.....	9-3
FINAL REDUCTION ASSEMBLY	9-6



9. FINAL REDUCTION

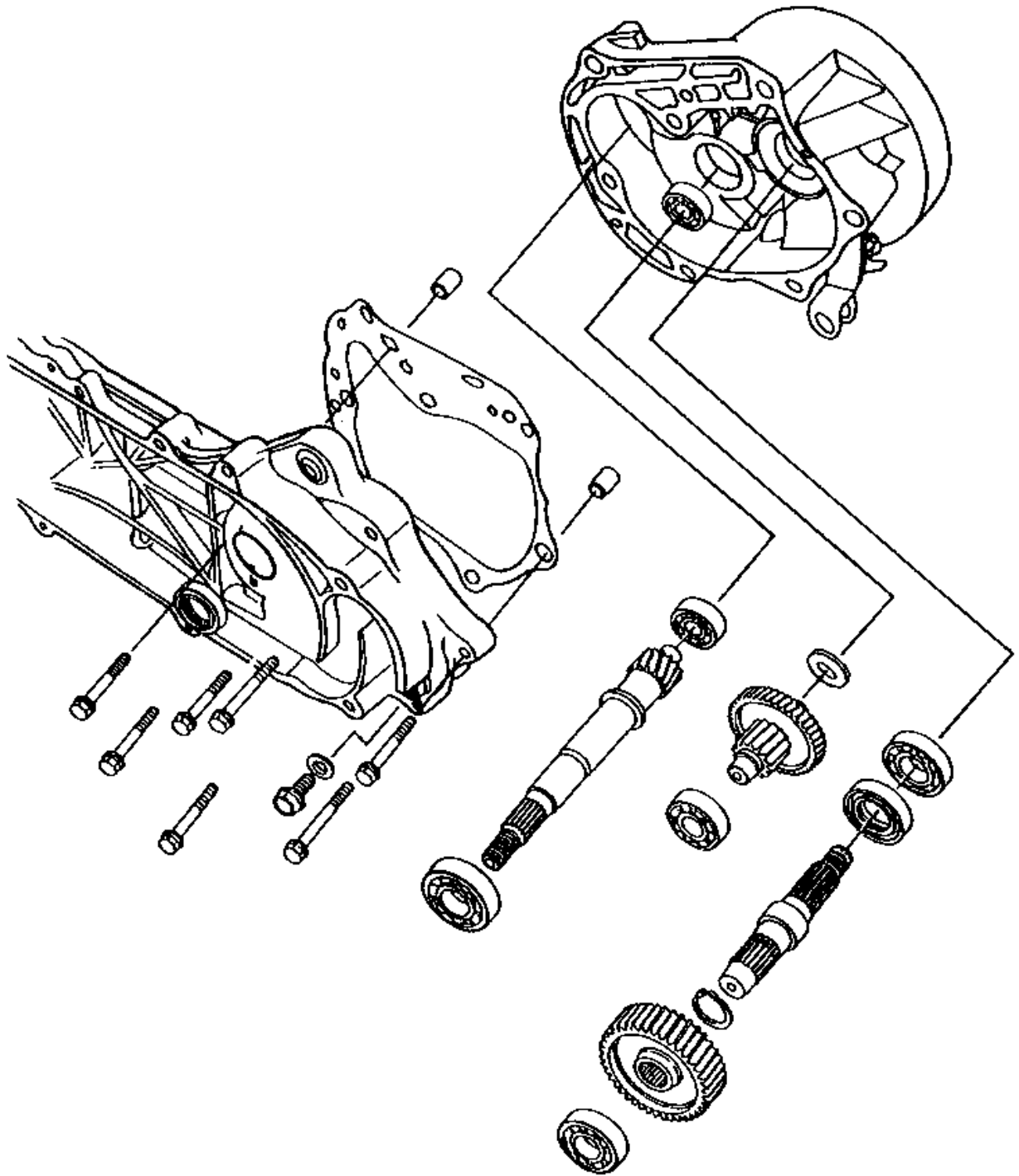

9. FINAL REDUCTION

SERVICE INFORMATION

Specified Oil: SAE90#
At disassembly: 0.12 liter
At change: 0.1 liter

SPECIAL TOOLS

Bearing remover set, 12mm
Bearing remover set, 15mm
Crankcase assembly collar
Crankcase assembly shaft
Bearing outer driver, 37x40mm
Bearing outer driver, 32x35mm
Bearing driver pilot, 17mm
Bearing driver pilot, 15mm
Bearing driver pilot, 12mm
Bearing outer driver handle A

TROUBLESHOOTING

Engine starts but motorcycle won't move

- Damaged transmission
- Seized or burnt transmission

Abnormal noise

- Worn, seized or chipped gears
- Worn bearing

Oil leaks

- Oil level too high
- Worn or damaged oil seal

9. FINAL REDUCTION

FINAL REDUCTION DISASSEMBLY

Remove the rear wheel. (⇒14-3)
Remove the left crankcase cover. (⇒8-4)
Remove the clutch/driven pulley. (⇒8-15)
Drain the transmission gear oil into a clean container.
Remove the transmission case cover attaching bolts.
Remove the transmission case cover.
Remove the gasket and dowel pins.

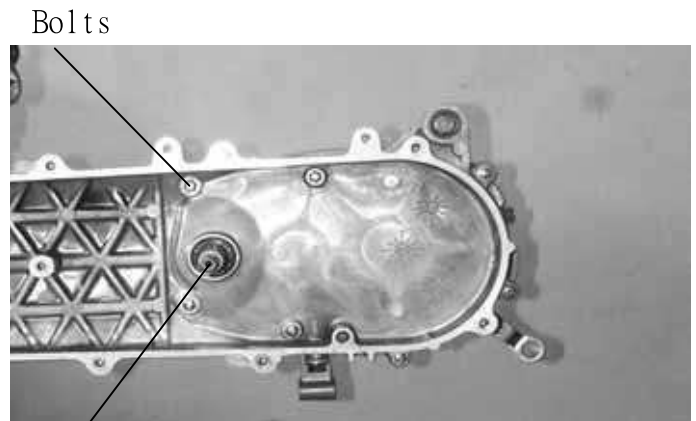

Driver shift

Remove the final gear and countershaft.

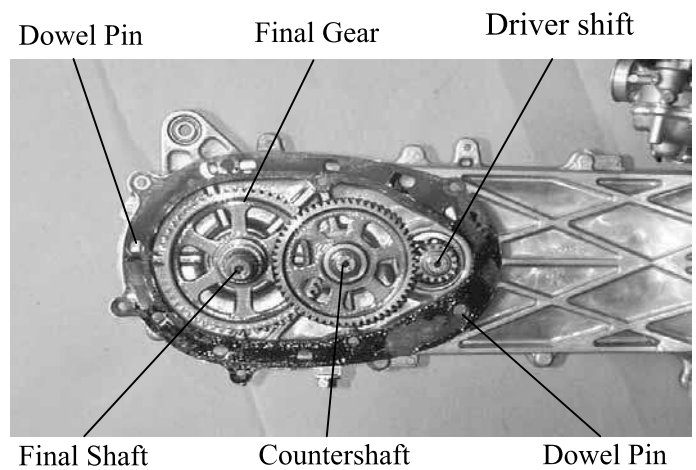

FINAL REDUCTION INSPECTION

Inspect the countershaft and gear for wear or damage.



Countershaft

9. FINAL REDUCTION

Inspect the final gear and final shaft for wear, damage or seizure.



Check the left crankcase bearings for excessive play and inspect the oil seal for wear or damage.

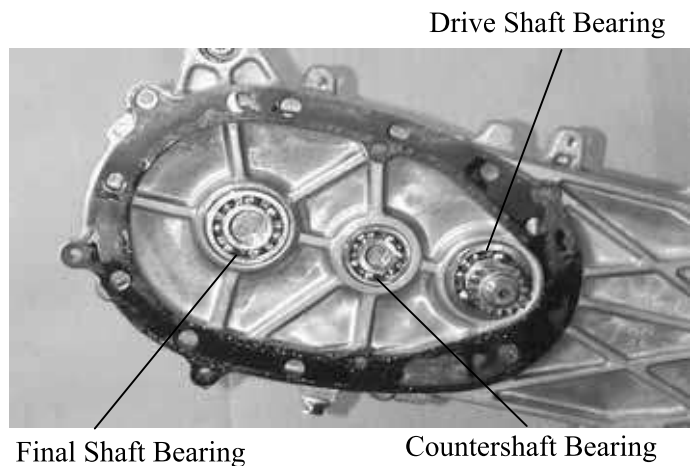

Inspect the drive shaft and gear for wear or damage.
Check the transmission case cover bearings for excessive play and inspect the final shaft bearing oil seal for wear or damage.

* Do not remove the transmission case cover except for necessary part replacement. When replacing the drive shaft, also replace the bearing and oil seal.

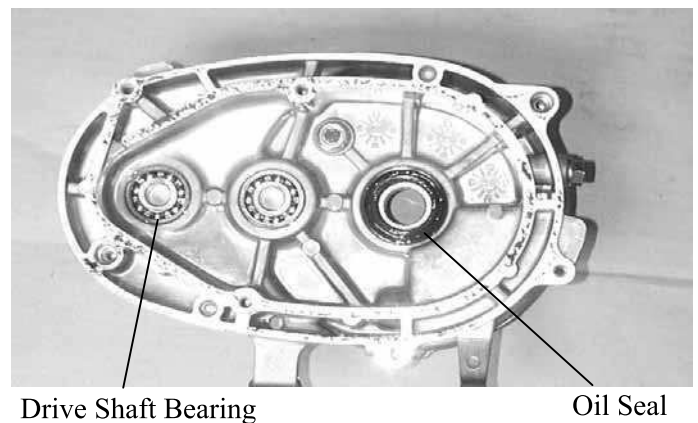

9. FINAL REDUCTION

BEARING REPLACEMENT (Transmission Case Cover)

Remove the transmission case cover bearings using the bearing remover.
Remove the final shaft oil seal.

Drive Shaft Bearing

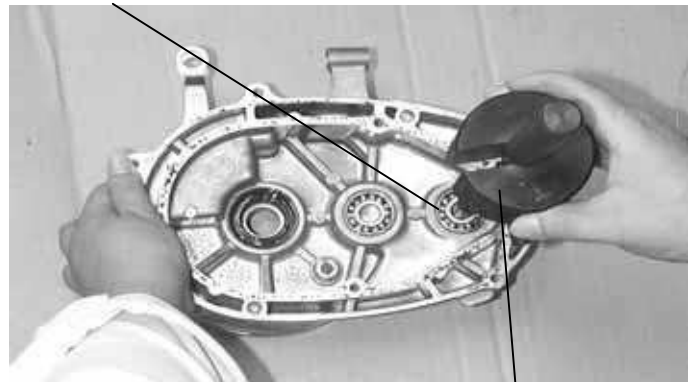

Bearing Remover Set

Drive new bearings into the transmission case cover.

Bearing Outer Driver Handle A

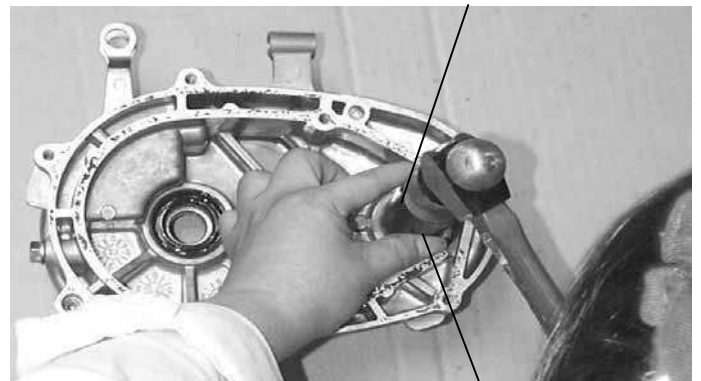

Bearing Outer Driver, 32x35mm

BEARING REPLACEMENT (Left Crankcase Cover)

Remove the drive shaft.
Remove the drive shaft oil seal.
Remove the left crankcase bearings using the bearing remover.

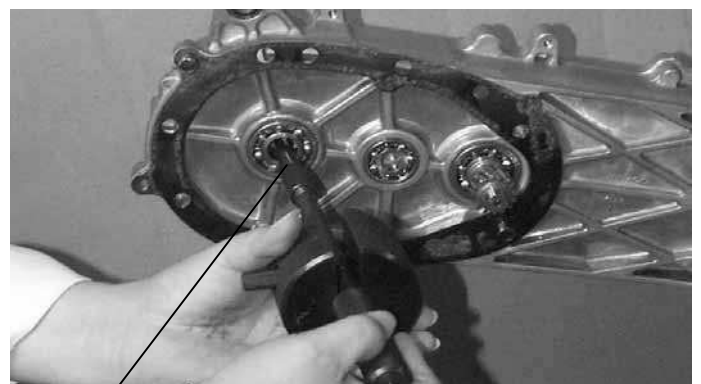

Bearing Remover Set, 12mm

9. FINAL REDUCTION

Drive new bearings into the left crankcase.
Install a new drive shaft oil seal.



Bearing Outer Driver

FINAL REDUCTION ASSEMBLY

Install the drive shaft into the left crankcase.

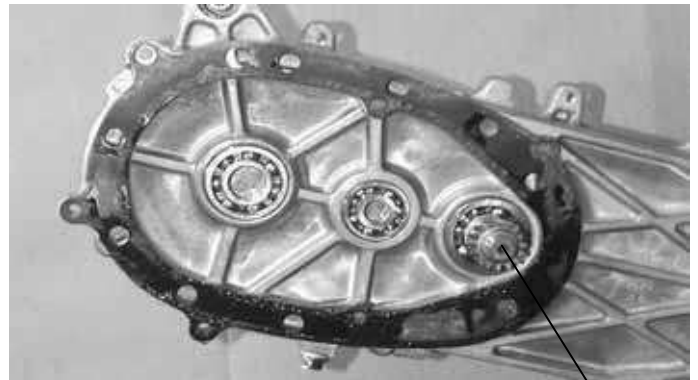

Drive Shaft

Install the final gear and final shaft into the left crankcase.



9. FINAL REDUCTION

Install the countershaft and gear into the left crankcase.
Install the resin washer onto the counter-
shaft.
Install the dowel pins and a new gasket.

Dowel Pins

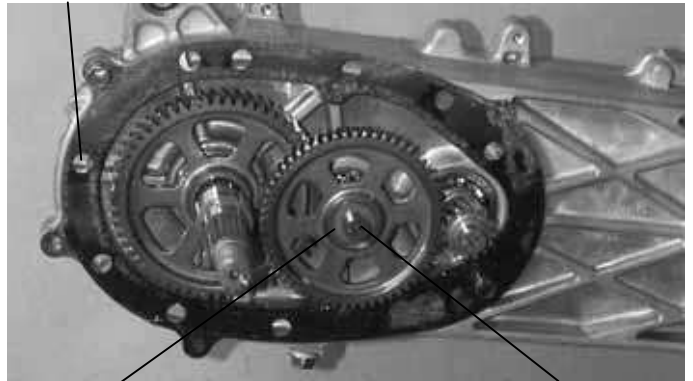

Resin Washer

Countershaft

Install the transmission case cover.

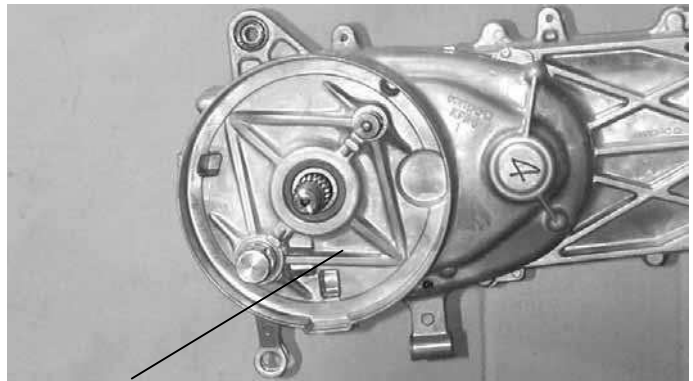

Transmission Case Cover

Install and tighten the transmission case
cover bolts.
Install the clutch/driven pulley. (\Rightarrow 8-20)
Install other removed parts in the reverse
order of removal.

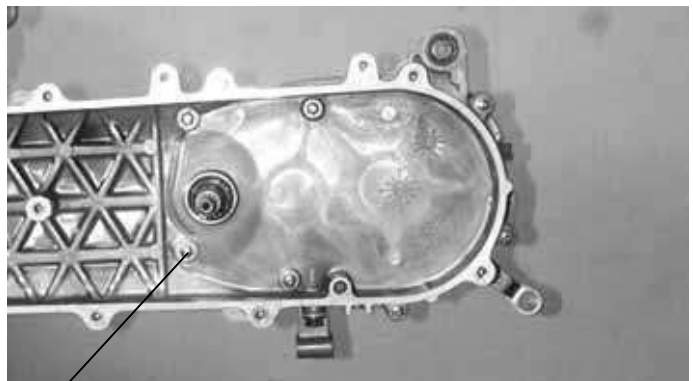

Bolts

9. FINAL REDUCTION

After installation, fill the transmission case with the specified oil.

*

- Place the motorcycle on its main stand on level ground.
- Check the sealing washer for wear or damage.

Specified Gear Oil: SAE90#

Oil Capacity: at disassembly: 0.12 liter
at change: 0.09 liter

Install and tighten the oil check bolt.

Torque: 1.0~1.5kg-m

Start the engine and check for oil leaks.
Check the oil level from the oil check bolt hole and add the specified oil to the proper level if the oil level is low.

Oil Check Bolt Hole/Filler

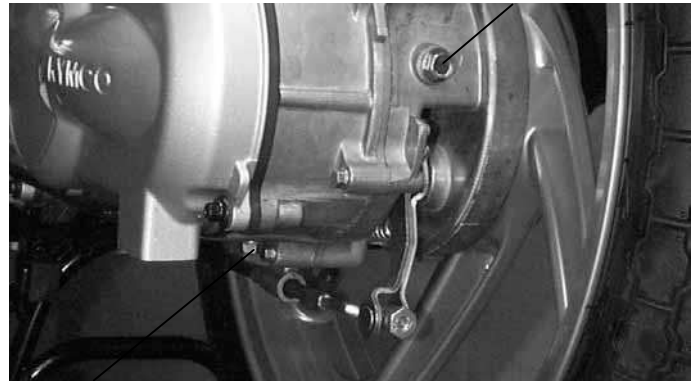

Drain Bolt

10. CRANKCASE/CRANKSHAFT

CRANKCASE/CRANKSHAFT

SERVICE INFORMATION	10-2
TROUBLESHOOTING	10-2
CRANKCASE SEPARATION	10-3
CRANKSHAFT REMOVAL.....	10-3
CRANKSHAFT INSPECTION	10-4
CRANKSHAFT INSTALLATION	10-5
CRANKCASE ASSEMBLY.....	10-7

10

10. CRANKCASE/CRANKSHAFT

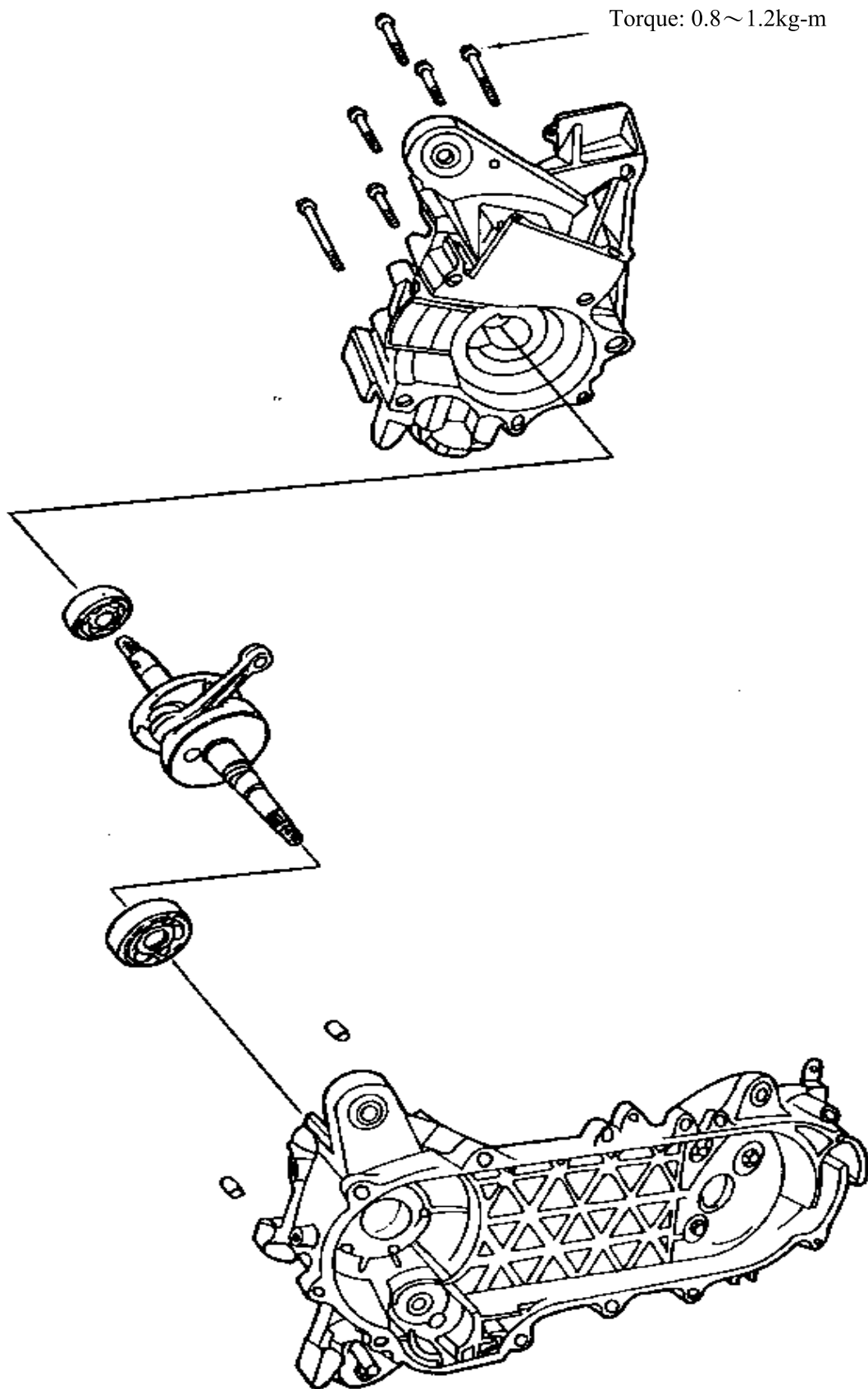

10. CRANKCASE/CRANKSHAFT

SERVICE INFORMATION

GENERAL INSTRUCTIONS

- This section covers crankcase separation to service the crankshaft.
- The following parts must be removed before separating the crankcase.
 - Engine (⇒Section 5)
 - Driven pulley (⇒Section 9)
 - Carburetor (⇒Section 11)
 - A.C. generator (⇒Section 7)
 - Oil pump (⇒Section 4)
 - Cylinder head/cylinder (⇒Section 6)
 - Reed valve (⇒Section 11)
- When the left crankcase must be replaced, remove the following part in addition to the above.
 - Final reduction removal
- Special tools must be used for crankshaft and crankcase assembly. When separating the crankcase, the bearing will remain in the crankcase and it should be removed. When assembling, drive a new bearing into the crankcase and install a new oil seal.

SPECIFICATIONS	BA10AB.AC.50	
	Standard (mm)	Service Limit (mm)
Connecting rod big end side clearance	—	0.60
Connecting rod big end radial clearance	—	0.04
Crankshaft runout A/B	—	0.15/0.10

SPECIAL TOOLS

Crankcase puller	Bearing outer driver handle A
Universal bearing puller	Bearing outer driver, 42x47mm
Crankcase assembly collar	Bearing driver pilot, 20mm
Crankcase assembly tool	Bearing outer driver, 37x40mm
	Bearing driver pilot, 17mm

TROUBLESHOOTING

Abnormal engine noise

- Excessive crank journal bearing play
- Excessive crankpin bearing play
- Excessive transmission bearing play

10. CRANKCASE/CRANKSHAFT

CRANKCASE SEPARATION

Remove the crankcase attaching bolts.

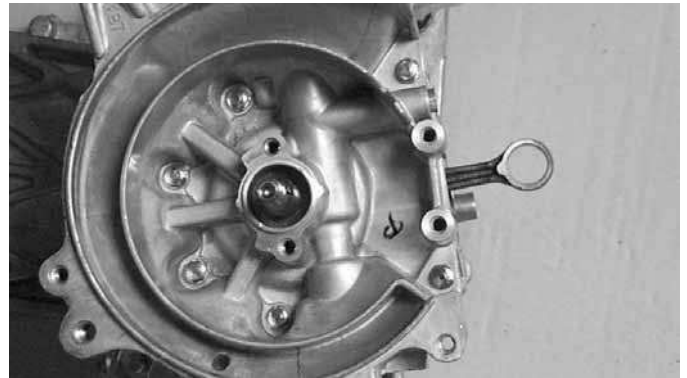

Attach the crankcase puller on the right crankcase and remove the right crankcase from the left crankcase.

Crankcase Puller

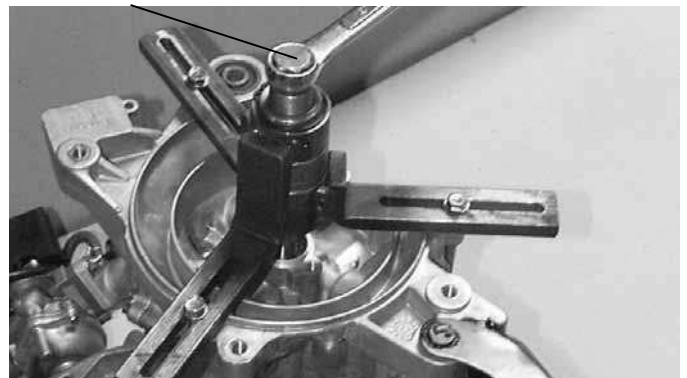

CRANKSHAFT REMOVAL

Attach the crankcase puller on the left crankcase and remove the crankshaft from the left crankcase.

* When removing the crankshaft, do it slowly and gently.

Crankcase Puller



10. CRANKCASE/CRANKSHAFT

Remove the remaining bearing on the crankshaft side using the universal bearing puller.

* When separating the crankcase, the oil seals must be removed. Replace the oil seals with new ones.

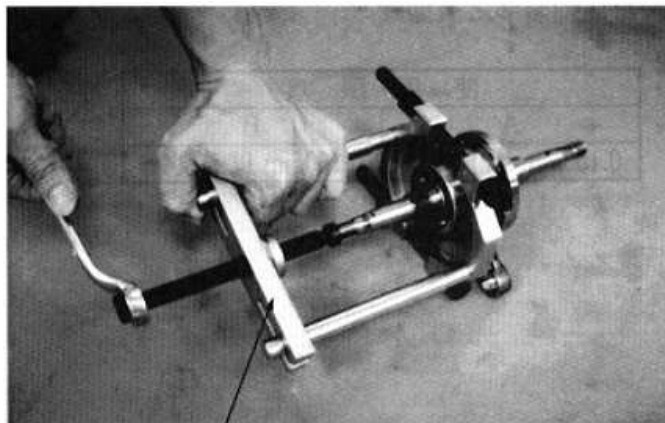

Universal Bearing Puller

CRANKSHAFT INSPECTION

Measure the connecting rod big end side clearance.

Service Limit: 0.6mm replace if over

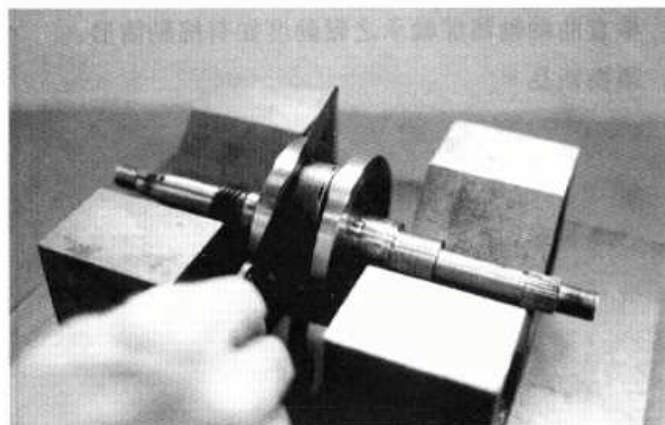

Measure the connecting rod big end radial clearance at two points in the X and Y directions.

Service Limit: 0.04mm replace if over

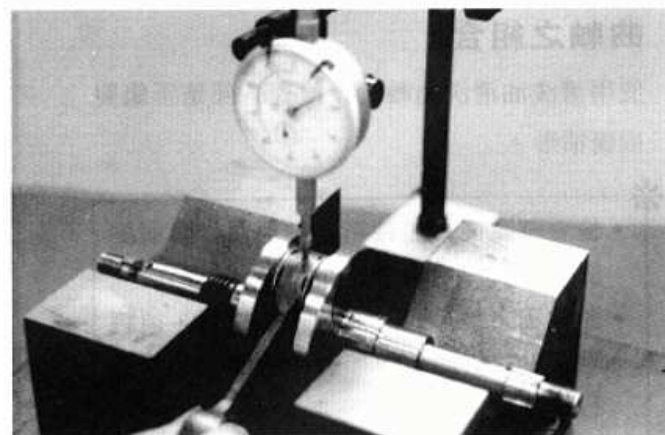

10. CRANKCASE/CRANKSHAFT

Measure the crankshaft runout.

Service Limit	
A	B
0.150mm replace if over	0.100mm replace if over

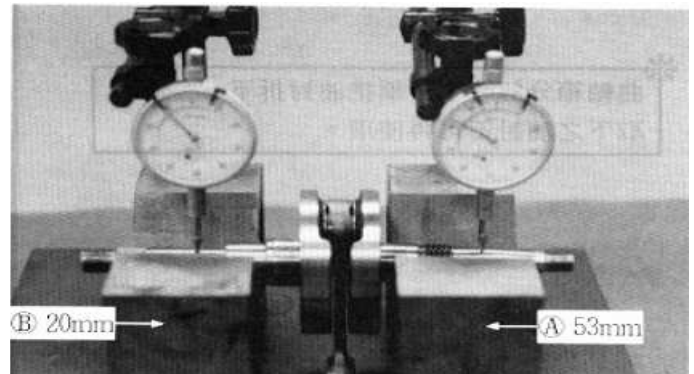

Check the crankshaft bearings for excessive play. The bearings must be replaced if they are noisy or have excessive play.

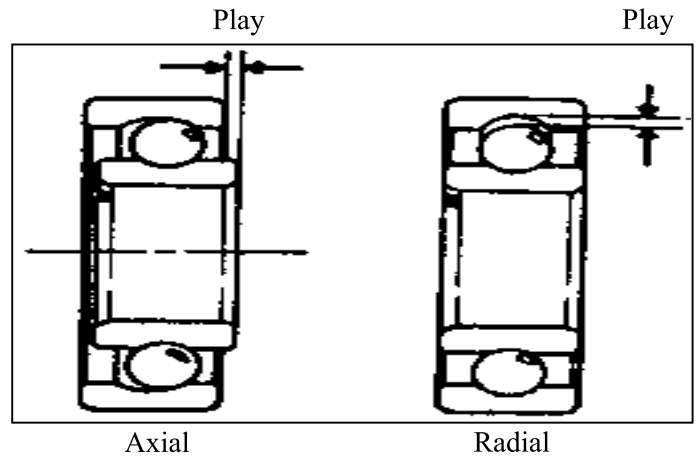

CRANKSHAFT INSTALLATION

Wash the crankshaft in cleaning solvent and then check for cracks or other faults.

*

- After check, apply clean engine oil to all moving and sliding parts.
- Remove all gasket material from the crankcase mating surfaces. Dress any roughness or irregularities with an oil stone.

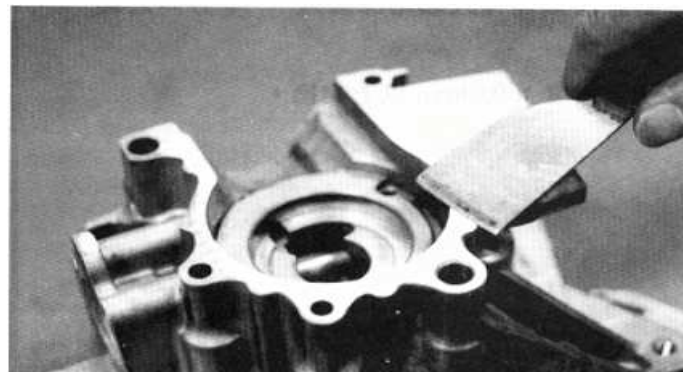

10. CRANKCASE/CRANKSHAFT

Drive a new crankshaft bearing into the right crankcase.

Bearing Outer Driver Handle A

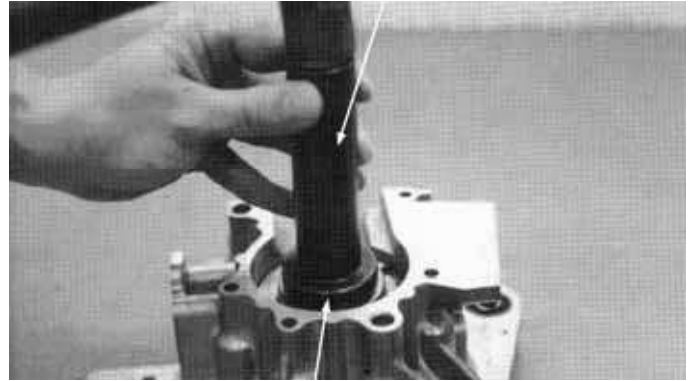

Bearing Outer Driver, 37x40mm
Bearing Driver Pilot, 17mm

Drive a new crankshaft bearing into the left crankcase.

Bearing Outer Driver Handle A



Bearing Outer Driver, 42x47mm
Pilot, 20mm

Install the crankshaft into the left crankcase.

*

- Apply KYMCO ULTRA motor oil or molybdenum disulfide to the crankshaft bearings and connecting rod big end.
- Apply grease to the lip of the oil seal and then install it.

Crankcase Assembly Tool



Crankcase Assembly Collar

10. CRANKCASE/CRANKSHAFT

CRANKCASE ASSEMBLY

Install the dowel pins and a new gasket to the crankcase mating surface.

Dowel Pins

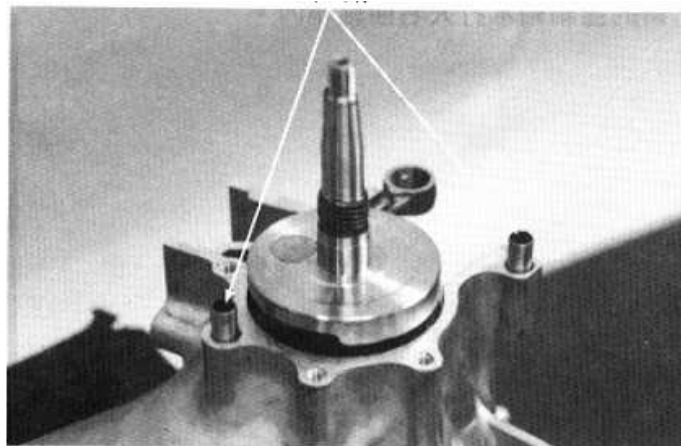

Assemble the crankcase halves.

Crankcase Assembly Collar

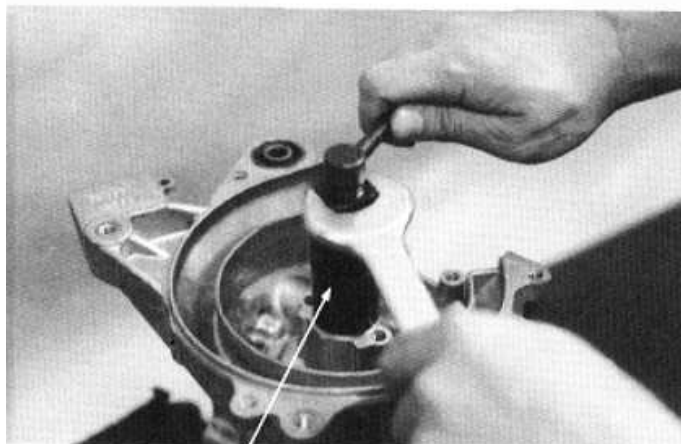

Crankcase Assembly Tool

The distance between the right crankcase oil seal and crankcase surface is about 12.5 ± 0.5 mm.

*

When installing the oil seal, be careful to press it with even force.

Crankcase Assembly Collar

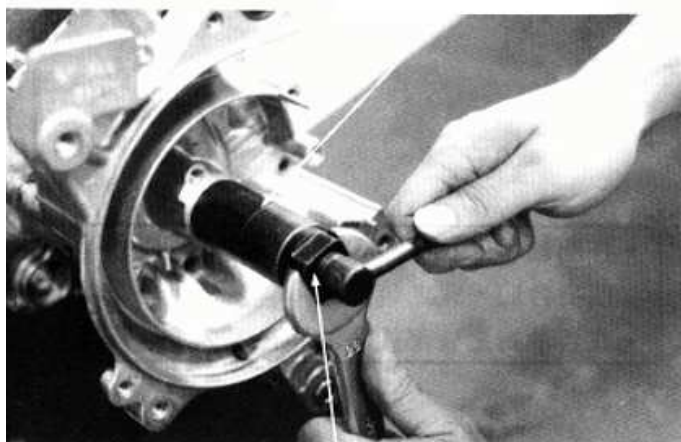

Crankcase Assembly Tool

10. CRANKCASE/CRANKSHAFT

The distance between the left crankcase oil seal and crankcase surface is about 1.0mm.

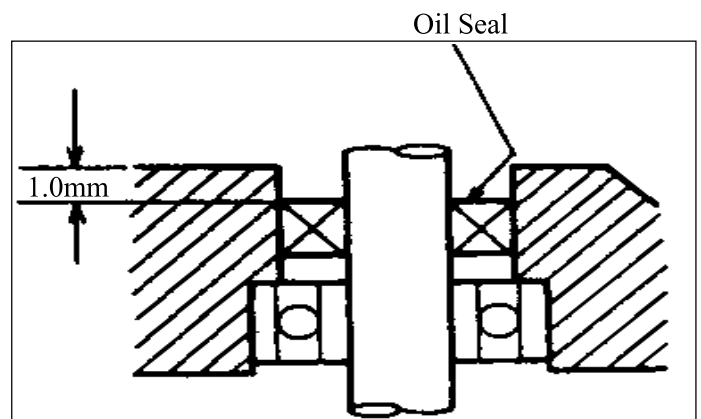

Install and tighten the crankcase attaching bolts.

* After assembly, check the crankshaft for smooth operation.

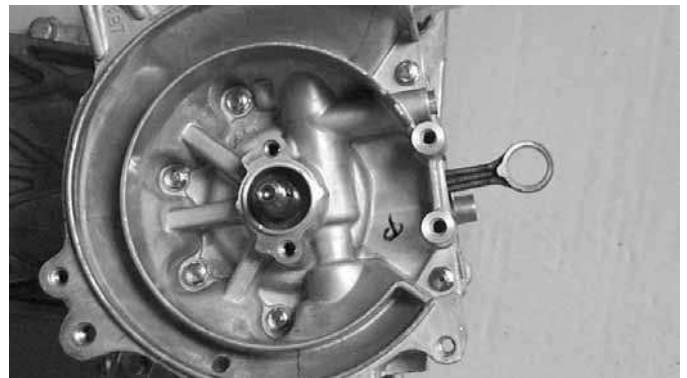

11. CARBURETOR

CARBURETOR

SERVICE INFORMATION	11- 2
TROUBLESHOOTING	11- 2
THROTTLE VALVE DISASSEMBLY	11- 3
THROTTLE VALVE INSTALLATION.....	11- 4
CARBURETOR REMOVAL	11- 5
AUTO BYSTARTER.....	11- 6
FLOAT CHAMBER	11- 8
FLOAT LEVEL INSPECTION	11-10
CARBURETOR INSTALLATION	11-11
AIR SCREW ADJUSTMENT	11-11
REED VALVE	11-12
FUEL TANK.....	11-13

11. CARBURETOR

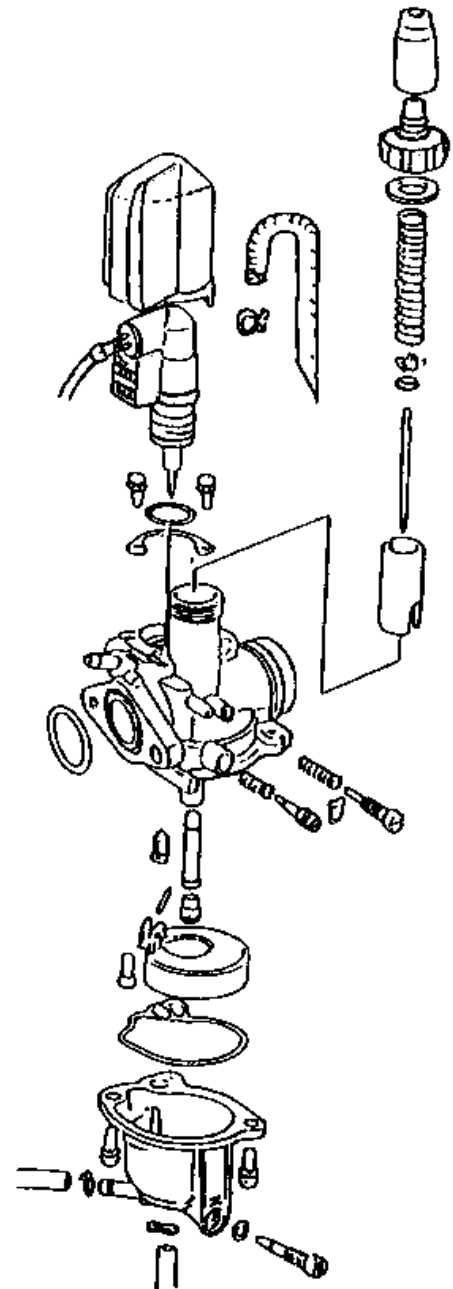
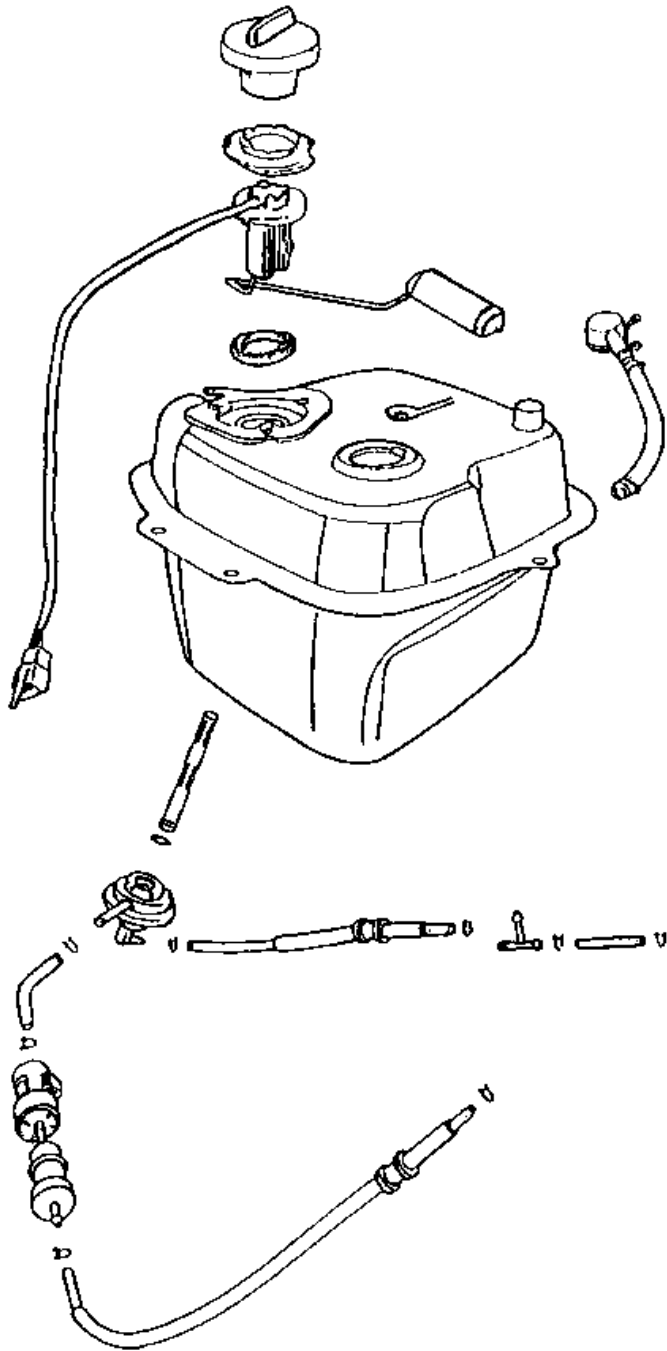

11. CARBURETOR

SERVICE INFORMATION

GENERAL INSTRUCTIONS

- When working with gasoline, keep away from sparks and flames..
- Note the locations of O-rings when disassembling and replace them with new ones during assembly.
- All cables, fuel lines and wires must be routed and secured at correct locations.
- Bleed air from the oil lines whenever they are disconnected.

SPECIFICATIONS	BA10AB.AC.
Venturi dia.	14mm
Identification number	PB058 A
Float level	8.6mm
Main jet	#85
Slow jet	#35
Air screw opening	$1\frac{1}{4} \pm \frac{1}{2}$
Idle speed	2000±100rpm
Throttle grip free play	2~6mm

SPECIAL TOOL

Float level gauge

TROUBLESHOOTING

Engine does not start

- No fuel in tank
- Too much fuel getting to cylinder
- Clogged fuel filter
- Clogged air cleaner

Lean mixture

- Clogged fuel jets
- Clogged fuel cap vent
- Clogged fuel filter
- Bent, kinked or restricted fuel line

- Faulty float valve
- Float level too low
- Clogged air cleaner

Engine idles roughly, stalls or runs poorly

- Incorrect idle speed
- Ignition malfunction
- Compression too low
- Incorrectly adjusted air screw
- Incorrect float level
- Clogged air cleaner
- Intake air leaks
- Fuel contaminated
- Faulty reed valve
- Clogged fuel jets

Rich mixture

- Faulty float valve
- Float level too high
- Clogged air jets

11. CARBURETOR

THROTTLE VALVE DIS-ASSEMBLY

Remove the rear carrier. (⇒12-5)
Remove the met-in box. (⇒12-4)
Loosen the carburetor cap and remove the throttle valve.

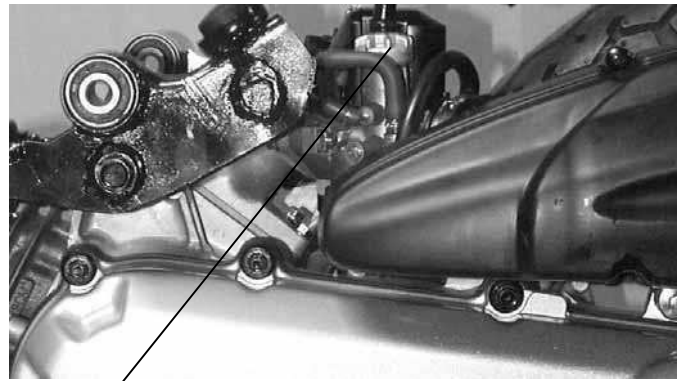

Carburetor Cap

Disconnect the throttle cable from the throttle valve.

Throttle Valve

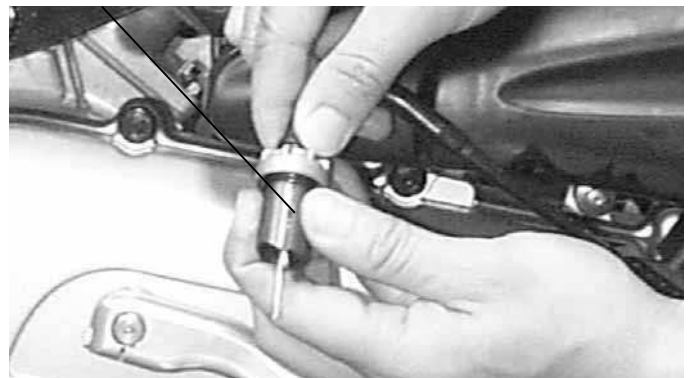

Remove the throttle valve spring, carburetor cap and rubber seal.

Rubber Seal

Carburetor Cap

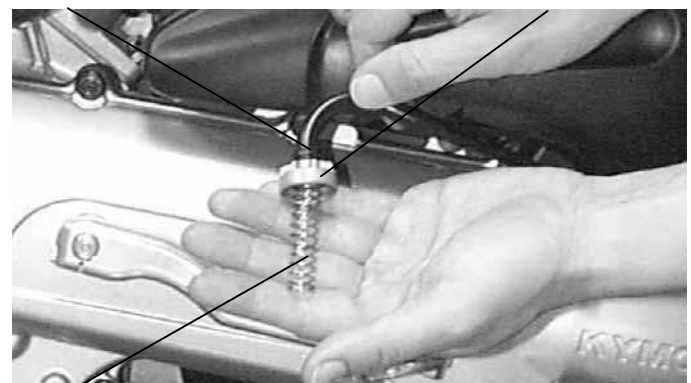

Spring

11. CARBURETOR

Remove the jet needle by removing the needle clip.
Check the jet needle and throttle valve for wear or damage.

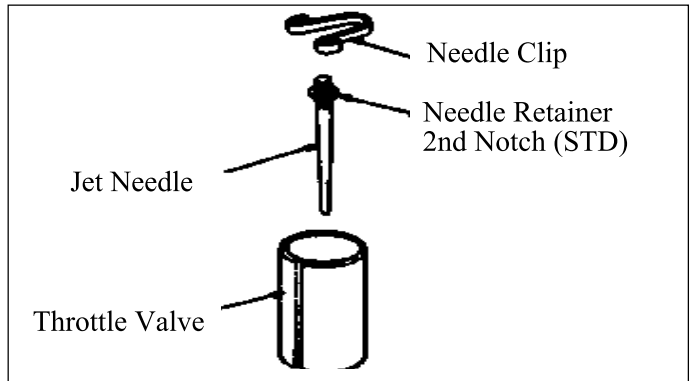

THROTTLE VALVE INSTALLATION

Install the jet needle on the throttle valve and secure with the needle clip.

Install the rubber seal on the throttle cable and then install the carburetor cap and throttle valve spring.

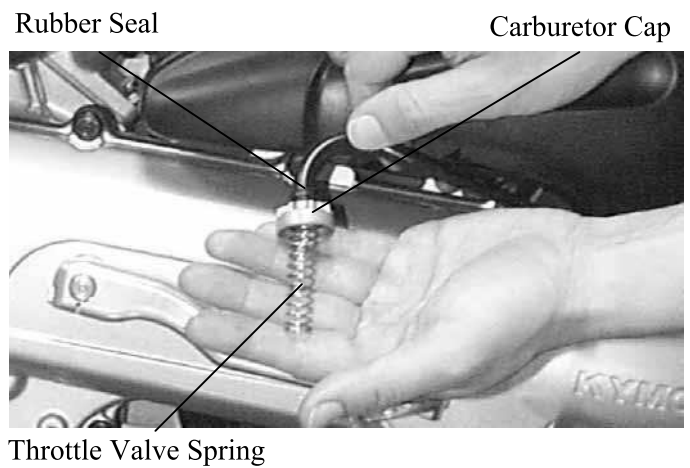

Connect the throttle cable to the throttle valve.

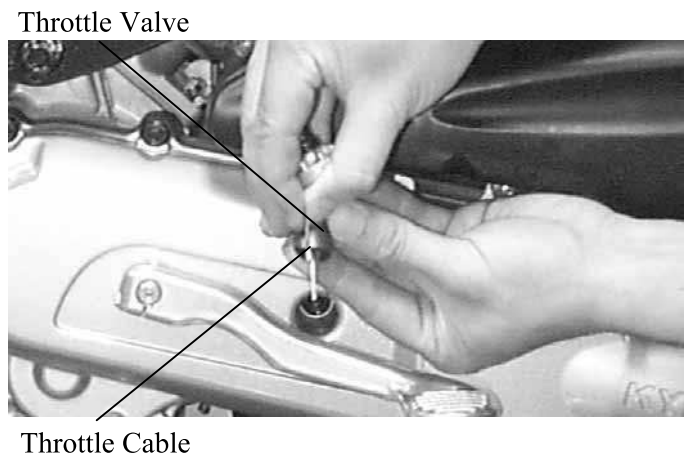

11. CARBURETOR

Install the throttle valve by aligning the groove in the throttle valve with the throttle stop screw.

Groove



Throttle Stop Screw

Tighten the carburetor cap.
After installation, perform the following adjustments and inspections.

- Throttle cable free play (⇒3-12)
- Idle speed adjustment (⇒3-11)

Install the met-in box.

Carburetor Cap



CARBURETOR REMOVAL

Remove the met-in box. (⇒12-4)
Remove the air cleaner by removing the air cleaner band screw and attaching bolts.
Disconnect the fuel tube.
Loosen the drain bolt to drain fuel from the carburetor.
Disconnect the auto bystarter wire connector.
Remove the two carburetor lock nuts.

Auto Bystarter

Throttle Cable

Fuel Tube



Drain Bolt

Band

11. CARBURETOR

Remove the carburetor.

Nut

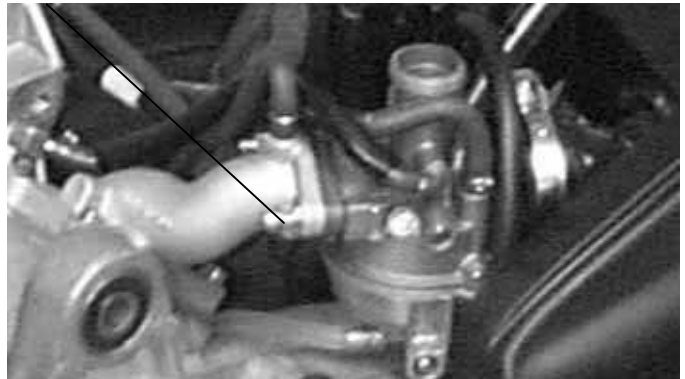

AUTO BYSTARTER

AUTO BYSTARTER INSPECTION

Measure the resistance between the auto bystarter wire terminals.

Resistance: 5Ω (10 minutes minimum after stopping the engine)

If the resistance exceeds 5Ω , replace the auto bystarter with a new one.

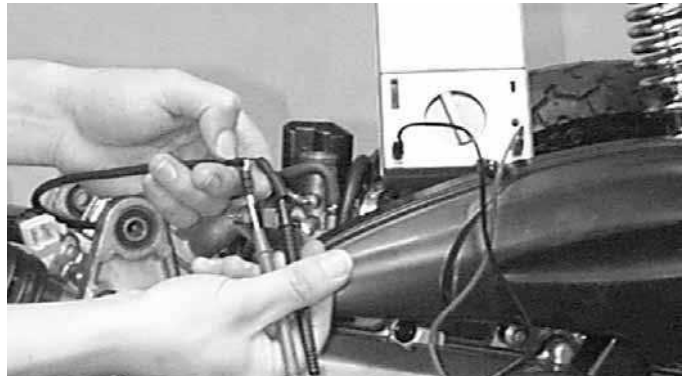

After the engine stops for 30 minutes, connect a hose to the fuel enriching circuit and blow the hose with mouth.

If air cannot be blown into the hose (clogged), the auto bystarter is faulty. Replace it with a new one.

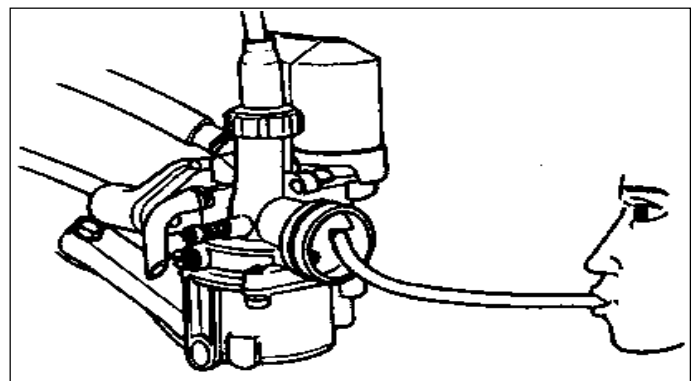

11. CARBURETOR

Connect the auto bystarter yellow wire to the battery positive (+) terminal and green/black wire to the battery negative (-) terminal and wait 5 minutes.

Connect a hose to the fuel enriching circuit and blow the hose with mouth.

If air can be blown into the hose, the auto bystarter is faulty and replace it with a new one.

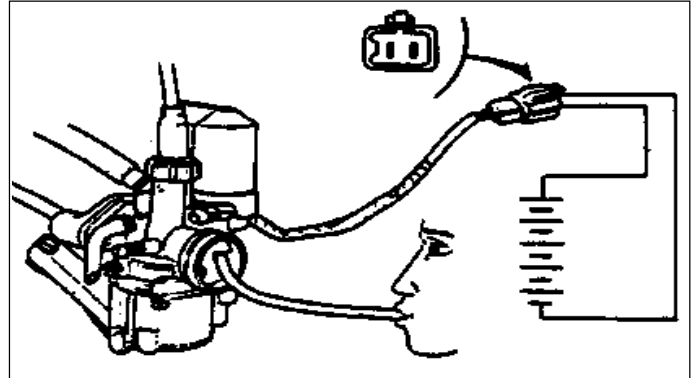

AUTO BYSTARTER REMOVAL

Remove the auto bystarter cover.

Remove the two auto bystarter set plate screws to remove the auto bystarter.

Auto Bystarter

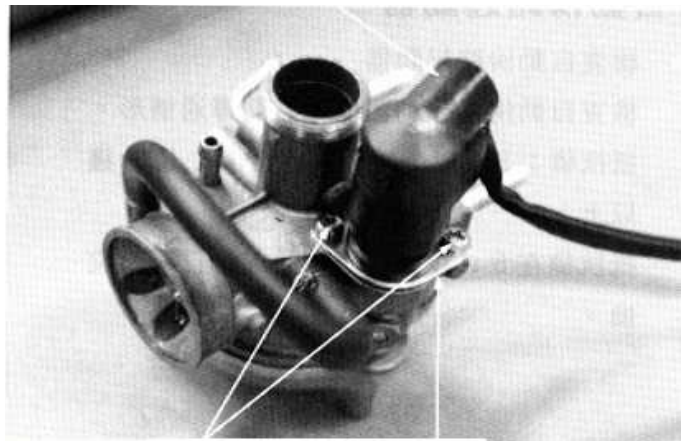

Screws

Set Plate

Check the auto bystarter valve and needle for wear or damage.

Check the O-ring for wear or damage.

O-ring

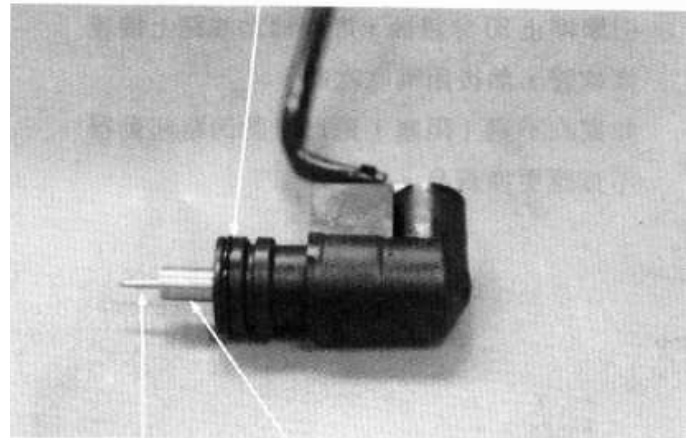

Bystarter Needle

Bystarter Valve

11. CARBURETOR

AUTO BYSTARTER INSTALLATION

Install the auto bystarter into the carburetor body until it bottoms.
Install the set plate and then tighten the two screws.

Screws

Auto Bystarter

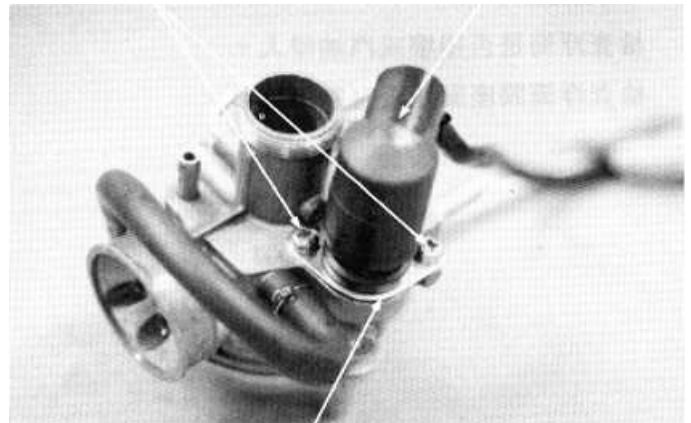

Set Plate

FLOAT CHAMBER

Remove the two float chamber screws and the float chamber.

Screws

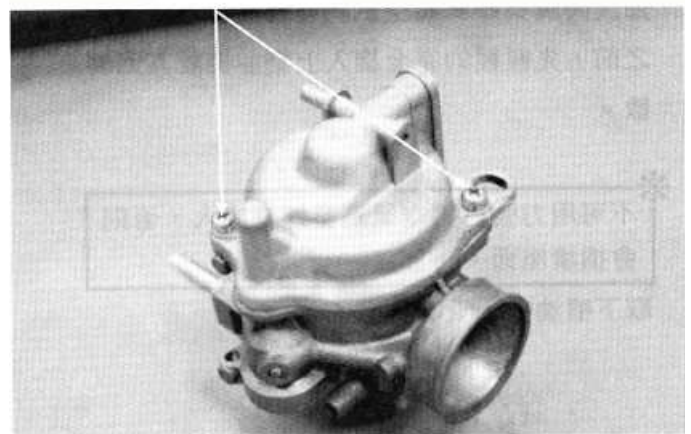

Remove the screw and O-ring.
Remove the float pin, float and float valve.

O-ring

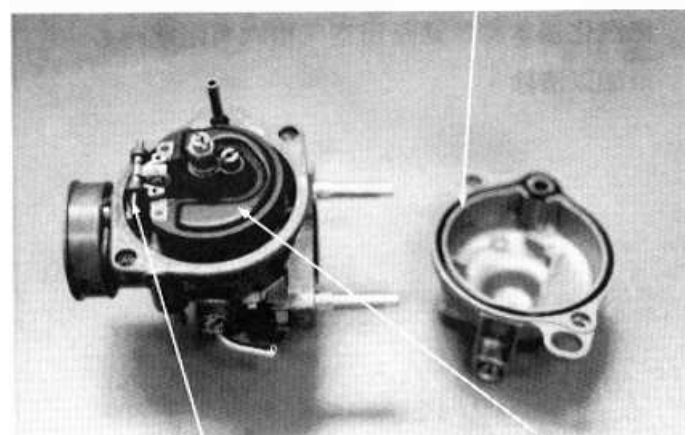

Float Pin

Float

11. CARBURETOR

FLOAT/FLOAT VALVE INSPECTION

Inspect the float for damage or fuel inside the float.
Check the float valve seat for wear or damage.

Float Valve

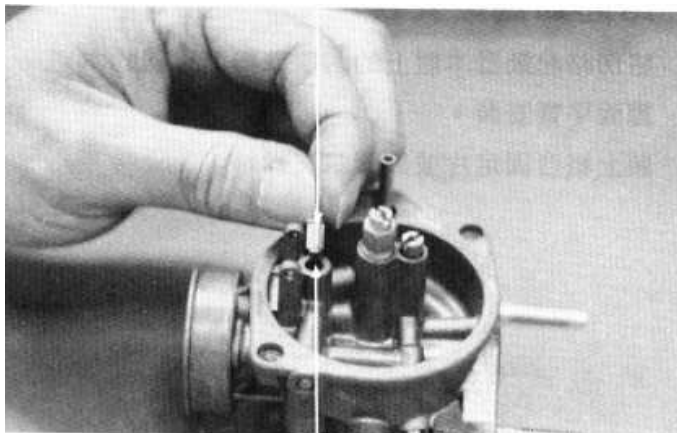

Float Seat

JETS/SCREWS REMOVAL

Before removing the throttle stop screw or air screw, record the number of rotations until it seats lightly. Then, remove them.

* Do not force the air screw against its seat to prevent damage.

Remove the main jet and needle jet holder.

Main Jet

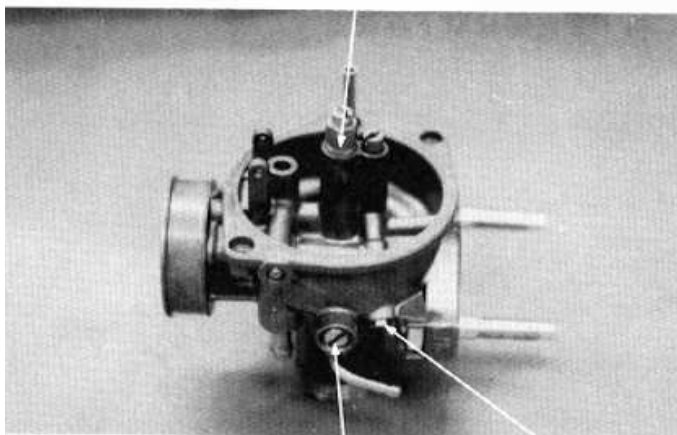

Throttle Stop Screw

Air Screw

CARBURETOR PASSAGES CLEANING

Blow compressed air through all passages of the carburetor body with an air gun.

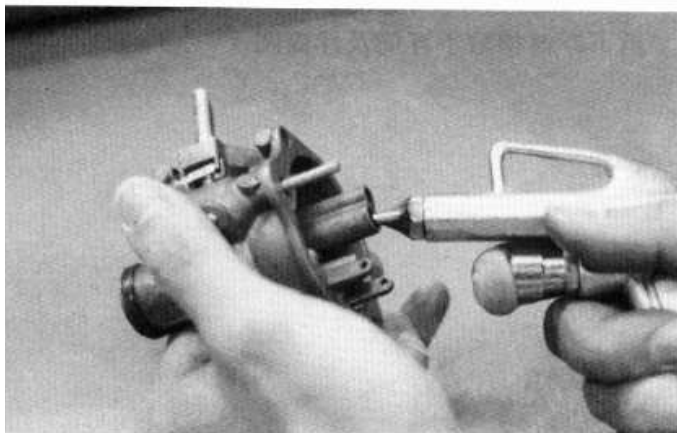

11. CARBURETOR

FLOAT CHAMBER ASSEMBLY

Install the main jet and needle jet holder.
Install the air screw and throttle stop screw according to the rotations recorded.

*

If the air screw must be replaced, be sure to perform the air screw adjustment again.

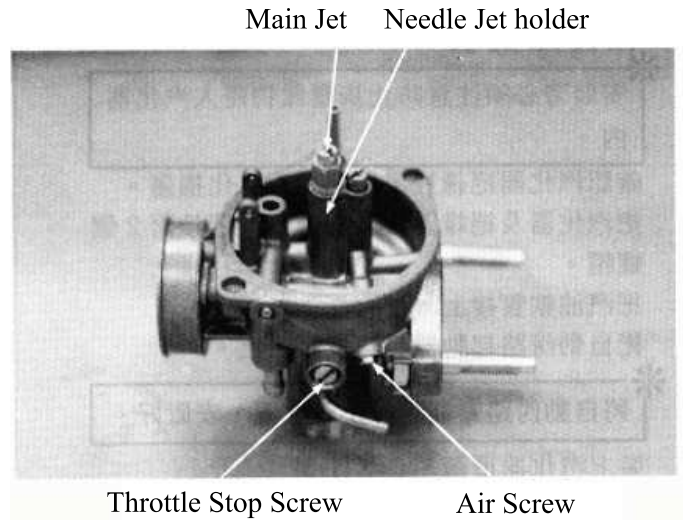

Install the float valve, float and float pin.
Tighten the float screw securely.

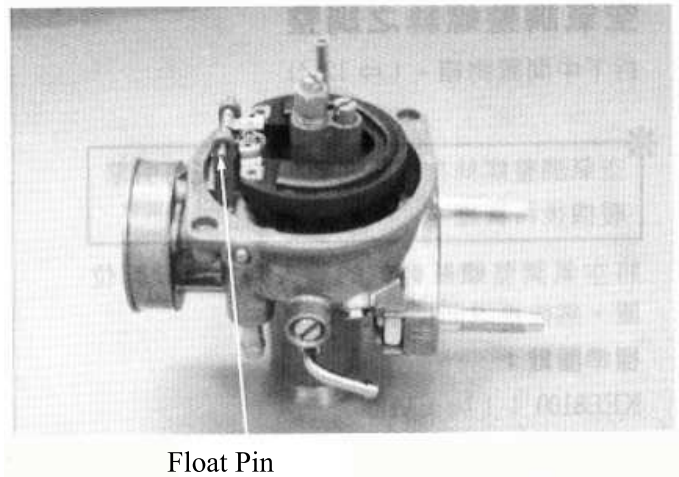

FLOAT LEVEL INSPECTION

Slightly tilt the carburetor and measure the float level with the float valve just connecting the float arm.

Float Level: 8.6mm

Replace the float if the level is out of the specified level range.

Install the O-ring.

Check the operation of the float and install the float chamber.

Tighten the screws.

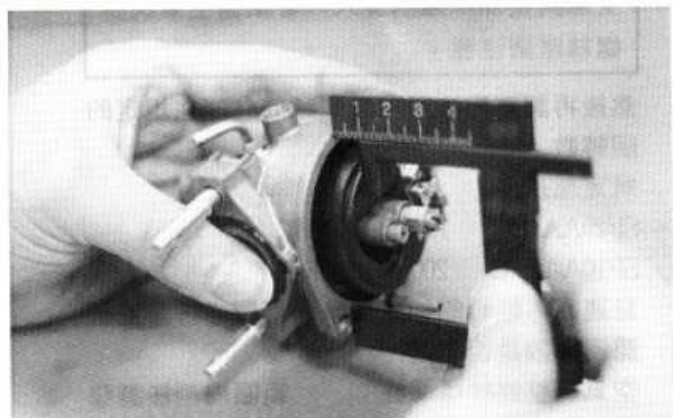

11. CARBURETOR

CARBURETOR INSTALLATION

- * When installation, do not allow foreign particles to enter the carburetor.

Check the carburetor insulator and O-ring for wear or damage.
Install the carburetor and insulator onto the intake manifold and tighten the two lock nuts.
Connect the fuel tube and auto bystarter wire connector.

- * Route the auto bystarter wire correctly and properly.

Install the carburetor cap. (⇒11-4)
Install the air cleaner onto the carburetor and tighten the band screw.
Install the met-in box. (⇒12-4)

AIR SCREW ADJUSTMENT

Remove the met-in box. (⇒12-4)

- * Warm up the engine before air screw adjustment.

Turn the air screw clockwise until it seats lightly and back it to the specification given.

Air Screw Opening:

BA10AB.AC.50 : $1\frac{1}{4} \pm \frac{1}{2}$ turns

Start the engine and turn the air screw in or out slowly to obtain the highest engine speed.

- * Do not force the air screw against its seat to prevent damage.

Turn the throttle stop screw to obtain the specified idle speed.

Idle Speed:

BA10AB.AC.50 : 2000 ± 100 rpm

Slightly increase the engine speed and make sure that the engine does not miss or run erratic.

If the adjustment of the air screw within the range of $\pm\frac{1}{2}$ turn makes no difference to the engine performance, check other related items.

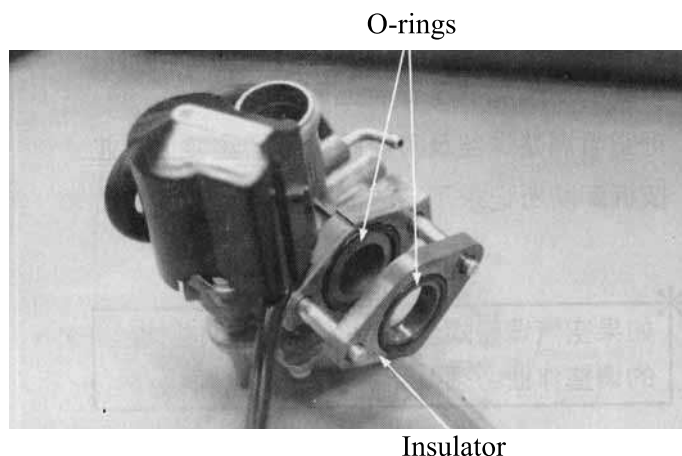

Carburetor Cap Band Air Cleaner Case



Fuel Tube

Air Screw



Throttle Stop Screw

11. CARBURETOR

REED VALVE

REMOVAL

Remove the rear carrier.
Remove the frame body cover.
Remove the four intake manifold bolts and gasket.
Remove the reed valve and gasket.

Bolts

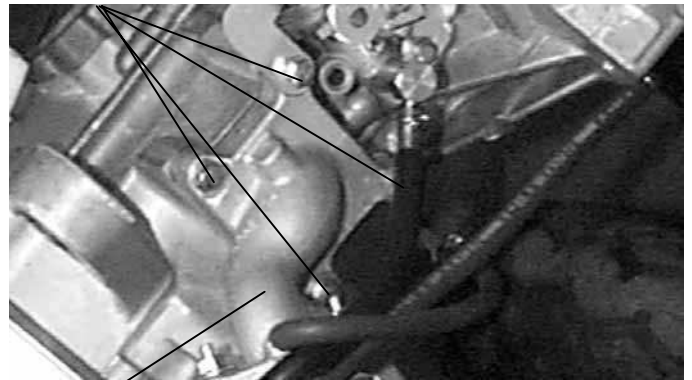

Intake Manifold

INSPECTION

Check the reed valve for damaged or weak reeds.
Check the reed valve seat for cracks, damage or clearance between the seat and reed.
Replace the valve if necessary.

* Do not disassemble or bend the reed stopper. To do so can cause loss of engine power and engine damage. If any of the stopper, reed or valve seat is faulty, replace them as a unit.

Reeds

Reed Stopper

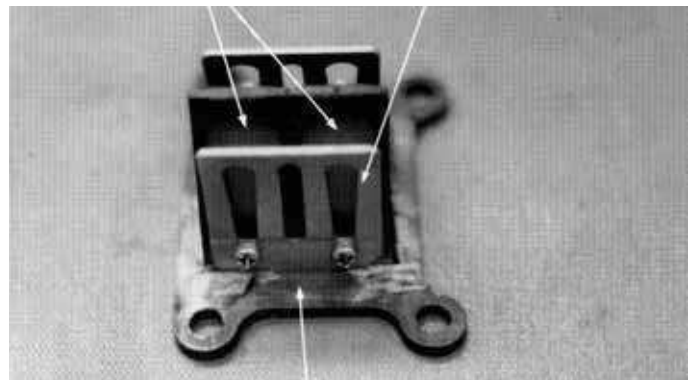

Reed Valve Seat

INSTALLATION

Install the reed valve in the reverse order of removal.

*

- Install a new gasket with the gasket indentation aligned with the reed valve.
- After installation, check for intake air leaks.

11. CARBURETOR

FUEL TANK

REMOVAL

- Remove the met-in box. (⇒12-4)
- Remove the frame body cover. (⇒12-5)
- Remove the rear carrier. (⇒12-5)
- Disconnect the fuel tube and vacuum tube at the auto fuel valve.
- Disconnect the fuel unit wire connector.
- Remove the fuel tank mounting bolts and fuel tank.
- Inspect the fuel unit. (⇒16-2)
- Replace the fuel unit if necessary. (⇒16-2)

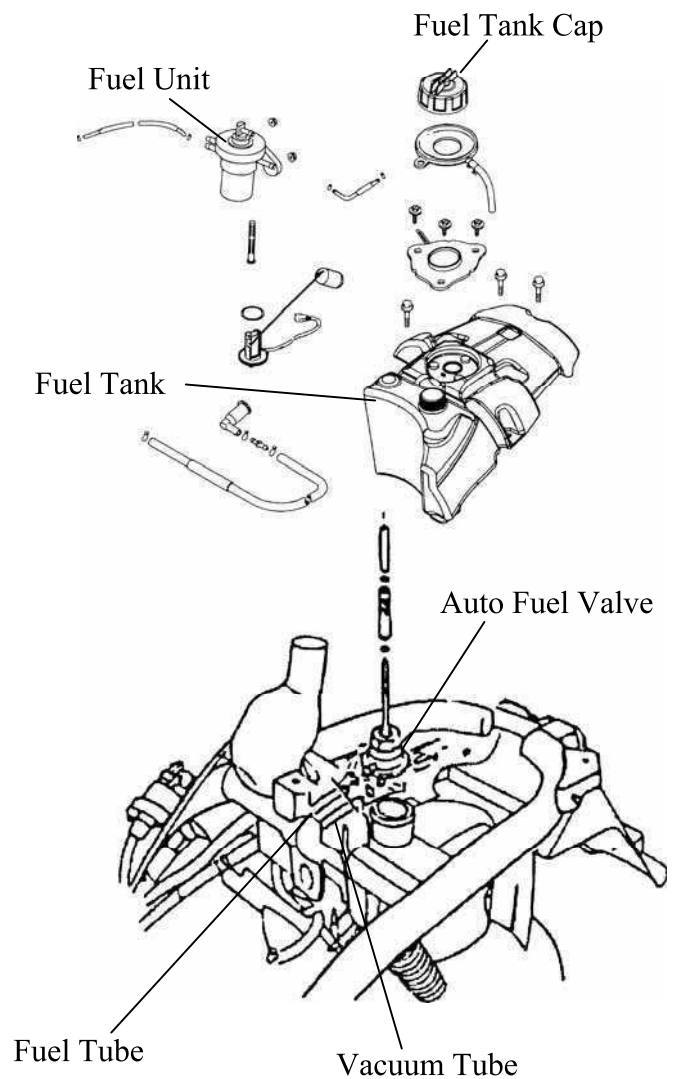

12. FRAME COVERS

FRAME COVERS

SERVICE INFORMATION 12-2
FRAME COVERS REMOVAL/INSTALLATION 12-3

12. FRAME COVERS

ASSEMBLY DRAWING

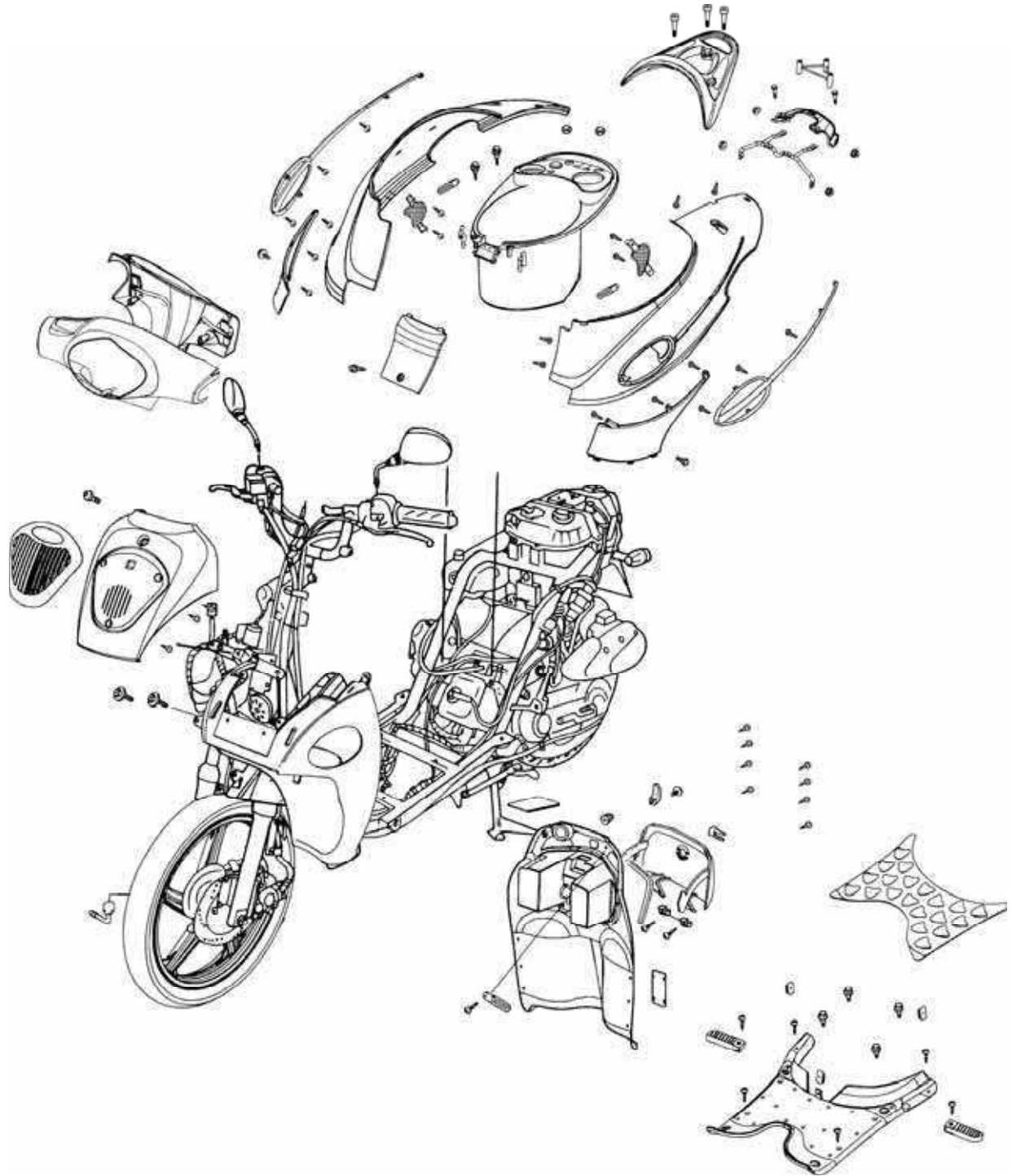

12. FRAME COVERS

SERVICE INFORMATION

- When removing frame covers, use care not to pull them by force because the cover joint claws may be damaged.

Items Related for Removal

- Handlebar front cover ——— Headlight wire
- Front cover ———
- Handlebar rear cover ——— Speedometer cable and instrument light wire connectors, etc.
- Frame body cover ——— Met-in box, rear carrier, rear fender.
- Floor board ——— frame body cover.
- Front tool box ——— Front cover, battery, floor board .

12. FRAME COVERS

FRAME COVERS REMOVAL

FRONT COVER REMOVAL

Remove the screw the front cover.
Remove the two screws on the back of the front cover.
Push the two inside claws of the downside front cover to float the front cover.
Remove the front cover downward.
The installation sequence is the reverse of removal.

• During removal, be careful not to pull the joint claws forcibly.

Front Cover



Screw

Screws

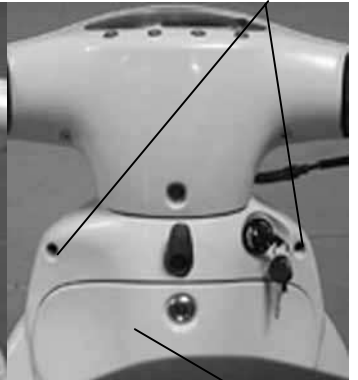

Front Tool Box

HANDLEBAR FRONT/REAR COVER REMOVAL

First remove the one screws attaching the handlebar front cover.
Remove the handlebar front cover.
Disconnect the headlight wire connector.
Remove the handlebar rear cover:
Remove the four screws and bolt attaching the handlebar rear cover.
Disconnect the speedometer cable and instrument light wire connectors.
Remove the handlebar rear cover.
The installation sequence is the reverse of removal.

Screws

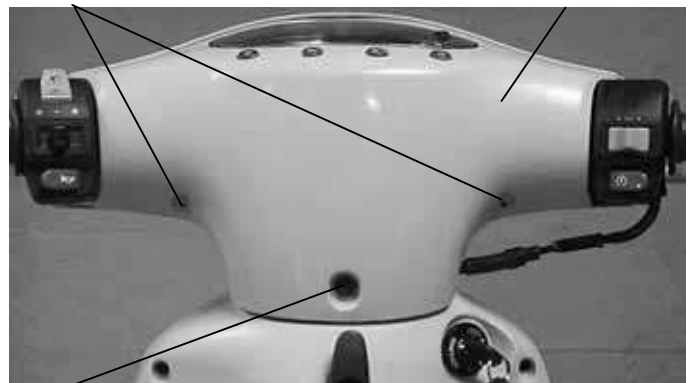

Handlebar Rear Cover

Screws

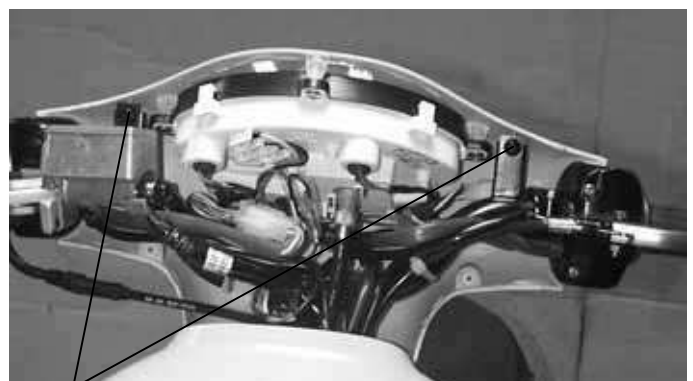

Screws

12. FRAME COVERS

FLOOR BOARD REMOVAL

Remove the rear carrier. (⇒12-5)
Remove the frame body cover. (⇒12-6)
Remove the front cover. (⇒12-3)
Remove the four bolts attaching and six screws the floor board to remove the floor board.
The installation sequence is the reverse of removal.

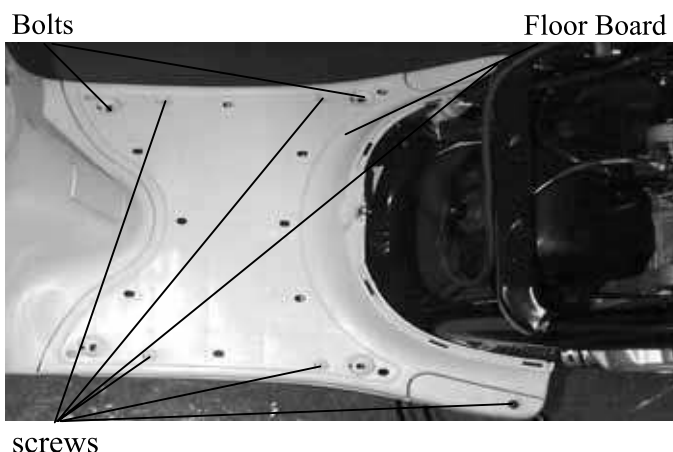

FRONT TOOL BOX REMOVAL

Remove the rear carrier. (⇒12-5)
Remove the frame body cover. (⇒12-6)
Remove the floor board. (⇒12-4)
Open the front tool box and remove the battery.
Remove the switch covers.
Remove the nut attaching and six screws the front tool box.
Remove the front tool box.
The installation sequence is the reverse of removal.

When removing the battery, first disconnect the battery negative (-) cable and then the positive (+) cable.
When taking the front tool box, pull them up and backward from downside not to damage the claws.

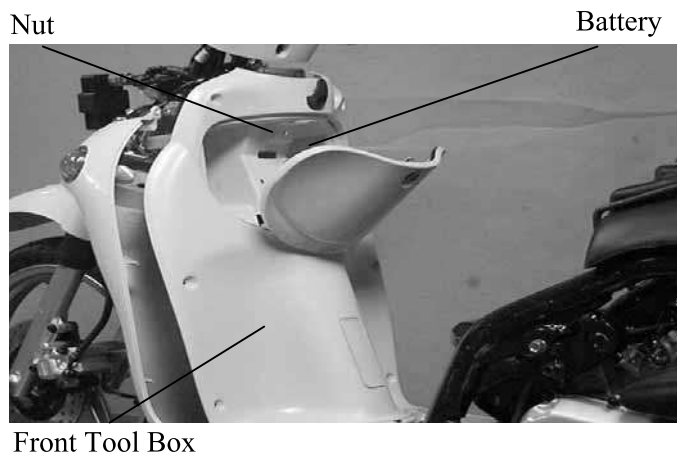

BOTTOM COVER REMOVAL

Remove the floor board. (⇒12-4)
Remove the three screws each side of the bottom cover.
Remove the bolt attaching the side stand.
Remove the bottom cover.
The installation sequence is the reverse of removal.

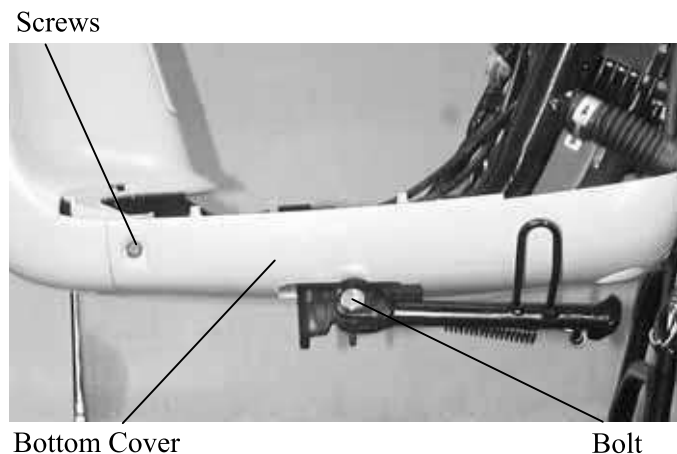

12. FRAME COVERS

MET-IN BOX REMOVAL:

Open the seat.
Remove the two bolts, two nuts attaching the met-in box.
Remove the oil tank cap, rubber packing and fuel tank cap.
Remove the met-in box.
The installation sequence is the reverse of removal .

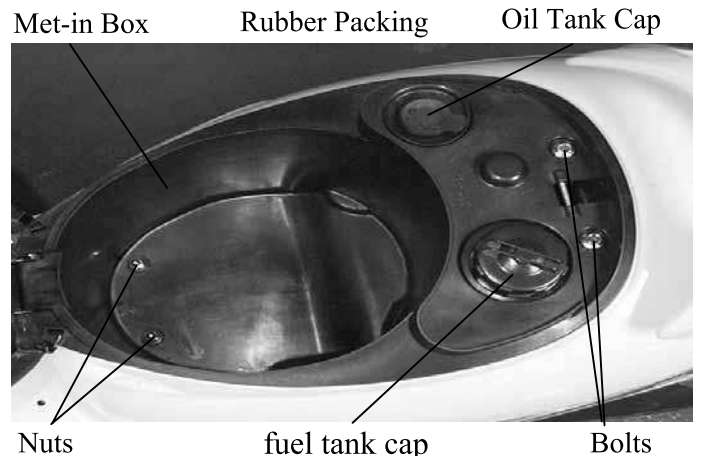

REAR CARRIER REMOVAL

Remove the three bolts attaching the rear carrier.
Remove the rear carrier.
The installation sequence is the reverse of removal.

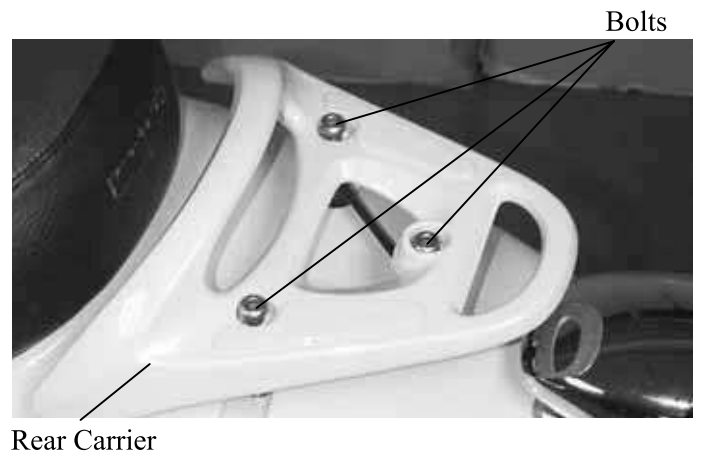

REAR FENDER REMOVAL

Remove the two screws the rear fender.
Remove the rear fender.
The installation sequence is the reverse of removal.

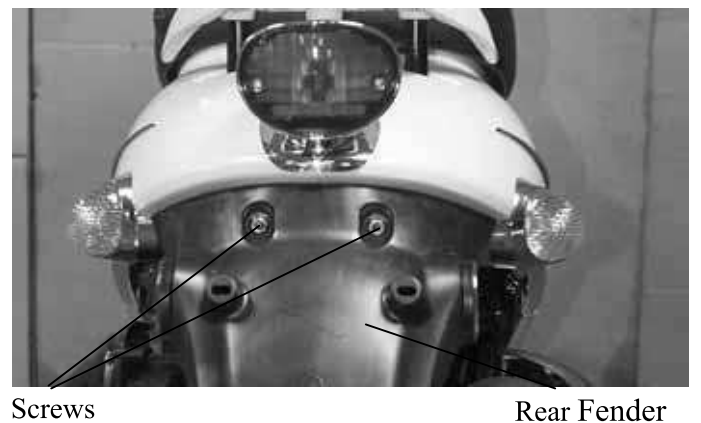

12. FRAME COVERS

FRAME BODY COVER REMOVAL

Remove the rear carrier. (⇒12-5)

Remove the rear fender. (⇒12-5)

Remove the met-in box. (⇒12-4)

Remove the rear brake cable.

Remove the bolt attaching the front center cover of the frame body cover.

Remove the frame body cover.

The installation sequence is the reverse of removal.

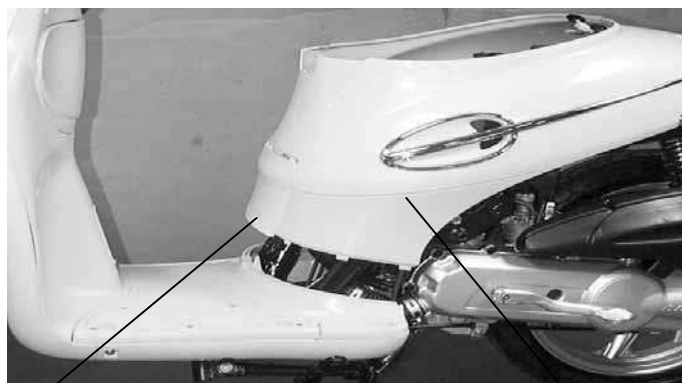

Bolt

frame body

FRONT FENDER REMOVAL

Remove the floor board. (⇒12-4)

Remove the front tool box.(⇒12-4)

Remove the handlebar. (⇒13-3)

Remove the front fork. (⇒13-19)

Remove two bolts attaching each side of the front fender.

Remove the front fender.

The installation sequence is the reverse of removal.

Bolts



Front Fender

FRONT LOWER COVERS REMOVAL

Remove the rear brake cable.

Remove the frame body cover. (⇒12-5)

Remove the front tool box.(⇒12-4)

Remove the handlebar. (⇒13-3)

Remove the front fork. (⇒13-19)

First remove the front cover. (⇒12-3)

Remove the right and left bottom cover removing the two screws for each rail.

Remove the two bolts attaching each of the right and left front lower covers.

Remove the front lower covers.

The installation sequence is the reverse of removal.

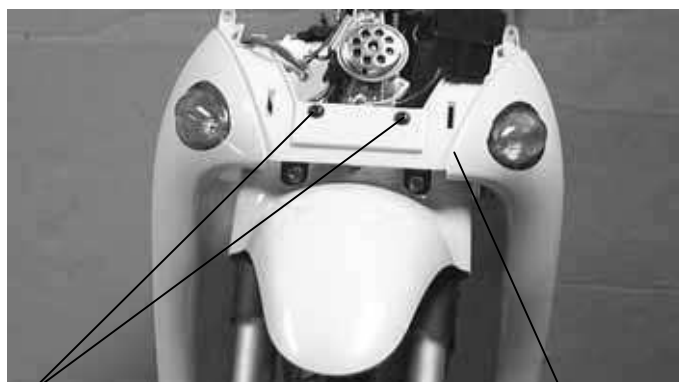

Bolts

Front Lower Cover

13. STEERING HANDLEBAR/FRONT WHEEL/FRONT BRAKE/FRONT SHOCK ABSORBER/FRONT FORK

STEERING HANDLEBAR/FRONT WHEEL/FRONT BRAKE/FRONT SHOCK ABSORBER/FRONT FORK

SERVICE INFORMATION	13- 2
TROUBLESHOOTING	13- 2
STEERING HANDLEBAR	13- 3
FRONT WHEEL	13- 5
FRONT BRAKE (DRUM BRAKE)	13- 9
FRONT BRAKE (DISK BRAKE)	13-12
FRONT SHOCK ABSORBER	13-20
FRONT FORK	13-23

13. STEERING HANDLEBAR/FRONT WHEEL/FRONT BRAKE/FRONT SHOCK ABSORBER/FRONT FORK

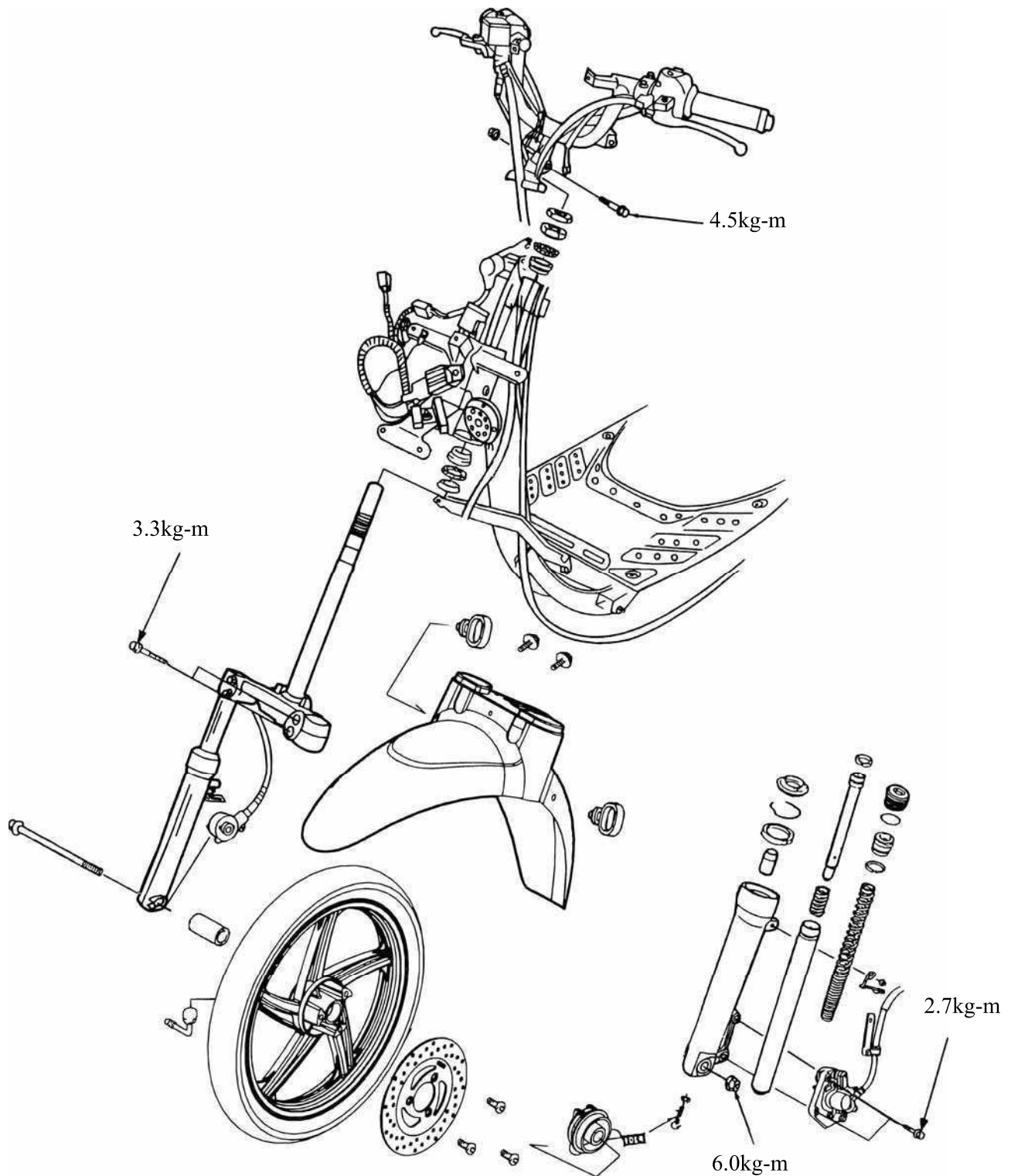

13. STEERING HANDLEBAR/FRONT WHEEL/FRONT BRAKE/FRONT SHOCK ABSORBER/FRONT FORK

SERVICE INFORMATION

SPECIFICATIONS

Item	Standard (mm)	Service Limit (mm)
Axle shaft runout	—	0.2
Front wheel rim runout	Radial	2.0
	Axial	2.0
Front shock absorber spring free length	200	182.8
Brake disk thickness	35~3.8	3.0
Brake disk runout	—	0.30
Brake master cylinder I.D.	12.700~12.743	12.75
Brake master cylinder piston O.D.	12.657~12.684	12.64
Brake caliper piston O.D.	25.400~25.405	25.45
Brake caliper piston I.D.	25.318~25.368	25.30

TORQUE VALUES

Handlebar lock nut	4.0~5.0kg-m	Front damper nut	1.5~3.0kg-m
Steering stem lock nut	8.0~12.0kg-m	Front axle nut	5.0~7.0kg-m
Steering top cone race	0.5~1.3kg-m	Brake arm bolt	0.4~0.7kg-m

SPECIAL TOOLS

Lock nut wrench	Driver handle A
Lock nut socket wrench	Outer driver, 37x40mm
Outer driver, 28x30mm	Pilot, 10mm
Rear shock absorber remover	Bearing puller
Rear shock absorber compressor	Snap ring pliers (close)
Ball race remover	Damper compressor

TROUBLESHOOTING

Hard steering (heavy)

- Excessively tightened steering stem top cone race
- Broken steering balls
- Insufficient tire pressure

Steers to one side or does not track straight

- Broken clutch weight spring
- Bent front fork
- Bent front axle or uneven tire

Poor brake performance

- Incorrectly adjusted brake
- Worn brake linings
- Contaminated brake lining surface
- Worn brake cam
- Worn brake drum
- Poorly connected brake arm

Poor brake performance (disk brake)

- Air in brake system
- Deteriorated brake fluid

- Contaminated brake disk or disk pad
- Worn brake bushing
- Worn brake master cylinder piston oil seal
- Clogged brake fluid line
- Deformed brake disk
- Unevenly worn brake caliper

Front wheel wobbling

- Bent rim
- Loose front axle
- Bent spoke plate
- Faulty tire
- Improperly tightened axle nut

Soft front shock absorber

- Weak shock springs
- Insufficient damper oil

Front shock absorber noise

- Slider bending
- Loose fork fasteners
- Lack of lubrication

13. STEERING HANDLEBAR/FRONT WHEEL/FRONT BRAKE/FRONT SHOCK ABSORBER/FRONT FORK

STEERING HANDLEBAR

REMOVAL

Remove the handlebar front and rear covers.
(⇒ 12-3)
Remove two bolts attaching the left brake lever holder.
Remove two bolts attaching the brake master cylinder (disk brake) to the right brake lever.

Brake Master Cylinder



Bolts

Bolts

Remove the two right handlebar switch housing bolts and separate the housing.
Disconnect the throttle cable and then remove the throttle pipe from the handlebar.

Bolts

Throttle Pipe

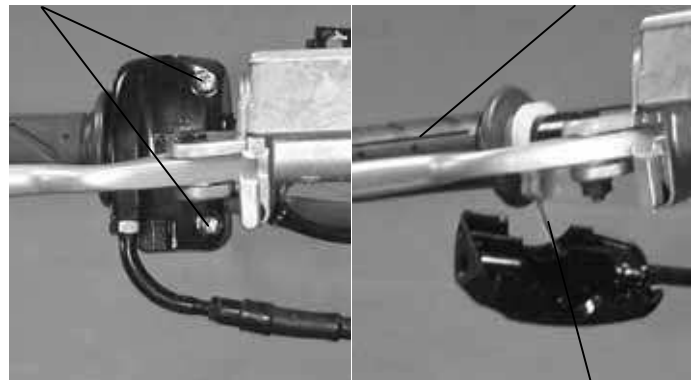

Throttle Cable

Remove the handlebar lock nut to remove the handlebar.

Handlebar

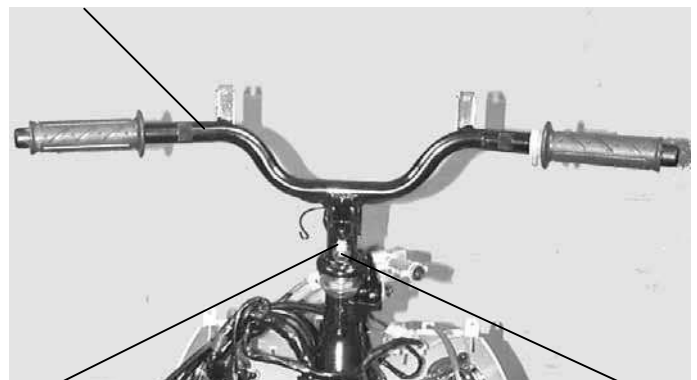

Nut

Bolt

13. STEERING HANDLEBAR/FRONT WHEEL/FRONT BRAKE/FRONT SHOCK ABSORBER/FRONT FORK

INSTALLATION

Install the handlebar, aligning the tabs of the handlebar with the grooves in the steering stem.

Install and tighten the handlebar lock nut.

Torque: 4.5 ~ 5.0kg-m

Tab/Groove

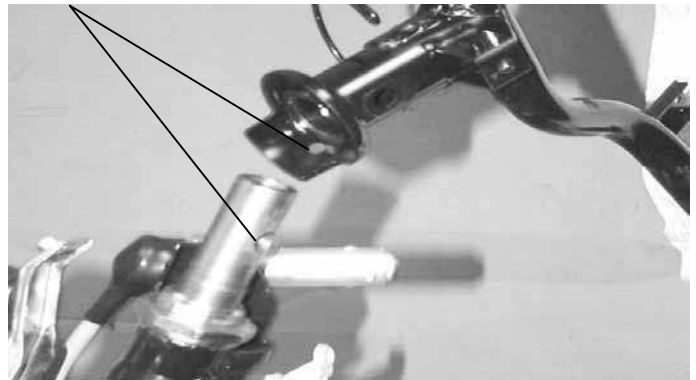

Lubricate the throttle pipe front end with grease.

Install the throttle grip and connect the throttle cable.

Throttle Cable

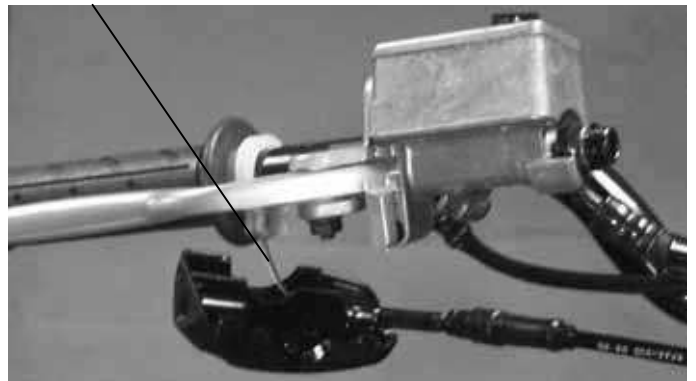

The installation sequence is the reverse of removal.

Install the rear brake lever holder.

Install the front brake master cylinder (disk brake).

Holders

Brake Master Cylinder

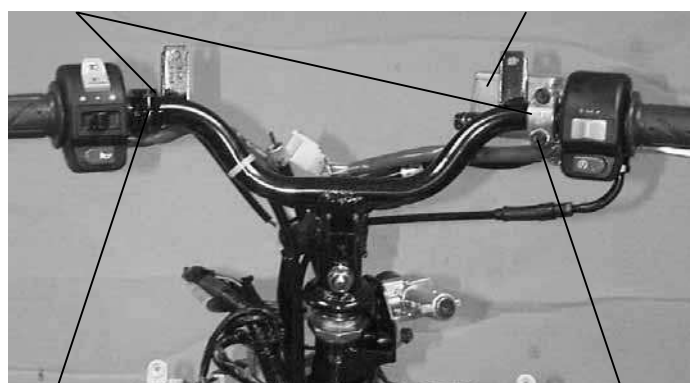

Bolts

Bolts

13. STEERING HANDLEBAR/FRONT WHEEL/FRONT BRAKE/FRONT SHOCK ABSORBER/FRONT FORK

FRONT WHEEL

REMOVAL

(DISK BRAKE)

Jack the motorcycle front wheel off the ground.
Remove the speedometer cable set screw and disconnect the speedometer cable.
Remove the front axle nut and pull out the axle.
Remove the front wheel.
Remove the brake panel side collar.

Speedometer Cable

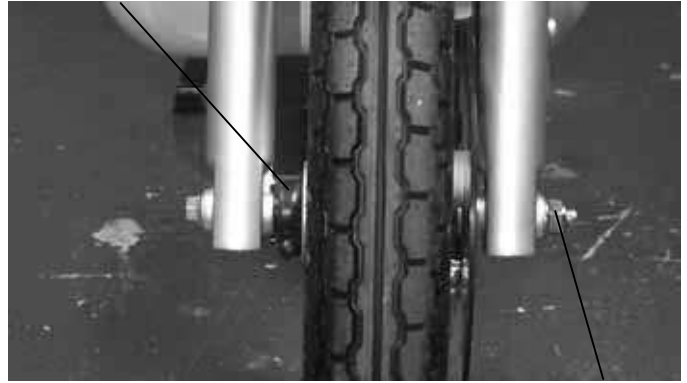

Axle Nut

INSPECTION

Set the axle in V blocks and measure the runout.
The actual runout is $\frac{1}{2}$ of the total indicator reading.

Service Limit: 0.2mm replace if over.

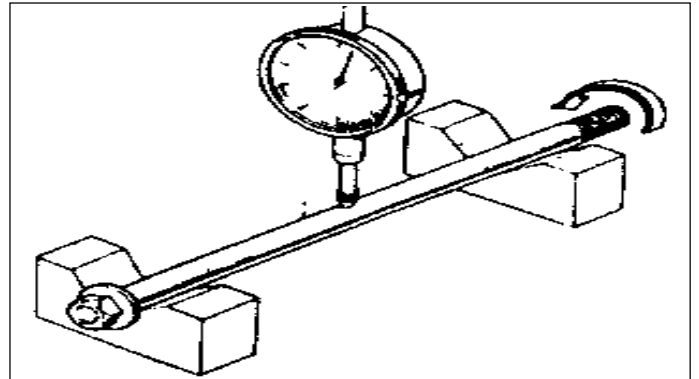

Check the wheel rim runout.

Service Limits:

Radial: 2.0mm replace if over

Axial: 2.0mm replace if over

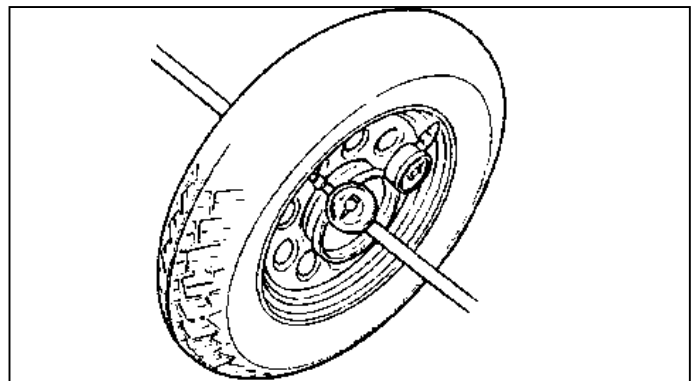

13. STEERING HANDLEBAR/FRONT WHEEL/FRONT BRAKE/FRONT SHOCK ABSORBER/FRONT FORK

Turn the wheel bearings and replace them if they have excessive play or noise.

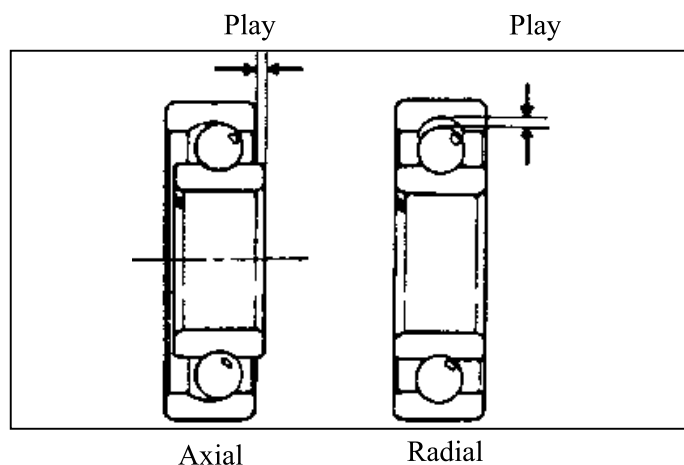

DISASSEMBLY
Remove the dust seal.

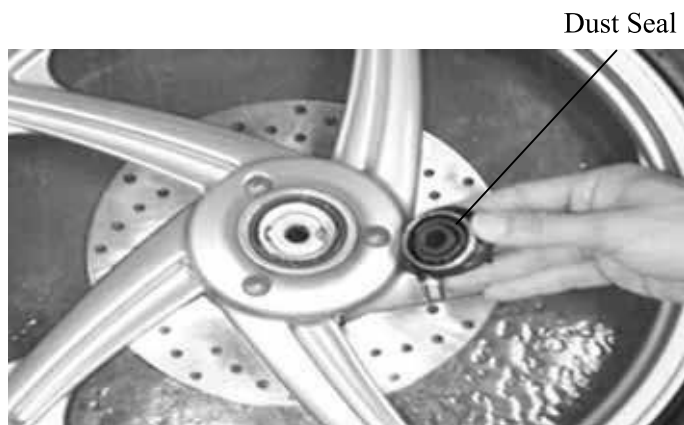

Remove the wheel bearings and distance collar.

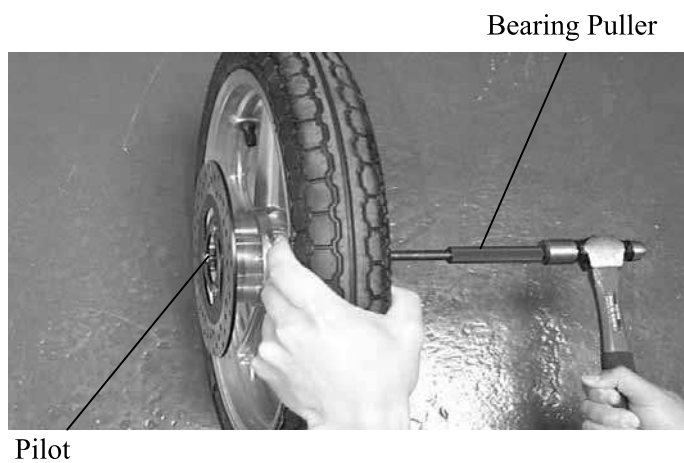

13. STEERING HANDLEBAR/FRONT WHEEL/FRONT BRAKE/FRONT SHOCK ABSORBER/FRONT FORK

ASSEMBLY

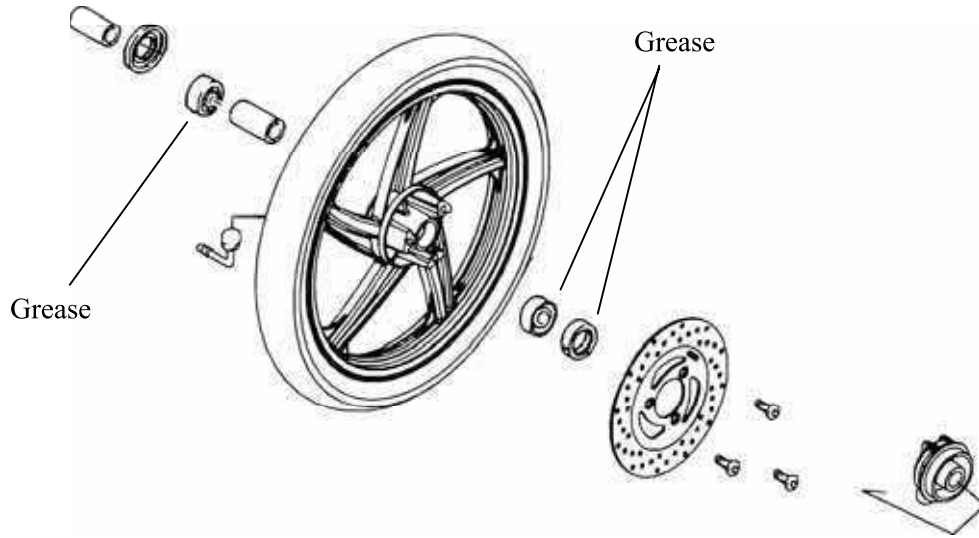

Pack all bearing cavities with grease.
Drive in the left bearing .
Install the distance collar.
Drive in the right bearing.

* Drive the bearing squarely with the sealed end facing out.

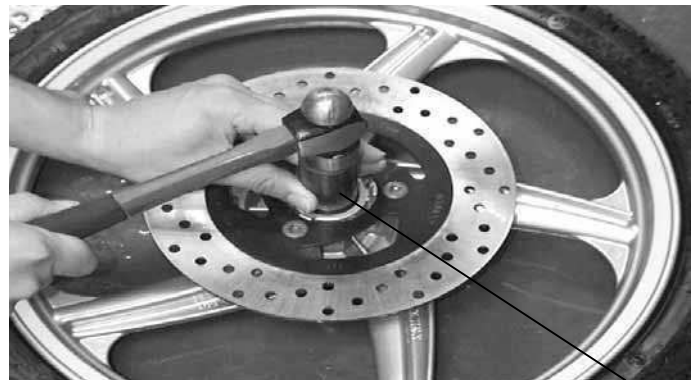

Pilot

Apply grease to the dust seal lip and install the dust seal.
Install the side collar.

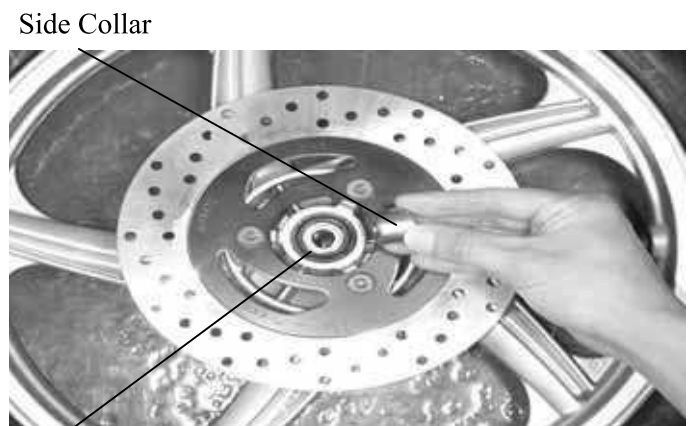

Dust Seal

13. STEERING HANDLEBAR/FRONT WHEEL/FRONT BRAKE/FRONT SHOCK ABSORBER/FRONT FORK

FRONT WHEEL INSTALLATION

(Disk Brake)

Install the front wheel, aligning the speedometer gear tab with the front fork groove.

Connect the speedometer cable.

Torque: 5.0~7.0kg-m



Groove

Tab

Axle Nut

HYDRAULIC BRAKE (FRONT BRAKE)

Brake Fluid Replacement/Air Bleeding

Check the brake fluid level on level ground.

*

- When operating the brake lever, the brake reservoir cap must be tightened securely to avoid spill of brake fluid.
- When servicing the brake system, use shop towels to cover plastic parts and coated surfaces to avoid damage caused by spill of brake fluid.

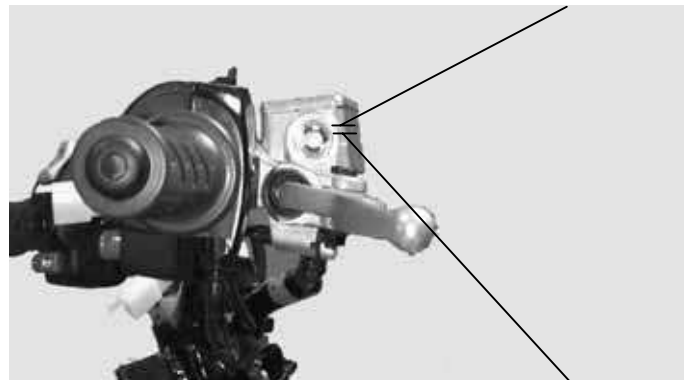

Upper Limit

Lower Limit

Brake Fluid Bleeding

In order to avoid spill of brake fluid, connect a transparent hose to the bleed valve.

Warning

Brake fluid spilled on brake pads or brake disk will reduce the braking effect. Clean the brake pads and brake disk with a high quality brake degreaser.

Fully apply the brake lever and then loosen the brake caliper bleed valve to drain the brake fluid until there is no air bubbles in the brake fluid. Then, tighten the bleed valve. Repeat these steps until the brake system is free of air.

Front Brake Caliper

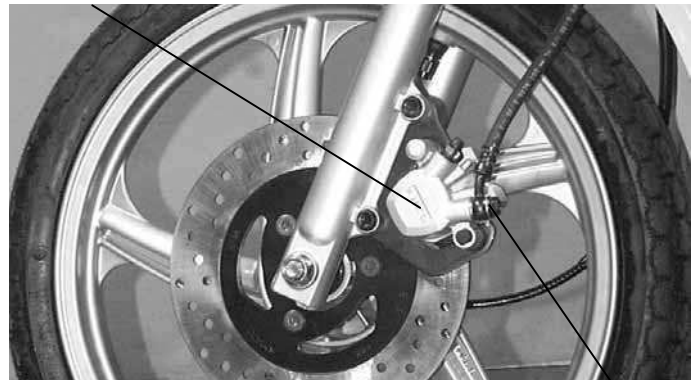

Bleed Valve

Brake Fluid Refilling

Add DOT-3 brake fluid to the brake reservoir.

*

- When bleeding, be careful not to allow air in the brake reservoir flowing into the brake system.
- When using a brake bleeder, follow the manufacturer's instructions.
- Never use dirty or unspecified brake fluid or mix different brake fluids because it will damage the brake system.

Make sure to bleed air from the brake system.

13. STEERING HANDLEBAR/FRONT WHEEL/FRONT BRAKE/FRONT SHOCK ABSORBER/FRONT FORK

Brake Pad/Disk Replacement

* The brake pads must be replaced as a set to ensure the balance of the brake disk.

Remove the two bolts attaching the brake caliper.
Remove the brake caliper.
Remove the brake pads.



Front Brake Caliper

Install the brake pads in the reverse order of removal.
Torque: 1.5~2.0kg-m

* Keep grease or oil off the brake pads to avoid brake failure.

Front Brake Caliper

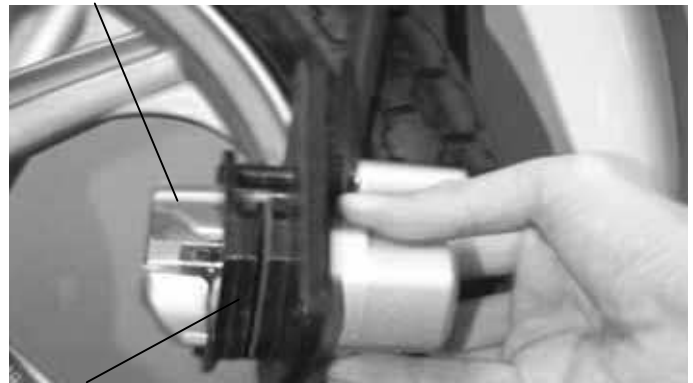

Brake Pads

Brake Disk

Measure the brake disk thickness.

Service Limit: 3.0mm

Measure the brake disk runout.

Service Limit: 0.3mm

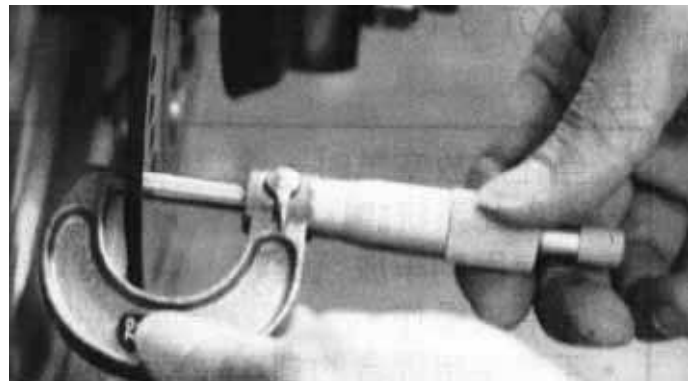

13. STEERING HANDLEBAR/FRONT WHEEL/FRONT BRAKE/FRONT SHOCK ABSORBER/FRONT FORK

BRAKE MASTER CYLINDER

Removal

First drain the brake fluid from the hydraulic brake system.

*

- When servicing the brake system, use shop towels to cover rubber and plastic parts and coated surfaces to avoid being contaminated by brake fluid.
- When removing the brake fluid pipe bolt, be sure to plug the pipe to avoid

Brake Master Cylinder

Bolts

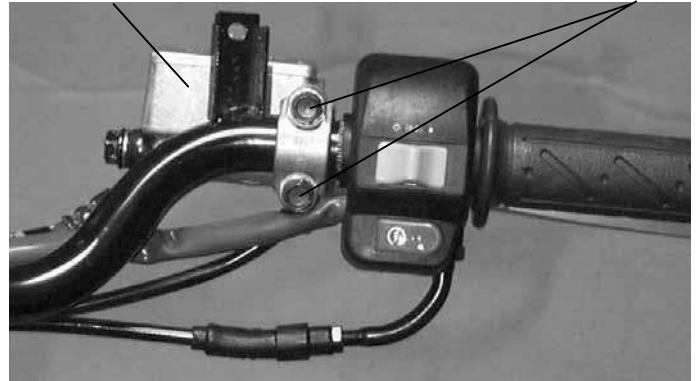

Disassembly

Remove the piston rubber cover and snap ring from the brake master cylinder.

Snap Ring

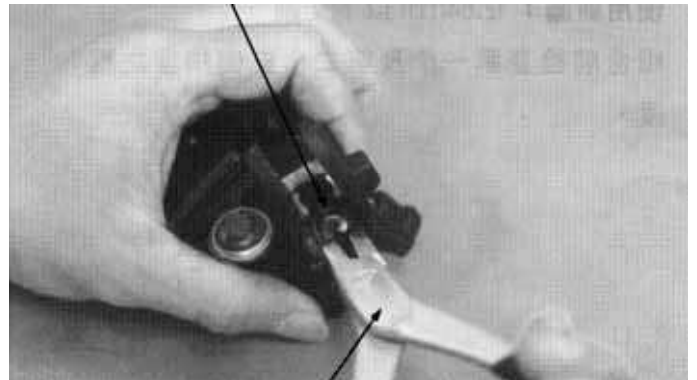

Snap Ring Pliers (close)

Remove the washer, main piston and spring from the brake master cylinder. Clean the inside of the master cylinder and brake reservoir with brake fluid.

Master Cylinder

Spring

Main Piston

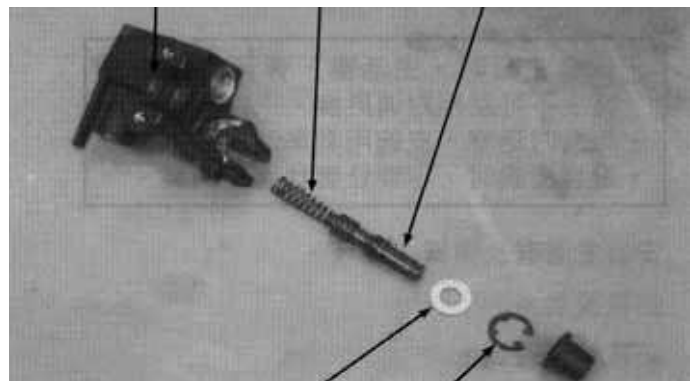

Washer

Snap Ring

13. STEERING HANDLEBAR/FRONT WHEEL/FRONT BRAKE/FRONT SHOCK ABSORBER/FRONT FORK

Inspection

Measure the brake master cylinder I.D.

Service Limit: 12.75mm

Inspect the master cylinder for scratch or crack.



Measure the brake master cylinder piston O.D.

Service Limit: 12.6mm

Before assembly, inspect the 1st and 2nd rubber cups for wear.



Assembly

Before assembly, apply brake fluid to all removed parts.

Install the spring together with the 1st rubber cup.

*

- During assembly, the main piston and spring must be installed as a unit without exchange.
- When assembling the piston, soak the cups in brake fluid for a while.
- Install the cups with the cup lips facing the correct direction.

Install the main piston, spring and snap ring.

Install the rubber cover.

Install the brake lever.



13. STEERING HANDLEBAR/FRONT WHEEL/FRONT BRAKE/FRONT SHOCK ABSORBER/FRONT FORK

Place the brake master cylinder on the handlebar and install the holder with “up” mark facing up. Be sure to align the punch mark with the holder joint. First tighten the upper bolt and then tighten the lower bolt.

Torque: 1.0~1.4kg-m

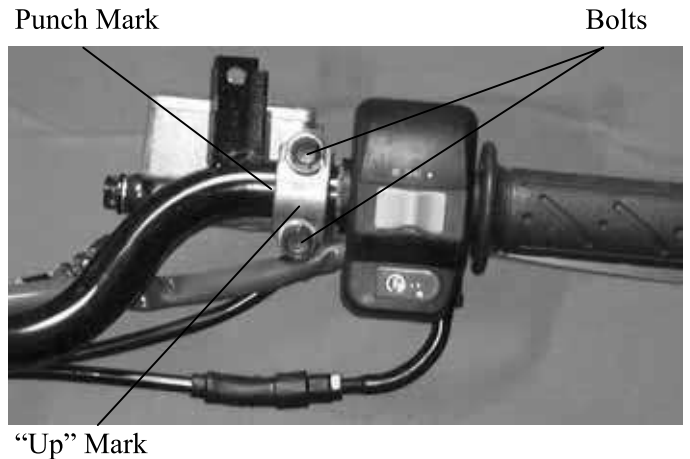

Install the brake fluid pipe with the attaching bolt and two sealing washers.

Install the handlebar covers. (⇒12-3)
Fill the brake reservoir with recommended brake fluid to the upper limit and bleed air according to the method stated in 13-12.

BRAKE CALIPER (FRONT)

Removal

Remove the brake caliper. (⇒13-13)
Place a clean container under the brake caliper and disconnect the brake fluid pipe from the caliper.

* Do not spill brake fluid on any coated surfaces.



13. STEERING HANDLEBAR/FRONT WHEEL/FRONT BRAKE/FRONT SHOCK ABSORBER/FRONT FORK

Disassembly

Remove the brake caliper seat from the brake caliper.

Brake Caliper Seat

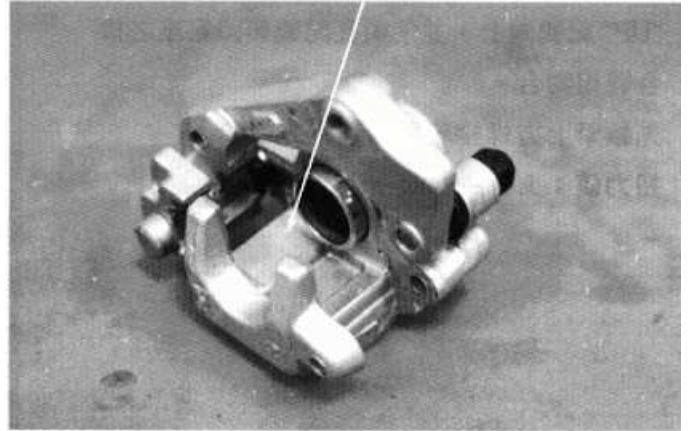

Remove the piston from the brake caliper. If necessary, use compressed air to squeeze out the piston through the brake fluid inlet opening and place a shop towel under the caliper to avoid contamination caused by the removed piston. Check the piston cylinder for scratch or wear and replace if necessary.

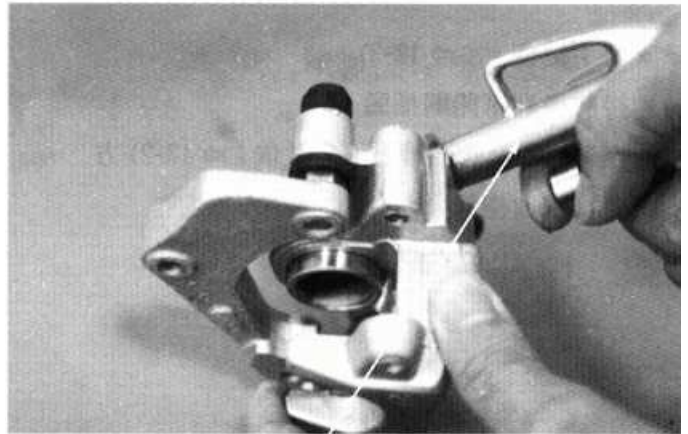

Compressed Air

Push the piston oil seal outward to remove it. Clean the oil seal groove with brake fluid.

Piston Oil Seal

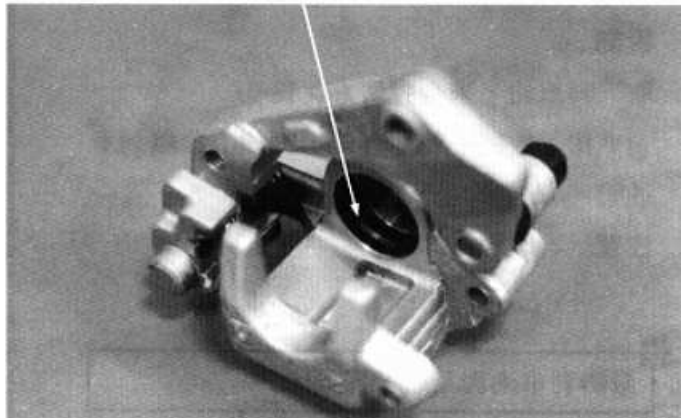

* Be careful not to damage the piston surface.

13. STEERING HANDLEBAR/FRONT WHEEL/FRONT BRAKE/FRONT SHOCK ABSORBER/FRONT FORK

Check the piston for scratch or wear.
Measure the piston O.D. with a micrometer.
Service Limit: 25.45mm



Check the caliper cylinder for scratch or wear and measure the cylinder bore.
Service Limit: 25.30mm

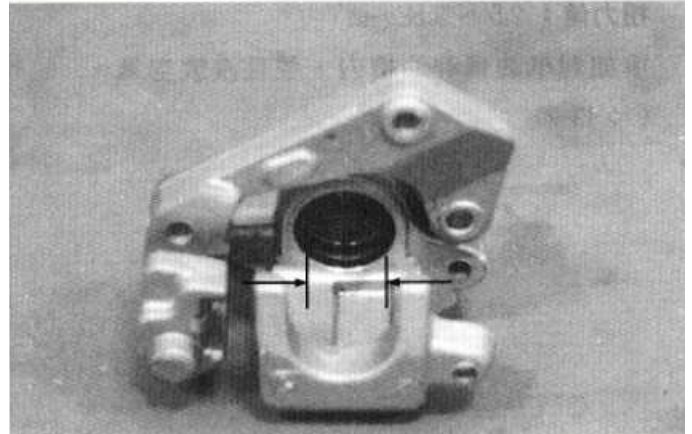

Assembly

Clean all removed parts.
Apply silicon grease to the piston and oil seal. Lubricate the brake caliper cylinder inside wall with brake fluid.
Install the brake caliper piston with grooved side facing out.

* Install the piston with its outer end 3~5mm protruding beyond the brake caliper.

Wipe off excessive brake fluid with a clean shop towel. Apply silicon grease to the brake caliper seat pin and caliper inside.
Install the brake caliper seat.

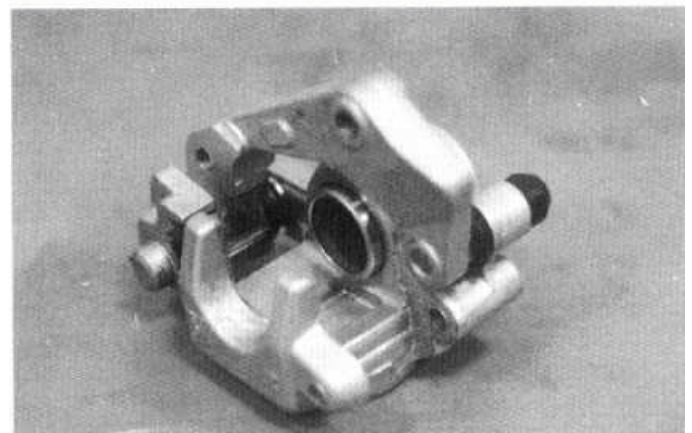

13. STEERING HANDLEBAR/FRONT WHEEL/FRONT BRAKE/FRONT SHOCK ABSORBER/FRONT FORK

Installation

Install the brake caliper and tighten the two bolts.

Torque: 2.9~3.5kg-m



Bolts

Connect the brake fluid pipe to the brake caliper and tighten the fluid pipe bolt.

Torque: 3.0~4.0kg-m

Fill the brake reservoir with recommended brake fluid and bleed air from the brake system. (⇒13-12)



Bolt

13. STEERING HANDLEBAR/FRONT WHEEL/FRONT BRAKE/FRONT SHOCK ABSORBER/FRONT FORK

FRONT SHOCK ABSORBER

REMOVAL

Remove the front wheel. (⇒13-5)
Remove the front fender. (⇒12-6)
Remove the front shock absorber upper mount bolts.
Loosen the lower mount bolts to remove the front shock absorbers.

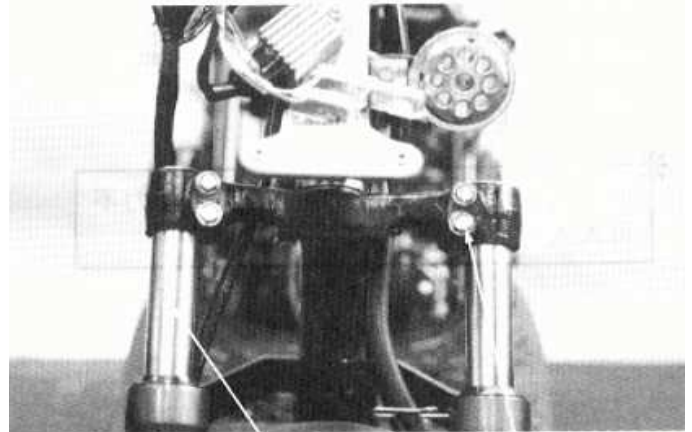

Front Shock Absorber

Mount Bolt

LEFT FRONT SHOCK ABSORBER DISASSEMBLY

Remove the dust boot.
Remove the circlip.

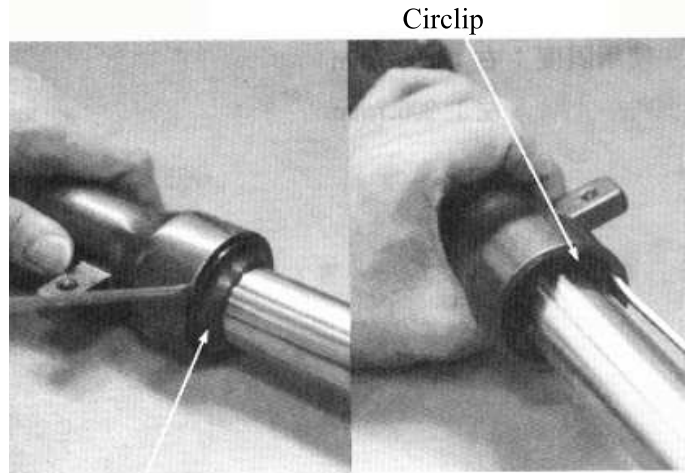

Dust Boot

Circlip

Use a vise to hold the front shock absorber and remove the shock absorber tube, hex bolt and copper washer from the front shock absorber.

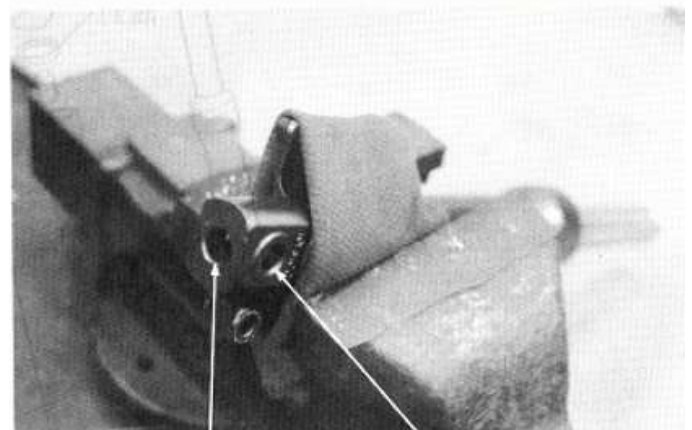

Bolt/Washer

Front Shock Absorber

13. STEERING HANDLEBAR/FRONT WHEEL/FRONT BRAKE/FRONT SHOCK ABSORBER/FRONT FORK

Use a vise to hold the front shock absorber tube and remove the damper from the shock absorber tube.

* When holding the shock absorber tube, place a shop towel under it and do not apply too much force.

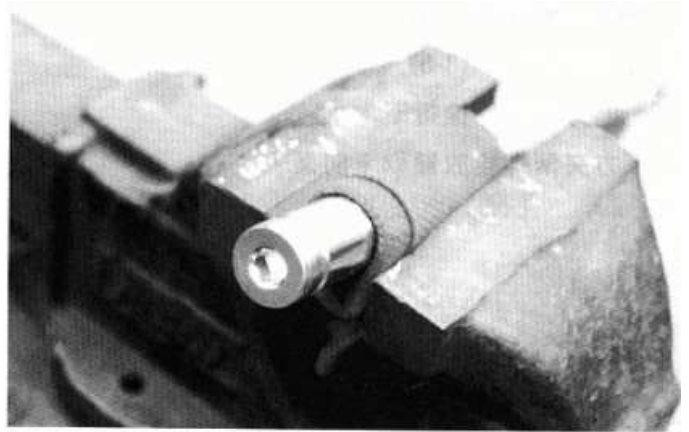

Measure the front shock absorber spring free length.

Service Limit: Right : 200mm
Left : 200mm

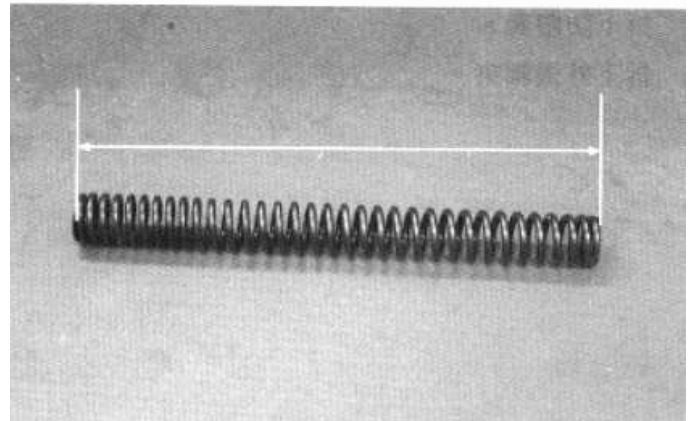

FRONT SHOCK ABSORBER ASSEMBLY

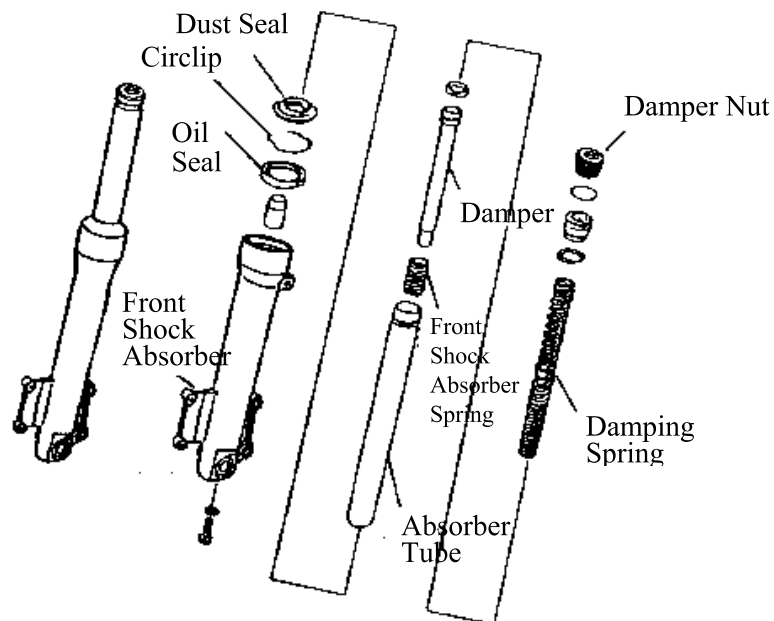

13. STEERING HANDLEBAR/FRONT WHEEL/FRONT BRAKE/FRONT SHOCK ABSORBER/FRONT FORK

Install the damping spring to the damper and then install them into the front shock absorber tube.
Install the front shock absorber spring and tighten the damper nut.

* Install the front shock absorber spring with the loosely wound coils facing up.

Use a vise to hold the front shock absorber.
Tighten the hex bolt.
(Apply locking agent to the washer and socket hex bolt and install them together.)

Torque: 1.5~3.0kg-m

Specified Oil: ss#8

Oil Capacity: 61cc

Install the circlip.
Install the dust boot.

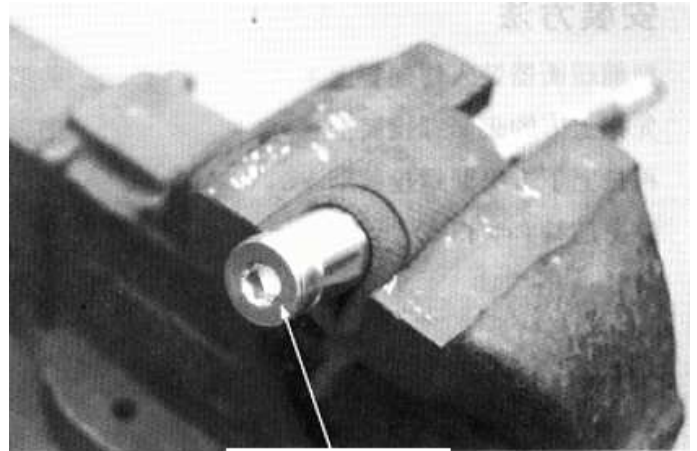

Damper Nut

Front Shock Absorber

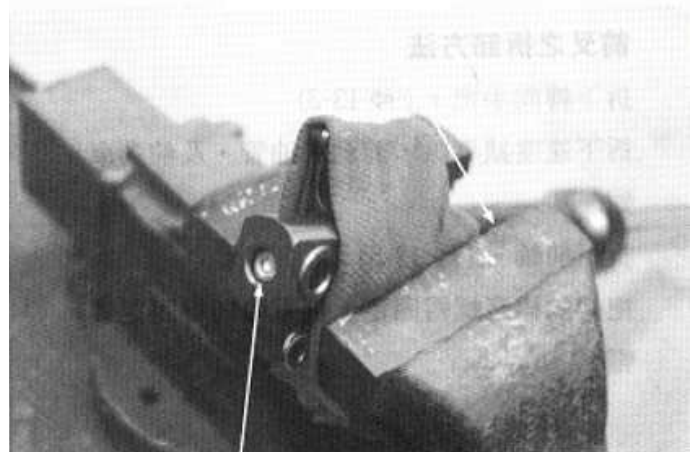

Bolt/Washer

Circlips

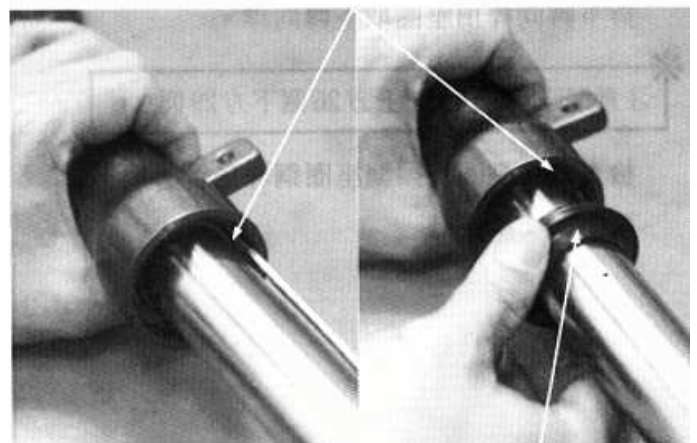

Dust Boot

13. STEERING HANDLEBAR/FRONT WHEEL/FRONT BRAKE/FRONT SHOCK ABSORBER/FRONT FORK

INSTALLATION

Install the front shock absorbers onto the steering stem.
Install and tighten the front shock absorber upper mount bolts.
Tighten the lower mount bolts.
Install the front fender.
Install the front wheel. (⇒13-8)

Mount Bolts

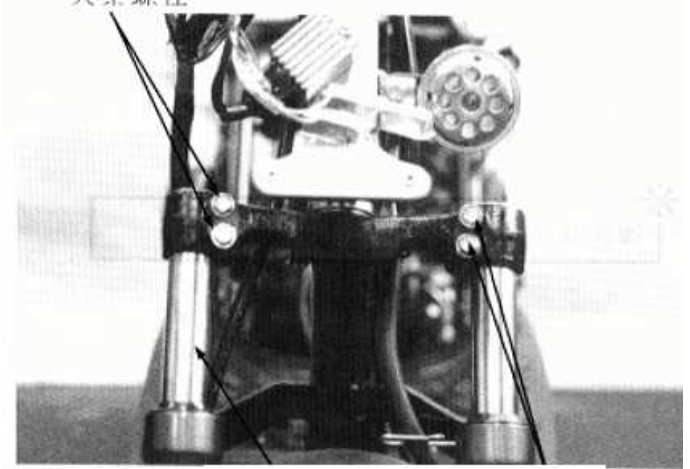

Front Shock Absorber

Mount Bolts

FRONT FORK

REMOVAL

Remove the steering handlebar. (⇒13-3)
Disconnect the speedometer cable and front brake fluid pipe and remove the front brake caliper.
Remove the front wheel. (⇒13-5)
Hold the steering stem top cone race and remove the steering stem lock nut.

Lock Nut Socket Wrench

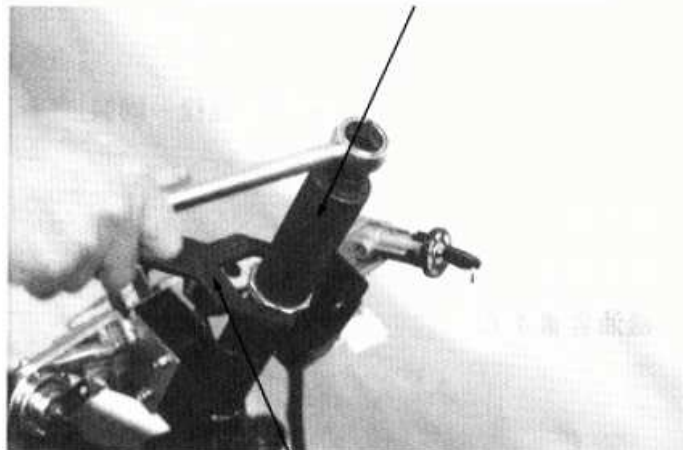

Lock Nut Wrench

Remove the top cone race and remove the front fork.

* Be careful not to lose the steel balls (26 on top race and 19 on bottom race).

Inspect the ball races, cone races and steel balls for wear or damage. Replace if necessary.



Top Cone Race

13. STEERING HANDLEBAR/FRONT WHEEL/FRONT BRAKE/FRONT SHOCK ABSORBER/FRONT FORK

BOTTOM CONE RACE REPLACEMENT

Remove the bottom cone race using a chisel.

Drive a new bottom cone race into place with a proper driver.

* Be careful not to damage the steering stem and front fork.

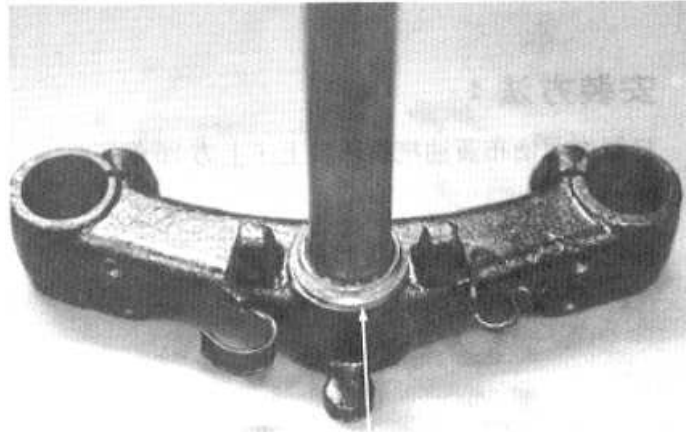

Bottom Cone Race

BALL RACE REPLACEMENT

Drive out the ball races.

Drive in new ball races.

* Be sure to drive the ball races into place completely.

Ball Race Remover

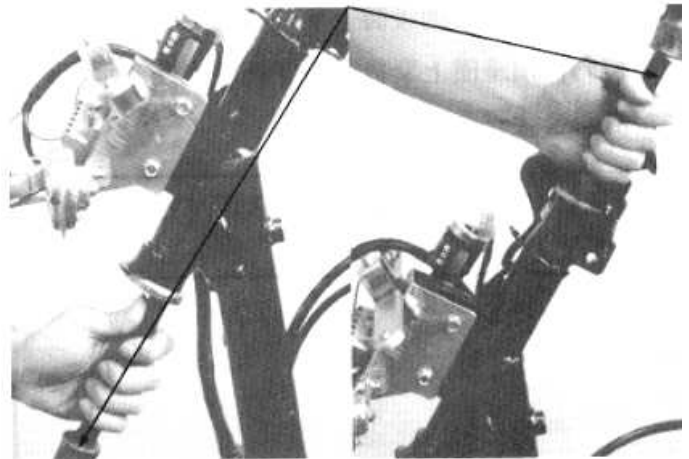

Driver Handle A

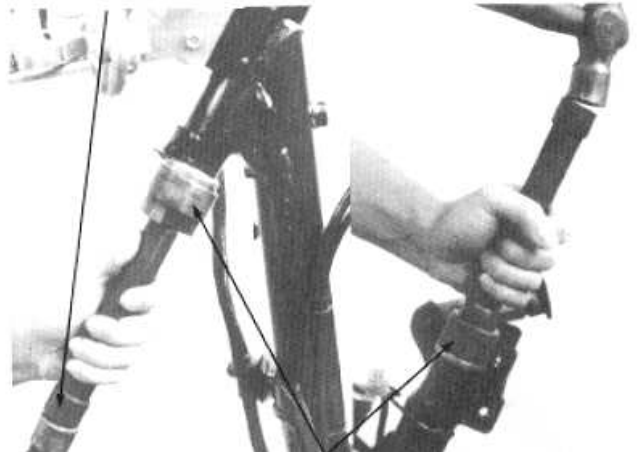

Outer Driver, 37x40mm

13. STEERING HANDLEBAR/FRONT WHEEL/FRONT BRAKE/FRONT SHOCK ABSORBER/FRONT FORK

INSTALLATION

Apply grease to top and bottom ball races and install 26 steel balls on the top ball race and 29 steel balls on the bottom ball race. Apply grease to the ball races again and then install the front fork.



Apply grease to the top cone race and install it.

Tighten the top cone race and then turn the steering stem right and left several times to make steel balls contact each other closely.

*

Check that the steering stem rotates freely without vertical play.



Top Cone Race

Lock Nut Socket Wrench

Install the steering stem lock nut and tighten it while holding the top cone race.

Torque: 8.0~12.0kg-m

Install the handlebar. (⇒13-4)

Install the speedometer cable.



Lock Nut Wrench

14. REAR WHEEL/REAR BRAKE/REAR SHOCK ABSORBER

REAR WHEEL/REAR BRAKE/REAR SHOCK ABSORBER

SERVICE INFORMATION	14-2
TROUBLESHOOTING	14-2
REAR WHEEL.....	14-3
REAR BRAKE	14-4
REAR SHOCK ABSORBER.....	14-7

14. REAR WHEEL/REAR BRAKE/REAR SHOCK ABSORBER

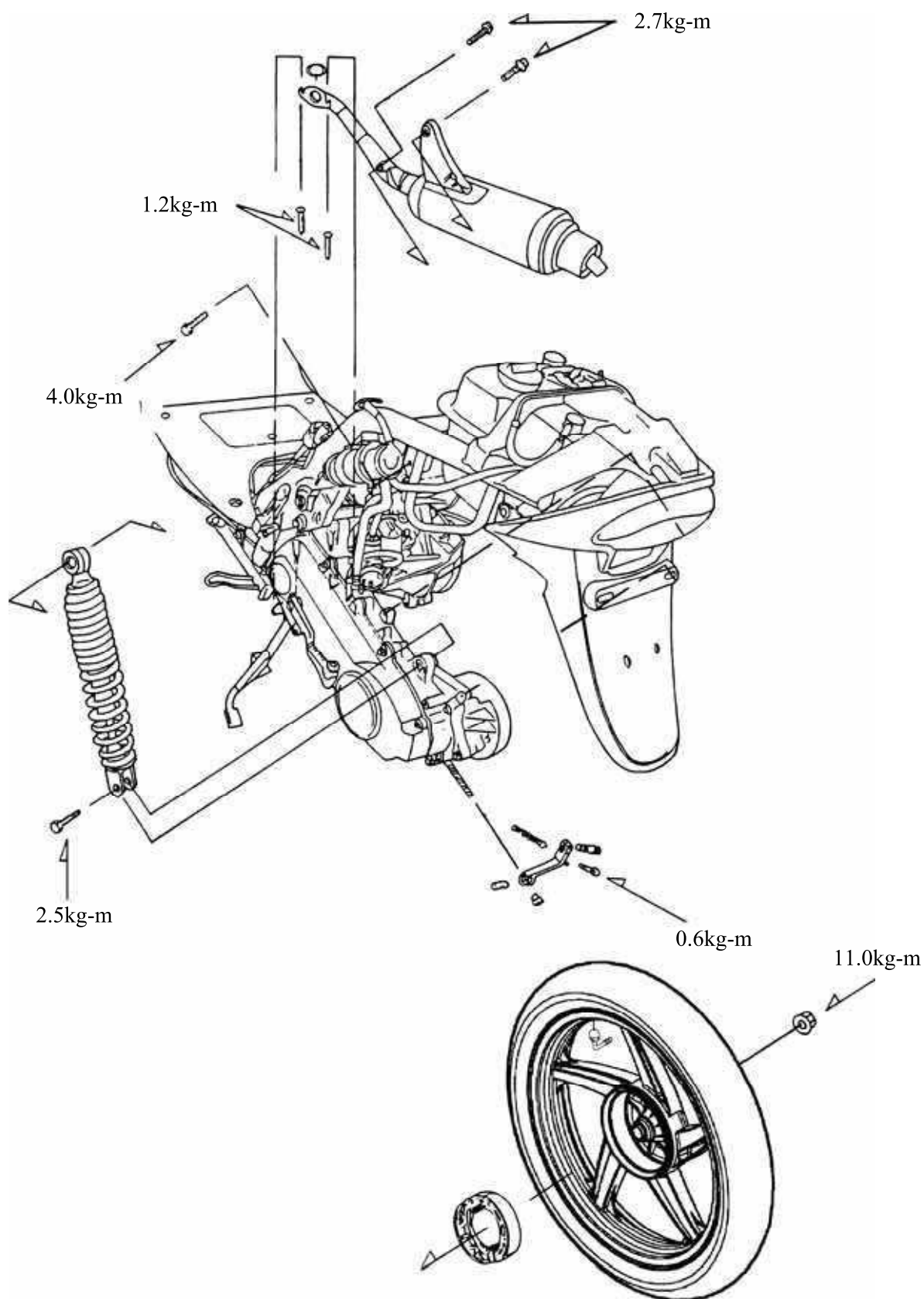

14. REAR WHEEL/REAR BRAKE/REAR SHOCK ABSORBER

SERVICE INFORMATION

SPECIFICATIONS

Item	Standard (mm)	Service Limit (mm)
Rear wheel rim runout		2.0
Rear brake drum I.D.	110	111
Rear brake lining thickness	4.0	2.0
Rear shock absorber spring free length	235.7	218.7

TORQUE VALUES

Rear axle nut	11.0~13.0kg-m
Rear shock absorber upper mount bolt	3.5~4.5kg-m
Rear shock absorber lower mount bolt	2.4~3.0kg-m
Rear shock absorber lower joint nut	3.5~4.5kg-m (apply locking agent)

SPECIAL TOOL

Rear shock absorber remover
Rear shock absorber compressor

TROUBLESHOOTING

Rear wheel wobbling

- Bent rim
- Faulty tire
- Axle not tightened properly

Soft rear shock absorber

- Weak shock absorber spring

Poor brake performance

- Brake not adjusted properly
- Contaminated brake linings
- Worn brake linings
- Worn brake shoes at cam contacting area
- Worn brake cam
- Improper engagement between brake arm and wear indicator plate

14. REAR WHEEL/REAR BRAKE/REAR SHOCK ABSORBER

REAR WHEEL

REMOVAL

Remove the two exhaust muffler joint lock nuts.
Remove the two exhaust muffler lock bolts.
Remove the exhaust muffler.
Remove the rear axle nut to remove the rear wheel.

Rear Axle Nut

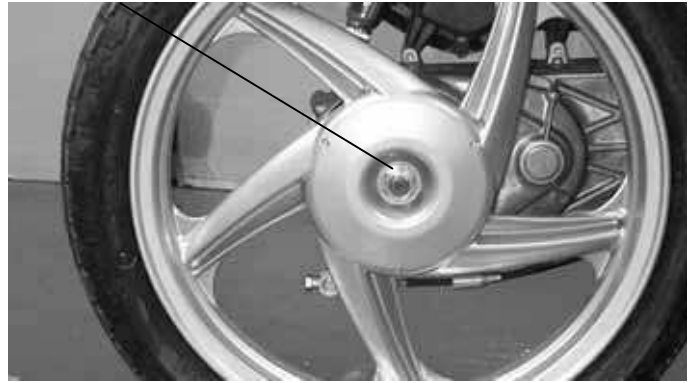

INSPECTION

Measure the rear wheel rim runout.

Service Limits:

Radial : 2.0mm replace if over

Axial : 2.0mm replace if over

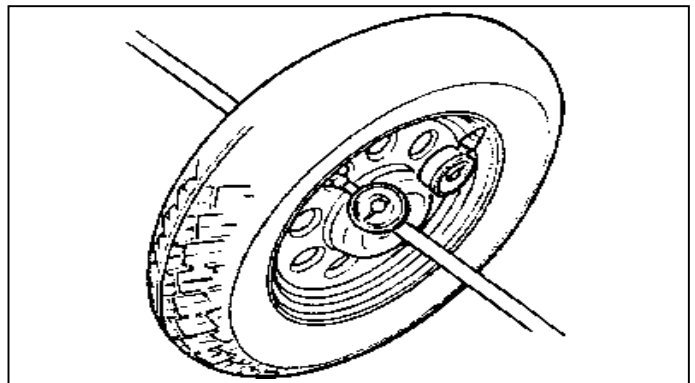

INSTALLATION

Install the rear wheel and apply SAE30# engine oil to the axle threads. Then, tighten the rear axle nut.

Torque values:

Rear axle nut: 11.0~13.0kg-m

Rear Axle Nut

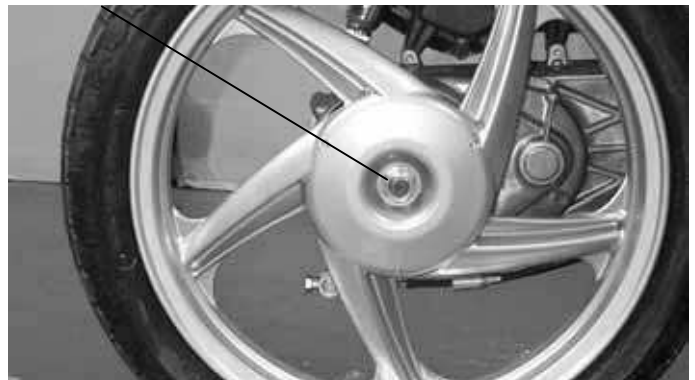

14. REAR WHEEL/REAR BRAKE/REAR SHOCK ABSORBER

REAR BRAKE

Remove the rear wheel. (⇒14-3)
Inspect the rear brake drum.
Measure the rear brake drum I.D.
Service Limit: 95.5mm replace if over



BRAKE LINING INSPECTION

Measure the brake lining thickness.
Service Limit: 2.0mm replace if below

*

Keep oil or grease off the brake linings.

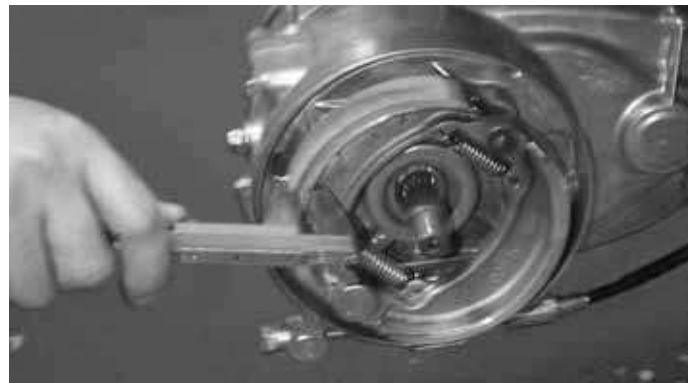

REAR BRAKE DISASSEMBLY

Remove the rear brake adjusting nut and disconnect the rear brake cable.
Remove the rear brake shoes.

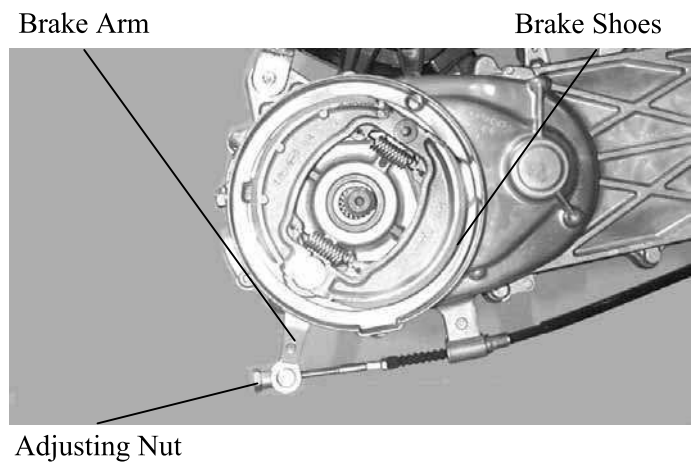

14. REAR WHEEL/REAR BRAKE/REAR SHOCK ABSORBER

Remove the brake cam bolt to remove the brake arm, wear indicator plate and felt seal.
Remove the brake arm.

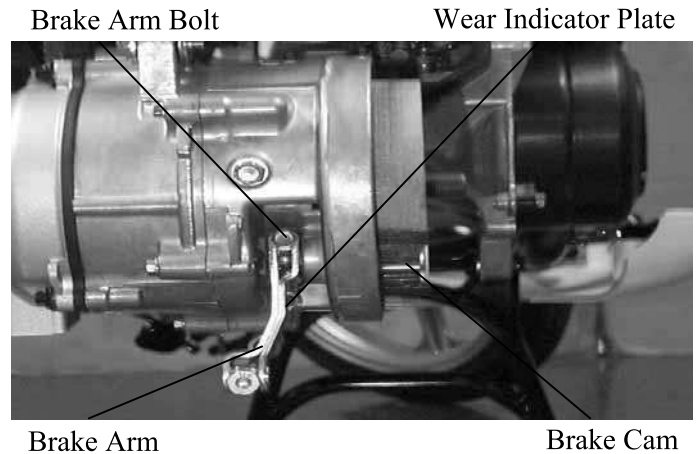

REAR BRAKE ASSEMBLY

Apply grease to the anchor pin and brake shoe moving parts.
Apply grease to the brake cam and install it.

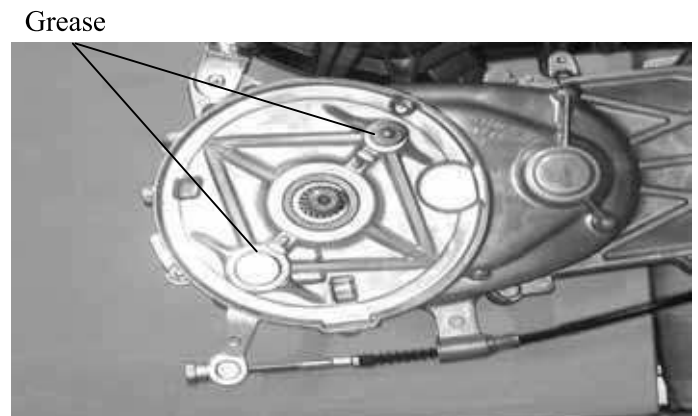

Apply engine oil to the felt seal and install it to the brake cam.

* Install the wear indicator plate.

Align the wide tooth of the wear indicator plate with the wide groove on the brake cam.

* Install the brake arm onto the brake cam.

Align the punch mark on the brake arm with the scribed line on the brake cam.

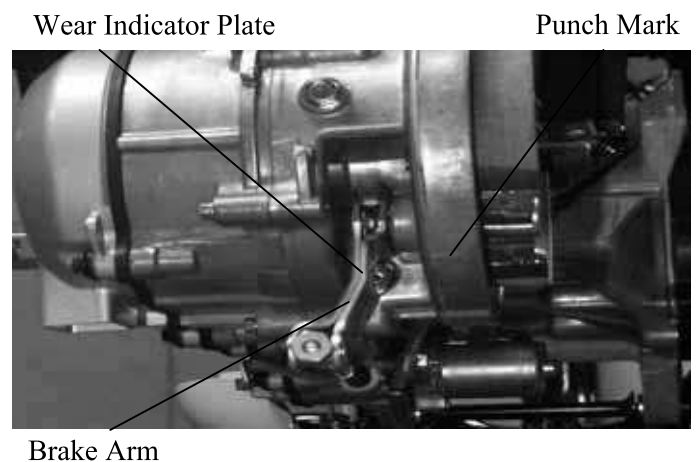

Install and tighten the brake arm bolt.
Install the brake arm return spring.
Install the brake shoes.

14. REAR WHEEL/REAR BRAKE/REAR SHOCK ABSORBER

Install the brake arm pin.
Connect the brake cable and install the adjusting nut.
Install the rear wheel. (⇒14-3)
Adjust the rear brake lever free play. (⇒3-4)

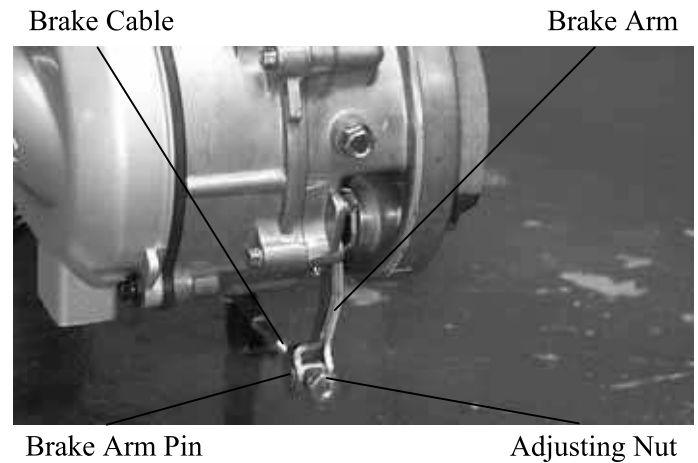

14. REAR WHEEL/REAR BRAKE/REAR SHOCK ABSORBER

REAR SHOCK ABSORBER

REMOVAL

Remove the front cover. (⇒12-6)
Remove the met-in box. (⇒12-5)
Remove the air cleaner case. (⇒5-2)
Remove the rear shock absorber upper and lower mount bolts to remove the rear shock absorber.

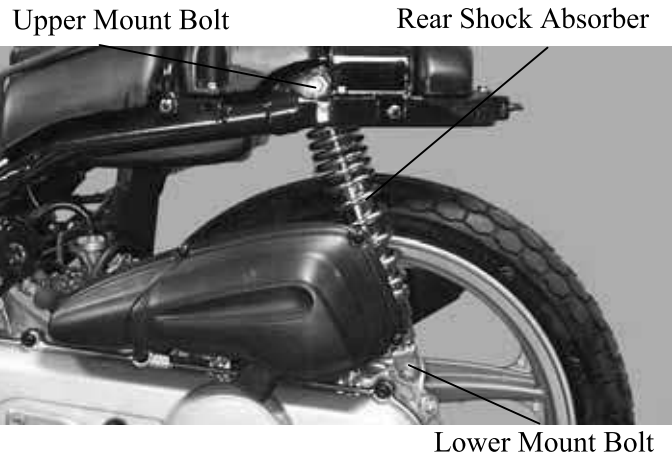

DISASSEMBLY

Install the rear shock absorber compressor as the figure shown.

* Install the rear shock absorber lower joint into the rear shock absorber compressor.

Compress the rear shock absorber spring.

Rear Shock Absorber Compressor



Rear Shock Absorber Remover

Loosen the lower joint lock nut.
Remove the lower joint.
Remove the lock nut, rubber and damper.

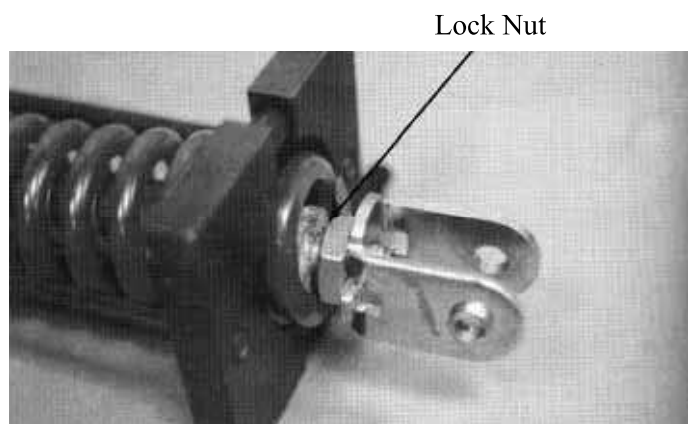

14. REAR WHEEL/REAR BRAKE/REAR SHOCK ABSORBER

INSPECTION

Inspect the damper rod for bending or damage.
Inspect the damper for oil leaks.
Inspect the damper rubber for deterioration or damage.

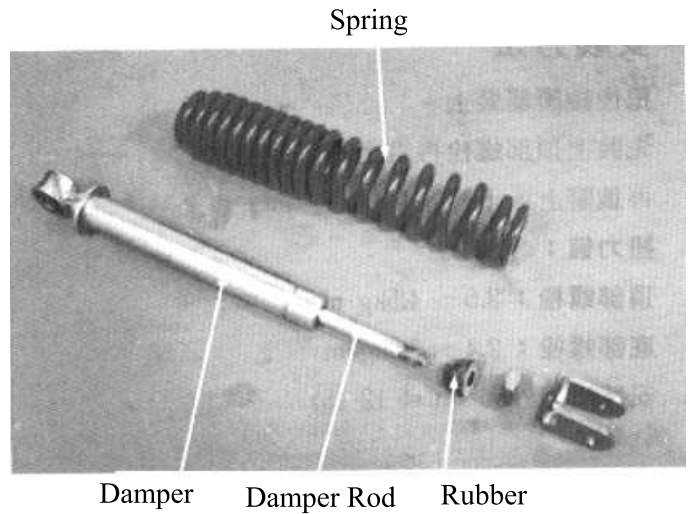

Measure the rear shock absorber spring free length.

Service Limit: 232mm replace if below

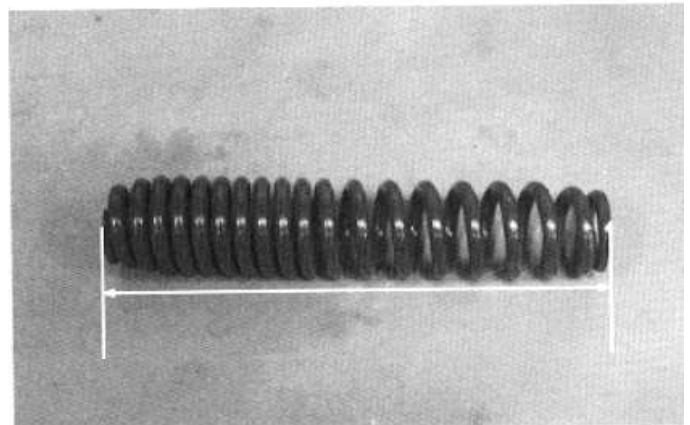

ASSEMBLY

Assemble the rear shock absorber in the reverse order of disassembly.

- *
- Install the shock absorber spring with loosely wound coils facing down.
 - Apply locking agent to the lock nut thread and then install and tighten the lock nut.

Tighten the lock nut.

Torque: 3.5~4.5kg-m

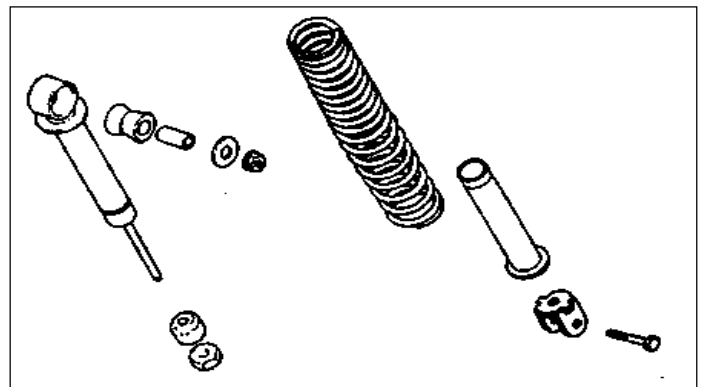

14. REAR WHEEL/REAR BRAKE/REAR SHOCK ABSORBER

INSTALLATION

Install the rear shock absorber.
Install the rear shock absorber upper mount bolt and then install the lower mount bolt.

Torque:

Upper Mount Bolt: 3.5~4.5kg-m

Lower Mount Bolt: 2.4~3.0kg-m

Install the frame body cover. (⇒12-5)

Upper Mount Bolt



Lower Mount Bolt

15. ELECTRICAL EQUIPMENT

15

ELECTRICAL EQUIPMENT

SERVICE INFORMATION	15- 1
TROUBLESHOOTING	15- 1
CHARGING SYSTEM	15- 3
BATTERY	15- 4
IGNITION SYSTEM	15- 7
STARTING SYSTEM.....	15-11

15. ELECTRICAL EQUIPMENT

SERVICE INFORMATION

GENERAL INSTRUCTIONS

- It is not necessary to check the battery electrolyte or fill with distilled water.
- Remove the battery from the motorcycle for charging. Do not remove the electrolyte cap..
- Do not quick charge the battery. Quick charging should only be done in an emergency..
- Charge the battery according to the charging current and time specified on the battery.
- When charging, check the voltage (open voltage) with an electric tester.
- When replacing the battery, do not use a traditional battery.

SPECIFICATIONS

SPECIFICATIONS		BA10AB.AC.
Battery	Capacity	12V4AH
	Voltage	13.0~13.2V
	Charging current	Standard Quick
Spark plug	(NGK)	BR8HSA
Spark plug gap		0.6~0.7mm
Ignition coil resistance	Primary coil	0.2~0.3Ω
	Secondary coil (with plug cap)	7.0~8.4KΩ
	Secondary coil (without plug cap)	2.5~3.2KΩ
Pulser coil resistance (20°C)		80~160Ω
Ignition timing		8°~14°±1.5°BTDC/2000rpm

TROUBLESHOOTING

CHARGING SYSTEM

No power

- Dead battery
- Disconnected battery cable
- Fuse burned out
- Faulty ignition switch

Low power

- Weak battery
- Loose battery connection
- Charging system failure
- Faulty regulator/rectifier

Intermittent power

- Loose battery cable connection
- Loose charging system connection
- Loose connection or short circuit in ignition system
- Loose connection or short circuit in lighting system

Charging system failure

- Loose, broken or shorted wire or connector
- Faulty regulator/rectifier
- Faulty A.C. generator

15. ELECTRICAL EQUIPMENT

IGNITION SYSTEM

No spark at plug

- Faulty spark plug
- Poorly connected, broken or shorted wire
 - Between A.C. generator and CDI unit
 - Between CDI unit and ignition coil
 - Between CDI unit and ignition switch
 - Between ignition coil and spark plug
- Faulty ignition switch
- Faulty ignition coil
- Faulty CDI unit
- Faulty A.C. generator

Engine starts but turns poorly

- Ignition primary circuit
 - Faulty ignition coil
 - Poorly connected wire or connector
- Ignition secondary circuit
 - Faulty ignition coil
 - Faulty spark plug
 - Poorly insulated plug cap
- Improper ignition timing
 - Battery voltage too low (6V max.)
 - Faulty CDI unit

STARTING SYSTEM

Starter motor won't turn

- Fuse burned out
- Weak battery
- Faulty ignition switch
- Faulty starter switch
- Faulty front or rear stop switch
- Faulty starter relay
- Poorly connected, broken or shorted wire
- Faulty starter motor

Lack of power

- Weak battery
- Loose wire or connection
- Foreign matter stuck in starter motor or pinion

Starter motor rotates but engine does not start

- Faulty starter pinion
- Starter motor rotates reversely
- Faulty starter clutch
- Weak battery

15. ELECTRICAL EQUIPMENT

CHARGING SYSTEM

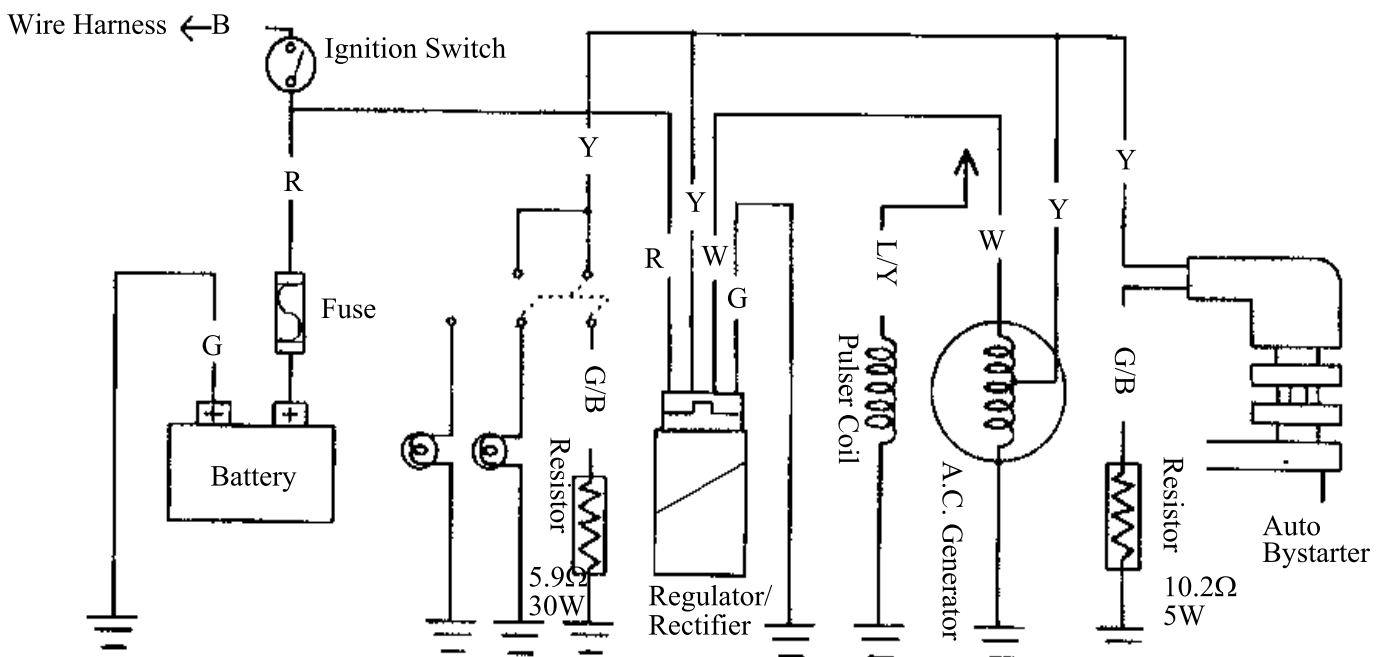
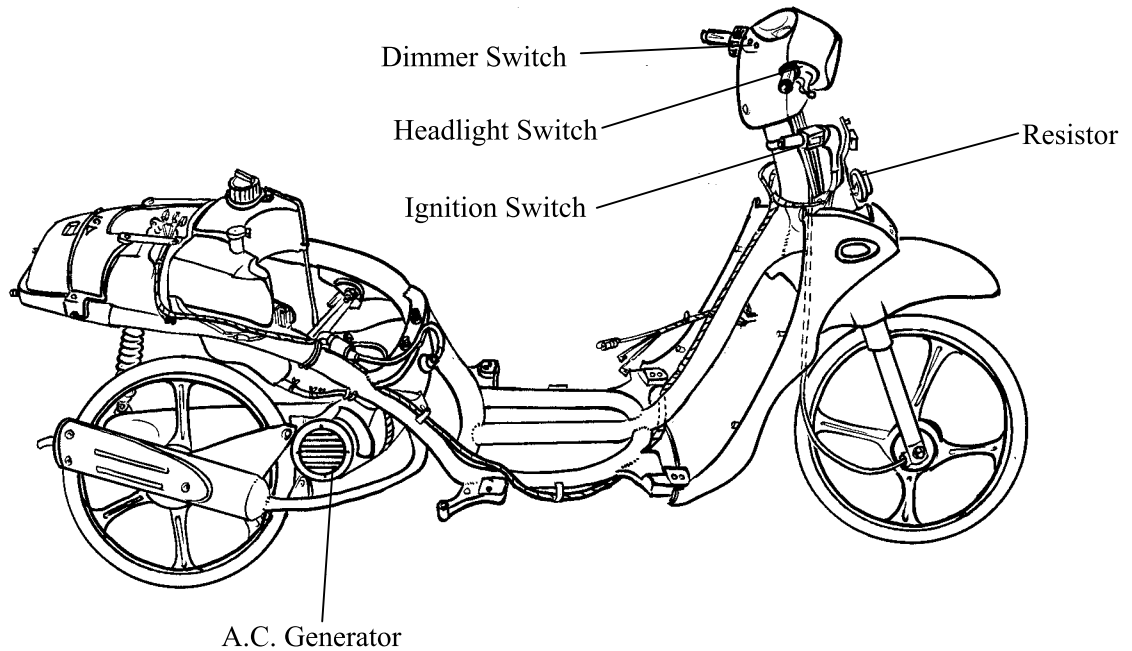

15. ELECTRICAL EQUIPMENT

BATTERY

BATTERY REMOVAL

Remove the front tool box cover.

Disconnect the battery cables .

- * First disconnect the battery negative (-) cable and then the positive (+) cable.

Remove the bolt and battery bracket.

Remove the battery.

The installation sequence is the reverse of removal.

BATTERY CHARGING (OPEN CIRCUIT VOLTAGE) INSPECTION

Remove the battery cover and disconnect the battery cables.

Measure the voltage between the battery terminals.

Fully charged : 13.0V ~ 13.2V

Undercharged : 12.3V max.

- * Battery charging inspection must be performed with an electric tester.

CHARGING METHOD

Connect the charger positive (+) cable to the battery positive (+) cable.

Connect the charger negative (-) cable to the battery negative (-) cable.

- *
 - Keep flames and sparks away from a charging battery.
 - Turn power ON/OFF at the charger, not at the battery terminals to prevent sparks near the battery.
 - Charge the battery according to the current specified on the battery surface.

Charging current: Standard : 0.4A

Quick : 4A

Charging time : Standard : 5 hours

Quick : 0.5 HOUR

After charging: Open circuit voltage: 12.8V min.

- *
 - Quick charging should only be done in an emergency.
 - During quick charging, the battery temperature should not exceed 45°C .
 - Measure the voltage 30 minutes after the battery is charged.



Front tool box Cover

Battery

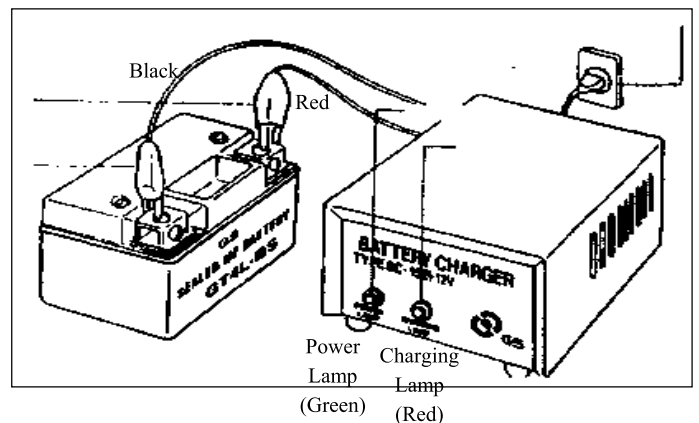
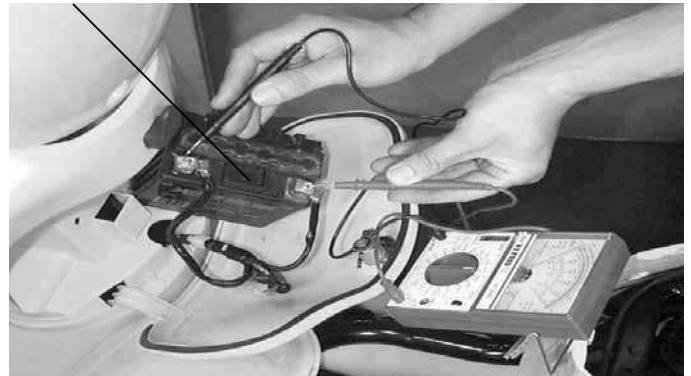

15. ELECTRICAL EQUIPMENT

PERFORMANCE TEST

Warm up the engine.
Remove the floor mat and front tool box cover.

* Use a fully charged battery to check the charging system output.

Stop the engine and open the fuse box. Disconnect the wire lead from the fuse terminal. Connect an ammeter between the wire lead and fuse terminal as shown. Connect the battery positive (+) terminal to the voltmeter positive (+) probe and battery negative (-) terminal to the voltmeter negative (-) probe.

Start the engine, gradually increase engine speed to test the output:

Position RPM	Day	Night
2500	1.3A min.	1.0A min.
6000	2.0A min.	2.0A min.

Charging Limit Voltage: $14.5 \pm 0.5V/8000rpm$

If the limit voltage is not within the specified range, check the regulator/rectifier.

A.C. GENERATOR (CHARGING COIL) INSPECTION

* Inspect with the engine installed.

Remove the met-in box. (\Rightarrow 12-4)
Disconnect the A.C. generator connector. Measure the resistances between the charging coil terminals (white-green) and lighting coil terminals (yellow-green).

Resistances:

Charging coil	white-green	$0.2 \sim 1.2\Omega$
Lighting coil	yellow-green	$0.3 \sim 1.0\Omega$

Refer to 7-3 for A.C. generator removal.

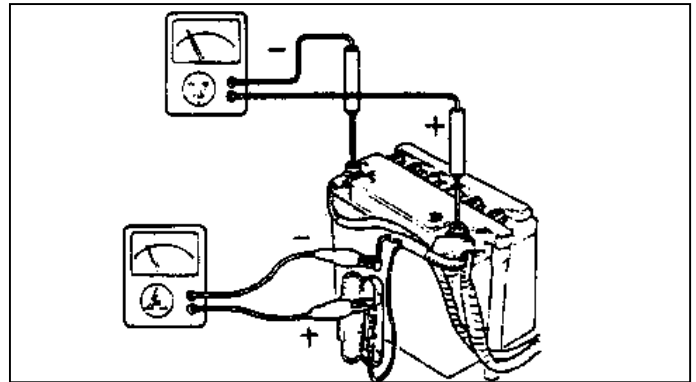

A.C. Generator Connector

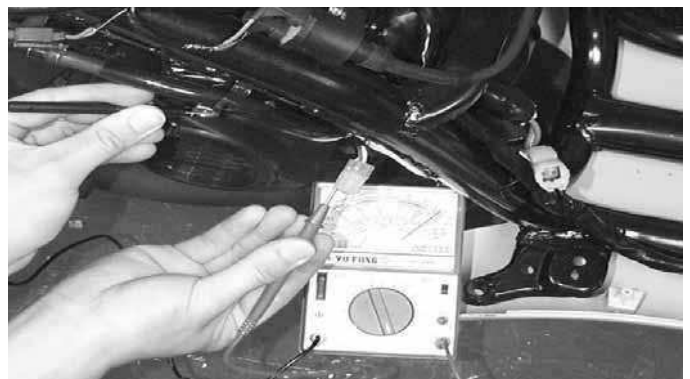

15. ELECTRICAL EQUIPMENT

RESISTOR INSPECTION

Remove the frame front cover. (⇒12-3)
 Measure the resistance between the resistor B pink wire and ground.
 Measure the resistance between the resistor A green/black wire and ground.

Resistances:

- Resistor A: 9.9~12.0Ω
- Resistor B: 5.6~7.2Ω

* Faulty resistor is the cause of faulty operation of the auto bystarter.

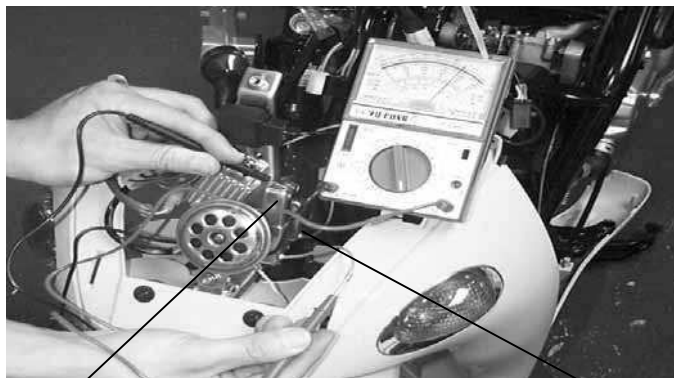

Resistor A

Resistor B

REGULATOR/RECTIFIER INSPECTION

Remove the front cover. (⇒12-3)
 Disconnect the regulator/rectifier wire coupler and remove the bolt to remove the regulator/rectifier.

Measure the resistances between the terminals.
 Replace the regulator/rectifier if the readings are not within the specifications in the table below.

* Due to the semiconductor in circuit, it is necessary to use a specified tester for accurate testing. Use of an improper tester in an improper range may give false readings.

- Use a Sanwa Electric Tester (07208-0020000) or Kowa Electric Tester (TH-5H). The proper range for testing is listed below.

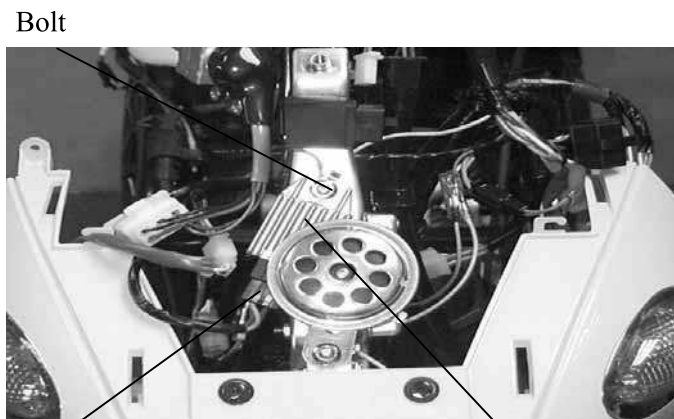

Coupler

Regulator/Rectifier

Model	Brand	Range
SP-10D	Sanwa	KΩ
TH-5H	Kowa	100Ω

C (Yellow) A (Red)

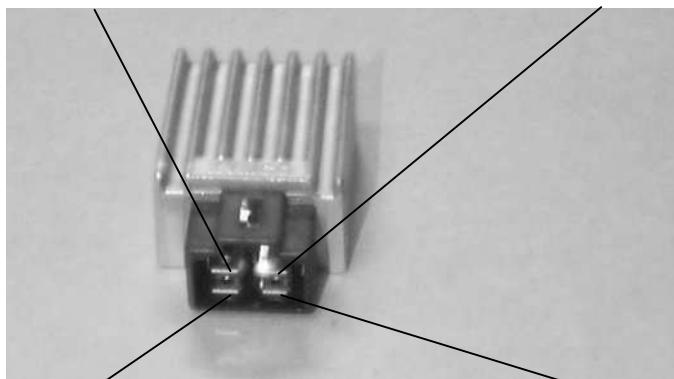

D (Green)

B (White)

Probe⊕ Probe(-)	A (R)	B (W)	C (Y)	D (G)
A (R)		20-35KΩ	∞	∞
B (W)	8-20KΩ		∞	∞
C (Y)	∞	∞		∞
D (G)	∞	∞	6.5-35KΩ	

15. ELECTRICAL EQUIPMENT

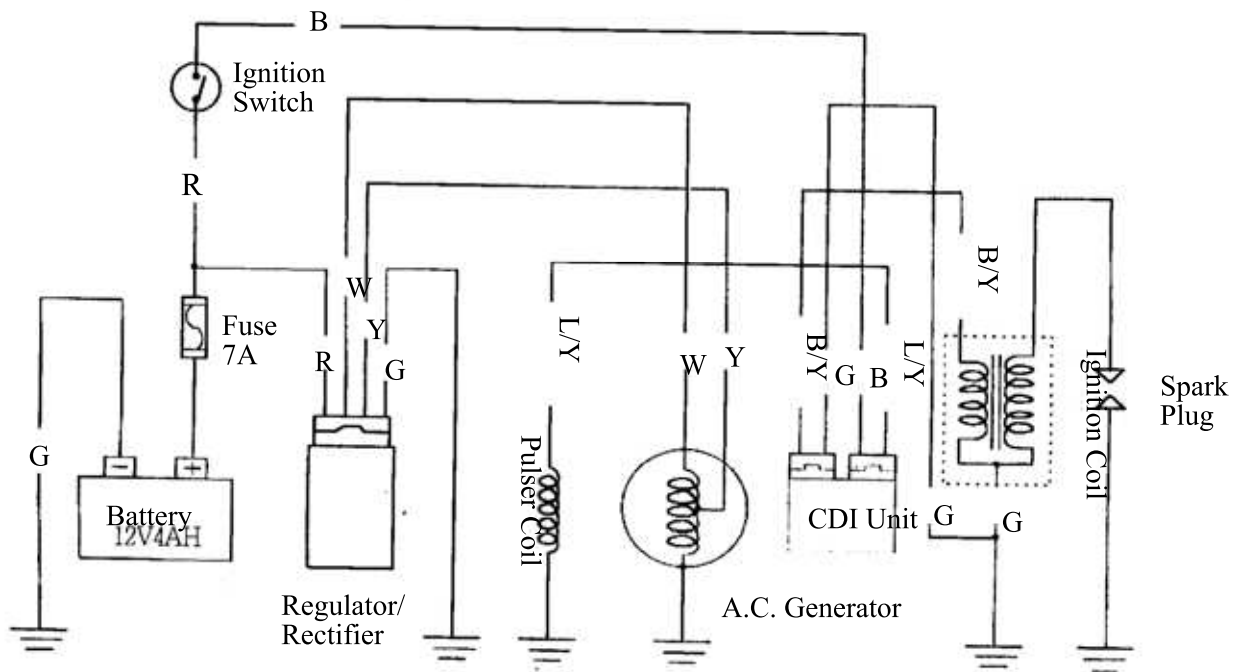
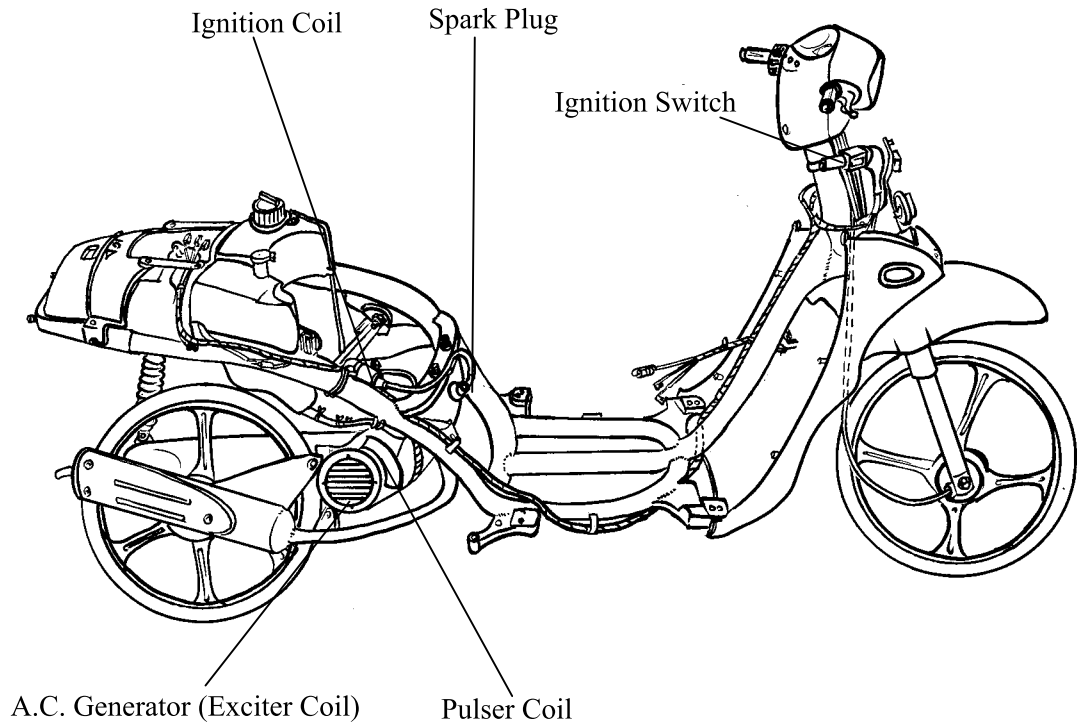

15. ELECTRICAL EQUIPMENT

IGNITION COIL INSPECTION

Continuity Test

* This test is to inspect the continuity of ignition coil.

Remove the met-in box. (⇒12-4)
Measure the resistance between the ignition coil primary coil terminals.

Resistance (20°C): 0.153~0.187Ω

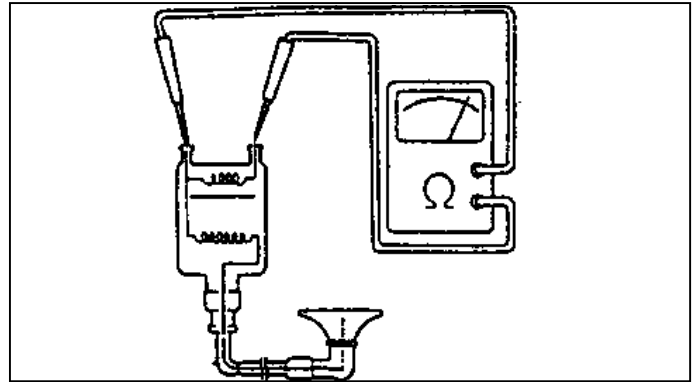

Measure the secondary coil resistance between the spark plug cap and the primary coil terminal as Figure A shown.

Resistance (20°C) (with plug cap): 7.0~8.4KΩ

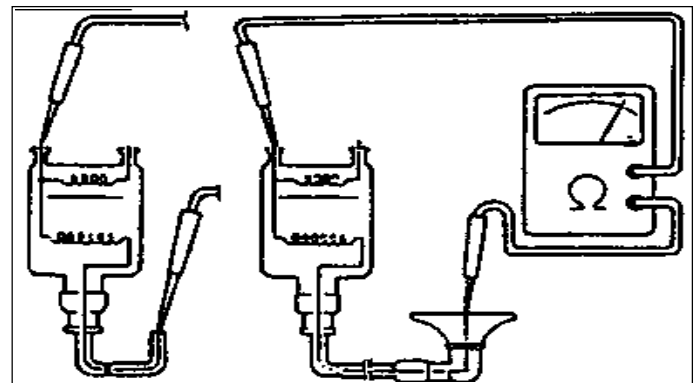

Figure B

Figure A

Measure the secondary coil resistance between the ignition coil terminal and the primary coil terminal as Figure B shown.

Resistance (20°C) (without plug cap): 2.5~3.2KΩ



Black

Green

15. ELECTRICAL EQUIPMENT

Performance Test

Remove the ignition coil.

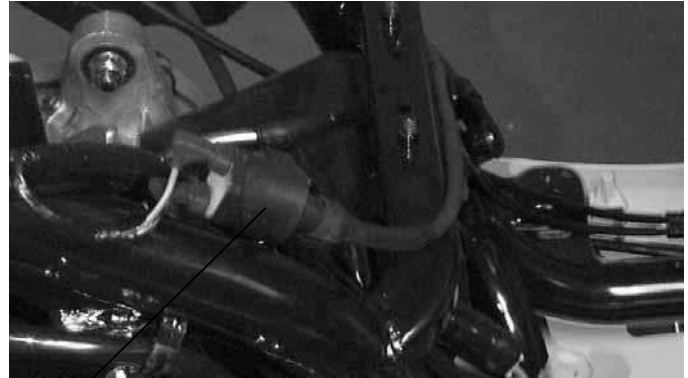

Ignition Coil

Inspect the ignition coil with an ignition coil tester.

* Follow the ignition coil tester manufacturer's instructions.

1. Turn the changeover switch to 12V and connect the ignition coil to the tester.
2. Turn the power switch ON and check the spark from the watch window.
 - Good : Normal and continuous spark
 - Faulty : Weak or intermittent spark

* The test is performed at both conditions that the ignition coil is cold and hot.

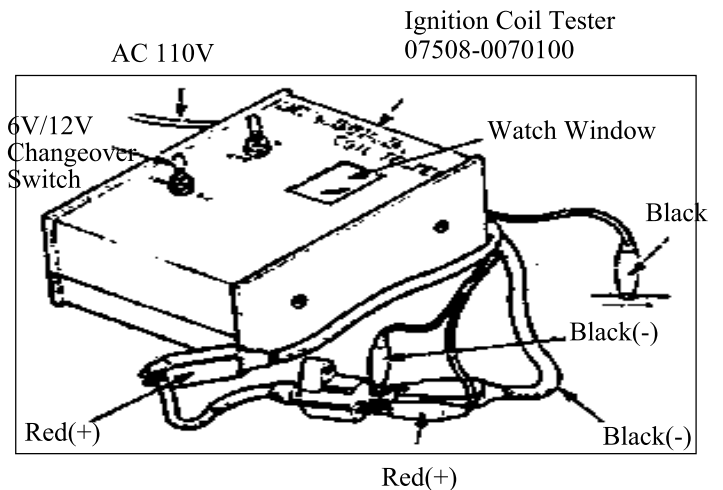

A.C. GENERATOR

Exciter Coil/Pulser Coil Inspection

* This test is performed with the stator installed in the engine.

Remove the met-in box. (⇒ 12-4)
Disconnect the A.C. generator wire connector.
Measure the pulser coil resistance between the blue/yellow and ground.

Resistance (20°C): 100~150Ω

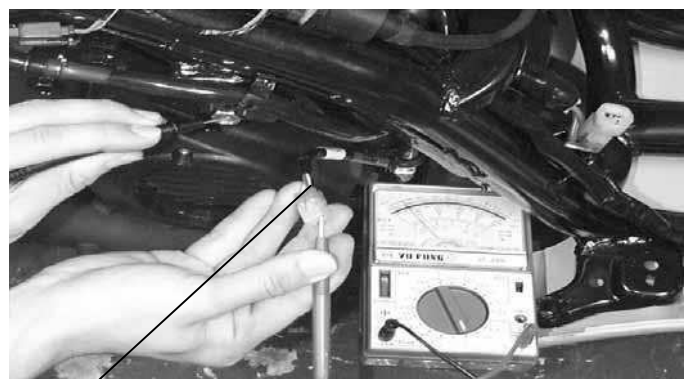

Blue/Yellow

15. ELECTRICAL EQUIPMENT

CDI UNIT INSPECTION

Remove the battery cover.
Disconnect the CDI coupler and remove the CDI unit.

Coupler



CDI Unit

CDI CIRCUIT INSPECTION

Measure the resistance between the terminals.
Replace the CDI unit if the readings are not within the specifications in the table below.

- * Due to the semiconductor in circuit, it is necessary to use a specified tester for accurate testing. Use of an improper tester in an improper range may give false readings.
- Use a Sanwa Electric Tester or Kowa Electric Tester (TH-5H).
 - In this table, “Needle swings then returns” indicates that there is a charging current applied to a condenser. The needle will then remain at “∞” unless the condenser is discharged.

Black/ Yellow Green

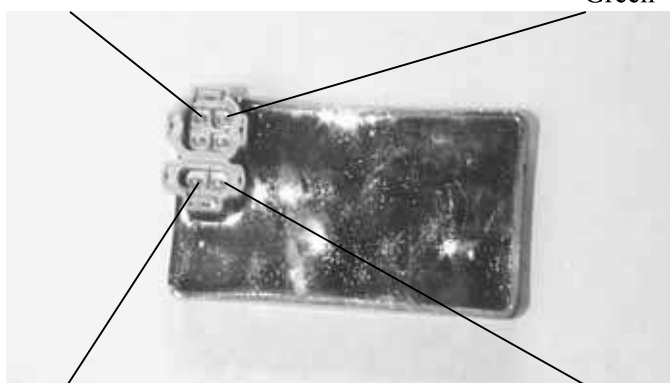

Blue/ Yellow

Black

Use the x KΩ range for the Sanwa Tester.
Use the x 100Ω range for the Kowa Tester.

Unit: KΩ

Probe⊕ (-)Probe	Black	Blue/ Yellow	Green	Black/ Yellow
Black		∞	13~16	∞
Blue/ Yellow	33~40		18~22	∞
Green	8~10	∞		∞
Black/ Yellow	14~17	∞	2.5~3.0	

15. ELECTRICAL EQUIPMENT

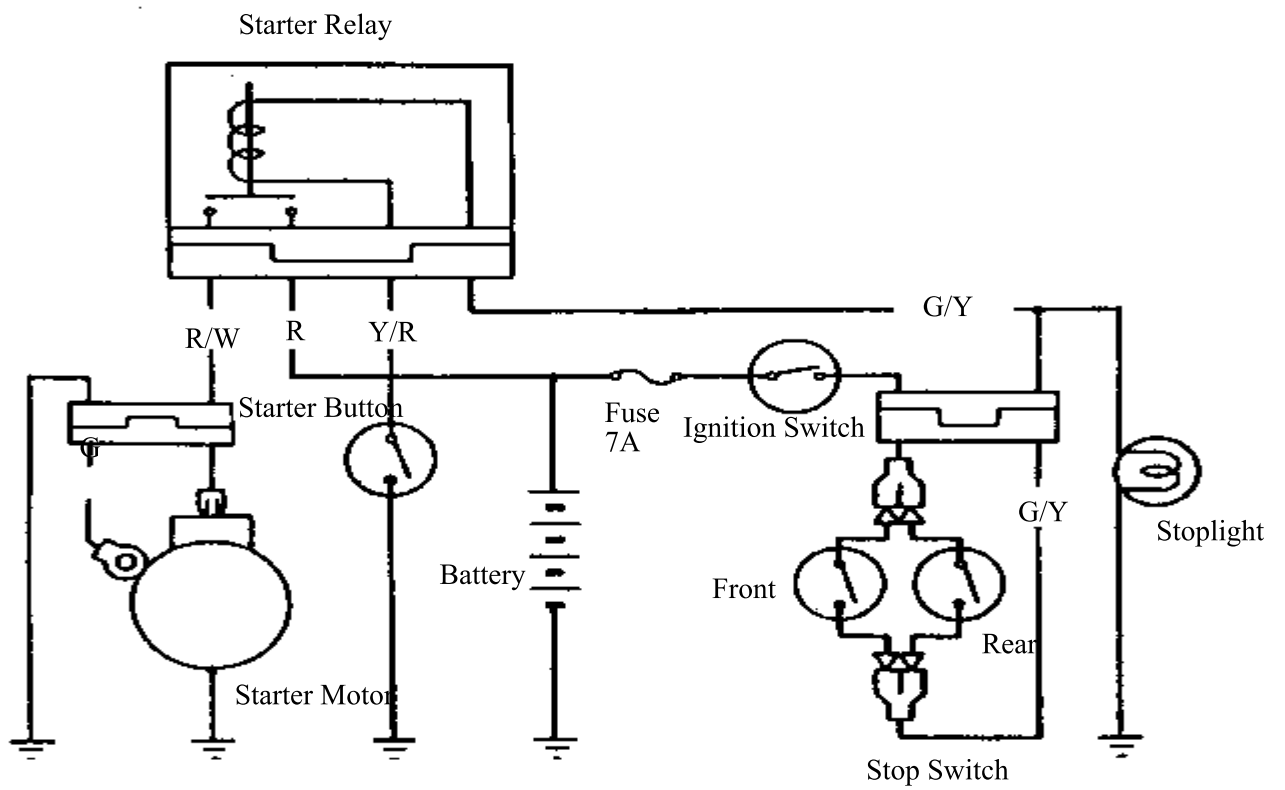
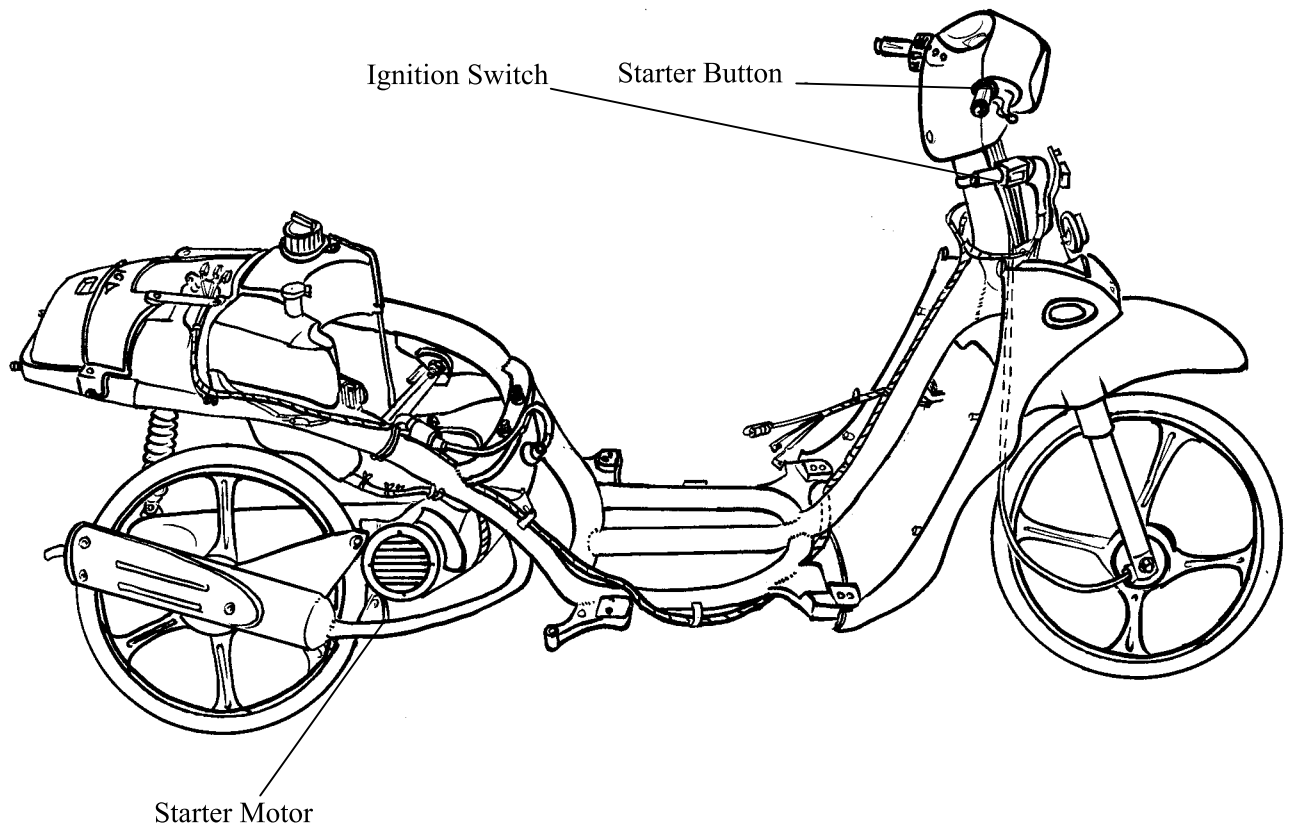

15. ELECTRICAL EQUIPMENT

STARTER RELAY INSPECTION

Remove the front cover.
Disconnect the starter relay coupler and then remove the starter relay.

Starter Relay

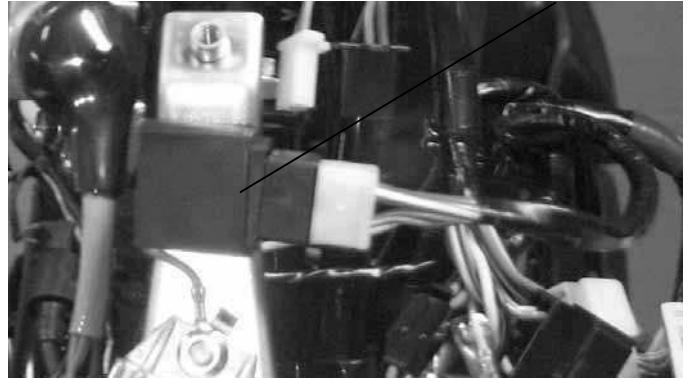

Connect the starter relay green/yellow terminal to the 12V battery positive (+) terminal and the relay yellow/red terminal to the battery negative (-) terminal. Check for continuity between the starter relay red and red/white terminals. The relay is normal if there is continuity.

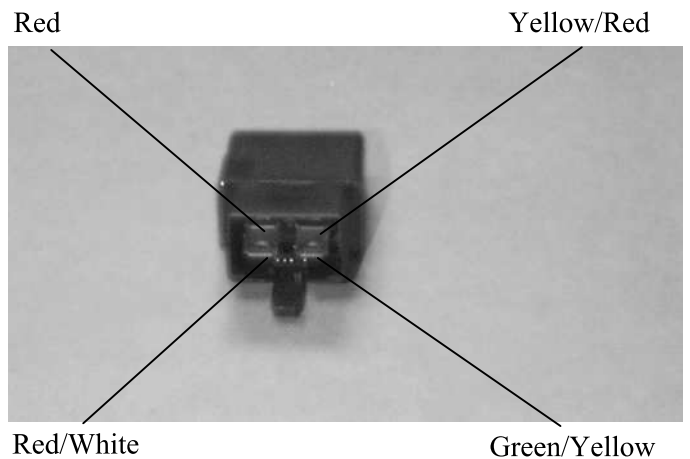

STARTER MOTOR REMOVAL

Disconnect the starter motor cable.
Remove the two bolts attaching the starter motor and remove the starter motor.
The installation sequence is the reverse of removal.

Bolts



Starter Motor

15. ELECTRICAL EQUIPMENT

STARTER MOTOR INSPECTION

Connect a battery across the starter motor and check for its operation.

*

1. Do not turn the starter motor for a long time.
2. This inspection should be done with a fully charged battery.

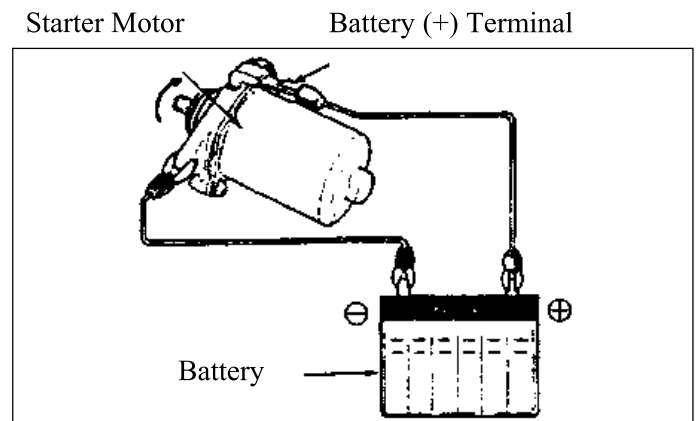

16. INSTRUMENT/SWITCHES/LIGHTS

16

INSTRUMENT/SWITCHES/LIGHTS

SERVICE INFORMATION	16-1
TROUBLESHOOTING	16-1
FUEL UNIT.....	16-2
OIL METER.....	16-3
SWITCHES	16-5
STOP SWITCH INSPECTION/HORN	16-6
BULB REPLACEMENT	16-7
INSTRUMENT/HEADLIGHT	16-8

16. INSTRUMENT/SWITCHES/LIGHTS

SERVICE INFORMATION

GENERAL INSTRUCTIONS

- Wires should be connected to other wires of the same color. Couplers must be connected to other couplers of the same color.
- All plastic plugs have locking tabs that must be released before disconnecting, and must be aligned when reconnecting.
- After installation of each switch, a continuity check must be performed.

TROUBLESHOOTING

Lights do not come on when ignition switch is "ON"

- Burned bulb
- Faulty switch
- Broken or shorted wire
- Fuse burned out
- Weak battery
- Poorly connected wire
- Faulty winker

Light dims

- Faulty ignition coil
- Wire or switch resistance too high
- Faulty regulator/rectifier

Headlight does not change when dimmer switch is turn to Hi or Lo

- Faulty or burned bulb
- Faulty dimmer switch

Motor oil indicator light does not come on (when motor oil is insufficient)

- Fuse burned out
- Dead battery
- Faulty ignition switch
- Faulty instrument
- Faulty oil meter

Motor oil indicator light winks

- Loose wire connection
- Broken wire
- Faulty oil meter

Fuel gauge pointer does not register correctly

- Disconnected wire or connector
- Broken wire
- Faulty float
- Faulty fuel unit
- Faulty instrument

Fuel gauge pointer fluctuates or swings

- Loose wire connection
- Faulty fuel unit
- Faulty instrument

16. INSTRUMENT/SWITCHES/LIGHTS

FUEL UNIT

* No Smoking!

REMOVAL

Remove the frame body cover. (⇒12-5)
 Disconnect the fuel unit wire connectors.
 Remove the three bolts attaching from the fuel unit retainer .

* Do not damage the fuel unit wire.

Remove the fuel unit.

* Be careful not to bend or damage the fuel unit float arm.

Fuel Unit



Fuel Unit Wire

INSPECTION

Remove the fuel unit.
 Measure the resistance between the fuel unit wire terminals with the float at upper and lower positions.

Wire Terminals	Upper	Lower
G~Y/W	36Ω	700Ω
G~L/W	550Ω	160Ω
Y/W~L/W	600Ω	600Ω

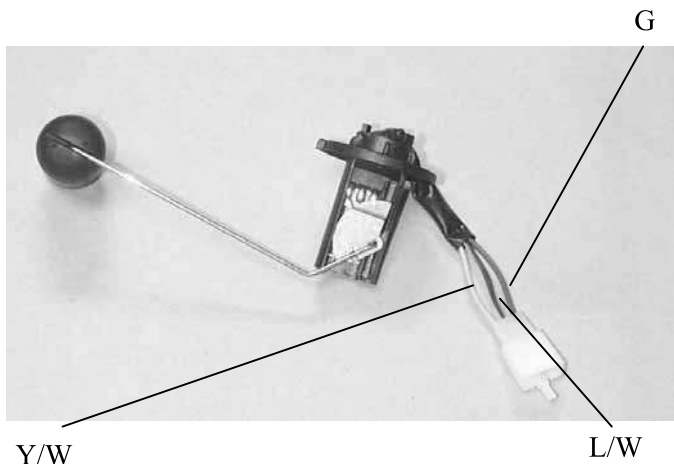

FUEL GAUGE INSPECTION

Connect the fuel unit wire connectors and turn the ignition switch "ON".

* Before performing the following test, operate the turn signals to determine that the battery circuit is normal.

Check the fuel gauge needle for correct indication by moving the fuel unit float up and down.

Float Position	Needle Position
Upper	"F" (Full)
Lower	"E" (Empty)



16. INSTRUMENT/SWITCHES/LIGHTS

INSTALLATION

The installation sequence is the reverse of removal.

- * Align the groove on the fuel unit with the flange on the fuel tank.



OIL METER

INSPECTION

Remove the met-in box. (⇒12-4)
 Remove the frame body cover. (⇒12-4)
 Disconnect the oil meter wire connectors and remove the oil meter. Keep the oil meter float at the lower position.
 Measure the resistances between the wire terminals as ① and ② shown in the left figure.

Wire Terminals	Resistance
Green/Red(+) ~ Black(-)	46Ω
Green(-) ~ Black(+)	∞

- * Before removing the oil meter, be sure to drain the motor oil and do not allow sparks or flames near the working area.

Oil Meter Operation Inspection

Connect the oil meter wire connectors and turn the ignition switch ON.
 Measure the resistance between the wire terminals with the float at upper position.

Green/Red(+) ~ Black(-)	About 300Ω
----------------------------	------------

- * Before performing the following test, operate the turn signals to determine that the battery circuit is normal.

Oil Meter

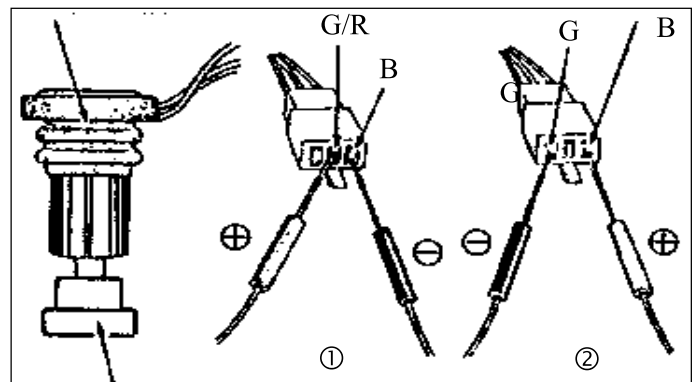

Float

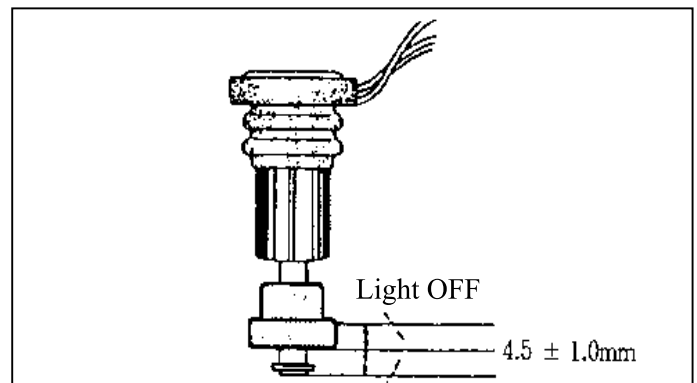

Light ON

16. INSTRUMENT/SWITCHES/LIGHTS

Move the oil meter float up and down to see if the oil indicator light will go out and come on.

* If the oil indicator light does not light, check for burned bulb, loose wire or connector. After correction, check again according to the method mentioned above.



Oil Indicator Light

SWITCHES

IGNITION SWITCH INSPECTION

Remove the front cover. (⇒12-3)
 Disconnect the ignition switch wire couplers and check for continuity between the wire terminals.

Color	Red	Black/White	Green	Black
Symbol	BAT ₁	IG	E	BAT ₂
LOCK		○ — ○	○	
OFF		○ — ○	○	
ON	○			○

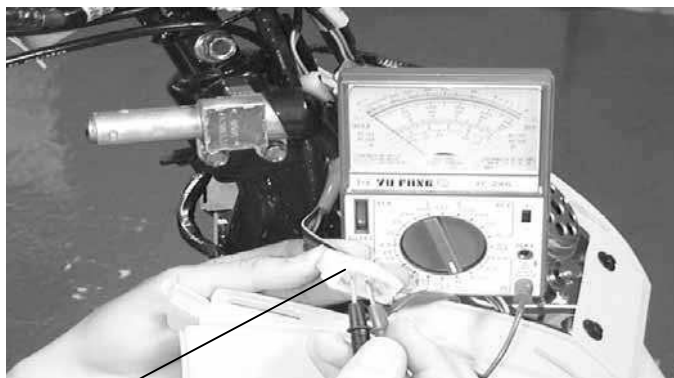

Ignition Switch Coupler

IGNITION SWITCH REPLACEMENT

Remove the front cover. (⇒12-3)
 Disconnect the ignition switch wire couplers.
 Remove the two mounting bolts and remove the ignition switch.
 The installation sequence is the reverse of removal.



Bolts

16. INSTRUMENT/SWITCHES/LIGHTS

HEADLIGHT SWITCH INSPECTION

Remove the handlebar front cover. (⇒12-3)
Disconnect the headlight switch wire coupler and check for continuity between wire terminals.

Color	Blue/White	Yellow	Brown	Pink
Symbol	HL	CI	TL	RE
OFF		○		○
P		○	○	
H	○	○	○	

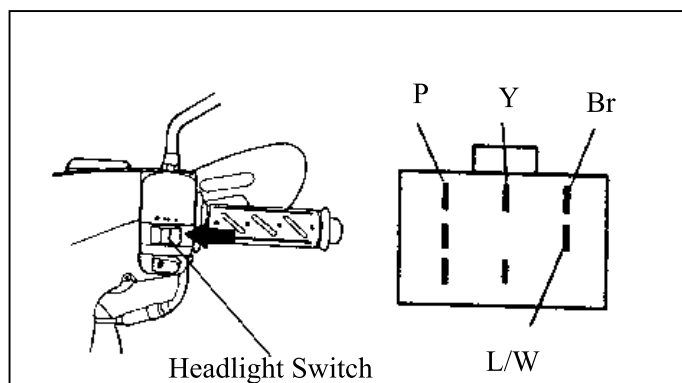

DIMMER SWITCH INSPECTION

Check for continuity between wire terminals.

Color	Blue/White	Blue	White	Black
Symbol	HL	HI	LO	BAT
HI	○	○		
LO	○		○	
PASSING		○		○

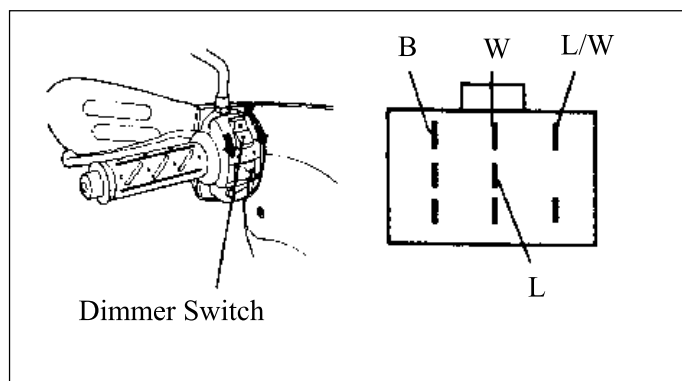

淺

TURN SIGNAL SWITCH INSPECTION

Check for continuity between the wire terminals.

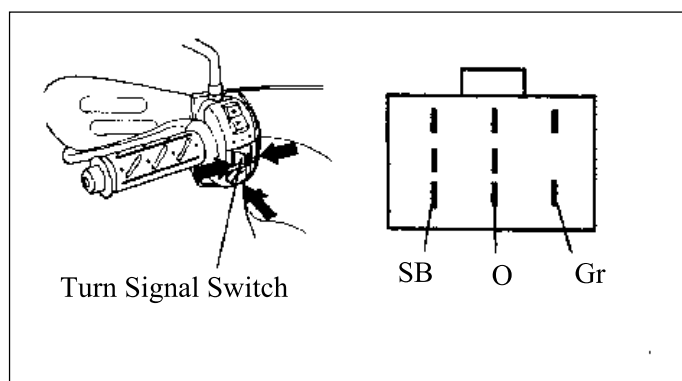

Color	Light Blue	Orange	Gray
Symbol	R	L	WR
R	○		○
L		○	○



16. INSTRUMENT/SWITCHES/LIGHTS

STARTER SWITCH INSPECTION

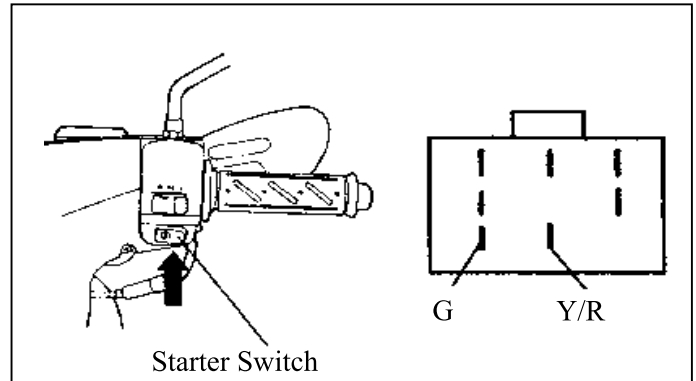

Check for continuity between wire terminals.
Push the starter button when measuring.

Color	Yellow/Red	Green
Symbol	ST	E
FREE		
PUSH		



HORN SWITCH INSPECTION

Check for continuity between wire terminals.
Push the horn button when measuring.

Color	Light Green	Brown / Blue
Symbol	HO	BAT
FREE		
PUSH		

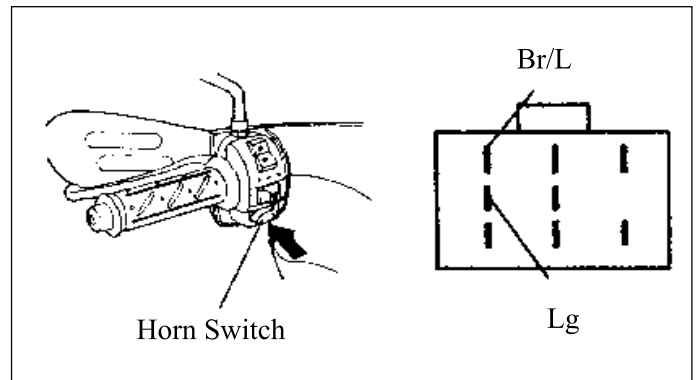

STOP SWITCH INSPECTION

Remove the handlebar front cover. (⇒12-3)
Disconnect the front and rear stop switch wire couplers.
Check for continuity between the wire terminals when the front/rear brake lever is applied.



16. INSTRUMENT/SWITCHES/LIGHTS

HORN INSPECTION

Remove the frame front cover. (⇒12-3)
Disconnect the horn wire couplers. The horn is normal if it sounds when a 12V battery is connected across the horn wire terminals.

Horn Terminal



Battery

FRONT TURN SIGNAL LIGHT REPLACEMENT

Remove the met-in box. (⇒12-5)
Remove the floor board. (⇒12-4)
Remove the front tool box. (⇒12-4)
Remove two screws attaching the turn signal light shell and the bulb.
Replace with new ones.

* Replace with new bulbs of the same specifications.

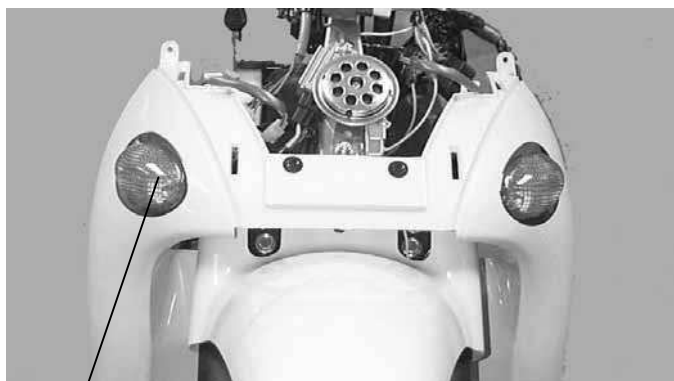

Turn Signal Light Bulb

TAILLIGHT/STOPLIGHT/REAR TURN SIGNAL LIGHT BULB REPLACEMENT

Taillight Shell Removal:
Remove two screws attaching the taillight shell.
Remove the taillight shell and stop light bulb.
Remove screws attaching the rear turn signal light.
Remove the rear turn signal light bulbs.
The installation sequence is the reverse of removal.

Taillight Shell

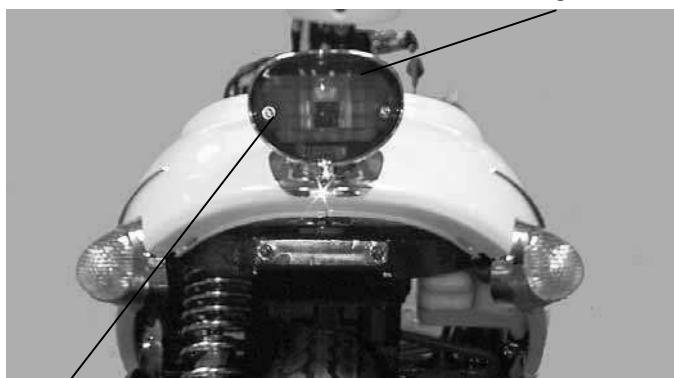

Screws

16. INSTRUMENT/SWITCHES/LIGHTS

INSTRUMENT

Instrument Bulbs Replacement

Remove the handlebar rear cover. (⇒12-3)
Remove the bulbs and replace with new ones.

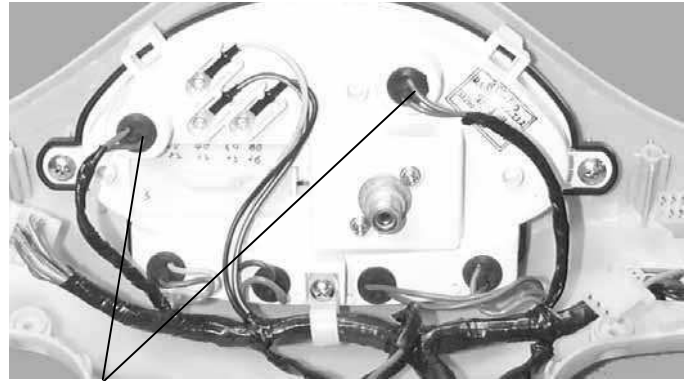

Bulb Sockets

SPEEDOMETER REMOVAL

Disconnect the speedometer cable.
Disconnect the speedometer wire connector.
Remove the three screws attaching the speedometer.
Remove the speedometer.
The installation sequence is the reverse of removal.

Screws

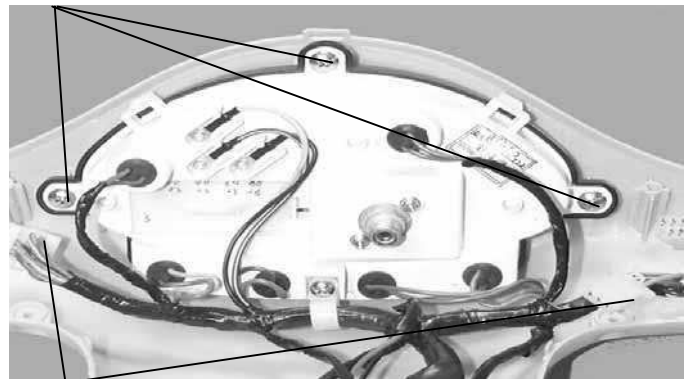

Wire Couplers

HEADLIGHT

REMOVAL/BULB REPLACEMENT

Remove the handlebar front cover. (⇒12-3)
Remove the bulb sockets and bulbs.

*

- The model adopts krypton gas bulb. When installing, do not directly touch the bulb glass with fingers.
- Use bulbs of the same specifications for replacement.

The installation sequence is the reverse of removal.

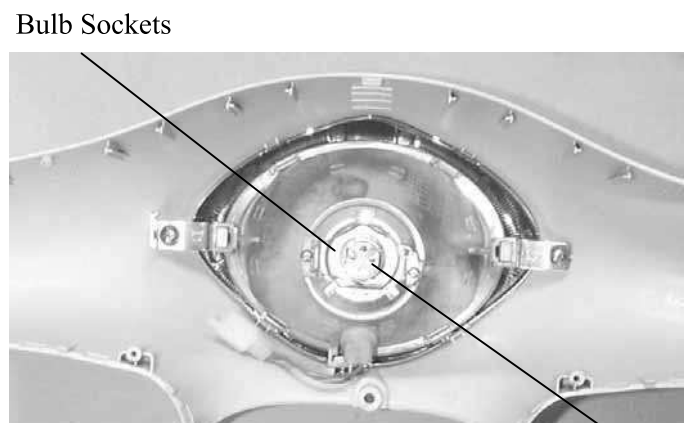

Coupler