FUEL INJECTION SYSTEM

SERVICE INFORMATION-----	13- 1
SPECIFICATIONS -----	13- 2
INJECTION SYSTEM DIAGRAM-----	13- 3
PARTS LOCATION -----	13- 4
TROUBLESHOOTING-----	13- 6
SELF-DIAGNOSTIC PROCEDURES WITHOUT DIAGNOSTIC TOOL-----	13- 7
EFI SELF-DIAGNOSIS CHECK ENGINE LAMP (CELP) FAILURE CODES-----	13- 8
SELF-DIAGNOSIS RESET PROCEDURE -----	13- 9
CELP FAILURE CODES LIST-----	13-10
TPS/ISC RESET -----	13-13
FUEL PUMP -----	13-14
FUEL CUT-OFF RELAY -----	13-16
TILT SWITCH-----	13-17
ELECTRONIC CONTROL UNIT (ECU)-----	13-18
FUEL INJECTOR -----	13-20
WTS SENSOR -----	13-22
O ² SENSOR -----	13-23
THROTTLE BODY/MAP/ISC/TPS -----	13-24
DIAGNOSTIC TOOL CONNECTOR-----	13-27
DIAGNOSTIC TOOL OPERATION INSTRUCTIONS-----	13-28
VEHICLE CAN NOT BE STARTED -----	13-40
MANUAL TROUBLE SHOOTING PROCEDURE-----	13-41

SERVICE INFORMATION

GENERAL INSTRUCTIONS

- Scooter services can be done with the engine installed in the frame.
- Be sure to relieve the fuel pressure before fuel pump or fuel hose removal.
- Bending or twisting the control cables will affect operation and could cause the cables to stick or bind, resulting in loss of vehicle control.
- Work in a fully ventilated area. Smoking or allowing flames or sparks in the work area or where gasoline is stored can cause a fire or explosion.
- Do not snap the throttle valve from fully open to fully close after the throttle cable has been removed; it may cause incorrect idle speed.
- Do not loosen or tighten the painted bolts and screws of the throttle body. Loosening or tighten them can cause throttle and idle valve synchronization failure.
- Seal the cylinder head intake ports with tape or a clean towel to prevent dirt and debris from entering the intake ports after the throttle body has been removed.
- Do not damage the throttle body. It may cause incorrect throttle and idle valve synchronization.
- Do not take the fuel pump on the ground downward.
- Always replace the packing when the fuel pump is removed.
- The electronic fuel injection system is equipped with the self-diagnostic system. If the Check Engine Lamp “CELP” illuminate while riding, follow the self-diagnostic procedures to solve the problem.
- A faulty AFI problem is often related to poorly connected or corroded connectors. Check those connections before proceeding.
- When disassembling the fuel injection parts, note the location of the O-rings. Replace them with new ones upon reassembly.
- Do not disconnect the battery negative (-) or positive (+) cable while engine is running, it may cause ECU damage.
- **Do not disconnect or connect the ECU connector during the ignition switch “ON”; it may cause the ECU damage.**

13. FUEL INJECTION SYSTEM



People GT 300i

SPECIFICATIONS

ITEM		SPECIFICATIONS
Throttle body identification number		LGE5
Idle speed		1600±100 rpm
Throttle grip free play		2~6 mm (1/16~1/4 in)
Fuel injector resistance (at 20°C/68°F)		11.7±0.6 Ω
Fuel pump resistance (at 20°C/68°F)	Float at full position	100±3 Ω
	Float at empty position	1100±33 Ω
Fuel pump standard pressure (at 40 L/Hr)		294±6 kPa (3 Bar)
Water temperature sensor resistance	At -20°C/-4°F	18.8 KΩ
	At 40°C/104°F	1.136 KΩ
	At 100°C/212°F	0.1553 KΩ
Intake pressure sensor (MAP) pressure (at 1~4.2 V)		13.332 kPa (0.13332 kgf/cm ² , 1.89 psi)~ 119.99 kPa (1.1999 kgf/cm ² , 17.04 psi)
Inductive ignition coil		Primary: 3.57~4.83 Ω Secondary: 10.42~14.49K Ω
Throttle position sensor (TPS) resistance (at 20°C/68°F)		3500~6500 Ω
Crank position sensor voltage (at 200 rpm)		100~130 Ω
O ² heater sensor resistance (at 20°C/68°F)		6.7~9.5 Ω (engine warming condition)
Tilt switch voltage	Standard	0.4~1.4 V
	Over 65° (fall down)	3.7~4.4 V

INJECTION SYSTEM DIAGRAM

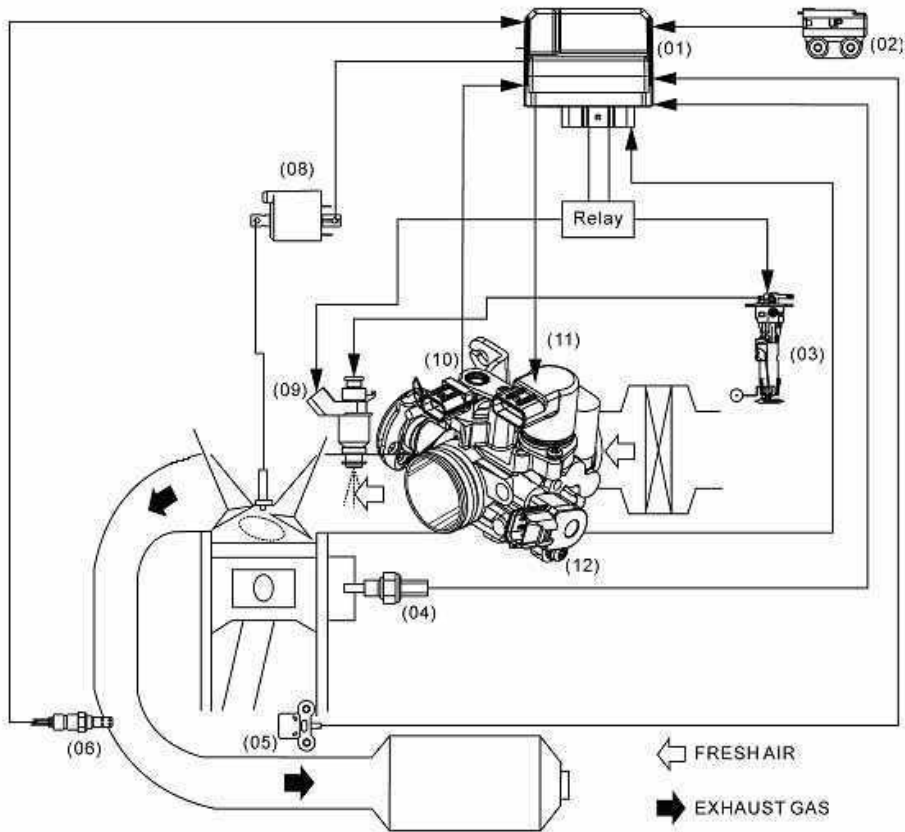

No.	FULL NAME	ABBREVIATIONS
(01)	Electronic control unit	ECU
(02)	Tilt switch (Angle detect sensor)	ROLL
(03)	Fuel pump/Fuel level unit	FP
(04)	Water temperature sensor	WTS sensor
(05)	Crank position sensor (Pulser)	CPS
(06)	Oxygen/Oxygen heater sensor	O ² /O ² Heat sensor
(08)	Inductive ignition coil	IG
(09)	Fuel injector (Nozzle)	INJ
(10)	Intake pressure sensor	MAP sensor
(11)	Idle air bypass valve	ISC
(12)	Throttle position sensor	TPS

PARTS LOCATION

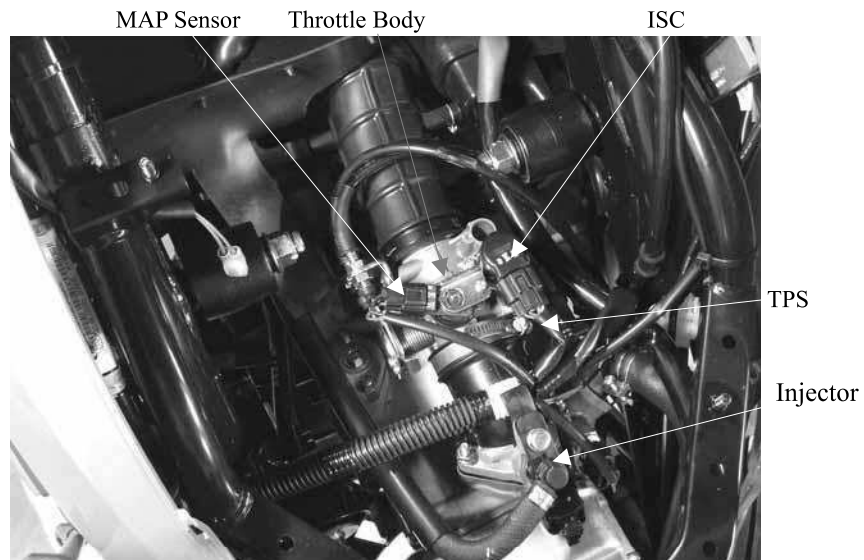
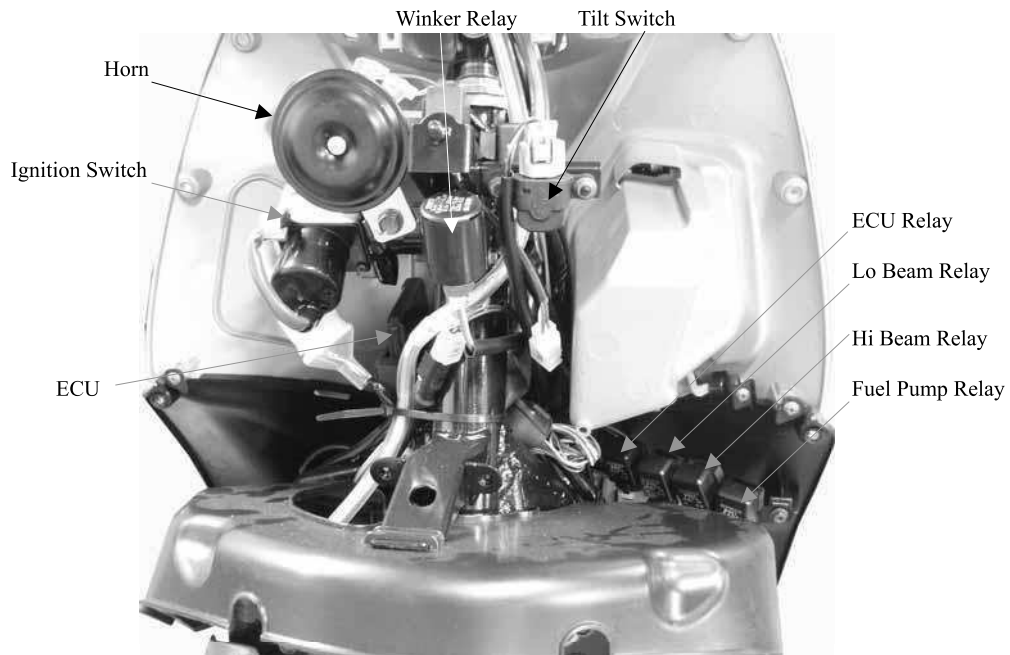

TROUBLESHOOTING

Engine fail to start

- Intake manifold air leak
- Fuel contaminated/deteriorated
- Pinched or clogged fuel hose
- Faulty fuel pump
- Clogged fuel filter, throttle body
- Sticking fuel injector needle
- Faulty fuel pump operating system
- Carbon deposit stayed on the fuel injector
- Spark plug dirty
- Fuel pressure incorrect

Engine stall, hard to start, rough idling

- Intake air leak
- Fuel contaminated/deteriorated
- Pinched or clogged fuel hose
- Idle speed fail to adjust
- Fail to perform PTS/ISC reset

Backfiring or misfiring during acceleration

- Ignition system malfunction

Poor performance (drive ability) and poor fuel economy

- Pinched or clogged fuel hose
- Faulty injector

SELF-DIAGNOSTIC PROCEDURES WITHOUT DIAGNOSTIC TOOL

SELF-DIAGNOSTIC PROCEDURES

* It can be performed without diagnostics program.

Place the scooter on its main stand.

Put the side stand up and the engine stop switch is at "RUN".

- Turn key to On position.
- The CELP will be lighting for two seconds and then off.
- If the engine has problem, the CELP will blink to show the failure codes.
- There're 11 failure codes for the KEHIN system.

If the vehicle gets more failure codes, the CELP will be blinking from a lower number, then show the higher number after three seconds. All failure codes would be appeared repeatedly.

* No matter when the "CELP" illuminated while riding condition, should find out the cause of the problem as soon as

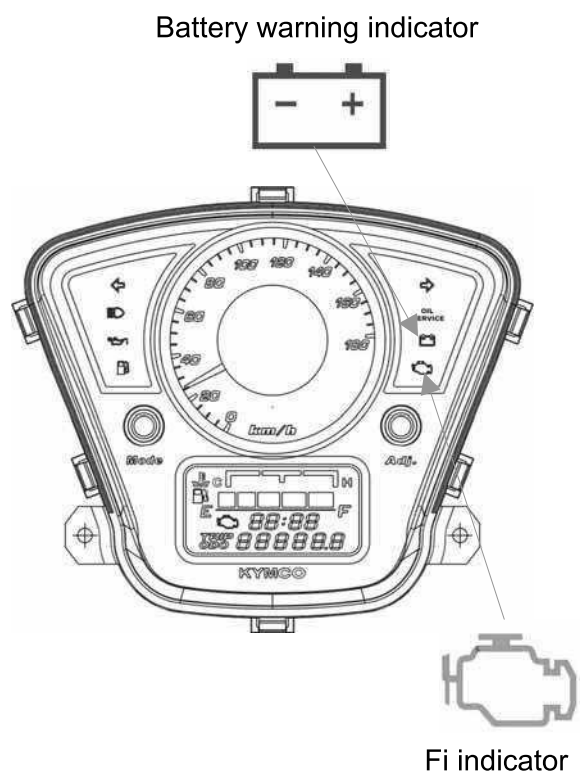
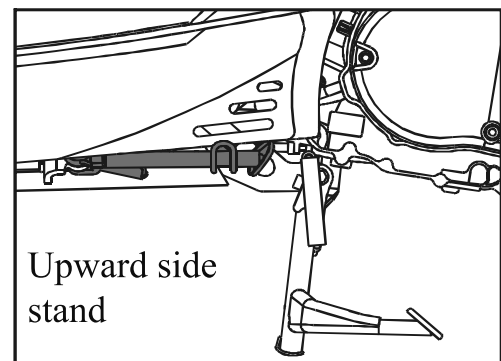

EFI SELF-DIAGNOSIS CHECK ENGINE LAMP (CELP) FAILURE CODES

The "CELP" denotes the failure codes. When the indicator lights for one second that is equal to ten.

For example: one longer blink illumination and two shorter blinks (0.5 second x 2) of the indicator is equal to 12 blinks. Follow code 12.

If more than a damaged part has occurred, the "CELP" begins blinking in order.

For example: If the indicator blinks six times, then shows one second illumination and two blinks, so there are two failures have occurred. Follow code 6 and 12.

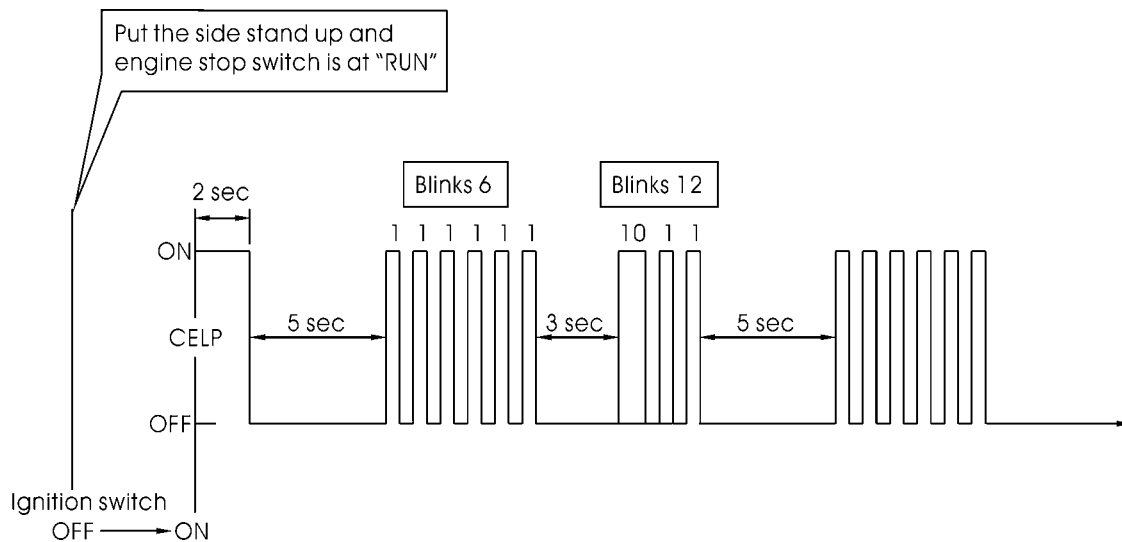

13. FUEL INJECTION SYSTEM

SELF-DIAGNOSIS RESET PROCEDURE

1. Put the side stand up and engine stop switch is at "RUN".
2. Turn the key to the ON position and wait for ten seconds.
3. Fully open the throttle and wait for ten seconds.
4. Release the throttle.
5. The indicator will blink twice (0.5 second) after five seconds quickly.
6. Self-diagnosis memory data is disappeared after the CELP lamp is off.

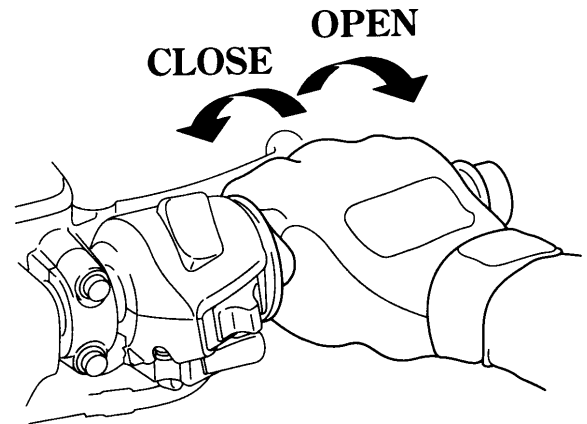

* The self-diagnosis can not be reset when has still problem inside the system.

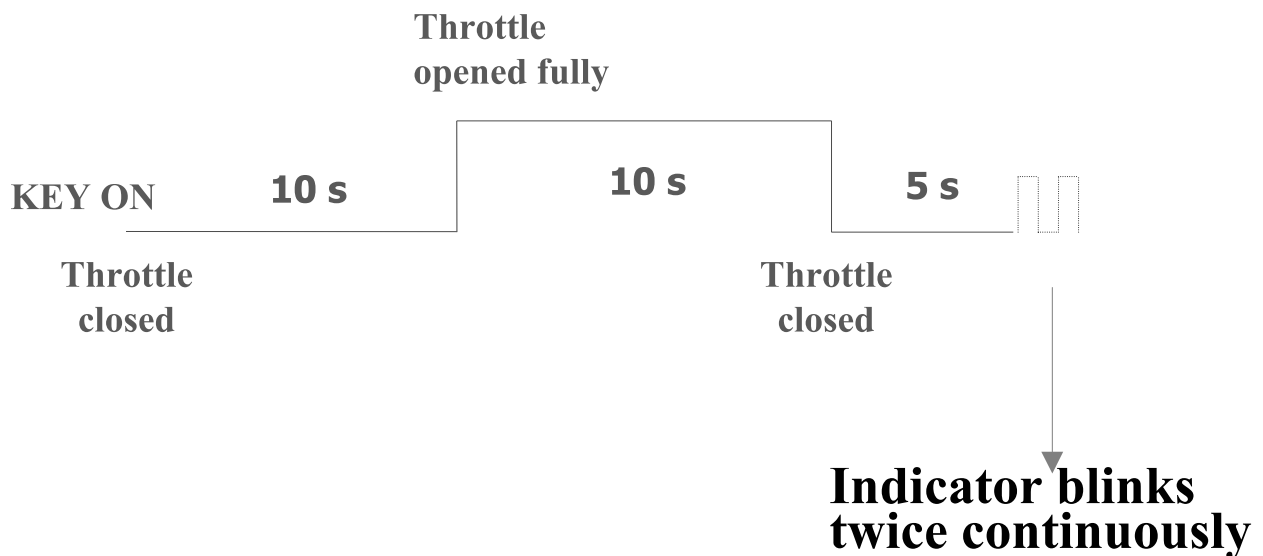

CELP FAILURE CODES LIST

Blinks	Failure Codes	Contents	Causes	Symptoms
06	P0120	Faulty TPS	<ul style="list-style-type: none"> ● Faulty TPS voltage range (0.3~4.5 V) ● Loose or poor connection on TPS Sensor ● Open or short circuit on the TPS wire ● Faulty TPS itself. 	Engine operates normally
09	P0105	Faulty MAP	<ul style="list-style-type: none"> ● Faulty MAP voltage range (1~4.2 V) ● Loose or poor connection on MAP Sensor ● Open or short circuit on MAP wire ● Faulty MAP itself 	Engine operates normally
12	P0115	Faulty WTS (water temperature)	<ul style="list-style-type: none"> ● Faulty ECT Ω range (-20°C:18.8 Ω/40°C: 1.136 Ω/100°C: 0.1553 Ω) ● Loose or poor connection on ECT ● Open or short circuit on ECT wire ● Faulty ECT 	Engine operates normally
15	P1630	Faulty Tilt switch (Roll)	<ul style="list-style-type: none"> ● Faulty Tilt switch voltage range (inclined angle <65°: 0.4~1.4 V/ Inclined angle >65°: 3.7~4.4 V) ● Loose or poor connection on Tilt switch ● Open or short circuit in Tilt switch wire ● Faulty tilt switch 	Engine operates normally
17	P0130	Faulty O ² Sensor	<ul style="list-style-type: none"> ● Faulty O² sensor voltage range (A/F below 14.7: > 0.7V/ A/F over 14.7: < 0.18 V) ● Loose or poor connection on O² sensor ● Open or short circuit on O² sensor wire ● Faulty O² sensor 	Engine operates normally
33	P0201	Faulty Injector (Nozzle)	<ul style="list-style-type: none"> ● Faulty Fuel injector Ω range (9.945~13.5 Ω) ● Loose or poor connection on injector ● Open or short circuit on injector wire ● Faulty fuel injector 	Engine fail to be operated

13. FUEL INJECTION SYSTEM



People GT 300i

Blinks	Failure Codes	Contents	Causes	Symptoms
37	P0351	Faulty inductive ignition coil	<ul style="list-style-type: none"> ● Faulty Inductive ignition coil Ω range ($4.2 \Omega \pm 15\%$) ● Loose or poor connection on inductive ignition coil ● Open or short circuit on inductive ignition coil wire ● Faulty inductive ignition coil 	Engine fail to be operated
41	P0230	Faulty Fuel Pump	<ul style="list-style-type: none"> ● Faulty Fuel pump Ω range (F: $1100 \pm 33 \Omega$ E: $100 \pm 3 \Omega$) ● Loose or poor connection on fuel pump ● Open or short circuit on fuel pump wire ● Faulty fuel pump 	Engine fail to be operated
45	P0135	Faulty O ² Sensor Heater	<ul style="list-style-type: none"> ● Faulty O² sensor heater Ω range ($6.7 \Omega \sim 9.5 \Omega$) ● Loose or poor connection on O² sensor heater ● Open or short circuit on O² sensor heater wire ● Faulty O² sensor heater 	Engine starts normally but not smooth
49	P1505	Faulty ISC	<ul style="list-style-type: none"> ● Loose or poor contacts on ISC ● Open or short circuit in ISC wire ● Faulty ISC 	Engine operates normally
66	P0335	Faulty CPS	<ul style="list-style-type: none"> ● Loose or poor connection on CPS sensor ● Open or short circuit on CPS wire ● Faulty CPS sensor 	Engine starts normally but not smooth

SPARK PLUG ANTI-FLOOD

When have not failure code occurs and pressing starter switch repeatedly, can still not start the engine, maybe the spark plug is wet by fuel, perform the spark plug anti-flood to purge the fuel in the engine.

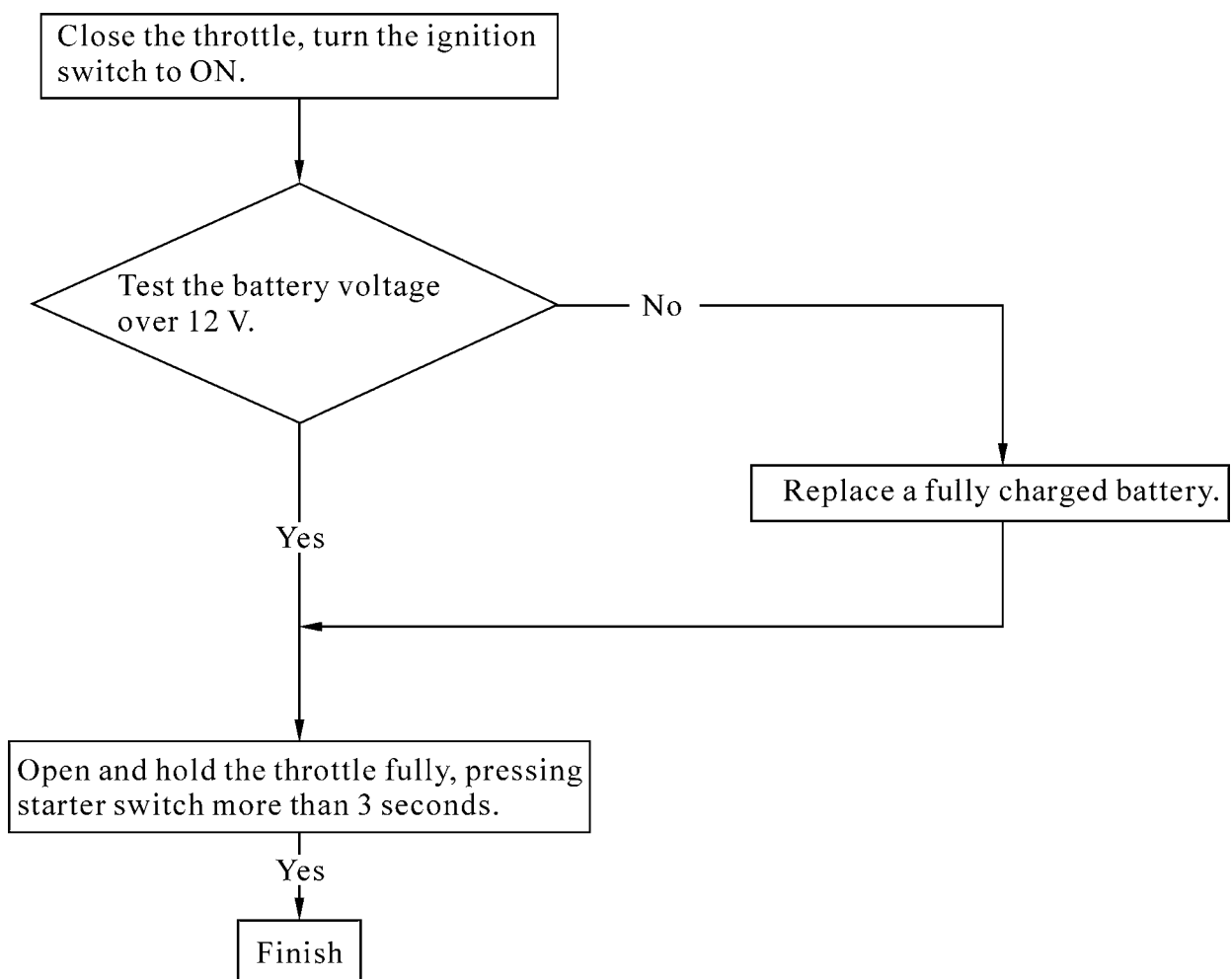

TPS/ISC RESET

- If close or open the throttle grip randomly, the ECU may record the incorrect TPS when the ECU or the throttle body has been reinstalled. It can cause hard to start engine or idling speed is not smooth when engine installation.
- ISC has a motor inside, which controls ISC valve to obtain smooth idling speed. The ECU may record the incorrect ISC position during the engine speed isn't working when the ECU or the throttle body has been reinstalled. It can cause engine stop, hard to start engine or rough idling speed.

The throttle position sensor (TPS) and idle air bypass valve (ISC) have to be reset when throttle body, MAP, TPS, ISC or ECU has been reinstalled.

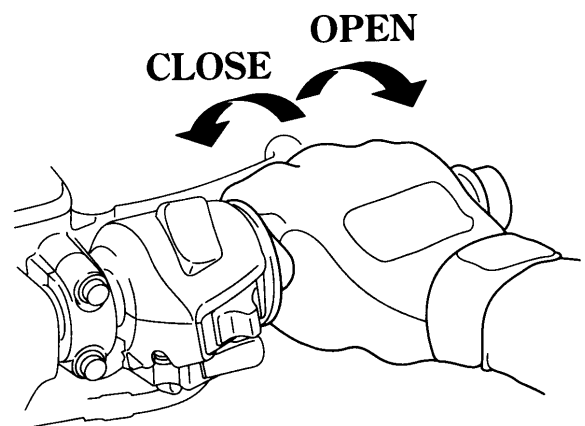

TPS/ISC RESET PROCEDURE

1. Put the side stand up and engine stop switch is at "RUN".
2. Turn the key to the OFF position.
3. Fully open the throttle.
4. Turn the key to the ON position.
5. Release the throttle after waiting for eight seconds.
6. Turn the key to the OFF position.
7. Turn the key to the ON position.
8. TPS and ISC have been reset successfully.

If fail to reset, repeat the steps from 1 to 8.

FUEL PUMP

INSPECTION

Put the side stand up and the engine stop switch is at "RUN"

Disconnect the fuel pump/fuel unit connector.

Connect the multimeter (+) probe to the Red/Black terminal and the multi-meter (-) probe to the Green terminal.

Turn the ignition switch to "ON" and measure the voltage between the terminals.

It should be shown the current battery voltage for a few seconds.

If there is still battery voltage, replace the fuel pump.

If there is not any battery voltage, inspect the following:

- Fuse B (10 A)
- Fuel cut-off relay
- ECU

Measure the resistance between the Red/Black and Green terminals of the fuel pump side connector.

Standard (at 20°C/68°F): 1.9±0.3 Ω

Fuel level sensor inspection

Measure the resistance between the Yellow/White and Green terminals of the fuel pump side connector.

Standard (at 20°C/68°F):

Float at full position	100±3 Ω
Float at empty position	1100±33 Ω

Connector

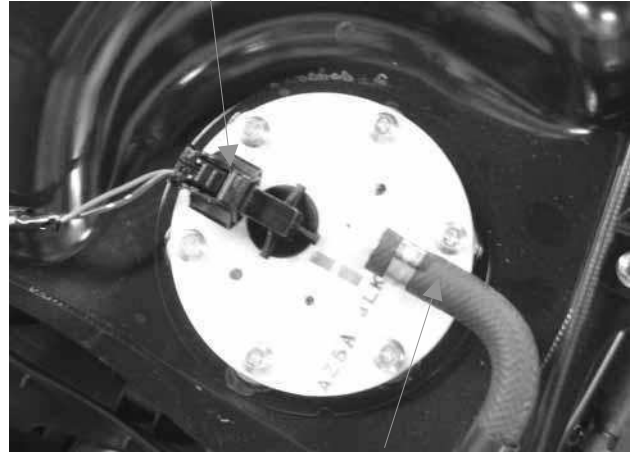

Fuel Hose

REMOVAL

Disconnect the connector and fuel band from the fuel pump.

Remove the six screws onto the fuel pump.

Remove the fuel pump and O-ring.

Fuel Pump Connector

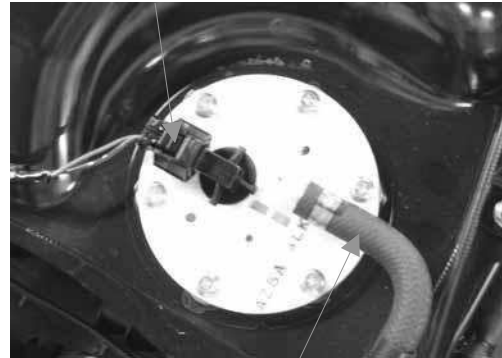

Hose Band

INSTALLATION

Replace a new O-ring on the fuel tank.

Don't damage the fuel pump wire and ensure the connector rearward carefully.

Torque: 0.35 kgf-m (3.5 N-m, 2.5 lbf-ft)



FUEL OUTPUT PRESSURE INSPECTION

Turn the key to the OFF position.

Use the fuel hose clamp.

Disconnect the fuel hose from the fuel injector.

Connect the fuel pressure gauge.

Turn the key to the ON position.

Check the fuel pressure.

Standard:3.0 Bar

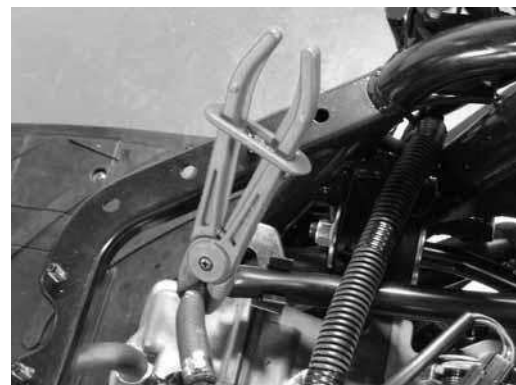

* If the fuel output pressure is less than 3.0 bar, may fail to start the engine or in trouble in case of riding.

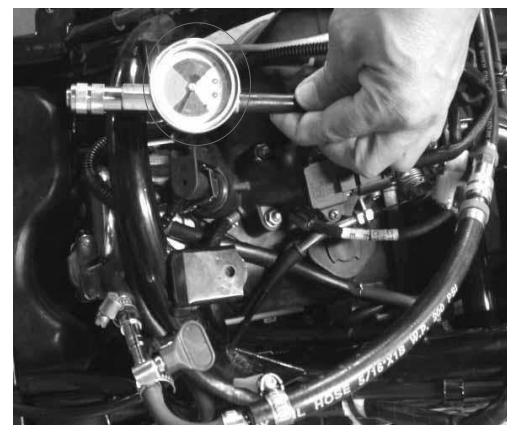

FUEL CUT-OFF RELAY

INSPECTION

Remove the fuel cut-off relay.
Connect the ohmmeter to the fuel cut-off relay connector terminals.

Connection: Black – Red/Black

Connect 12 V battery with the fuel cut-off relay connector.

Connection: Blue/Black – Black

There should be continuity only when 12 V battery connected.
If there is not continuity when the 12 V battery is connected, replace a fuel cut-off relay.

REMOVAL

Disconnect the fuel cut-off relay connector and remove it from frame.

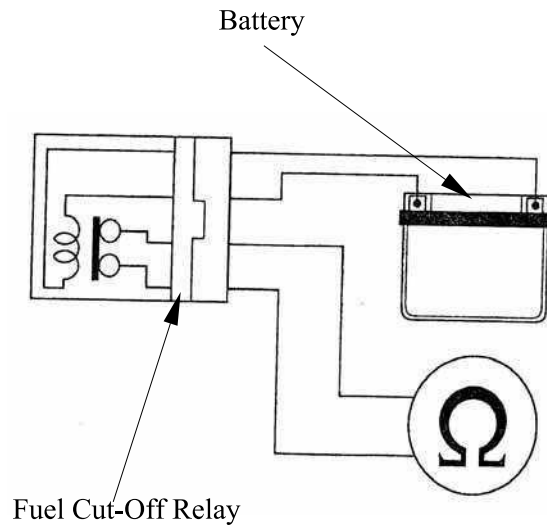

TILT SWITCH

INSPECTION

Support the scooter level surface.

Put the side stand up and engine stop switch is at "RUN".

Turn the ignition switch to "OFF"

Remove the screws, washers and tilt switch.

* Do not disconnect the tilt switch connector during inspection.

Place the tilt switch vertical as shown, and turn the ignition switch to "ON".

Measure the voltage between the following terminals of the tilt switch connector with the connector connected.

Terminal	Normal
Violet/Red (+) – Green/Pink (-)	5 V (ECU voltage)
Black/Blue (+) – Green/Pink (-)	0.4 ~ 1.4 V

Incline the tilt switch 65 ± 10 degrees to the left or right with the ignition switch turned to "ON".

Measure the voltage between the following terminals of the tilt switch connector with the connector connected.

Terminal	Normal
Violet/Red (+) – Green/Pink (-)	5 V (ECU voltage)
Black/Blue (+) – Green/Pink (-)	3.7 ~ 4.4 V

If repeat this test, first turn the ignition switch to "OFF", then turn the ignition switch to "ON".

REMOVAL/INSTALLATION

Disconnect the connector and remove two screws.

Remove the Tilt switch.

Installation is in the reverse order of removal.

* Install the tilt switch with its "UP" mark facing up.

Tighten the mounting screws securely.

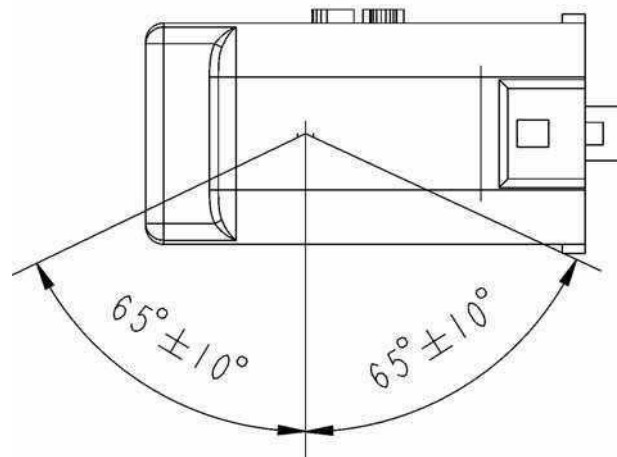
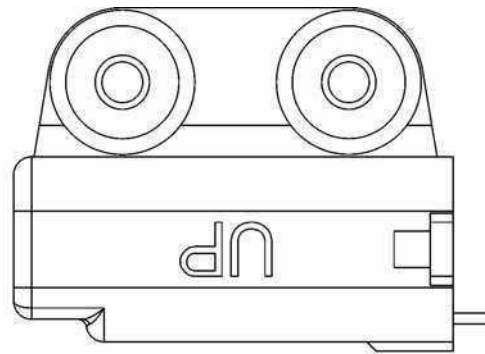

ELECTRIC CONTROL UNIT (ECU)

REMOVAL/INSTALLATION

- * Do not disconnect or connect the ECU connector during the ignition switch "ON"; it may cause the ECU damaged.
- * The throttle position sensor (TPS) and idle air bypass valve (ISC) have to be reset when throttle body, MAP, TPS, ISC or ECU has been reinstalled.

Disconnect the ECU connector and remove the ECU from the frame.

Installation is in the reverse order of the removal.



13. FUEL INJECTION SYSTEM

INSPECTION

Disconnect and remove the ECU from the frame.

Check for continuity between pin 35 and 36 of the ECU side connector.

There should be continuity at all times.

Check for continuity between each pins 8, 9 and 24 of the ECU side connector.

There should be continuity at all times.

Check for continuity between pin 24 and 36 of the ECU side connector.

There should be no continuity at all times.

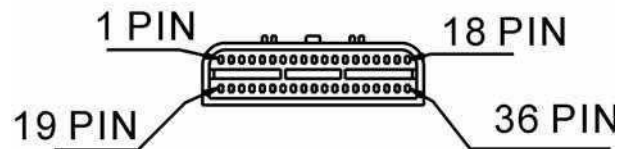
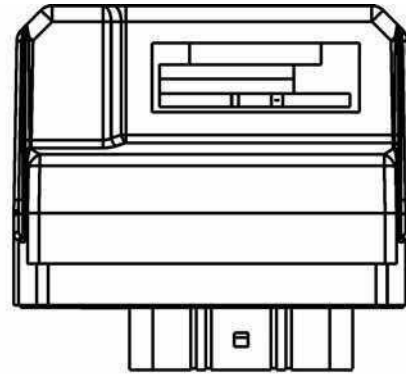

ECU PIN FUNCTION

PIN NO.	NAME	FUNCTION	PIN NO.	NAME	FUNCTION
1	IGP	Ignition power	19	BATT	Battery
2	ROLL	Roll sensor (Tilt switch)	20	—	—
3	CRK-P	Crank pulse sensor	21	MIL	Multi indicator lamp (ECLP)
4	—	—	22	TW	Water temperature sensor (ECT)
5	TH	Throttle position sensor	23	—	—
6	PM	Manifold pressure sensor (Intake pressure sensor)	24	SG	Sensor ground
7	HEGO	HEGO sensor (O ₂ sensor)	25	—	—
8	LG	Logic ground	26	—	—
9	CRK-M	Crank pulse sensor ground	27	—	—
10	K-LINE	Diagnostic tool	28	—	—
11	FLPR	Fuel pump relay	29	—	—
13	VCC	Sensor power output (+5V)	31	ISCAN	Idle speed control (ISC) / A (-)
14	ISCBP	Idle speed control (ISC) B (+)	32	ISCBN	Idle speed control (ISC) / B (-)
15	ISCAP	Idle speed control (ISC) A (+)	33	NE	Meter
16	INJ	Injection	34	—	—
17	HEGO HT	HEGO HT sensor (O ₂ HT sensor)	35	PG1	Power ground
18	IG	Ignition coil	36	PG2	Power ground

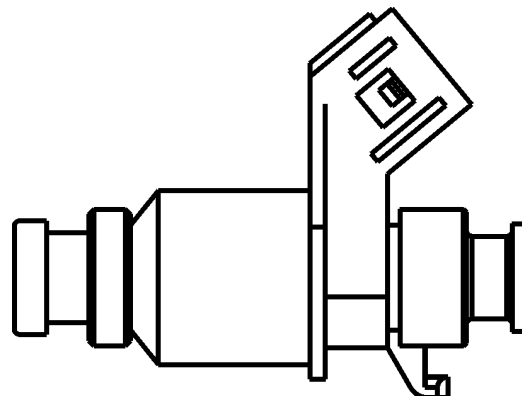

r

Bolt

*
Ensure the fuel pipe without any pressure, then remove the fuel injector.
STEP 1: Disconnect the fuel pump relay or fuel pump connector.
STEP 2: Turn the key to the ON position. Starting the engine till the engine stop working.



O-ring

Fuel Injector

INSTALLATION

Apply the engine oil to a new O-ring.
Install the fuel injector into the fuel pipe.
Ensure the tab of the fuel injector inserted into the groove of the fuel pipe.

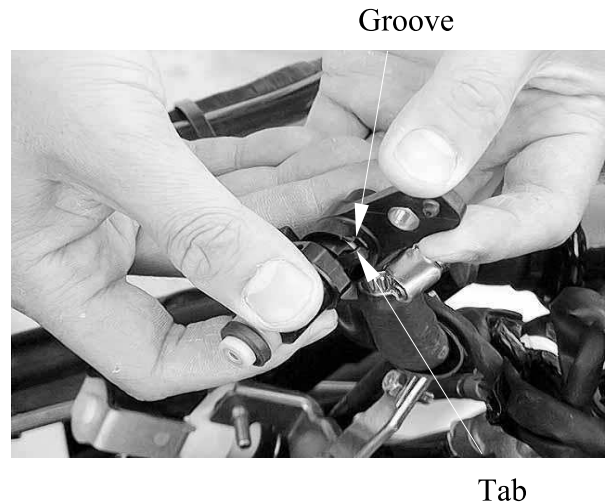

Install the fuel pipe into the intake manifold by aligning the dowel pin.
Be careful not to damage the O-ring.
Tighten the fuel pipe mounting bolt.

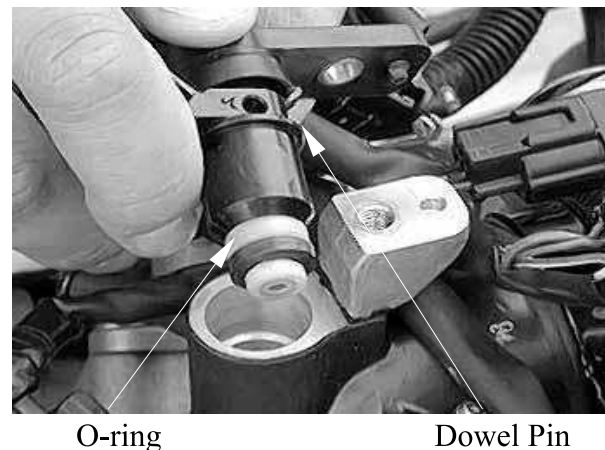

FUEL INJECTOR CLEANING

PROBLEM

1. Fuel Injector cannot output the fuel.
2. The Injector injection time (ms) is shorter or longer.

Standard: < 1.6ms

ANALYSIS

Injector block (With some carbons).

TROUBLESHOOTING

1. Use the specified injector cleaner.
2. Pouring the liquid of carburetor cleaner until half container.
3. Connect the battery as picture.
4. The injector cleaner with the flash relay.
5. Keeping the fuel Injector operation.
6. Waiting for 20~30 minutes.
7. Cleaning the carbons completely.

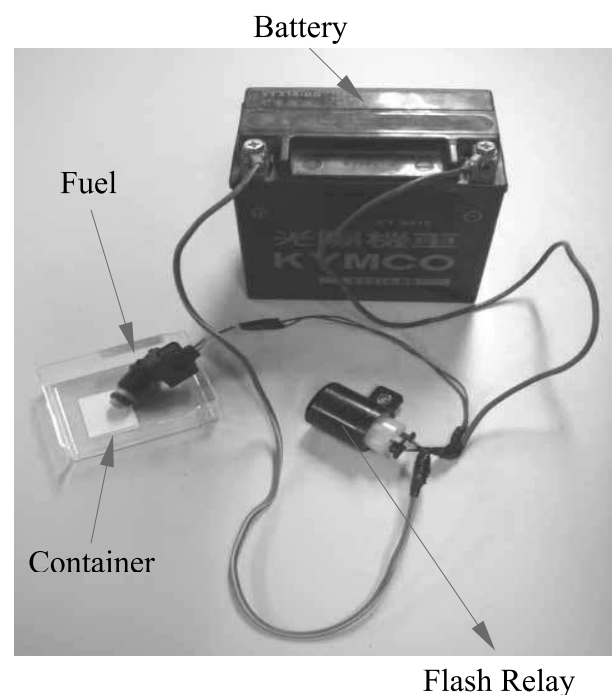

WTS SENSOR (Water Temperature Sensor)

REMOVAL / INSTALLATION

Drain the coolant from the cooling system.
Disconnect the WTS sensor connector from the sensor.
Remove the WTS sensor and O-ring.

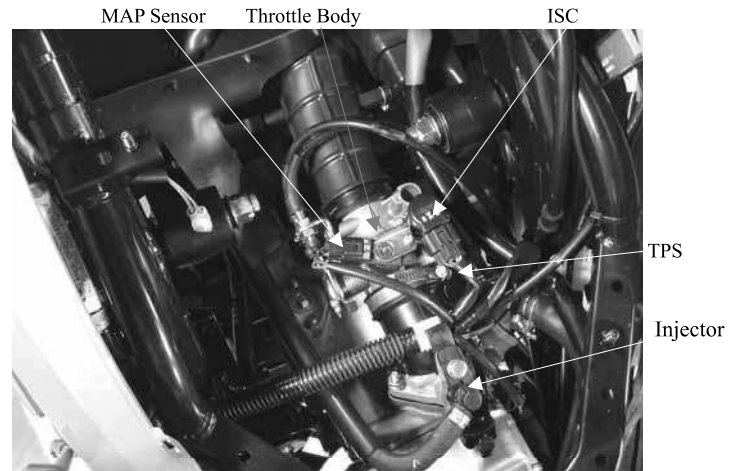

Install a new O-ring and WTS sensor.

* Always replace an O-ring with a new one.

Tighten the WTS sensor to the specified torque.

Torque: 1.2 kgf-m (12 N-m, 8.6 lbf-ft)

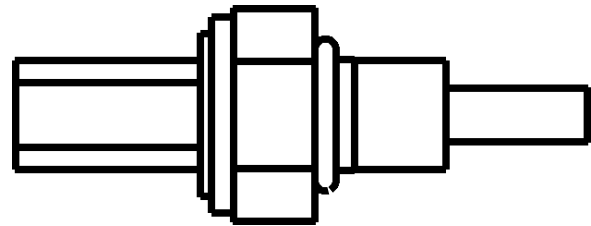

Connect the WTS sensor connector.

Fill the cooling system with the recommended coolant.

INSPECTION

Measure the resistance at the WTS sensor terminals.

STANDARD

°C	-20	40	100
KΩ	18.8	1.136	0.1553

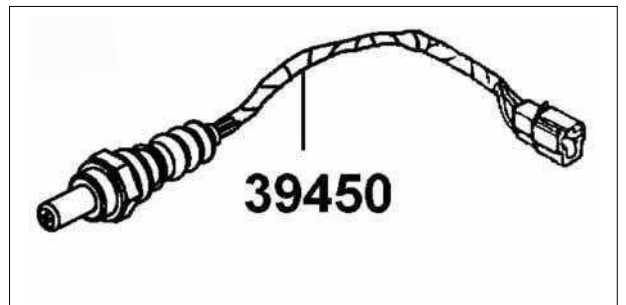
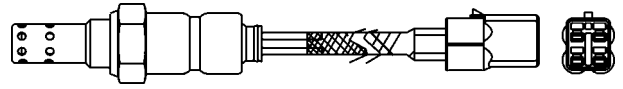

*

THROTTLE BODY/MAP/ISC/TPS

- Turn off the ignition switch while replacement.
- Check and confirm if the voltage is over 12V by a voltmeter after replacement.
- Check and confirm if the other connectors are installed correctly after replacement.
- Do not damage the throttle body, it may cause the throttle and idle valve isn't synchronization.
- The throttle body is preset in KYMCO factory, do not disassemble it by a wrong way.
- Do not loosen or tighten the painted bolts and screws for the throttle body. Loosen or tighten them can cause the throttle and idle valve to synchronization failure.
- **TPS and ISC have to be reset after the throttle body MAP, TPS, ISC or ECU has been reinstalled.**

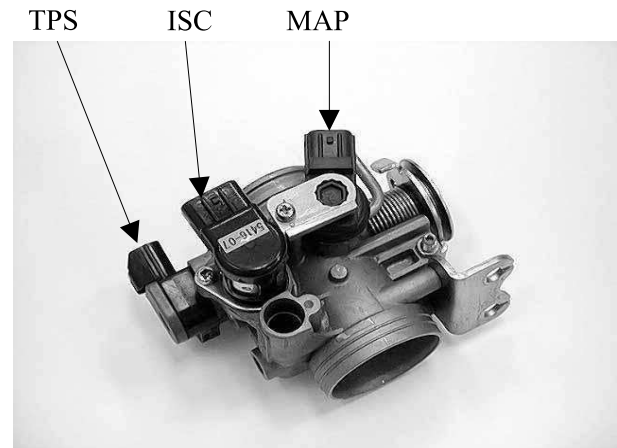

MAP INSPECTION

Support the scooter on a level surface.

Put the side stand up and engine stop switch is at "RUN".

Turn the ignition switch to "ON" position.

Measure if the ECU voltage outputs to the MAP between the following terminals of the MAP connector.

Terminal	Normal
Violet/Red (+) – Green/Pink (-)	5 V

TPS INSPECTION

Support the scooter on a level surface.
 Put the side stand up and engine stop switch is at "RUN".
 Turn the ignition switch to "ON".
 Measure if the ECU voltage outputs to TPS between the following terminals of the TPS connector.

Terminal	Normal
Violet/Red (+) – Green/Pink (-)	5 V

Throttle position sensor (TPS) resistance (at 20°C/68°F) 3500~6500 Ω

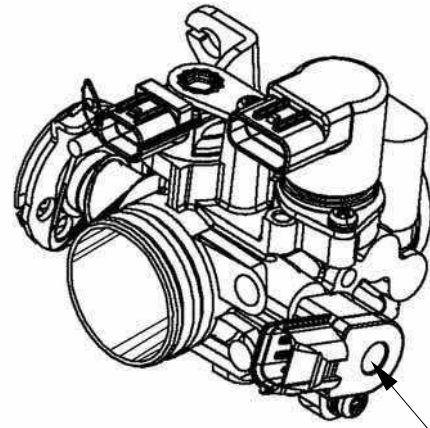

TPS

REMOVAL

Loosen the throttle cables with the adjusting nuts.
 Disconnect the throttle cable ends from throttle seat.

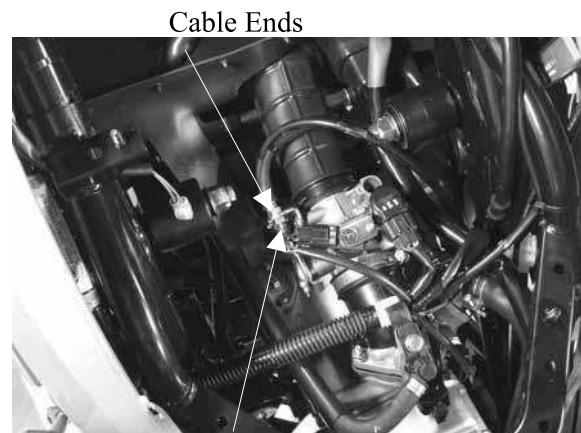

Cable Ends

Adjusting Nuts

Disconnect the TPS, ISC and MAP sensor connectors.
 Loosen the air cleaner connecting hose band screw.
 Loosen the intake manifold band screw.
 Remove the throttle body, MAP sensor, TPS sensor and ISC sensor as a set.

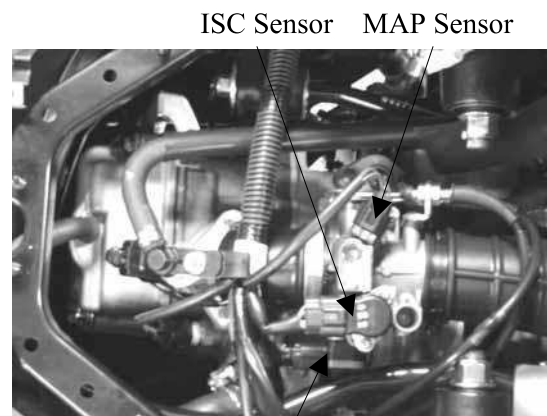

ISC Sensor MAP Sensor

TPS Sensor

13. FUEL INJECTION SYSTEM

DISASSEMBLY

*

The throttle position sensor (TPS) and idle air bypass valve (ISC) have to be reset when the throttle body MAP, TPS, ISC or ECU has been reinstalled.

Remove the screw and then remove the ISC and set plate.

Remove the screw and set plate.

Remove the MAP

Remove the screw AND then remove the TPS.

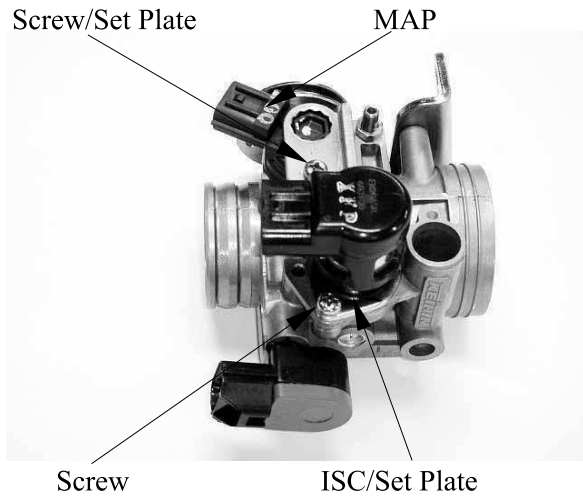

ASSEMBLY

*

The throttle position sensor (TPS) and idle air bypass valve (ISC) have to reset when the throttle body MAP, TPS, ISC or ECU has been reinstalled.

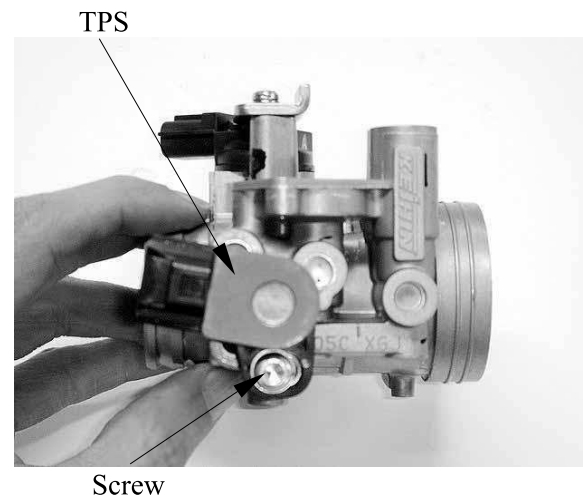

Apply oil onto a new O-ring.

When install the TPS onto the throttle body, being careful not to damage the O-ring.

Install and tighten the screw securely.

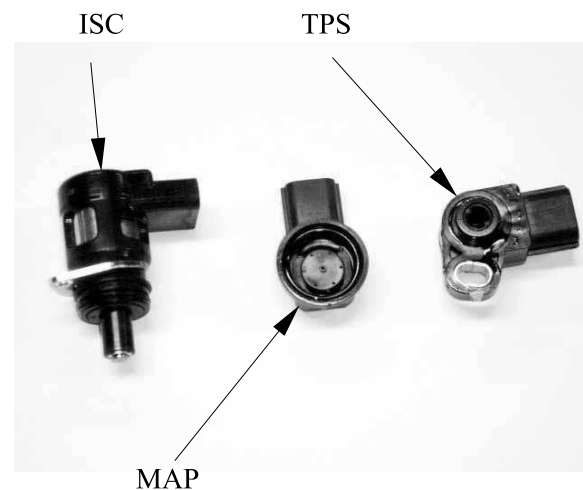

13. FUEL INJECTION SYSTEM

Apply oil onto a new O-ring.

When install the MAP onto the throttle body, being careful not to damage the O-ring.

* Always replace an O-ring with a new one.

Install the set plate and tighten the screw securely.

Apply oil onto a new O-ring.

When install the ISC and set plate onto the throttle body, being careful not to damage the O-ring.

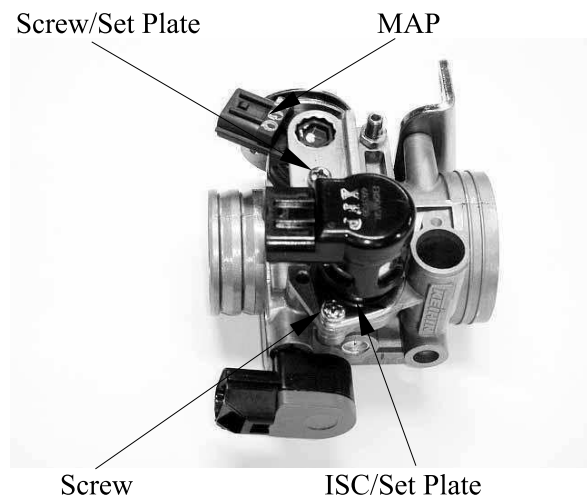
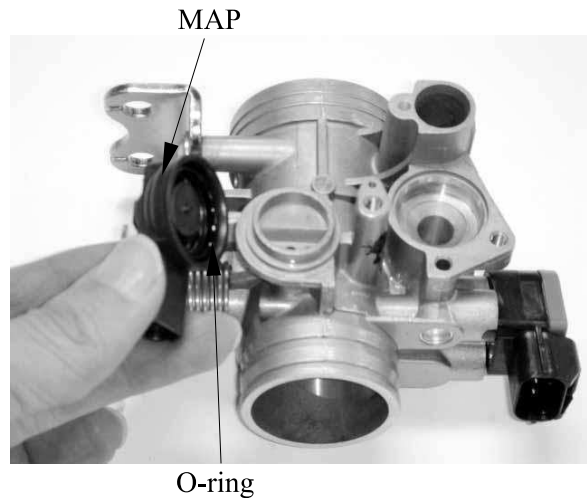

DIAGNOSTIC TOOL CONNECTOR

INSPECTION

Put the side stand up and engine stop switch is at "RUN".

Turn the ignition switch to "ON"

Measure the voltage between the following terminals of the diagnostic tool connector with PDA tester.

Terminal	Normal
Black (+) – Green (-)	Battery voltage
White/Yellow (+) – Green (-)	Battery voltage – 1 V



Diagnostic Connector



**FI DIAGNOSTIC TOOL
OPERATION INSTRUCTIONS
3620A-LEB2-E00**

. FI DIAGNOSTIC TOOL

- This tool is developed by KYMCO and for KYMCO vehicle only.
- Please refer to the specification when serving this vehicle.
- This tool is without battery inside. The power is provided from vehicle.
- This software can be updated with computer for new model through the USB cable. The power required of tool is connected with 12V battery.
- For connection, please connect this tool with the connector of ECU. It's available when turning on the ignition switch.
- The side stand must be upward when serving the diagnostic procedure.
- The function includes ECU version, model name, data analysis and reset.
 - ECU version: includes model name, ECU number, identifications number and software version.
 - Failure codes: DTC reading, DTC clearing and troubleshooting.
 - Data analysis: For ECU's software inspection.
 - Reset: For the setting function adjustment.

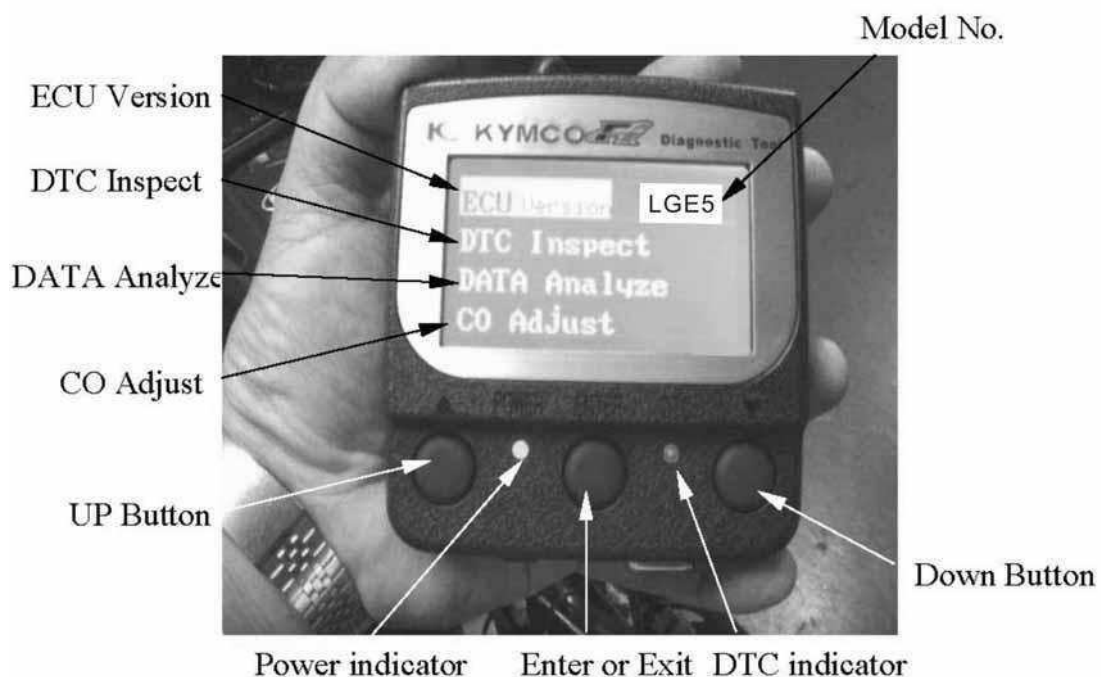

13. FUEL INJECTION SYSTEM

. DTC INSPECTION PROCEDURE

Showing four functions on the screen when switching on power.



LGE5 is for
People GT 300i

A). ECU version: Including of model name, ECU number, identifications number and software version.

Press the " Enter " button

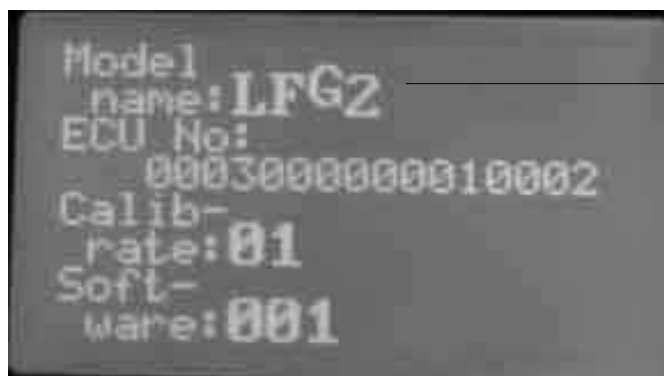

LGE5 is for
People GT 300i

B). Press the " Down " button and then turn to the first page.



LGE5 is for
People GT 300i

C). Press the " Enter " button to check the DTC failure code



LGE5 is for
People GT 300i

D). Press the " Enter " button

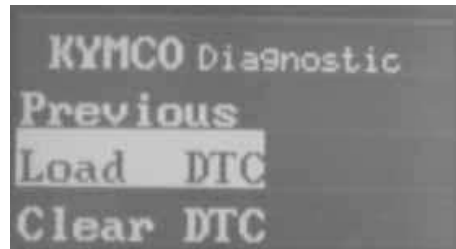

E). Press the " Enter " button

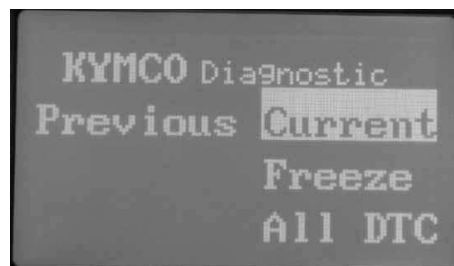

F). Display what's DTC number on this DTC-List.

Press the " Enter " button and then turn to the previous page

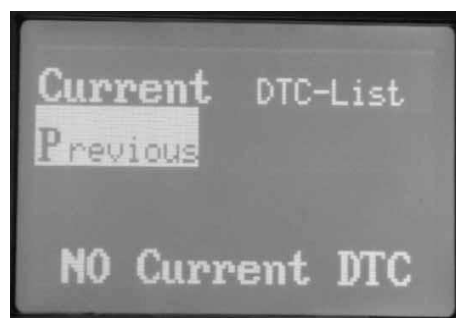

G). Press the " UP " button

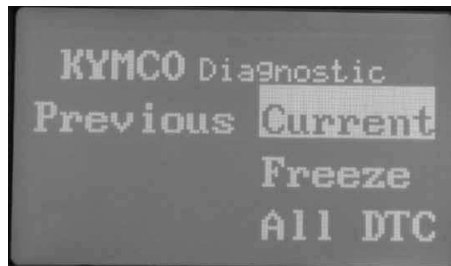

H). Press the " Enter " button and then turn to the previous page with red color.

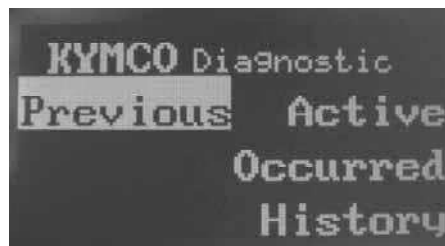

I). Press the " UP " button

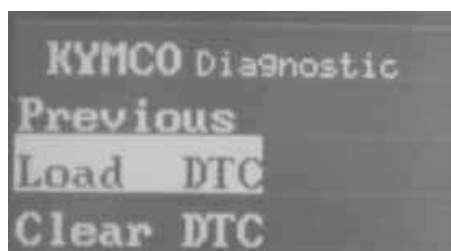

13. FUEL INJECTION SYSTEM

J). Press the " Enter " button and then turn to the first page.

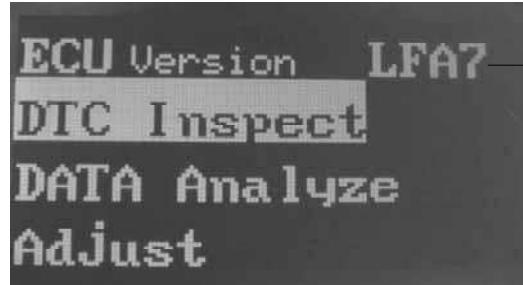

LGE5 is for
People GT 300i



LGE5 is for
People GT 300i

13. FUEL INJECTION SYSTEM

. DTC CLEAR PROCEDURE

A). Check the DTC



LGE5 is for
People GT 300i

B). Press the " Enter " button



LGE5 is for
People GT 300i

C). Choose " Load DTC "
Press the " Down " button

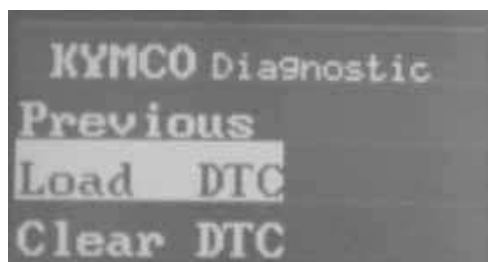

13. FUEL INJECTION SYSTEM

D). Press the " Enter " button and the indicator is lighting.

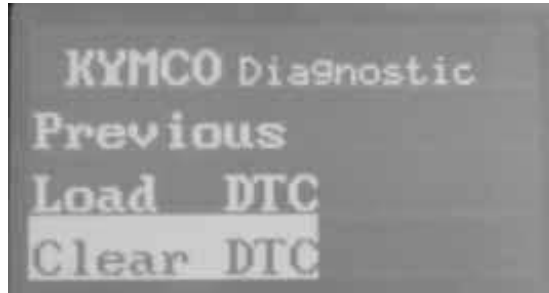

E). Clearing DTC completed if the indicator is off.

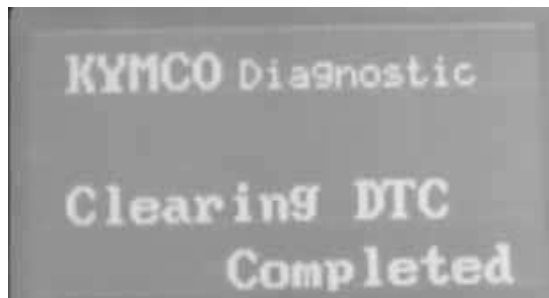

13. FUEL INJECTION SYSTEM

. DATA ANALYSIS PROCEDURE

A). Press the " Down " twice



LGE5 is for
People GT 300i

B). Choose " Data Analyze"

Press the " Enter " button to enter page 01

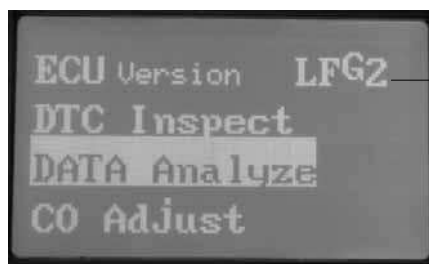

LGE5 is for
People GT 300i

C). Down-page 01

The measure figures including of Engine speed, Battery voltage and DTC number.

Press the " Down " button to enter page 02.

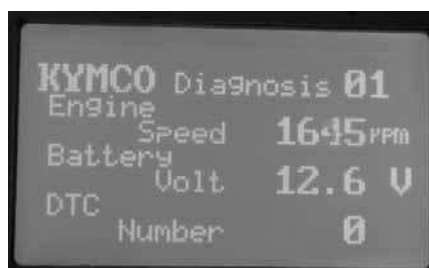

5. FUEL INJECTION SYSTEM

. DATA ANALYSIS PROCEDURE

A). Press the " Down " twice



LGE5 is for
People GT 300i

B). Choose " Data Analyze"

Press the " Enter " button to enter page 01

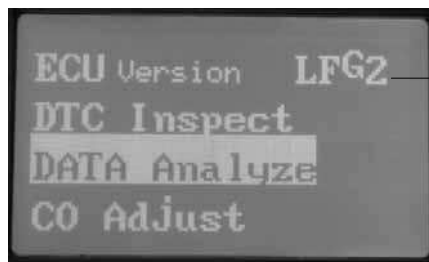

LGE5 is for
People GT 300i

C). Down-page 01

The measure figures including of Engine speed, Battery voltage and DTC number.

Press the " Down " button to enter page 02.

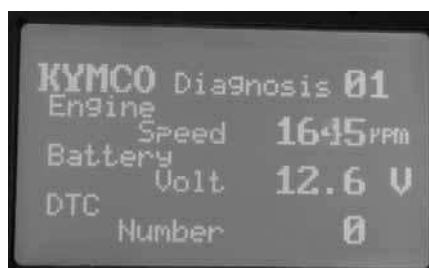

5. FUEL INJECTION SYSTEM

D). Down-page 02

The measure figures including of TPS position, Intake pressure and Intake air temperature.

Press the “ Down” button to enter page 03.

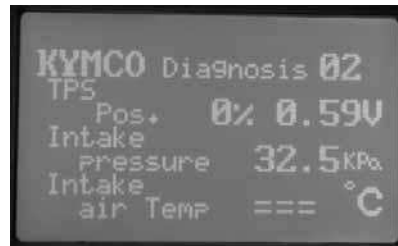

E). Down-page 03

The measure figures including of Atmosphere pressure, Fuel Injector interval and Ignition advance timing.

Press the “ Down” button to enter page 04.

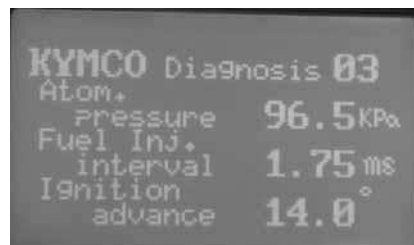

F). Down-page 04

The measure figures including of Engine temperature, O2 sensor voltage and O2 heater activation.

Press the “ Down” button to enter page 05.



5. FUEL INJECTION SYSTEM

G). Down-page 05

The measure figures including of ISC target, ISC step and ISC learn step.

Press the “ Down ” button to enter page 06.



H). Down-page 06

The measure figures including of ISC motor state.

Press the “ Down ” button to enter page 07.

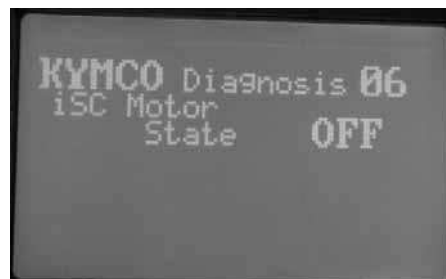

I). Down-page 07

The measure figures including of Cut Out voltage.

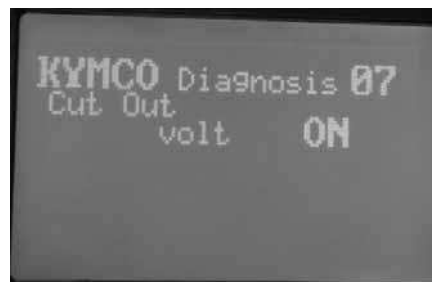

J). Press the " UP " to the previous page.

5. FUEL INJECTION SYSTEM

五. Vehicle can not be started – Handling method (Steps)

Preliminary Checking: 6 basic inspection

1. Is the battery with voltage (12 V or higher)
2. Key-On and listen for any action with Fuel Pump / Fuel Pump Relay (It will turn off automatically in 5-10 seconds)
3. Key-On to check for any failure lamp light up on dashboard.
4. Is the Idle screw of Throttle Valve being changed or loose?
5. Has the vehicle under regular service? Is the gas station a good one?

6. Is the spark plug the correct model of specified by the vehicle builder?

Vehicle can not be started?

Check for any Failure code. (Failure Lamp on / How to tell the Failure code?)

Turn on power to see if the engine inspection / failure lamp off?

If it flashes continuously or light up for long time, the vehicle is at failure -> read the Failure Code?

Methods:

1. Reading DTC from speedometer, if PDA or diagnosis tool is not available.
2. Reading DTC from Diagnosis tool, if it is available.

5. FUEL INJECTION SYSTEM

六. Manual Trouble Shooting Procedure

How to read DTC from speedometer?

New Phase 5 Fuel Injection Engine Vehicle DTC Reading:

Automatic indication – ECU upgrade version (with Oxygen sensor):

Reading DTC from speedometer directly.

Key On → light off in 2 seconds. When the engine inspection lamp is light up again, it starts to deliver failure code. If no show, there is without any failure.

Note:

1. The “CELP” denotes the failure codes. When the indicator lights for 1 second it is equivalent 10 blinks. For example, a 1 second illumination and two blinks (0.5 second x 2) of the indicator equals 12 blinks. Refer to DTC 12.
2. If more than one failure occurs, the “CELP” shows the blinks in the occurred order. For example, if the indicator blinks 6 times, then shows one second illumination and two blinks, two failures have occurred. Refer to DTC 6 and DTC 12.

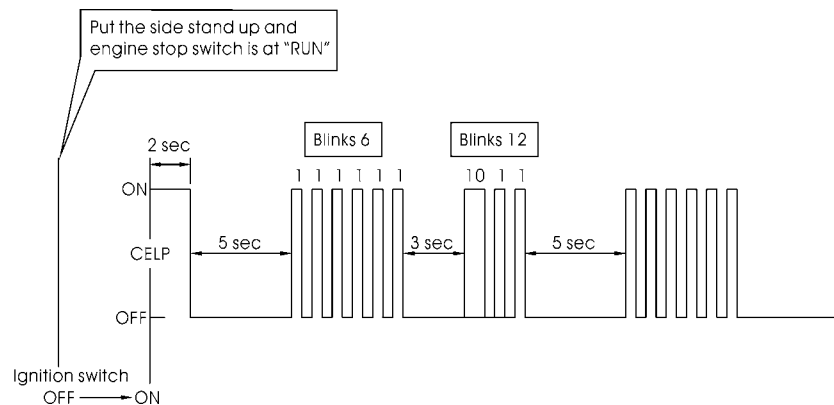

After excluding trouble, how the DTC can be cleared? Confirm the failure is excluded.

- Turn on power but maintain not started and keep the engine inspection lamp light up for 4 cycles. If it is off automatically, it means the historical DTC is cleared automatically.
- Use PDA or diagnosis tool: clear Historical Failure code
- Check again to confirm DTC is excluded.
Turn on power again. When there is no residual historical failure cod.
Start the engine and if no failure lamp is on or flashing, it is Okay.