

---

## PREFACE

This Service Manual describes the technical features and servicing procedures for the KYMCO DINK50.

Section 1 contains the precautions for all operations stated in this manual. Read them carefully before any operation is started.

Section 2 is the removal/installation procedures for the frame covers which are subject to higher removal/installation frequency during maintenance and servicing operations.

Section 3 describes the inspection/adjustment procedures, safety rules and service information for each part, starting from periodic maintenance.

Sections 5 through 12 give instructions for disassembly, assembly and adjustment of engine parts. Section 13 is the removal/installation of chassis. Section 16 states the testing and measuring methods of electrical equipment.

Most sections start with an assembly or system illustration and troubleshooting for the section. The subsequent pages give detailed procedures for the section.

The information and contents included in this manual may be different from the motorcycle in case specifications are changed.
---

## TABLE OF CONTENTS

ENGINE	GENERAL INFORMATION	1
	EXHAUST MUFFLER/FRAME COVERS	2
	INSPECTION/ADJUSTMENT	3
	LUBRICATION SYSTEM	4
	ENGINE REMOVAL/INSTALLATION	5
	CYLINDER HEAD/CYLINDER/PISTON	6
	KICK STARTER/DRIVE PULLEY/CLUTCH/DRIVEN PULLEY	7
	FINAL REDUCTION	8
	A.C. GENERATOR	9
	CRANKCASE/CRANKSHAFT	10
	COOLING SYSTEM	11
	CARBURETOR/FUEL PUMP	12
CHASSIS	STEERING HANDLEBAR/FRONT WHEEL/FRONT BRAKE/FRONT SHOCK ABSORBER/FRONT FORK	13
	REAR BRAKE/REAR FORK/REAR WHEEL/REAR SHOCK ABSORBER	14
	FUEL TANK	15
ELECTRICAL EQUIPMENT	BATTERY/CHARGING SYSTEM	16
	IGNITION SYSTEM	17
	STARTING SYSTEM	18
	SWITCHES/HORN/FUEL UNIT/ THERMOSTATIC SWITCH/TEMPERATURE GAUGE/INSTRUMENTS/ LIGHTS	19
TIRE	HIGH-SPEED TIRE (TUBELESS TIRE)	20

**KWANG YANG MOTOR CO., LTD.**  
**OVERSEAS SALES DEPARTMENT**  
**OVERSEAS SERVICE SECTION**

---

# 1. GENERAL INFORMATION

---

1

<b>ENGINE SERIAL NUMBER</b> --- 1- 0	<b>TOOLS</b> ----- 1-14
SPECIFICATION ----- 1- 1	LUBRICATION POINTS----- 1-16
SERVICE PRECAUTIONS----- 1- 3	WIRING DIAGRAM ----- 1-17
TORQUE VALUES ----- 1-13	CABLE & HARNESS ROUTING-- 1-22
	TROUBLESHOOTING ----- 1-24

## ENGINE SERIAL NUMBER



Location of Engine Serial Number

# 1. GENERAL INFORMATION

## SPECIFICATIONS

Name & Model No.		SH10BA		
Overall length		1950mm		
Overall width		735mm		
Overall height		1180mm		
Wheel base		1350mm		
Engine type		Air cooled 2-stroke		
Displacement		49.4cc		
Fuel Used		92# nonleaded gasoline		
Net weight (kg)	Front wheel	45		
	Rear wheel	61.5		
	Total	106.5		
Gross weight(kg)	Front wheel	80		
	Rear wheel	149		
	Total	229		
Tires	Front wheel	110/70-12		
	Rear wheel	130/70-12		
Ground clearance		155mm		
Performance	Braking distance (m)	4.4m /30km/HV		
	Min. turning radius	2150mm		
Engine	Starting system		Starting motor & kick starter	
	Type		Gasoline, 2-stroke	
	Cylinder arrangement		Single cylinder, flat	
	Combustion chamber type		Semi-sphere	
	Bore x stroke (mm)		39 x 41.4	
	Compression ratio		7.2:1	
	Compression pressure (kg/cm <sup>2</sup> -rpm)		11.8	
	Max. output (ps/rpm)		5.2/7000	
	Max. torque (kg m/rpm)		0.56/6500	
	Port timing	Intake (1mm)	Open	Automatic controlled
			Close	Automatic controlled
		Exhaust (1mm)	Open	
			Close	
	Valve clearance (cold)		Intake	
			Exhaust	
	Idle speed (rpm)		2000±100rpm	
	Lubrication System	Lubrication type		Separate type
		Oil pump type		Plunger type
		Oil filter type		Full-flow filtration
		Oil capacity		1.1 liters
Cooling Type		Air cooling		

Fuel System	Air cleaner type & No		Paper element, wet		
	Lubrication oil capacity		1.5. liters		
	Fuel capacity		10. liters		
	Carburetor	Type		PB	
Piston dia.					
Venturi dia.		14 equivalent			
Throttle type					
Electrical Equipment	Ignition System	Type		CDI	
		Ignition timing		13.5°/2000rpm	
		Contact breaker			
		Spark plug		NGK BR8HSA	
	Spark plug gap		0.6~0.7mm		
Battery	Capacity		12V4AH		
Power Drive System	Clutch	Type		Dry multi-disc clutch	
		Transmission Gear	Type		Non-stage transmission
	Operation		Automatic centrifugal type		
	Reduction Gear	Type		Two-stage reduction	
		Reduction ratio	1st		
2nd					
Moving Device	Front Axle	Caster angle			
		Connecting rod			
	Tire pressure (kg/cm <sup>2</sup> )	Front	1.75		
		Rear	2.25		
Turning angle	Left	42.5°			
	Right	42.5°			
Brake system type		Front	Disk brake		
		Rear	Expanding		
Damping Device	Suspension type	Front	Telescope		
		Rear	Unit swing		
	Shock absorber type	Front	Telescope		
		Rear	Double swing		
Frame type		Under bone			

# 1. GENERAL INFORMATION

## SPECIFICATIONS

Name & Model No.		SH10AA		
Overall length		1950mm		
Overall width		735mm		
Overall height		1180mm		
Wheel base		1350mm		
Engine type		Water cooled 2stroke		
Displacement		49.4cc		
Fuel Used		92# nonleaded gasoline		
Net weight (kg)	Front wheel	45		
	Rear wheel	61..5		
	Total	106.5		
Gross weight(kg)	Front wheel	80		
	Rear wheel	149		
	Total	229		
Tires	Front wheel	110/70-12		
	Rear wheel	130/70-12		
Ground clearance		155mm		
Performance	Braking distance (m)	4.4m /30km/HV		
	Min. turning radius	2150mm		
Engine	Starting system		Starting motor & kick starter	
	Type		Gasoline,2-stroke	
	Cylinder arrangement		Single cylinder	
	Combustion chamber type		Semi-sphere	
	Bore x stroke (mm)		39 x 41.4	
	Compression ratio		7.2:1	
	Compression pressure (kg/cm <sup>2</sup> -rpm)		11.8	
	Max. output (ps/rpm)		5.7/7000	
	Max. torque (kg m/rpm)		0.6/6500	
	Port timing	Intake (1mm)	Open	Automatic controlled
			Close	Automatic controlled
		Exhaust (1mm)	Open	
			Close	
	Valve clearance (cold)		Intake	
			Exhaust	
	Idle speed (rpm)		2000±100rpm	
	Lubrication System	Lubrication type		Separate type
		Oil pump type		Plunger type
		Oil filter type		Full-flow filtration
		Oil capacity		1.1 liters
	Cooling Type		Water cooling	

Fuel System	Air cleaner type & No		Paper element, wet	
	Lubrication oil capacity		1.5 liters	
	Fuel capacity		10 liters	
	Carburetor	Type	P B	
Piston dia.				
Venturi dia.		14 equivalent		
Electrical Equipment	Ignition System	Type	CDI	
		Ignition timing	13.5°/2000rpm	
		Spark plug	NGK BR6HSA	
	Spark plug gap	0.6~0.7mm		
	Battery	Capacity	12V4AH	
	Power Drive System	Clutch	Type	Dry multi-disc clutch
Transmission Gear			Type	Non-stage transmission
		Operation	Automatic centrifugal type	
		Reduction Gear	Type	Two-stage reduction
Reduction ratio			1st	
		2nd		
Moving Device	Front Axle	Caster angle		
		Connecting rod		
	Tire pressure (kg/cm <sup>2</sup> )	Front	1.75	
		Rear	2.25	
Turning angle	Left	42.5°		
	Right	42.5°		
Brake system type		Front	Disk brake	
		Rear	Expanding	
Damping Device	Suspension type	Front	Telescope	
		Rear	Unitswing	
	Shock absorber type	Front	Telescope	
		Rear	Double swing	
Frame type		Under bone		



# 1. GENERAL INFORMATION

---

## SERVICE PRECAUTIONS

- Make sure to install new gaskets, O-rings, circlips, cotter pins, etc. when reassembling.

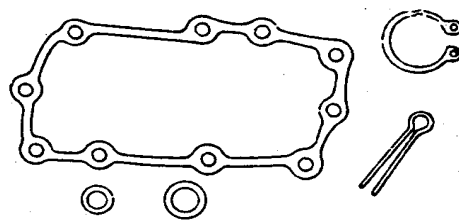

- When tightening bolts or nuts, begin with larger-diameter to smaller ones at several times, and tighten to the specified torque diagonally.

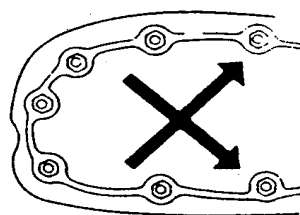

- Use genuine parts and lubricants.

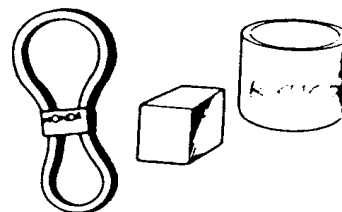

- When servicing the motorcycle, be sure to use special tools for removal and installation.

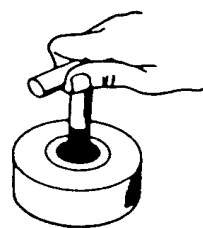

- After disassembly, clean removed parts. Lubricate sliding surfaces with engine oil before reassembly.

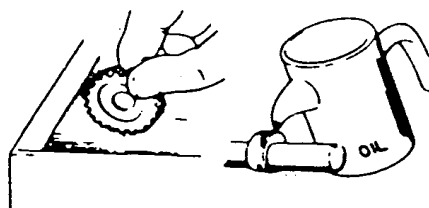

# 1. GENERAL INFORMATION

---

- Apply or add designated greases and lubricants to the specified lubrication points.

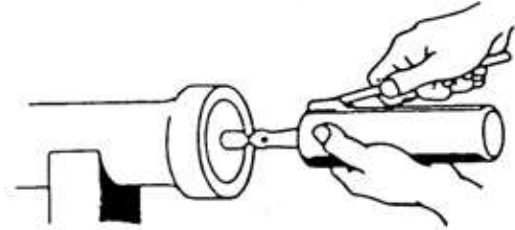

- After reassembly, check all parts for proper tightening and operation.

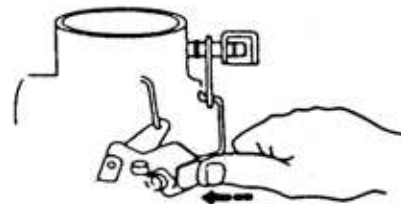

- When two persons work together, pay attention to the mutual working safety.



- Disconnect the battery negative (-) terminal before operation.
- When using a spanner or other tools, make sure not to damage the motorcycle surface.

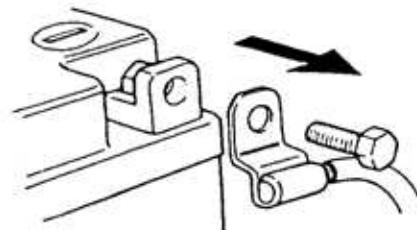

- After operation, check all connecting points, fasteners, and lines for proper connection and installation.
- When connecting the battery, the positive (+) terminal must be connected first.
- After connection, apply grease to the battery terminals.
- Terminal caps shall be installed securely.

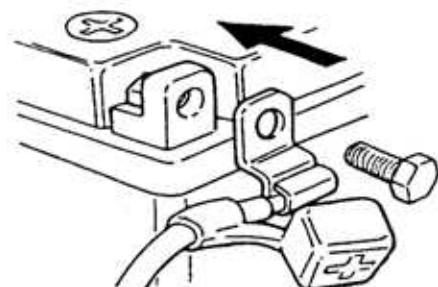

# 1. GENERAL INFORMATION

---

- If the fuse is burned out, find the cause and repair it. Replace it with a new one according to the specified capacity.

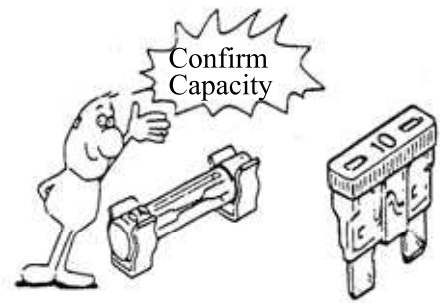

- After operation, terminal caps shall be installed securely.



- When taking out the connector, the lock on the connector shall be released before operation.

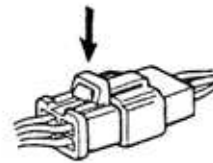

- Hold the connector body when connecting or disconnecting it.
- Do not pull the connector wire.

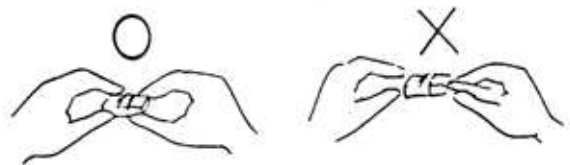

- Check if any connector terminal is bending, protruding or loose.

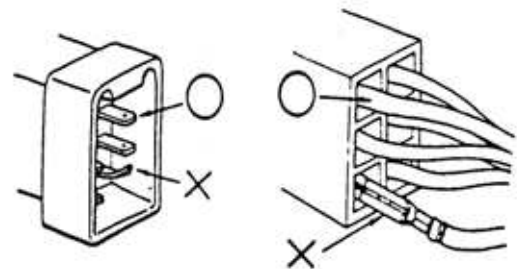

# 1. GENERAL INFORMATION

---

- The connector shall be inserted completely.
- If the double connector has a lock, lock it at the correct position.
- Check if there is any loose wire.

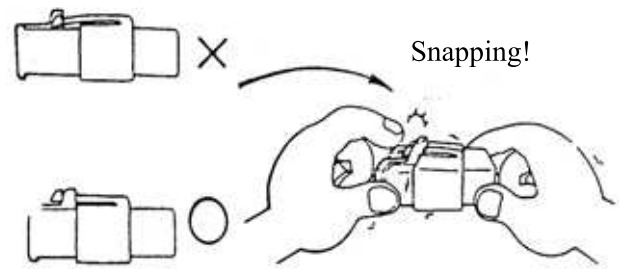

- Before connecting a terminal, check for damaged terminal cover or loose negative terminal.

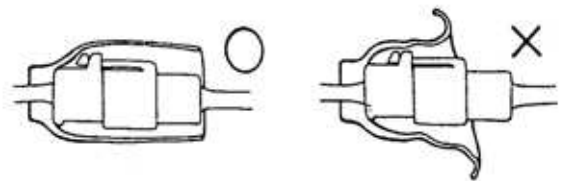

- Check the double connector cover for proper coverage and installation.

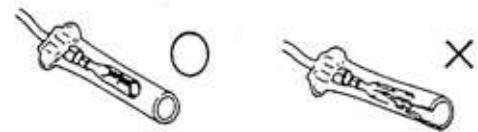

- Insert the terminal completely.
- Check the terminal cover for proper coverage.
- Do not make the terminal cover opening face up.

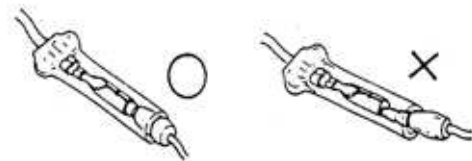

- Secure wire harnesses to the frame with their respective wire bands at the designated locations. Tighten the bands so that only the insulated surfaces contact the wire harnesses.

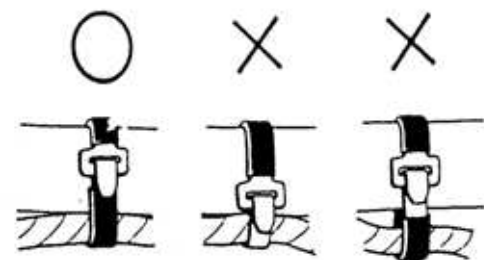

# 1. GENERAL INFORMATION

---

- After clamping, check each wire to make sure it is secure.

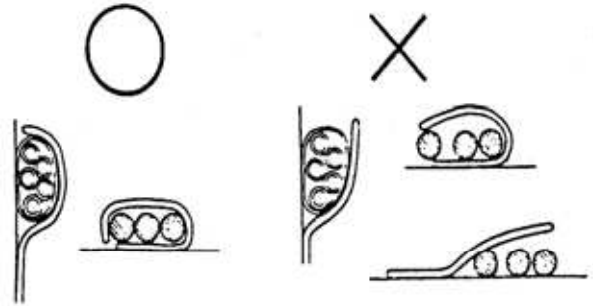

- Do not squeeze wires against the weld or its clamp.



- After clamping, check each harness to make sure that it is not interfering with any moving or sliding parts.

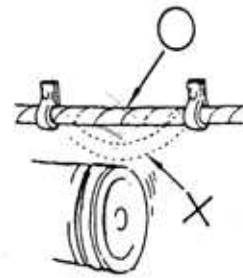

- When fixing the wire harnesses, do not make it contact the parts which will generate high heat.

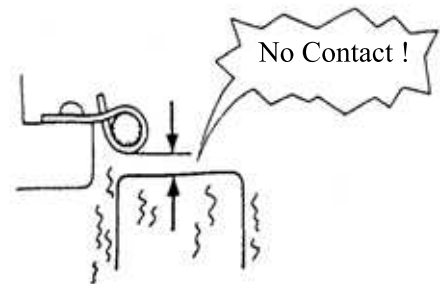

- Route wire harnesses to avoid sharp edges or corners. Avoid the projected ends of bolts and screws.
- Route wire harnesses passing through the side of bolts and screws. Avoid the projected ends of bolts and screws.

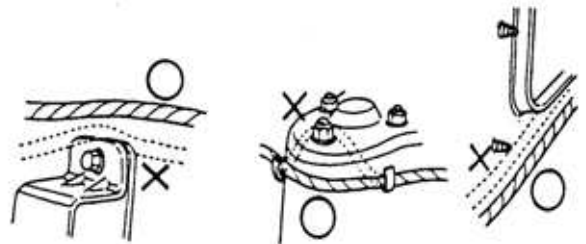

# 1. GENERAL INFORMATION

---

- Route harnesses so they are neither pulled tight nor have excessive slack.

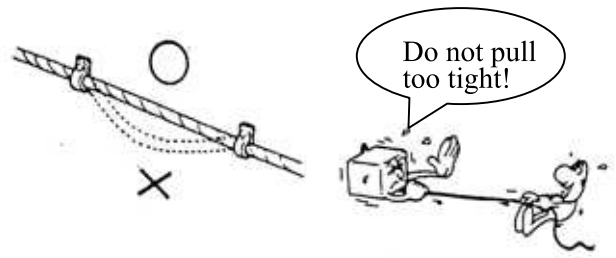

- Protect wires and harnesses with electrical tape or tube if they contact a sharp edge or corner.

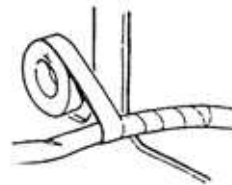

- When rubber protecting cover is used to protect the wire harnesses, it shall be installed securely.

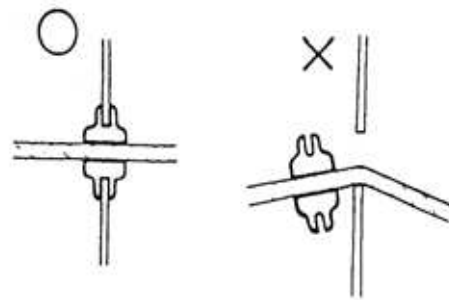

- Do not break the sheath of wire.
- If a wire or harness is with a broken sheath, repair by wrapping it with protective tape or replace it.

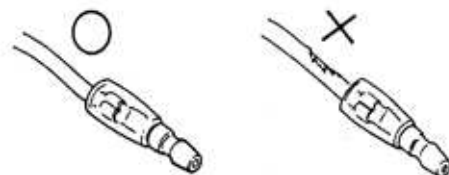

Do not press or squeeze the wire.

- When installing other parts, do not press or squeeze the wires.



# 1. GENERAL INFORMATION

---

- After routing, check that the wire harnesses are not twisted or kinked.

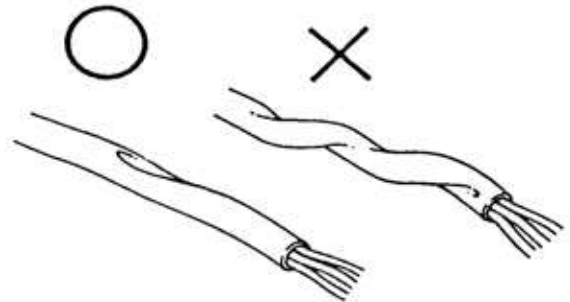

- Wire harnesses routed along with handlebar should not be pulled tight, have excessive slack or interfere with adjacent or surrounding parts in all steering positions.



- When a testing device is used, make sure to understand the operating methods thoroughly and operate according to the operating instructions.
- Be careful not to drop any parts.

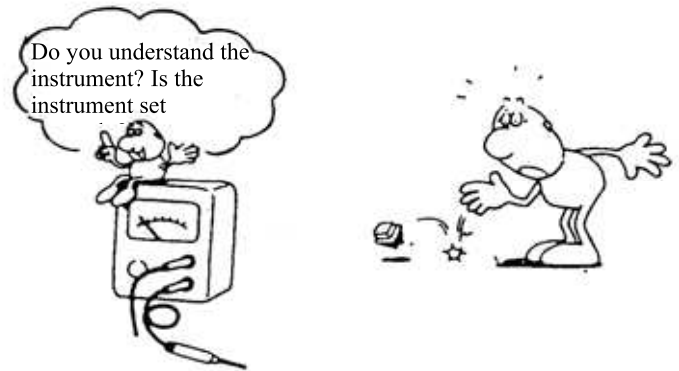

- When rust is found on a terminal, remove the rust with sand paper or equivalent before connecting.

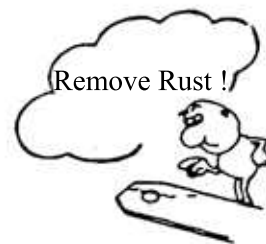

- Do not bend or twist control cables. Damaged control cables will not operate smoothly and may stick or bind.



# 1. GENERAL INFORMATION

---

## ■ Symbols:

The following symbols represent the servicing methods and cautions included in this service manual.



: Apply engine oil to the specified points. (Use designated engine oil for lubrication.)



: Apply grease for lubrication.



: Transmission Gear Oil (90#)



: Use special tool.



: Caution



: Warning



# 1. GENERAL INFORMATION

## SERVICE INFORMATION

ENGINE Item	Standard (mm)		Service Limit (mm)	
	SH10BA	SH10AA	SH10BA	SH10AA
Cylinder head warpage	—	—	0.10	0.10
Piston O.D.(5mm from bottom of piston skirt)	38.970~38.955	38.970~38.955	38.90	38.90
Cylinder-to- piston clearance	0.03~0.07		0.10	0.10
Piston pin hole I.D.	12.002~12.008	12.002~12.008	12.03	12.03
Piston pin O.D.	11.994~12.0	11.994~12.0	11.98	11.98
Piston-to-piston pin clearance	0.002~0.014	←	0.03	←
Piston ring end gap (top/second)	0.10~0.25	0.10~0.25	0.40	0.40
Connecting rod small end I.D.	17.005~17.017	17.005~17.017	17.03	17.03
Cylinder bore	39.0~39.025	39.0~39.025	39.05	39.05
Drive belt width	18	18	17	17
Drive pulley collar O.D.	20.01~20.025	20.01~20.025	19.97	19.97
Movable drive face ID.	20.035~20.085	20.035~20.085	20.21	20.21
Weight roller O.D.	13.0	13.0	12.4	12.4
Clutch outer I.D.	107~107.2	107~107.2	107.5	107.5
Driven face spring free length	87.9	87.9	82.6	82.6
Driven face O.D.	33.965~33.985	←	33.94	←
Movable driven face I.D.	34.0~34.025	←	34.06	←
Connecting rod big end side clearance	—	←	0.60	←
Connecting rod big end radial clearance	—	←	0.04	←
Crankshaft runout A/B	—	—	L:0.15 R:0.10	←

CARBURETOR	SH10BA	SH10AA
Venturi dia.	14mm	14mm
Identification number	PB058 <span style="border: 1px solid black; padding: 0 2px;">A</span>	PB058 <span style="border: 1px solid black; padding: 0 2px;">A</span>
Float level	8.6mm	8.6mm
Main jet	#85	#85
Slow jet	#35	#35
Air screw opening	1½ ± ½	1¼ ± ½
Idle speed	2000±100rpm	2000±100rpm
Throttle grip free play	2~6mm	2~6mm
Jet needle clip notch	1 <sup>st</sup> notch	1 <sup>st</sup> notch

# 1. GENERAL INFORMATION

## FRAME

Item		Standard (mm)		Service Limit (mm)	
		SH10BA	SH10AA	SH10BA	SH10AA
Axle shaft runout		—	—	0.2	0.2
Front wheel rim runout	Radial				
	Axial				
Front shock absorber spring free length		200.0	200.0	182.8	182.8
Rear wheel rim runout				2.0	2.0
Brake drum I.D.	Front/rear	110	110	111	111
Brake lining thickness	Front/rear	4.0/4.0	4.0/4.0	2.0/2.0	2.0/2.0
Brake disk runout	Front/rear	—	—	0.30	0.30
Rear shock absorber spring free length		235.7	235.7	218.7	218.7

## ELECTRICAL EQUIPMENT

			SH10BA	SH10AA
Battery	Capacity		12V4AH	12V4AH
	Voltage		13.0~13.2V	13.0~13.2V
	Charging current	Standard	0.4A/5H	0.4A/5H
		Quick	4A/0.5H	4A/0.5H
Spark plug	(NGK)		BR8HSA	BR6HSA
Spark plug gap			0.6~0.7mm	0.6~0.7mm
Ignition coil resistance	Primary coil		0.153~0.187Ω	0.153~0.187Ω
	Secondary coil (with plug cap)		6.99~10.21KΩ	6.99~10.21KΩ
	Secondary coil (without plug cap)		3.24~3.96KΩ	3.24~3.96KΩ
Pulser coil resistance (20°C)			80~160Ω	80~160Ω
Ignition timing			13.5°±2°BTDC/2000rpm	13.5°±2°BTDC/2000rpm

# 1. GENERAL INFORMATION

## TORQUE VALUES

### ENGINE

Item	Thread dia. (mm)	Torque (kg-m)	Remarks
Cylinder head bolt	BF7x115	1.5~1.7	(cold)
Clutch drive plate nut	10	3.5~4.0	
Clutch outer nut	NH10	3.5~4.5	
Drive face nut	NH12	5.0~6.0	
Oil check bolt	10	1.0~1.5	
Engine mounting bolt	BF10x95	4.5~5.5	
Engine hanger bracket bolt	BF10x50	3.5~4.5	
Exhaust muffler joint lock nut	NC6mm	1.0~1.4	
Exhaust muffler lock bolt	BF8x35	3.0~3.6	
Spark plug		1.1~1.7	(cold)

### FRAME

Item	Thread dia. (mm)	Torque (kg-m)	Remarks
Handlebar lock nut	10	4.5~5.0	Flange bolt/U-nut
Steering stem lock nut	25.4	8.0~12.0	
Steering top cone race	25.4	0.5~1.3	
Front axle nut	12	5.0~7.0	Flange U-nut
Rear axle nut	16	11.0~13.0	Flange U-nut
Rear brake arm bolt			Flange nut
Front shock absorber:			
upper mount bolt	8	3.3	Flange bolt/U-nut
lower mount bolt		3.3	Cross head
hex bolt		1.5~3.0	Apply locking agent
Front damper nut	8	1.5~3.0	
Front pivot arm bolt			Flange screw/U-nut
Rear shock absorber:			
upper mount bolt	10	3.5~4.5	Flange nut
lower mount bolt	8	2.4~3.0	
lower joint nut	8	1.5~2.5	

Torque specifications listed above are for important fasteners. Others should be tightened to standard torque values below.

#### STANDARD TORQUE VALUES

SH bolt: 8mm      Flange 6mm bolt

Item	Torque (kg-m)	Item	Torque (kg-m)
5mm bolt, nut	0.45~0.6	5mm screw	0.35~0.5
6mm bolt, nut	0.8~1.2	6mm screw, SH bolt	0.7~1.1
8mm bolt, nut	1.8~2.5	6mm flange bolt, nut	1.0~1.4
10mm bolt, nut	3.0~4.0	8mm flange bolt, nut	2.4~3.0
12mm bolt, nut	5.0~6.0	10mm flange bolt, nut	3.5~4.5

# 1. GENERAL INFORMATION

---

## SPECIAL TOOLS

Tool Name	Tool No.	Remarks
Universal bearing puller		Crankshaft bearing removal
Lock nut wrench, 39mm		Drive pulley disassembly/assembly
Lock nut socket wrench		Top cone race holding
Lock nut wrench,		Stem lock nut tightening
Crankcase puller		Crankcase disassembly
Bearing remover set, 12mm (Spindle assy, 15mm) (Remover weight)		Drive shaft bearing removal/installation
Bearing remover set, 15mm (Spindle assy, 15mm) (Remover head, 15mm) (Remover shaft, 15mm)		Drive shaft bearing removal/installation
Bearing outer driver, 28x30mm		Bearing installation
Bearing remover		Driven pulley outer bearing installation
Clutch spring compressor		Driven pulley disassembly/assembly
Crankcase assembly collar		Driven shaft, crankshaft & crankcase assembly
Crankcase assembly tool		Crankshaft & crankcase assembly
Rear shock absorber remover		Front shock absorber disassembly/assembly
Ball race remover		Steering stem bearing races
Rear shock absorber compressor		Rear shock absorber disassembly/assembly
Float level gauge		Carburetor fuel level check
Lock nut socket wrench, 32mm		One-way clutch lock nut removal/installation
Universal holder		Flywheel holding
Flywheel puller		Flywheel removal
Pilot, 12mm		Drive shaft bearing installation
Bearing outer driver, 32x35mm		Drive shaft bearing installation Final shaft bearing installation

# 1. GENERAL INFORMATION

---

Tool Name	Tool No.	Remarks
Bearing outer driver, 37x40mm		Drive shaft bearing installation Final shaft bearing installation Crankshaft bearing installation
Outer driver, 24x26mm		Driven pulley bearing installation
Pilot, 10mm		Front wheel bearing installation
Bearing driver pilot, 17mm		Drive shaft bearing installation
Snap ring pliers (close)		Circlip removal/installation
Bearing outer driver, 42x47mm		Crankshaft bearing installation
Pilot, 20mm		Crankshaft bearing installation
Bearing outer driver handle A		Bearing installation Drive in ball race
Bearing puller head, 10mm		Front wheel bearing removal
Universal bearing puller		Crankshaft bearing removal
Bearing puller		Front wheel bearing removal
Pressure tester set		Cylinder compression gauge

# 1. GENERAL INFORMATION

## LUBRICATION POINTS

### ENGINE

NO.	Lubrication Points	Lubricant	Remarks
1	Crankcase sliding & movable	JASO-FC or API-TC	
2	Cylinder movable parts		
3	Transmission gear (final gear)	SAE-90#	
4	Kick starter spindle bushing	Grease	
5	Drive pulley movable parts	Grease	
6	Starter pinion movable parts	Grease	

### FRAME

Apply clean engine oil or grease to cables and movable parts not specified. This will avoid abnormal noise and rise the durability of the motorcycle.

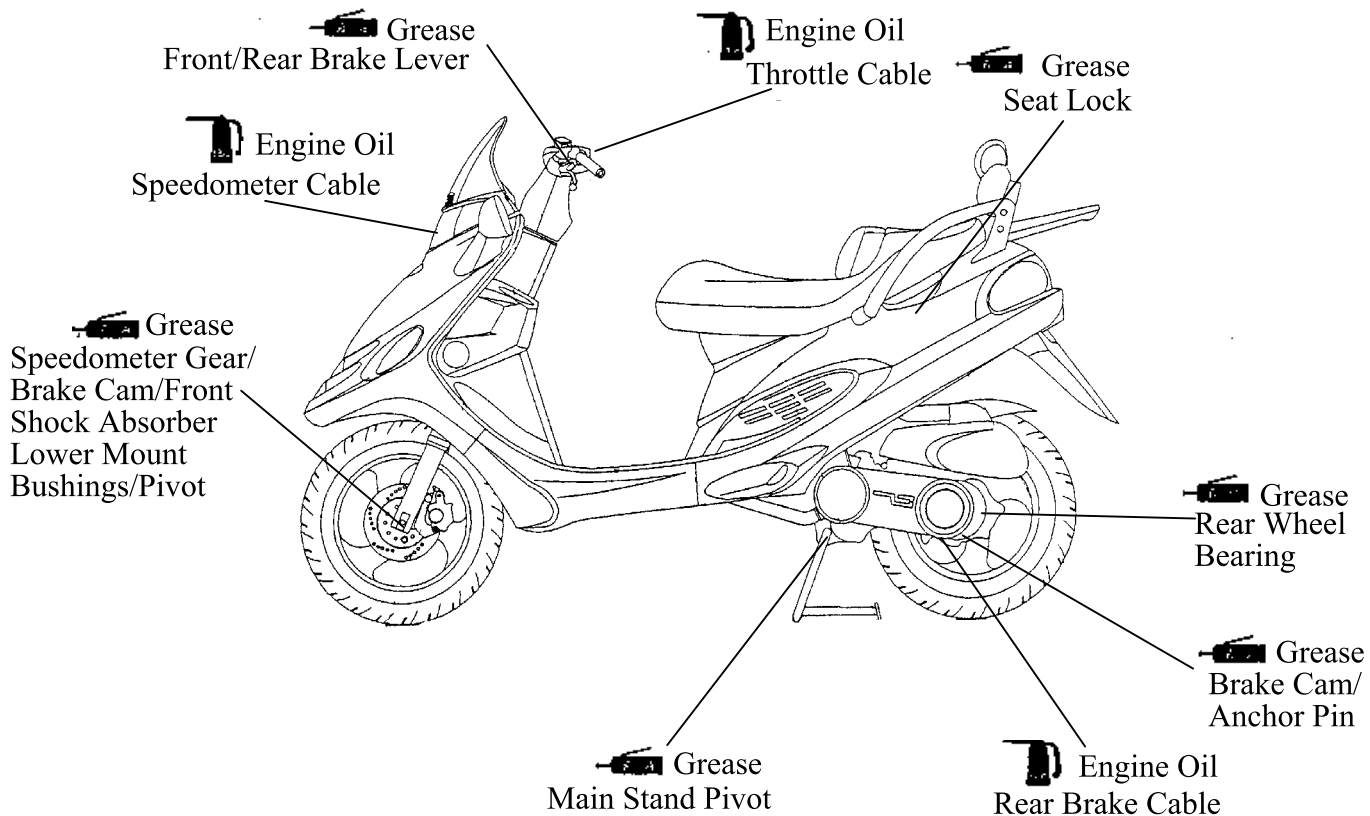

# 1. GENERAL INFORMATION

---

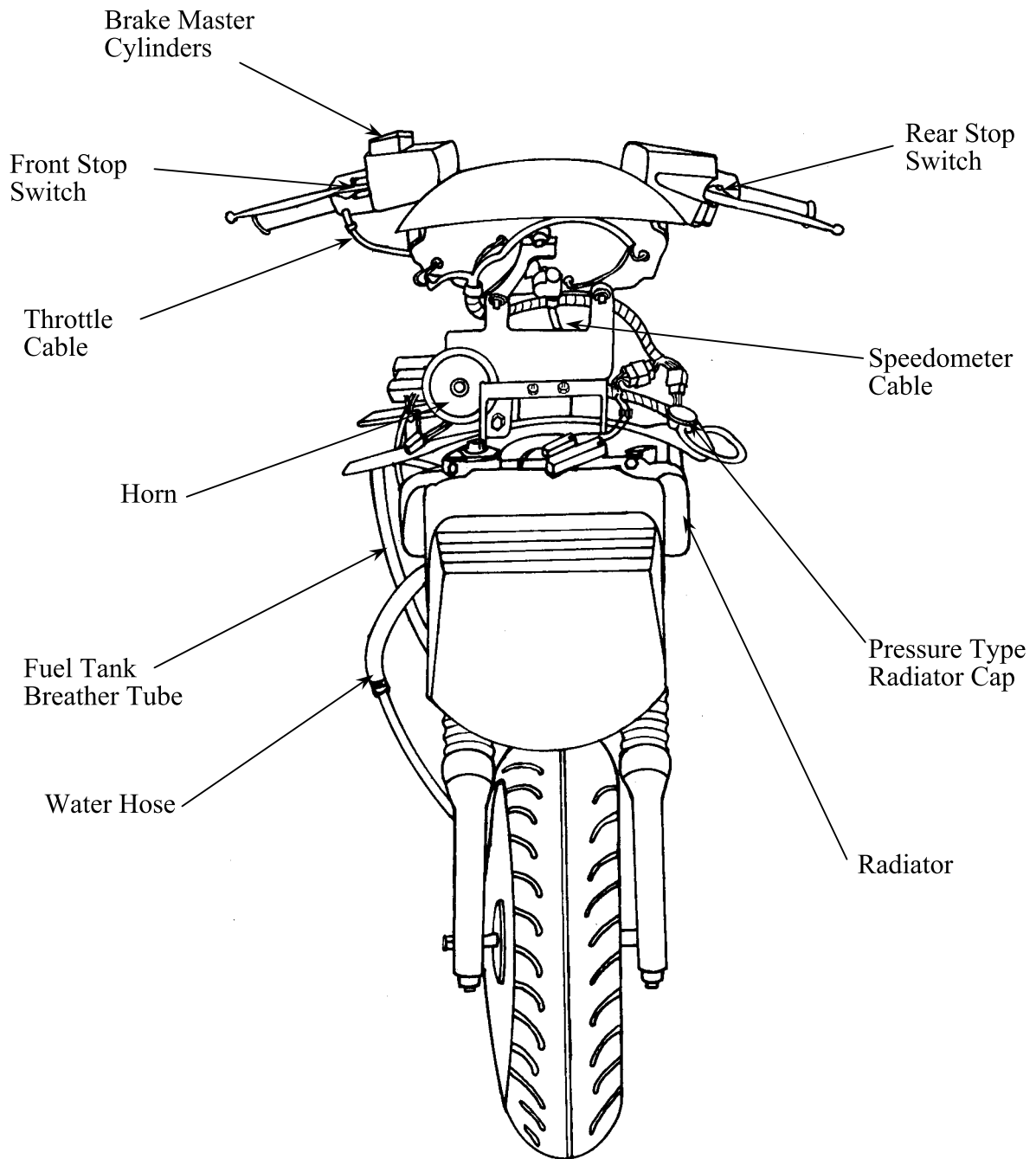

# 1. GENERAL INFORMATION

---

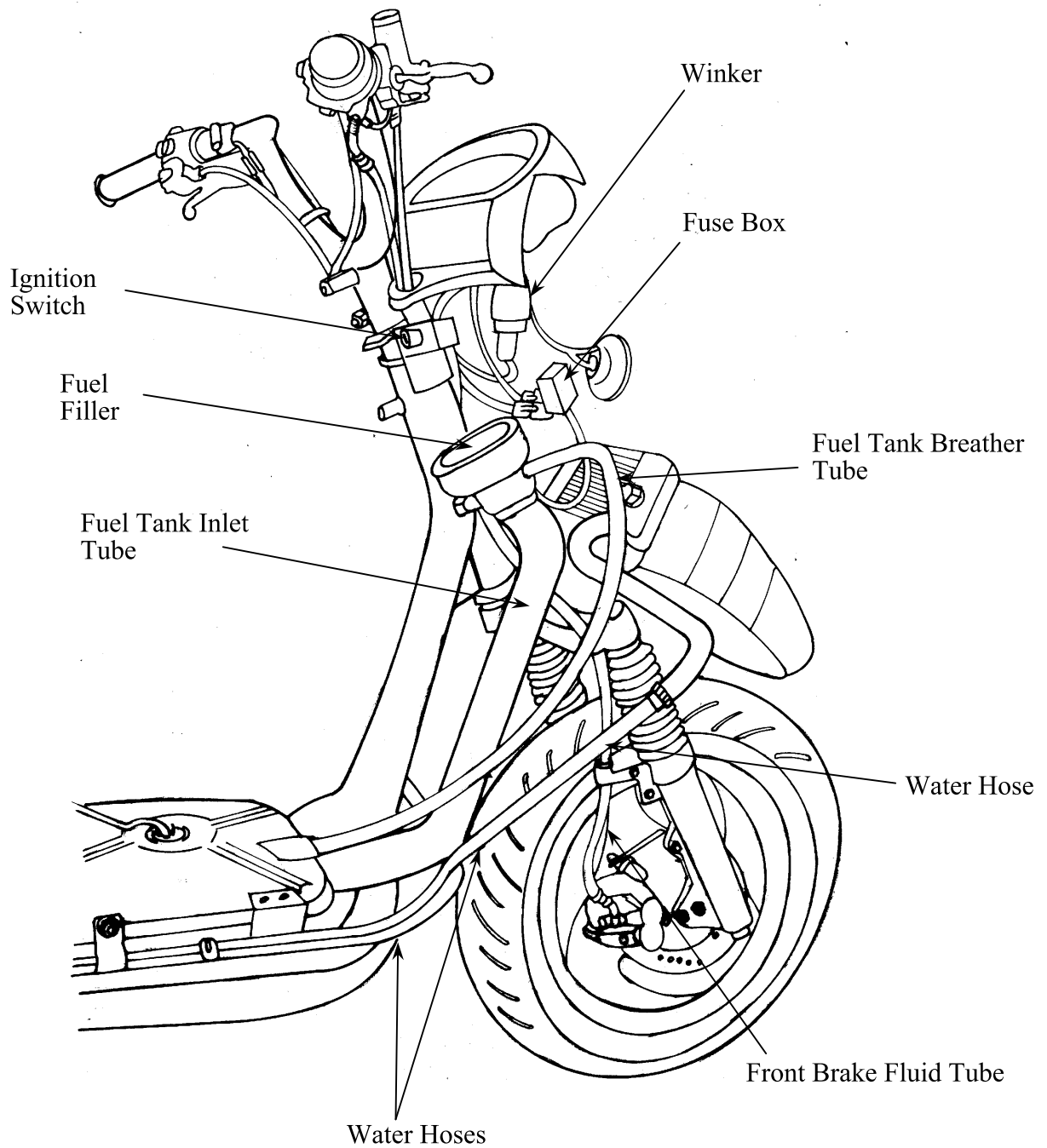



# 1. GENERAL INFORMATION

---

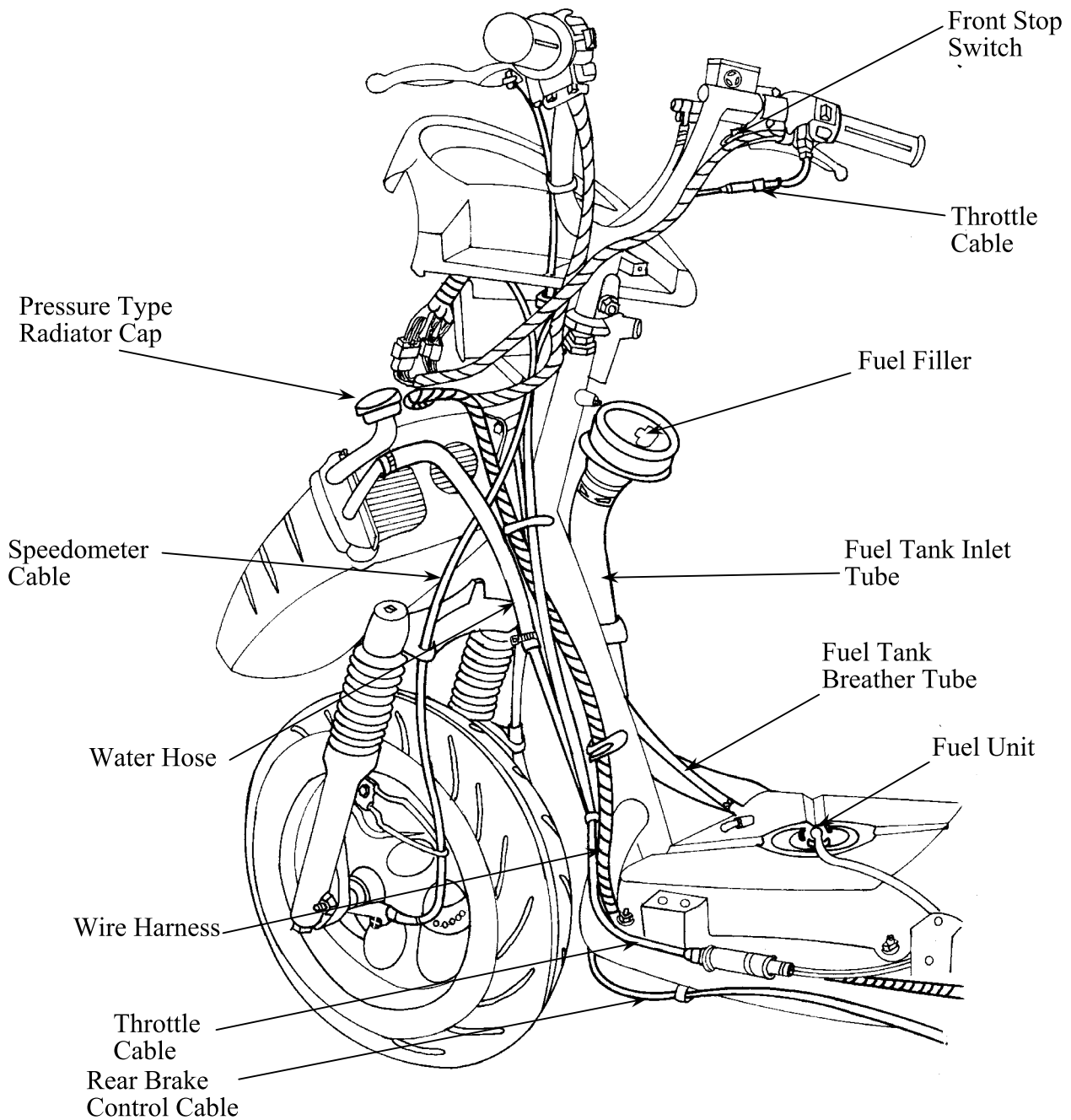

# 1. GENERAL INFORMATION

---

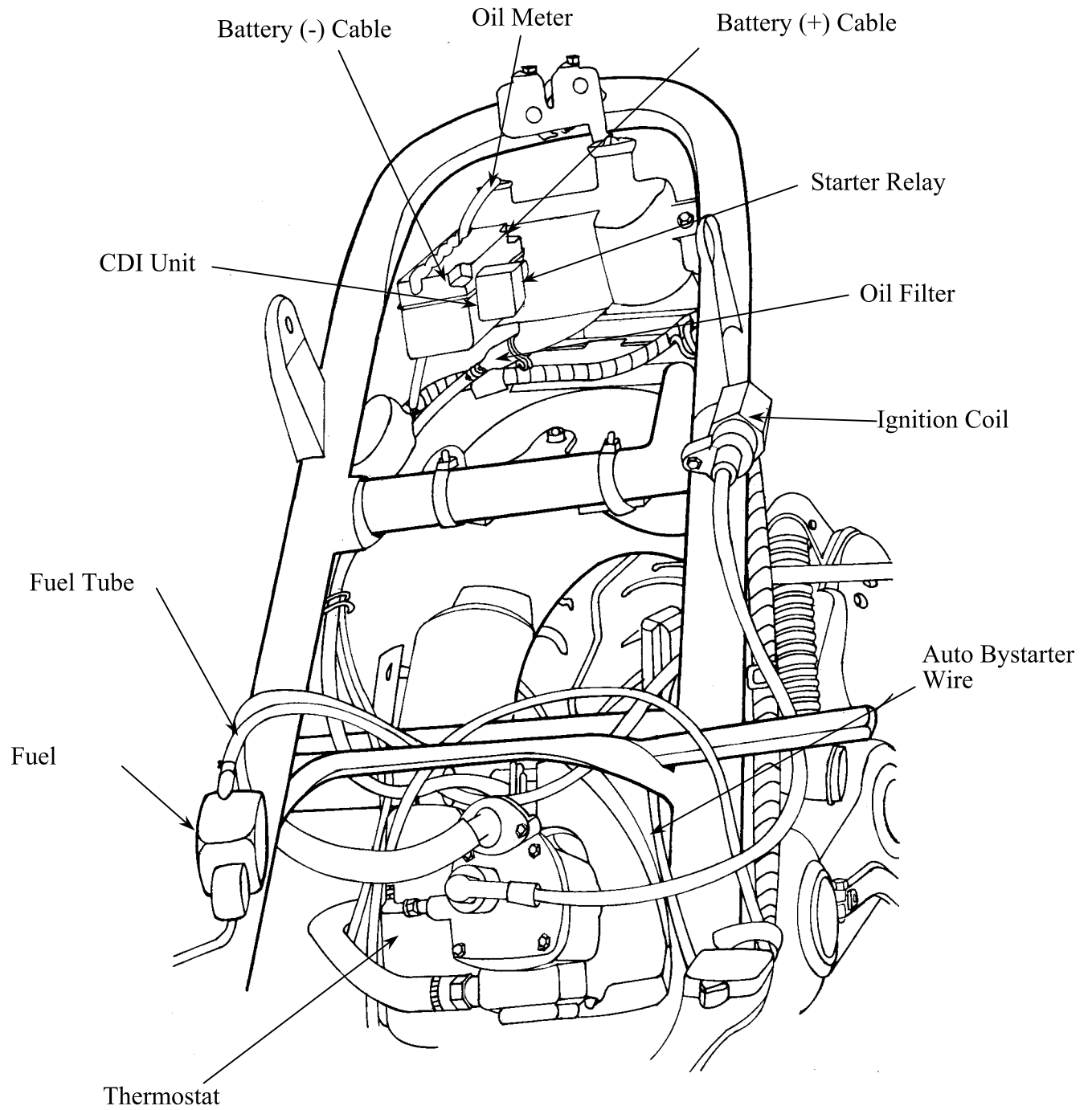

# 1. GENERAL INFORMATION

---

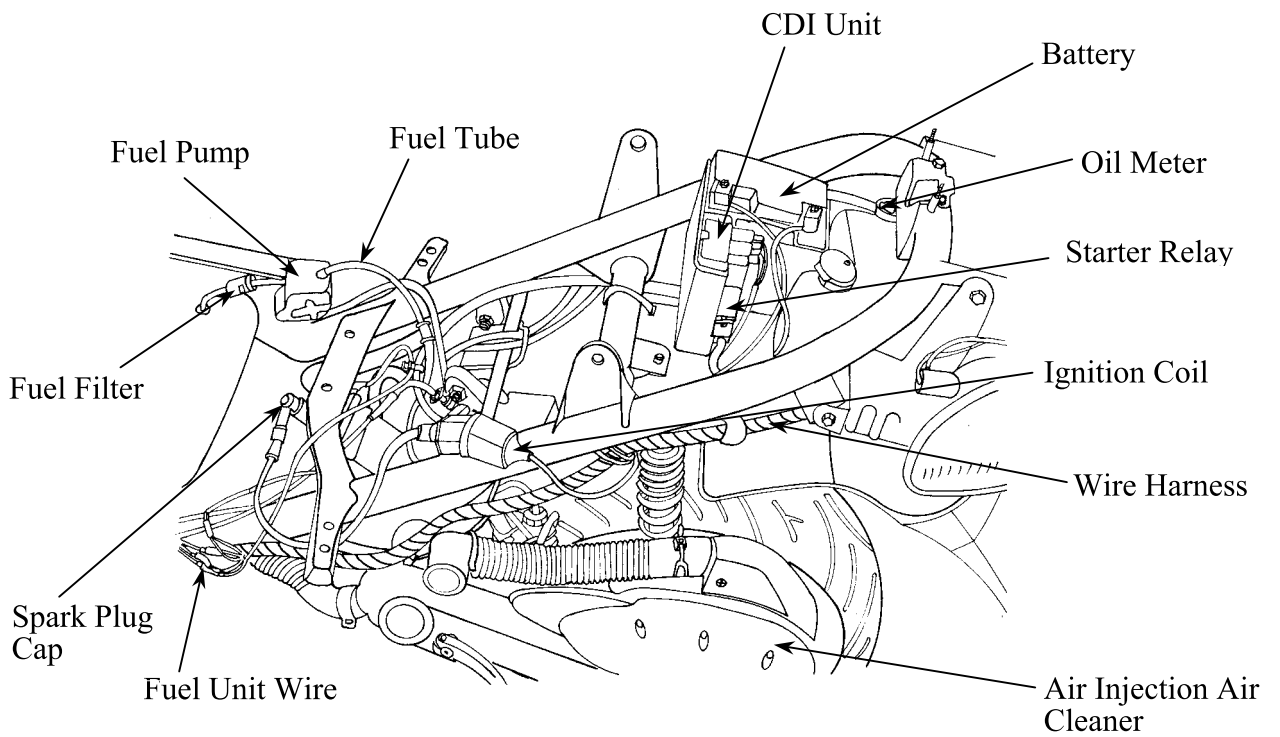
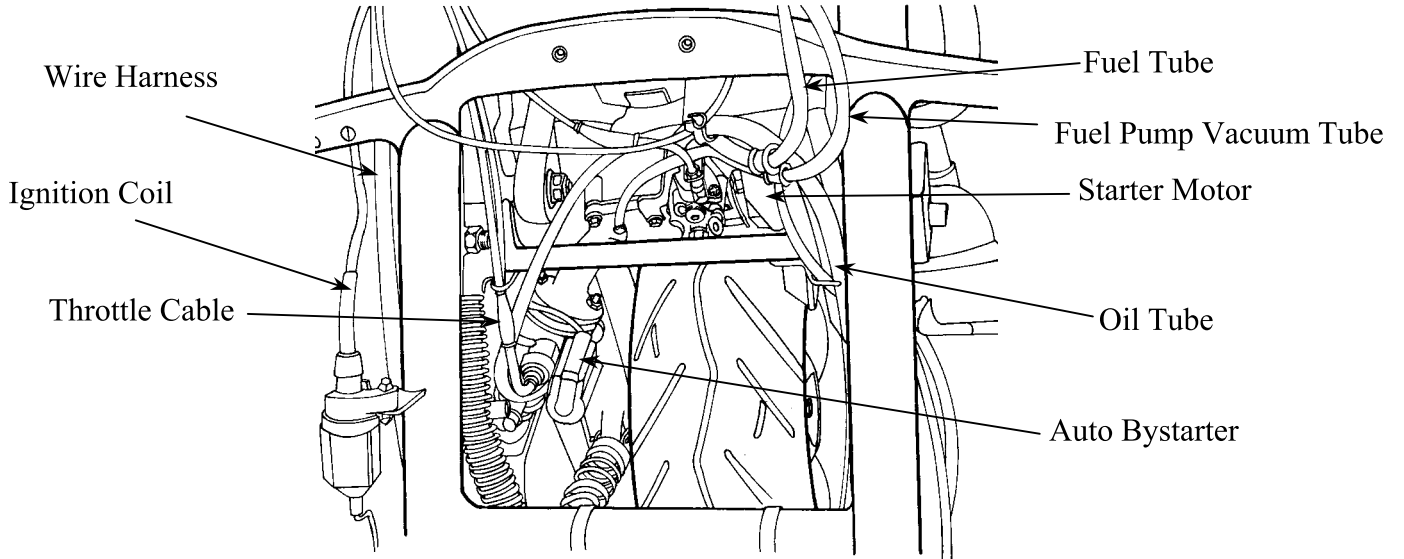

# 1. GENERAL INFORMATION

## WIRING DIAGRAM (SH10AA)

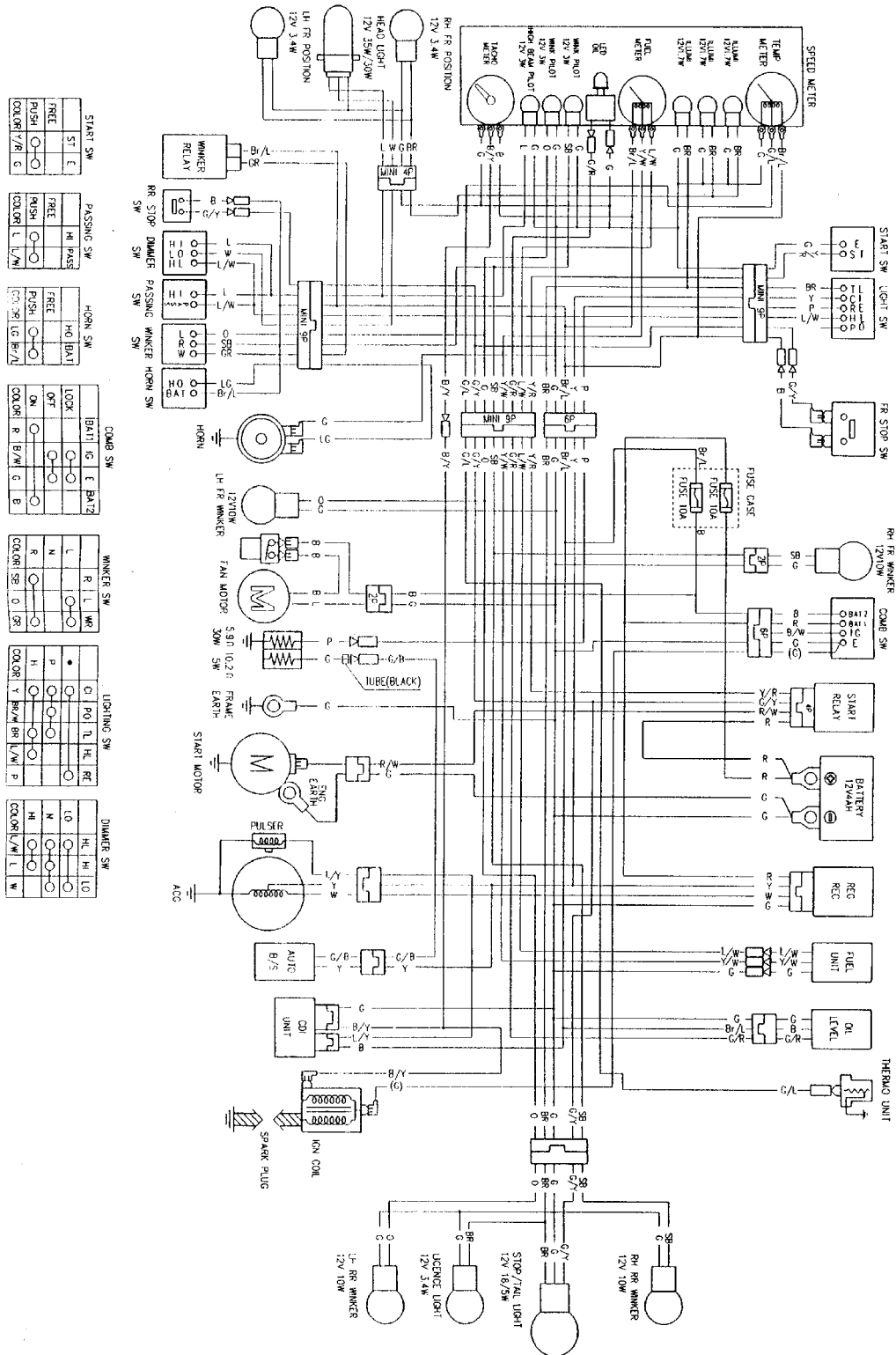

# 1. GENERAL INFORMATION

## WIRING DIAGRAM <SH10BA>

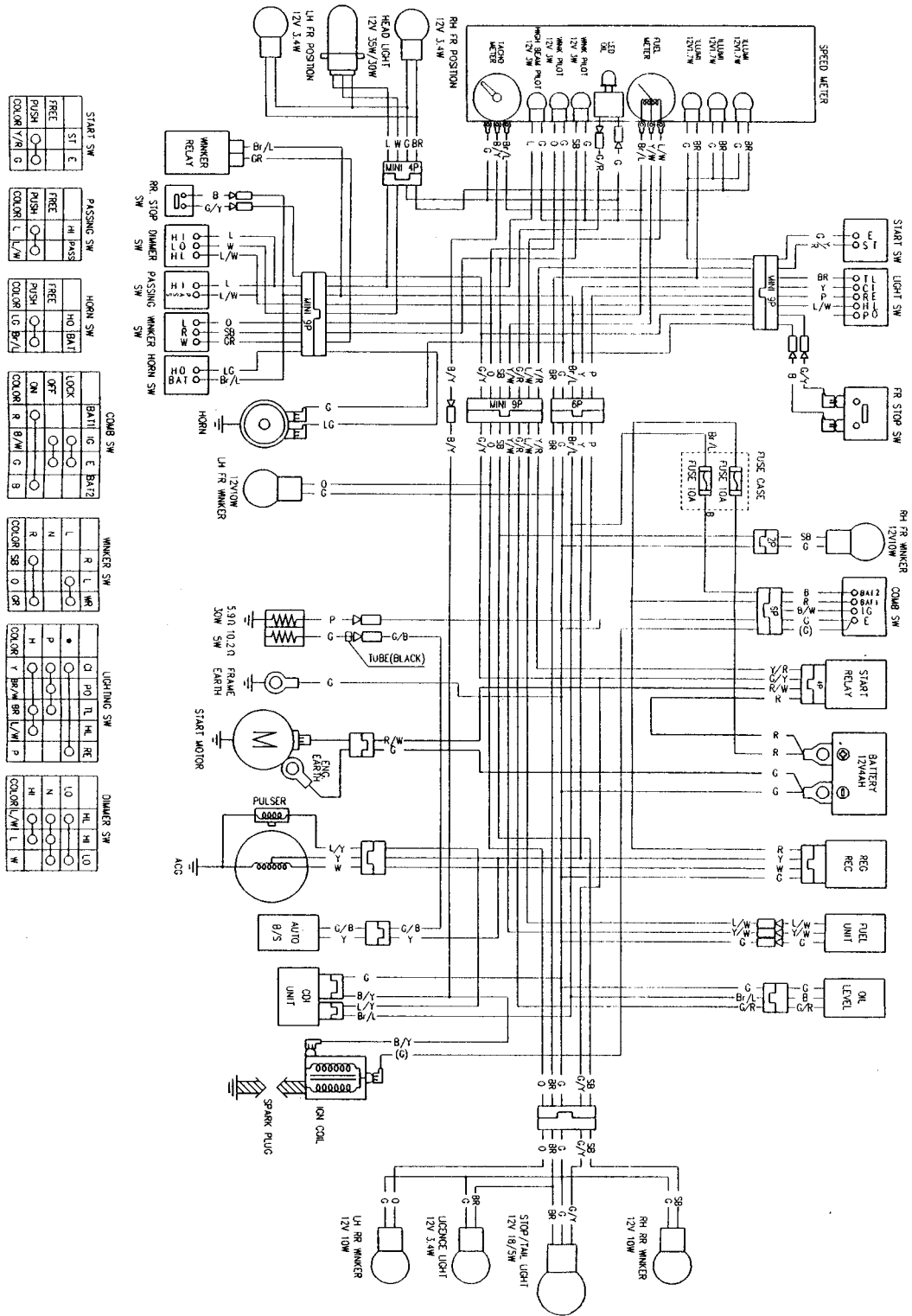

# 1. GENERAL INFORMATION

## TROUBLESHOOTING

### ENGINE WILL NOT START OR IS HARD TO START

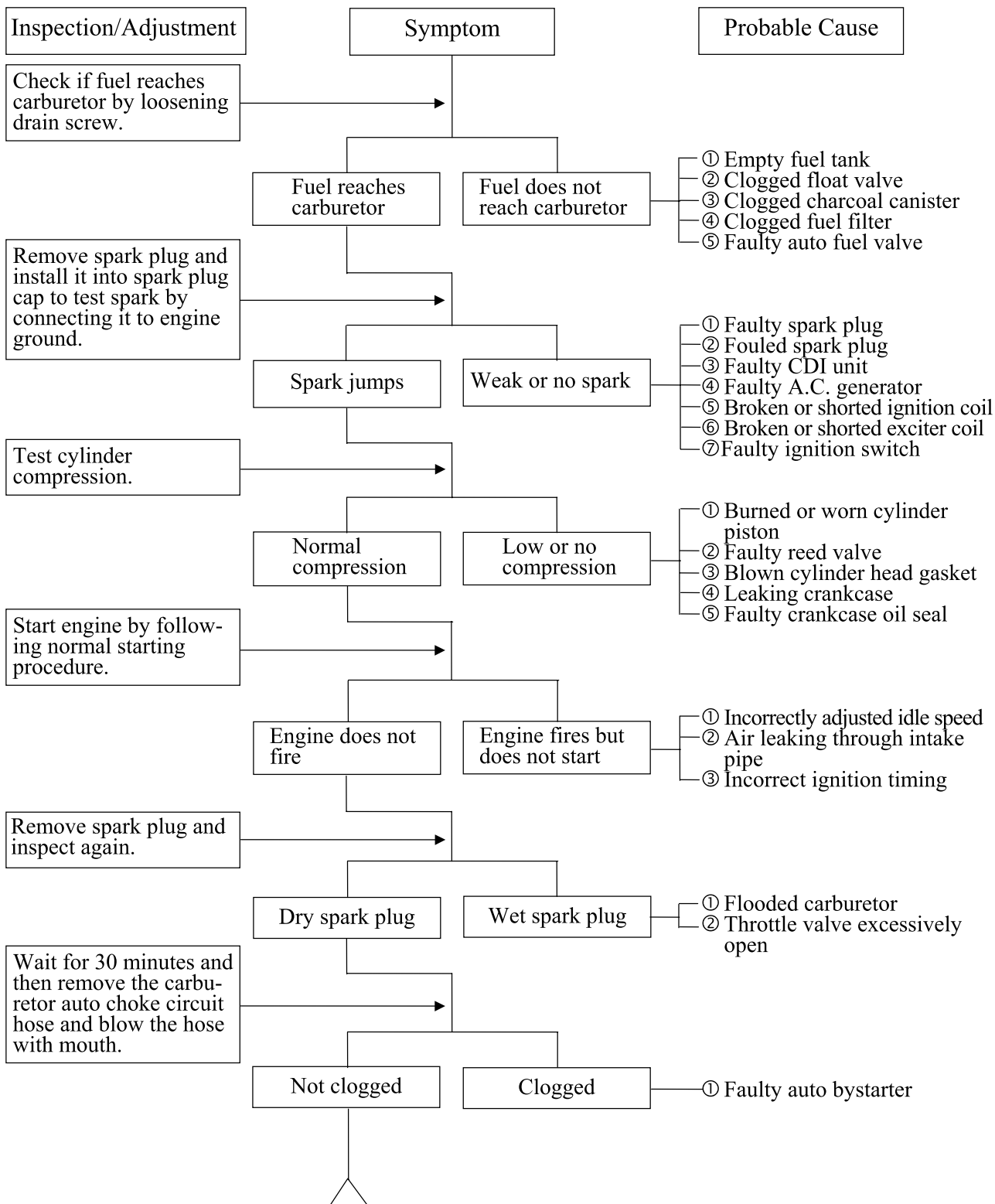

# 1. GENERAL INFORMATION

## ENGINE STOPS IMMEDIATELY AFTER IT STARTS

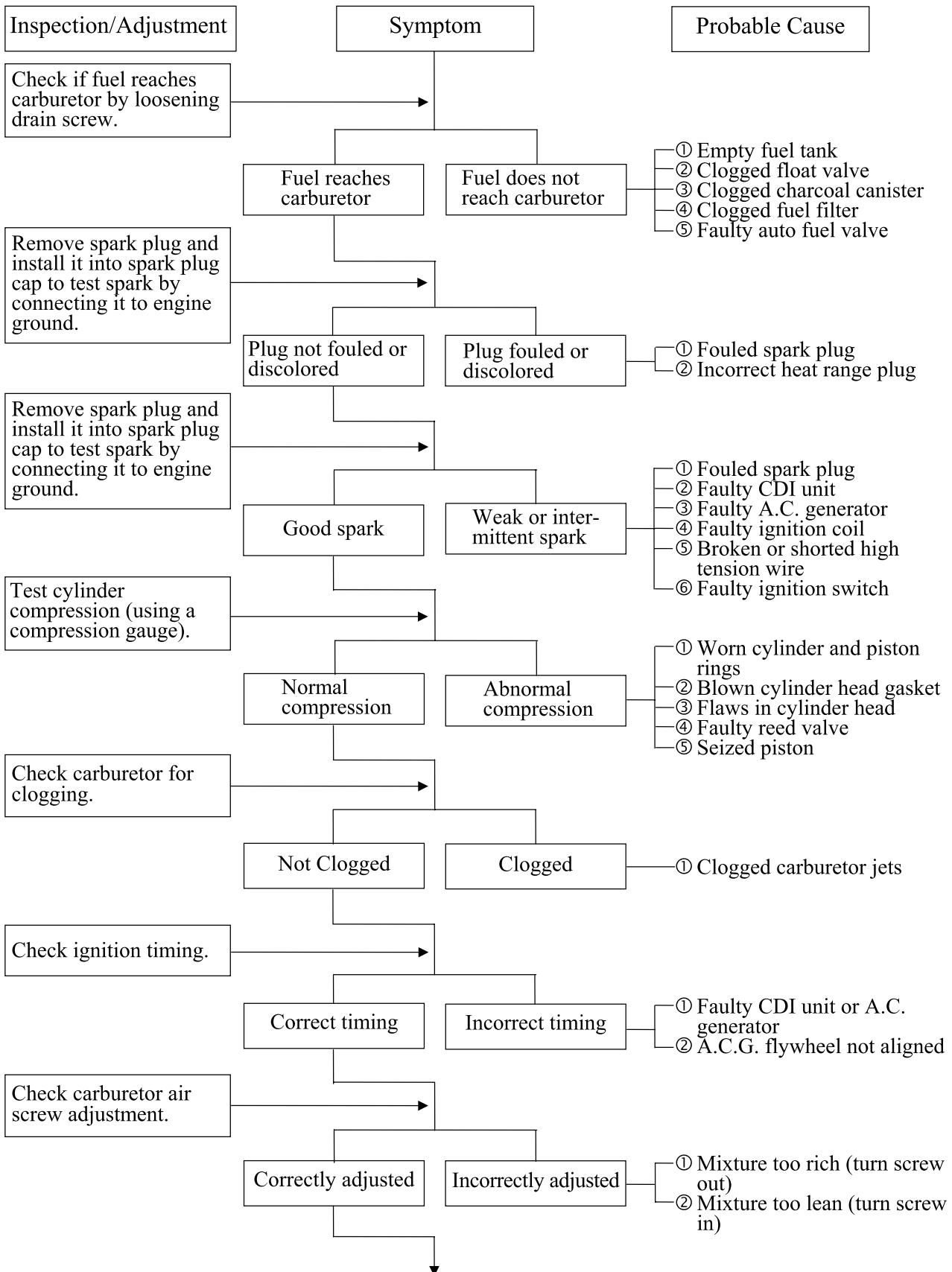

# 1. GENERAL INFORMATION

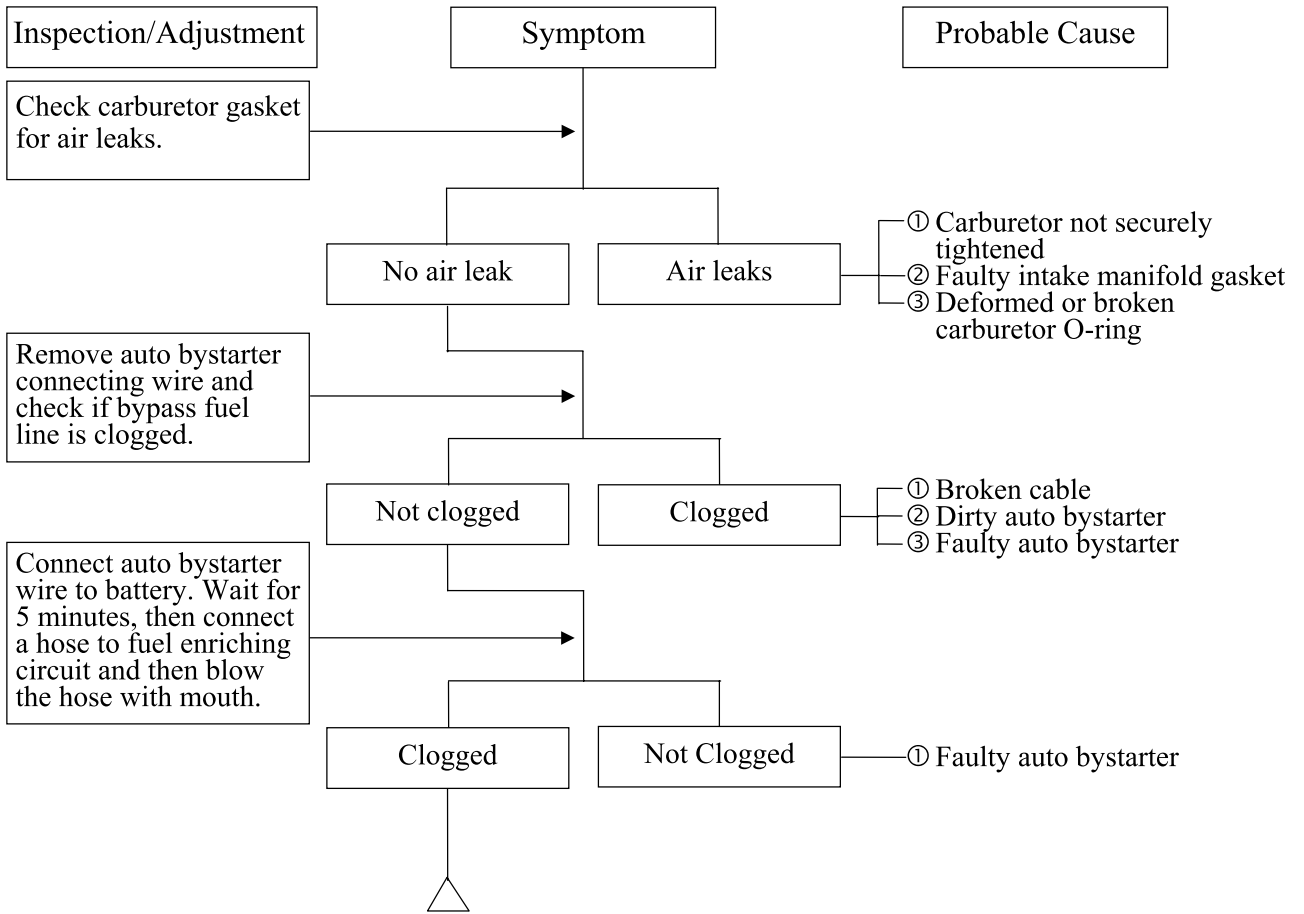



# 1. GENERAL INFORMATION

## ENGINE LACKS POWER

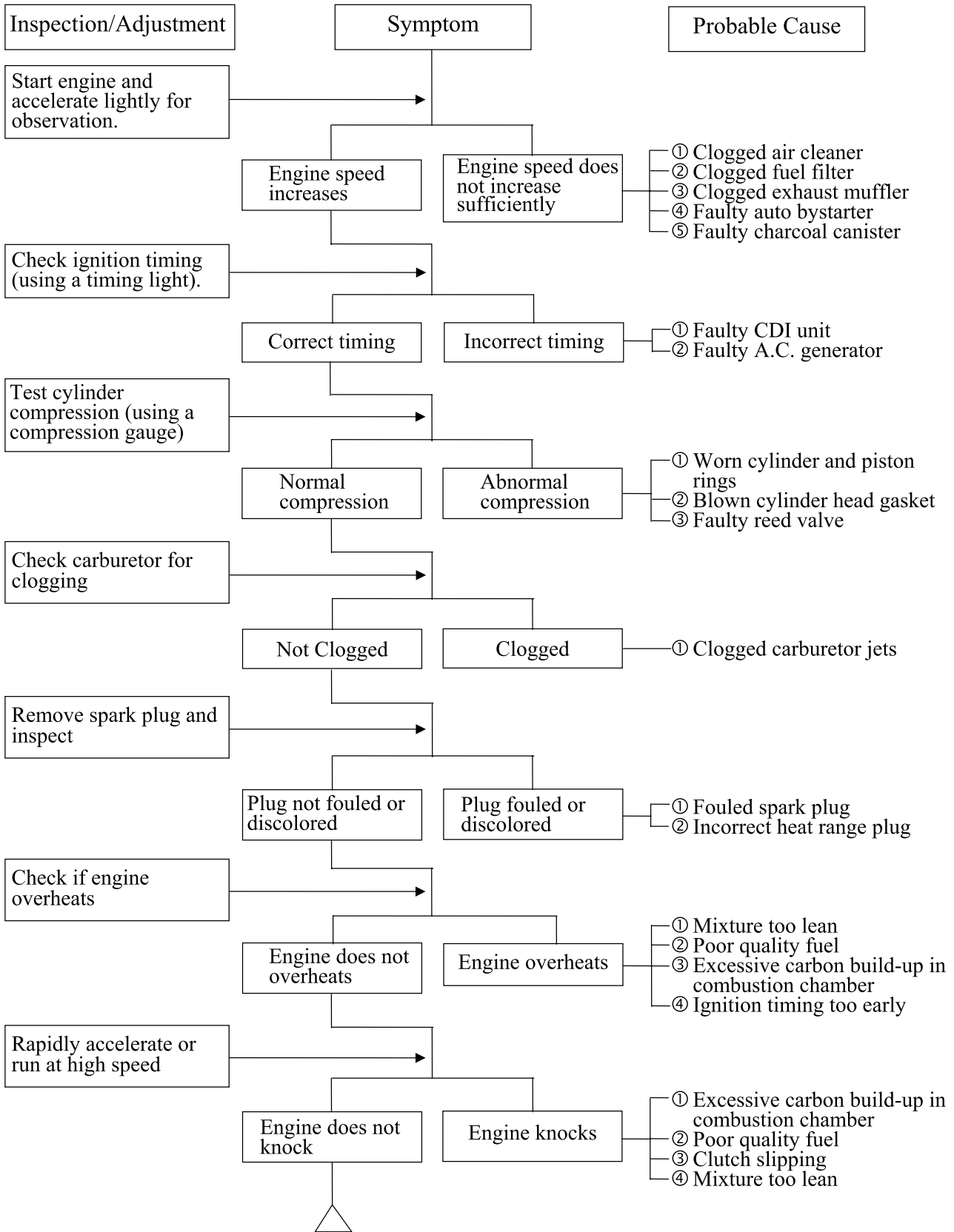

# 1. GENERAL INFORMATION

## POOR PERFORMANCE (ESPECIALLY AT IDLE AND LOW SPEEDS)

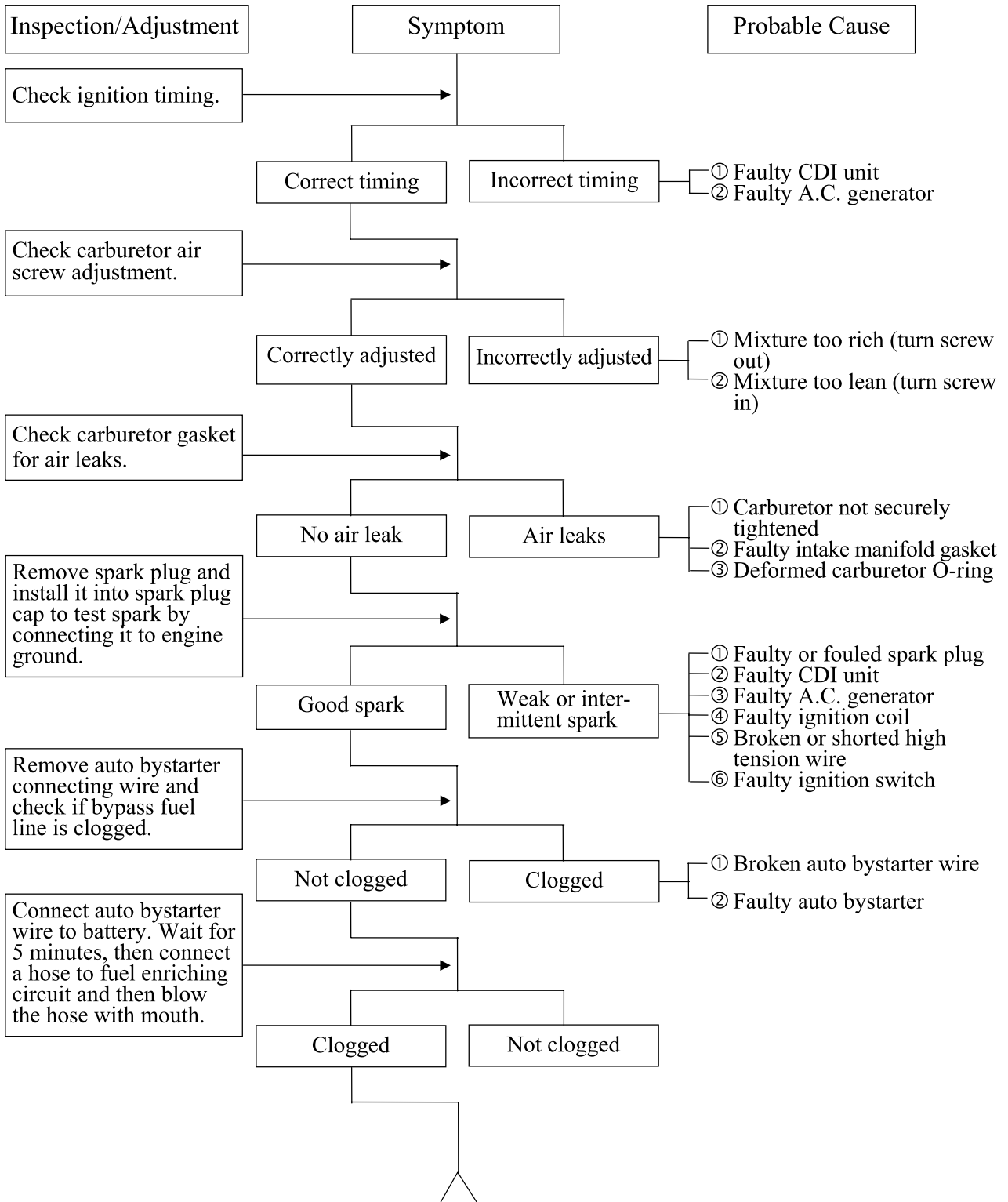

# 1. GENERAL INFORMATION

## POOR PERFORMANCE (AT HIGH SPEED)

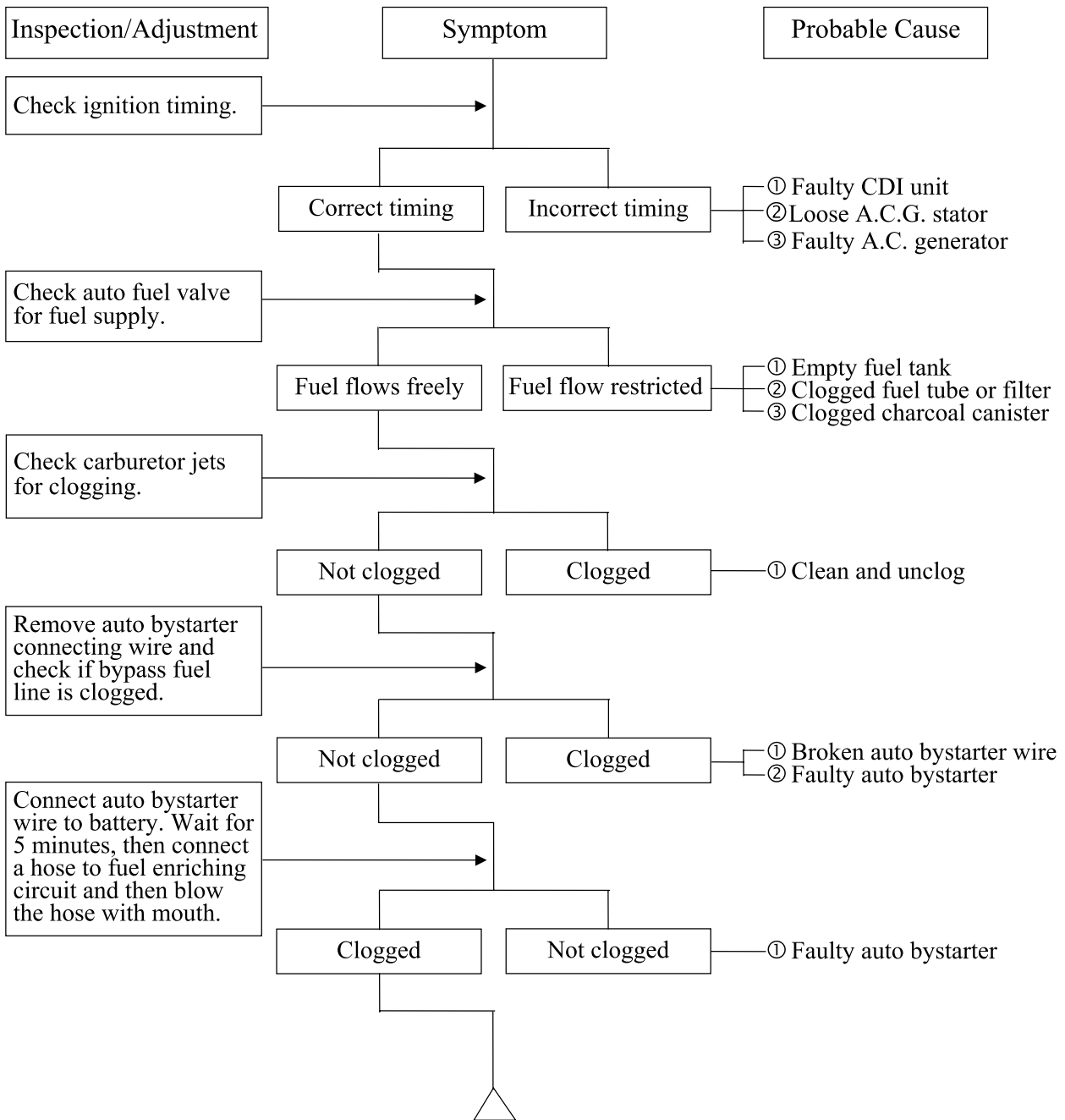

# 1. GENERAL INFORMATION

## CLUTCH, DRIVE AND DRIVEN PULLEYS

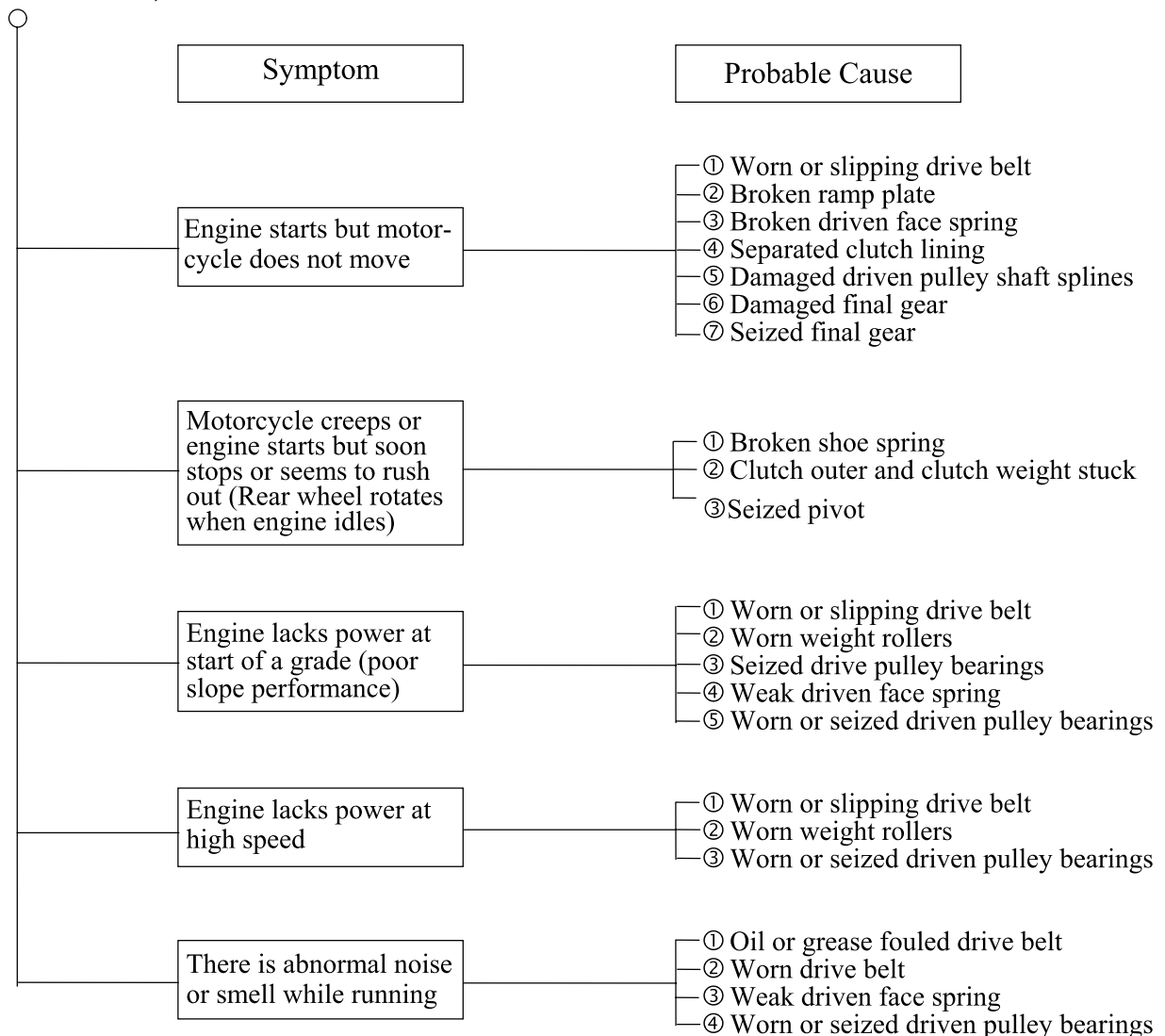

## STEERING HANDLEBAR DOES NOT TRACK STRAIGHT

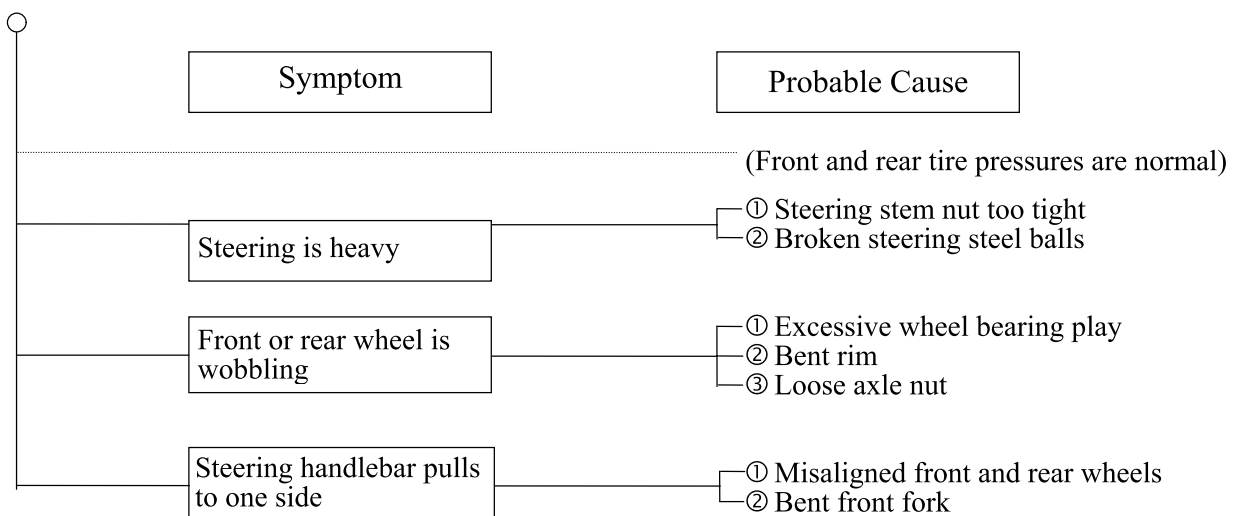

# 1. GENERAL INFORMATION

## POOR SUSPENSION PERFORMANCE

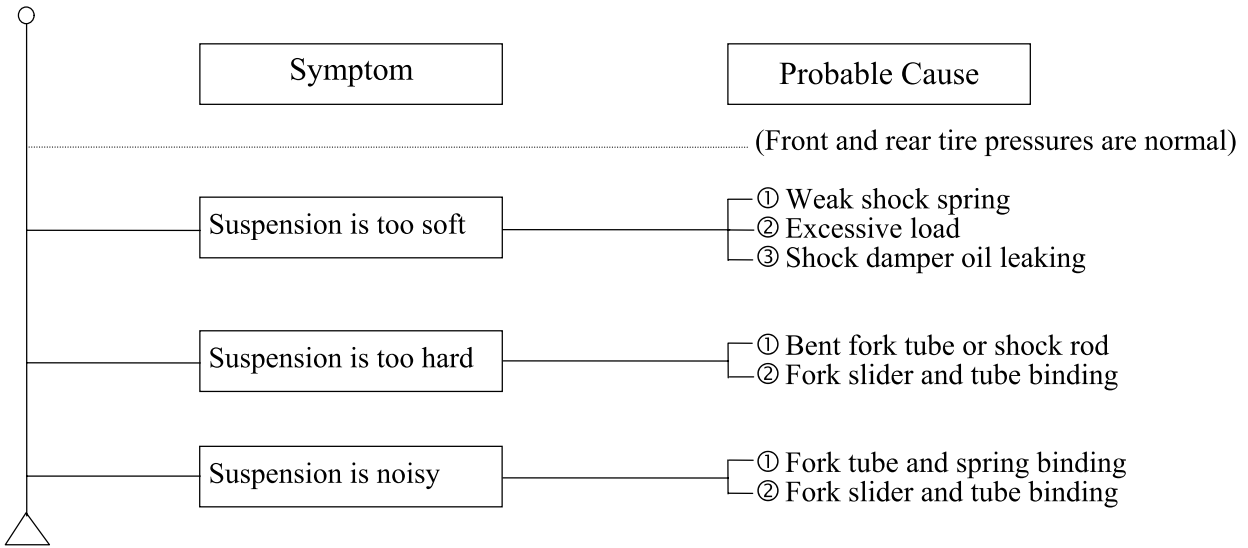

## POOR BRAKE PERFORMANCE

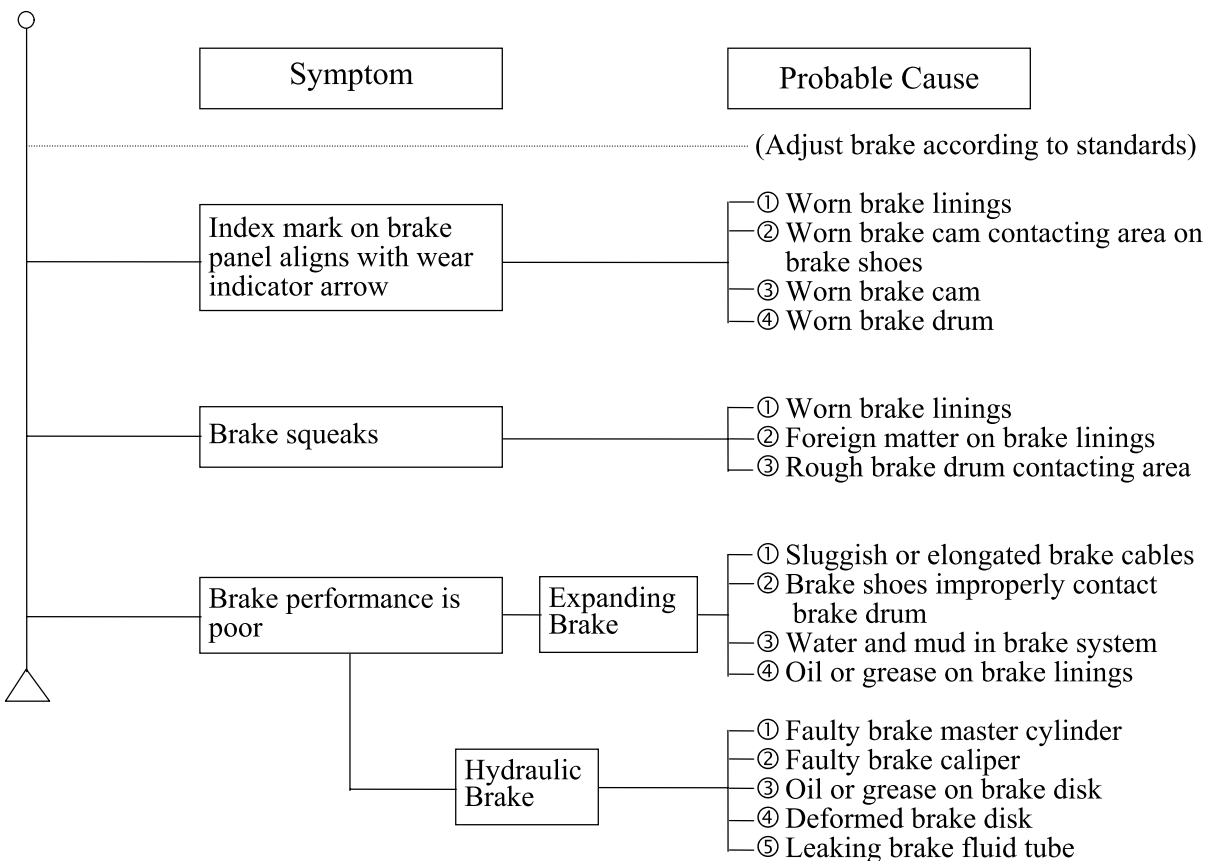

# 1. GENERAL INFORMATION

## OIL METER

1. Motor oil indicator light does not come on when there is no motor oil (Ignition switch ON)

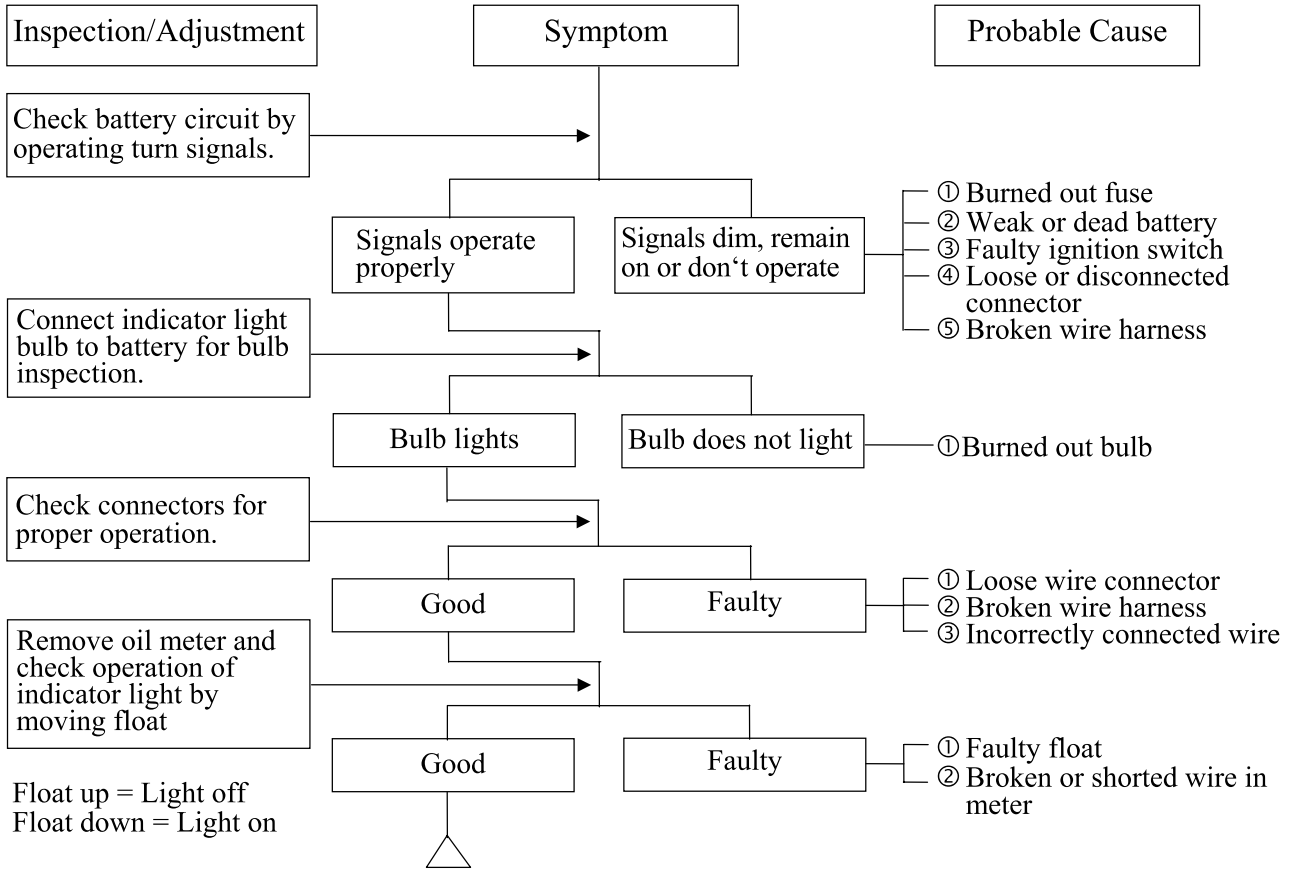

2. Motor oil is sufficient but the indicator light remains on (Ignition switch ON)

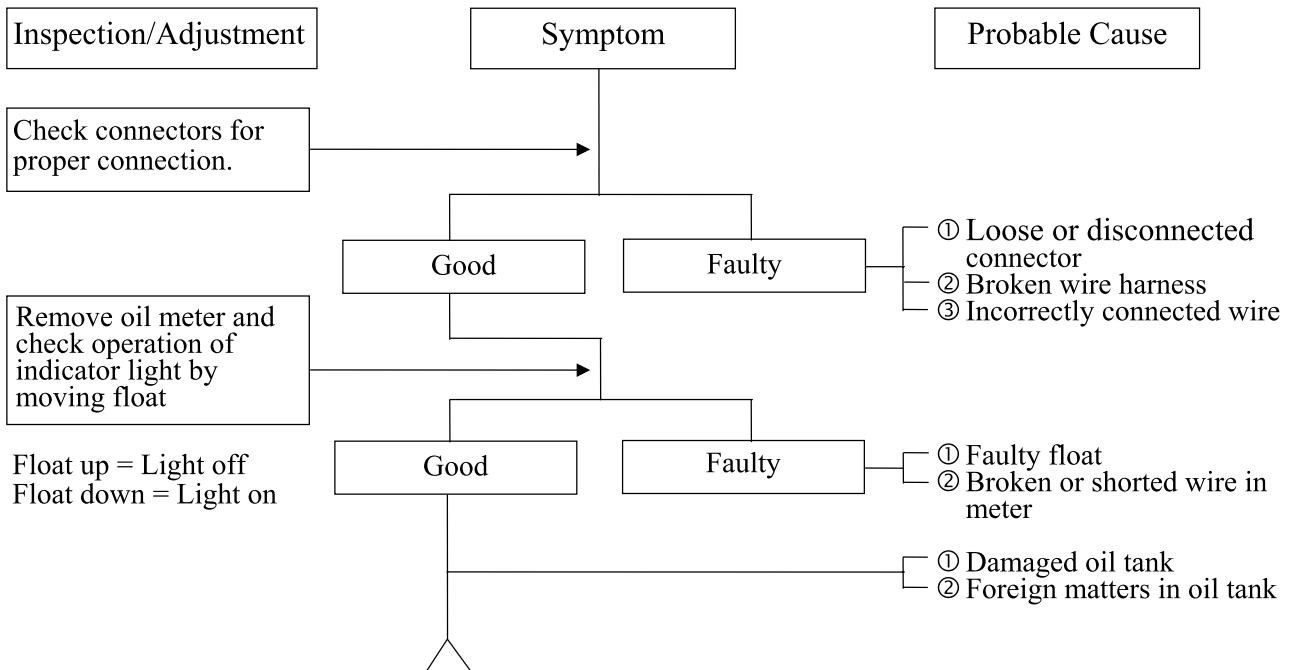

# 1. GENERAL INFORMATION

## FUEL GAUGE

### 1. Pointer does not register correctly (Ignition switch ON)

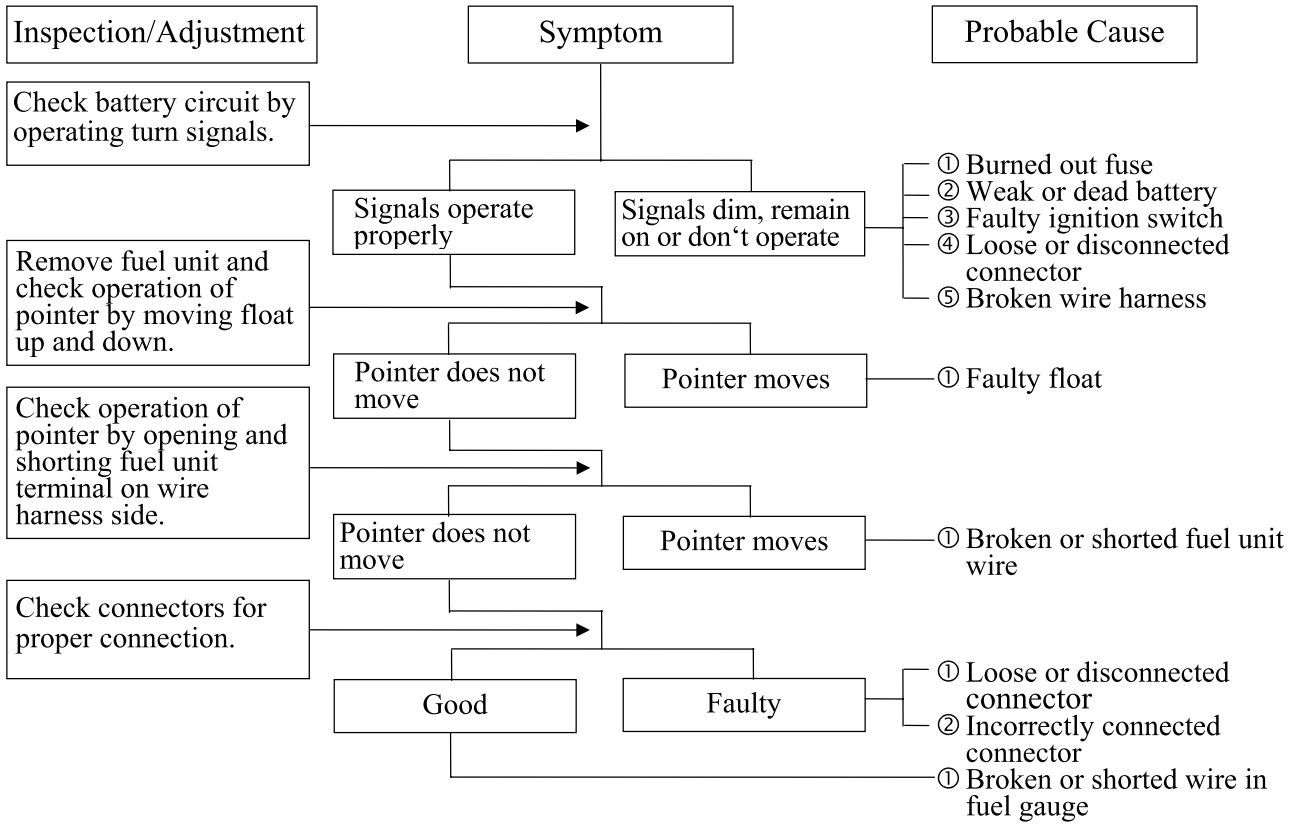

### 2. Pointer fluctuates or swings (Ignition switch ON)

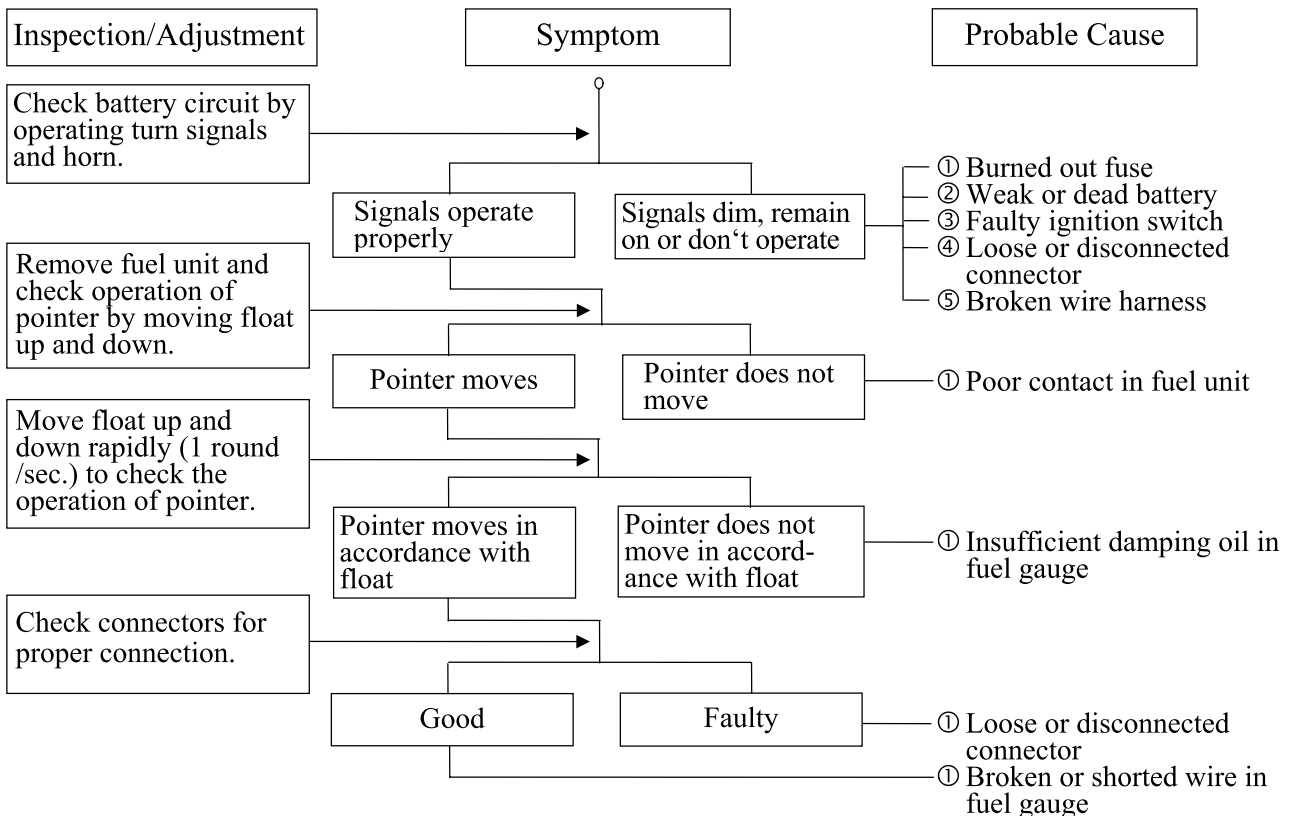

# 1. GENERAL INFORMATION

## STARTER MOTOR

### 1. Starter motor won't turn

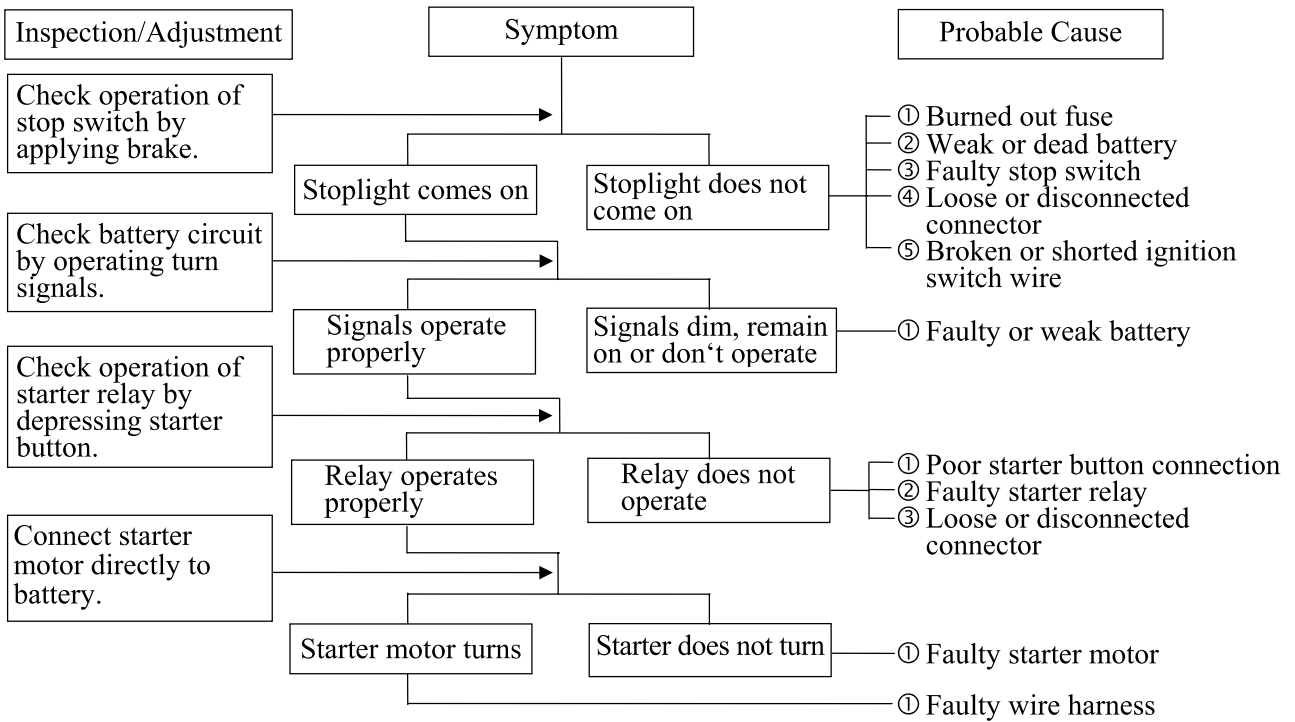

### 2. Starter motor turns slowly or idles

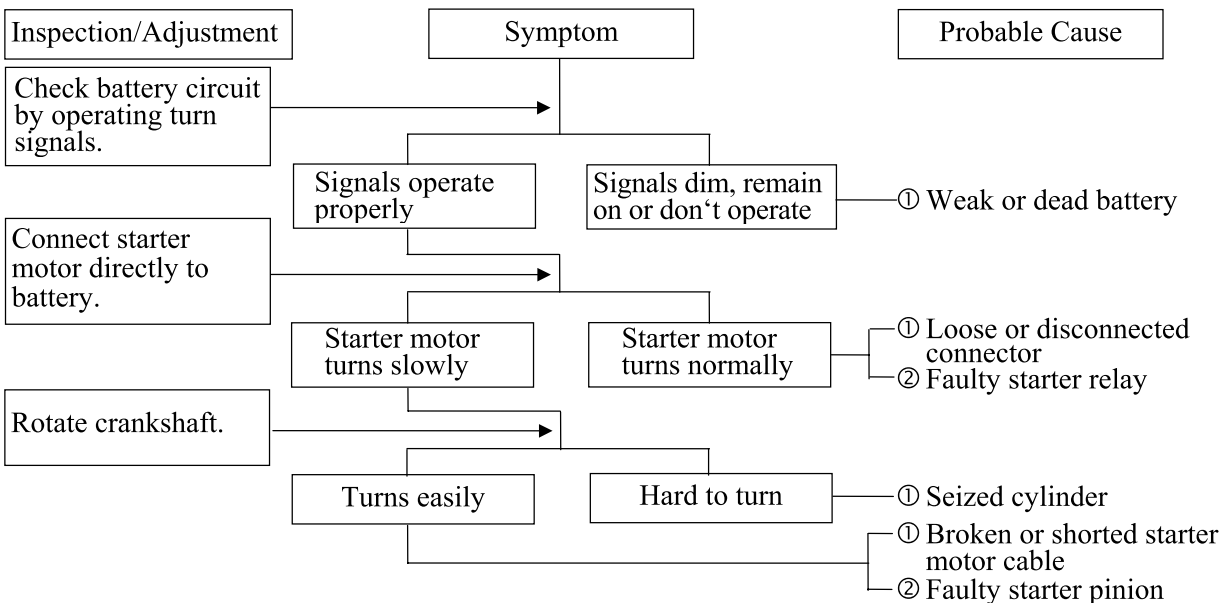

### 3. Starter motor does not stop turning

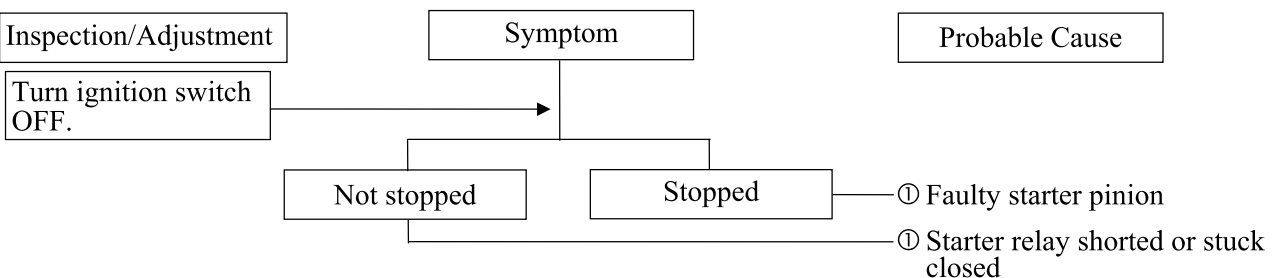



## **2. EXHAUST MUFFLER/FRAME COVERS**

---

**2**

---

### **EXHAUST MUFFLER/FRAME COVERS**

---

SCHEMATIC DRAWING -----	2-1
SERVICE INFORMATION-----	2-2
TROUBLESHOOTING-----	2-2
FRAME COVERS REMOVAL -----	2-3
EXHAUST MUFFLER REMOVAL-----	2-6

## 2. EXHAUST MUFFLER/FRAME COVERS

---

### SCHEMATIC DRAWING

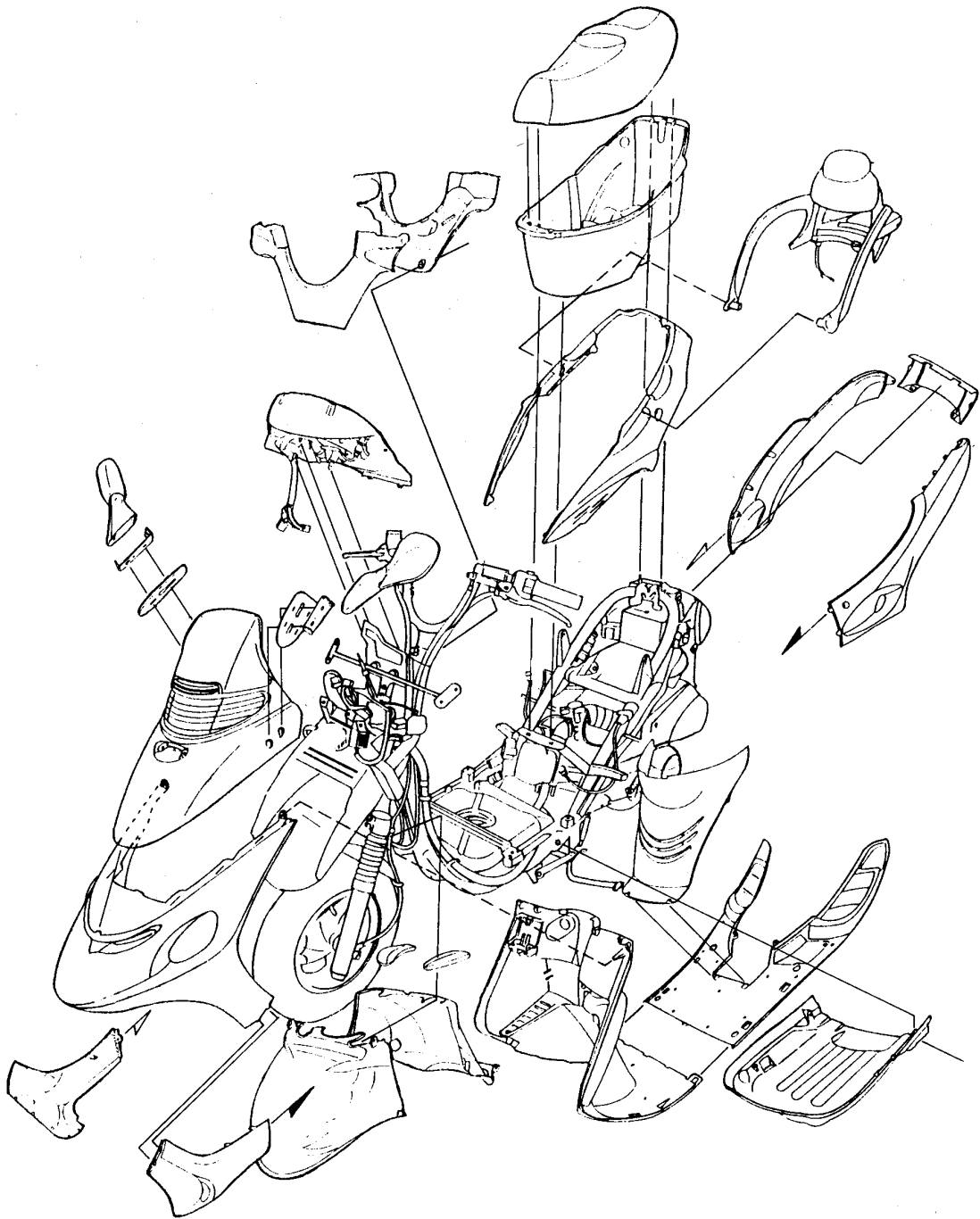

## **2. EXHAUST MUFFLER/FRAME COVERS**

---

### **SERVICE INFORMATION**

#### **GENERAL INSTRUCTIONS**

- When removing frame covers, use care not to pull them by force because the cover joint claws may be damaged.
- Make sure to route cables and harnesses according to the Cable & Harness Routing.

#### **TORQUE VALUES**

Exhaust muffler lock bolt	3.5kg-m
Exhaust muffler joint lock nut	1.2kg-m

### **TROUBLESHOOTING**

#### **Noisy exhaust muffler**

- Damaged exhaust muffler
- Exhaust muffler joint air leaks

#### **Lack of power**

- Caved exhaust muffler
- Clogged exhaust muffler
- Exhaust muffler air leaks

## 2. EXHAUST MUFFLER/FRAME COVERS

### FRAME COVERS REMOVAL

#### REAR CARRIER & HAND RAIL REMOVAL

Remove the met-in box:  
First remove the two bolts and two nuts attaching the met-in box.  
Remove the bolt attaching the center cover.  
Remove the met-in box.

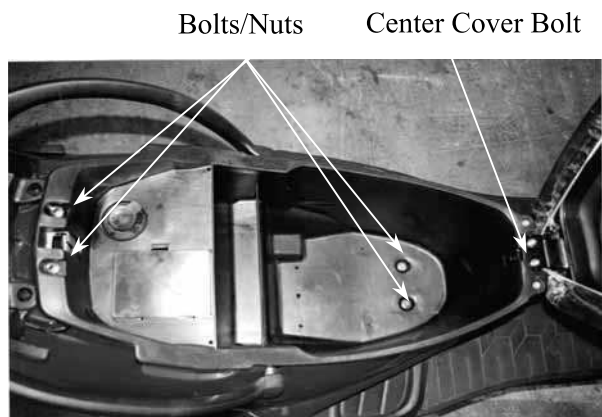

Remove the hand rail right and left lock bolts.  
Remove the two hex bolts and one stay bolt attaching the rear carrier.  
Disconnect the two stoplight wire connector on the rear carrier.  
Remove the rear carrier and hand rail.

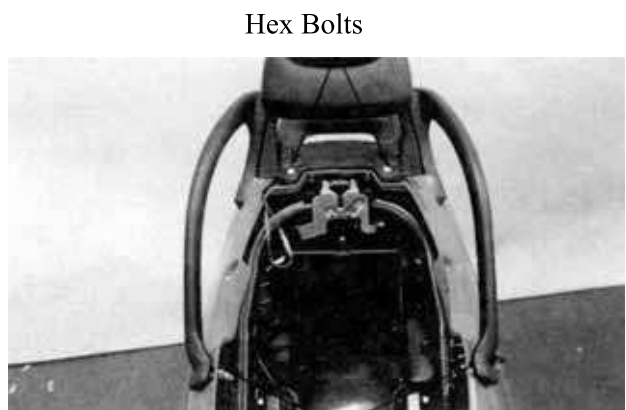

#### FRAME BODY COVER REMOVAL

Remove the two screws on the bottom of the center cover.  
Remove the center cover.  
Remove the two screws attaching the front part of the frame body cover.

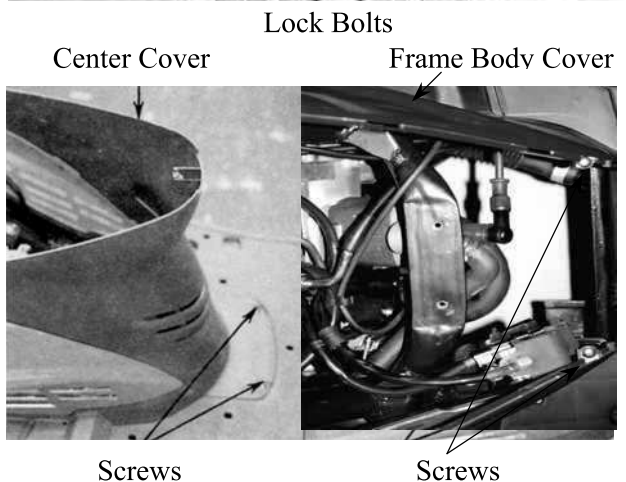

Remove the two screws attaching the rear protective cover.  
Remove the rear protective cover.  
Remove the two screws attaching the rear ends of the right and left side rails.

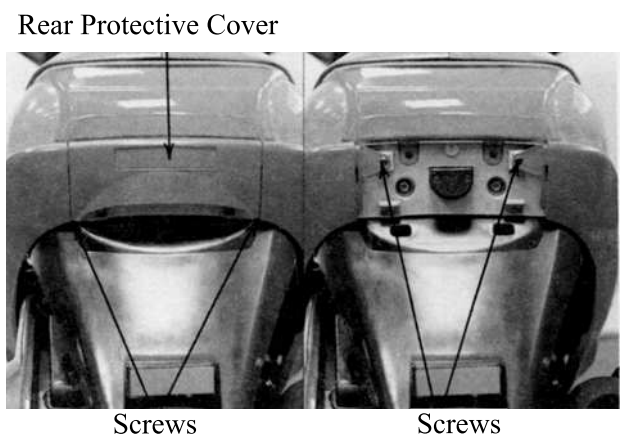

## 2. EXHAUST MUFFLER/FRAME COVERS

Remove the screws attaching the right and left side covers.  
Remove the right and left side covers by pulling them backward.



Screws      Side Cover

Seat Lock Wire

Remove the right and left screws on the rear part of the frame body cover.  
Disconnect the seat lock wire.  
Remove the frame body cover.



Screw

### FLOOR BOARD REMOVAL

Remove the floor mat.  
Remove the center cover. (⇒2-3)  
Remove the ten screws and two bolts attaching the front right and left side covers.  
Remove the two bottom cover adjusting screws.  
Remove the front right and left side covers.

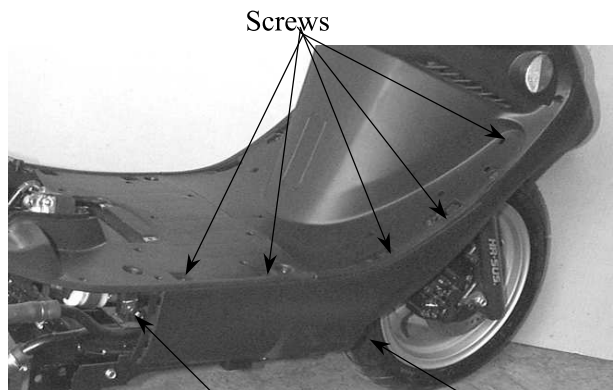

Screws

Screw

Adjusting Screws

Remove the six bolts attaching the floor board.  
Remove the floor board .  
The installation sequence is the reverse of removal.

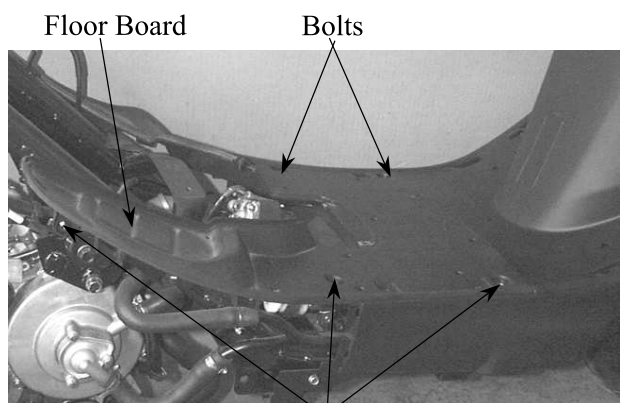

Floor Board

Bolts

Bolts

## 2. EXHAUST MUFFLER/FRAME COVERS

---

### FRONT UPPER COVER REMOVAL

Remove the right and left rearview mirrors.  
Remove the two screws on the back of the front upper cover.  
Remove the two bolts on the front of the front upper cover.  
Disconnect the headlight wire connector.  
Remove the front upper cover.  
The installation sequence is the reverse of removal.



Bolts

Screws

### FRONT LOWER COVER REMOVAL

First remove the front upper cover.  
Remove the two screws attaching the front lower cover.  
Remove the four screws on the back of the front lower cover.  
Disconnect the right/left turn signal light wire connectors.  
Remove the front lower cover.  
The installation sequence is the reverse of removal.

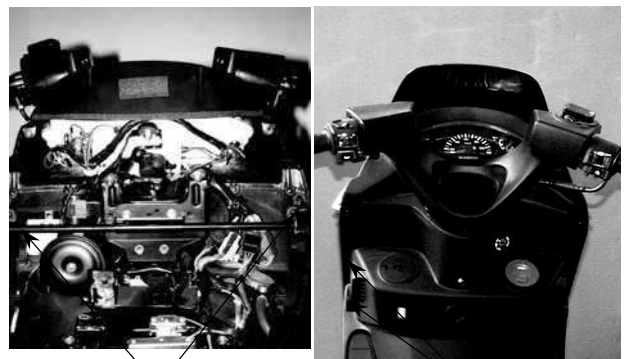

Screws

Screws

### LEG SHIELD REMOVAL

Remove the front upper cover.  
Remove the front lower cover.  
Remove the four screws attaching the leg shield and instruments and remove the fuse box.  
Remove the nut attaching the leg shield.  
Remove the adjusting screw which combines the leg shield with instruments.

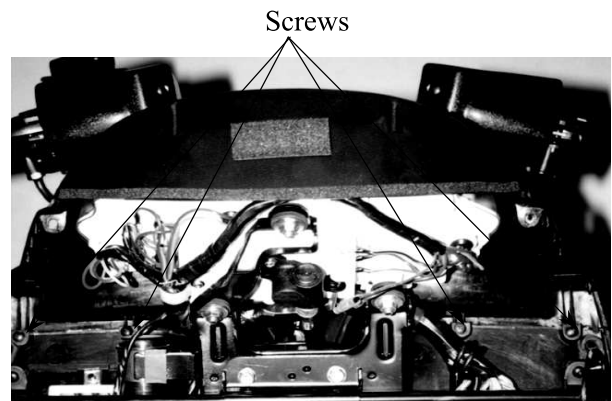

Screws

Remove the leg shield.  
The installation sequence is the reverse of removal.

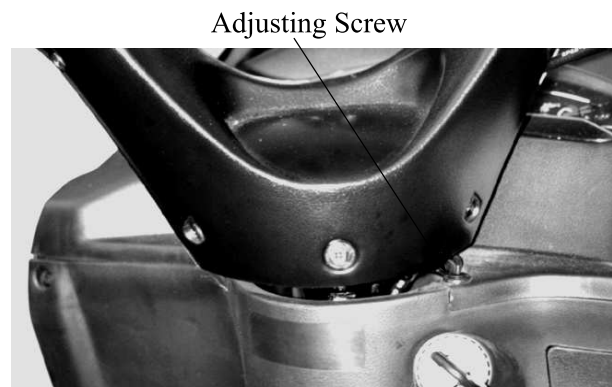

Adjusting Screw

## 2. EXHAUST MUFFLER/FRAME COVERS

### HANDLEBAR COVER REMOVAL

Remove the two screws and one bolt attaching the handlebar rear cover.  
First remove the four screws attaching the handlebar front cover.  
Remove the handlebar front cover.  
Remove the handlebar rear cover.  
The installation sequence is the reverse of removal.

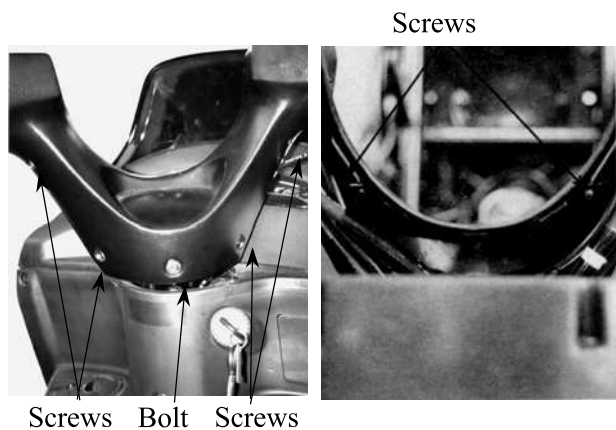

### BOTTOM COVER REMOVAL

Remove the side stand.  
Remove the four bolts attaching the bottom cover.  
Remove the bottom cover.

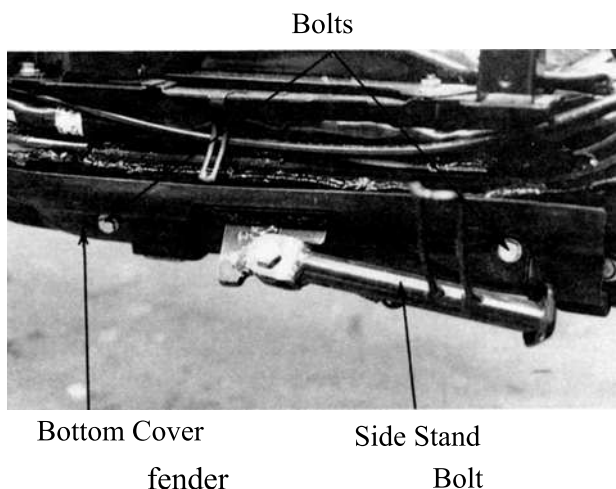

### FRONT INNER FENDER A/B REMOVAL

Remove the front upper cover. (⇒2-5)  
Remove the front lower cover. (⇒2-5)  
Remove the screws which combines inner fender A with inner fender B.  
Remove the two bolts attaching the inner fender A.  
Separate inner fenders A and B.  
The installation sequence is the reverse of removal.

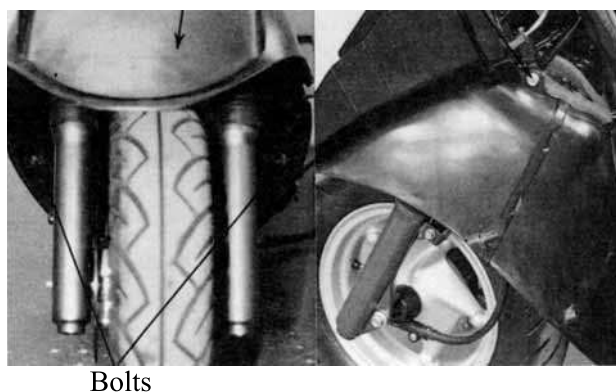

### EXHAUST MUFFLER REMOVAL

Remove the two exhaust muffler joint lock nuts.  
Remove the two exhaust muffler lock bolts to remove the exhaust muffler.  
Remove the exhaust muffler joint packing collar.  
The installation sequence is the reverse of removal.

#### Torque:

Exhaust muffler joint lock nut: 1.2kg-m  
Exhaust muffler lock bolt: 3.5kg-m

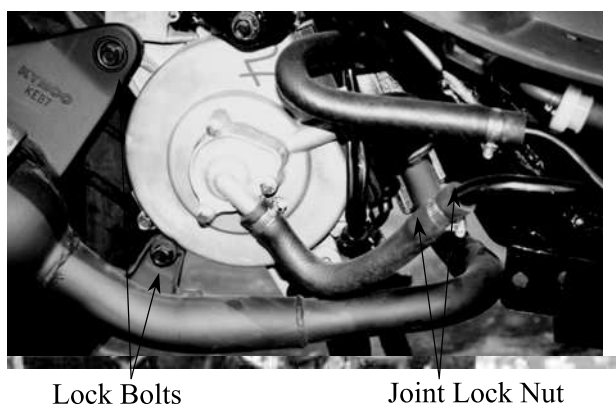

# 3. INSPECTION/ADJUSTMENT

---

---

## INSPECTION/ADJUSTMENT

---

INSPECTION AND MAINTENANCE SCHEDULE.....	3- 1
BRAKE SYSTEM.....	3- 4
MOVING DEVICE .....	3- 6
DAMPING DEVICE.....	3- 7
POWER DRIVE SYSTEM.....	3- 7
ELECTRICAL EQUIPMENT.....	3- 8
ENGINE .....	3- 9
OTHERS.....	3-12



### 3. INSPECTION/ADJUSTMENT

#### INSPECTION AND MAINTENANCE SCHEDULE

(Note) 1. ○ means time for inspection.

2. ☆ means regular replacement for the specified parts.

This inspection and maintenance schedule is based upon average riding conditions. Machines subjected to severe use, or ridden in unusually dusty areas, require more frequent servicing.

Inspection & Maintenance Item			Frequency				Judgment Standards	Remarks								
			Preride	1st month	Every 6 months	Every 12 months										
Suspension	Steering handlebar	Check for looseness and vertical play				○										
		Operating performance	○			○										
		Right/left turning angle				○										
	Front fork	Damage			○	○										
		Check for front fork pivot installation			○	○		Check steering stem								
		Check front fork pivot for looseness and abnormal noise				○		Check steering stem								
Brake System	Brake Lever	Front/rear brake lever free play			○	○	Free play: 10~20mm									
		Brake lever operation	○													
		Brake performance		○	○	○										
	Lever/Cable	Looseness, abnormal noise and damage		○		○										
	Brake drum/shoe	Drum-to-lining clearance			○	○										
		Brake shoe and lining wear				☆		Indicator type								
Brake drum wear and damage					○	Standard: Front: 110 mm Rear : 110 mm Service Limits: Front: 111 mm Rear : 111 mm										
Moving Device	Tire	Tire pressure	○		○	○	<table border="1"> <thead> <tr> <th></th> <th>Front</th> <th>Rear</th> </tr> </thead> <tbody> <tr> <td>1 rider</td> <td>1.75 kg/cm<sup>2</sup></td> <td>2.25 kg/cm<sup>2</sup></td> </tr> <tr> <td>Tire Size</td> <td>110/70-12</td> <td>130/70-12</td> </tr> </tbody> </table>		Front	Rear	1 rider	1.75 kg/cm <sup>2</sup>	2.25 kg/cm <sup>2</sup>	Tire Size	110/70-12	130/70-12
	Front	Rear														
1 rider	1.75 kg/cm <sup>2</sup>	2.25 kg/cm <sup>2</sup>														
Tire Size	110/70-12	130/70-12														

### 3. INSPECTION/ADJUSTMENT

Inspection & Maintenance Item			Frequency				Judgment Standards	Remarks
			Preride	1st month	Every 6 months	Every 12 months		
Moving Device	Motor-cycle	Tire crack and damage	○		○	○		
		Tire groove and abnormal wear	○		○	○	Groove Depth: Front: 0.8mm Rear : 0.8mm	
		Imbedded objects, gravel, etc.	○		○	○		
		Axle nut looseness			○	○	Torque Values: Front axle nut 5.0~7.0kg-m Rear axle nut 11.0~13.0kg-m	Axle nut torque
		Check wheel rim, rim edge and spoke plate for damage		○		○	Rim runout at rim end: Front: Axial 2.0mm Radial 2.0mm Rear: Axial 2.0mm Radial 2.0mm	
		Check front wheel bearing for excessive play and abnormal noise				○		
		Check front wheel bearing for excessive play and abnormal noise				○		
Damping Device	Frame Spring	Damage					Shock spring free length	
	Suspension arm	Connecting parts looseness and arm damage				○		
	Shock absorber	Oil leakage and damage				○		
		Assembly parts looseness abnormal noise				○		
Power Drive System	Clutch	Operation		○	○	○		
	Transmission case	Oil leakage and oil level			○	○	Oil level: Oil check bolt hole at lower hole edge	Rear wheel transmission case
Electrical Equipment	Ignition device	Spark plug condition			○	○	Plug gap: 0.6~0.7mm	
	Battery	Terminal connection				○		
	Wires	Loose connection and damage				○		

### 3. INSPECTION/ADJUSTMENT

Inspection & Maintenance Item			Frequency				Judgment Standards	Remarks
			Preride	1st month	Every 6 months	Every 12 months		
Engine	Body	Performance and abnormal noise			○	○		
		Conditions at low and high speeds		○	○	○		
		Exhaust smoke			○	○		
		Air cleaner			○	○		
	Lubrication system	Oil quality and quantity			○	○	<input type="checkbox"/> Oil level indicator Indicator light comes on when oil is insufficient	
		Oil leakage			○	○		
		Oil level	○					
		Check oil filter for clogging				○		
	Fuel System	Fuel leakage						
		Carburetor, throttle valve and auto bystarter				○		
		Check fuel filter for clogging				○		
		Fuel level	○					
		Fuel tube replacement					☆Every 4 years	
	Lights & Winker	Operation						
Winking action, dirt and damage		○						
Buzzer & Steering Lock	Operation				○			
Rearview Mirror & Reflector	Rearview mirror position	○					Rearview Mirror	
Reflector & License Plate	Dirt and damage	○						
Counter	Operation				○			
Exhaust Muffler	Joint looseness and damage				○			
	Exhaust muffler performance				○			
Body & Frame	Looseness and damage				○			
Abnormal Conditions Happened Last Time	Check if the abnormal conditions occur again	○						
Others	Lubrication points			○	○			
	Remove carbon deposits on combustion chamber, breather hole and exhaust muffler				○			

# 3. INSPECTION/ADJUSTMENT

## BRAKE SYSTEM

### BRAKE LEVER

#### 《Free Play》

Measure the front and rear brake lever free plays.

**Free Play:** Front: 10~20mm

Rear: 10~20mm

Front 10~20mm

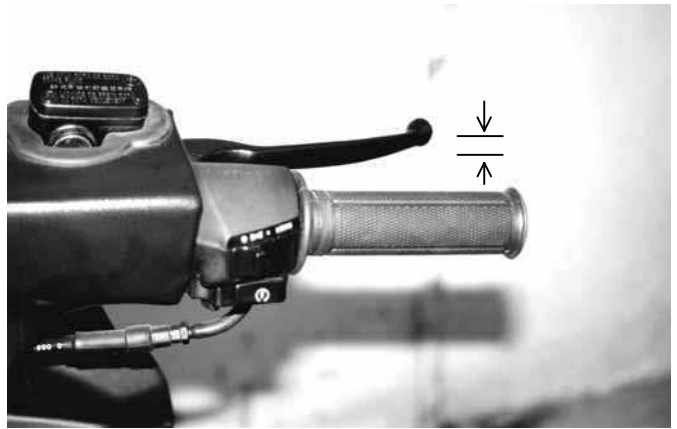

Rear 10~20mm



<Front>

“△” Marks

<Rear>

If the free plays do not fall within the limits, turn the right and left adjusting nuts for adjustment.

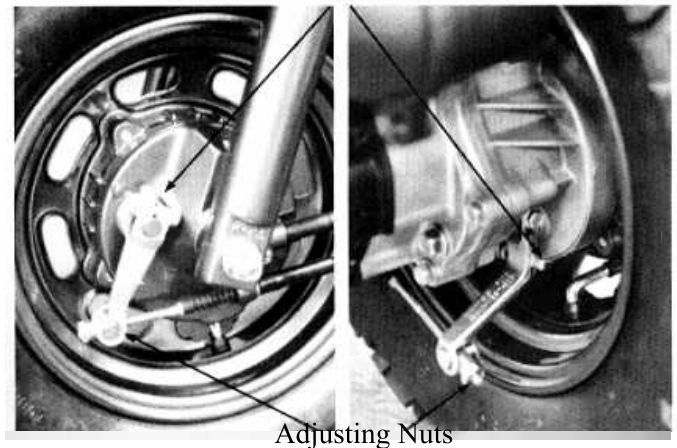

Adjusting Nuts

### 3.INSPECTION/ADJUSTMENT

---

#### BRAKE DRUM/SHOE

##### 《 Brake Shoe Wear 》

Replace the brake shoes if the arrow on the brake arm aligns with reference mark“△” on the brake panel when the brake is fully applied.

##### 《 Brake Drum Wear/Damage 》

Check the brake drum appearance for damage. Check if the brake lining wear is within the specified service limit. Check the brake operation for abnormal noise and brake drum inside for wear or damage.

<Front>                      “△” Marks                      <Rear>

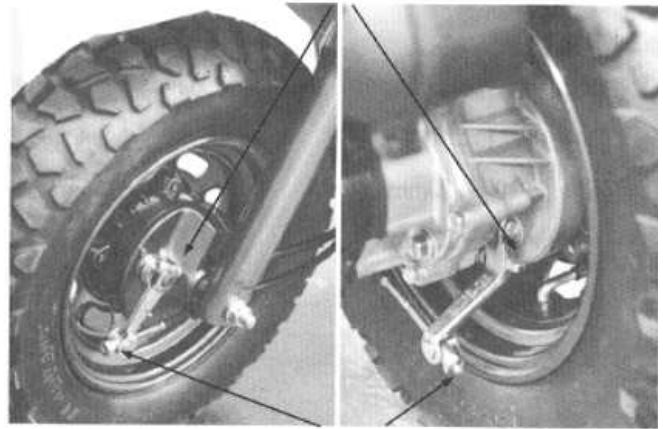

Adjusting Nuts

#### BRAKE DISK/LINING

##### 《 Brake Disk Surface and Brake Pad Wear 》

Check the brake disk surface for scratch. Check if the brake pad wear is within the specified service limit.

##### 《 Brake Disk Runout Inspection 》

Jack the motorcycle wheels off the ground and check if the brake disk runout is within the specified service limit.



Brake Lining Service Limit Mark

Brake Disk

#### BRAKE FLUID LEVEL INSPECTION

##### 《 Brake Master Cylinder Fluid Level Inspection 》

Turn the steering handlebar upright and check if the front brake fluid level is within the specified limits through the front brake master cylinder check hole.



Brake Master Cylinder

### 3. INSPECTION/ADJUSTMENT

#### MOVING DEVICE

##### TIRES

###### 《Tire Pressure》

Check the tire pressure.

\* 

Tire pressure should be checked when tires are cold.
--

Tire Pressure (one rider)

**Front:** 1.75 kg/cm<sup>2</sup>

**Rear:** 2.25 kg/cm<sup>2</sup>

Tire Size

	Cross-country Tire	
Front	110/70 – 12	
Rear	130/70 – 12	

###### 《Axle Nut/Axle Shaft Looseness》

Check the front and rear axle nuts for looseness.

If the axle nuts are loose, tighten them to the specified torques.

Torques:

**Front:** 5.0~7.0kg-m

**Rear:** 11.0~13.0kg-m

###### 《Wheel Rim/Spoke Plate Damage》

Check the wheel rim and spoke plate for wear or damage and measure the rim runout.



Front Wheel



Axle Nut

Rear Wheel



Axle Nut

# 3.INSPECTION/ADJUSTMENT

---

## DAMPING DEVICE

### SHOCK ABSORBERS

#### 《Oil Leak/Damage》

Fully apply the front brake and check the action of the front shock absorber by compressing it several times.  
Check the entire shock absorber assembly for looseness or damage.  
Check the action of the rear shock absorber by compressing it several times.  
Check the entire shock absorber assembly for looseness or damage.



## POWER DRIVE SYSTEM

### TRANSMISSION CASE

Check the rear wheel transmission case surrounding area for oil leaks.  
Stop the engine and remove the oil check bolt.

\* Place the motorcycle on its main stand on level ground.

The gear oil level shall be at the oil check bolt hole. If the oil level is low, add the specified oil to the proper level.

**Specified Gear Oil:** SAE10W90#

Install and tighten the oil check bolt.

**Torque:** 1.0~1.5kg-m

Start the engine and check for oil leaks.

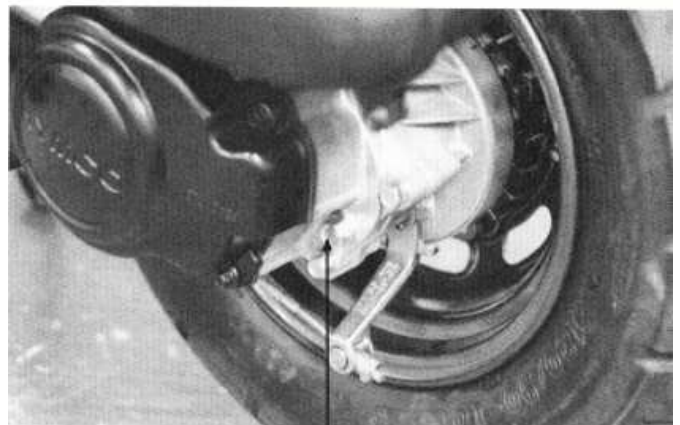

Oil Check Bolt

### 3. INSPECTION/ADJUSTMENT

#### ELECTRICAL EQUIPMENT

#### IGNITION APPARATUS

##### 《Spark Plug》

Remove the frame center cover.  
 Remove the spark plug cap and spark plug.  
 Check the spark plug for wear, fouling and carbon deposits.  
 Remove the fouling and carbon deposits with a spark plug cleaner or wire brush.

##### Specified Spark Plug

NGK	
SH10AA.	SH10BA.
BR6HSA	BR8HSA

**Spark Plug Gap:** 0.6~0.7mm

##### 《Ignition Apparatus》

\* The CDI ignition timing is not adjustable. If the timing is incorrect, check the CDI unit, ignition coil and A.C. generator and replace any faulty parts.

Remove the right side rail. (⇒2-4)  
 Remove the three bolts attaching the right crankcase cover and the cover.

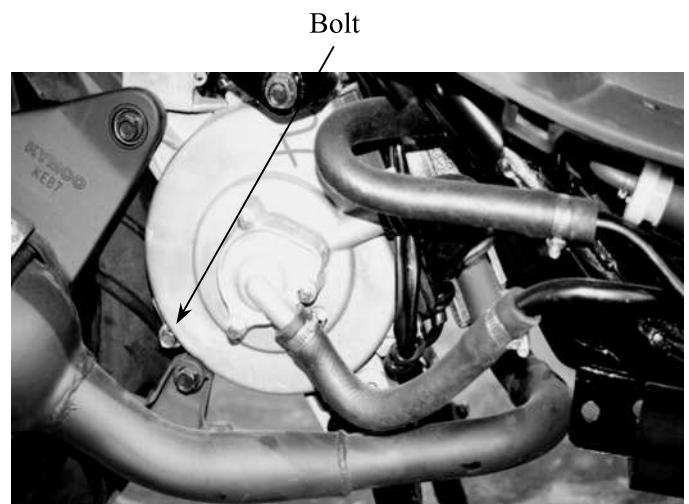
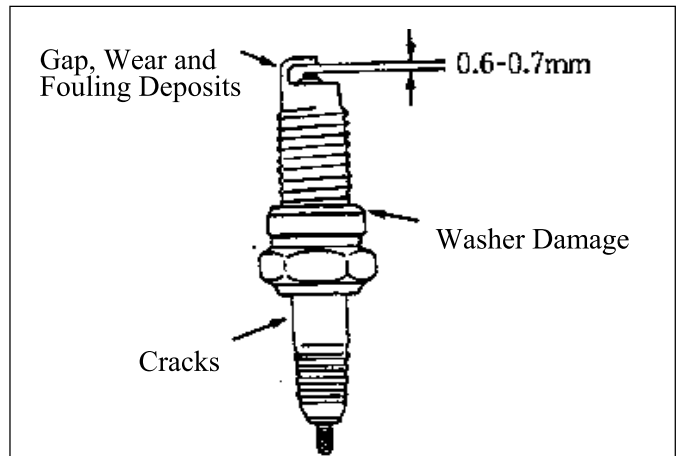

When the engine is running at the specified rpm, the ignition timing is correct if the "F" mark on the flywheel aligns with the index mark on the crankcase within  $\pm 2^\circ$ .

##### Ignition Timing:

SH10BA.:  $13.5^\circ \pm 2^\circ$  BTDC/2000rpm

SH10AA.:  $13.5^\circ \pm 2^\circ$  BTDC/2000rpm

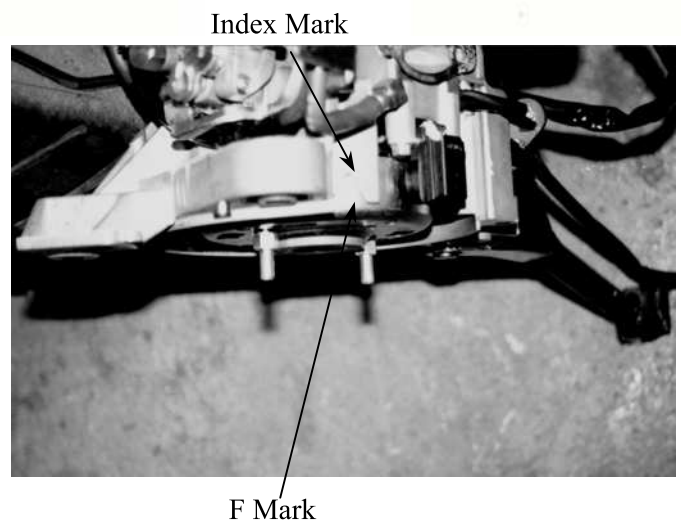



### 3.INSPECTION/ADJUSTMENT

---

#### ENGINE

#### BODY

#### 《At High and Low Speeds》

\* The engine must be warm for accurate idle speed adjustment.

Adjust the idle speed to the specified range by turning the throttle stop screw and air screw.

#### Idle Speed:

SH10BA: 2000±100 rpm

SH10AA: 2000±100 rpm

#### 《Air Cleaner》

Remove the air cleaner cover by removing the seven air cleaner cover screws.  
Remove the air cleaner element.

Throttle Stop Screw

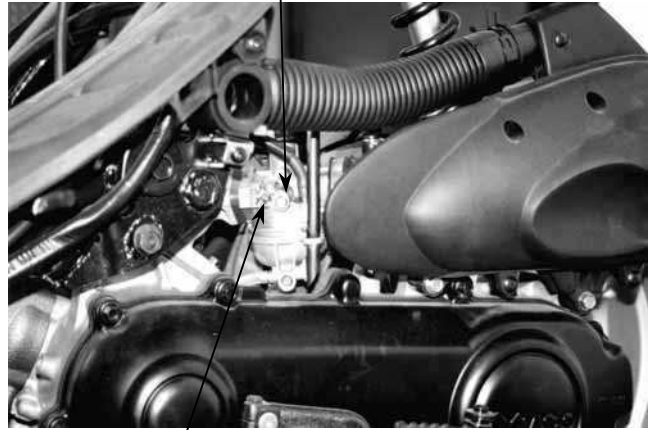

Air Screw

Screws

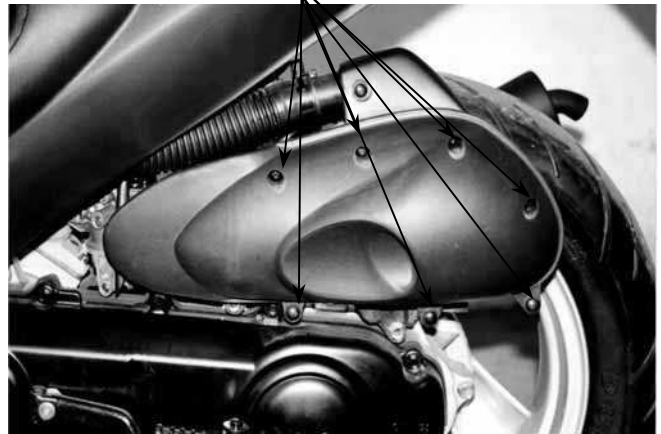

Air Cleaner

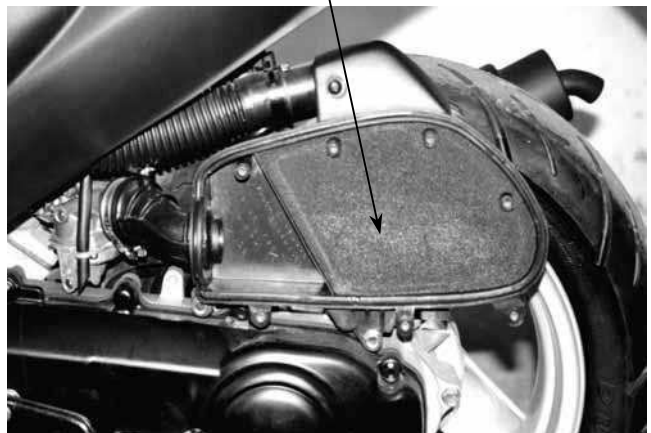

### 3. INSPECTION/ADJUSTMENT

Wash the air cleaner element in detergent oil, squeeze out and allow to dry.

\* Never use gasoline or organic vaporable oil with acid or alkali for washing.

After washing, soak the element in clean engine oil SAE 15W-40# and squeeze out excess oil. Reinstall the element.

#### 《Cylinder Compression》

\* Warm up the engine before compression test.

Remove the spark plug and insert a compression gauge. Open the throttle valve fully and push the starter button for 7~8 seconds to test the compression.

#### Compression:

SH10BA: 11.8kg/cm<sup>2</sup>

SH10AA: 11.8kg/cm<sup>2</sup>

If the compression is low, check for the following:

- Leaking cylinder head gasket
- Worn piston/cylinder

If the compression is high, it indicates that carbon deposits have accumulated on the combustion chamber and the piston head.

#### LUBRICATION SYSTEM

##### 《Oil Filter Cleaning》

Disconnect the oil tube at the oil pump side and allow oil to drain into a clean container. Remove the tube clip at the oil tank side and disconnect the oil tube. Remove the oil filter.

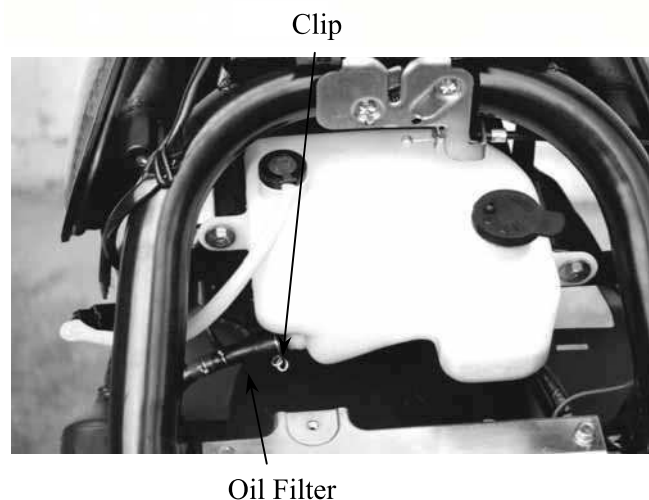
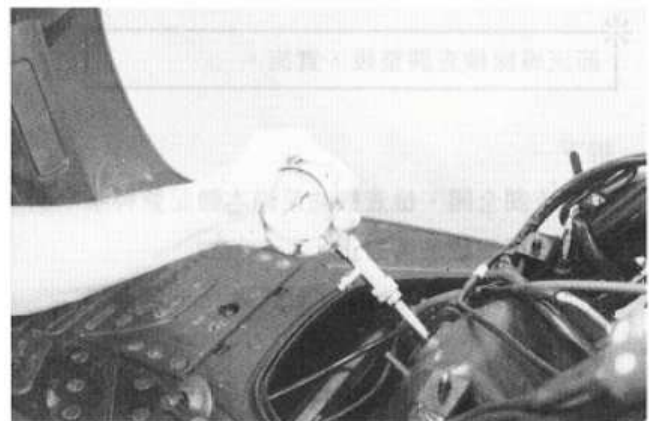
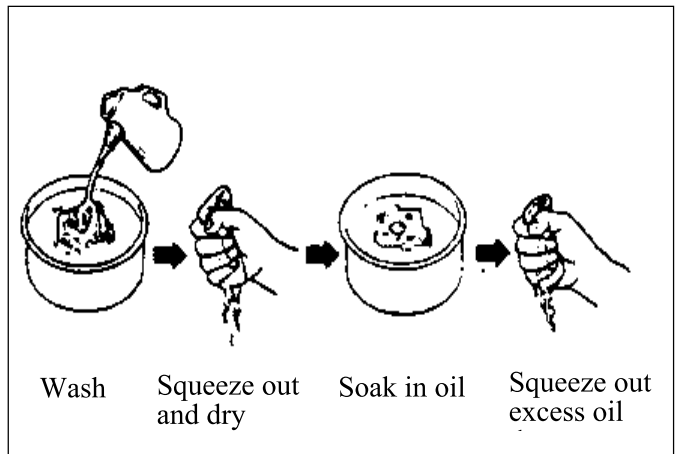

### 3.INSPECTION/ADJUSTMENT

---

Clean the oil filter screen with compressed air.

Install the oil filter in the reverse order of removal and fill the oil tank with specified oil up to the proper level.

Bleed air from the oil pump and oil lines.

\* \_\_\_\_\_

- Connect the oil tubes securely.
- Install the tube clip at the oil tank side and also install the clip to the lower oil tube that goes to the oil pump.
- Check for oil leaks.

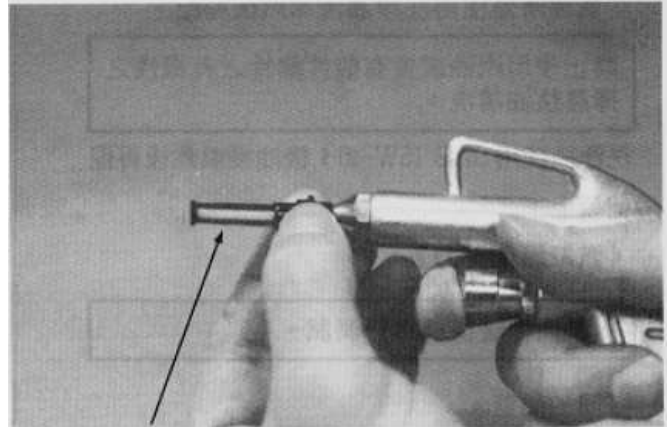

Filter Screen

#### 《Oil Pump Condition》

\* \_\_\_\_\_

Adjust oil pump control cable after the throttle grip free play is adjusted.

Open the throttle valve fully and check that the index mark on the pump body aligns with the aligning mark on the oil pump control lever.

Reference tip alignment within 1mm of index mark on open side is acceptable.

Start and idle the engine, then slowly open the throttle to increase engine rpm and check the operation of the oil pump control lever.

If adjustment is necessary, adjust the oil pump control cable by loosening the control cable lock nut and turning the adjusting nut. After adjustment, tighten the lock nut.

\* \_\_\_\_\_

Reference tip alignment within 1mm of index mark on open side is acceptable. However, the aligning mark on the control lever must never be on the closed side of the index mark, otherwise engine damage will occur because of insufficient lubrication.

Control Lever Aligning Mark



Pump Body Index Mark

Lock Nut

Adjusting Nut

If the oil pump is not synchronized properly, the following will occur:

- Excessive white smoke or hard starting due to pump control lever excessively open
- Seized piston due to pump control lever insufficiently open

### 3. INSPECTION/ADJUSTMENT

#### FUEL SYSTEM

##### 《Throttle Grip Free Play》

Measure the throttle grip free play.

**Free Play:** 2~6mm

If the throttle grip free play does not fall within the specified range, adjust by loosening the lock nut and turning the adjusting nut.



#### OTHERS

#### LIGHTS

##### 《Headlight》

Adjust the headlight beam by loosening the headlight adjusting bolt and moving the adjusting bolt forward and backward to a proper position. Tighten the adjusting bolt.

#### COOLING SYSTEM

##### COOLANT LEVEL INSPECTION

Place the motorcycle on its main stand on level ground.

Check the coolant level of the reserve tank and the level should be between the upper and lower level lines.

If necessary, fill the reserve tank with recommended coolant to the "F" level line.

**Recommended Coolant:** SIGMA Coolant  
(Standard Concentration 30%)

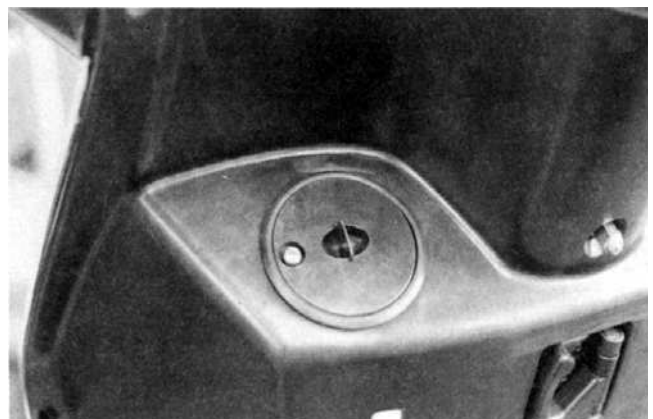

- \* The coolant level does not change no matter the engine is warm or cold. Fill to the "F" (upper) line.

##### COOLANT REPLACEMENT

- \* Perform this operation when the engine is cold.

Remove the front cover.

Remove the radiator cap.

Remove the water hose to drain the coolant and tilt the motorcycle to the right and the coolant will drain more easily.

Drain the coolant in the reserve tank.

Reinstall the water hose.

Fill the radiator with the specified coolant.

- \* The coolant freezing point should be 5 °C lower than the temperature of the riding area.

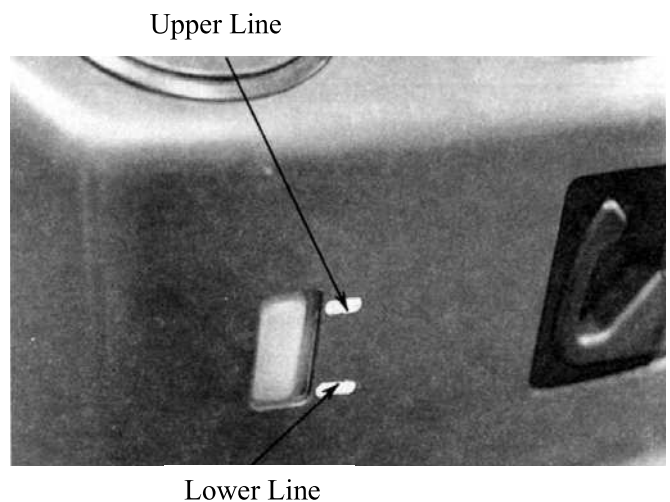

# 4. LUBRICATION SYSTEM

---

---

## LUBRICATION SYSTEM

---

SERVICE INFORMATION .....	4-2
TROUBLESHOOTING .....	4-2
OIL PUMP REMOVAL.....	4-3
OIL PUMP INSPECTION .....	4-3
OIL PUMP INSTALLATION .....	4-4
OIL PUMP BLEEDING.....	4-5
OIL TANK .....	4-6

# 4. LUBRICATION SYSTEM

---

## LUBRICATION SYSTEM

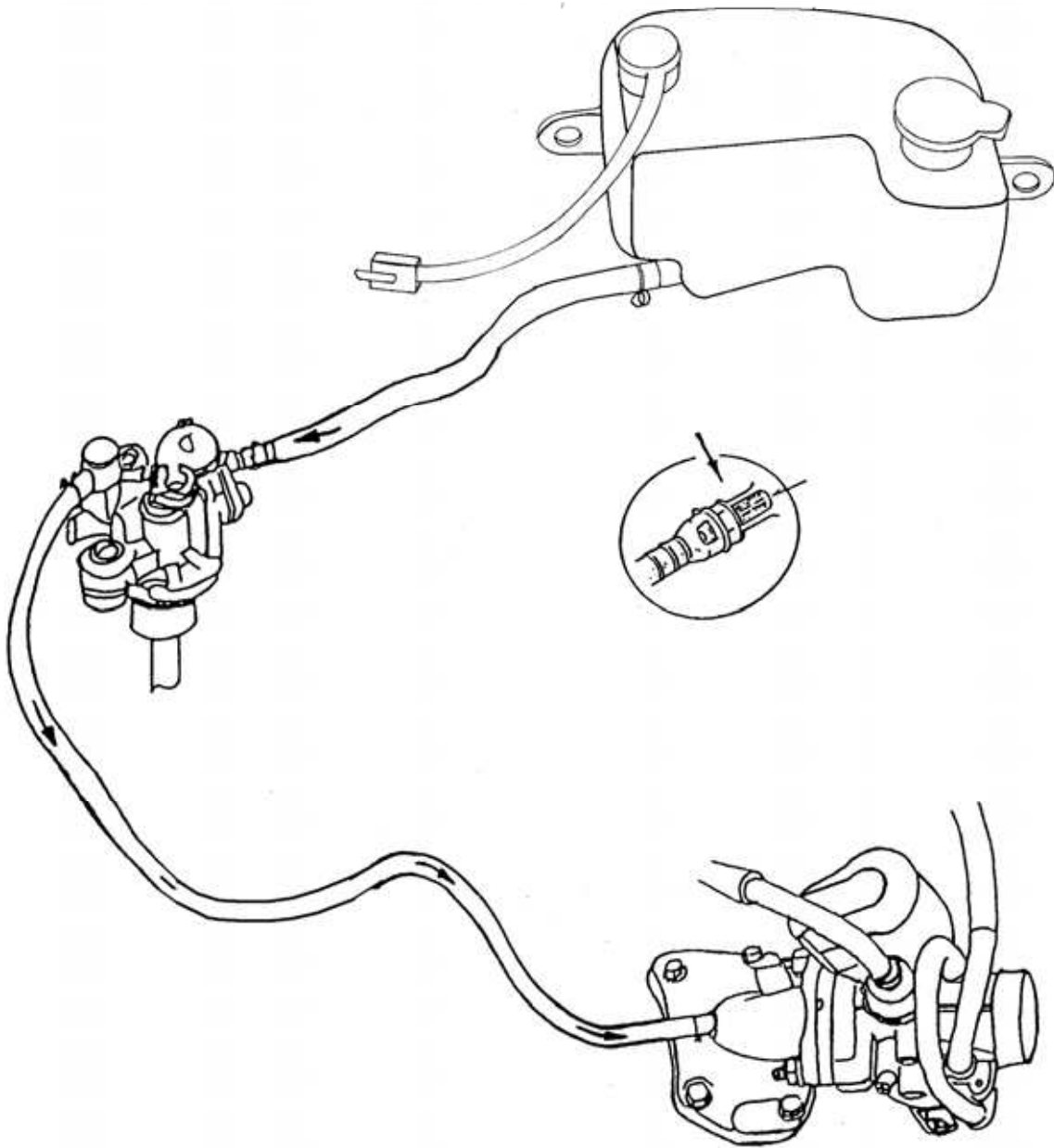

# 4. LUBRICATION SYSTEM

---

## SERVICE INFORMATION

### GENERAL INSTRUCTIONS

- Use care when removing and installing the oil pump not to allow dust and dirt to enter the engine and oil line.
- Do not attempt to disassemble the oil pump.
- Bleed air from the oil pump if there is air between the oil pump and oil line.
- If the oil is disconnected, refill the oil line with motor oil before connecting it.

### SPECIFICATIONS

- Recommended Motor Oil: SAE20W20# 2-stroke Motor Oil
- Oil Capacity : 1.5 liter  
Light comes on : 0.5 liter

## TROUBLESHOOTING

### Excessive white smoke or carbon deposits on spark plug

- Oil pump not properly synchronized (excessive oil)
- Poor quality oil

### Engine overheating

- Oil pump not properly adjusted (insufficient oiling)
- Poor quality oil

### Seized piston

- No oil in tank or clogged oil line
- Oil pump not properly adjusted (insufficient oiling)
- Air in oil line
- Faulty oil pump

### Oil not flowing out of tank to engine

- Clogged oil tank cap breather hole
- Clogged oil filter

## 4. LUBRICATION SYSTEM

### OIL PUMP REMOVAL

Do not allow foreign matters to enter the crankcase. Before removing the oil pump, clean the oil pump and crankcase surfaces.

Remove the met-in box. (⇒2-4)

Disconnect the oil pump control cable from the pump body.  
Disconnect the oil inlet line from the oil pump.  
Then, disconnect the oil outlet line.

Before disconnecting the oil line, clip the oil line to avoid oil flowing out and then plug the oil line after it is disconnected.

Remove the oil pump control cable plate bolt and copper washer.  
Remove the oil pump from the crankcase.

### OIL PUMP INSPECTION

Remove the oil pump and inspect the following items:

- Weakened O-ring
- Damage to crankcase mating surface
- Damage to pump body
- Control lever operation
- Oil leaks through oil seals
- Worn or damaged pump pinion

Do not disassemble the oil pump which cannot be used after disassembly.

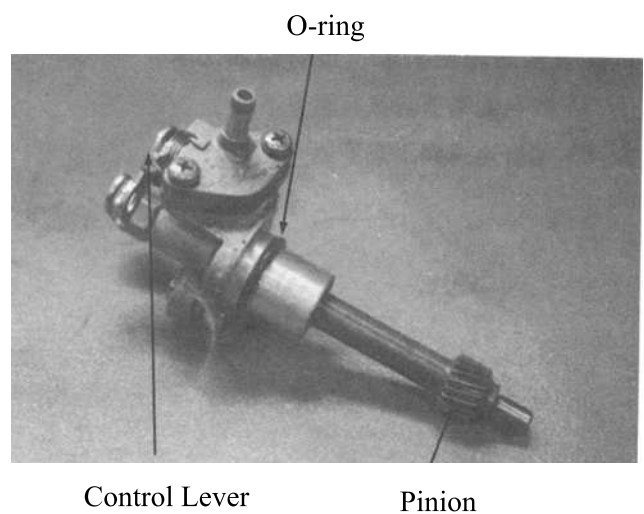
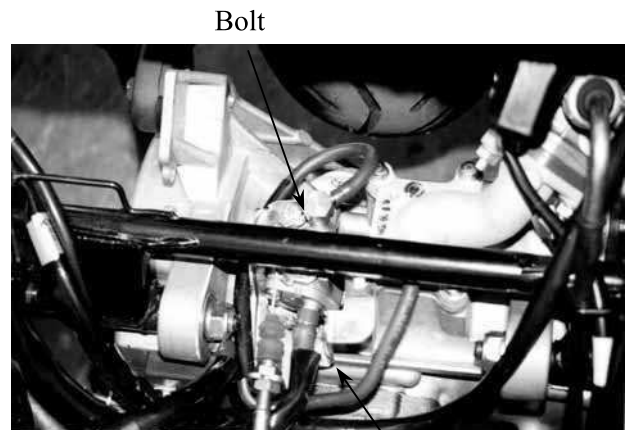
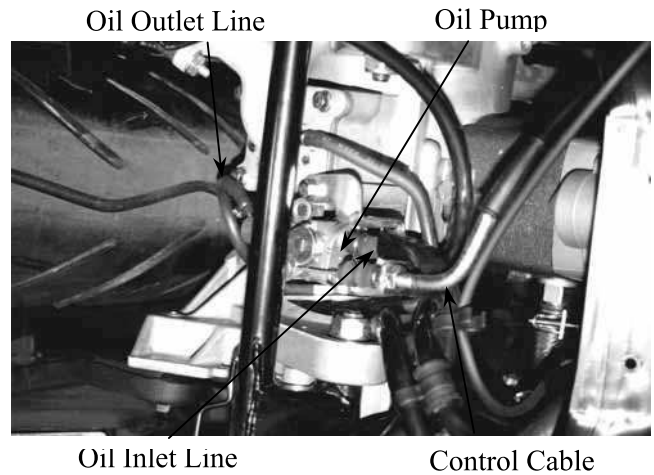



# 4. LUBRICATION SYSTEM

---

## OIL PUMP INSTALLATION

- Lubricate the O-ring with grease or engine oil before installation.
- Make sure that the oil pump is inserted into the crankcase.
- Apply molybdenum disulfide or grease to the pump pinion.

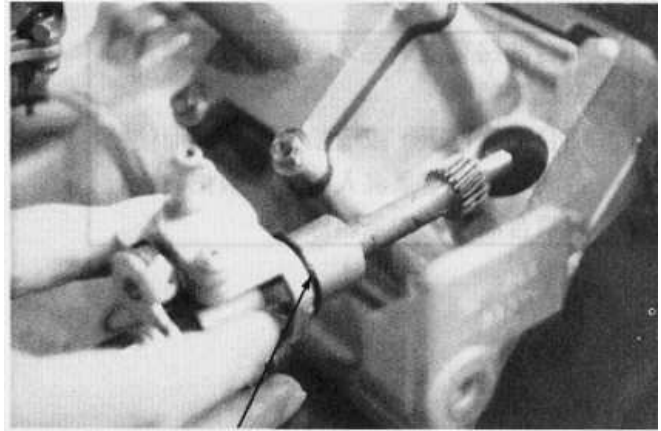

Grease or Engine Oil

Install the oil pump onto the crankcase.

Control Cable Plate

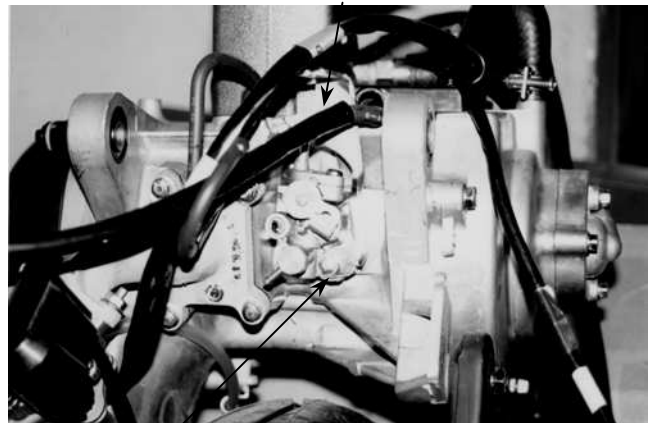

Bolt

Install the oil pump control cable plate.  
Connect the oil inlet line and oil outlet line properly.  
Connect the oil pump control cable.  
Bleed air from the oil pump.

Oil Outlet Line



Control Cable

## 4. LUBRICATION SYSTEM

### OIL PUMP BLEEDING

- Air in the oil lines will block oil flow and result in severe engine damage.
- Bleed air from the oil lines and oil pump whenever the oil lines or pump have been removed or there is air in the oil lines.

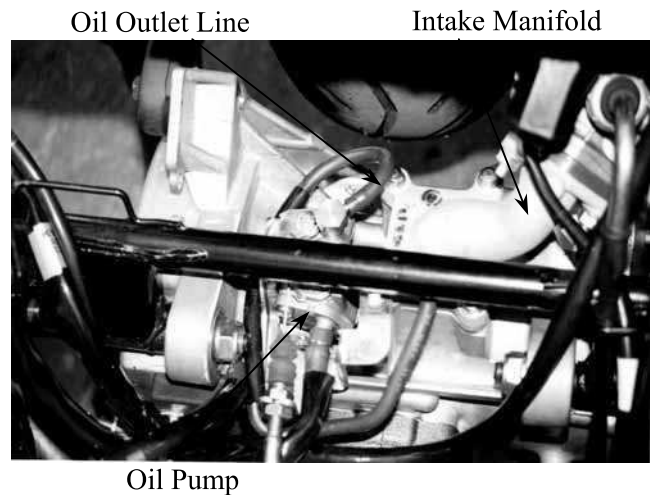

### OIL INLET LINE/OIL PUMP BLEEDING

Fill the oil tank with recommended oil.  
Place a shop towel around the oil pump.  
Disconnect the oil inlet line from the oil pump and clip it.  
Fill the oil pump with oil by squirting clean oil through the joint. (About 3cc)  
Fill the oil line with oil and connect it to the oil pump.

- Bleed air from the oil inlet line first, then bleed air from the oil outlet line.

### OIL OUTLET LINE BLEEDING

1. Disconnect the oil outlet line and bend it into U shape. Force air out of the tube by filling it with oil.
2. Start the engine and allow it to idle with the oil control lever in the fully open position. Visually check the oil flow.
3. If there is no oil flowing out within 1 minute, bleed air from the oil inlet line and oil pump.

- Never run the engine in a closed area.
- Do not increase the engine speed at will.

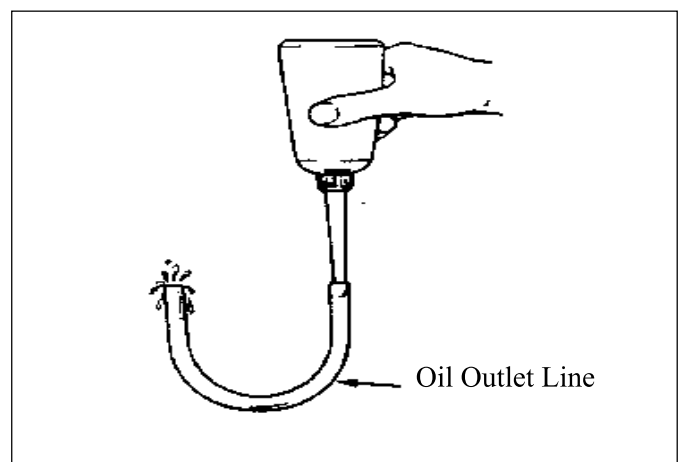

## 4. LUBRICATION SYSTEM

### OIL TANK

#### OIL TANK REMOVAL

Remove the seat and met-in box. (⇒2-3)

Remove the battery.

Remove the battery cover screw and the battery cover.

Remove the oil meter connector.

Remove the two bolts attaching the oil tank.

Disconnect the oil inlet line.

Drain the oil inside the oil tank into a clean container.

Remove the oil tank.

The installation sequence is the reverse of removal.

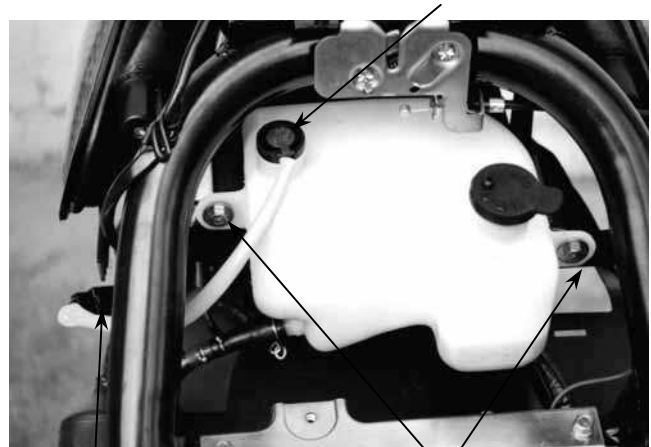

Wire Connector

Bolts

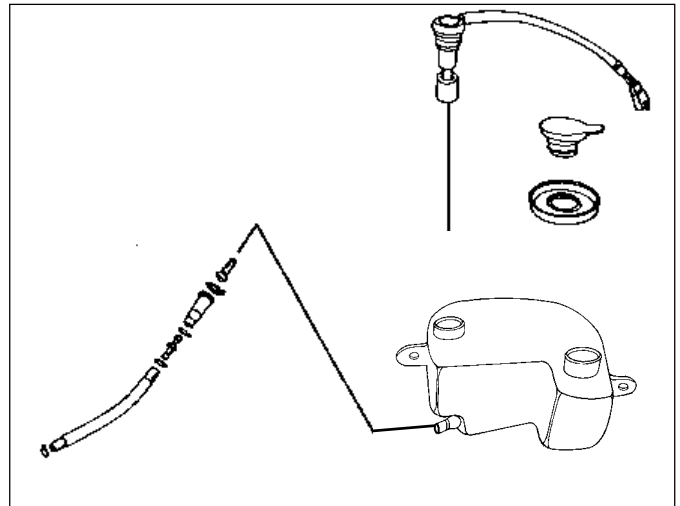

- Connect the oil line properly.
- Bleed air from the oil pump after installation.
- The oil tube clip (at the oil tank side) must be locked from inside of the oil tube joint.

# 5. ENGINE REMOVAL/INSTALLATION

---

5

---

## ENGINE REMOVAL/INSTALLATION

---

SERVICE INFORMATION .....	5-1
ENGINE REMOVAL .....	5-2
ENGINE INSTALLATION .....	5-4

# 5. ENGINE REMOVAL/INSTALLATION

---

## SERVICE INFORMATION

### GENERAL INSTRUCTIONS

- Parts requiring engine removal for servicing:

Crankcase  
Crankshaft

### TORQUE VALUES

Engine mounting bolt	4.5~5.5kg-m
Engine hanger bracket bolt	4.5~5.5kg-m
Rear shock absorber lower mount bolt	2.4~3.0kg-m
Rear shock absorber upper mount bolt	3.5~4.5kg-m

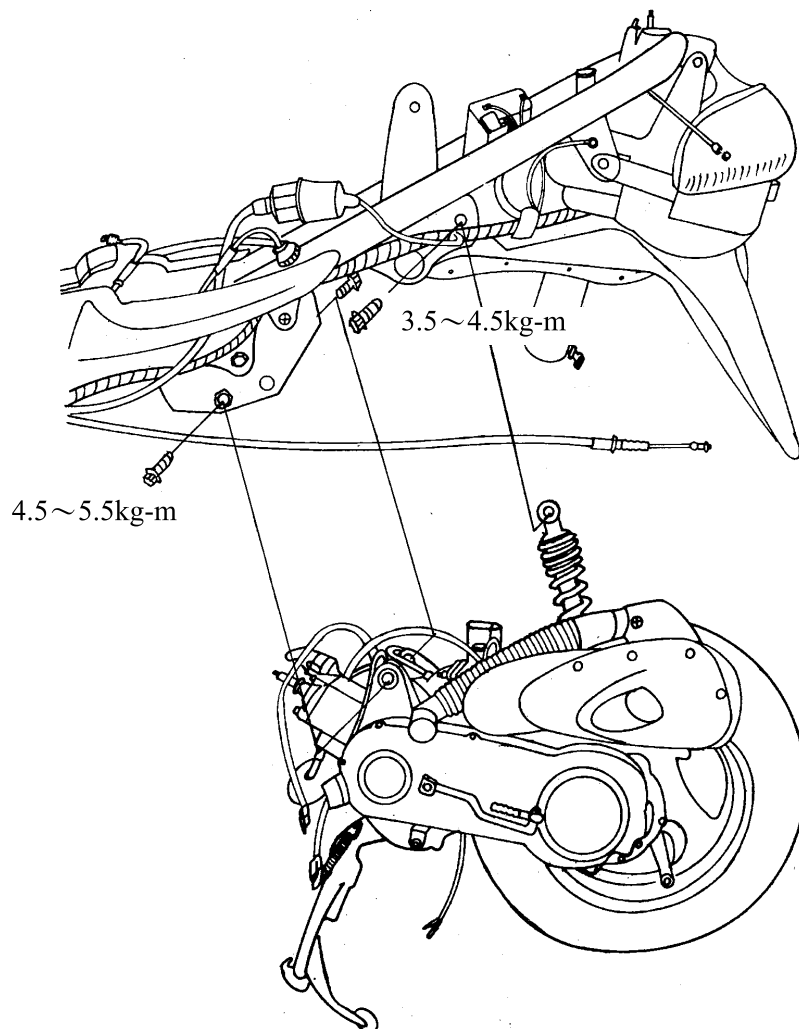

# 5. ENGINE REMOVAL/INSTALLATION

## ENGINE REMOVAL

Remove the frame body cover. (⇒2-5)  
Remove the two bolts attaching the air cleaner case.  
Loosen the band between the air cleaner and carburetor to remove the air cleaner case.  
Remove the carburetor cap.

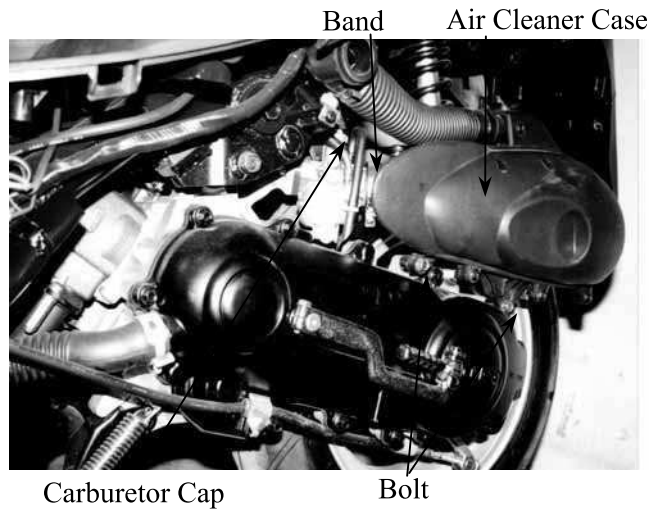

Disconnect the oil pump control cable from the pump body.  
Disconnect the oil inlet line from the oil pump.

\* After the oil inlet line is disconnected, plug the oil line opening to prevent oil from flowing out.

Disconnect the auto bystarter, A.C. generator and starter motor wire connectors.

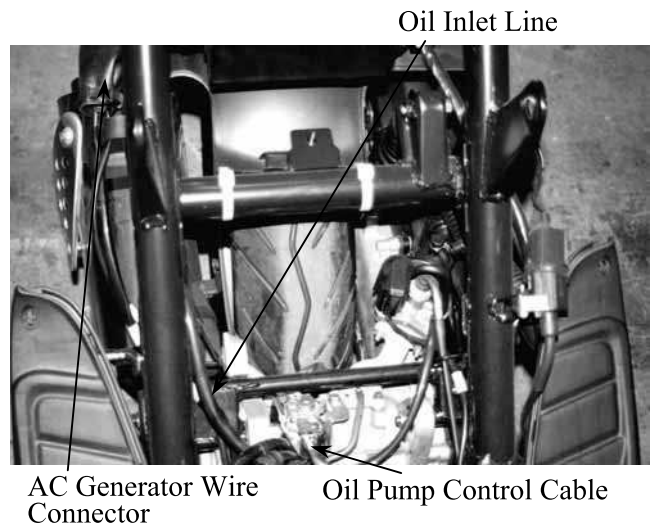

Remove the spark plug cap.

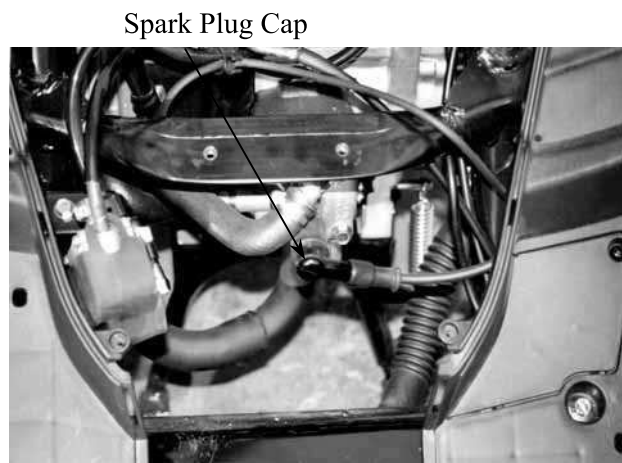

## 5. ENGINE REMOVAL/INSTALLATION

---

Remove the rear brake adjusting nut and disconnect the brake cable from the crankcase.  
Remove the rear brake cable clamp and rear brake cable.  
Remove the cooling air tube band on the left crankcase cover and disconnect the cooling air tube.  
Remove the rear shock absorber lower mount bolt.

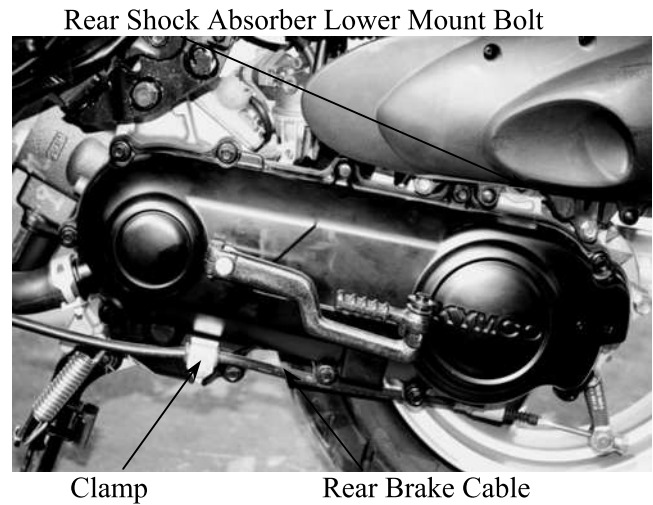

Remove the right and left engine mounting nuts.  
Take out the right and left engine mounting bolts.  
Lift the frame upward to separate it from the engine and be careful not to damage .



### ENGINE HANGER BRACKET REMOVAL

Remove the engine hanger bracket bolt and engine hanger bracket.  
The installation sequence is the reverse of removal.

**Torque:**4.5~5.5kg-m

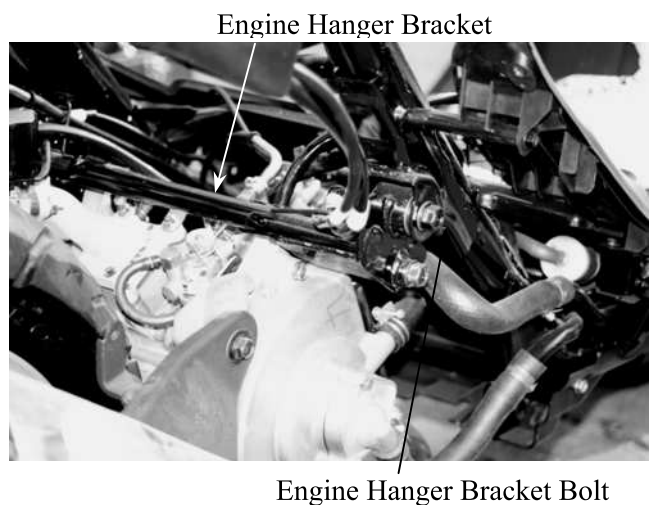

## 5. ENGINE REMOVAL/INSTALLATION

---

### ENGINE HANGER BRACKET INSPECTION

Inspect the stopper rubbers and bushings for damage and replace with new ones if necessary.

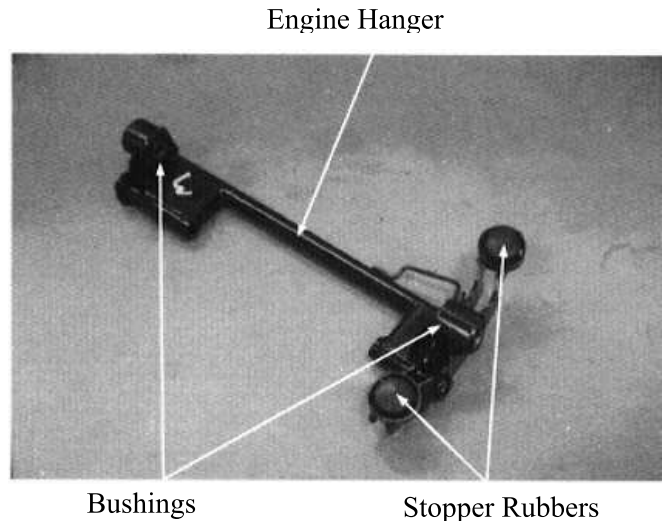

### ENGINE INSTALLATION

Install the engine in the reverse order of removal.

\* Cables and wires should be routed properly.

#### Torque Values:

Engine mounting bolt : 4.5~5.5kg-m  
Rear shock absorber lower mount bolt:  
: 2.4~3.0kg-m



Perform the following inspections and adjustments after installation.

- Throttle cable
- Oil pump control cable (⇒3-11)
- Rear brake cable (⇒3-5)
- Oil pump bleeding (⇒4-5)

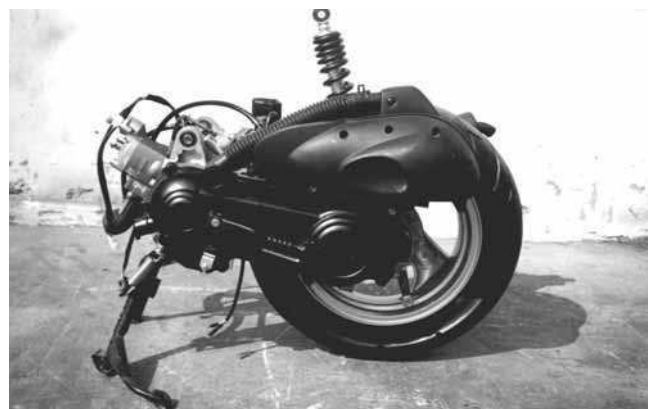



## 6. CYLINDER HEAD/CYLINDER/PISTON

---

6

### CYLINDER HEAD/CYLINDER/PISTON

---

SERVICE INFORMATION .....	6-3
TROUBLESHOOTING .....	6-3
CYLINDER HEAD .....	6-4
CYLINDER/PISTON .....	6-8

## 6. CYLINDER HEAD/CYLINDER/PISTON

---

〈SH10AA〉

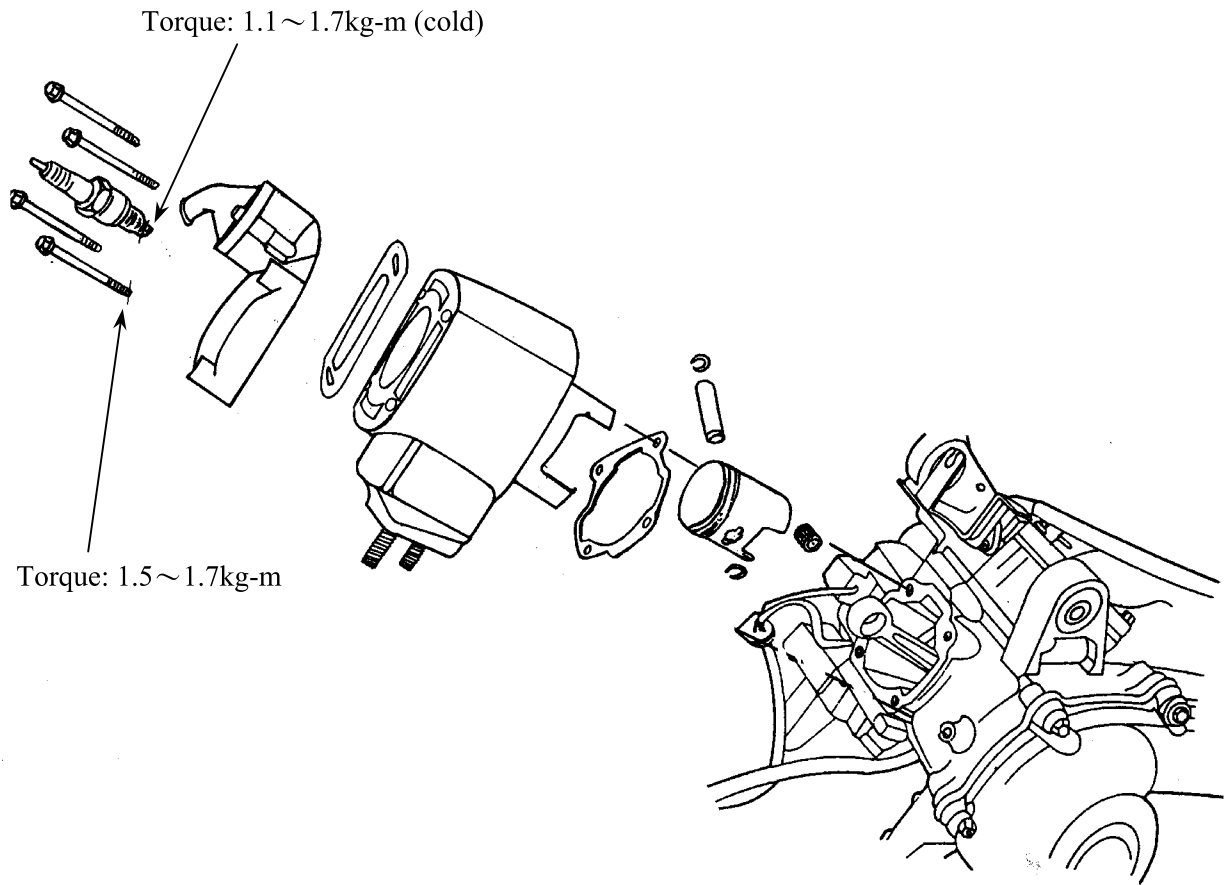

# 6. CYLINDER HEAD/CYLINDER/PISTON

---

〈SH10BA〉

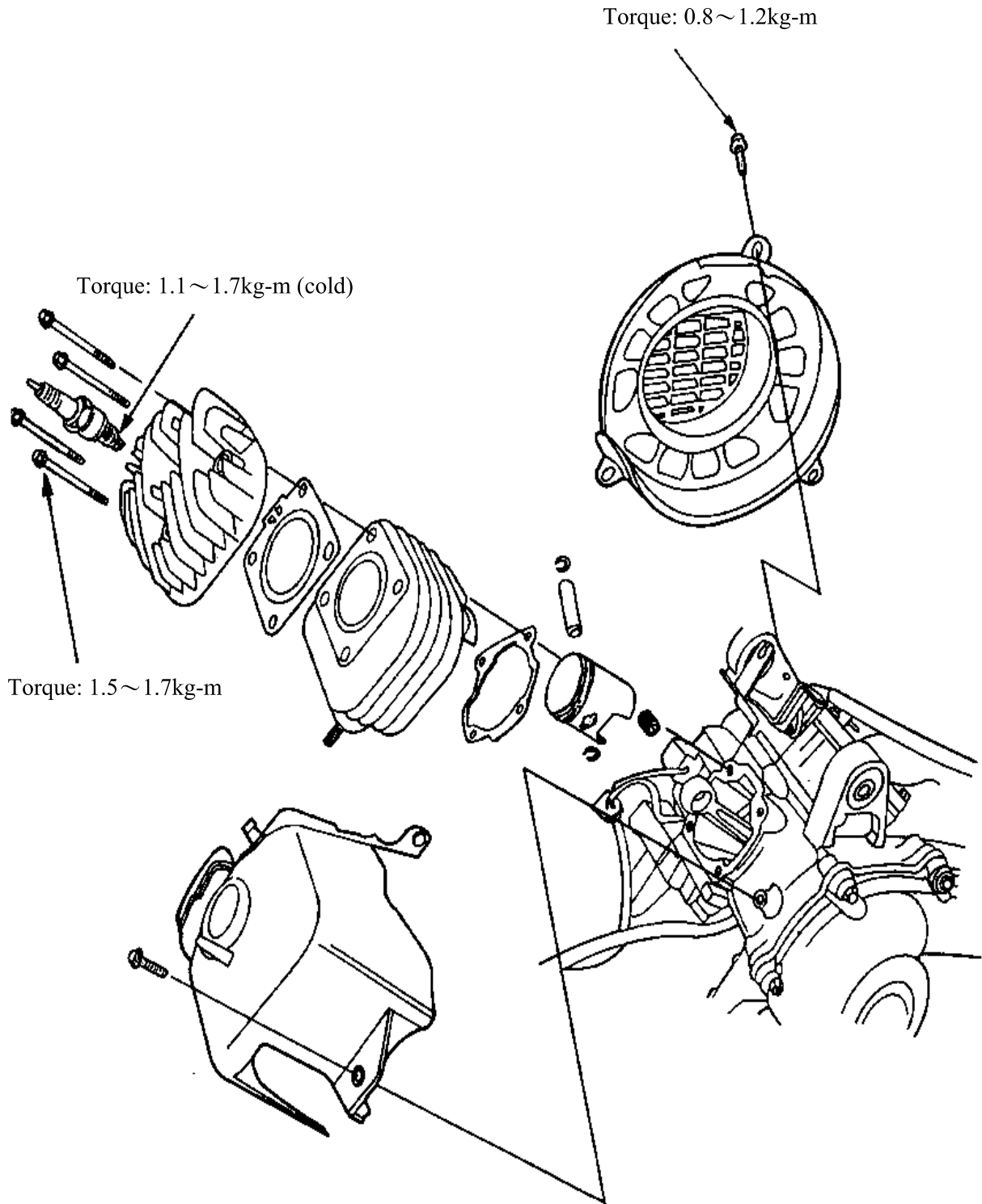

## 6. CYLINDER HEAD/CYLINDER/PISTON

---

### SERVICE INFORMATION

#### GENERAL INSTRUCTIONS

- The cylinder head, cylinder and piston can be serviced with the engine installed in the frame.
- Before disassembly, clean the engine to prevent dust from entering the engine.
- Remove all gasket material from the mating surfaces.
- Do not use a driver to pry between the cylinder and cylinder head, cylinder and crankcase.
- Do not damage the cylinder inside and the piston surface.
- After disassembly, clean the removed parts before inspection. When assembling, apply the specified engine oil to movable parts.

#### SPECIFICATIONS

Item	Standard (mm)		Service Limit (mm)	
	SH10BA	SH10AA	SH10BA	SH10AA
Cylinder head warpage	—	—	0.10	0.10
Piston O.D.(5mm from bottom of piston)	38.970~38.955	38.970~38.955	38.90	38.90
Cylinder-to- piston clearance	0.03~0.07	0.03~0.07	0.10	0.10
Piston pin hole I.D.	12.002~12.008	12.002~12.008	12.03	12.03
Piston pin O.D.	11.994~12.0	11.994~12.0	11.98	11.98
Piston-to-piston pin clearance	0.002~0.014	0.002~0.014	0.03	0.03
Piston ring end gap (top/second)	0.10~0.25	0.10~0.25	0.40	0.40
Connecting rod small end I.D.	17.005~17.017	17.005~17.017	17.03	17.03
Cylinder bore	39.0~39.025	39.0~39.025	39.05	39.05

#### TORQUE VALUES

Cylinder head bolt	1.5~1.7kg-m
Exhaust muffler joint lock nut	1.0~1.4kg-m
Exhaust muffler lock bolt	3.0~3.6kg-m
Spark plug	1.1~1.7kg-m

#### TROUBLESHOOTING

##### Compression too low, hard starting or poor performance at low speed

- Leaking cylinder head gasket
- Loose spark plug
- Worn, stuck or broken piston and piston rings
- Worn or damaged cylinder and piston

##### Compression too high, overheating or knocking

- Excessive carbon build-up in cylinder head or on piston head

##### Abnormal noisy piston

- Worn cylinder and piston
- Worn piston pin or piston pin hole
- Worn connecting rod small end bearing

##### Abnormal noisy piston rings

- Worn, stuck or broken piston rings
- Worn or damaged cylinder

## 6. CYLINDER HEAD/CYLINDER/PISTON

### CYLINDER HEAD

#### REMOVAL <SH10AA>

Remove the rear carrier.  
Remove the frame body cover. (⇒2-5)  
Drain the coolant.  
Disconnect the thermosensor wire from the thermosensor.  
Disconnect the water hose from the thermostat housing.



Remove the spark plug cap.  
Remove the two joint lock nuts on the front of the exhaust muffler and then remove the two exhaust muffler lock bolts.  
The installation sequence is the reverse of removal.

\* When installing the exhaust muffler, first tighten the two nuts on the front and then tighten the two bolts.

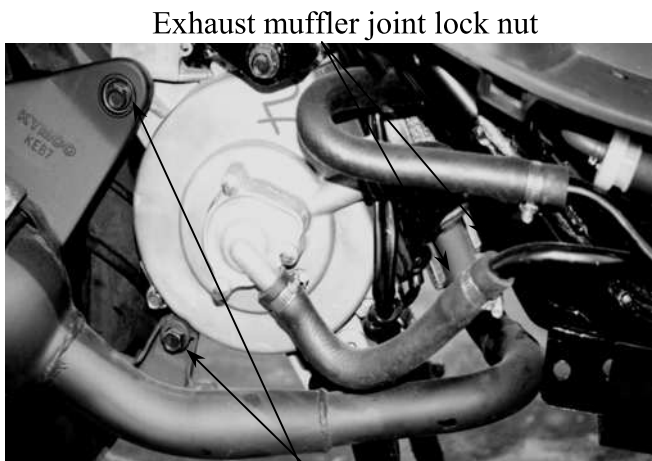

Remove the spark plug.  
Remove the cylinder head bolts and the cylinder head.

\* Loosen the bolts diagonally in 2 or 3 times.

Remove the cylinder head gasket.

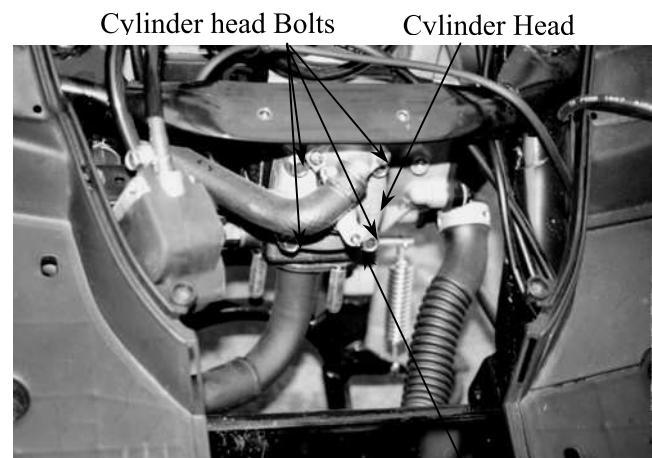

Spark Plug

## 6. CYLINDER HEAD/CYLINDER/PISTON

### CYLINDER HEAD

#### REMOVAL <SH10BA>

Remove the rear carrier.

Remove the frame body cover. (⇒2-5)

Remove the spark plug cap.

Remove the three bolts attaching the fan cover to remove the fan cover.

Remove the two joint lock nuts on the front of the exhaust muffler and then remove the two exhaust muffler lock bolts.

Remove the bolt attaching the engine hood to remove the engine hood.

The installation sequence is the reverse of removal.

\*

When installing the exhaust muffler, first tighten the two nuts on the front and then tighten the two bolts.

Remove the spark plug.

Remove the cylinder head bolts and the cylinder head.

\*

Loosen the bolts diagonally in 2 or 3 times.

Remove the cylinder head gasket.

Spark Plug Cap

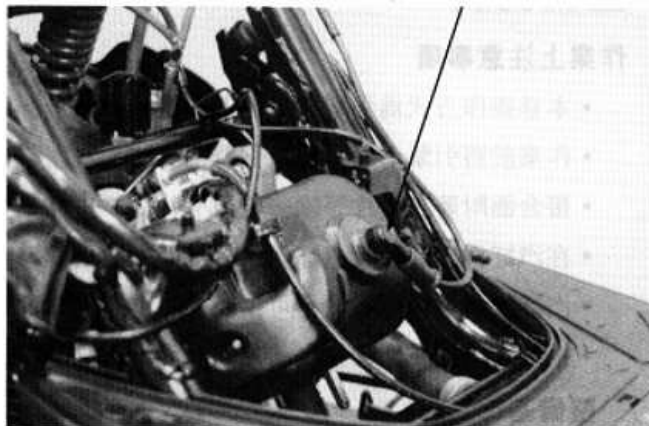

Fan Cover/Engine Hood

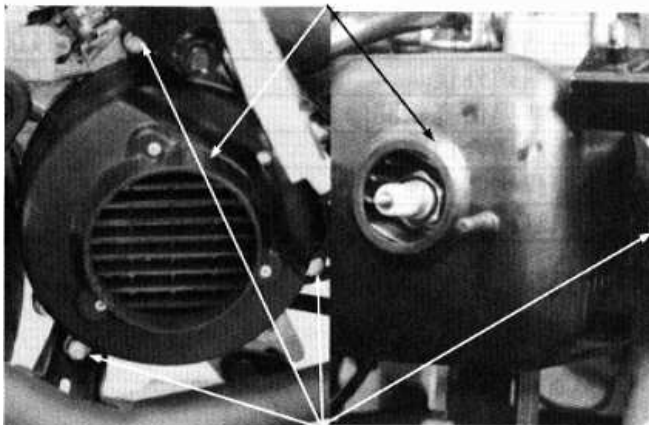

Bolts

Cylinder head Bolts

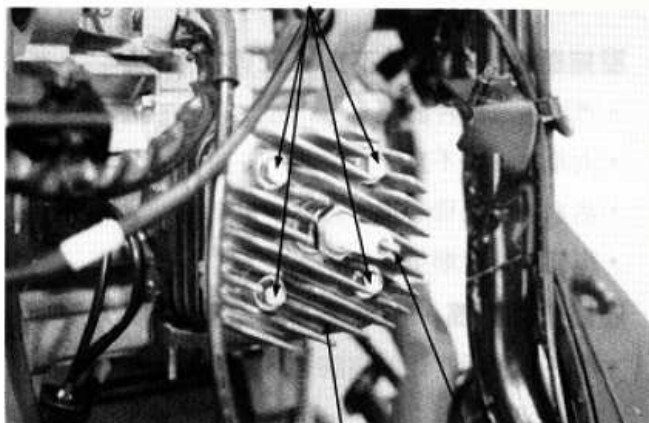

Cylinder Head Spark Plug

## 6. CYLINDER HEAD/CYLINDER/PISTON

---

### COMBUSTION CHAMBER DECARBONIZING

Remove the carbon deposits from the combustion chamber

\*

Avoid damaging the combustion chamber wall and cylinder mating surface.

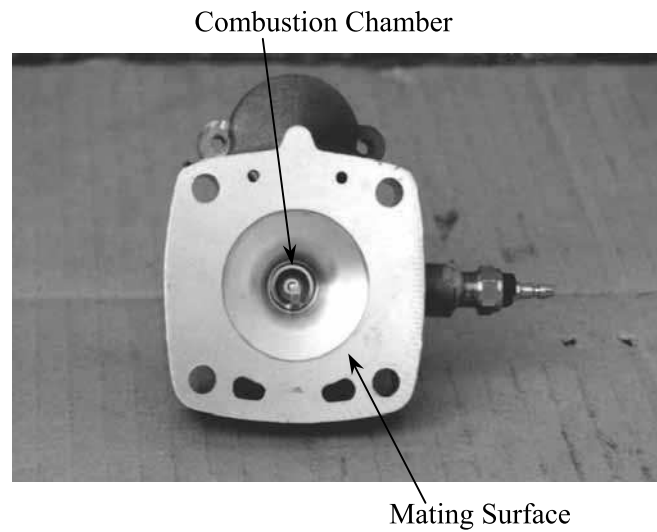

### CYLINDER HEAD INSPECTION

Check the cylinder head for warpage with a straight edge and feeler gauge.

#### Service Limit:

SH10BA: 0.10mm replace if over

SH10AA: 0.10mm replace if over

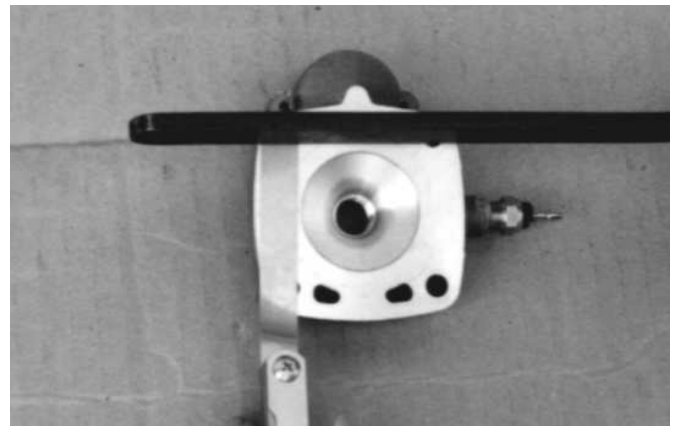

### CYLINDER HEAD INSTALLATION

Install the cylinder head on the cylinder properly.

\*

Be careful not to damage the mating surfaces.

Install a new cylinder head gasket onto the cylinder.

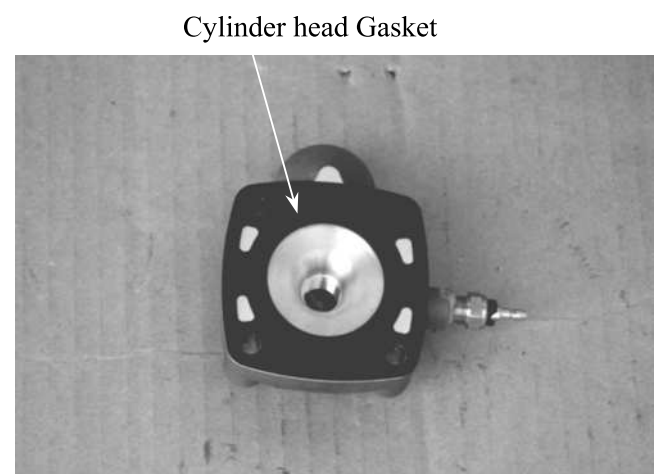

## 6. CYLINDER HEAD/CYLINDER/PISTON

---

### Cylinder Head Bolts Installation

Install and tighten the cylinder head bolts diagonally in 2 or 3 times.

**Torque:** 1.5~1.7kg-m

Install the spark plug.

**Torque:** 1.1~1.7kg-m

Cylinder head Bolts

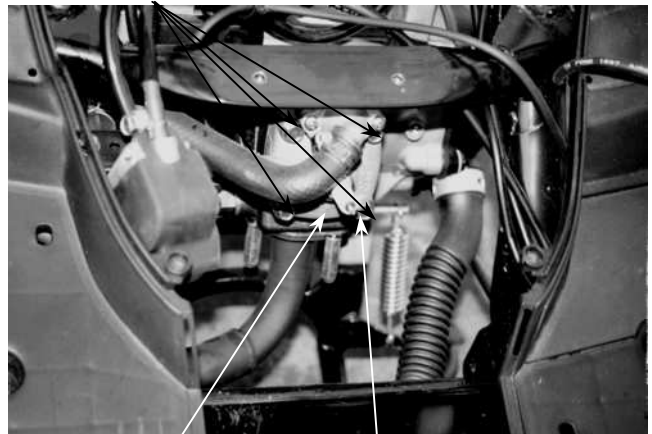

Cylinder Head

Spark Plug

### Engine Hood Installation <SH10BA>

Install the engine hood. (⇒6-5)

Install the spark plug cap. (⇒6-5)

Perform the following inspections after installation:

- Compression test
- Abnormal engine noise
- Cylinder air leaks

Spark Plug Engine Hood

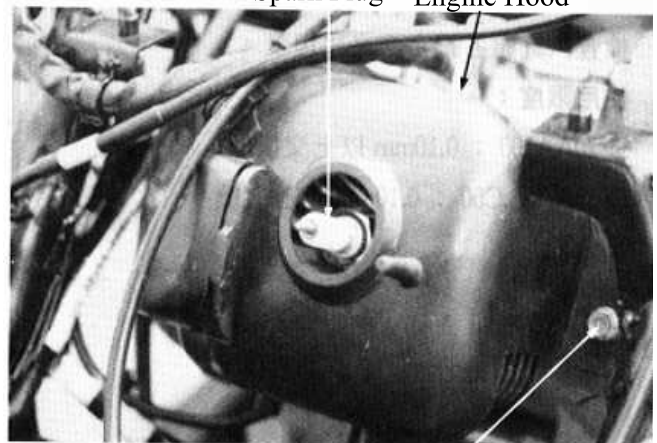

Bolts

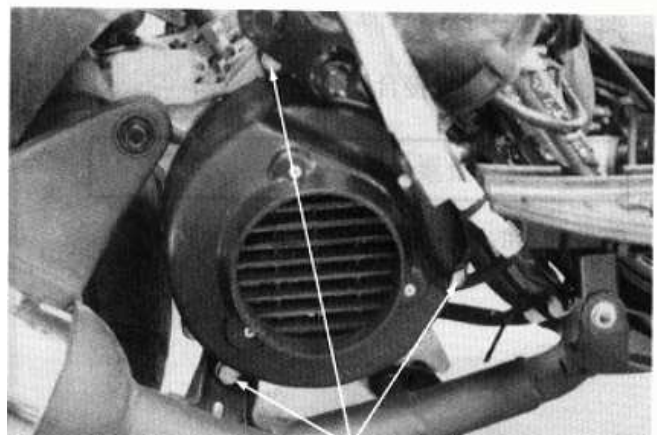

Bolts



## 6. CYLINDER HEAD/CYLINDER/PISTON

---

### CYLINDER/PISTON

#### CYLINDER REMOVAL

Remove the met-in box and seat.  
Remove the frame body cover.  
Remove the cylinder head. [ 6-4 ]  
Remove the two exhaust muffler joint lock nuts and two exhaust muffler lock bolts.  
Remove the exhaust muffler.  
Remove the cylinder.  
Remove the cylinder gasket.

\*

Do not pry between the cylinder and crankcase or strike the fins.



Exhaust Muffler Lock Bolts

Joint Lock Nuts

#### PISTON REMOVAL

Remove the piston pin clip to remove the piston pin and piston.

\*

- Do not damage or scratch the piston.
- Do not apply side force to the connecting rod when removing the piston pin.
- Place clean shop towels in the crankcase to keep the piston pin clip from falling into the crankcase.

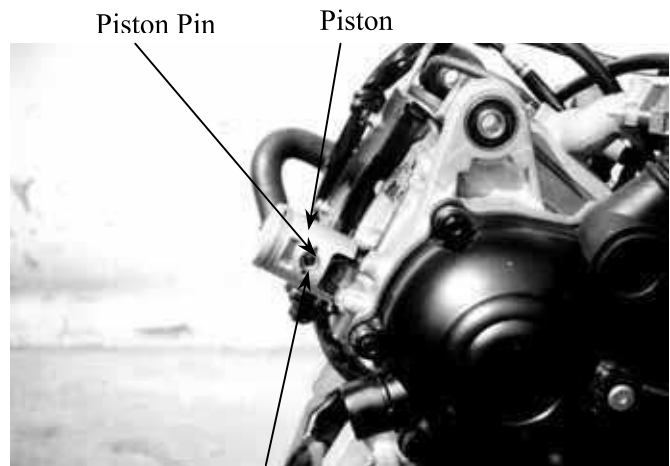

Piston Pin Clip

Spread each piston ring and remove by lifting it up at a point just opposite the gap.  
Remove the expander.



## 6. CYLINDER HEAD/CYLINDER/PISTON

---

### CYLINDER/PISTON INSPECTION

Check the cylinder and piston for wear or damage.

Clean carbon deposits from the exhaust port area.

\*

Be careful not to damage the cylinder inside wall.

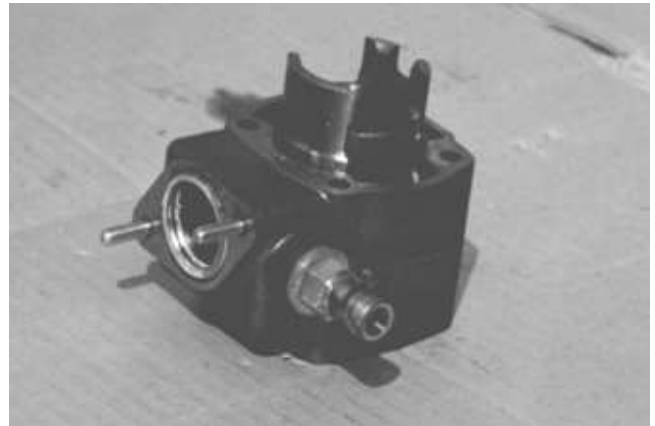

Measure the cylinder bore at three levels of A, B and C in both X and Y directions. Avoid the port area. Take the maximum figure measured to determine the cylinder bore.

#### Service Limit:

SH10BA: 51.05mm replace if over

SH10AA: 51.05mm replace if over

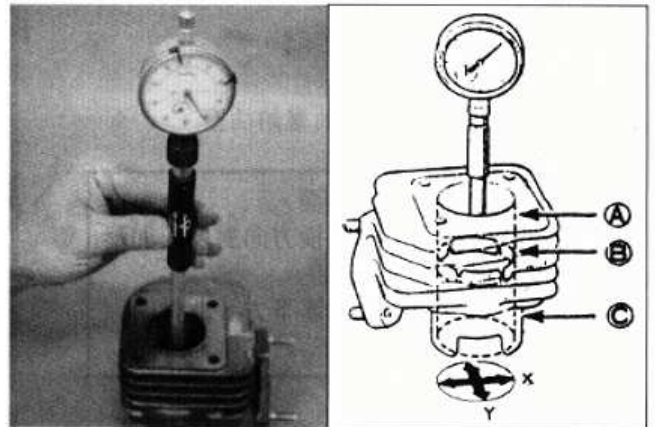

Inspect the top of the cylinder for warpage.

#### Service Limit:

SH10BA: 0.10mm replace if over

SH10AA: 0.10mm replace if over



## 6. CYLINDER HEAD/CYLINDER/PISTON

---

\*

The cylinder has an A mark or no mark on it. When replacing the cylinder with a new one, use a cylinder having the same mark as the old one.

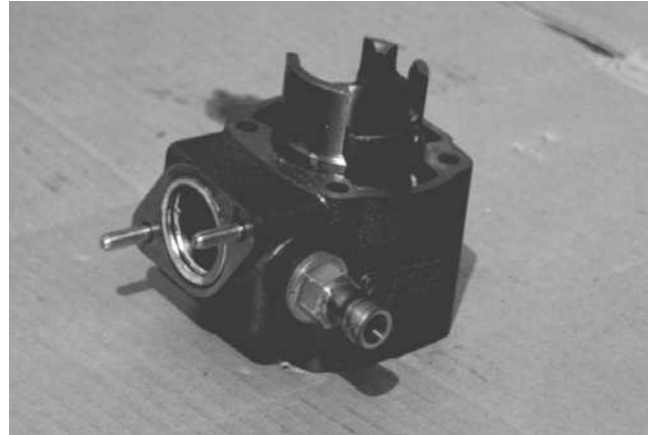

Measure the piston O.D. at a point 5mm from the bottom of the piston skirt.

**Service Limit:**

SH10BA: 38.90mm replace if below

SH10AA: 38.90mm replace if below

Measure the piston-to-cylinder clearance.

**Service Limit:**

SH10BA: 0.10mm replace if over

SH10AA: 0.10mm replace if over

Measure the piston pin hole I.D.

**Service Limit:**

SH10BA: 12.03mm replace if over

SH10AA: 12.03mm replace if over

Measure the piston pin O.D.

**Service Limit:**

SH10BA: 11.98mm replace if below

SH10AA: 11.98mm replace if below

Measure the piston-to-piston pin clearance.

**Service Limit:**

SH10BA: 0.03mm replace if over

SH10AA: 0.03mm replace if over

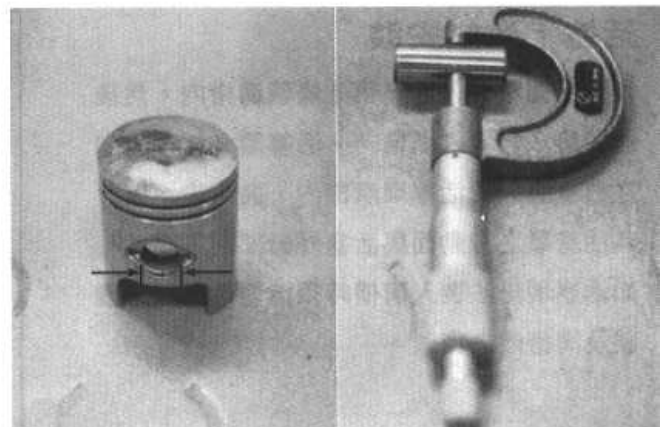
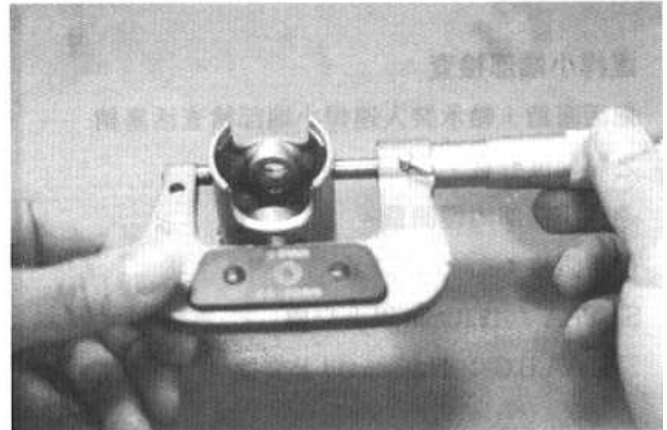

## 6. CYLINDER HEAD/CYLINDER/PISTON

### PISTON RING INSPECTION

Measure each piston ring end gap.

**Service Limits:** Top/Second

SH10BA: 0.40mm replace if over

SH10AA: 0.40mm replace if over

\* Set each piston ring squarely into the cylinder using the piston and measure the end gap.



### CONNECTING ROD SMALL END INSPECTION

Install the piston pin and bearing in the connecting rod small end and check for excessive play.

Measure the connecting rod small end I.D.

**Service Limit:**

SH10BA: 17.03mm replace if over

SH10AA: 17.03mm replace if over

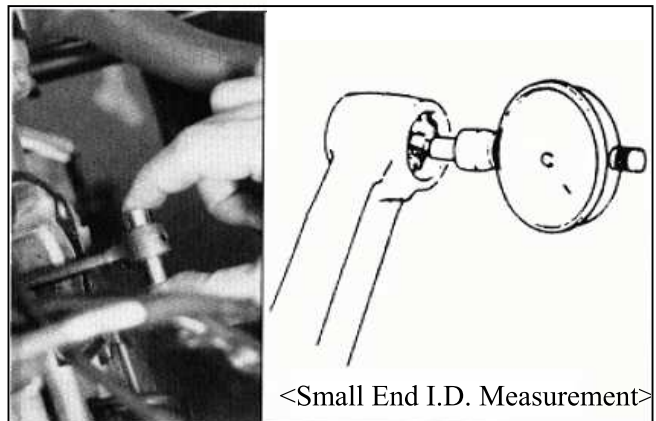

### PISTON/CYLINDER INSTALLATION

First install the expander in the second ring groove.

Then install the top and second rings in their respective ring grooves.

The piston rings should be pressed into the grooves with even force.

After installation, check and make sure that each ring is flush with the piston at several points around the ring.

A ring that will not compress means that the ring groove has carbon deposits in it and should be cleaned.

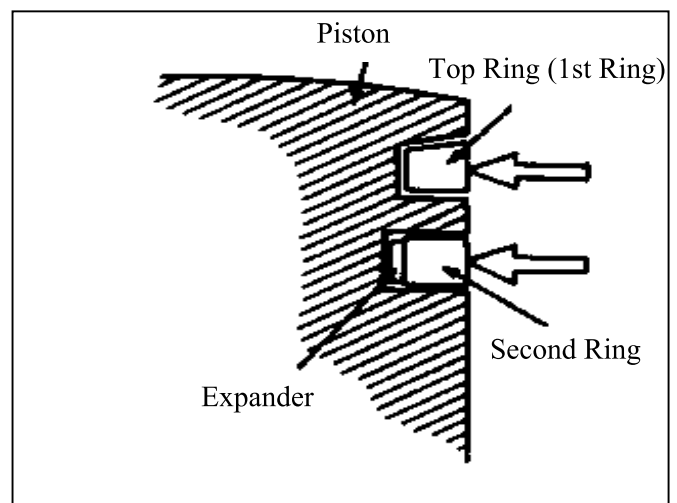

## 6. CYLINDER HEAD/CYLINDER/PISTON

---

Install a new cylinder gasket on the mating surface between the cylinder and crankcase.

Cylinder Gasket



Make sure that the ring end gaps are aligned with the piston ring pins in the ring grooves.

Ring Pins



Lubricate the cylinder inside and piston rings with engine oil and install the piston into the cylinder while compressing the piston rings.

\*

Be careful not to damage the piston.

Install the cylinder head.

**Torque:** 1.5~1.7kg-m

Install the exhaust muffler and tighten the exhaust muffler joint lock nuts.

**Torque:** 1.0~1.4kg-m

Tighten the exhaust muffler lock bolts.

**Torque:** 3.0~3.6kg-m

Install the frame covers.

# 7. KICK STARTER/DRIVE PULLEY/ CLUTCH/DRIVEN PULLEY

---

## KICK STARTER/DRIVE PULLEY/ CLUTCH/DRIVEN PULLEY

---

7

SERVICE INFORMATION .....	7- 2
TROUBLESHOOTING .....	7- 2
KICK STARTER.....	7- 3
DRIVE BELT .....	7- 7
DRIVE PULLEY.....	7- 9
STARTER ONE-WAY CLUTCH DRIVE GEAR.....	7-11
CLUTCH/DRIVEN PULLEY.....	7-12

# 7. KICK STARTER/DRIVE PULLEY/ CLUTCH/DRIVEN PULLEY

---

MODEL SH10BA.SH10AA

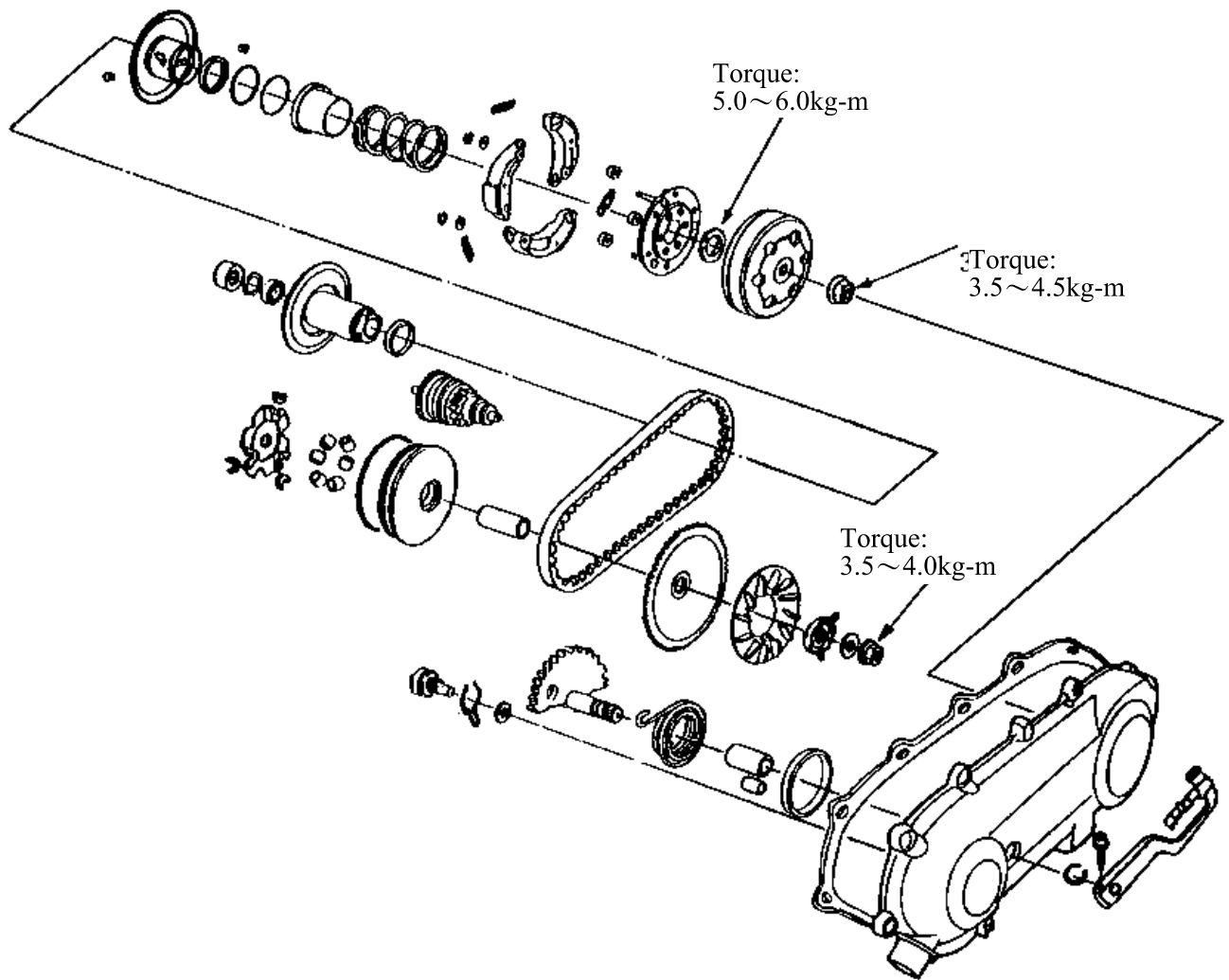

# 7. KICK STARTER/DRIVE PULLEY/ CLUTCH/DRIVEN PULLEY

---

## SERVICE INFORMATION

### GENERAL INSTRUCTIONS

- Avoid getting grease and oil on the drive belt and pulley faces.

SPECIFICATIONS	SH10BA		SH10AA	
	Standard (mm)	Service Limit (mm)	Standard (mm)	Service Limit (mm)
Drive pulley collar O.D.	20.01~20.025	24.24	20.01~20.025	24.24
Movable drive face I.D.	20.035~20.085	19.97	20.035~20.085	19.97
Weight roller O.D.	13.0	12.4	13.0	12.4
Clutch outer I.D.	107~107.2	107.5	107~107.2	107.5
Driven face spring free length	879	82.6	87.9	82.6
Driven face O.D.	33.965~33.985	33.94	33.965~33.985	33.94
Movable driven face I.D.	34.0~34.25	34.06	34.0~34.25	34.06
Drive belt width	18	17	18	17

### TORQUE VALUES

Drive face nut	3.5~4.0kg-m
Clutch outer nut	3.5~4.5kg-m
Clutch drive plate nut	5.0~6.0kg-m

### SPECIAL TOOLS

Lock nut wrench, 28mm	Universal holder
Clutch spring compressor	Lock nut socket wrench, 32mm
Bearing outer driver 37x40mm	Bearing driver pilot, 17mm
One-way clutch puller	Outer driver, 24x26mm

### TROUBLESHOOTING

#### Engine starts but motorcycle won't move

- Worn drive belt
- Broken ramp plate
- Worn or damaged clutch lining

#### Engine stalls or motorcycle creeps

- Broken clutch weight spring

#### Poor performance at high speed or lack of power

- Worn drive belt
- Weak driven face spring
- Worn weight roller
- Faulty driven face



## 7. KICK STARTER/DRIVE PULLEY/ CLUTCH/DRIVEN PULLEY

---

### KICK STARTER

#### LEFT CRANKCASE COVER REMOVAL

Remove the drive belt cooling air tube connector circlip.  
Remove the nine left crankcase cover bolts, left crankcase cover and dowel pins.  
Inspect the left crankcase cover seal rubber for damage or deterioration.

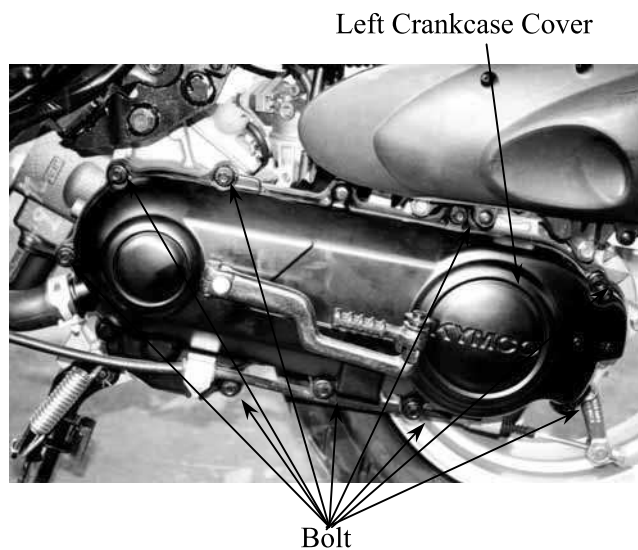

#### KICK STARTER SPINDLE REMOVAL

Remove the kick lever from the kick starter spindle.  
Remove the circlip and washer from the kick starter spindle.

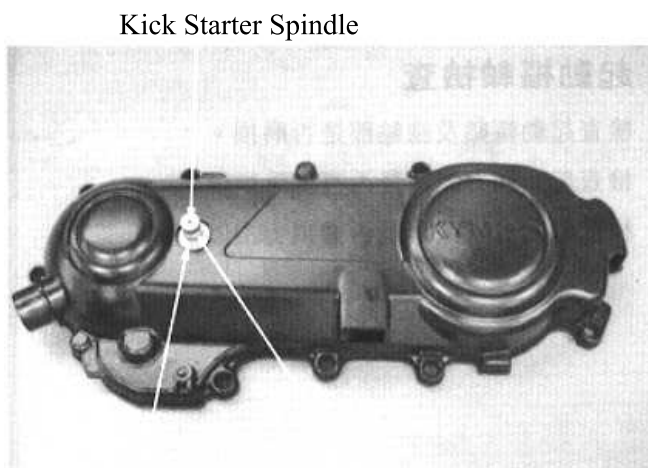

Slightly rotate the kick starter spindle to remove the kick starter driven gear together with the friction spring.

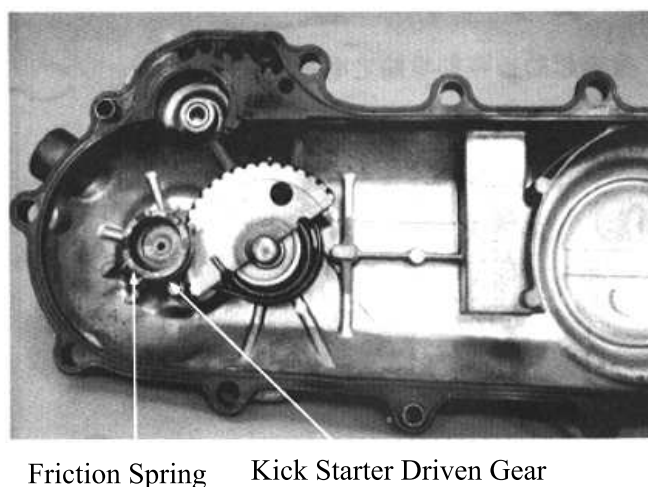

## 7. KICK STARTER/DRIVE PULLEY/ CLUTCH/DRIVEN PULLEY

---

Remove the kick starter spindle and return spring from the left crankcase cover.  
Remove the kick starter spindle bushing.

### **KICK STARTER SPINDLE INSPECTION**

Inspect the kick starter spindle and gear for wear or damage.  
Inspect the return spring for weakness or damage.  
Inspect the kick starter spindle bushing for wear or damage.

Check the kick starter driven gear for wear or damage.  
Check the friction spring for wear or damage.

Kick Starter Spindle

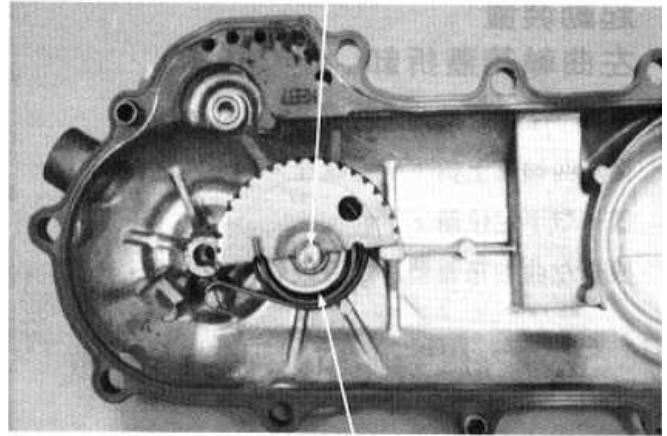

Return Spring

Spindle    Return Spring

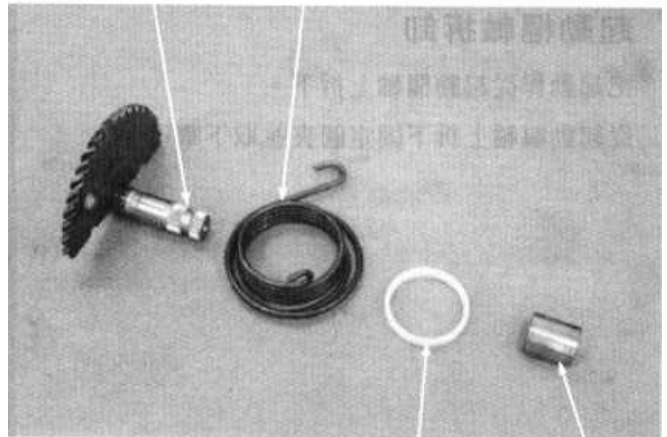

Plastic Bushing    Spindle Bushing

Friction Spring

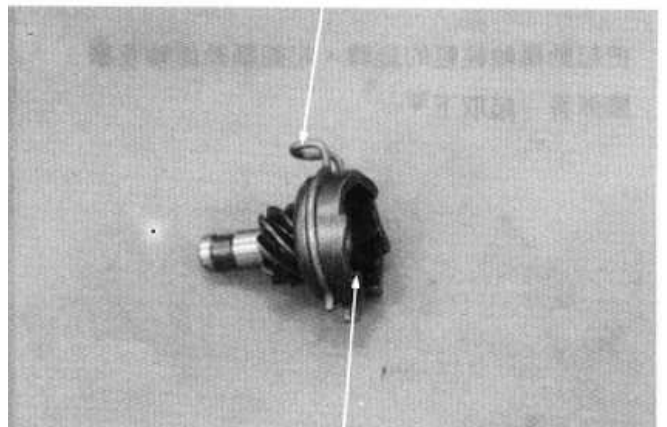

Kick Starter Driven Gear

## 7. KICK STARTER/DRIVE PULLEY/ CLUTCH/DRIVEN PULLEY

---

Inspect the kick starter spindle and driven gear forcing parts for wear or damage.

Kick Starter Spindle Forcing Part

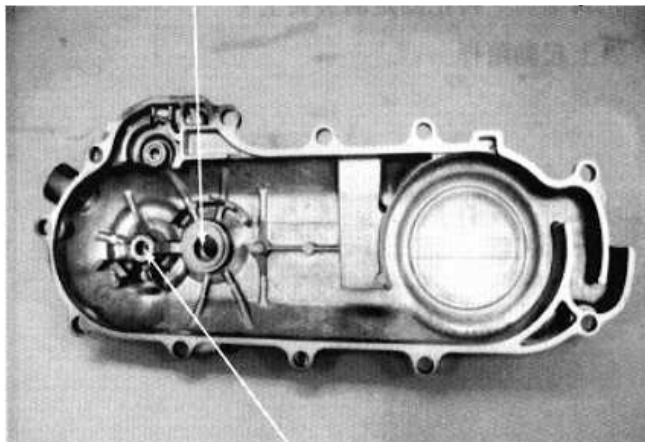

Kick Starter Driven Gear Forcing Part

### KICK STARTER INSTALLATION

Install the kick starter spindle bushing and return spring onto the left crankcase cover.

\* If the hooks of the return spring can not be installed properly, use a screw driver to press them into their locations respectively.

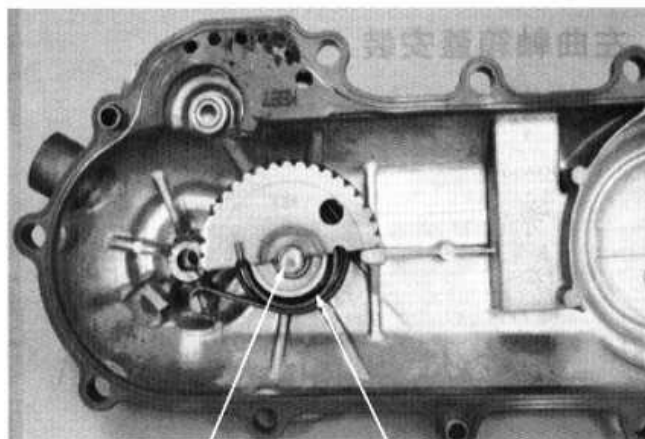

Kick Starter Spindle Friction Spring

Friction Spring

Properly install the kick starter driven gear and friction spring as the figure shown.

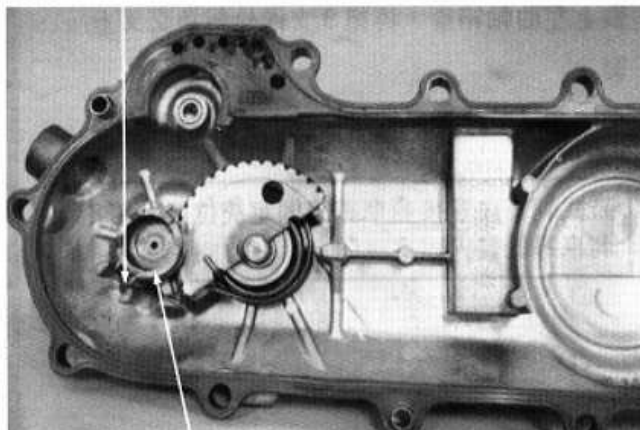

Kick Starter Driven Gear

## 7. KICK STARTER/DRIVE PULLEY/ CLUTCH/DRIVEN PULLEY

---

First install the washer and then the circlip onto the kick starter spindle.  
Install the kick lever.

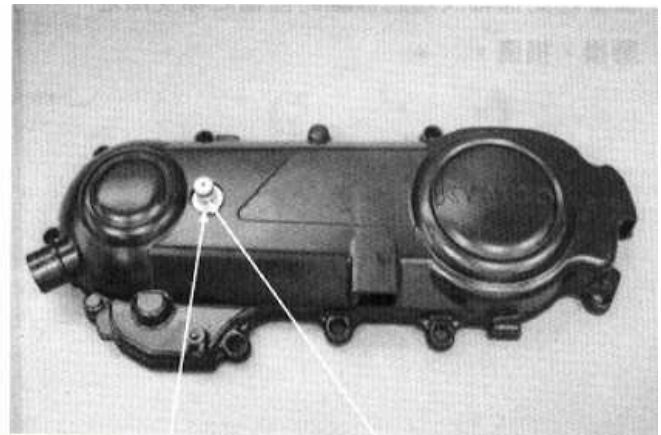

Washer

Circlip

Dowel Pins

### LEFT CRANKCASE COVER INSTALLATION

First install the dowel pins and then the seal rubber.

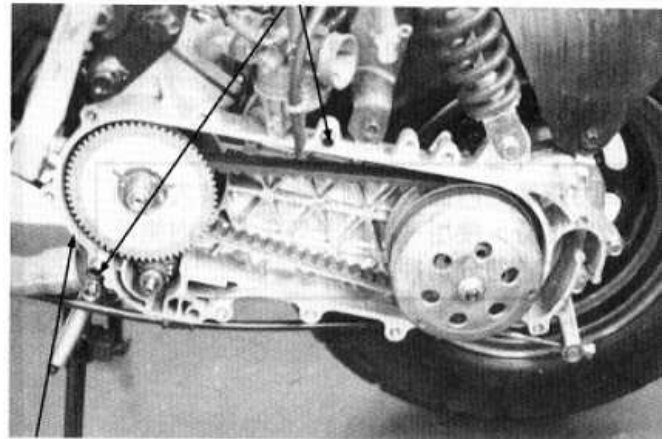

Seal Rubber

Left Crankcase Cover

Install the left crankcase cover and tighten the nine bolts diagonally.  
Connect the drive belt cooling air tube and install the circlip.

\* For drum brake, note the location of the brake cable clamp and install the rear brake cable in place with the clamp.

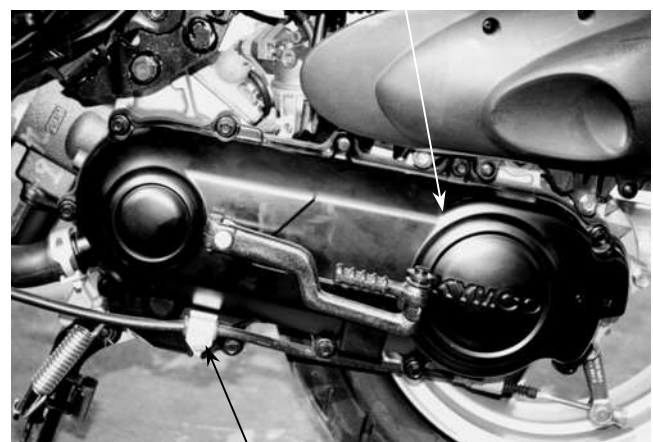

Rear Brake Cable Clamp



## 7. KICK STARTER/DRIVE PULLEY/ CLUTCH/DRIVEN PULLEY

---

### DRIVE BELT

Remove the left crankcase cover.

### INSPECTION

Check the drive belt for cracks, separation or abnormal or excessive wear.  
Measure the drive belt width.

### Service Limit:

SH10BA: 16.5mm replace if below

SH10AA: 16.5mm replace if below

\* Use specified genuine parts for replacement.

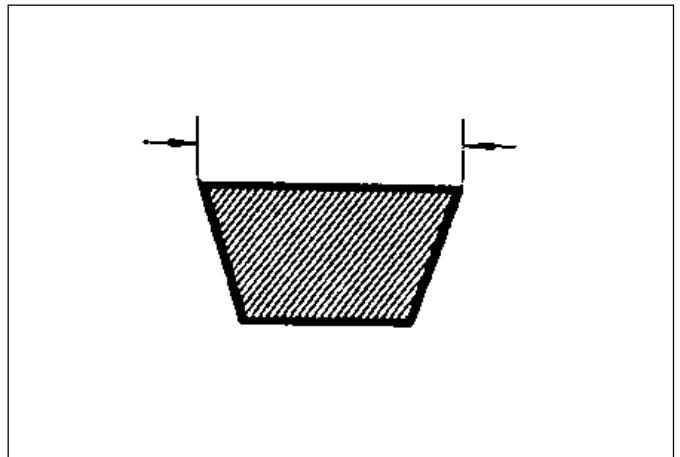

### REPLACEMENT

Remove the nine left crankcase cover bolts and left crankcase cover. (⇒7-3)

Hold the clutch outer with the universal holder and remove the 10mm clutch outer nut and clutch outer.

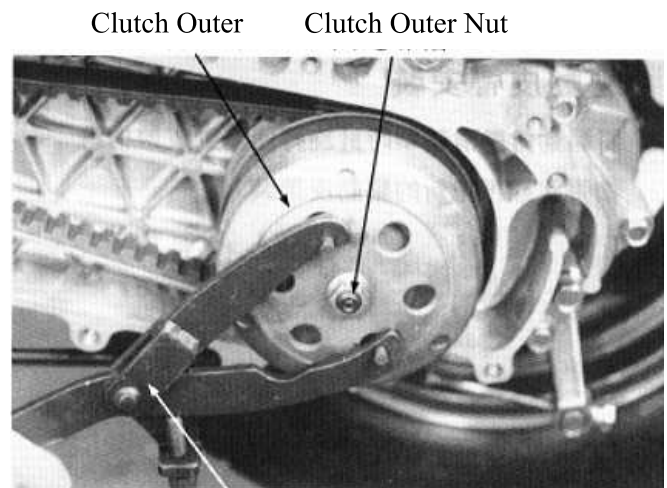

Universal Holder

Hold the drive pulley with the holder and remove the 12mm drive face nut.  
Remove the starting ratchet.  
Remove the drive pulley face.

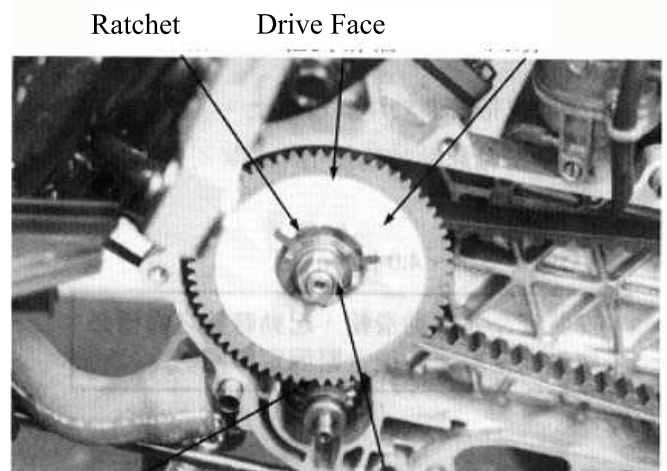

Drive Face Nut

## 7. KICK STARTER/DRIVE PULLEY/ CLUTCH/DRIVEN PULLEY

---

Remove the drive belt from the clutch/  
driven pulley.

Clutch/Driven Pulley

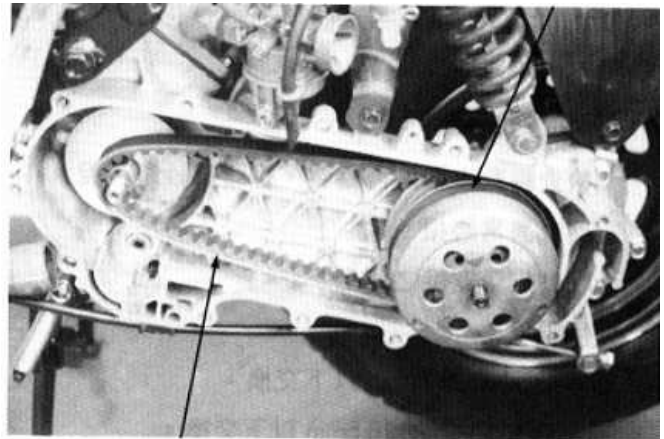

Drive Belt

### DRIVE BELT INSTALLATION

Turn the driven pulley clockwise and lift it  
up to expand the drive belt groove and then  
install a new drive belt.

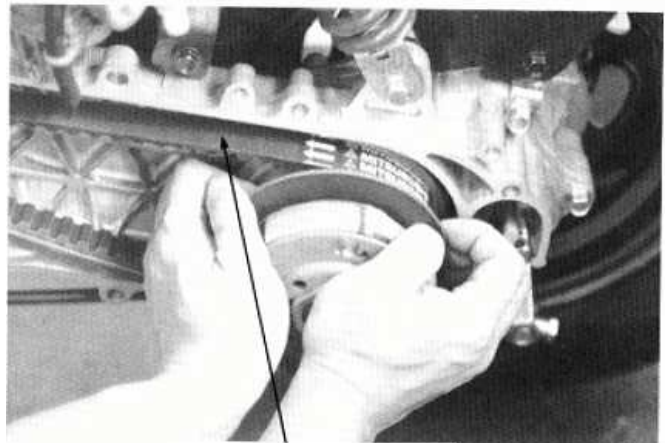

Drive Belt

Set the drive belt on the drive pulley.  
Install the drive pulley face, starting ratchet  
and 12mm washer, then tighten the drive  
face nut.

**Torque:** 3.5~4.0kg-m

\* When installing the drive face nut, make  
sure that the tooth spaces of the drive  
pulley face and starting ratchet align  
with the teeth of the crankshaft.

Drive Face Nut      Drive Pulley Face      Drive Belt

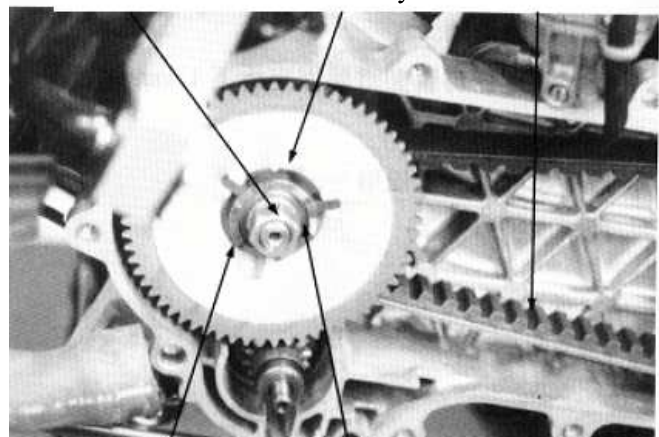

Starting Ratchet

12mm Washer

## 7. KICK STARTER/DRIVE PULLEY/ CLUTCH/DRIVEN PULLEY

---

### DRIVE PULLEY

#### REMOVAL

Hold the drive pulley with the holder and remove the 12mm drive face nut. Remove the starting ratchet, 12mm washer and drive pulley face.

Drive Pulley Face Starting Ratchet

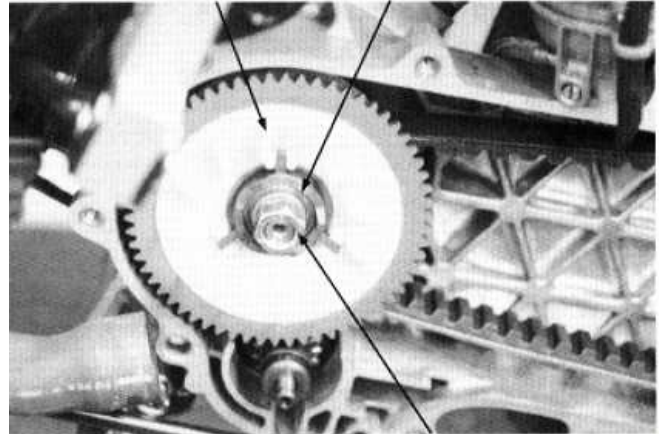

12mm Drive Face Nut

#### MOVABLE DRIVE FACE DISASSEMBLY

Remove the movable drive face and drive pulley collar from the crankshaft.

Movable Drive Face

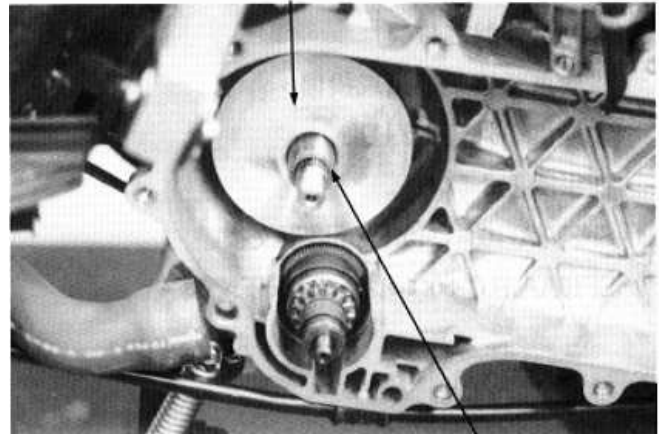

Drive Pulley Collar

Remove the ramp plate.

Ramp Plate

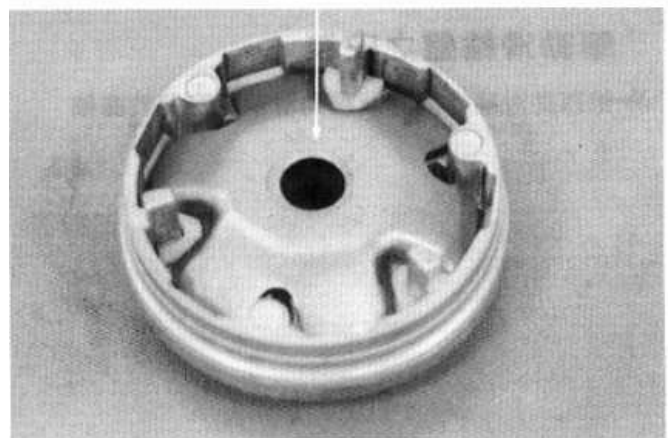

## 7. KICK STARTER/DRIVE PULLEY/ CLUTCH/DRIVEN PULLEY

---

Remove the weight rollers.

Weight Roller

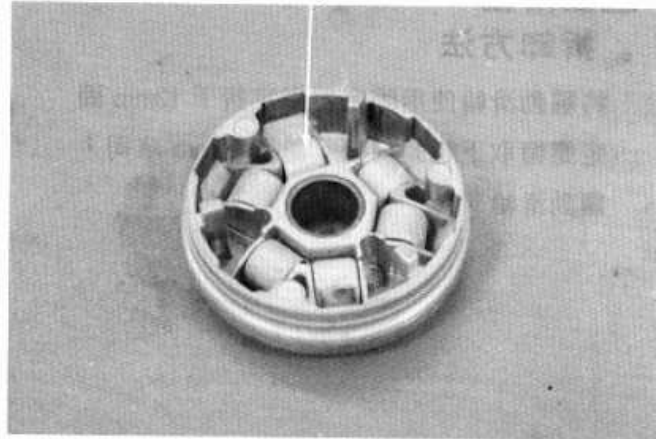

### MOVABLE DRIVE FACE INSPECTION

Check each weight roller for wear or damage.

Measure each roller O.D.

#### Service Limit:

SH10BA: 12.4mm replace if below

SH10AA: 12.4mm replace if below

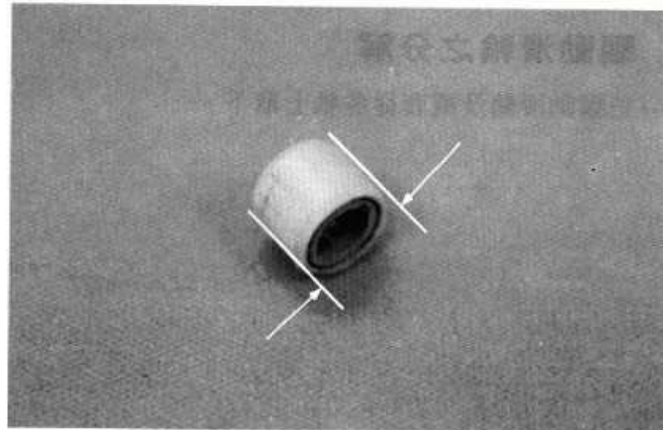

### DRIVE PULLEY INSTALLATION

Install the drive pulley collar and movable drive face onto the crankshaft.

Movable Drive Face

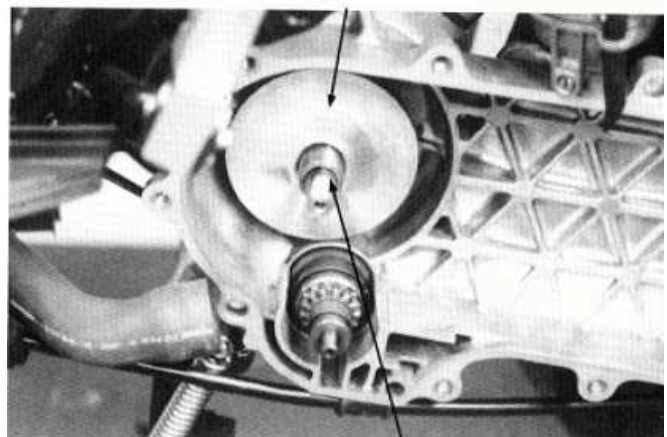

Drive Pulley Collar



## 7. KICK STARTER/DRIVE PULLEY/ CLUTCH/DRIVEN PULLEY

Install the drive belt on the crankshaft.  
Install the drive face, starting ratchet and washer, then tighten the 12mm drive face nut.

**Torque:** 3.5~4.0kg-m

\* Keep grease or oil off the drive belt and drive pulley faces.

Drive Pulley Face

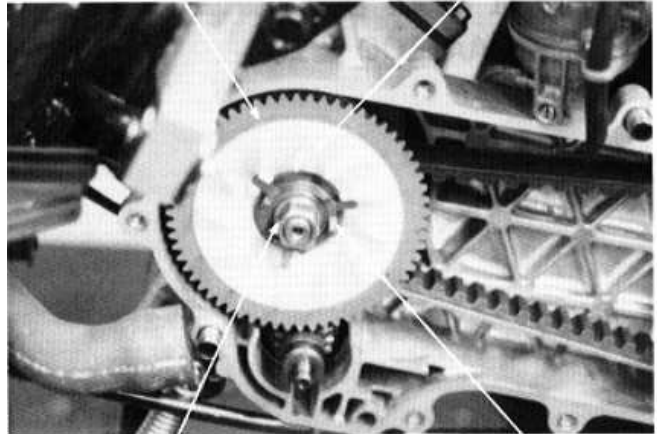

Drive Face Nut

Starting Ratchet

### STARTER PINION REMOVAL

Remove the left crankcase cover. (⇒7-3)  
Remove the drive pulley. (⇒7-7)  
Remove the starter pinion.

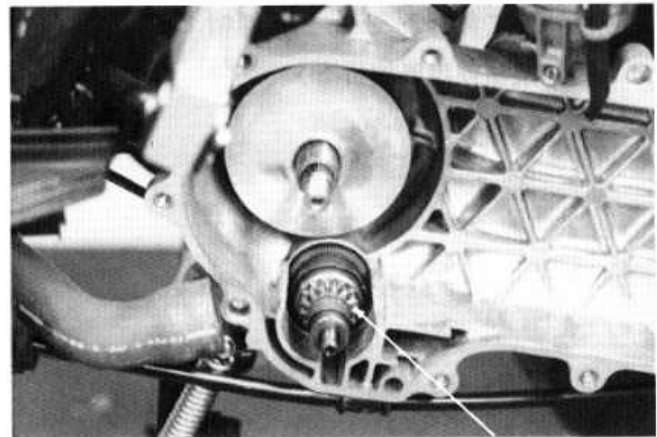

Starter Pinion

### INSPECTION

Inspect the starter pinion seat for wear.  
Inspect the starter pinion for smooth operation.  
Inspect the starter pinion shaft forcing parts for wear and damage.

### INSTALLATION

Apply a small amount of grease to the starter pinion teeth.  
Install the starter pinion in the reverse order of removal.

Shaft Forcing Parts



Starter Pinion

## 7. KICK STARTER/DRIVE PULLEY/ CLUTCH/DRIVEN PULLEY

---

### CLUTCH/DRIVEN PULLEY

#### CLUTCH/DRIVEN PULLEY REMOVAL

Remove the drive pulley. (⇒7-7)  
Hold the clutch outer with the universal holder and remove the 10mm clutch outer nut.  
Remove the clutch outer.

Clutch Outer

10mm Clutch Outer Nut

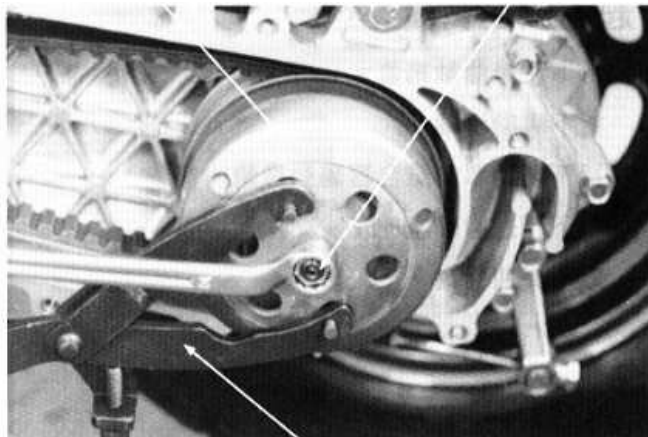

Universal Holder

Remove the clutch/driven pulley.  
Remove the drive belt from the clutch/driven pulley.

Clutch/Driven Pulley

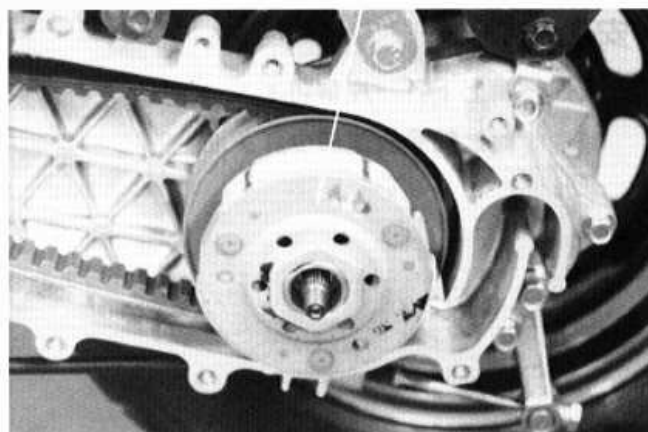

#### CLUTCH/DRIVEN PULLEY DIS-ASSEMBLY

Compress the clutch/driven pulley spring with the clutch spring compressor and remove the 28mm drive plate nut.  
Remove the driven face spring.

Lock Nut Wrench, 28mm

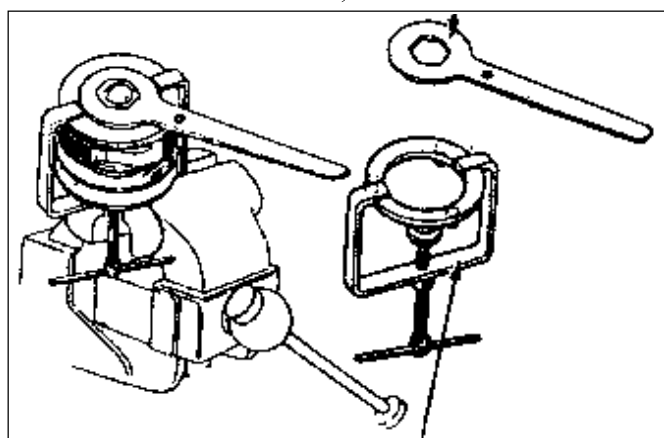

Clutch Spring Compressor

## 7. KICK STARTER/DRIVE PULLEY/ CLUTCH/DRIVEN PULLEY

---

Remove the seal collar.

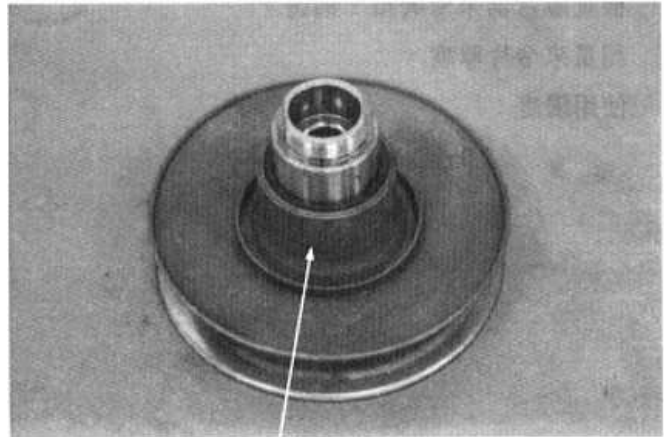

Seal Collar

Pull out the guide roller pins from the driven pulley and then remove the O-rings and oil seal from the driven pulley.

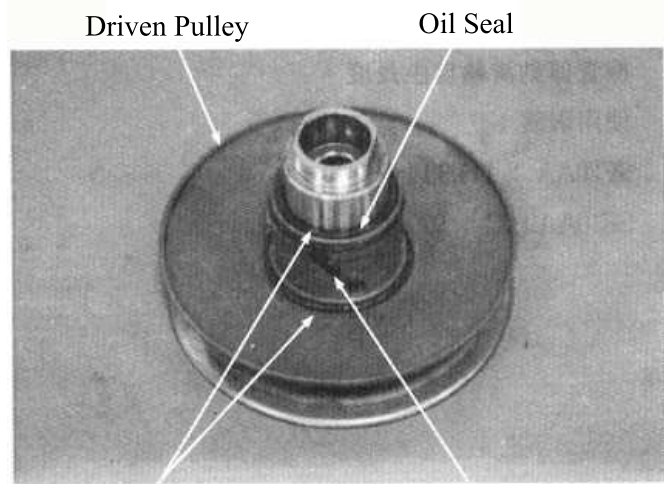

Driven Pulley

Oil Seal

O-rings

Guide Roller Pin

### CLUTCH/DRIVEN PULLEY INSPECTION

Inspect the clutch outer for wear or damage.  
Measure the clutch outer I.D.

#### Service Limit:

SH10BA: 107.5mm replace if below

SH10AA: 107.5mm replace if below

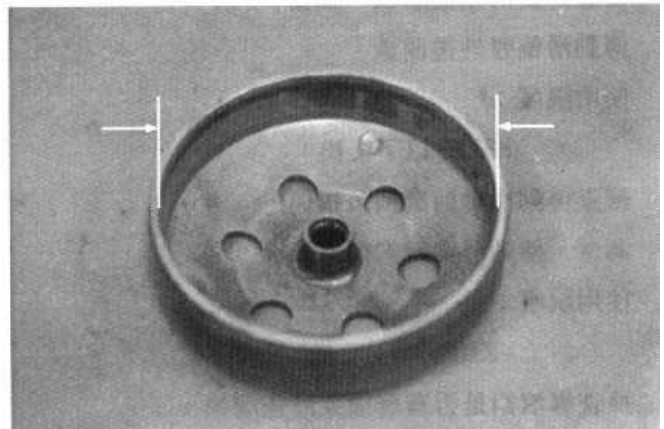

## 7. KICK STARTER/DRIVE PULLEY/ CLUTCH/DRIVEN PULLEY

---

Check the clutch shoes for wear or damage.  
Measure the clutch lining thickness.

**Service Limit:** 2.0mm replace if below

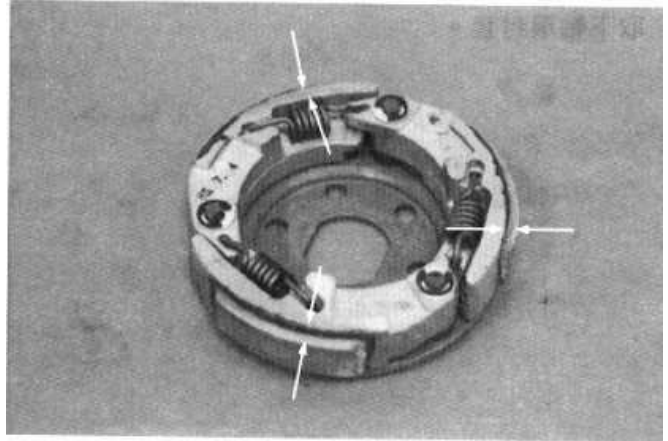

Measure the driven face spring free length.

**Service Limit:**

SH10BA: 82.6mm replace if below

SH10AA: 82.6mm replace if below

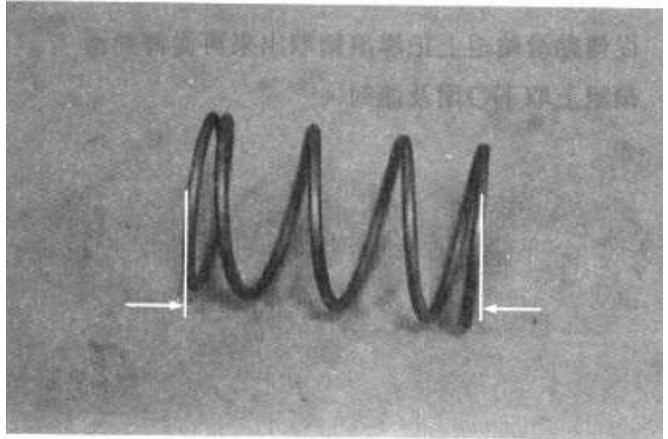

Check the driven face assembly for wear or damage.

Measure the driven face O.D.

**Service Limit:** 33.94mm replace if below

Check the movable driven face for wear or damage.

Measure the movable driven face I.D.

**Service Limit:** 34.06mm replace if below

Check the guide roller pins for stepped wear.

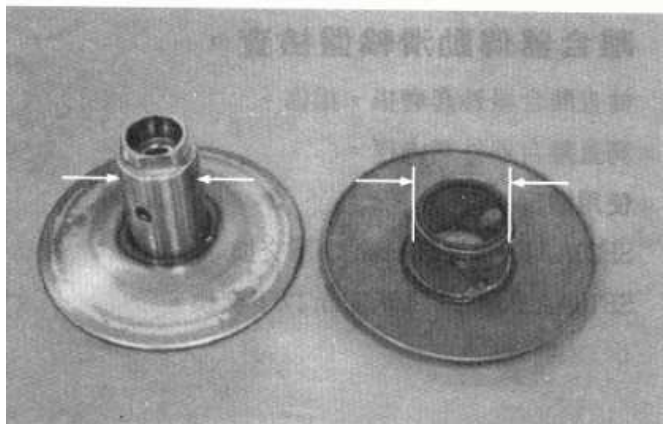



## 7. KICK STARTER/DRIVE PULLEY/ CLUTCH/DRIVEN PULLEY

---

### DRIVEN PULLEY FACE BEARING REPLACEMENT

Check the needle bearings in the driven face and replace them if they have excessive play, damage or abnormal noise. Drive the inner bearing out of the driven pulley face.

Inner Bearing

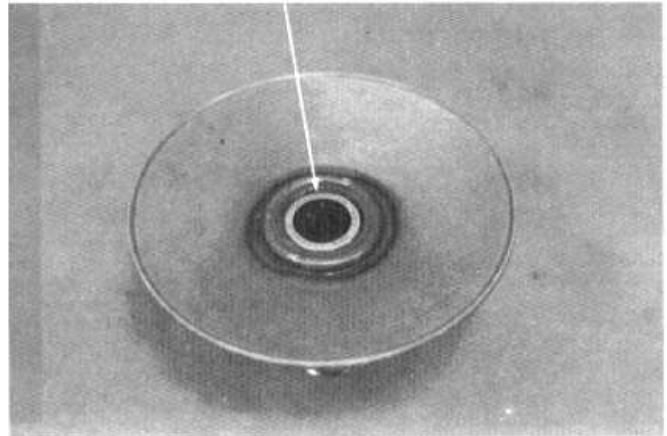

Remove the snap ring and drive the outer bearing out of the driven face.

Snap Ring

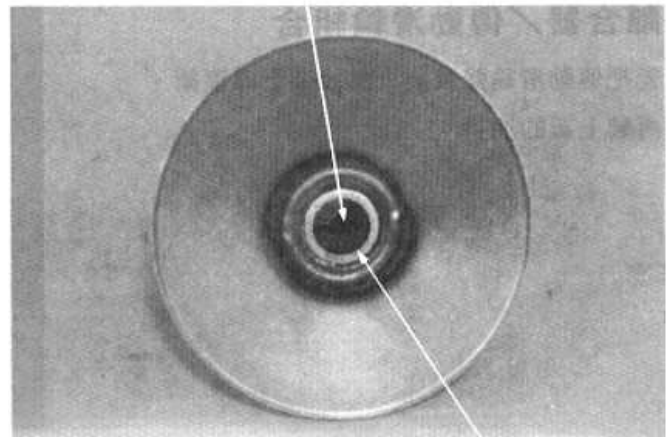

Outer Bearing

Drive a new outer bearing into the driven face with the sealed end facing up. Seat the snap ring in its groove.

\* Pack all bearing cavities with 5.0~5.6g grease.  
Specified grease: 230°C Heat-resistant grease

Bearing Outer Driver, 37x40mm

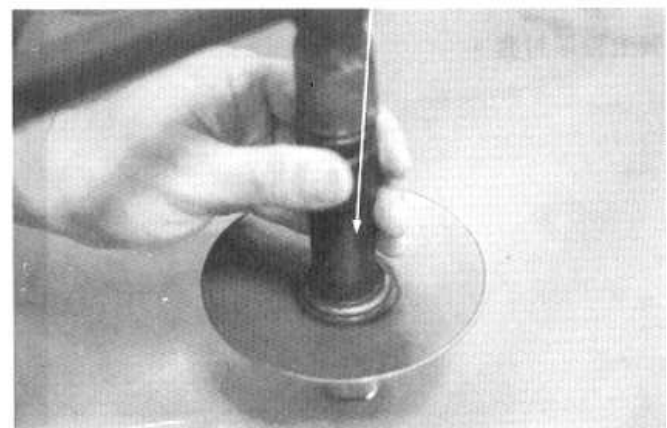

## 7. KICK STARTER/DRIVE PULLEY/ CLUTCH/DRIVEN PULLEY

---

Drive in a new needle bearing into the driven face with the mark facing up.

Bearing Driver Pilot

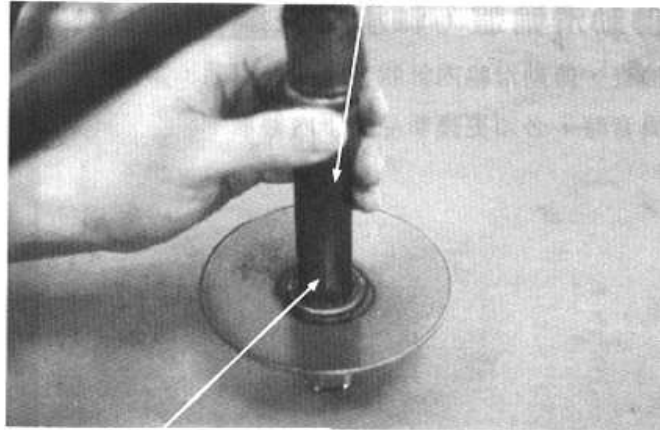

Outer Driver, 24x26mm

### CLUTCH/DRIVEN PULLEY ASSEMBLY

First install the movable driven face onto the driven face. Then, install the guide roller pins, O-rings and a new oil seal.

Driven Pulley

Oil Seal

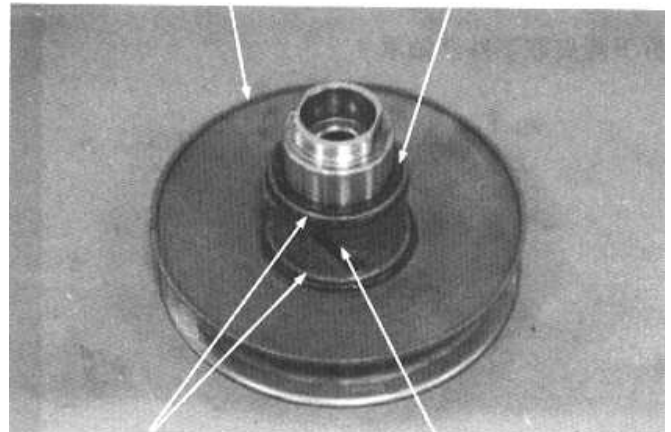

O-rings

Guide Roller Pin

Install the seal collar.

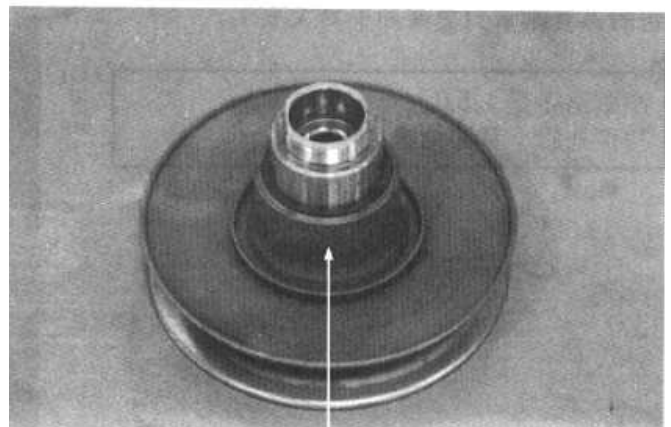

Seal Collar

## 7. KICK STARTER/DRIVE PULLEY/ CLUTCH/DRIVEN PULLEY

---

Set the driven pulley, driven face spring and clutch assembly onto the clutch spring compressor. Compress the tool and install the 28mm drive plate nut. Tighten the 28mm nut to the specified torque.

**Torque:** 5.0~6.0kg-m

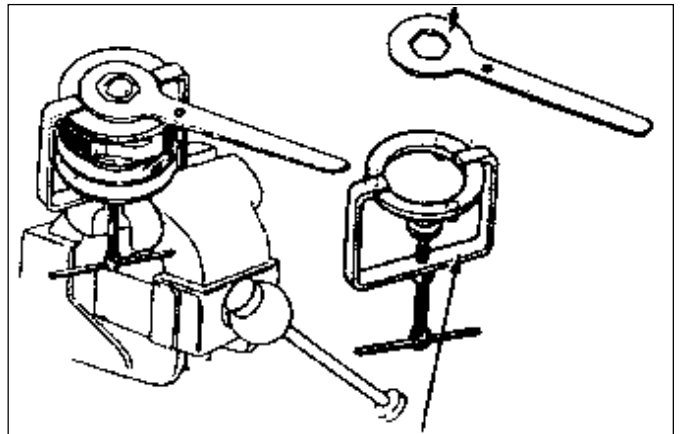

### CLUTCH/DRIVEN PULLEY INSTALLATION

Install the drive belt on the clutch/driven pulley and then install the clutch/driven pulley onto the drive shaft.

Clutch/Driven Pulley

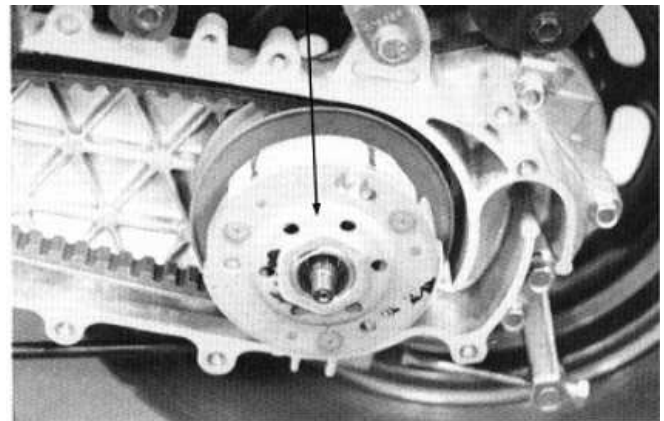

Install the clutch outer.  
Hold the clutch outer with the universal holder.  
Install and tighten the 10mm clutch outer nut.

**Torque:** 3.5~4.5kg-m

Install the left crankcase cover. (⇒7-6)

Clutch Outer

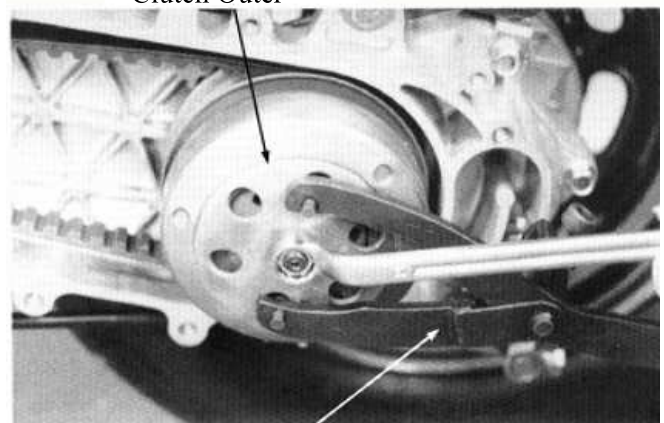

Universal Holder

# 8. FINAL REDUCTION

---

---

## FINAL REDUCTION

---

SERVICE INFORMATION .....	8-2
TROUBLESHOOTING .....	8-2
FINAL REDUCTION DISASSEMBLY .....	8-3
FINAL REDUCTION INSPECTION.....	8-3
FINAL REDUCTION ASSEMBLY .....	8-6





## 8. FINAL REDUCTION

---

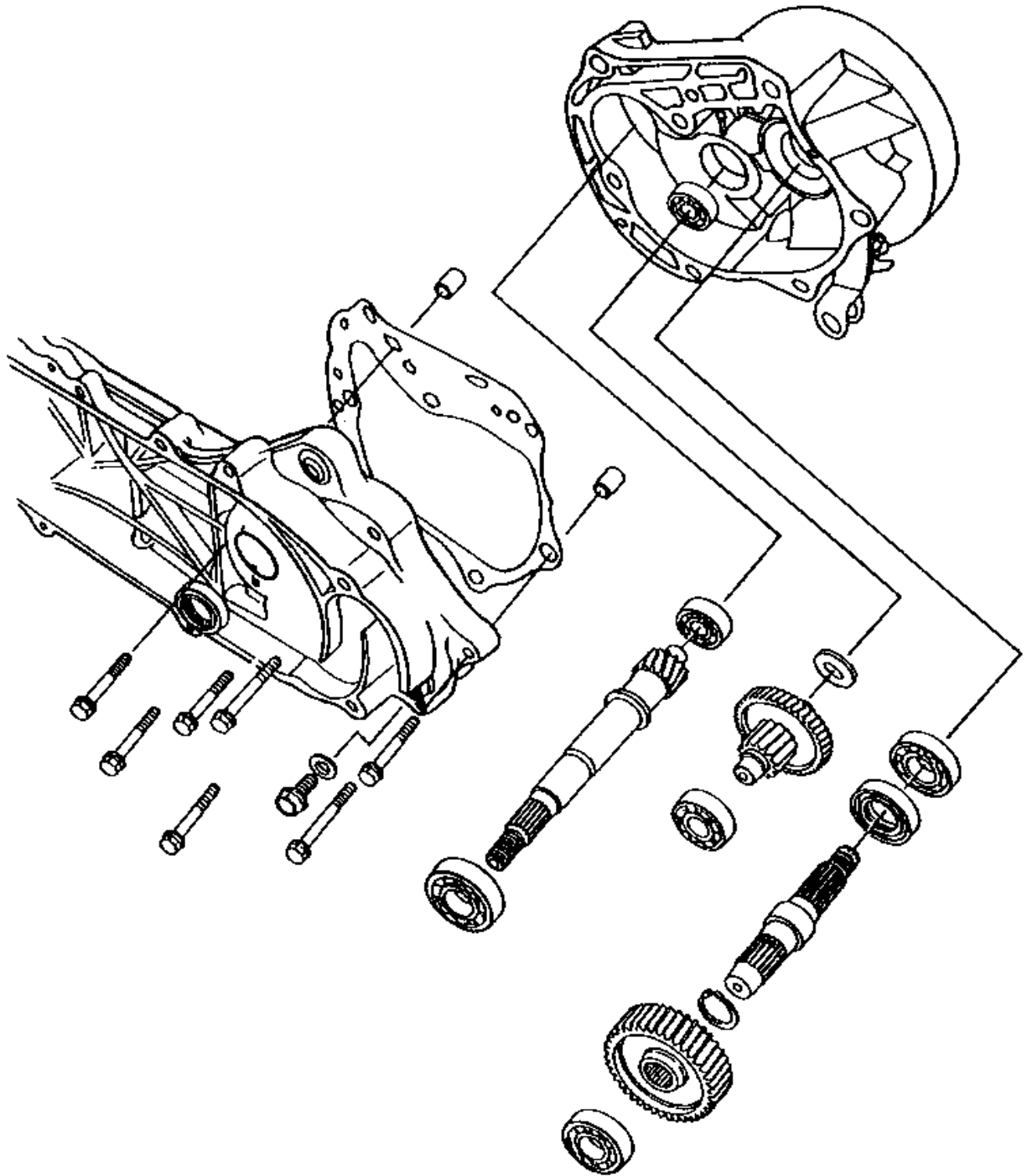

## 8. FINAL REDUCTION

---

### SERVICE INFORMATION

Specified Oil: SAE90#  
At disassembly: 0.12 liter  
At change: 0.1 liter

### SPECIAL TOOLS

Bearing remover set, 12mm  
Bearing remover set, 15mm  
Crankcase assembly collar  
Crankcase assembly shaft  
Bearing outer driver, 37x40mm  
Bearing outer driver, 32x35mm  
Bearing driver pilot, 17mm  
Bearing driver pilot, 15mm  
Bearing driver pilot, 12mm  
Bearing outer driver handle A

### TROUBLESHOOTING

#### **Engine starts but motorcycle won't move**

- Damaged transmission
- Seized or burnt transmission

#### **Abnormal noise**

- Worn, seized or chipped gears
- Worn bearing

#### **Oil leaks**

- Oil level too high
- Worn or damaged oil seal

## 8. FINAL REDUCTION

---

### FINAL REDUCTION DISASSEMBLY

Remove the rear wheel. (⇒14-3)  
Remove the left crankcase cover. (⇒7-3)  
Remove the clutch/driven pulley. (⇒7-12)  
Drain the transmission gear oil into a clean container.  
Remove the transmission case cover attaching bolts.  
Remove the transmission case cover.  
Remove the gasket and dowel pins.

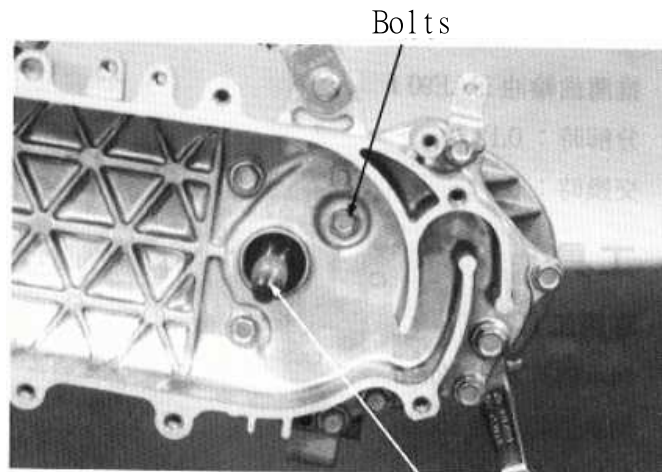

Driver shift

Remove the final gear and countershaft.

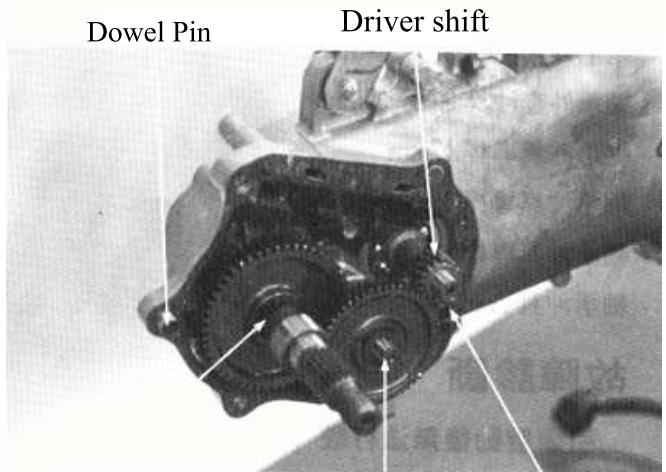

Final Gear

Countershaft

Dowel Pin

### FINAL REDUCTION INSPECTION

Inspect the countershaft and gear for wear or damage.



Countershaft

## 8. FINAL REDUCTION

---

Inspect the final gear and final shaft for wear, damage or seizure.

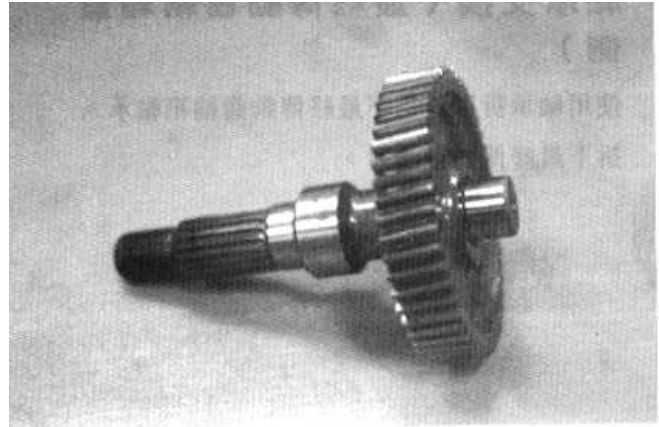

Check the left crankcase bearings for excessive play and inspect the oil seal for wear or damage.

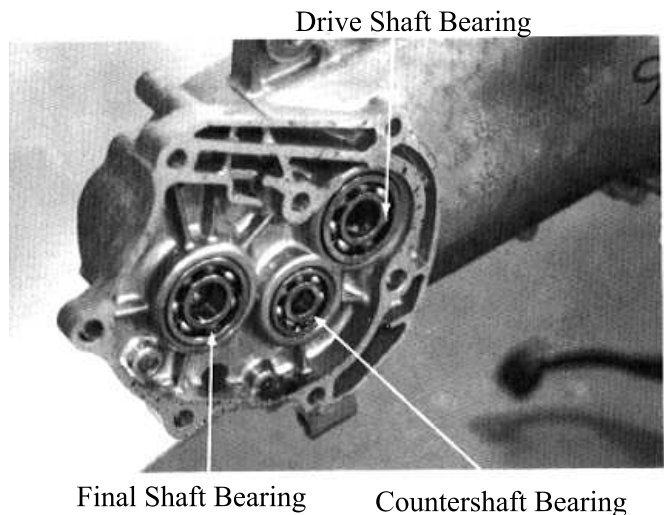

Inspect the drive shaft and gear for wear or damage.  
Check the transmission case cover bearings for excessive play and inspect the final shaft bearing oil seal for wear or damage.

\* Do not remove the transmission case cover except for necessary part replacement. When replacing the drive shaft, also replace the bearing and oil seal.

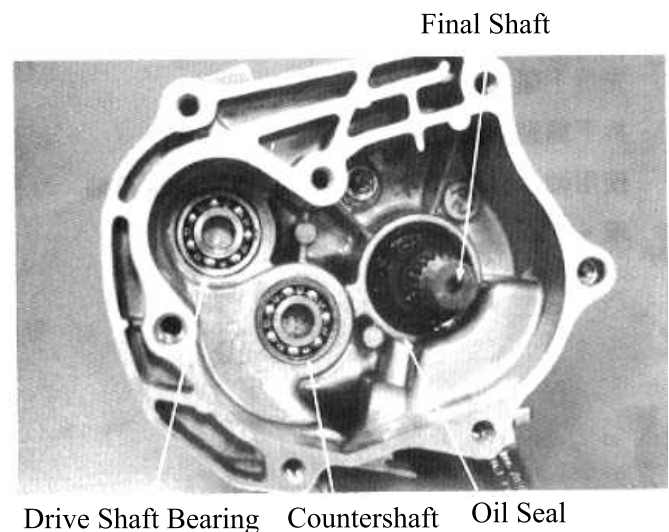

## 8. FINAL REDUCTION

---

### BEARING REPLACEMENT (Transmission Case Cover)

Remove the transmission case cover bearings using the bearing remover.  
Remove the final shaft oil seal.

Drive Shaft Bearing

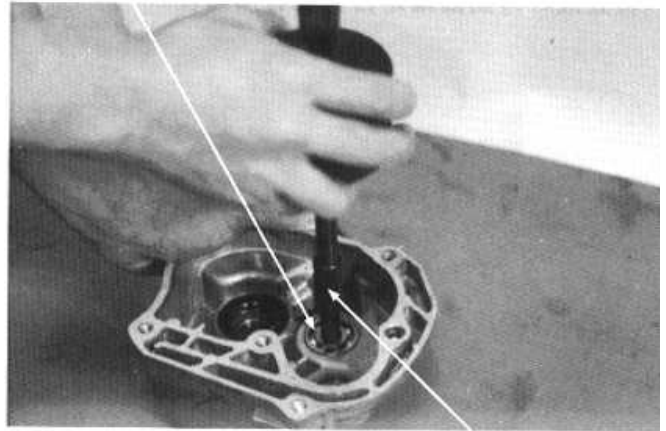

Bearing Remover Set

Drive new bearings into the transmission case cover.

Bearing Outer Driver Handle A

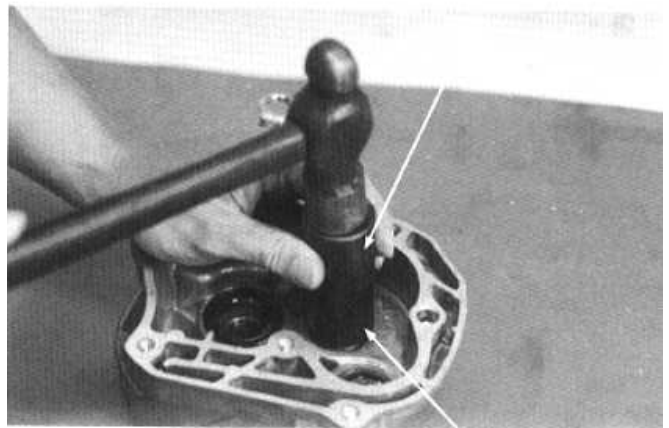

Bearing Outer Driver, 32x35mm

### BEARING REPLACEMENT (Left Crankcase Cover)

Remove the drive shaft.  
Remove the drive shaft oil seal.  
Remove the left crankcase bearings using the bearing remover.

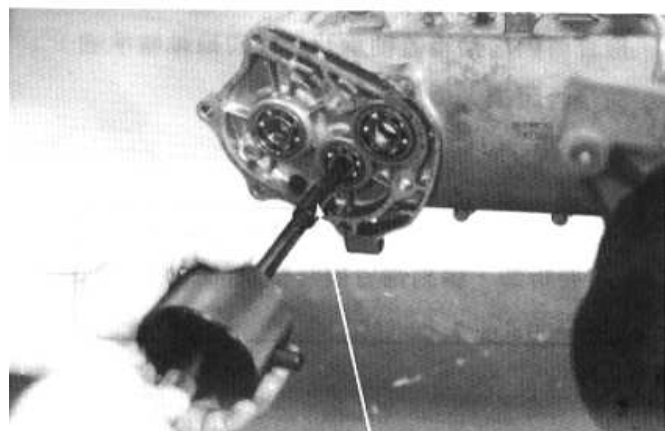

Bearing Remover Set, 12mm

## 8. FINAL REDUCTION

---

Drive new bearings into the left crankcase.  
Install a new drive shaft oil seal.

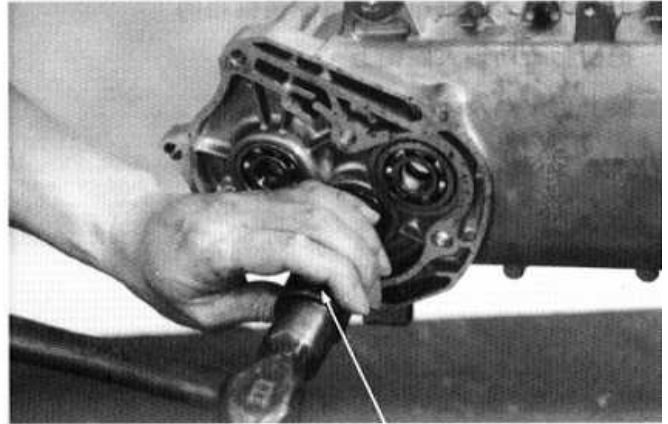

Bearing Outer Driver

### FINAL REDUCTION ASSEMBLY

Install the drive shaft into the left crankcase.

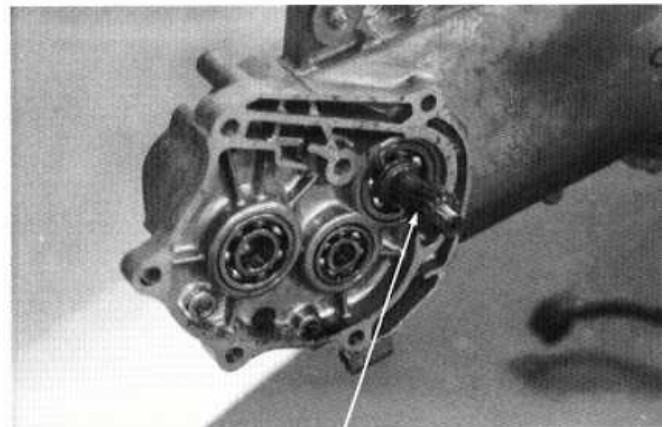

Drive Shaft

Install the final gear and final shaft into the left crankcase.

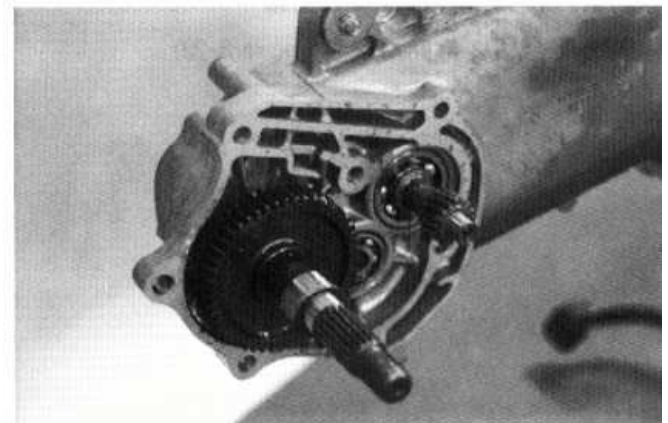

## 8. FINAL REDUCTION

---

Install the countershaft and gear into the left crankcase.  
Install the resin washer onto the countershaft.  
Install the dowel pins and a new gasket.

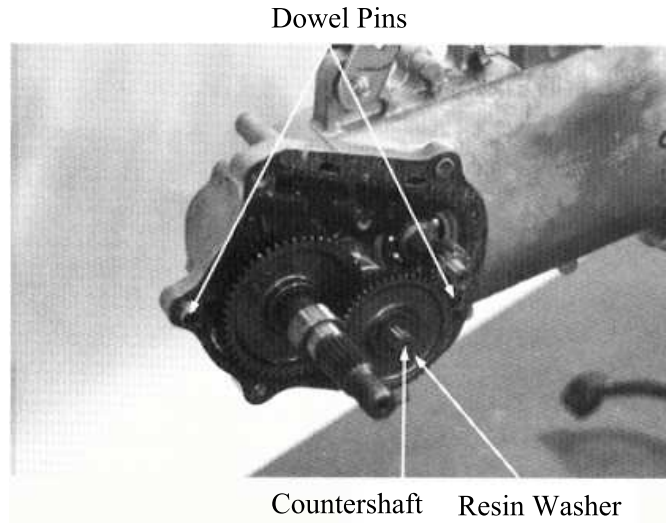

Install the transmission case cover.

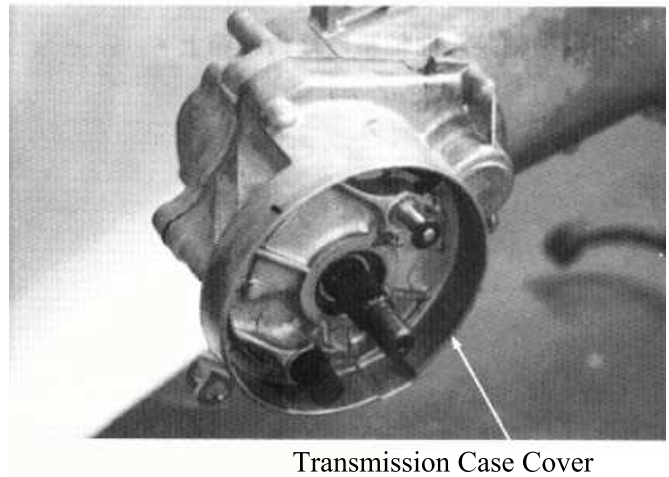

Install and tighten the transmission case cover bolts.  
Install the clutch/driven pulley. (⇒7-16)  
Install other removed parts in the reverse order of removal.

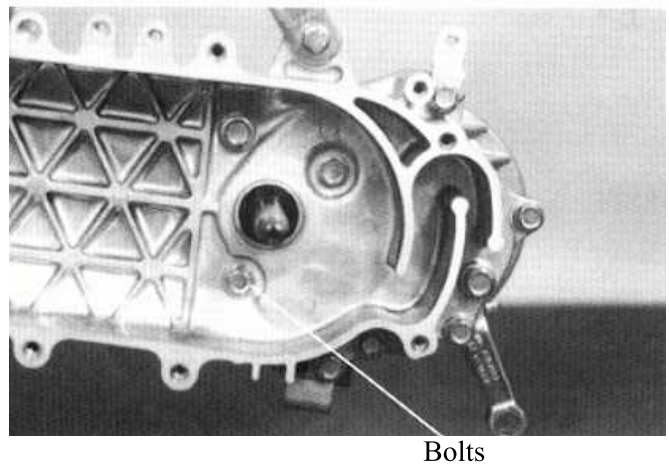



## 8. FINAL REDUCTION

---

After installation, fill the transmission case with the specified oil.

\*

- Place the motorcycle on its main stand on level ground.
- Check the sealing washer for wear or damage.

**Specified Gear Oil:** SAE90#

**Oil Capacity:** at disassembly: 0.12 liter  
at change: 0.1 liter

Install and tighten the oil check bolt.

**Torque:** 1.0~1.5kg-m

Start the engine and check for oil leaks.  
Check the oil level from the oil check bolt hole and add the specified oil to the proper level if the oil level is low.

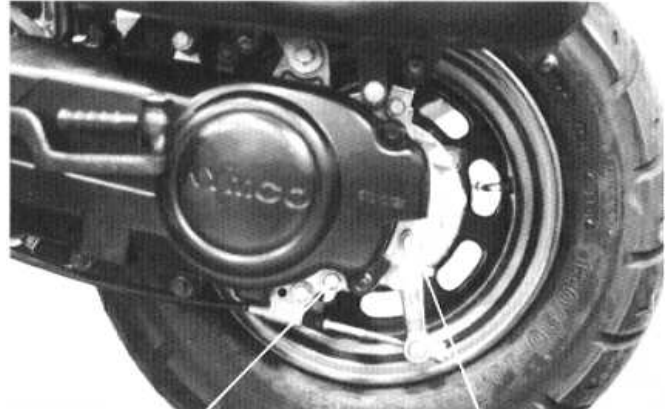

Drain Bolt

Oil Check Bolt Hole/Filler



# 9. A.C. GENERATOR

---



---

## A.C. GENERATOR

---

SERVICE INFORMATION .....	9-3
A.C. GENERATOR REMOVAL.....	9-4
A.C. GENERATOR INSTALLATION .....	9-6

# 9. A.C. GENERATOR

---

〈SH10AA〉

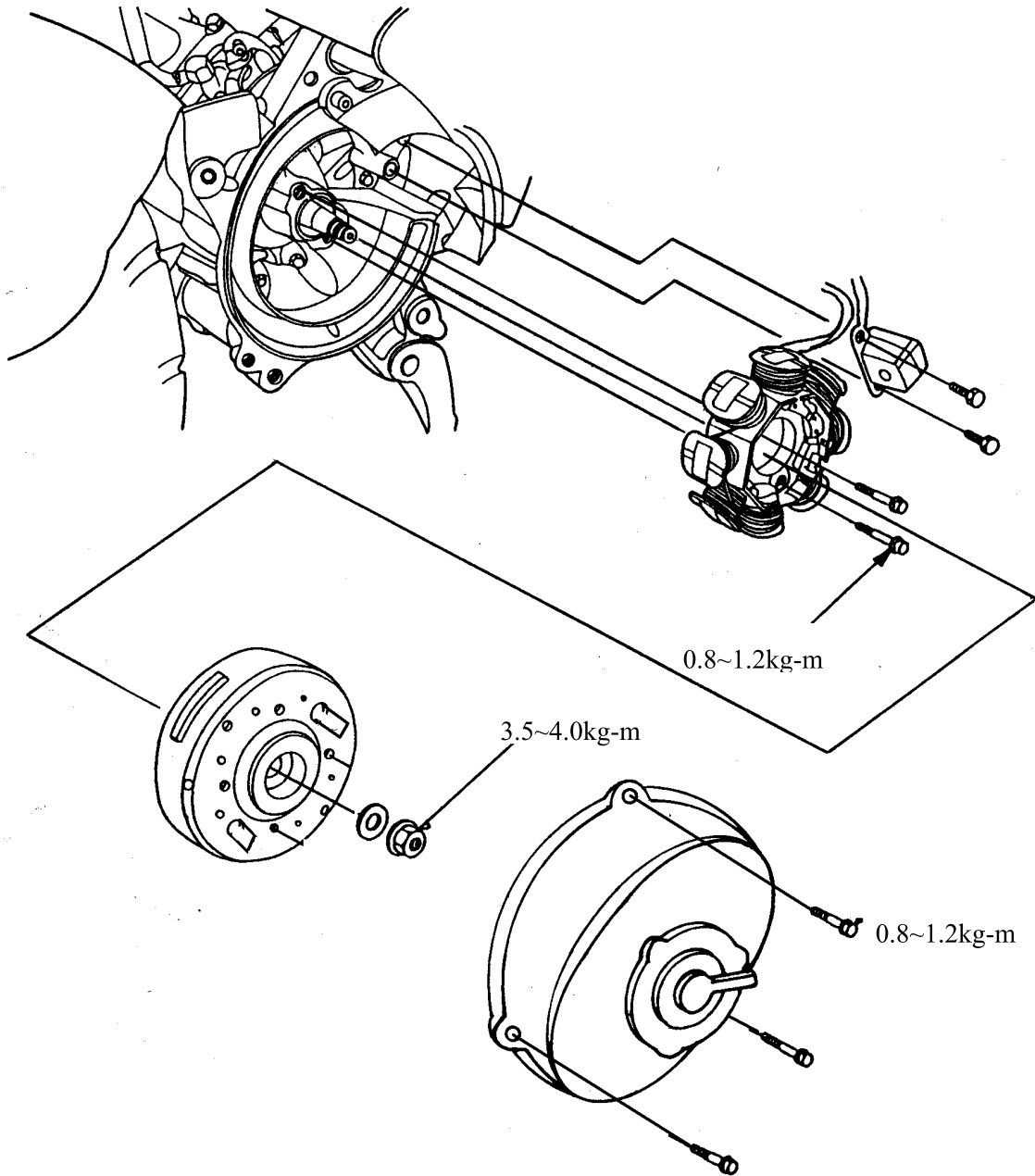

# 9. A.C. GENERATOR

〈SH10BA〉

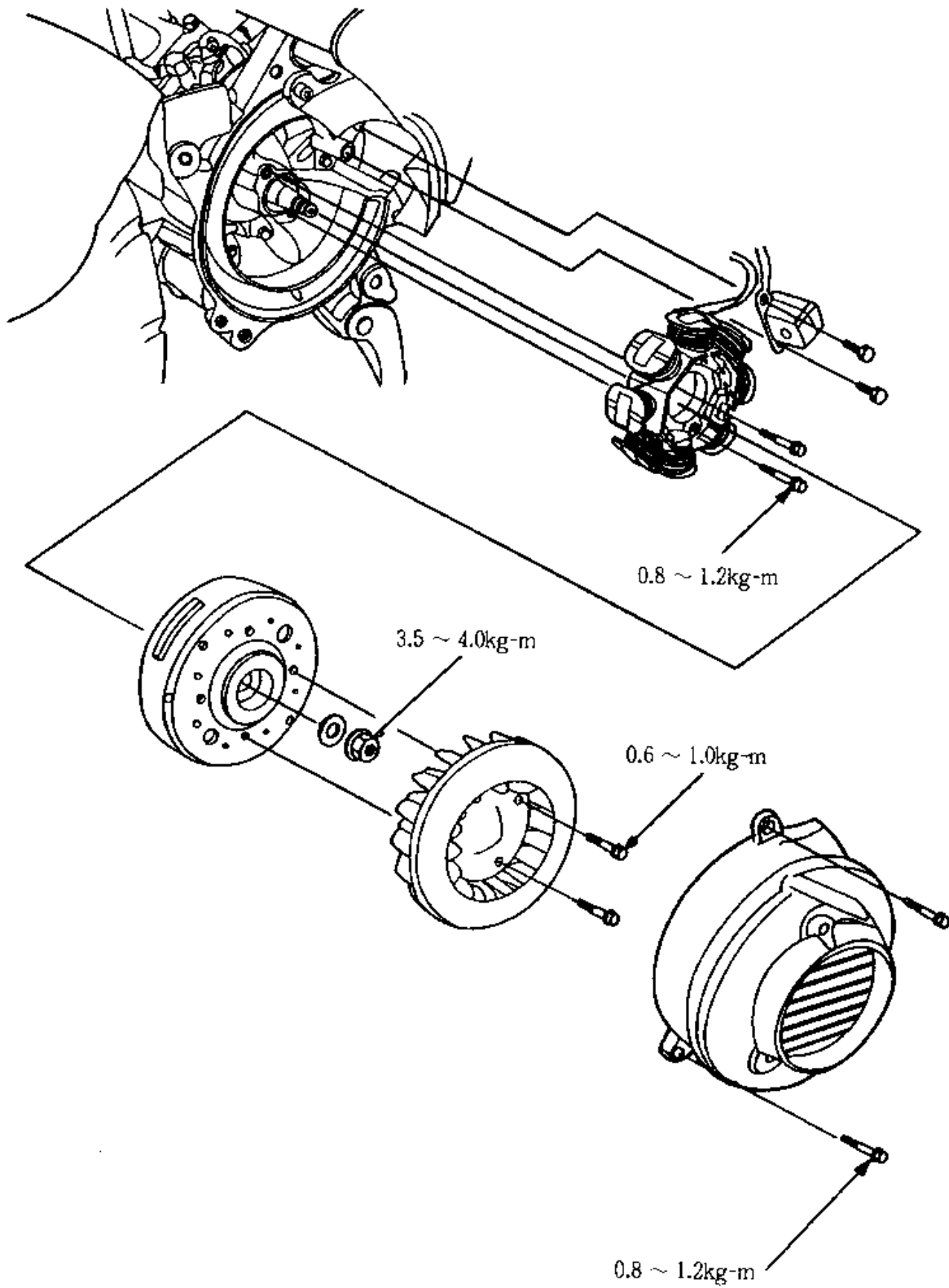

## **9. A.C. GENERATOR**

---

### **SERVICE INFORMATION**

#### **GENERAL INSTRUCTIONS**

- All A.C. generator maintenance and inspection can be made with the engine installed.
- Refer to Section 15 for A.C. generator inspection.

#### **TORQUE VALUE**

Flywheel nut : 3.5~4.0kg-m

#### **SPECIAL TOOLS**

Flywheel puller  
Universal holder

## 9. A.C. GENERATOR

---

〈SH10AA〉

### A.C. GENERATOR REMOVAL

Disconnect the water hoses from the right crankcase cover.  
Remove the three bolts attaching the right crankcase cover and the cover.

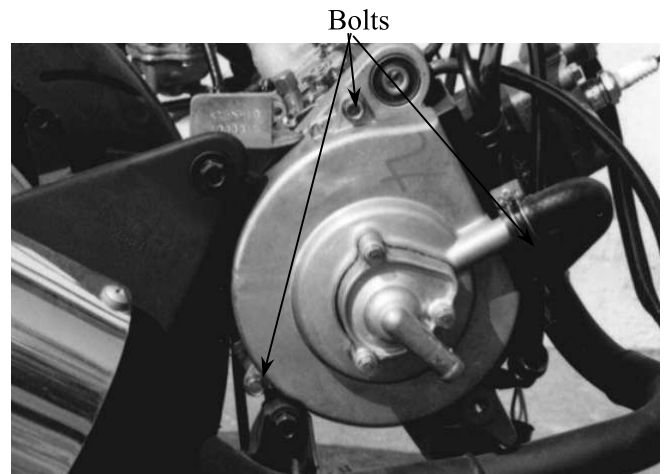

Hold the flywheel with an universal holder and then remove the 10mm flywheel nut.

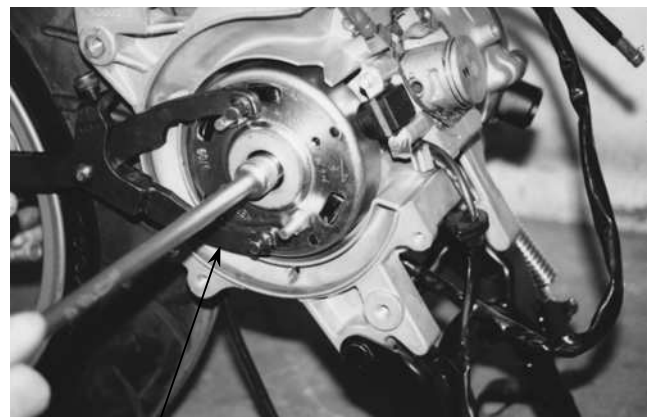

Universal Holder

## 9. A.C. GENERATOR

---

〈SH10BA〉

### A.C. GENERATOR REMOVAL

Remove the three bolts attaching the fan cover to remove the fan cover.

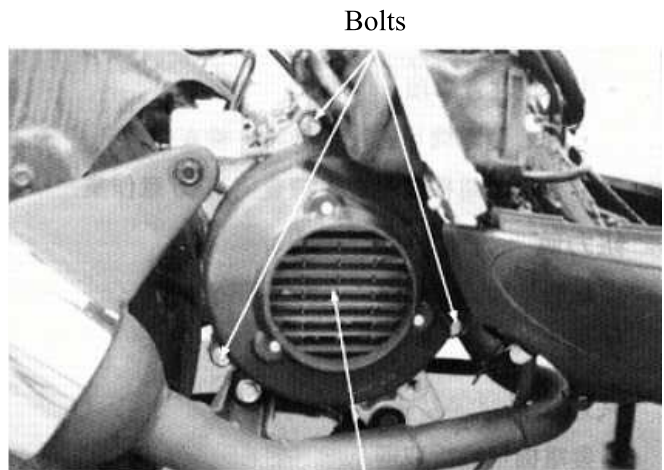

Fan Cover

Remove the cooling fan by removing the four bolts.

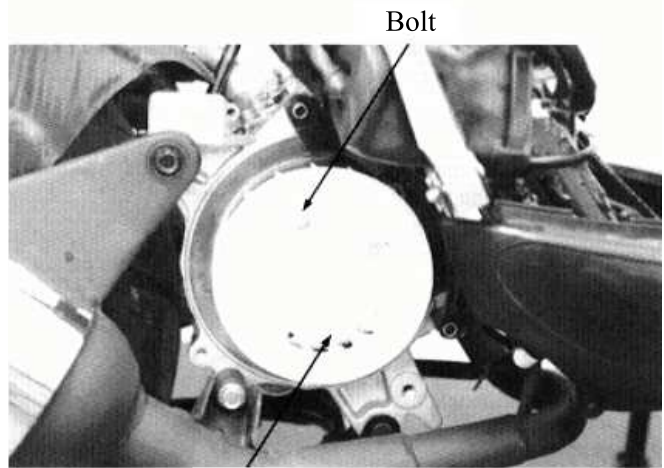

Cooling Fan

Hold the flywheel with an universal holder and then remove the 10mm flywheel nut.

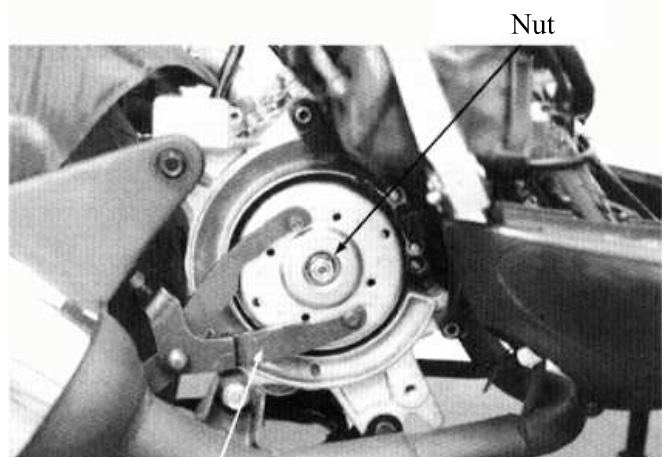

Universal Holder

## 9. A.C. GENERATOR

Remove the A.C. generator flywheel using the flywheel puller.

Lock Nut Wrench

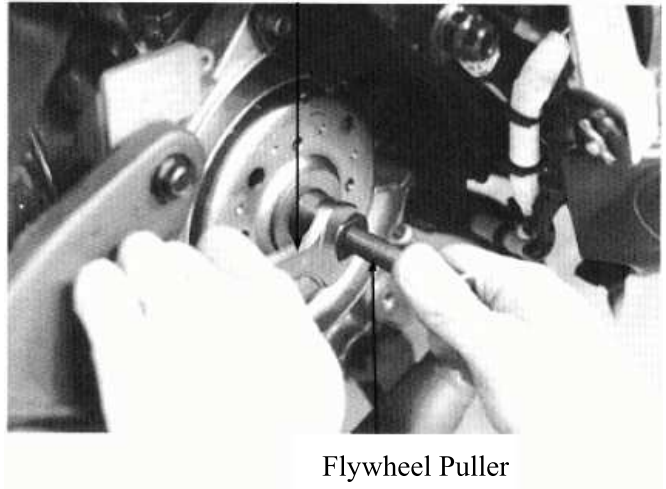

Remove the A.C. generator wire connector.

A.C. Generator Wire Connector



Remove the two pulser coil bolts and pulser coil from the right crankcase.  
Remove the pulser coil wire clamp from the right crankcase.  
Remove the two bolts attaching the A.C. generator stator.

\* Be careful not to damage the disconnected wire.

### A.C. GENERATOR INSTALLATION

Install the A.C. generator stator and pulser coil wire clamp onto the right crankcase, and then install the pulser coil.

Stator

Wire Clamp



Pulser Coil

## 9. A.C. GENERATOR

---

Connect the A.C. generator wire connector.

A.C. Generator Wire Connector



Clean the taper hole in the flywheel off any burrs and dirt.  
Install the woodruff key in the crankshaft keyway.

Woodruff Key

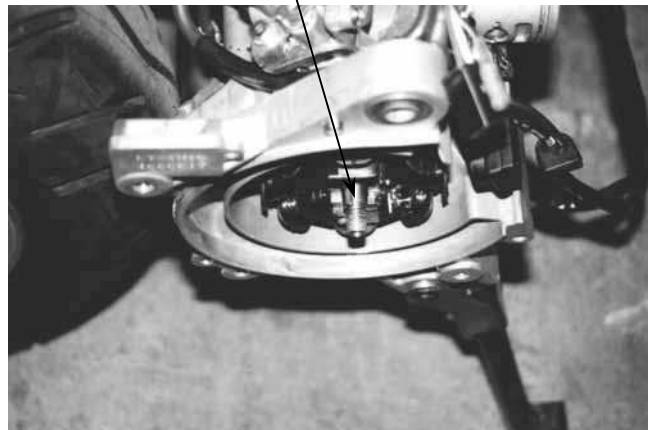

Install the flywheel onto the crankshaft with the flywheel groove aligned with the crankshaft woodruff key.  
Hold the flywheel with the universal holder and install the 10mm flywheel flange nut.

**Torque:** 3.5~4.0kg-m

Start the engine and check the ignition timing. (⇒3-8)

Install other removed parts in the reserve order of removal.

Universal Holder





# 10. CRANKCASE/CRANKSHAFT

---

---

## CRANKCASE/CRANKSHAFT

---

SERVICE INFORMATION .....	10-2
TROUBLESHOOTING .....	10-2
CRANKCASE SEPARATION .....	10-3
CRANKSHAFT REMOVAL.....	10-3
CRANKSHAFT INSPECTION .....	10-4
CRANKSHAFT INSTALLATION .....	10-5
CRANKCASE ASSEMBLY.....	10-7

**10**

# 10. CRANKCASE/CRANKSHAFT

---

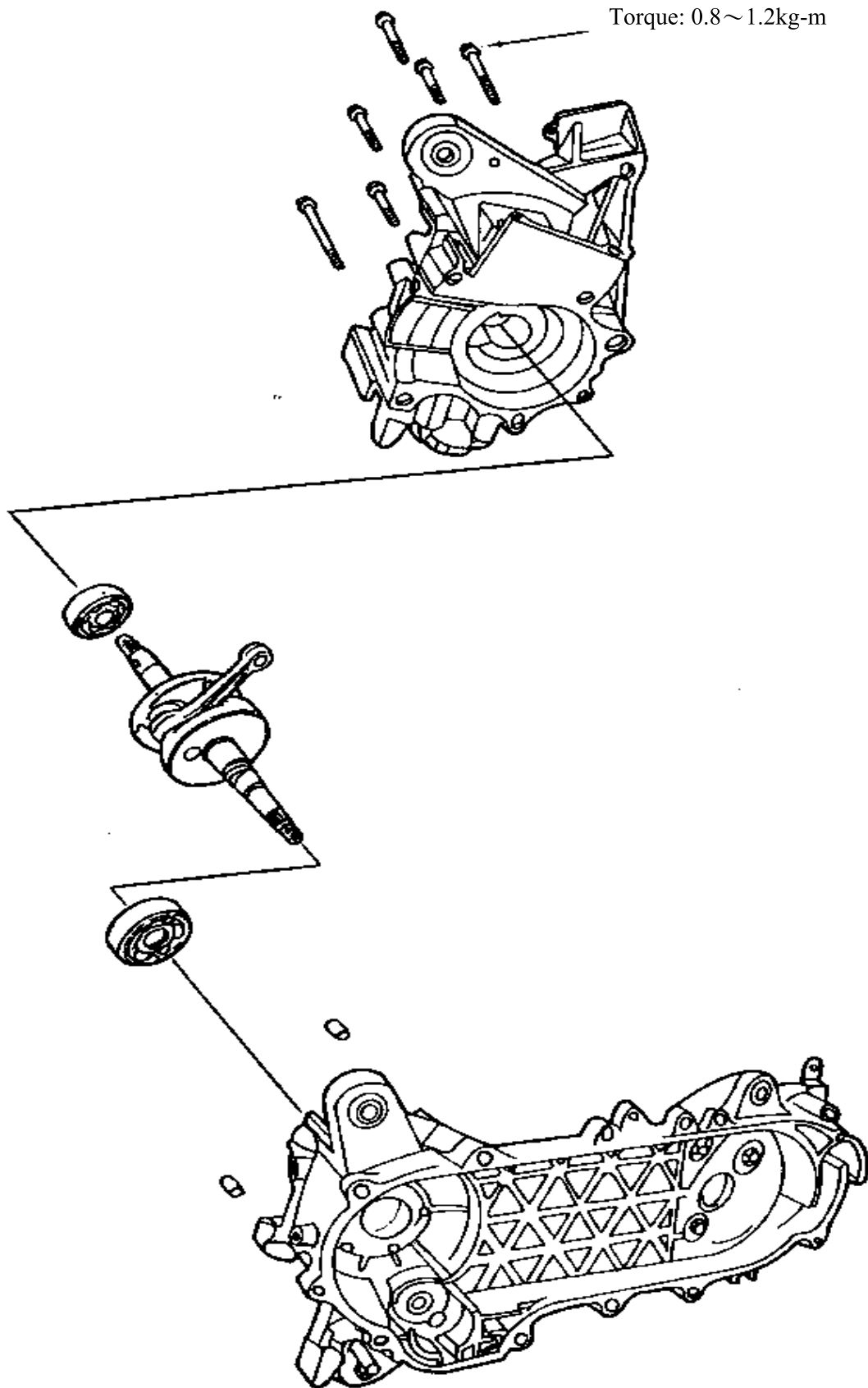

# 10. CRANKCASE/CRANKSHAFT

---

## SERVICE INFORMATION

### GENERAL INSTRUCTIONS

- This section covers crankcase separation to service the crankshaft.
- The following parts must be removed before separating the crankcase.
 

Engine (⇒Section 5)	Driven pulley (⇒Section 7)
Carburetor (⇒Section 12)	A.C. generator (⇒Section9)
Oil pump (⇒Section 4)	Cylinder head/cylinder (⇒Section 6)
Reed valve (⇒Section 12)	
- When the left crankcase must be replaced, remove the following part in addition to the above.  
Final reduction removal
- Special tools must be used for crankshaft and crankcase assembly. When separating the crankcase, the bearing will remain in the crankcase and it should be removed. When assembling, drive a new bearing into the crankcase and install a new oil seal.

### SPECIFICATIONS

Item	SH10BA		SH10AA	
	Standard (mm)	Service Limit (mm)	Standard (mm)	Service Limit (mm)
Connecting rod big end side clearance	—	0.60	—	0.60
Connecting rod big end radial clearance	—	0.04	—	0.04
Crankshaft runout A/B	—	0.15/0.10	—	0.15/0.10

### SPECIAL TOOLS

Crankcase puller	Bearing outer driver handle A
Universal bearing puller	Bearing outer driver, 42x47mm
Crankcase assembly collar	Bearing driver pilot, 20mm
Crankcase assembly tool	Bearing outer driver, 37x40mm
	Bearing driver pilot, 17mm

### TROUBLESHOOTING

#### Abnormal engine noise

- Excessive crank journal bearing play
- Excessive crankpin bearing play
- Excessive transmission bearing play

# 10. CRANKCASE/CRANKSHAFT

---

## CRANKCASE SEPARATION

Remove the crankcase attaching bolts.

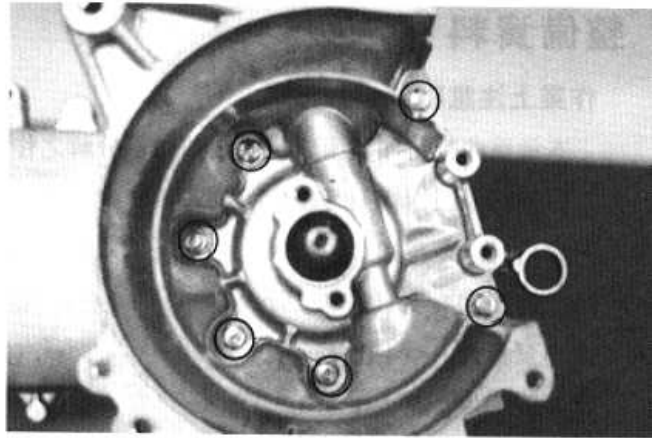

Attach the crankcase puller on the right crankcase and remove the right crankcase from the left crankcase.

Crankcase Puller

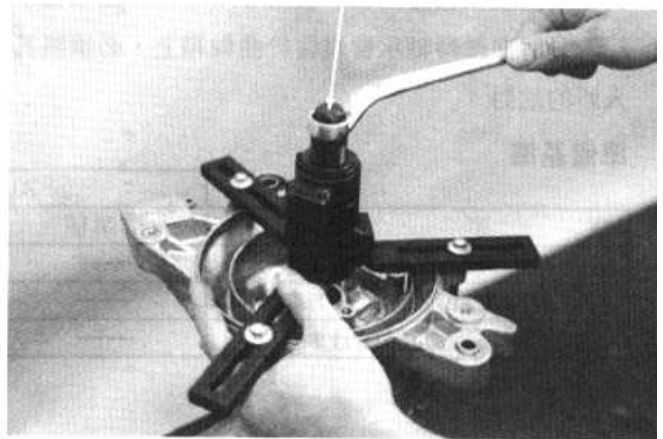

## CRANKSHAFT REMOVAL

Attach the crankcase puller on the left crankcase and remove the crankshaft from the left crankcase.

\* When removing the crankshaft, do it slowly and gently.

Crankcase Puller

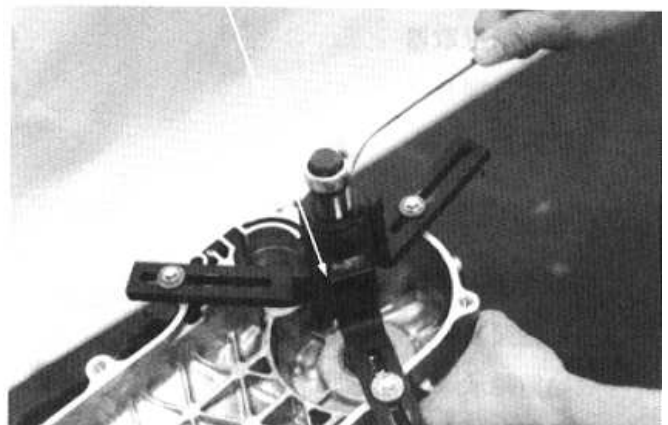

## 10. CRANKCASE/CRANKSHAFT

---

Remove the remaining bearing on the crankshaft side using the universal bearing puller.

\* When separating the crankcase, the oil seals must be removed. Replace the oil seals with new ones.

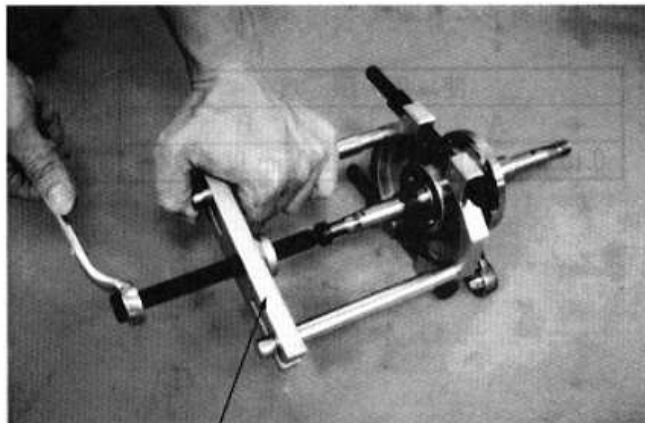

Universal Bearing Puller

### CRANKSHAFT INSPECTION

Measure the connecting rod big end side clearance.

**Service Limit:** 0.6mm replace if over

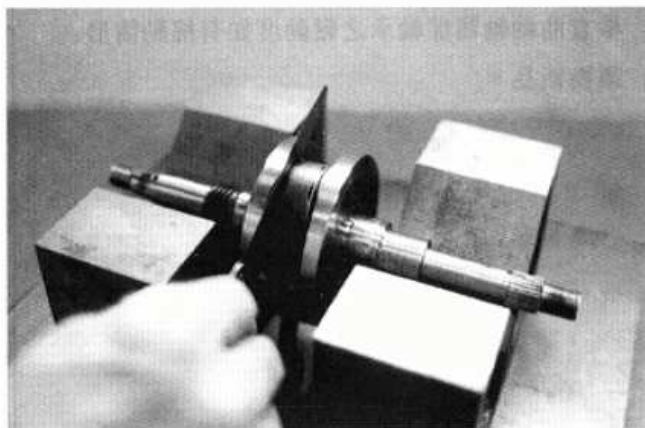

Measure the connecting rod big end radial clearance at two points in the X and Y directions.

**Service Limit:** 0.04mm replace if over

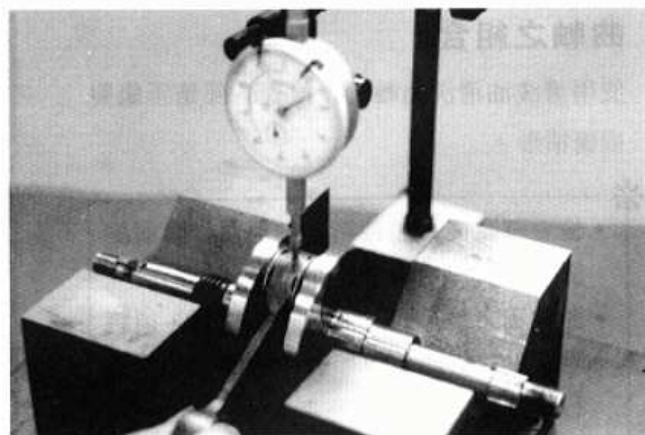

# 10. CRANKCASE/CRANKSHAFT

Measure the crankshaft runout.

Service Limit	
A	B
0.150mm replace if over	0.100mm replace if over

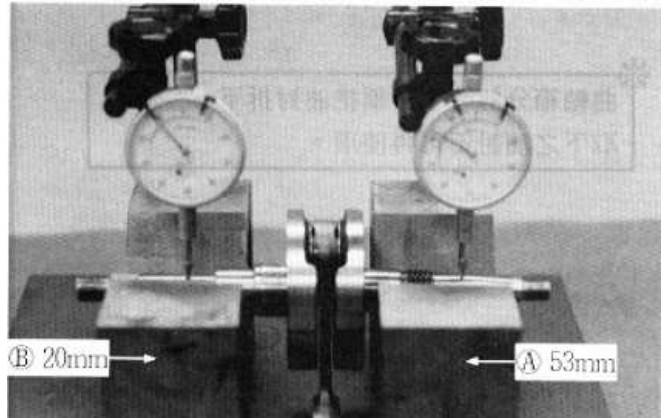

Check the crankshaft bearings for excessive play. The bearings must be replaced if they are noisy or have excessive play.

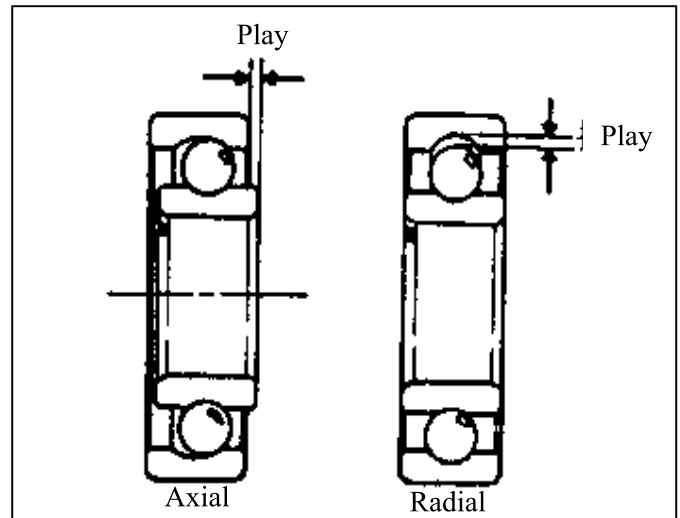

## CRANKSHAFT INSTALLATION

Wash the crankshaft in cleaning solvent and then check for cracks or other faults.

- \*
- After check, apply clean engine oil to all moving and sliding parts.
  - Remove all gasket material from the crankcase mating surfaces. Dress any roughness or irregularities with an oil stone.

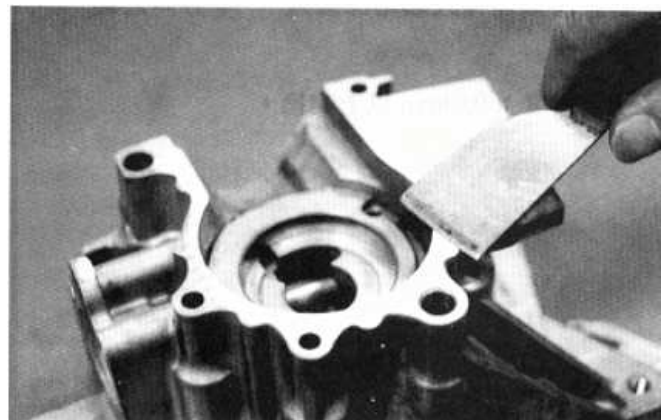

## 10. CRANKCASE/CRANKSHAFT

---

Drive a new crankshaft bearing into the right crankcase.

Bearing Outer Driver Handle A

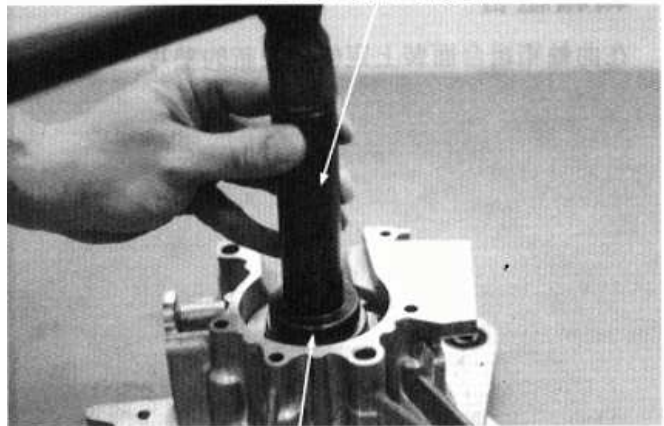

Bearing Outer Driver, 37x40mm  
Bearing Driver Pilot, 17mm

Drive a new crankshaft bearing into the left crankcase.

Bearing Outer Driver Handle A

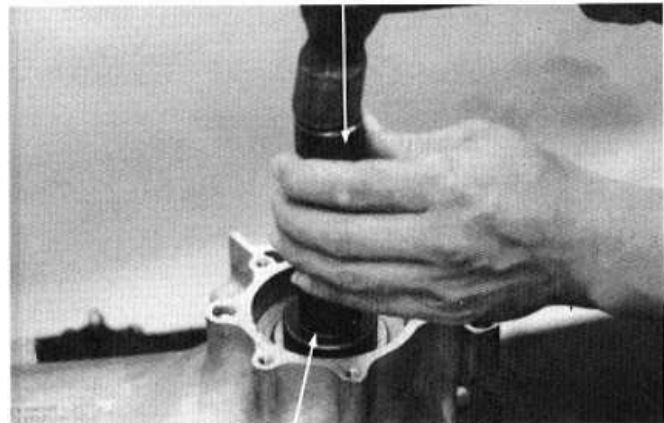

Bearing Outer Driver, 42x47mm  
Pilot, 20mm

Install the crankshaft into the left crankcase.

\*

- Apply KYMCO ULTRA motor oil or molybdenum disulfide to the crankshaft bearings and connecting rod big end.
- Apply grease to the lip of the oil seal and then install it.

Crankcase Assembly Collar

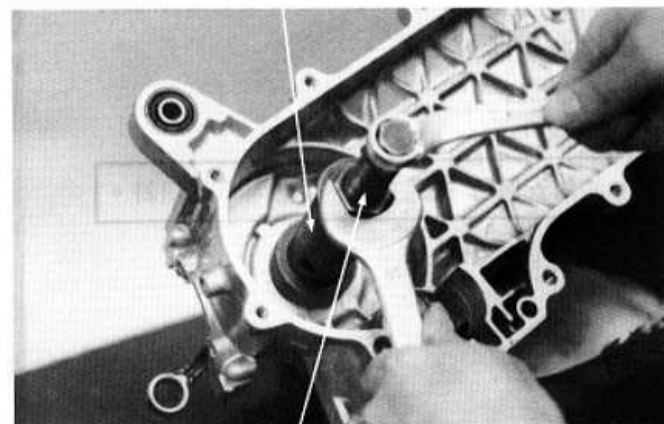

Crankcase Assembly Tool



# 10. CRANKCASE/CRANKSHAFT

---

## CRANKCASE ASSEMBLY

Install the dowel pins and a new gasket to the crankcase mating surface.

Dowel Pins

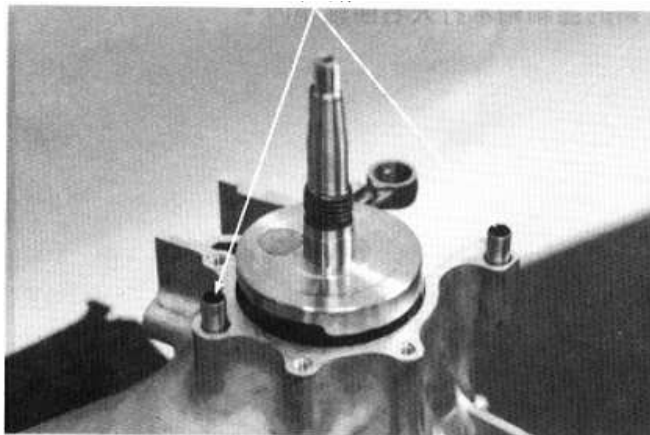

Assemble the crankcase halves.

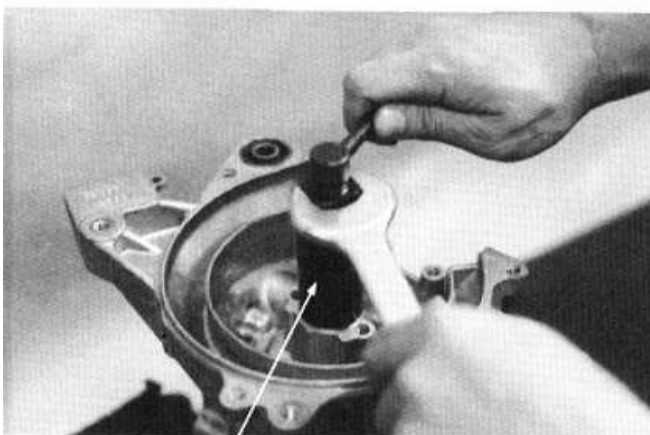

Crankcase Assembly Tool

Crankcase Assembly Collar

The distance between the right crankcase oil seal and crankcase surface is about  $12.5 \pm 0.5$  mm.

\* When installing the oil seal, be careful to press it with even force.



Crankcase Assembly Tool



## 10. CRANKCASE/CRANKSHAFT

---

The distance between the left crankcase oil seal and crankcase surface is about 1.0mm.

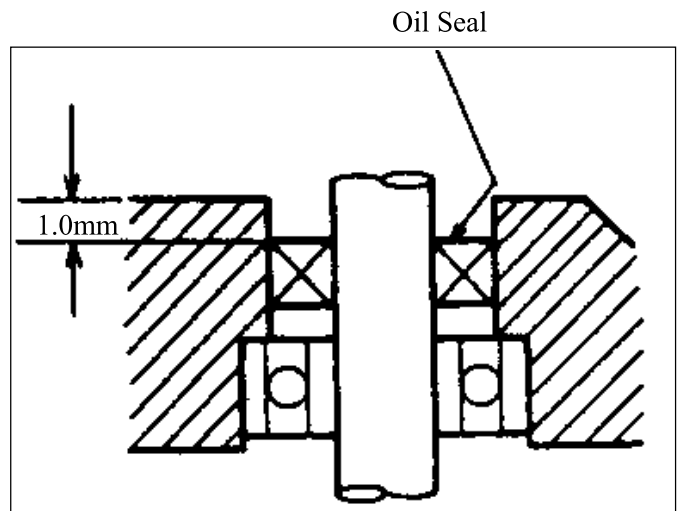

Install and tighten the crankcase attaching bolts.

\* After assembly, check the crankshaft for smooth operation.

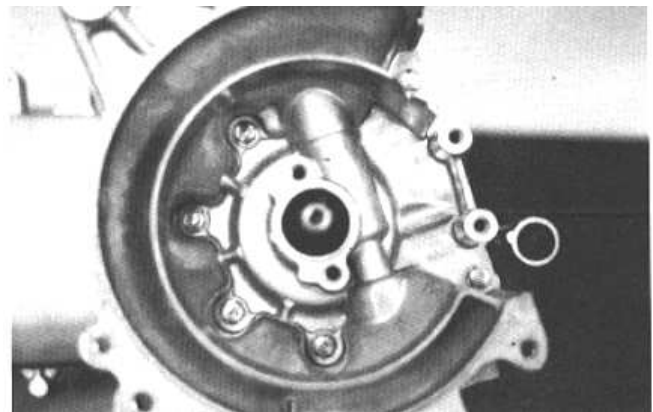

# 11. COOLING SYSTEM

---

---

## COOLING SYSTEM

---

SCHEMATIC DRAWING -----	11- 1
SERVICE INFORMATION-----	11- 2
TROUBLESHOOTING-----	11- 2
COOLING SYSTEM TESTING-----	11- 4
RADIATOR -----	11- 4
WATER PUMP -----	11- 8
THERMOSENSOR-----	11-12
THERMOSTAT-----	11-13

# 11. COOLING SYSTEM

---

## SCHEMATIC DRAWING

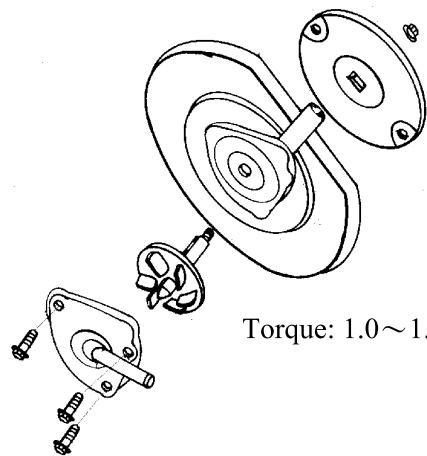
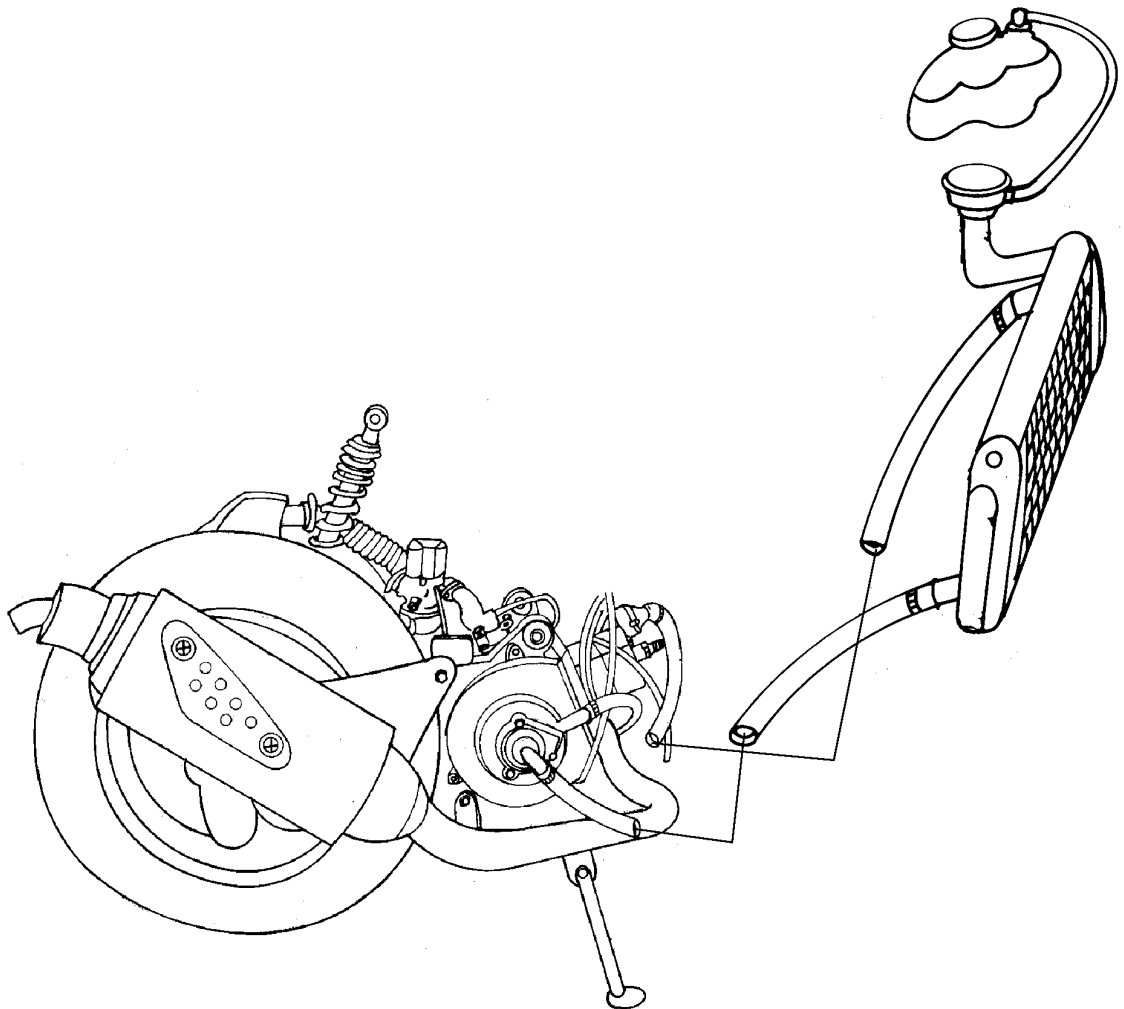

Torque: 1.0~1.4kg-m

# 11. COOLING SYSTEM

---

## SERVICE INFORMATION

### GENERAL INSTRUCTIONS

- The water pump must be serviced after removing the engine. Other cooling system service can be done with the engine installed in the frame.
- The engine must be cool before servicing the cooling system.  
When the coolant temperature is over 100°C, never remove the radiator cap to release the pressure because the boiling coolant may cause danger.
- Avoid spilling coolant on painted surfaces because the coolant will corrode the painted surfaces. Wash off any spilled coolant with fresh water as soon as possible.
- After servicing the system, check for leaks with a cooling system tester.

### SPECIAL TOOL

Mechanical seal driver

### TORQUE VALUES

Water pump impeller	1.0~1.4kg-m
Water pump cover bolt	0.8~1.2kg-m

### TROUBLESHOOTING

#### Engine temperature too high

- Faulty temperature gauge or thermosensor
- Faulty radiator cap
- Faulty thermostat
- Insufficient coolant
- Passages blocked in hoses or water jacket
- Clogged radiator fins
- Passages blocked in radiator
- Faulty water pump

#### Temperature gauge pointer does not register the correct coolant temperature

- Faulty temperature gauge or thermosensor
- Faulty thermostat

#### Coolant leaks

- Faulty pump mechanical (water) seal
- Deteriorated O-rings
- Damaged or deteriorated water hoses

# 11. COOLING SYSTEM

## SPECIFICATIONS

Radiator cap relief pressure		0.9±0.15kg/cm <sup>2</sup>	
Thermostat temperature	Begins to open	80±2°C	
	Full-open	90°C	
	Valve lift	3.5~4.5mm	
Coolant capacity		Total system 1165cc	Radiator: 825cc Reserve tank: 340cc

## COOLANT GRAVITY

Temp. °C Coolant concentration	0	5	10	15	20	25	30	35	40	45	50
5%	1.009	1.009	1.008	1.008	1.007	1.006	1.005	1.003	1.001	0.009	0.997
10%	1.018	1.107	1.017	1.016	1.015	1.014	0.013	1.011	1.009	1.007	1.005
15%	1.028	1.027	1.026	1.025	1.024	1.022	1.020	1.018	1.016	1.014	1.012
20%	1.036	1.035	1.034	1.033	1.031	1.029	1.027	1.025	1.023	1.021	1.019
25%	1.045	1.044	1.043	1.042	1.040	1.038	1.036	1.034	1.031	1.028	1.025
30%	1.053	1.051	1.051	1.049	1.047	1.045	1.043	1.041	1.038	1.035	1.032
35%	1.063	1.062	1.060	1.058	1.056	1.054	1.052	1.049	1.046	1.043	1.040
40%	1.072	1.070	1.068	1.066	1.064	1.062	1.059	1.056	1.053	1.050	1.047
45%	1.080	1.078	1.076	1.074	1.072	1.069	1.056	1.063	1.062	1.057	1.054
50%	1.086	1.084	1.082	1.080	1.077	1.074	1.071	1.068	1.065	1.062	1.059
55%	1.095	1.093	1.091	1.088	1.085	1.082	1.079	1.076	1.073	1.070	1.067
60%	1.100	1.098	1.095	1.092	1.089	1.086	1.083	1.080	1.077	1.074	1.071

## COOLANT MIXTURE (WITH ANTI-RUST AND ANTI-FREEZING EFFECTS)

Freezing Point	Mixing Rate	KYMCO SIGMA Coolant Concentrate	Distilled Water
-9°C	20%		
-15°C	30%	360cc	825cc
-25°C	40%		
-37°C	50%		
-44.5°C	55%		

### Cautions for Using Coolant:

- Use coolant of specified mixing rate. (The mixing rate of 360cc KYMCO SIGMA coolant concentrate + 825cc distilled water is 30%.)
- Do not mix coolant concentrate of different brands.
- Do not drink the coolant which is poisonous.
- The freezing point of coolant mixture shall be 5°C lower than the freezing point of the riding area.

# 11. COOLING SYSTEM

## COOLING SYSTEM TESTING

### RADIATOR CAP INSPECTION

Install the radiator cap onto the radiator tester and apply specified pressure to it. It must hold specified pressure for at least six seconds.

- \* Apply water to the cap sealing surface before testing.

#### Radiator Cap Relief Pressure:

$0.9 \pm 0.15 \text{ kg/cm}^2$

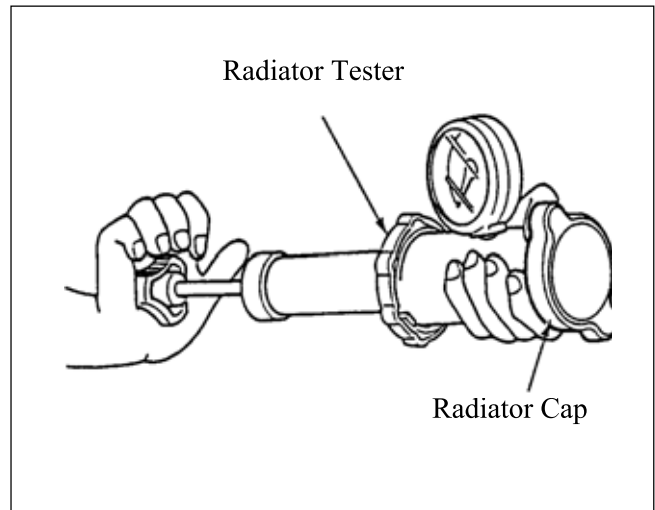

Install the radiator tester onto the radiator and apply specified pressure to it. It must hold specified pressure for at least six seconds.

Check the water hoses and connectors for leaks.

- \* The test pressure should not exceed  $1.05 \text{ kg/cm}^2$ . Excessive pressure can damage the radiator and its hose

Radiator Tester

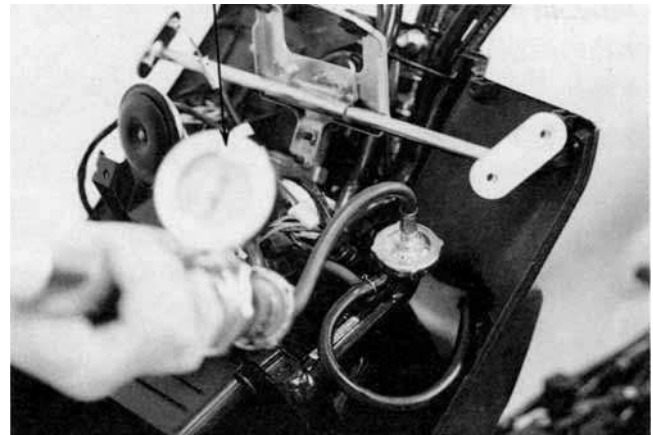

## RADIATOR

### RADIATOR INSPECTION

Remove the front upper cover. (⇒2-5)

Remove the front lower cover. (⇒2-5)

Remove the two screws and the air duct.

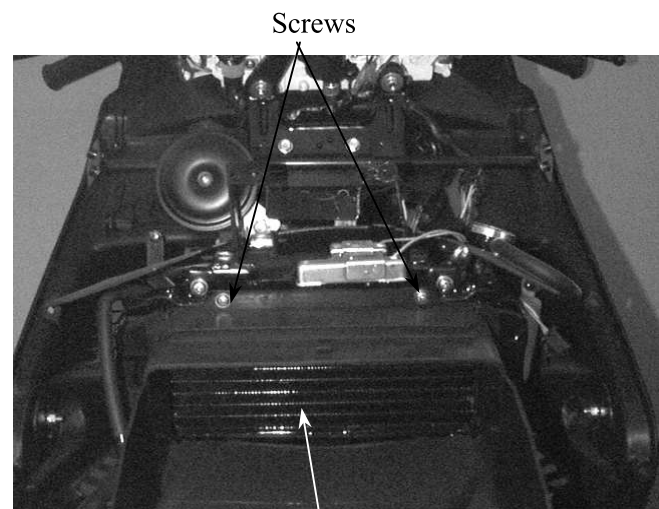

Air Duct

# 11. COOLING SYSTEM

---

Inspect the radiator soldered joints and seams for leaks.  
Blow dirt out from between core fins with compressed air. If insects, etc., are clogging the radiator, wash them off. Carefully straighten any bent fins.



## RADIATOR REMOVAL

Drain the coolant. (⇒3-9)  
Remove the overflow tube clamp and disconnect the overflow tube.



Overflow Tube

Loosen the hose band and disconnect the upper hose from the radiator.

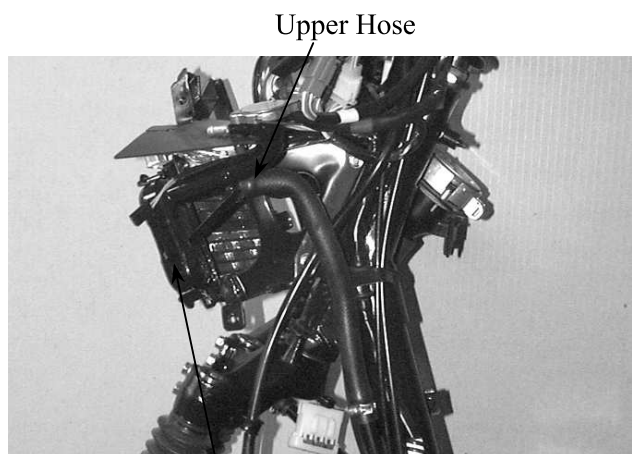

Upper Hose

Radiator

# 11. COOLING SYSTEM

---

Loosen the hose band and disconnect the lower hose from the radiator.



Lower Hose

Remove the four screws and the radiator.

Radiator

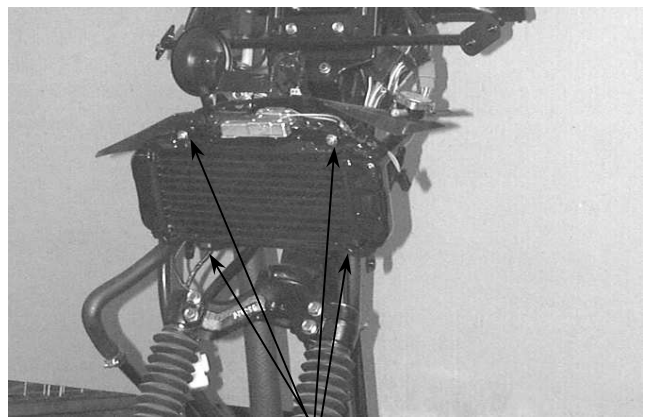

Screws

## **RADIATOR BRACKET REMOVAL/ INSTALLATION**

Remove the two bolts to remove the radiator bracket.  
The installation sequence is the reverse of removal.

Bolts

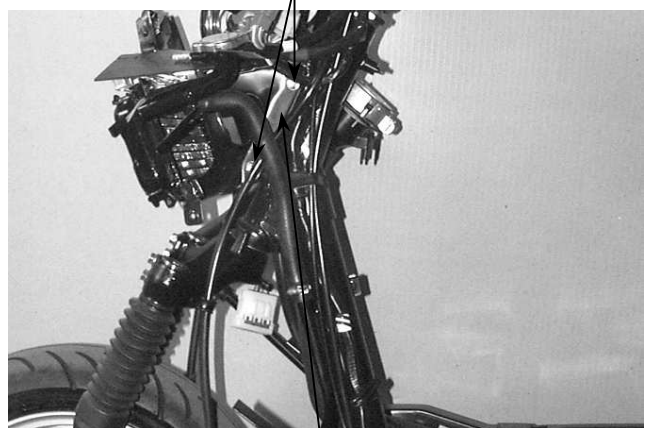

Radiator Bracket



# 11. COOLING SYSTEM

---

## RADIATOR INSTALLATION

Install the radiator on the radiator bracket with the four screws.

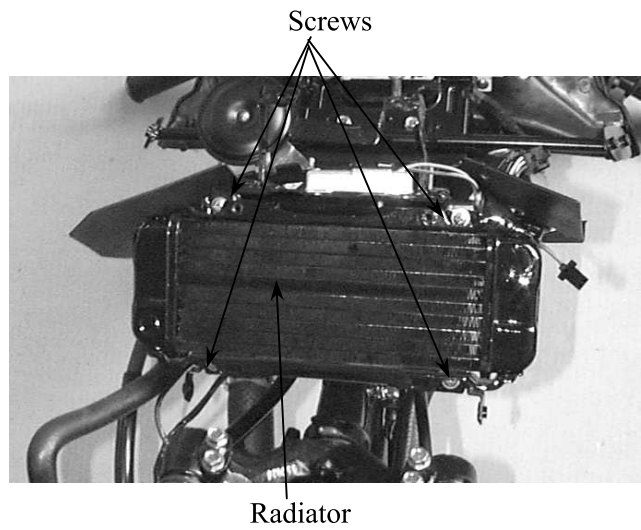

Connect the upper and lower hoses and secure them with hose bands.

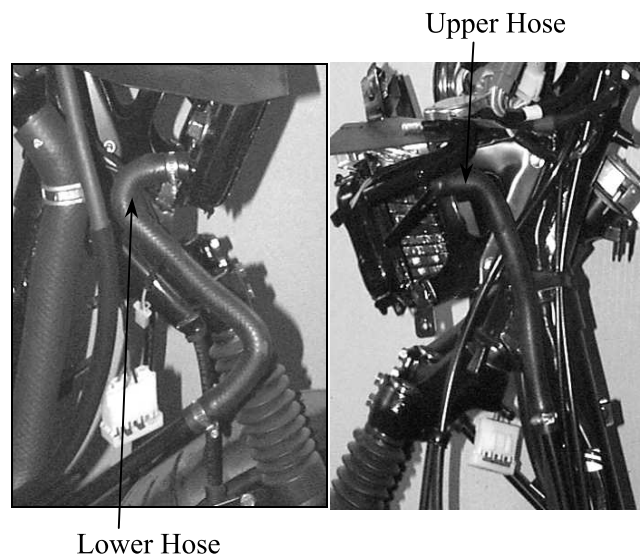

Install the heat screen.  
Connect the overflow tube and secure with the tube clamp.

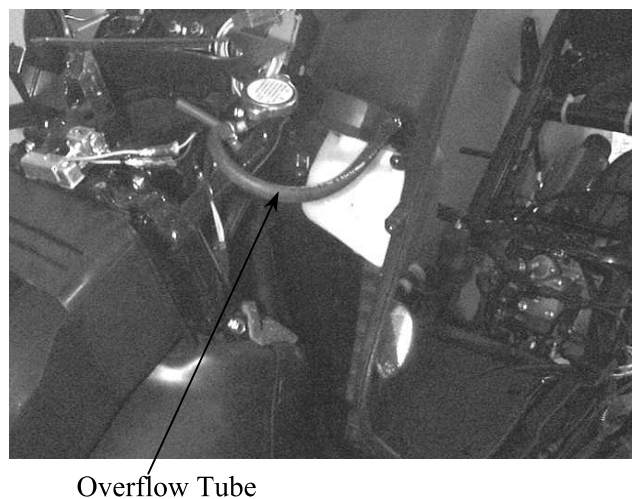

# 11. COOLING SYSTEM

---

Set the two tabs under the air duct into the grooves on the radiator lower part and then secure the radiator with the two screws.

Fill the radiator with coolant. (⇒3-12)  
After installation, check for coolant leaks.

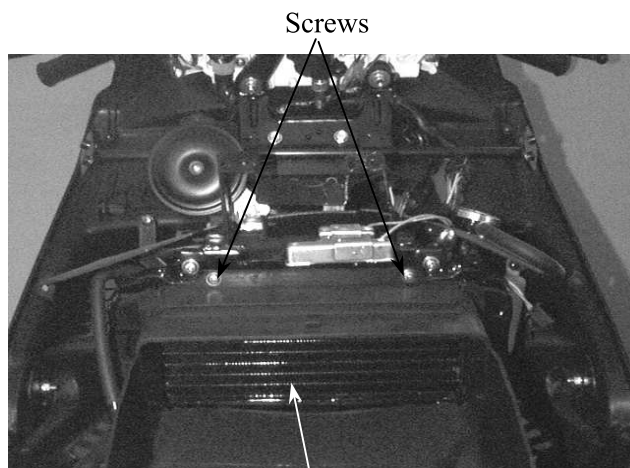

Air Duct

## WATER PUMP

### MECHANICAL SEAL (WATER SEAL) INSPECTION

Inspect the telltale hole for signs of mechanical seal coolant leakage.  
If the mechanical seal is leaking, remove the right crankcase cover and replace the mechanical seal.

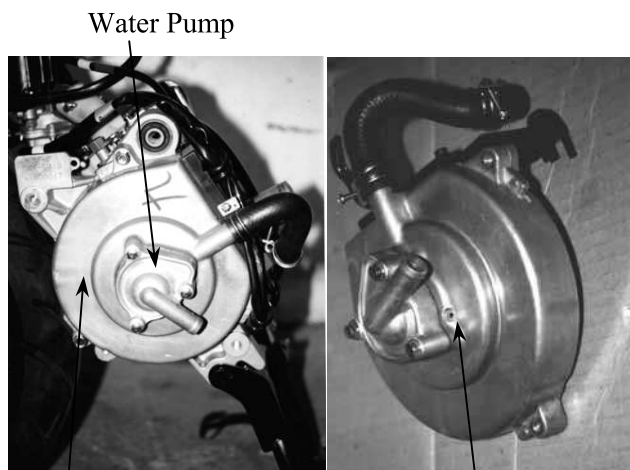

Right Crankcase Cover

Telltale Hole

### WATER PUMP/IMPELLER REMOVAL

Remove the engine from the frame. (⇒5-2)

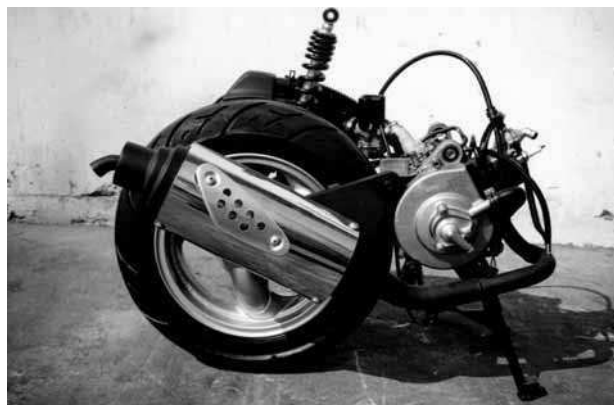

# 11. COOLING SYSTEM

---

Remove the three bolts and the water pump cover, gasket and 1 dowel pins.

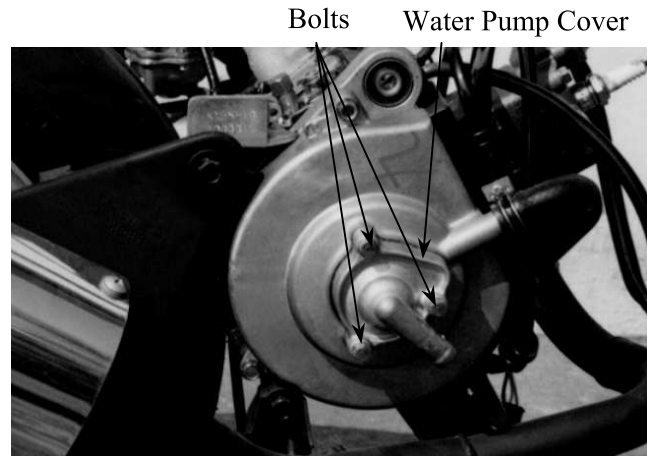

Remove the three bolts attaching the right crankcase cover and the cover. Remove the water pump impeller.

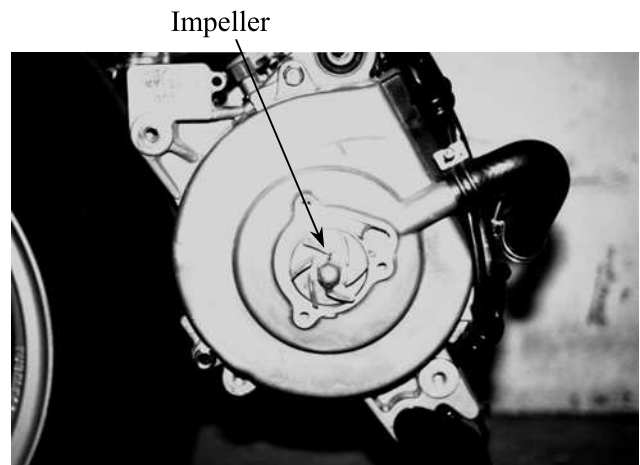

Inspect the mechanical (water) seal and inner bearing for wear or damage.

\* The mechanical seal and inner bearing must be replaced as a set.

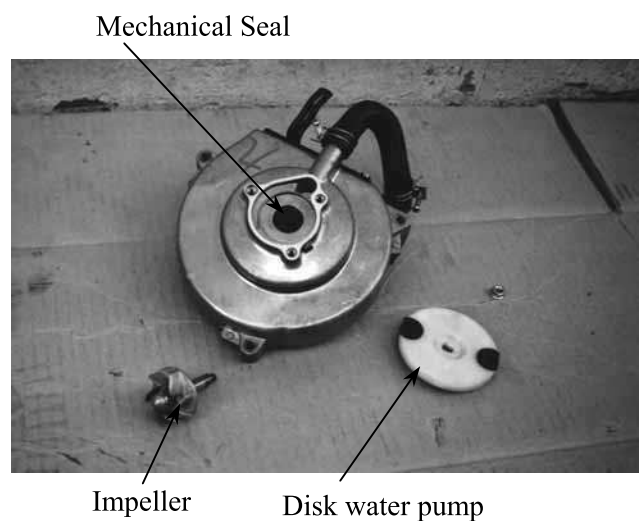

# 11. COOLING SYSTEM

---

## MECHANICAL SEAL REPLACEMENT

Drive the mechanical seal out of the water pump assembly from the outer.

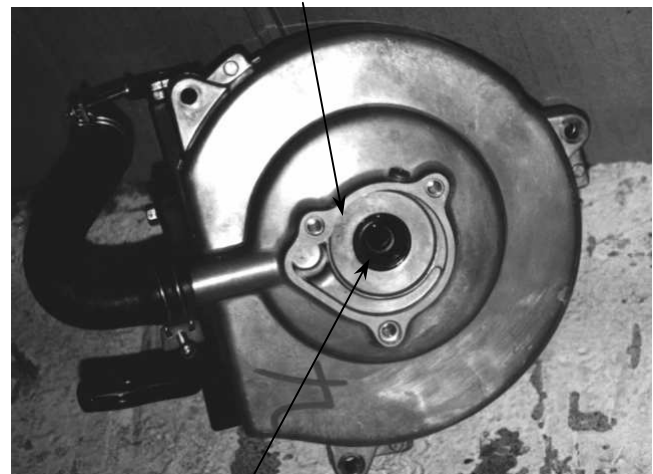

Mechanical Seal (Water Seal)

Drive in a new mechanical seal using a mechanical seal driver.

\* Apply sealant to the right crankcase cover fitting surface of a new mechanical seal and then drive in the mechanical seal.



Mechanical Seal Driver

## WATER PUMP SHAFT INSTALLATION

Drive a new water pump shaft inside bearing into the water pump assembly from the inside.

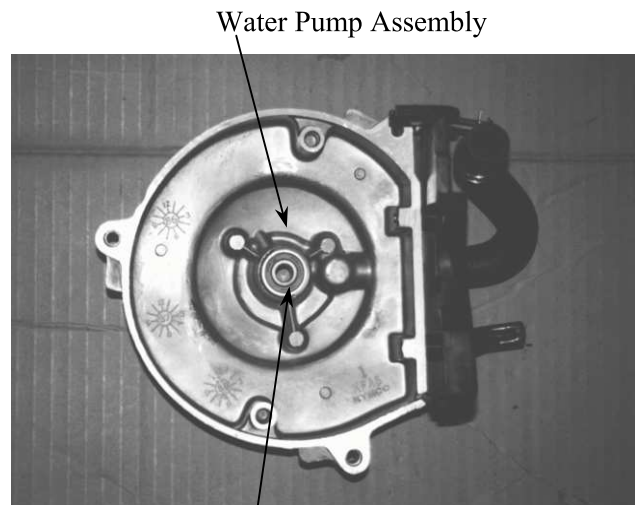

Inside Bearing

# 11. COOLING SYSTEM

---

## WATER PUMP/IMPELLER INSTALLATION

When the mechanical seal is replaced, a new shaft inside must be installed to the impeller.

Install the impeller onto the water pump assembly.

**Torque:** 1.0~1.4kg-m

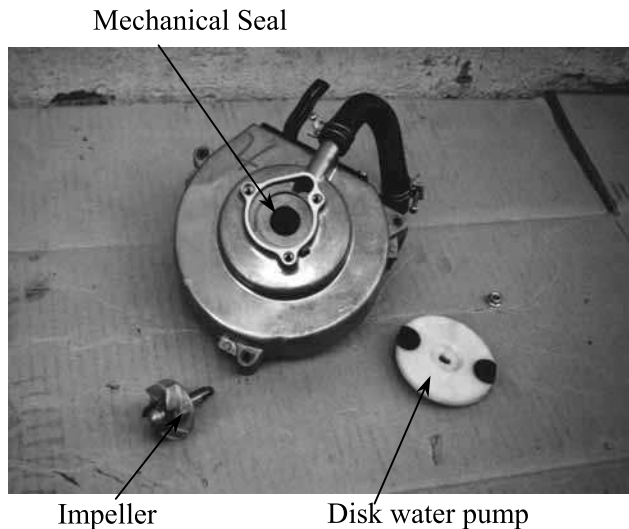

Install the one dowel pins and a new gasket.  
Install the water pump cover and tighten the 3 bolts.

**Torque:** 0.8~1.2kg-m

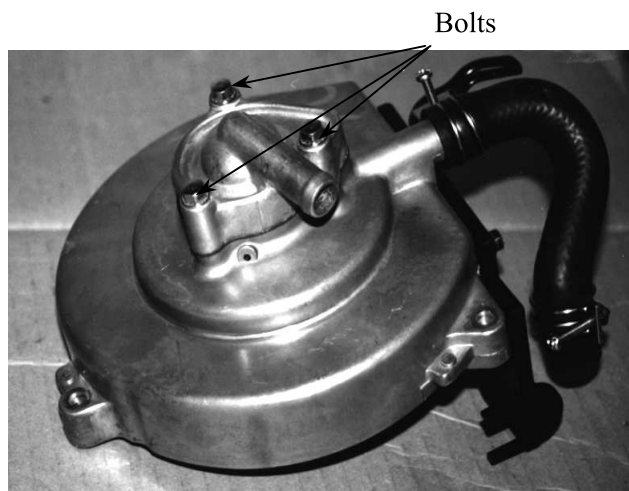

Install the right crankcase cover over the crankcase

Tighten the three right crankcase cover bolts.

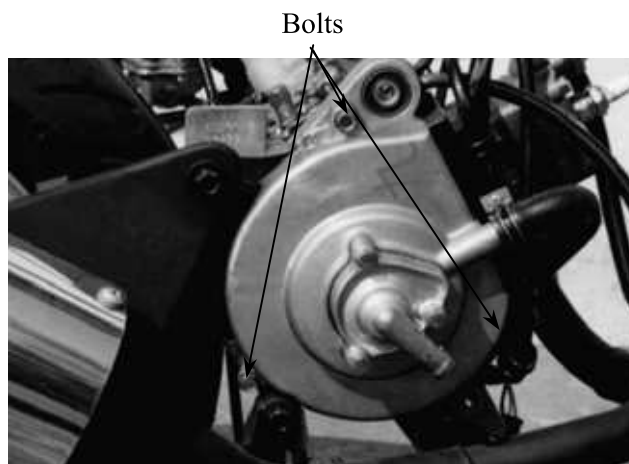

# 11. COOLING SYSTEM

## THERMOSENSOR

### THERMOSENSOR REMOVAL

Remove the seat, met-in box and center cover.  
Drain the coolant.  
Disconnect the thermosensor wire.  
Remove the thermosensor.

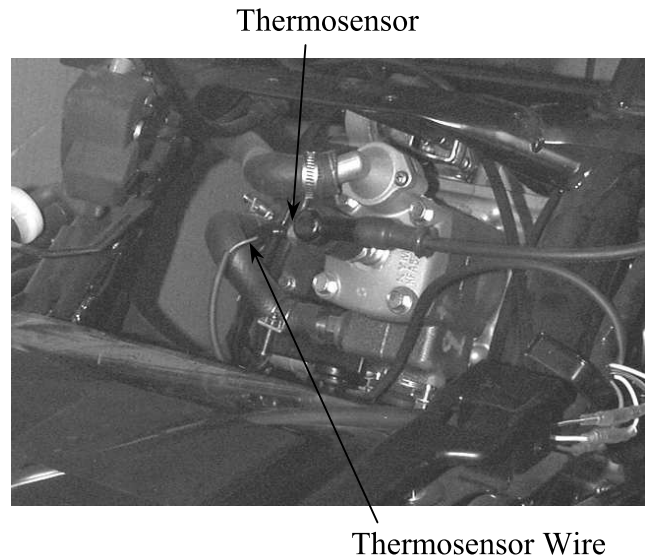

### THERMOSENSOR INSPECTION

Suspend the thermosensor in a pan of water over a burner and measure the resistance through the sensor as the water heats up.

Temperature(°C)	50	80	100	120
Resistance( $\Omega$ )	154	52	27	16

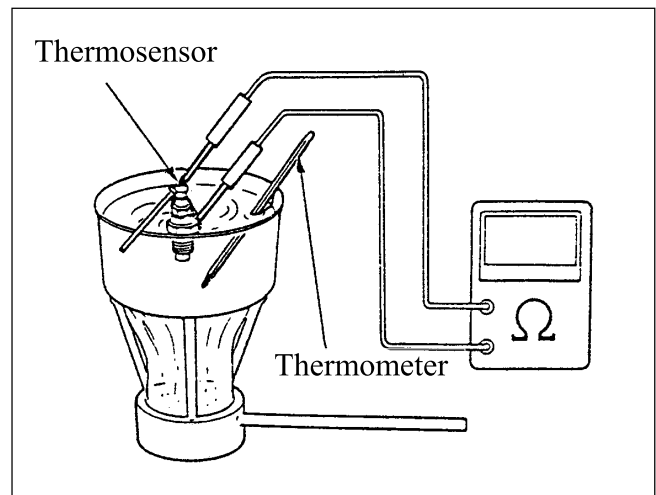

### THERMOSENSOR INSTALLATION

Apply 3-BOND No. 1212 sealant or equivalent to the cylinder head threads and install it into the thermostat housing.  
Connect the thermosensor wire.  
Fill the radiator with coolant. ( $\Rightarrow$ 3-12)  
Install the center cover, met-in box and seat. ( $\Rightarrow$ 2-3)

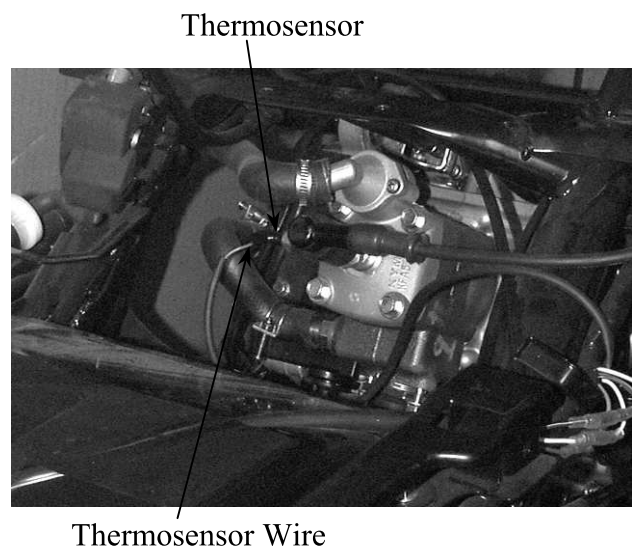

# 11. COOLING SYSTEM

## THERMOSTAT

### THERMOSTAT REMOVAL

Remove the seat, met-in box and center cover.  
Drain the coolant.  
Disconnect the water hose from the thermostat housing.  
Remove the mounting bolt and the thermostat housing from the cylinder head.

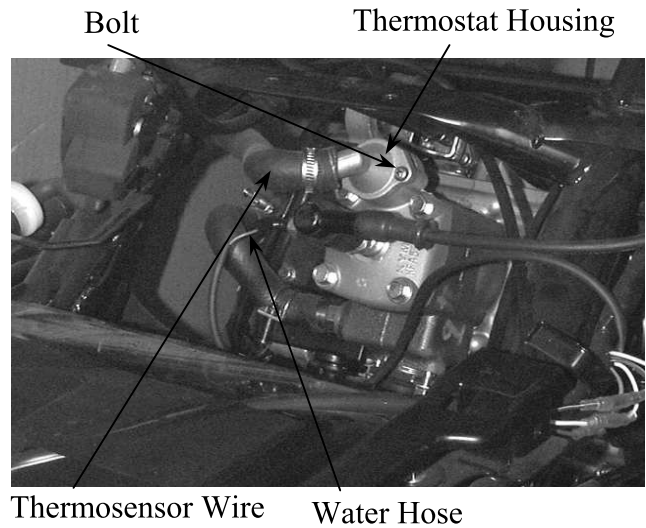

Remove the thermostat from the thermostat housing.

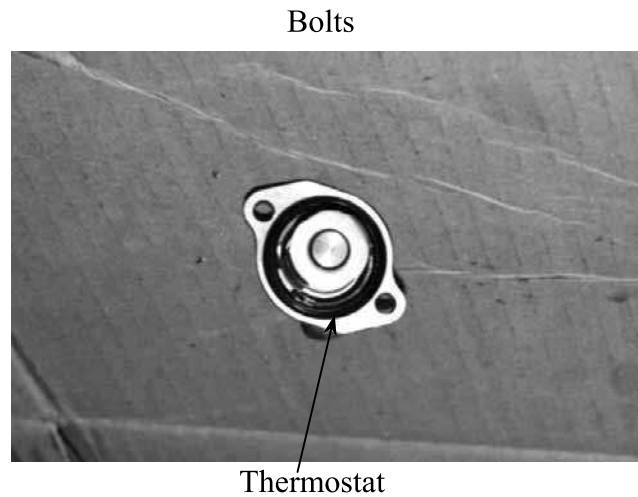

### THERMOSTAT INSPECTION

Suspend the thermostat in a pan of water over a burner and gradually raise the water temperature to check its operation.

#### Technical Data

Begins to open	$80\pm 2^{\circ}\text{C}$
Full-open	$90^{\circ}\text{C}$
Valve lift	3.5~4.5mm

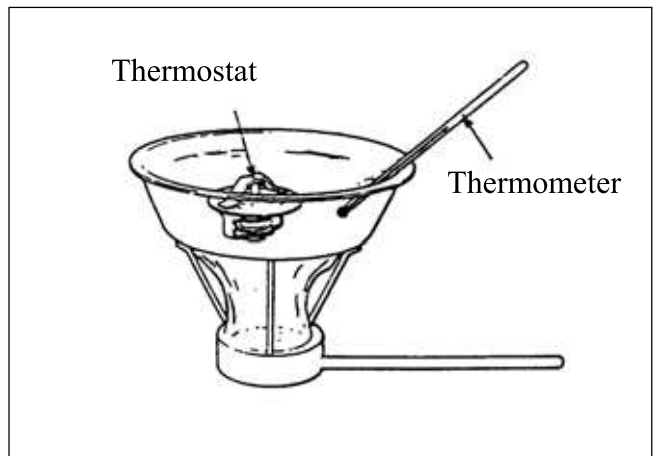

# 11. COOLING SYSTEM

---

- \* Do not let the thermostat touch the pan as it will give a false reading.
- Replace the thermostat if the valve stays open at room temperature.
- Test the thermostat after it is opened for about 5 minutes and holds the temperature at 70°C.



Thermostat Housing

## THERMOSTAT INSTALLATION

The installation sequence is the reverse of removal.

Fill the cooling system with the specified coolant. (⇒3-12)

Thermostat Housing





## 12. CARBURETOR/FUEL PUMP

---

---

### CARBURETOR/FUEL PUMP

---

SERVICE INFORMATION .....	12- 2
TROUBLESHOOTING .....	12- 2
THROTTLE VALVE DISASSEMBLY .....	12- 3
THROTTLE VALVE INSTALLATION.....	12- 4
CARBURETOR REMOVAL .....	12- 5
AUTO BYSTARTER.....	12- 6
FLOAT CHAMBER .....	12- 8
FLOAT LEVEL INSPECTION .....	12-10
CARBURETOR INSTALLATION .....	12-11
AIR SCREW ADJUSTMENT .....	12-11
REED VALVE .....	12-12
FUEL PUMP REMOVAL .....	12-13
FUEL PUMP INSTALLATION.....	12-15

## 12. CARBURETOR/FUEL PUMP

---

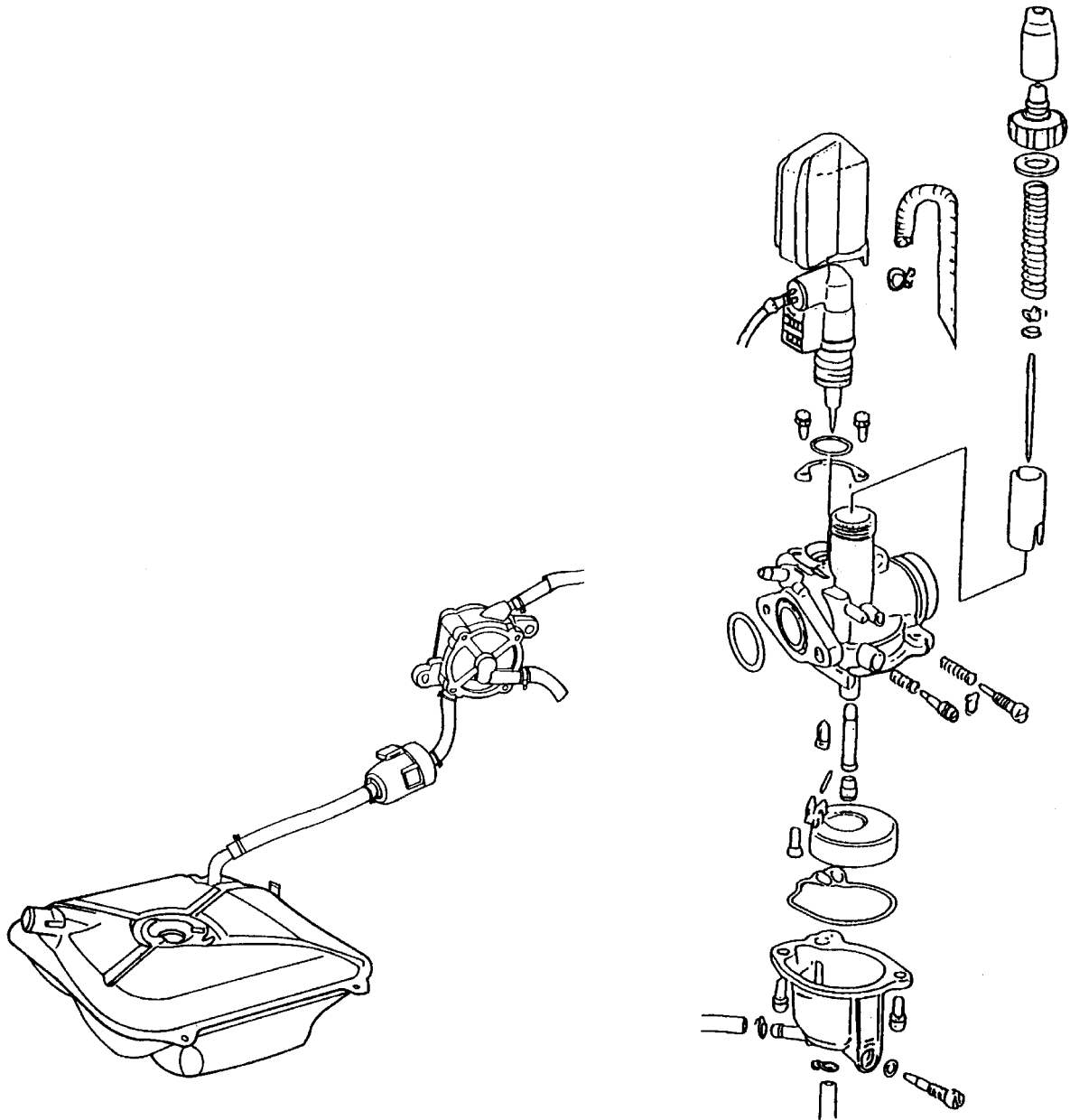

# 12. CARBURETOR/FUEL PUMP

---

## SERVICE INFORMATION

### GENERAL INSTRUCTIONS

- When working with gasoline, keep away from sparks and flames..
- Note the locations of O-rings when disassembling and replace them with new ones during assembly.
- All cables, fuel lines and wires must be routed and secured at correct locations.
- Bleed air from the oil lines whenever they are disconnected.

### SPECIFICATIONS

	SH10BA	SH10AA
Venturi dia.	14mm	14mm
Identification number	PB033 <span style="border: 1px solid black; padding: 0 2px;">A</span>	PB058 <span style="border: 1px solid black; padding: 0 2px;">A</span>
Float level	8.6mm	8.6mm
Main jet	#85	#85
Slow jet	#35	#35
Air screw opening	$1\frac{1}{2} \pm \frac{1}{2}$	$1\frac{1}{4} \pm \frac{1}{2}$
Idle speed	2000±100 rpm	2000±100rpm
Throttle grip free play	2~6mm	2~6mm

### SPECIAL TOOL

Float level gauge

### TROUBLESHOOTING

#### Engine does not start

- No fuel in tank
- Too much fuel getting to cylinder
- Clogged fuel filter
- Clogged air cleaner

#### Lean mixture

- Clogged fuel jets
- Clogged fuel cap vent
- Clogged fuel filter
- Bent, kinked or restricted fuel line

- Faulty float valve
- Float level too low
- Clogged air cleaner

#### Engine idles roughly, stalls or runs poorly

- Incorrect idle speed
- Ignition malfunction
- Compression too low
- Incorrectly adjusted air screw
- Incorrect float level
- Clogged air cleaner
- Intake air leaks
- Fuel contaminated
- Faulty reed valve
- Clogged fuel jets

#### Rich mixture

- Faulty float valve
- Float level too high
- Clogged air jets

## 12. CARBURETOR/FUEL PUMP

---

### THROTTLE VALVE DIS-ASSEMBLY

Remove the rear carrier. (⇒2-3)  
Remove the met-in box. (⇒2-4)  
Loosen the carburetor cap and remove the throttle valve.



Carburetor Cap

Disconnect the throttle cable from the throttle valve.

Throttle Valve

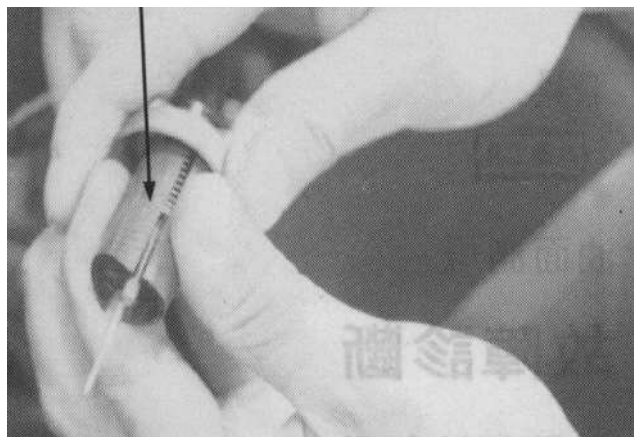

Remove the throttle valve spring, carburetor cap and rubber seal.

Rubber Seal

Carburetor Cap

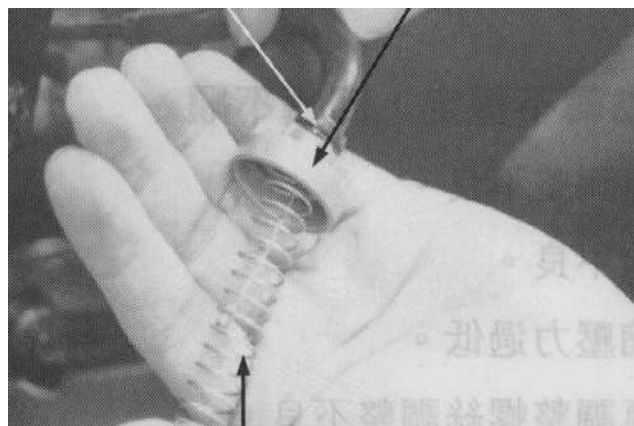

Spring

## 12. CARBURETOR/FUEL PUMP

---

Remove the jet needle by removing the needle clip.  
Check the jet needle and throttle valve for wear or damage.

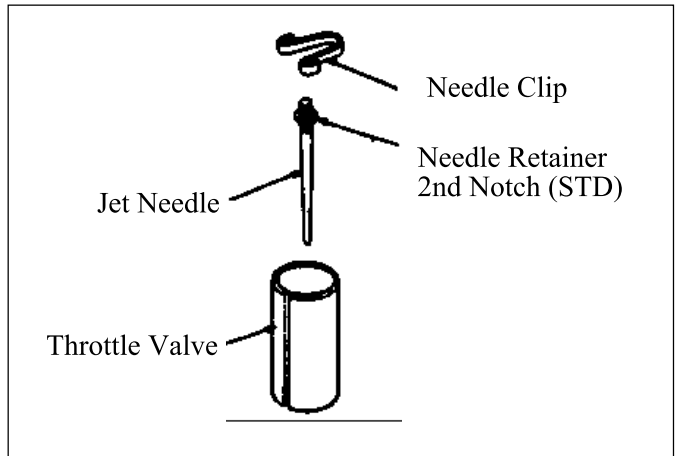

### THROTTLE VALVE INSTALLATION

Install the jet needle on the throttle valve and secure with the needle clip.

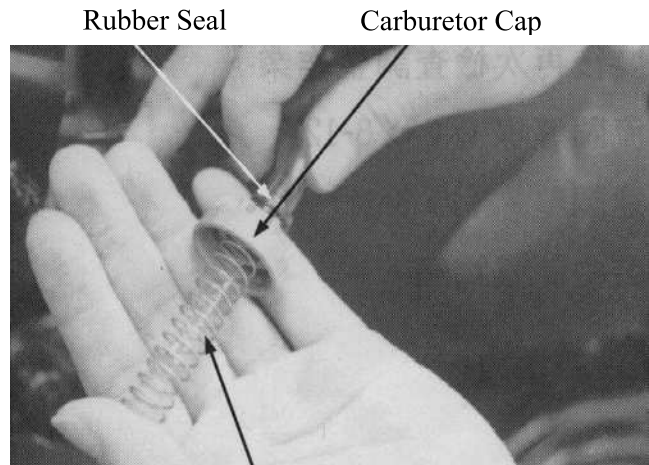

Throttle Valve Spring

Throttle Valve

Install the rubber seal on the throttle cable and then install the carburetor cap and throttle valve spring.  
Connect the throttle cable to the throttle valve.

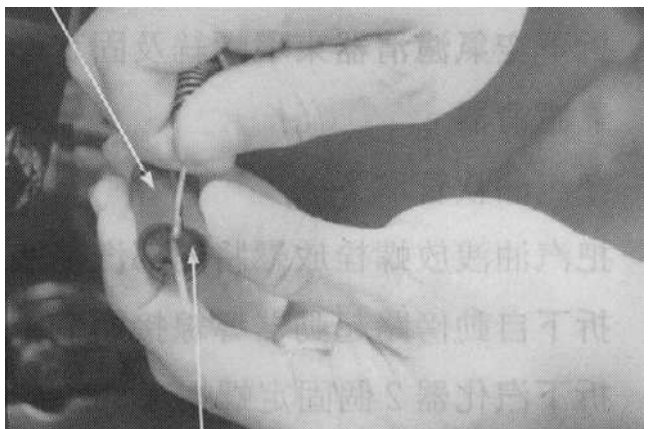

Throttle Cable

## 12. CARBURETOR/FUEL PUMP

---

Install the throttle valve by aligning the groove in the throttle valve with the throttle stop screw.

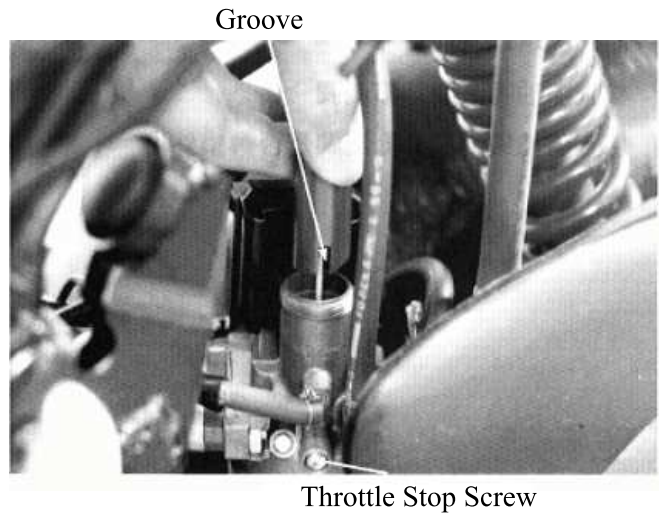

Tighten the carburetor cap.  
After installation, perform the following adjustments and inspections.

- Throttle cable free play (⇒3-12)
- Idle speed adjustment (⇒3-11)

Install the met-in box.

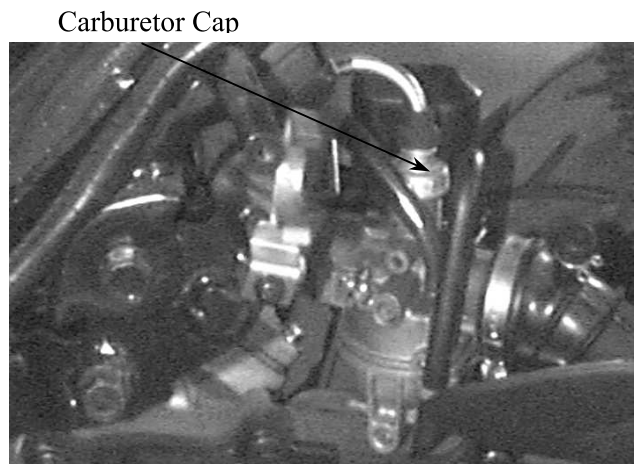

### CARBURETOR REMOVAL

Remove the met-in box. (⇒2-3)  
Remove the air cleaner by removing the air cleaner band screw and attaching bolts.  
Disconnect the fuel tube.  
Loosen the drain bolt to drain fuel from the carburetor.  
Disconnect the auto bystarter wire connector.  
Remove the two carburetor lock nuts.

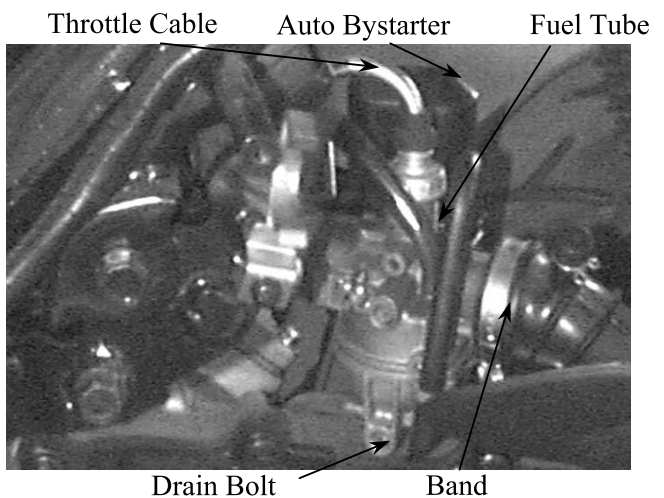

## 12. CARBURETOR/FUEL PUMP

---

Remove the carburetor.

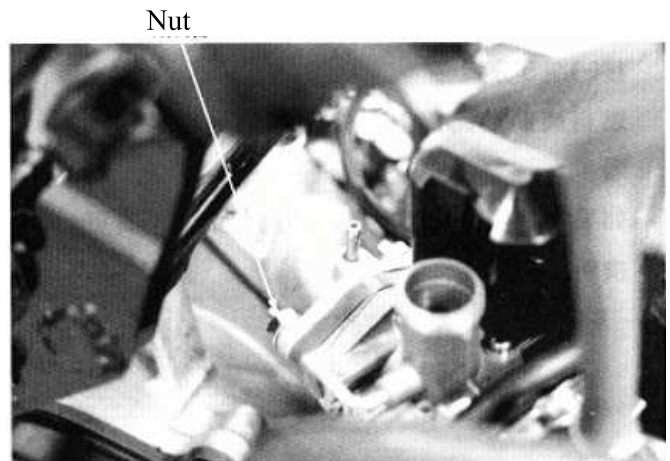

### AUTO BYSTARTER

#### AUTO BYSTARTER INSPECTION

Measure the resistance between the auto bystarter wire terminals.

**Resistance:**  $5\Omega$  (10 minutes minimum after stopping the engine)

If the resistance exceeds  $5\Omega$ , replace the auto bystarter with a new one.



After the engine stops for 30 minutes, connect a hose to the fuel enriching circuit and blow the hose with mouth.  
If air cannot be blown into the hose (clogged), the auto bystarter is faulty. Replace it with a new one.

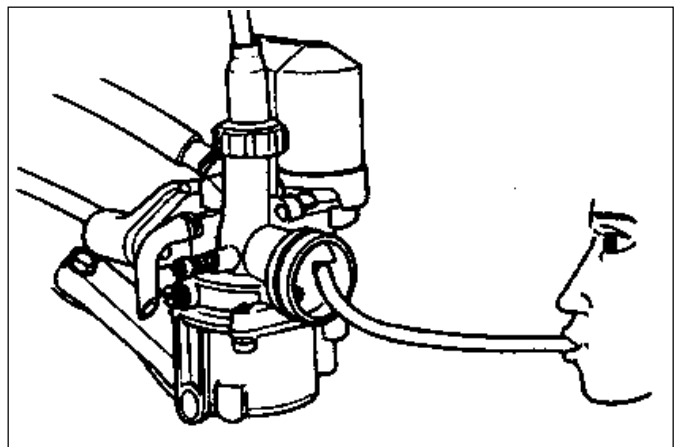



## 12. CARBURETOR/FUEL PUMP

---

Connect the auto bystarter yellow wire to the battery positive (+) terminal and green/black wire to the battery negative (-) terminal and wait 5 minutes.

Connect a hose to the fuel enriching circuit and blow the hose with mouth.

If air can be blown into the hose, the auto bystarter is faulty and replace it with a new one.

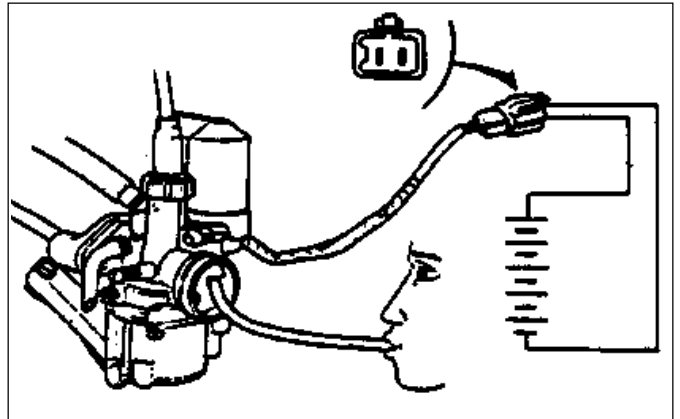

### AUTO BYSTARTER REMOVAL

Remove the auto bystarter cover.

Remove the two auto bystarter set plate screws to remove the auto bystarter.

Auto Bystarter

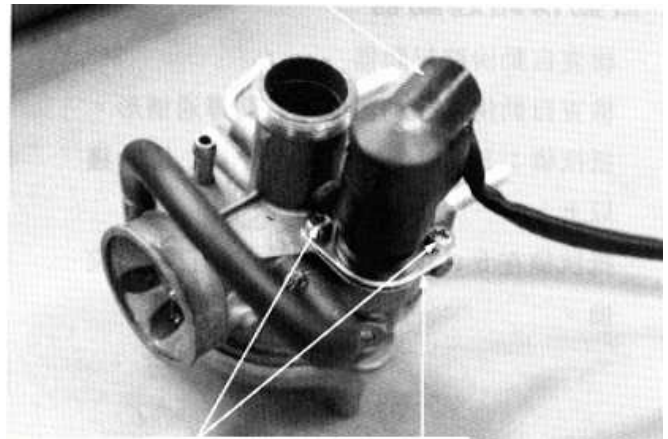

Screws

Set Plate

O-ring

Check the auto bystarter valve and needle for wear or damage.

Check the O-ring for wear or damage.

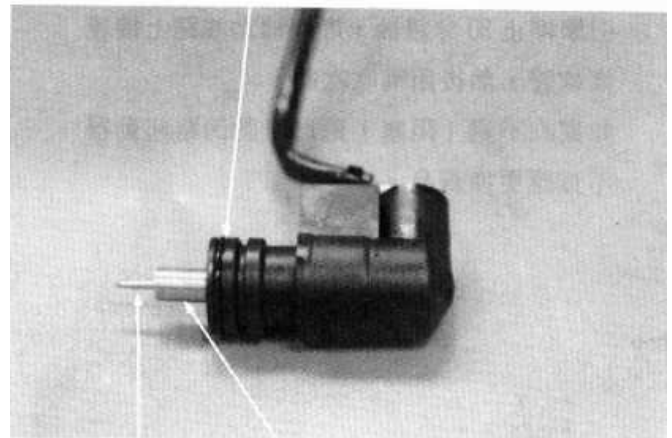

Bystarter Needle

Bystarter Valve



## 12. CARBURETOR/FUEL PUMP

---

### AUTO BYSTARTER INSTALLATION

Install the auto bystarter into the carburetor body until it bottoms..  
Install the set plate and then tighten the two screws.

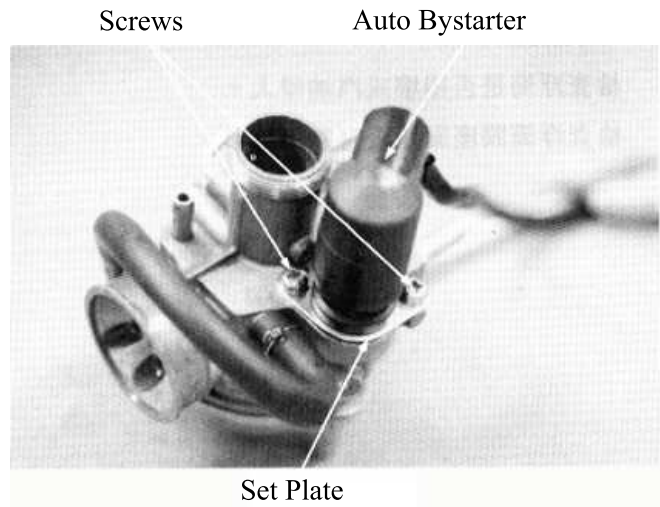

### FLOAT CHAMBER

Remove the two float chamber screws and the float chamber.

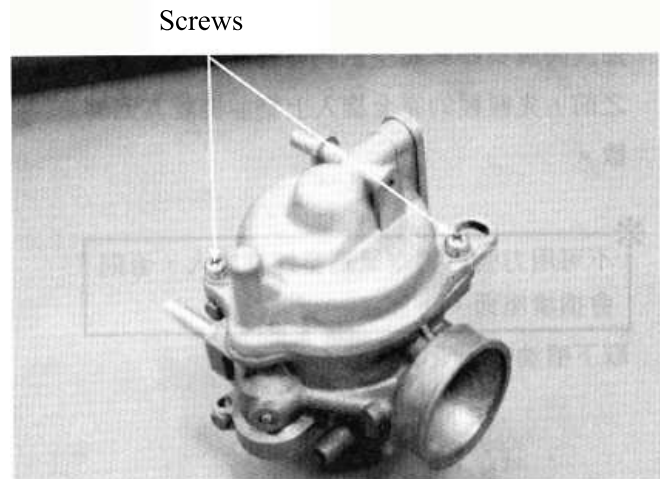

Remove the screw and O-ring.  
Remove the float pin, float and float valve.

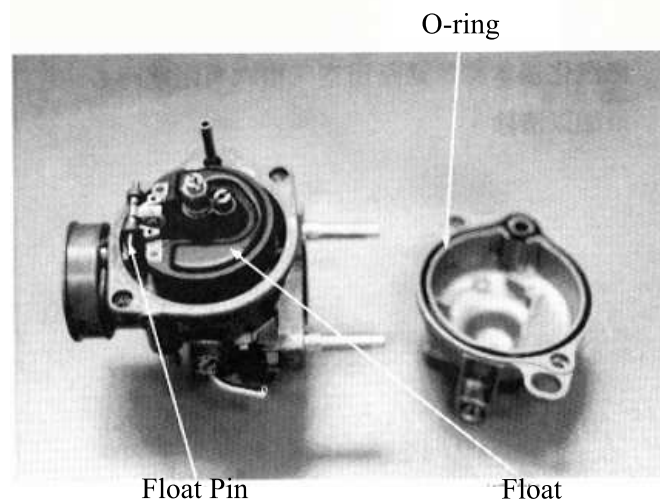

## 12. CARBURETOR/FUEL PUMP

---

### FLOAT/FLOAT VALVE INSPECTION

Inspect the float for damage or fuel inside the float.  
Check the float valve seat for wear or damage.

Float Valve

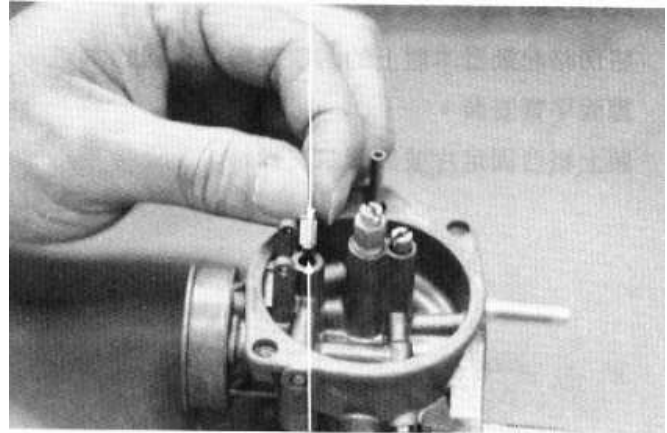

Float Seat

### JETS/SCREWS REMOVAL

Before removing the throttle stop screw or air screw, record the number of rotations until it seats lightly. Then, remove them.

\*

Do not force the air screw against its seat to prevent damage.

Remove the main jet and needle jet holder.

Main Jet

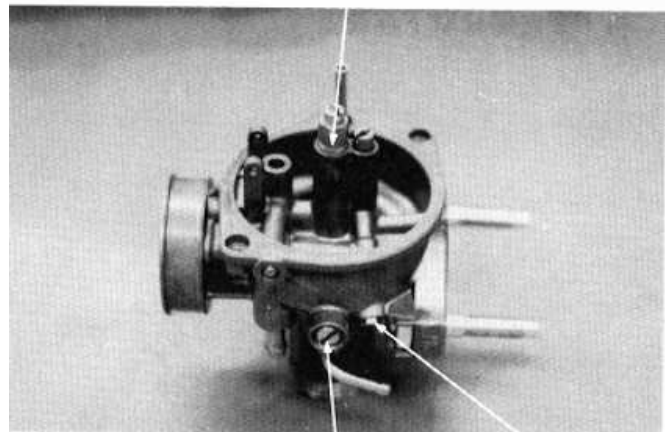

Throttle Stop Screw    Air Screw

### CARBURETOR PASSAGES CLEANING

Blow compressed air through all passages of the carburetor body with an air gun.

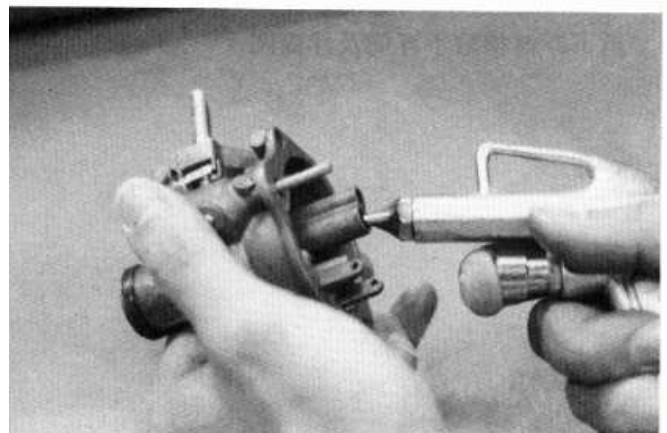

## 12. CARBURETOR/FUEL PUMP

---

### FLOAT CHAMBER ASSEMBLY

Install the main jet and needle jet holder.  
Install the air screw and throttle stop screw according to the rotations recorded.

\*

If the air screw must be replaced, be sure to perform the air screw adjustment again.

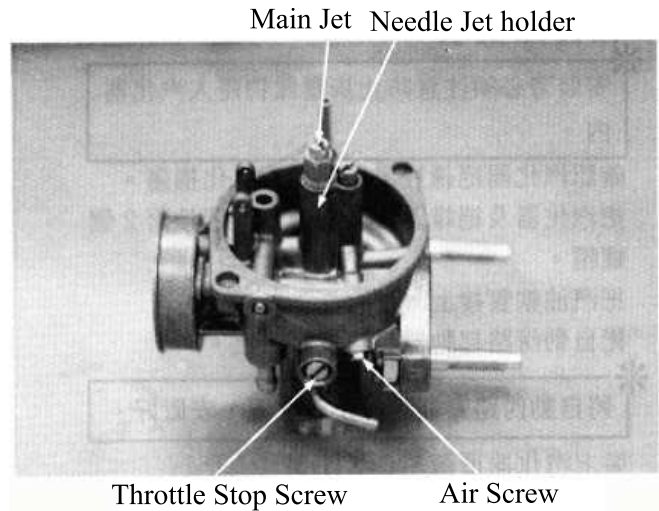

Install the float valve, float and float pin.  
Tighten the float screw securely.

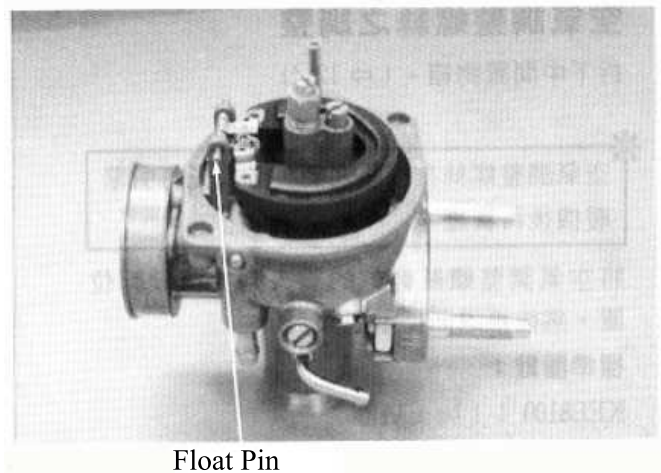

### FLOAT LEVEL INSPECTION

Slightly tilt the carburetor and measure the float level with the float valve just connecting the float arm.

**Float Level:** 8.6mm

Replace the float if the level is out of the specified level range.

Install the O-ring.

Check the operation of the float and install the float chamber.

Tighten the screws.

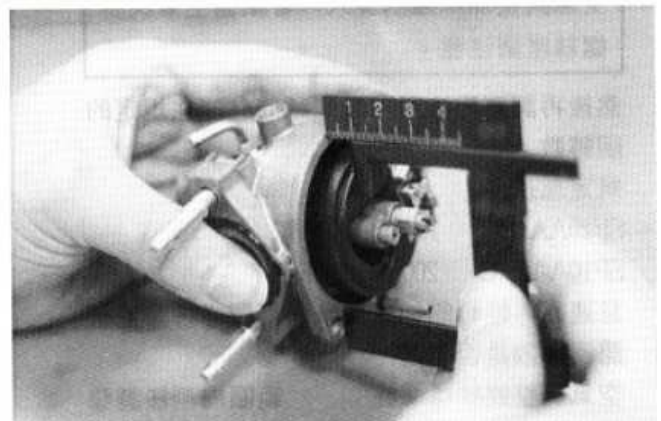

## 12. CARBURETOR/FUEL PUMP

### CARBURETOR INSTALLATION

- \* When installation, do not allow foreign particles to enter the carburetor.

Check the carburetor insulator and O-ring for wear or damage.  
Install the carburetor and insulator onto the intake manifold and tighten the two lock nuts.  
Connect the fuel tube and auto bystarter wire connector.

- \* Route the auto bystarter wire correctly and properly.

Install the carburetor cap. (⇒12-4)  
Install the air cleaner onto the carburetor and tighten the band screw.  
Install the met-in box. (⇒2-3)

### AIR SCREW ADJUSTMENT

Remove the met-in box. (⇒2-3)

- \* Warm up the engine before air screw adjustment.

Turn the air screw clockwise until it seats lightly and back it to the specification given.

#### Air Screw Opening:

SH10BA:  $1\frac{1}{2} \pm \frac{1}{2}$  turns

SH10AA:  $1\frac{1}{4} \pm \frac{1}{2}$  turns

Start the engine and turn the air screw in or out slowly to obtain the highest engine speed.

- \* Do not force the air screw against its seat to prevent damage.

Turn the throttle stop screw to obtain the specified idle speed.

#### Idle Speed:

SH10BA:  $2000 \pm 100$ rpm

SH10AA:  $2000 \pm 100$ rpm

Slightly increase the engine speed and make sure that the engine does not miss or run erratic.

If the adjustment of the air screw within the range of  $\pm\frac{1}{2}$  turn makes no difference to the engine performance, check other related items.

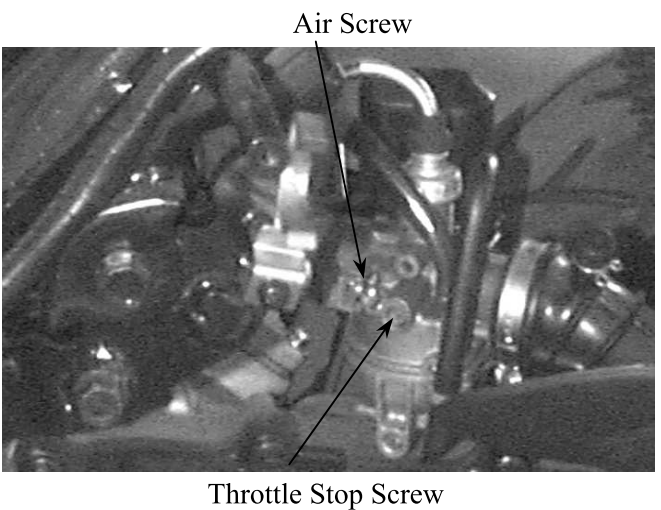
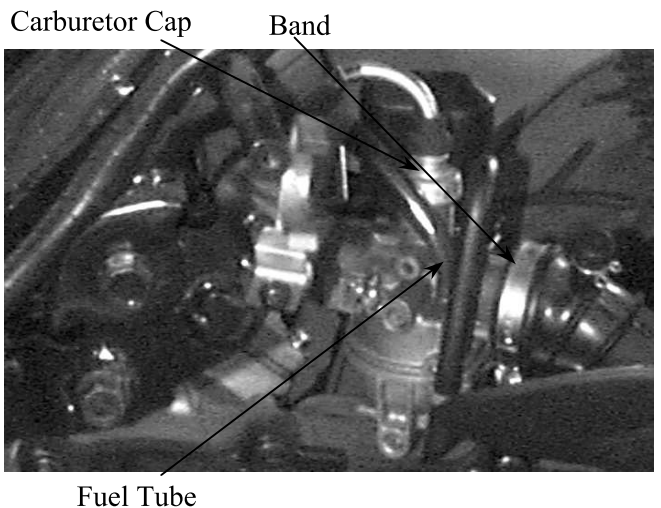
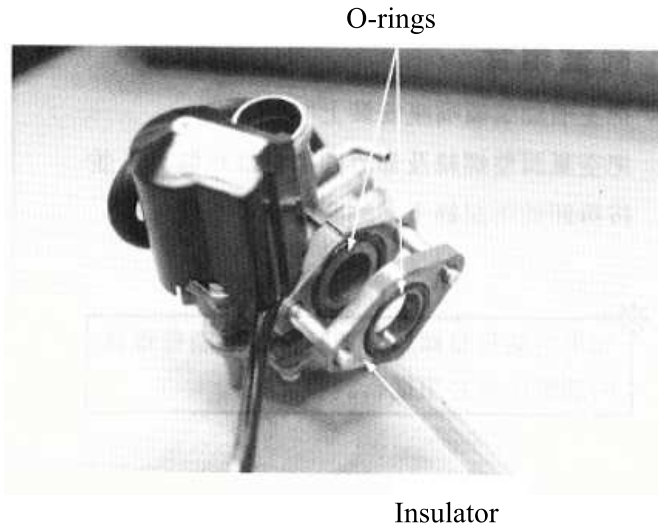



## 12. CARBURETOR/FUEL PUMP

---

### REED VALVE

#### REMOVAL

Remove the rear carrier.  
Remove the frame body cover.  
Remove the four intake manifold bolts and gasket.  
Remove the reed valve and gasket.

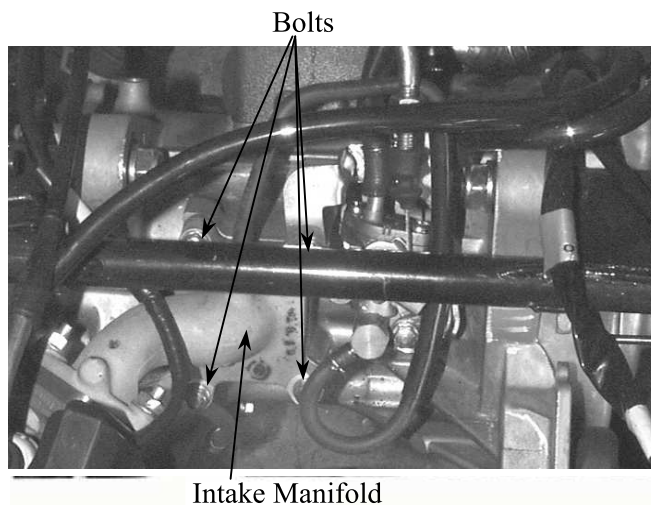

#### INSPECTION

Check the reed valve for damaged or weak reeds.  
Check the reed valve seat for cracks, damage or clearance between the seat and reed.  
Replace the valve if necessary.

\* Do not disassemble or bend the reed stopper. To do so can cause loss of engine power and engine damage. If any of the stopper, reed or valve seat is faulty, replace them as a unit.

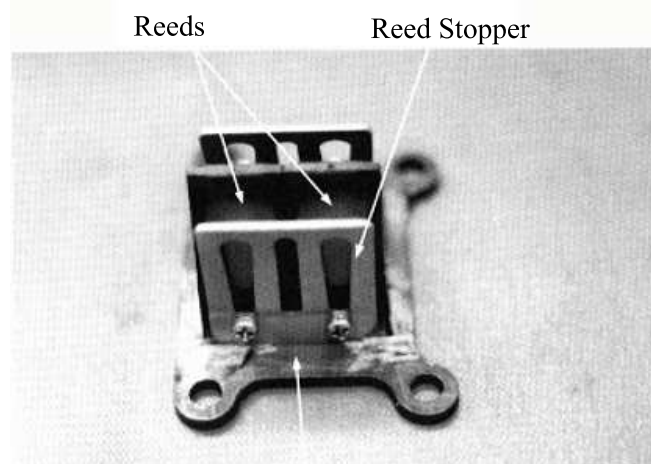

Reed Valve Seat

#### INSTALLATION

Install the reed valve in the reverse order of removal.

\*

- Install a new gasket with the gasket indentation aligned with the reed valve.
- After installation, check for intake air leaks.

## 12. CARBURETOR/FUEL PUMP

---

### FUEL PUMP REMOVAL

Remove the frame center cover.  
Disconnect the fuel pump inlet, outlet and vacuum tubes.  
Remove the two fuel pump attaching bolts and the fuel pump.

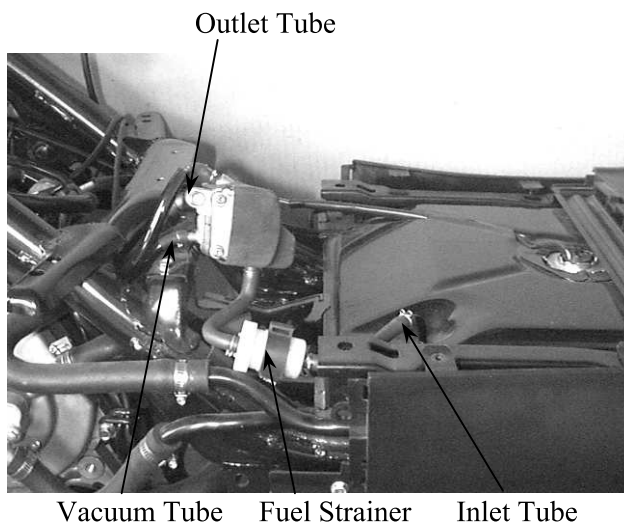

### FUEL PUMP DISASSEMBLY

Remove the four fuel pump body screws.

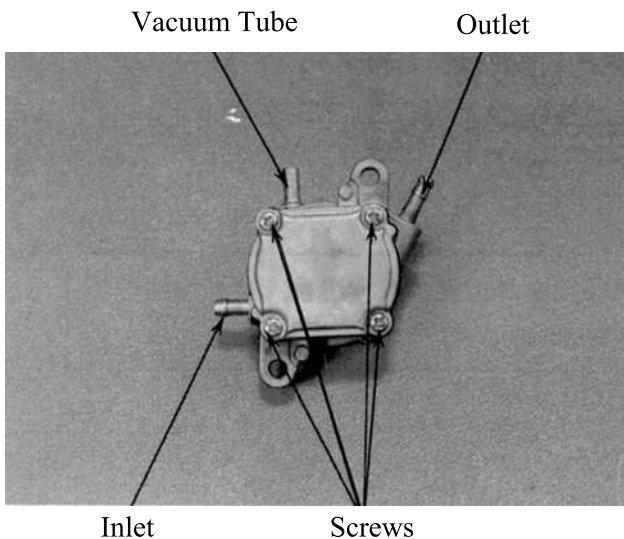

Disassemble the fuel pump.

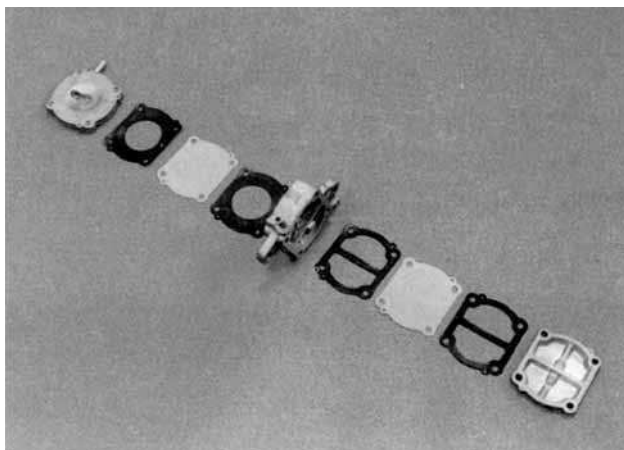

## 12. CARBURETOR/FUEL PUMP

---

### FUEL PUMP INSPECTION

Inspect the fuel pump diaphragms A and B for damage.  
Inspect each gasket for damage.

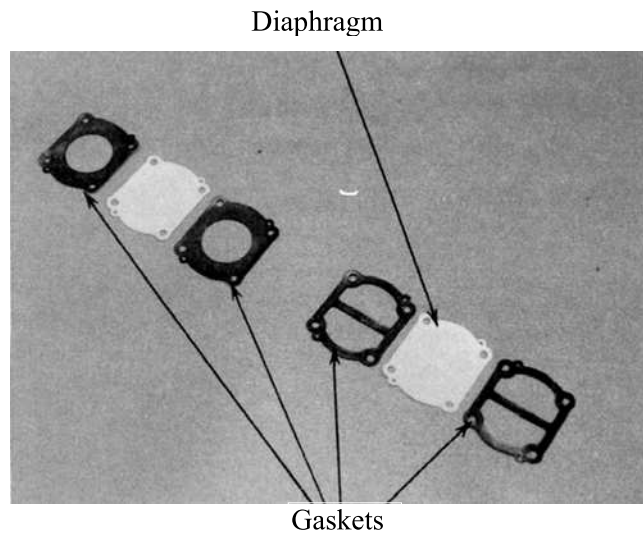

Inspect the suction valve, outlet valve and relief valve in the fuel pump body for damage, cracks or foreign matters.

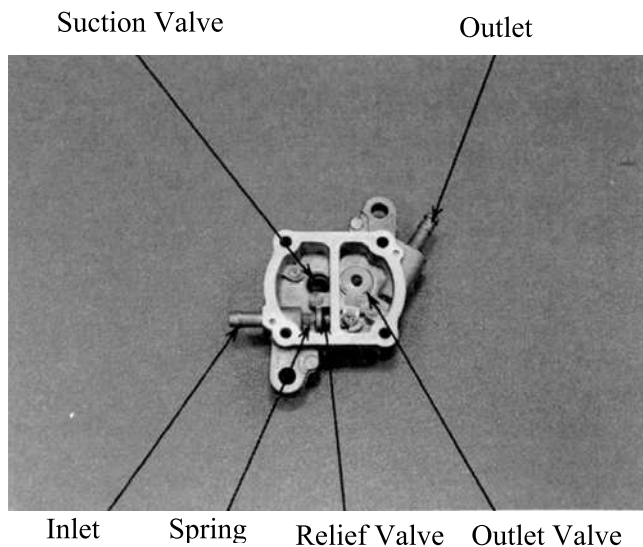

### FUEL PUMP ASSEMBLY

Assemble the fuel pump in the reverse order of disassembly.

- \* During assembly, be sure to install the gaskets and diaphragms properly to avoid damage.
- \* Do not allow any foreign matter to enter the fuel pump during assembly.

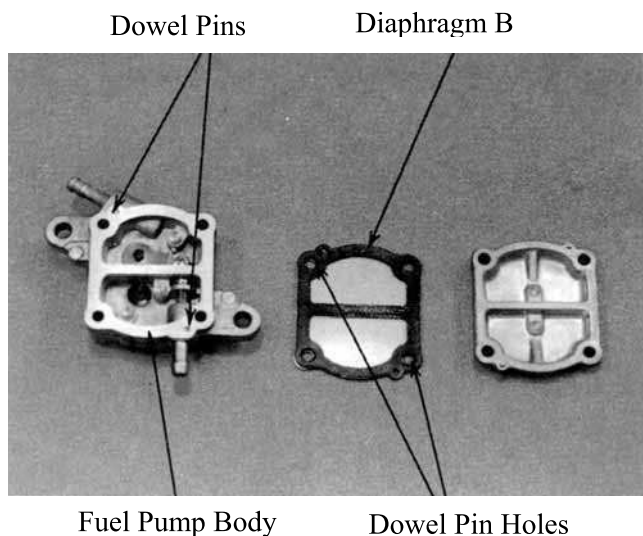

## 12. CARBURETOR/FUEL PUMP

---

### FUEL PUMP INSTALLATION

Install the fuel pump and secure it with the two bolts.  
Connect the fuel pump inlet, outlet and vacuum tubes.  
Install the seat, met-in box and frame center cover.

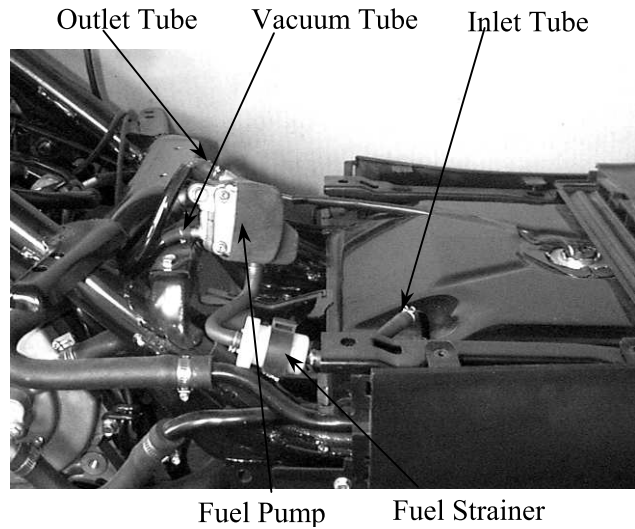

Measure the fuel pump output.  
Start the engine and disconnect the fuel outlet tube and place a clean container under the tube to check the fuel output.  
**Output:** 40cc/1500rpm/10 seconds .

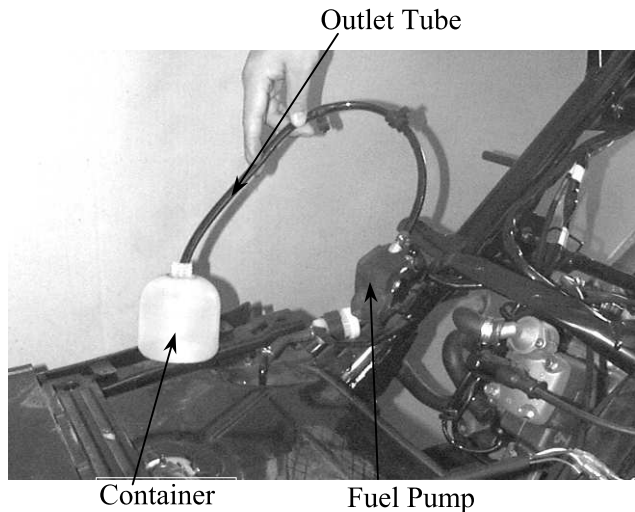



# **13. STEERING HANDLEBAR/FRONT WHEEL/FRONT BRAKE/FRONT SHOCK ABSORBER/FRONT FORK**

---

---

## **STEERING HANDLEBAR/FRONT WHEEL/FRONT BRAKE/FRONT SHOCK ABSORBER/FRONT FORK**

---

SCHEMATIC DRAWING -----	13- 1
SERVICE INFORMATION-----	13- 2
TROUBLESHOOTING-----	13- 3
STEERING HANDLEBAR -----	13- 4
FRONT WHEEL -----	13- 5
FRONT BRAKE -----	13- 8
FRONT SHOCK ABSORBER-----	13-14
FRONT FORK -----	13-17

# 13. STEERING HANDLEBAR/FRONT WHEEL/FRONT BRAKE/FRONT SHOCK ABSORBER/FRONT FORK

---

## SCHEMATIC DRAWING

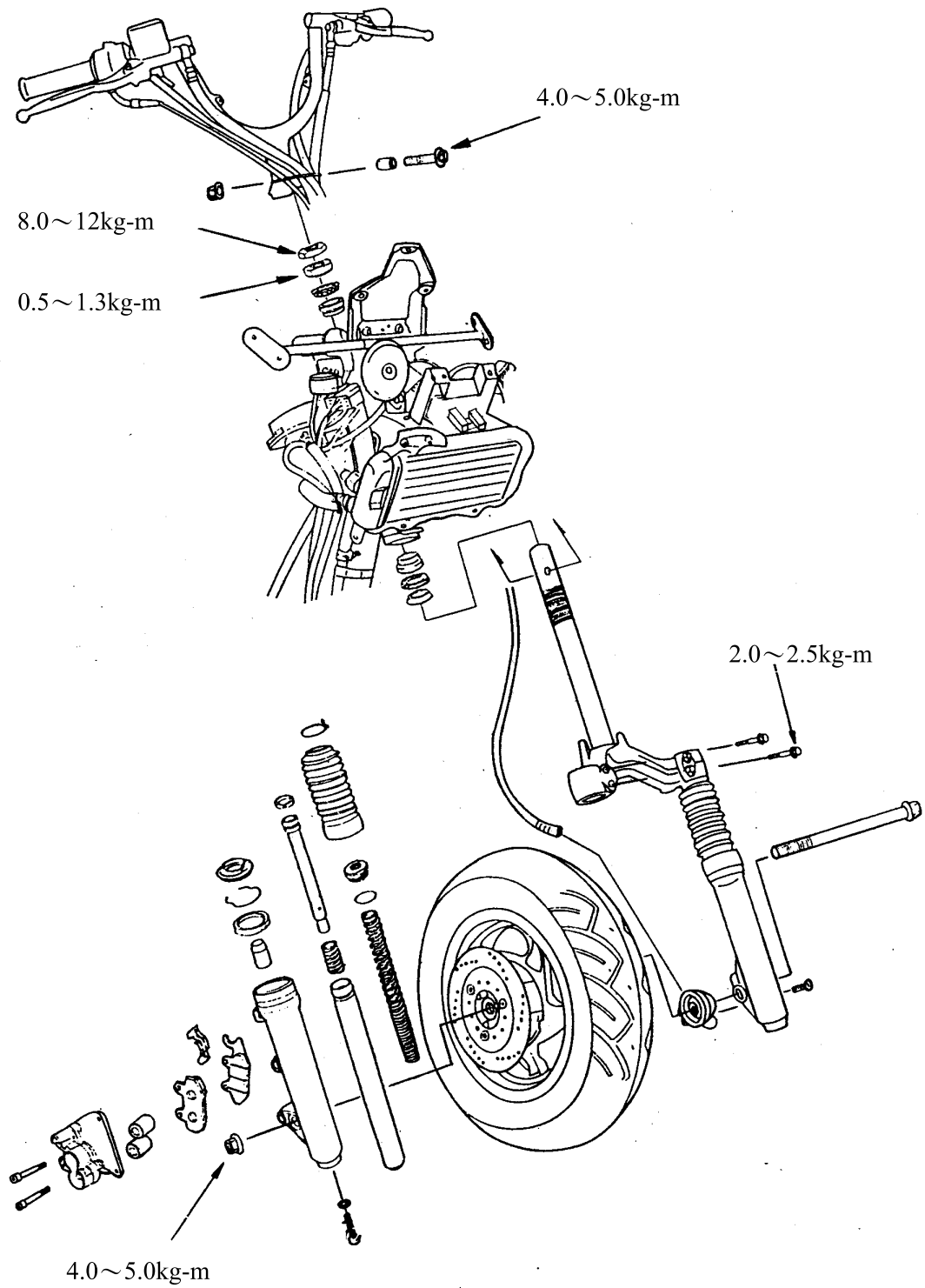

# 13. STEERING HANDLEBAR/FRONT WHEEL/FRONT BRAKE/FRONT SHOCK ABSORBER/FRONT FORK

---

## SERVICE INFORMATION

### GENERAL INSTRUCTIONS

- Remove the motorcycle frame covers before removing the front wheel, steering handlebar, front shock absorber and front fork. Jack the motorcycle front wheel off the ground and be careful to prevent the motorcycle from falling down.
- During servicing, keep oil or grease off the brake pads and brake disk.

### SPECIFICATIONS

Item		Standard (mm)	Service Limit (mm)
Axle shaft runout		—	0.2
Front wheel rim runout	Radial	—	2.0
	Axial	—	2.0
Front brake pad thickness		4.0	2.0
Front shock absorber spring free length		240.6	233
Brake disk thickness		3.8~4.2	3.0
Brake disk runout		—	0.30
Brake master cylinder I.D.		12.700~12.743	12.755
Brake master cylinder piston O.D.		12.657~12.684	12.645
Brake caliper piston O.D.		25.335~25.368	25.30
Brake caliper cylinder I.D.		25.400~25.45	25.45

### TORQUE VALUES

Steering stem lock nut	8.0~12.0kg-m
Steering top cone race	0.5~1.3kg-m
Front shock absorber bolt	2.0~2.5kg-m
Front axle nut	4.5~5.0kg-m
Brake caliper bolt	2.5~3.5kg-m

### SPECIAL TOOLS

Lock nut wrench  
Front shock absorber compressor  
Ball race remover  
Driver handle  
Outer driver, 37x40mm  
Pilot, 12mm  
Bearing remover  
Bearing remover head, 12mm

# 13. STEERING HANDLEBAR/FRONT WHEEL/FRONT BRAKE/FRONT SHOCK ABSORBER/FRONT FORK

---

## TROUBLESHOOTING

### Hard steering (heavy)

- Excessively tightened steering stem top cone race
- Broken steering balls
- Insufficient tire pressure

### Steers to one side or does not track straight

- Uneven front shock absorbers
- Bent front fork
- Bent front axle or uneven tire

### Poor brake performance

- Worn brake pads
- Contaminated brake pad surface
- Deformed brake disk
- Air in brake system
- Deteriorated brake fluid
- Worn brake master cylinder piston oil seal
- Clogged brake fluid line
- Unevenly worn brake caliper

### Front wheel wobbling

- Bent rim
- Loose front axle
- Bent spoke plate
- Faulty tire
- Improperly tightened axle nut

### Soft front shock absorber

- Weak shock springs
- Insufficient damper oil

### Front shock absorber noise

- Slider bending
- Loose fork fasteners
- Lack of lubrication

# 13. STEERING HANDLEBAR/FRONT WHEEL/FRONT BRAKE/FRONT SHOCK ABSORBER/FRONT FORK

## STEERING HANDLEBAR

### REMOVAL

- Remove the handlebar front and rear covers. (⇒2-6)
- Remove the front and rear brake master cylinder attaching bolts.
- Remove the front upper cover. (⇒2-5)
- Remove the front lower cover. (⇒2-5)
- Remove the floor board. (⇒2-4)
- Remove the leg shield. (⇒2-5)

- Remove the four screws attaching the right and left handlebar switches.
- Disconnect the throttle cable from the throttle grip and remove the throttle grip from the handlebar.

- Remove the handlebar lock nut and take out the bolt.
- Remove the handlebar.

### INSTALLATION

- Install the handlebar onto the steering stem and install the handlebar collar, lock nut and bolt.
- Tighten the bolt to the specified torque.
- Torque:** 4.0~5.0kg-m

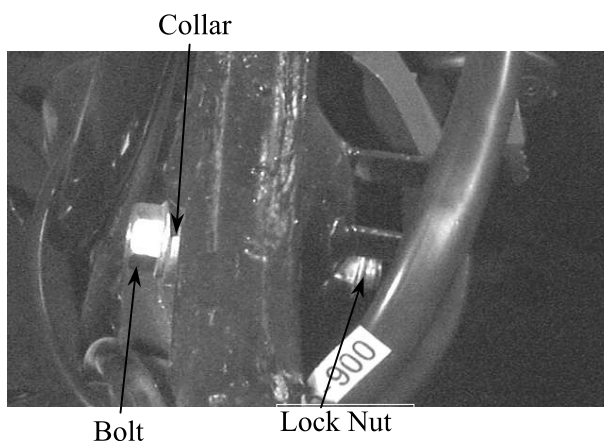
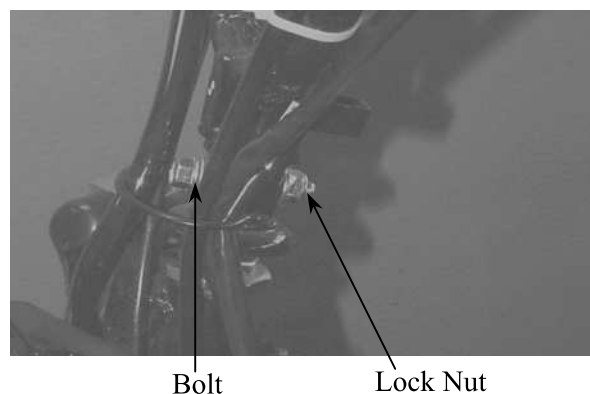
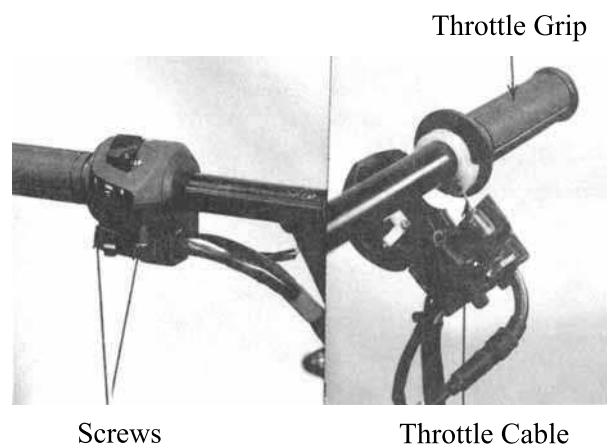
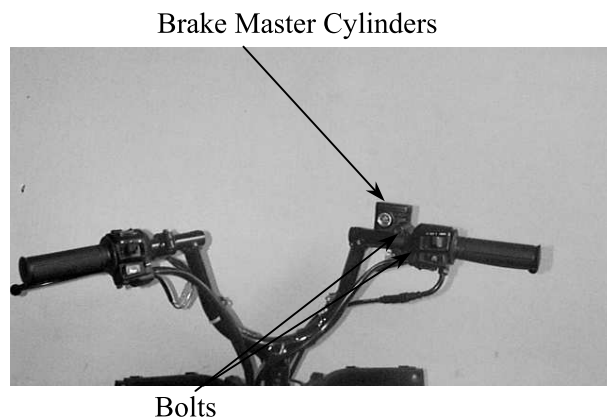

# 13. STEERING HANDLEBAR/FRONT WHEEL/FRONT BRAKE/FRONT SHOCK ABSORBER/FRONT FORK

Lubricate the throttle grip front end with grease and then install the throttle grip. Connect the throttle cable to the throttle grip. Install the right and left handlebar switches and tighten the screws.

- \* Adjust the throttle grip free play to the specified range of 2~6mm.

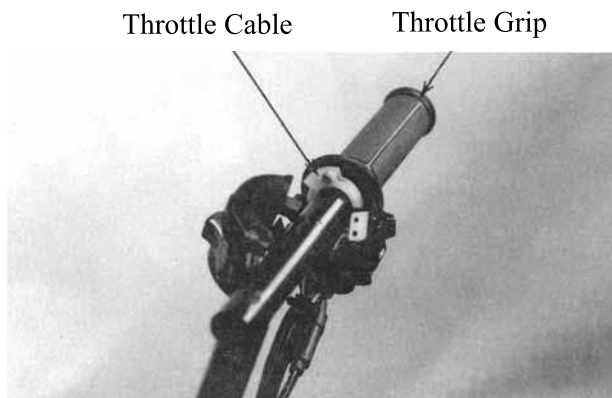

Install the front and rear brake master cylinders.

- \* Install the brake master cylinders by aligning the index marks.

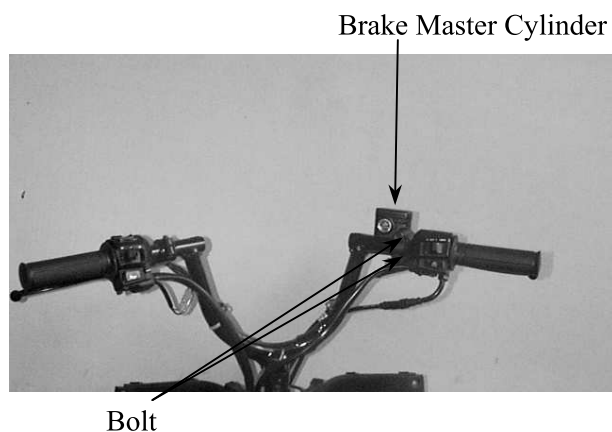

## FRONT WHEEL

### REMOVAL

Jack the motorcycle front wheel off the ground. Remove the front axle nut to pull out the axle. Remove the front wheel and the speedometer gear unit.

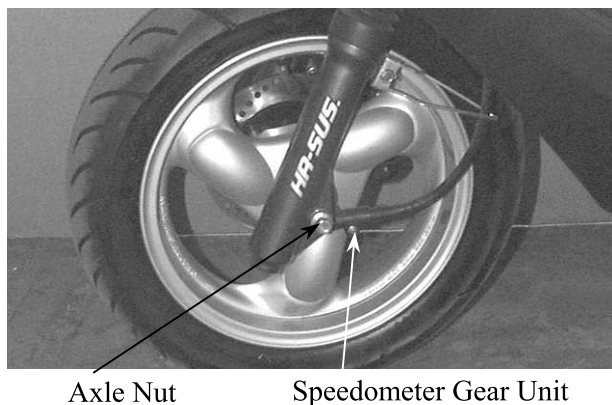

### INSPECTION

#### AXLE RUNOUT

Set the axle in V blocks and measure the runout using a dial gauge. The actual runout is  $\frac{1}{2}$  of the total indicator reading.

**Service Limit:** 0.2mm replace if over

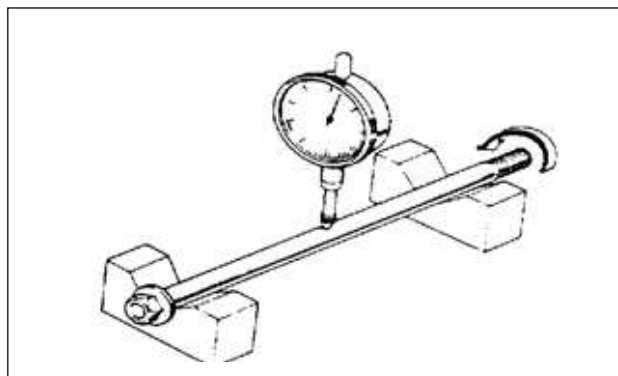

# 13. STEERING HANDLEBAR/FRONT WHEEL/FRONT BRAKE/FRONT SHOCK ABSORBER/FRONT FORK

---

## WHEEL RIM

Check the wheel rim runout.

### Service Limits:

**Radial:** 2.0mm replace if over

**Axial:** 2.0mm replace if over

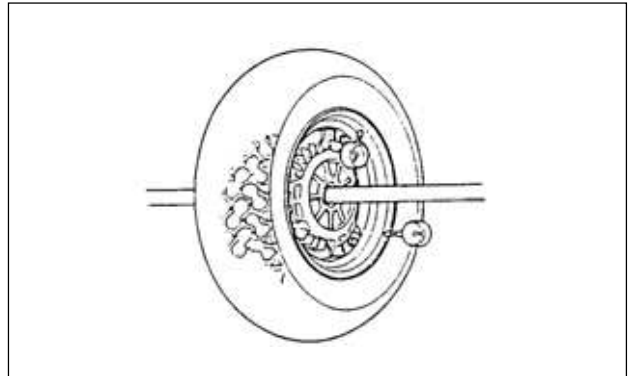

## FRONT WHEEL BEARING

Remove the side collar and dust seal.



Turn the inner race of each bearing with your finger to see if they turn smoothly and quietly. Also check if the outer race fits tightly in the hub.

Replace the bearings if the races do not turn smoothly, quietly, or if they fit loosely in the hub.

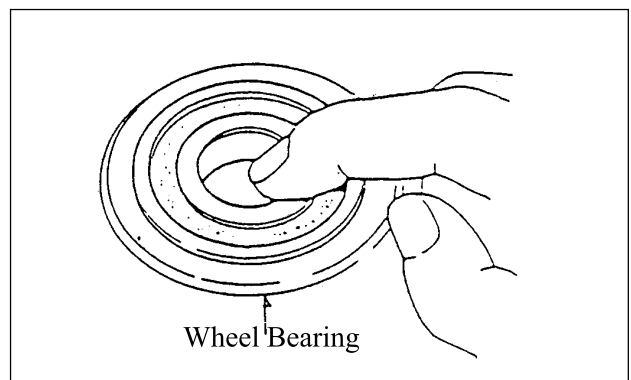

## BEARING REPLACEMENT

Remove the front wheel bearings and distance collar.

### Special Tools

Bearing Remover

Bearing Remover Head, 12mm



# 13. STEERING HANDLEBAR/FRONT WHEEL/FRONT BRAKE/FRONT SHOCK ABSORBER/FRONT FORK

Pack all bearing cavities with grease.  
Drive in the left bearing.  
Install the distance collar.  
Drive in the right bearing.

- \* Do not allow the bearings to tilt while driving them in.
- \* Drive in the bearing squarely with the sealed end facing out.

## Special Tools

Outer driver, 32x35mm  
Driver handle A  
Pilot, 12mm

Driver Handle A



Outer Driver, 32x35mm      Pilot, 12mm

## INSTALLATION

Apply grease to the speedometer gear unit.  
Install the speedometer gear unit by aligning its retaining pawl with the hub cutout.

- \* If not aligned, the retaining pawl will be deformed when the axle nut is tightened.
- \* After installing the axle, turn the wheel to make sure that the speedometer drive shaft rotates freely.

Speedometer Gear Unit



Hub Cutout      Pawl

Install the front wheel by aligning the speedometer gear unit groove with the front shock absorber tab.  
Insert the axle and tighten the axle nut.

- \* When installing the front wheel, position the brake disk between the two brake pads.

**Torque:** 4.5~5.0kg-m

Tab

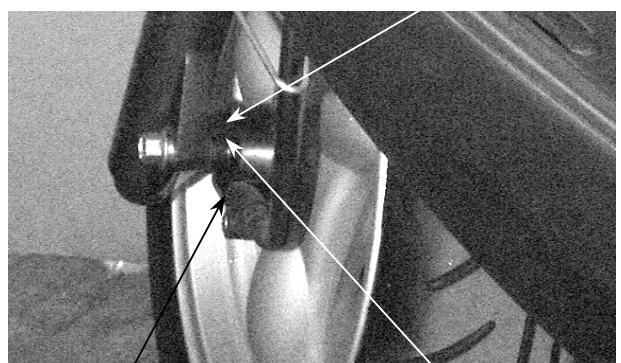

Speedometer Gear Unit      Groove



# 13. STEERING HANDLEBAR/FRONT WHEEL/FRONT BRAKE/FRONT SHOCK ABSORBER/FRONT FORK

## FRONT BRAKE

### BRAKE MASTER CYLINDER

#### REMOVAL

- Remove the handlebar covers. (⇒2-6)
- First drain the brake fluid from the hydraulic brake system.
- Disconnect the front stop switch wire connector.
- Remove the brake fluid tube bolt.
- Remove the two bolts attaching the brake master cylinder
- Remove the brake master cylinder.

- \* When servicing the brake system, use shop towels to cover rubber and plastic parts and coated surfaces to avoid being contaminated by brake fluid.
- \* When removing the brake fluid tube bolt, be sure to plug the tube end to avoid brake fluid leakage.

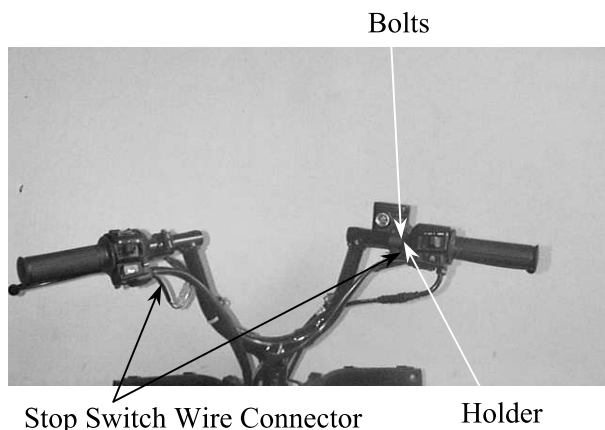

Snap Ring

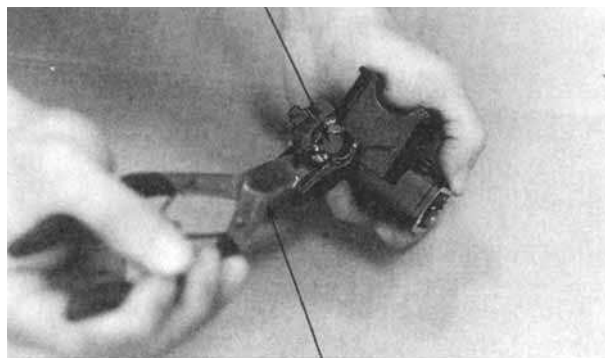

Snap Ring Pliers (Close)

### DISASSEMBLY

- Remove the brake lever bolt and the brake lever.
- Remove the piston rubber cover and snap ring from the brake master cylinder.

- Remove the washer, main piston and spring from the brake master cylinder.
- Clean the inside of the master cylinder and brake reservoir with brake fluid.

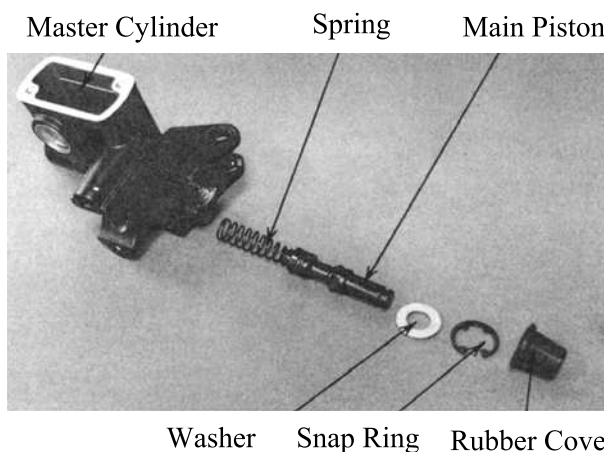

# 13. STEERING HANDLEBAR/FRONT WHEEL/FRONT BRAKE/FRONT SHOCK ABSORBER/FRONT FORK

## INSPECTION

Measure the brake master cylinder I.D.  
Inspect the master cylinder for scratches or cracks.

**Service Limit:** 12.75mm

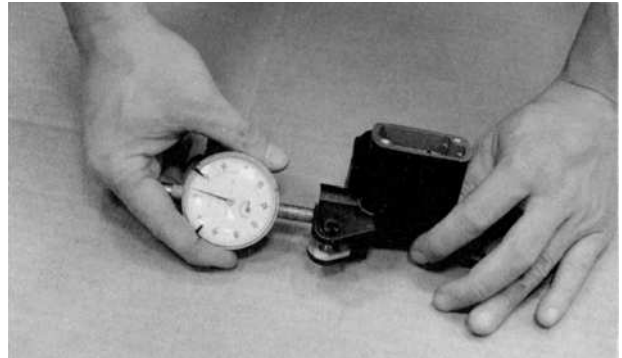

Measure the brake master cylinder piston O.D.

**Service Limit:** 12.645mm

Before assembly, inspect the 1st and 2nd rubber cups for wear.

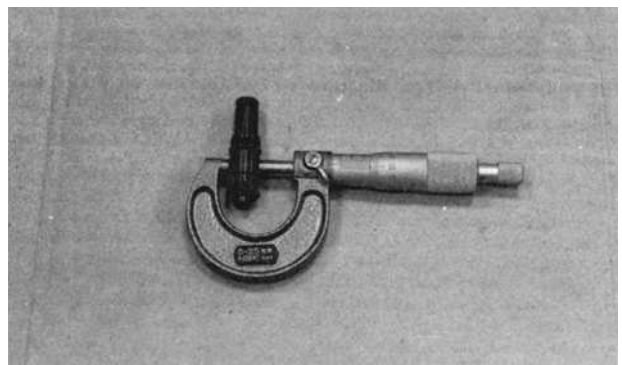

## ASSEMBLY

Before assembly, apply brake fluid to all removed parts.  
Install the spring together with the 1st rubber cup.

- \*
- During assembly, the main piston and spring must be installed as a unit without exchange.
  - When assembling the piston, soak the cups in brake fluid for a while.
  - Install the cups with the cup lips facing the correct direction.

Install the main piston, spring and snap ring.  
Install the rubber cover.  
Install the brake lever.  
Place the brake master cylinder on the handlebar and install the holder with the “up” mark facing up. Also align the punch mark with the holder joint seam.  
First tighten the upper bolt and then tighten the lower bolt.

**Torque:** 1.0~1.4kg-m

Install the brake fluid tube with the attaching bolt and two sealing washers.

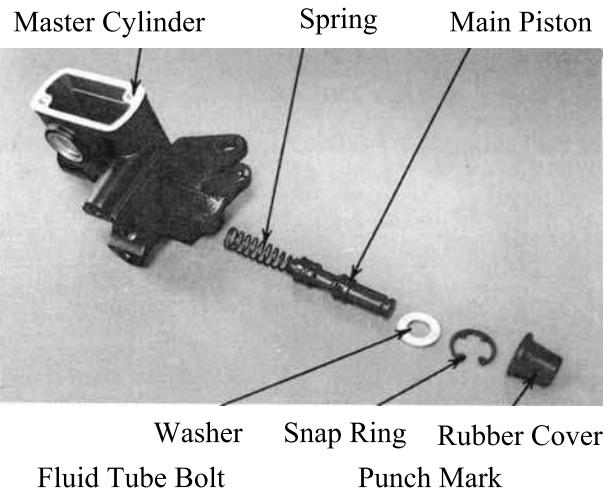

“Up” Mark

# 13. STEERING HANDLEBAR/FRONT WHEEL/FRONT BRAKE/FRONT SHOCK ABSORBER/FRONT FORK

Connect the front stop switch wire connector.  
Install the handlebar covers. (⇒2-6)



Stop Switch Wire Connector

## BRAKE FLUID REFILLING

Keep the handlebar upright and remove the brake reservoir cover and diaphragm.  
Add DOT-3 brake fluid to the brake reservoir.

- \* • When bleeding, be careful not to allow air in the brake reservoir flowing into the brake system.
- When using a brake bleeder, follow the manufacturer's instructions.
- Never use dirty or unspecified brake fluid or mix different brake fluids because it will damage the brake system.



## BRAKE FLUID BLEEDING

Keep the handlebar upright and remove the brake reservoir cover and diaphragm. Add the specified brake fluid to the upper limit.

- \* • Do not allow dust or water to enter the brake system during refilling.
- When servicing the brake system, use shop towels to cover plastic parts and coated surfaces to avoid damage caused by splash of brake fluid.

In order to avoid spilling brake fluid, connect a transparent hose to the bleed valve.

### Warning

Brake fluid spilled on brake pads or brake disk will reduce the braking effect. Clean the brake pads and brake disk with a high quality brake degreaser.

Fully apply the brake lever and then loosen the brake caliper bleed valve to drain the brake fluid until there is no air bubbles in the brake fluid. Then, tighten the bleed valve. Repeat these steps until the brake system is free of air.

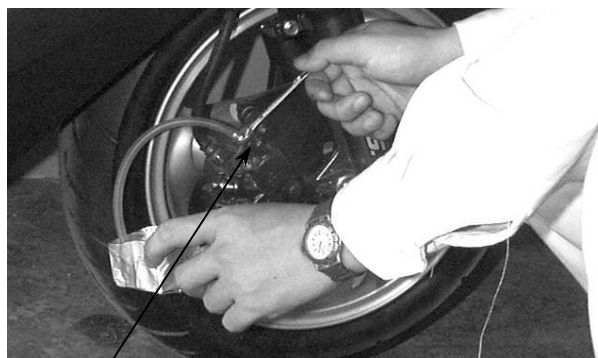

Bleed Valve

# 13. STEERING HANDLEBAR/FRONT WHEEL/FRONT BRAKE/FRONT SHOCK ABSORBER/FRONT FORK

---

## BRAKE CALIPER

### REMOVAL

First drain the brake fluid from the hydraulic brake system.  
Remove the brake fluid tube bolt.  
Remove the two bolts attaching the brake caliper.  
Remove the brake caliper.

Bleed Valve



Fluid Tube Bolt

Bolts

### DISASSEMBLY

Remove the two brake pads dowel pins from the brake caliper.  
Remove the brake pads.

Brake Pad

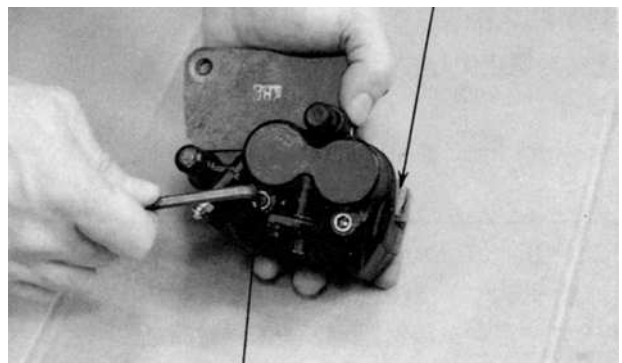

Dowel Pin

Remove the piston from the brake caliper.  
If necessary, use compressed air to squeeze out the piston through the brake fluid inlet opening and place a shop towel under the caliper to avoid contamination caused by the removed piston.  
Check the piston cylinder for scratches or wear and replace if necessary.



Compressed Air

Push the piston oil seal outward to remove it.  
Clean the oil seal groove with brake fluid.

\* Be careful not to damage the piston surface.

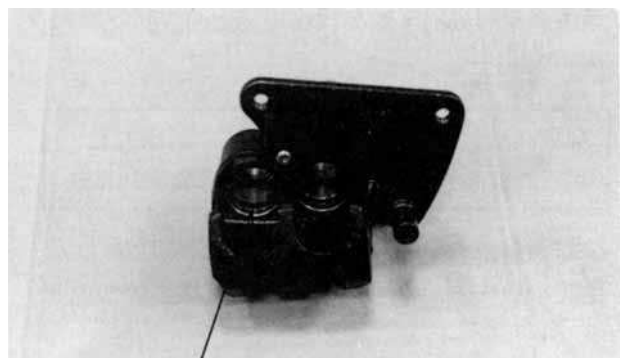

Piston Oil Seal

# 13. STEERING HANDLEBAR/FRONT WHEEL/FRONT BRAKE/FRONT SHOCK ABSORBER/FRONT FORK

---

Check the piston for scratches or wear.  
Measure the piston O.D. with a micrometer gauge.

**Service Limit:** 25.30mm

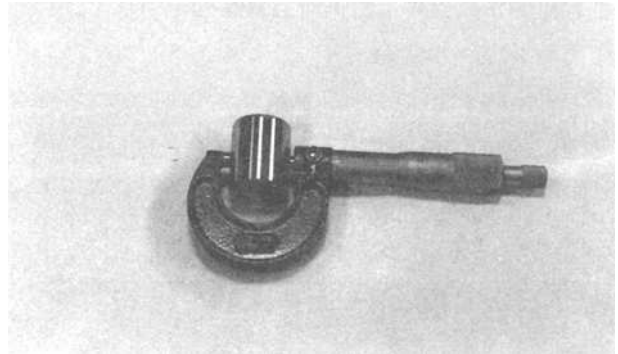

Check the caliper cylinder for scratches or wear and measure the cylinder bore.

**Service Limit:** 25.45mm

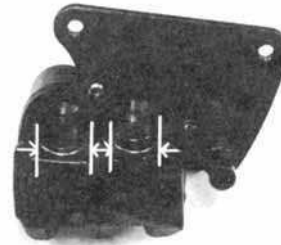

## ASSEMBLY

Clean all removed parts.  
Apply silicon grease to the piston and oil seal.  
Lubricate the brake caliper cylinder inside wall with brake fluid.  
Install the brake caliper piston with grooved side facing out.

- \* Install the piston with its outer end protruding 3 ~ 5mm beyond the brake caliper.

Wipe off excessive brake fluid with a clean shop towel. Apply silicon grease to the brake caliper seat pin and caliper inside.  
Install the brake caliper seat.

## INSTALLATION

Install the brake caliper to the shock absorber and tighten the two bolts.

**Torque:** 2.5 ~ 3.5kg-m

- \* When installing the brake caliper, be sure to position the brake disk between the two brake pads.

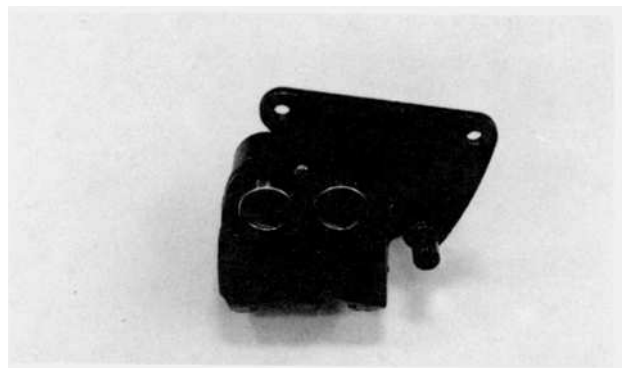

Fluid Tube Bolt

Brake Caliper

# 13. STEERING HANDLEBAR/FRONT WHEEL/FRONT BRAKE/FRONT SHOCK ABSORBER/FRONT FORK

---

Connect the brake fluid tube to the brake caliper and tighten the fluid tube bolt.

**Torque:** 2.5~3.5kg-m

Fill the brake reservoir with the specified brake fluid and bleed air from the brake system. (⇒13-10)

\* When installing the brake fluid tube, be sure to install the two copper sealing washers.

Brake Fluid Tube



Fluid Tube Bolt

Copper Washers

# 13. STEERING HANDLEBAR/FRONT WHEEL/FRONT BRAKE/FRONT SHOCK ABSORBER/FRONT FORK

## FRONT SHOCK ABSORBER

### REMOVAL

Remove the front upper cover. (⇒2-5)  
Remove the front lower cover. (⇒2-5)  
Remove the front wheel. (⇒13-5)  
Remove the front brake caliper. (⇒13-11)  
Remove the front shock absorber upper mount bolts.  
Loosen the lower mount bolts to remove the front shock absorbers.

### DISASSEMBLY

Remove the dust boot.  
Remove the dust seal.  
Remove the circlip.

Set the front shock absorber in a vise.  
Remove the damper rod hex bolt and copper washer.  
Pull out the front shock absorber tube.

\* After the hex bolt is removed, place a container under the front shock absorber to drain the engine oil from it.

Set the front shock absorber tube in a vise.  
Remove the lock nut on the front shock absorber tube.  
Take out the shock absorber spring and damper rod.

\* When holding the shock absorber tube, place a shop towel to protect it and do not apply too much force.

Front Fork

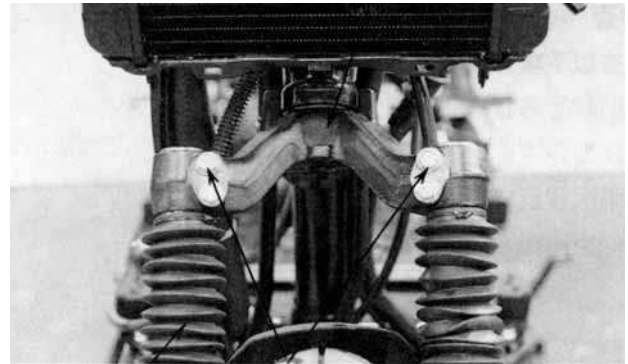

Shock Absorber

Mount Bolts

Dust Boot

Circlip

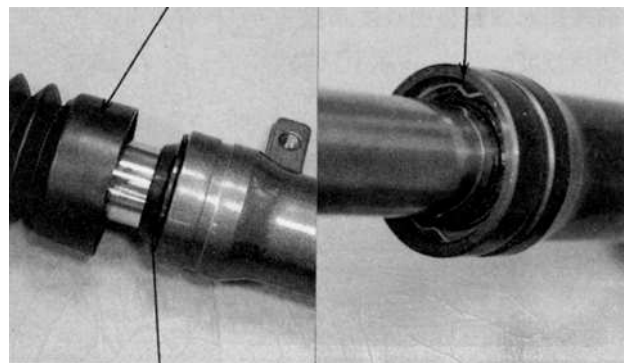

Dust Seal

Copper Washer



Hex Bolt



Lock Nut

Shock Absorber Tube

# 13. STEERING HANDLEBAR/FRONT WHEEL/FRONT BRAKE/FRONT SHOCK ABSORBER/FRONT FORK

---

## INSPECTION

Inspect the following items and replace if necessary.

- Front shock absorber tube bending, damage or wear
- Weak front shock absorber spring
- Damper and damper rod bending
- Oil seal damage or wear

Shock Absorber Tube

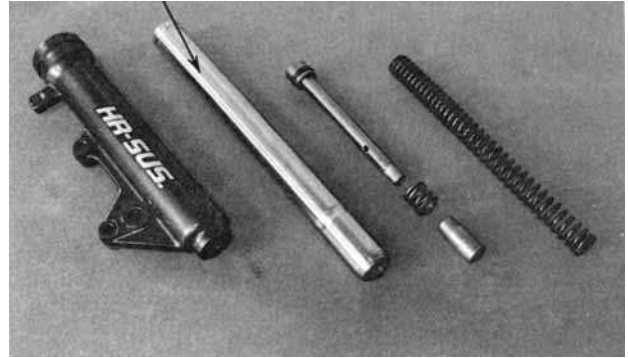

Measure the front shock absorber spring free length.

**Service Limit:** 233mm replace if below

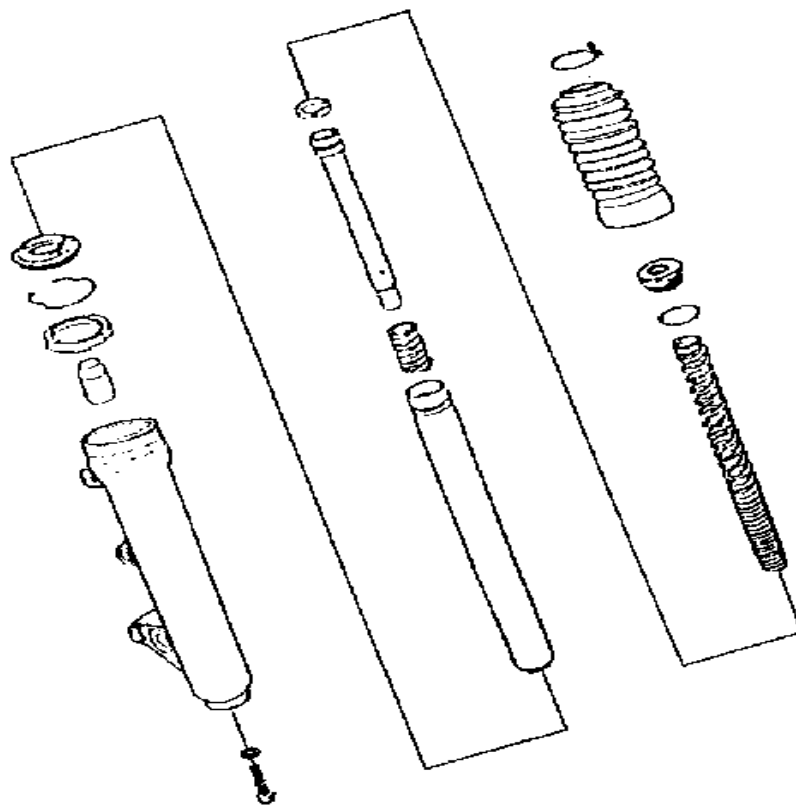
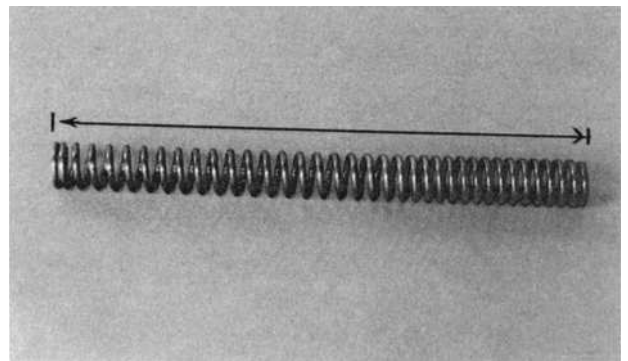



# 13. STEERING HANDLEBAR/FRONT WHEEL/FRONT BRAKE/FRONT SHOCK ABSORBER/FRONT FORK

## ASSEMBLY

Install the damper spring onto the damper rod and then install them into the front shock absorber tube.

Install the shock absorber spring onto the front shock absorber tube.

Set the front shock absorber tube in a vise and then tighten the lock nut.

\* When holding the shock absorber tube, place a shop towel to protect it and do apply too much force .

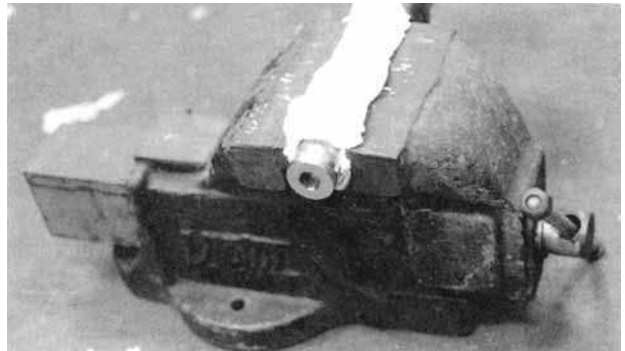

Set the front shock absorber in a vise. Insert the shock absorber tube into the shock absorber and then install the copper washer and tighten the damper rod hex bolt.

\* Apply locking agent to the washer and hex bolt and install them together.

Add engine oil into the front shock absorber.

**Torque:** 1.5~3.0kg-m

**Specified Oil:** SS#8

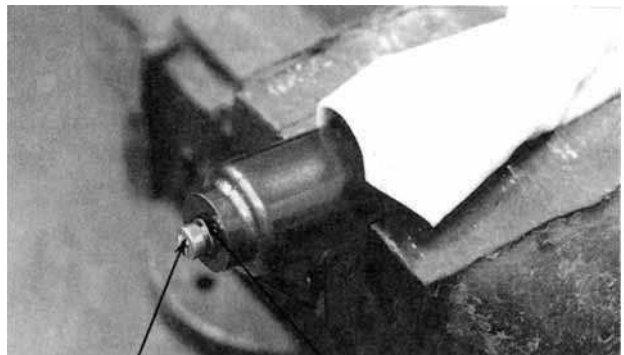

Hex Bolt

Copper Washer

**Oil Capacity:** 52cc

Install the oil seal

Install the circlip.

Install the dusts seal and dust boot.

Circlip

Dust Boot

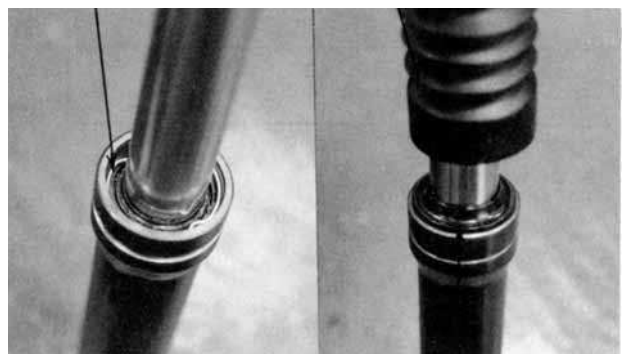

Dust Seal

## INSTALLATION

Install the front shock absorbers onto the front fork.

Install and tighten the front shock absorber upper mount bolts.

Tighten the lower mount bolts.

\* Align the upper mount bolt hole with the groove on the front fork.

Install the front wheel. (⇒13-7)

# 13. STEERING HANDLEBAR/FRONT WHEEL/FRONT BRAKE/FRONT SHOCK ABSORBER/FRONT FORK

## FRONT FORK

### REMOVAL

Remove the handlebar covers. (⇒2-6)  
Remove the steering handlebar. (⇒13-4)  
Remove the front upper cover. (⇒2-5)  
Remove the front lower cover. (⇒2-5)  
Remove the front inner fender. (⇒2-6)  
Remove the front wheel. (⇒13-5)  
Remove the front brake caliper. (⇒13-11)  
Hold the steering stem top cone race and remove the steering stem lock nut.  
Remove the top cone race and remove the front fork.

\* Be careful not to lose the steel balls (26 on top race and 19 on bottom race).

Inspect the ball races, cone races and steel balls for wear or damage. Replace if necessary.

### BOTTOM CONE RACE REPLACEMENT

Remove the bottom cone race using a chisel.

Drive a new bottom cone race into place with a proper driver.

\* Be careful not to damage the steering stem and front fork.

### BALL RACE REPLACEMENT

Drive out the ball races.

Lock Nut Socket



Lock Nut Wrench

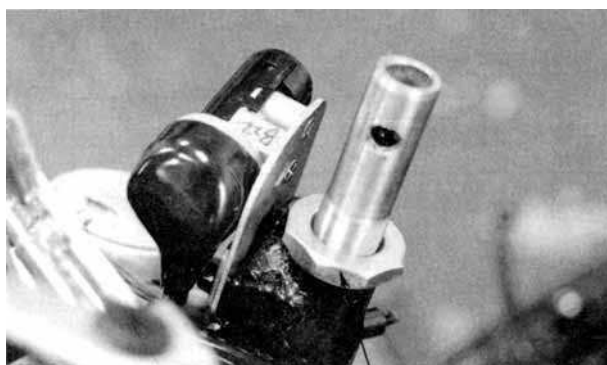

Top Cone Race

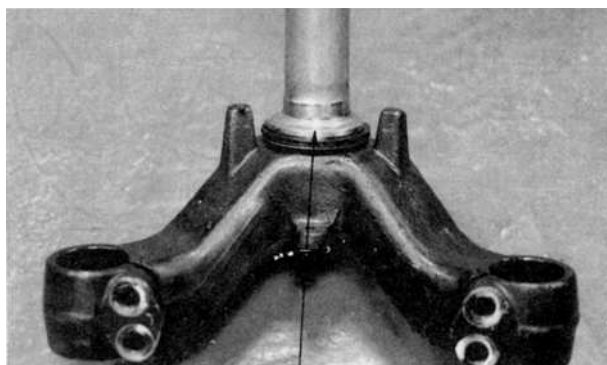

Bottom Cone Race

Ball Race Remover

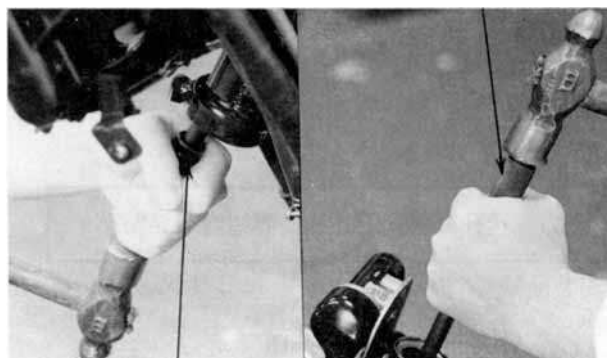

Ball Race Remover

# 13. STEERING HANDLEBAR/FRONT WHEEL/FRONT BRAKE/FRONT SHOCK ABSORBER/FRONT FORK

Drive in new ball races.

- \* Be sure to drive the ball races into place completely.

## INSTALLATION

Apply grease to the top and bottom ball races and install 26 steel balls on the top ball race and 19 steel balls on the bottom ball race. Then, install the front fork.

Apply grease to the top cone race and install it.

Tighten the top cone race and then turn the steering stem right and left several times to make steel balls contact each other closely.

- \* Check that the steering stem rotates freely without vertical play.

Install the steering stem lock nut and tighten it while holding the top cone race.

**Torque:** 8.0~12.0kg-m

Install the front wheel. (⇒13-7)

Install the front brake caliper. (⇒13-12)

Install the front inner fender. (⇒2-6)

Install the throttle grip and the right and left handlebar switches. (⇒13-5)

Install the right and left brake master cylinders. (⇒13-5)

Outer Driver, 37x40mm

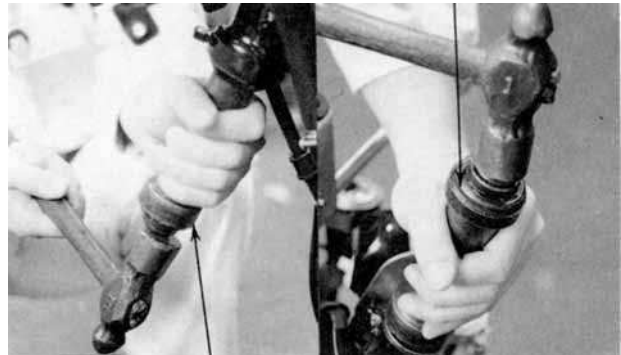

Outer Driver, 37x40mm

Top Cone Race



Ball Race



Lock Nut Wrench

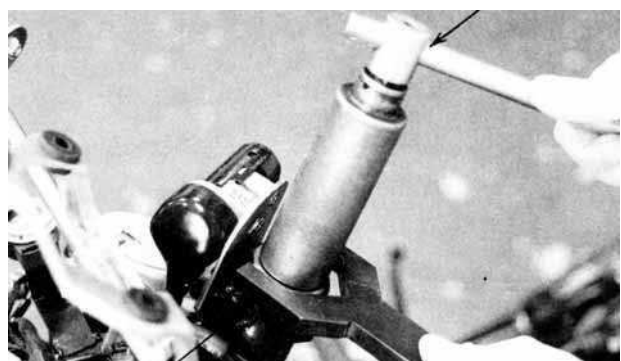

Lock Nut Wrench

# 14. REAR WHEEL/REAR BRAKE/REAR SHOCK ABSORBER

---

---

## REAR WHEEL/REAR BRAKE/REAR SHOCK ABSORBER

---

SERVICE INFORMATION .....	14-2
TROUBLESHOOTING .....	14-2
REAR WHEEL.....	14-3
REAR BRAKE .....	14-4
REAR SHOCK ABSORBER.....	14-7

# 14. REAR WHEEL/REAR BRAKE/REAR SHOCK ABSORBER

---

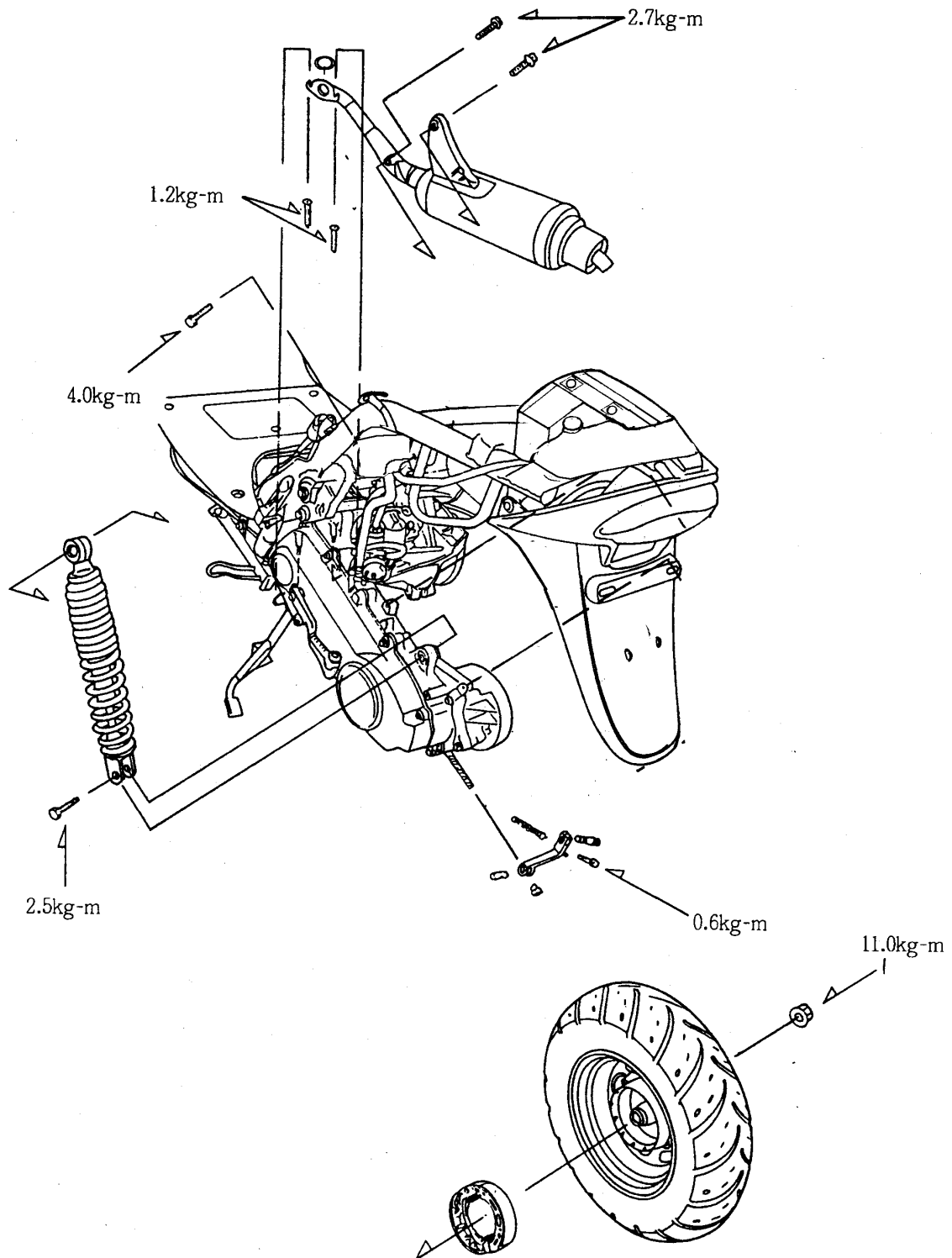

# 14. REAR WHEEL/REAR BRAKE/REAR SHOCK ABSORBER

---

## SERVICE INFORMATION

### SPECIFICATIONS

Item	Standard (mm)	Service Limit (mm)
Rear wheel rim runout		2.0
Rear brake drum I.D.	110	111
Rear brake lining thickness	4.0	2.0
Rear shock absorber spring free length	235.7	218.7

### TORQUE VALUES

Rear axle nut	11.0~13.0kg-m
Rear shock absorber upper mount bolt	3.5~4.5kg-m
Rear shock absorber lower mount bolt	2.4~3.0kg-m
Rear shock absorber lower joint nut	3.5~4.5kg-m (apply locking agent)

### SPECIAL TOOL

Rear shock absorber remover  
Rear shock absorber compressor

### TROUBLESHOOTING

#### Rear wheel wobbling

- Bent rim
- Faulty tire
- Axle not tightened properly

#### Soft rear shock absorber

- Weak shock absorber spring

#### Poor brake performance

- Brake not adjusted properly
- Contaminated brake linings
- Worn brake linings
- Worn brake shoes at cam contacting area
- Worn brake cam
- Improper engagement between brake arm and wear indicator plate

# 14. REAR WHEEL/REAR BRAKE/REAR SHOCK ABSORBER

---

## REAR WHEEL

### REMOVAL

Remove the two exhaust muffler joint lock nuts.  
Remove the two exhaust muffler lock bolts.  
Remove the exhaust muffler.  
Remove the rear axle nut to remove the rear wheel.

Rear Axle Nut



### INSPECTION

Measure the rear wheel rim runout.

#### Service Limits:

Radial : 2.0mm replace if over

Axial : 2.0mm replace if over

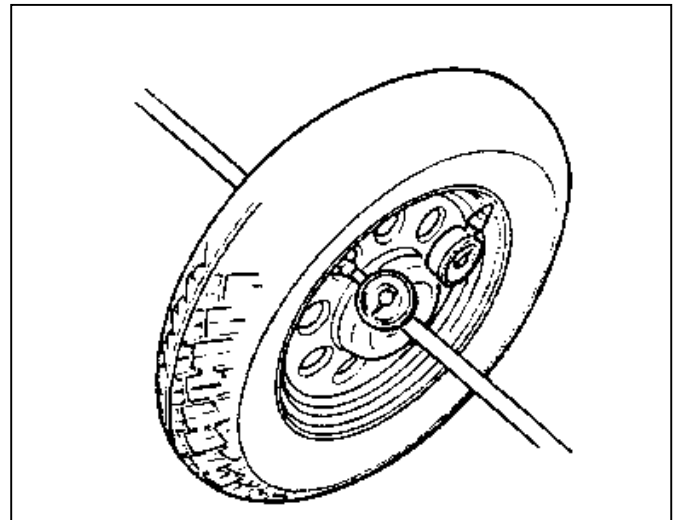

### INSTALLATION

Install the rear wheel and apply SAE30# engine oil to the axle threads. Then, tighten the rear axle nut.

#### Torque values:

Rear axle nut: 11.0~13.0kg-m

Rear Axle Nut



# 14. REAR WHEEL/REAR BRAKE/REAR SHOCK ABSORBER

---

## REAR BRAKE

Remove the rear wheel. (⇒14-3)  
Inspect the rear brake drum.  
Measure the rear brake drum I.D.  
**Service Limit:** 95.5mm replace if over

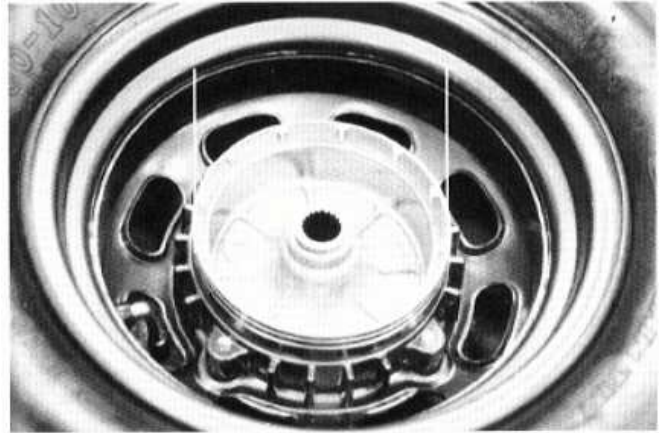

## BRAKE LINING INSPECTION

Measure the brake lining thickness.  
**Service Limit:** 2.0mm replace if below

\* Keep oil or grease off the brake linings.

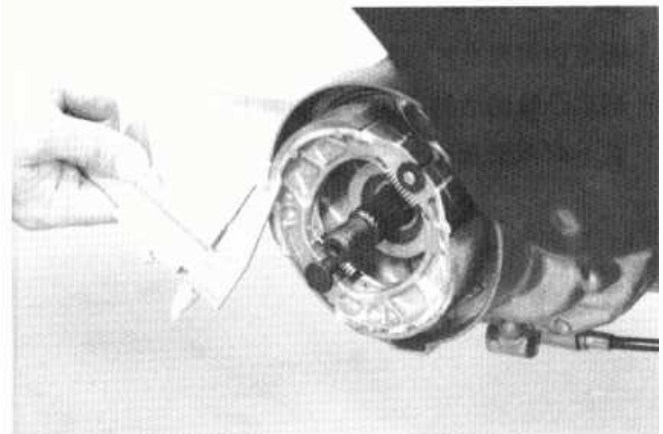

## REAR BRAKE DISASSEMBLY

Remove the rear brake adjusting nut and disconnect the rear brake cable.  
Remove the rear brake shoes.

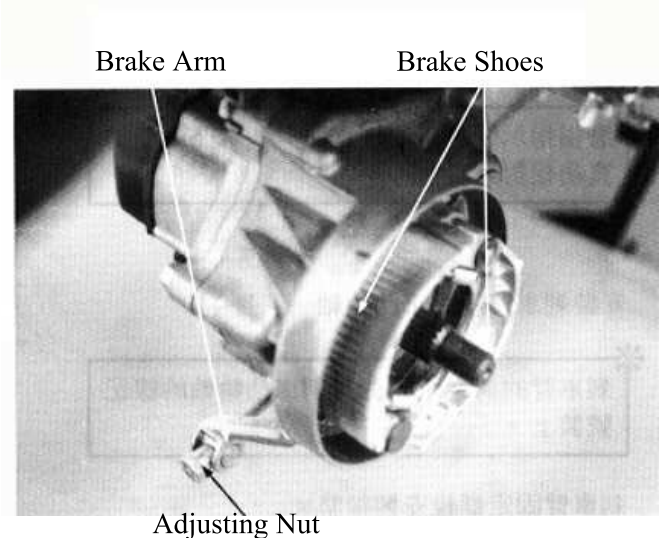



# 14. REAR WHEEL/REAR BRAKE/REAR SHOCK ABSORBER

Remove the brake arm bolt to remove the brake arm, wear indicator plate and felt seal.  
Remove the brake cam.

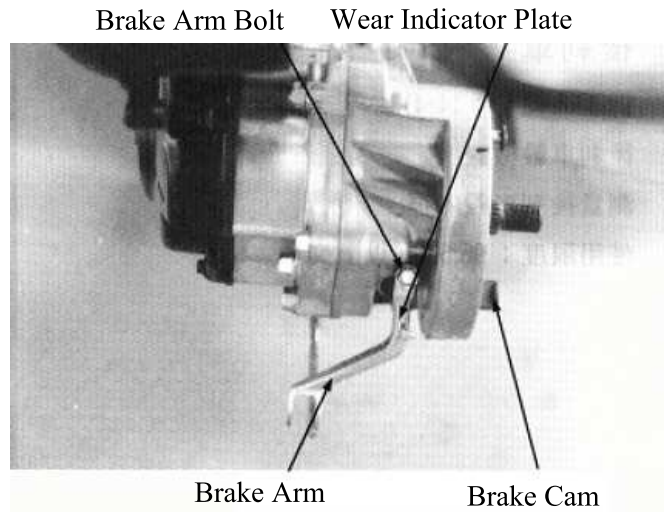

## REAR BRAKE ASSEMBLY

Apply grease to the anchor pin and brake shoe moving parts.  
Apply grease to the brake cam and install it.

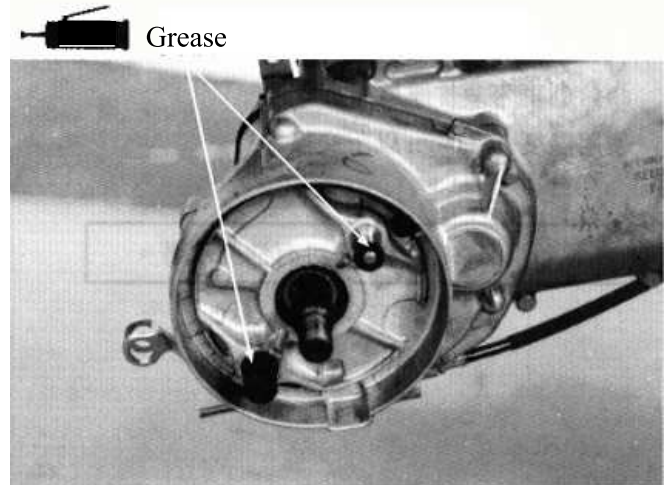

Apply engine oil to the felt seal and install it to the brake cam.  
Install the wear indicator plate.

\* Align the wide tooth of the wear indicator plate with the wide groove on the brake cam.

Install the brake arm onto the brake cam.

\* Align the punch mark on the brake arm with the scribed line on the brake cam.

Install and tighten the brake arm bolt.  
Install the brake arm return spring.  
Install the brake shoes.

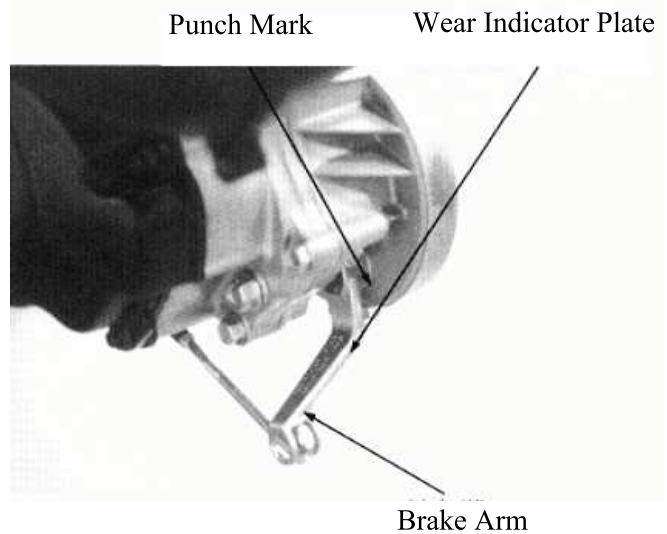

## 14. REAR WHEEL/REAR BRAKE/REAR SHOCK ABSORBER

---

Install the brake arm pin.  
Connect the brake cable and install the adjusting nut.  
Install the rear wheel.  
Adjust the rear brake lever free play.  
(⇒3-4)

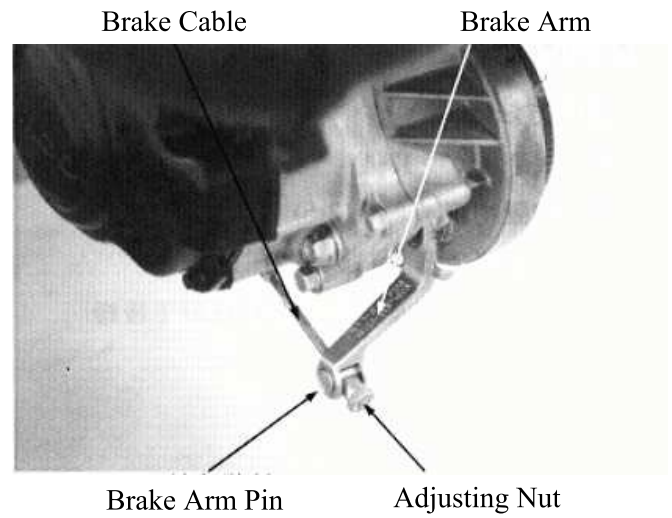

# 14. REAR WHEEL/REAR BRAKE/REAR SHOCK ABSORBER

---

## REAR SHOCK ABSORBER

### REMOVAL

Remove the rear carrier. (⇒2-3)  
Remove the met-in box. (⇒2-3)  
Remove the air cleaner case. (⇒5-2)  
Remove the rear shock absorber upper and lower mount bolts to remove the rear shock absorber.

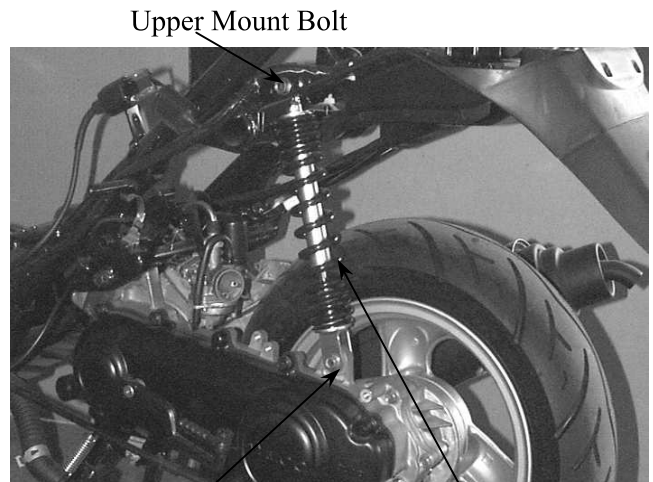

Upper Mount Bolt      Lower Mount Bolt      Rear Shock Absorber

### DISASSEMBLY

Install the rear shock absorber compressor as the figure shown.

\* Install the rear shock absorber lower joint into the rear shock absorber compressor.

Compress the rear shock absorber spring.

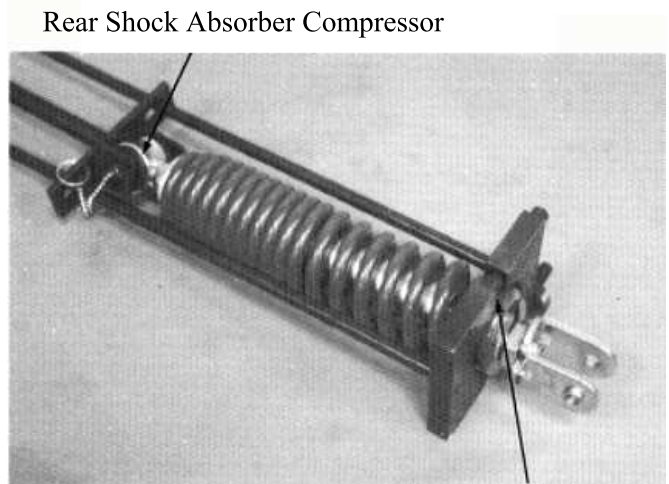

Rear Shock Absorber Compressor

Loosen the lower joint lock nut.  
Remove the lower joint.  
Remove the lock nut, rubber and damper.

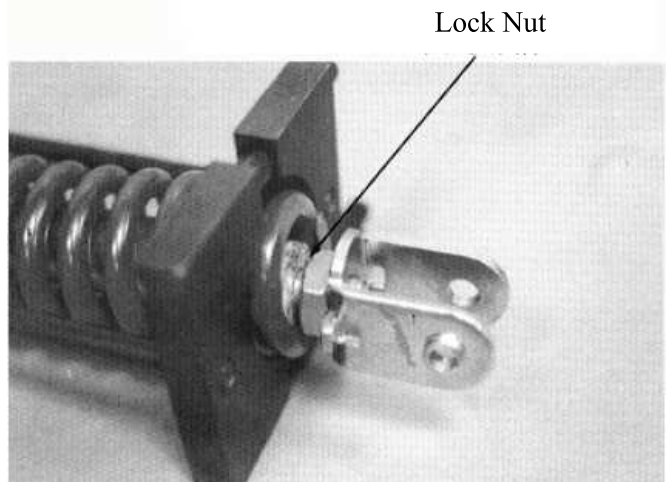

Lock Nut

# 14. REAR WHEEL/REAR BRAKE/REAR SHOCK ABSORBER

## INSPECTION

Inspect the damper rod for bending or damage.  
Inspect the damper for oil leaks.  
Inspect the damper rubber for deterioration or damage.

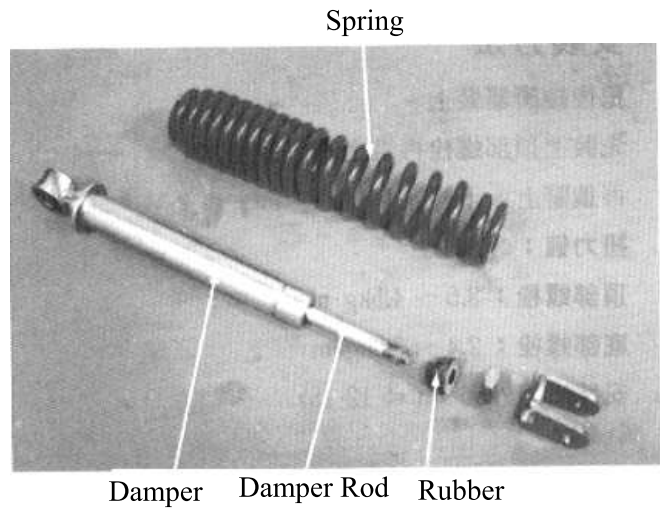

Measure the rear shock absorber spring free length.

**Service Limit:** 232mm replace if below

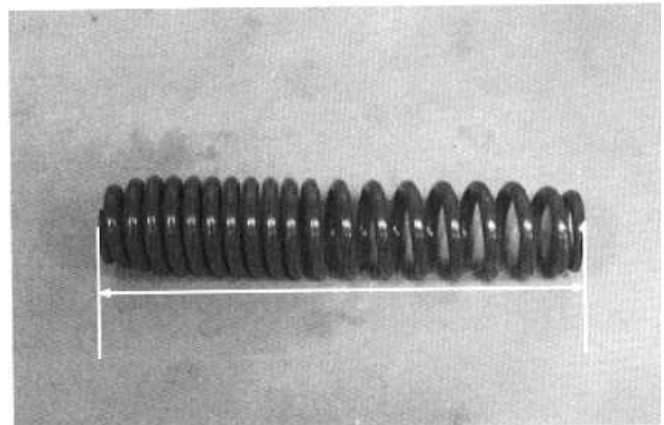

## ASSEMBLY

Assemble the rear shock absorber in the reverse order of disassembly.

- \* Install the shock absorber spring with loosely wound coils facing down.
- \* Apply locking agent to the lock nut thread and then install and tighten the lock nut.

Tighten the lock nut.

**Torque:** 3.5~4.5kg-m

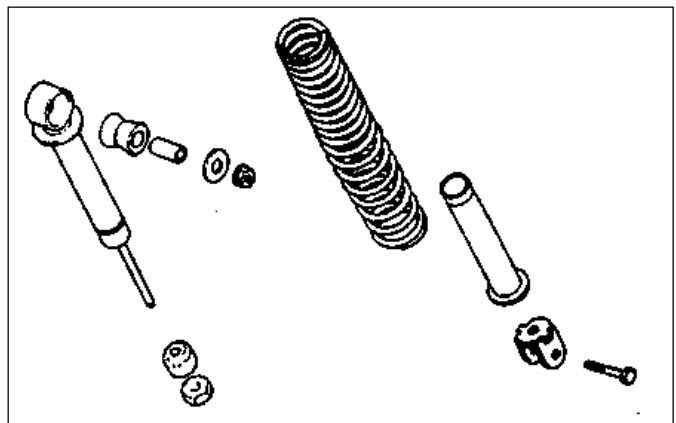

## 14. REAR WHEEL/REAR BRAKE/REAR SHOCK ABSORBER

---

### INSTALLATION

Install the rear shock absorber.  
Install the rear shock absorber upper mount bolt and then install the lower mount bolt.

#### Torque:

**Upper Mount Bolt:** 3.5~4.5kg-m

**Lower Mount Bolt:** 2.4~3.0kg-m

Install the frame body cover. (⇒2-4)

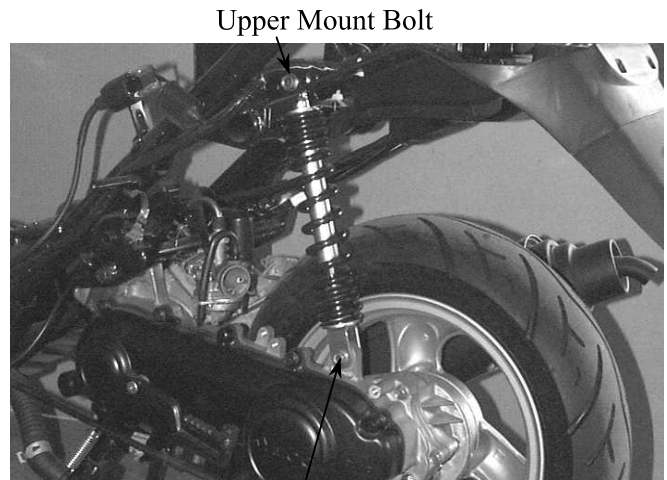

Lower Mount Bolt

---

## FUEL TANK

---

SCHEMATIC DRAWING .....	15-1
SERVICE INFORMATION.....	15-2
TROUBLESHOOTING.....	15-2
FUEL TANK REMOVAL.....	15-3
FUEL STRAINER INSPECTION.....	15-3

# 15. FUEL TANK

---

## SCHEMATIC DRAWING

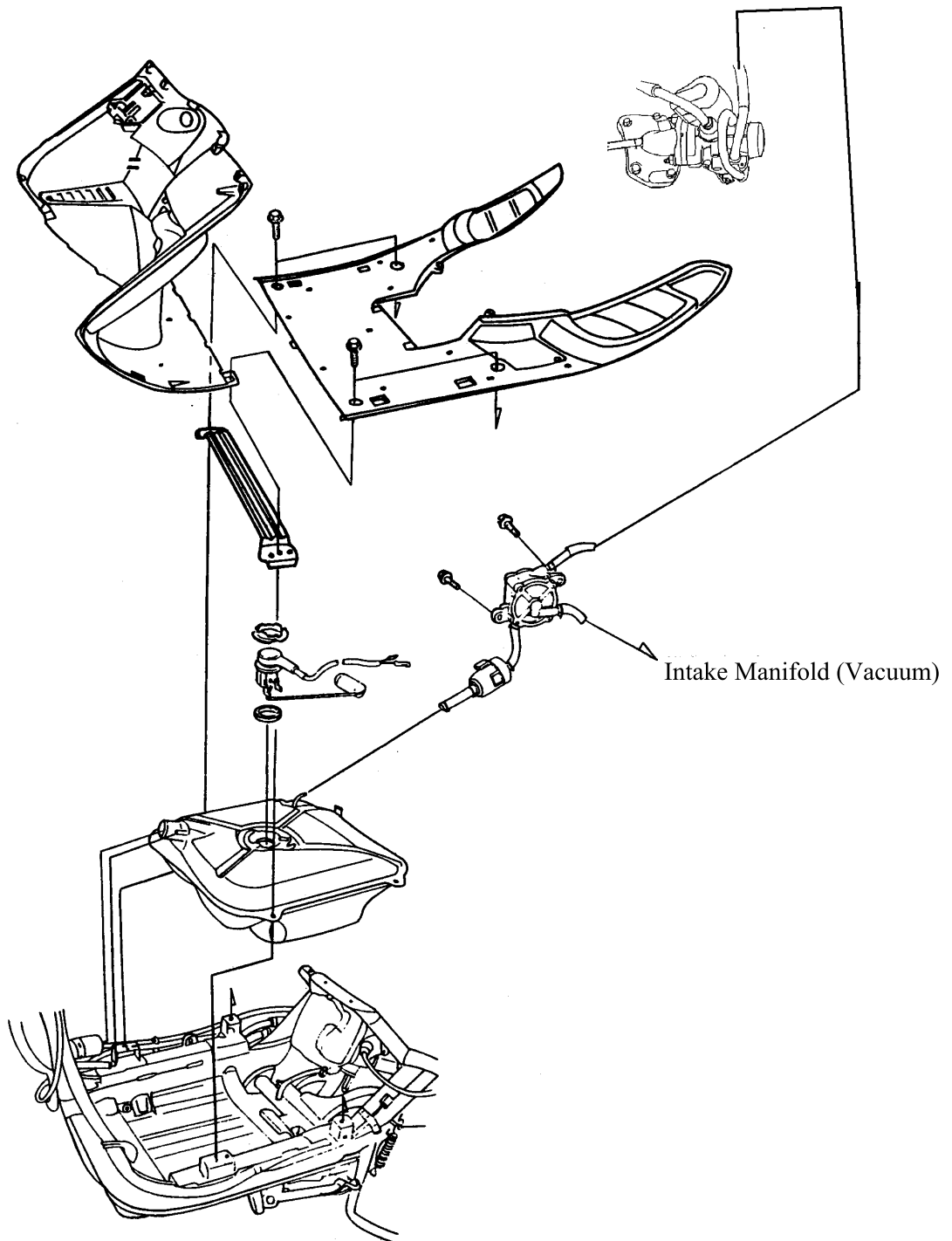

# 15. FUEL TANK

---

## SERVICE INFORMATION

### GENERAL INSTRUCTIONS

- When removing the fuel tank, keep sparks and flames away from the working area.
- When removing the fuel tank, the remaining fuel in the tank must be lower than  $\frac{1}{2}$  of the fuel tank capacity to avoid gasoline overflowing.
- Fuel tank capacity: 10 liters

## TROUBLESHOOTING

### Engine is hard to start

- No fuel in tank
- Restricted fuel line
- Clogged fuel strainer
- Faulty fuel pump
- Broken or clogged vacuum tube
- Faulty or clogged charcoal canister

### Lean mixture

- Clogged charcoal canister
- Bent, kinked or restricted fuel line
- Clogged fuel strainer
- Float level too low



# 15. FUEL TANK

---

## FUEL TANK REMOVAL

Remove the floor board. (⇒2-4)  
Remove the leg shield . (⇒2-5)  
Disconnect the fuel unit wire connector.  
Remove the fuel tube between the fuel tank and the fuel filler.  
Disconnect the fuel vapor tube.  
Remove the fuel tank.

The installation sequence is the reverse of removal.

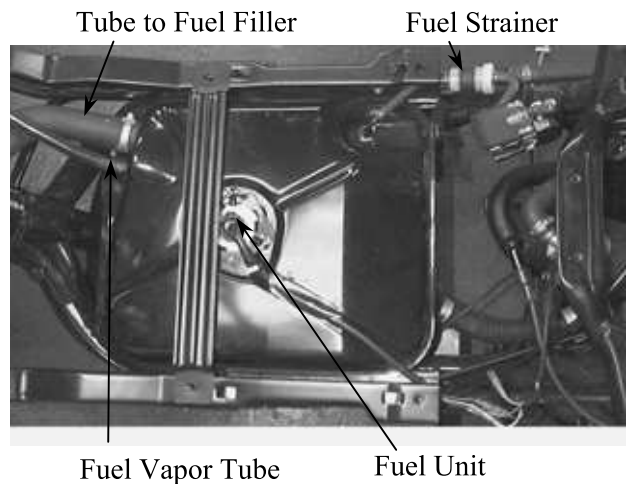

## FUEL STRAINER REMOVAL

Remove the fuel strainer from the fuel tank.

### INSPECTION

Inspect if the fuel strainer is clogged and clean it with compressed air.

- When removing the fuel strainer, do not allow flames or sparks near the working area and drain the residual gasoline into a container.



## INSTALLATION

Install the fuel strainer with its arrow mark toward the fuel pump.

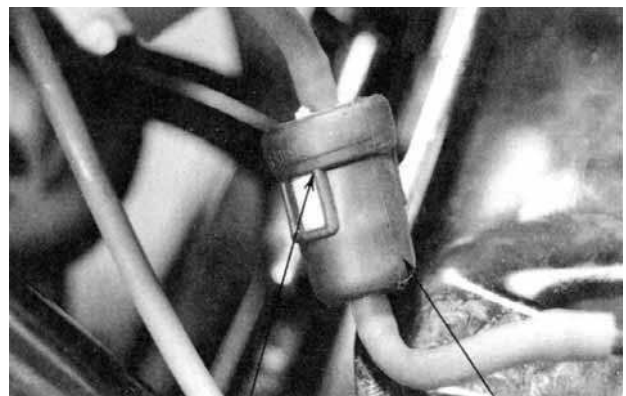

Arrow Mark

Fuel Strainer

# 16. BATTERY/CHARGING SYSTEM

---

**16**

---

## BATTERY/CHARGING SYSTEM

---

CHARGING SYSTEM LAYOUT -----	16-1
SERVICE INFORMATION-----	16-2
TROUBLESHOOTING-----	16-3
BATTERY -----	16-4
CHARGING SYSTEM -----	16-5
A.C. GENERATOR INSPECTION -----	16-5
REGULATOR/RECTIFIER INSPECTION-----	16-6

# 16. BATTERY/CHARGING SYSTEM

## CHARGING SYSTEM LAYOUT

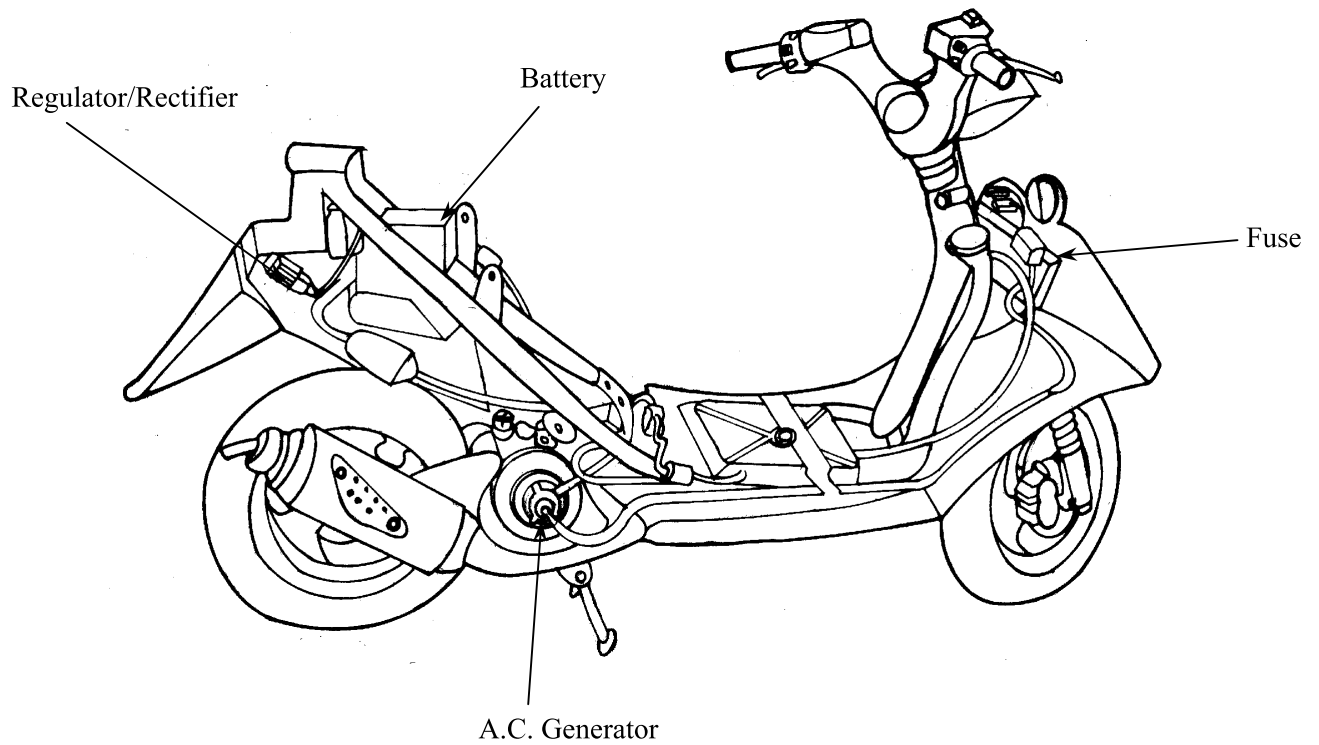

## CHARGING CIRCUIT

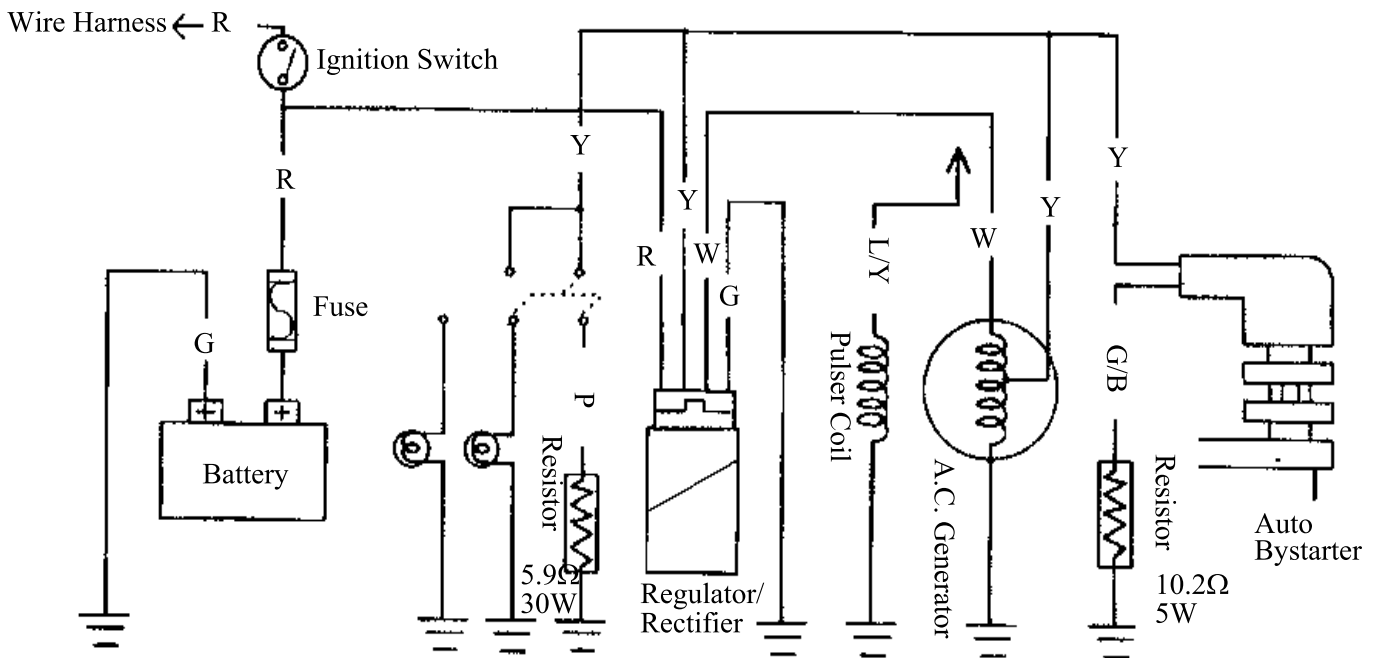

# 16. BATTERY/CHARGING SYSTEM

## SERVICE INFORMATION

### GENERAL INSTRUCTIONS



The battery electrolyte (sulfuric acid) is poisonous and may seriously damage the skin and eyes. Avoid contact with skin, eyes, or clothing. In case of contact, flush with water and get prompt medical attention

- The battery can be charged and discharged repeatedly. If a discharged battery is not used for a long time, its service life will be shortened. Generally, the capacity of a battery will decrease after it is used for 2~3 years. A capacity-decreased battery will resume its voltage after it is recharged but its voltage decreases suddenly and then increases when a load is added.
- When a battery is overcharged, some symptoms can be found. If there is a short circuit inside the battery, no voltage is produced on the battery terminals. If the rectifier won't operate, the voltage will become too high and shorten the battery service life.
- If a battery is not used for a long time, it will discharge by itself and should be recharged every 3 months.
- A new battery filled with electrolyte will generate voltage within a certain time and it should be recharged when the capacity is insufficient. Recharging a new battery will prolong its service life.
- Inspect the charging system according to the sequence specified in the Troubleshooting.
- Do not disconnect and soon reconnect the power of any electrical equipment because the electronic parts in the regulator/rectifier will be damaged. Turn off the ignition switch before operation.
- It is not necessary to check the MF battery electrolyte or fill with distilled water.
- Check the load of the whole charging system.
- Do not quick charge the battery. Quick charging should only be done in an emergency.
- Remove the battery from the motorcycle for charging.
- When replacing the battery, do not use a traditional battery.
- When charging, check the voltage with an electric tester.

### SPECIFICATIONS

Item		Standard	
Battery	Capacity	12V4AH	
	Voltage (20°C)	Fully charged	13.2V
		Undercharged	12.3V
	Charging current	STD: 0.5A Quick: 5.0A	
	Charging time	STD: 5-10hr Quick: 30min	
A.C. Generator	Capacity	160W/500rpm	
	Charging coil resistance (20°C)	Yellow~Yellow   0.6~1.6Ω	
	Charging rpm	1300rpm max (14V)	
	Charging performance	1.3A min/2500rpm 2.0A min/6000rpm	
Regulator/Rectifier	Limit voltage	14.5±0.5V	

### TESTING INSTRUMENTS

Ammeter  
Electric tester  
Tachometer

### TORQUE VALUES

Pulser coil bolt 0.5kg-m  
Coil lock bolt 0.9kg-m  
Flywheel nut 3.5~4.5kg-m

# 16. BATTERY/CHARGING SYSTEM

---

## SPECIAL TOOLS

Universal holder  
Flywheel puller

## TROUBLESHOOTING

### No power

- Dead battery
- Disconnected battery cable
- Fuse burned out
- Faulty ignition switch

### Low power

- Weak battery
- Loose battery connection
- Charging system failure
- Faulty regulator/rectifier

### Intermittent power

- Loose battery cable connection
- Loose charging system connection
- Loose connection or short circuit in ignition system

### Charging system failure

- Loose, broken or shorted wire or connector
- Faulty regulator/rectifier
- Faulty A.C. generator

# 16. BATTERY/CHARGING SYSTEM

## BATTERY

Remove the seat and met-in box. (⇒2-3)  
Remove the battery.  
First disconnect the battery negative (-) cable  
and then the positive (+) cable.

✎ When disconnecting the battery positive (+) cable, do not touch the frame with tool; otherwise it will cause short circuit and sparks to fire the fuel.

The installation sequence is the reverse of removal.

✎ First connect the positive (+) cable and then negative (-) cable to avoid short circuit.

## BATTERY VOLTAGE INSPECTION (OPEN CIRCUIT VOLTAGE)

Disconnect the battery cables.  
Measure the voltage between the battery terminals.

Fully charged : 13.2V

Undercharged : 12.3V max.

\* Battery charging inspection must be performed with a voltmeter.

## CHARGING

Connect the charger positive (+) cable to the battery positive (+) terminal.  
Connect the charger negative (-) cable to the battery negative (-) terminal.

✎ Keep flames and sparks away from a charging battery.

- Turn power ON/OFF at the charger, not at the battery terminals to prevent sparks near the battery.
- Charge the battery according to the current specified on the battery.
- During quick charging, the battery temperature should not exceed 45°C.

\*

- Quick charging should only be done in an emergency.
- Measure the voltage 30 minutes after the battery is charged.

Charging current: Standard : 0.5A  
Quick : 5A

Charging time : Standard : 5~10 hours  
Quick : 30 minutes

After charging: Open circuit voltage: 12.8V min.

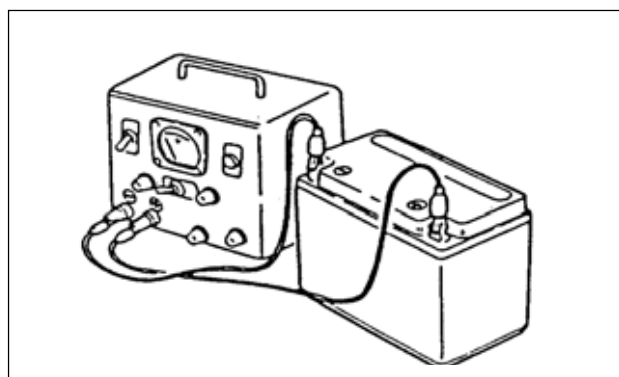
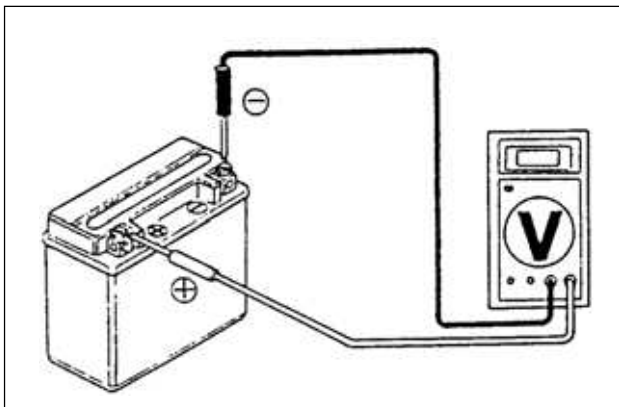
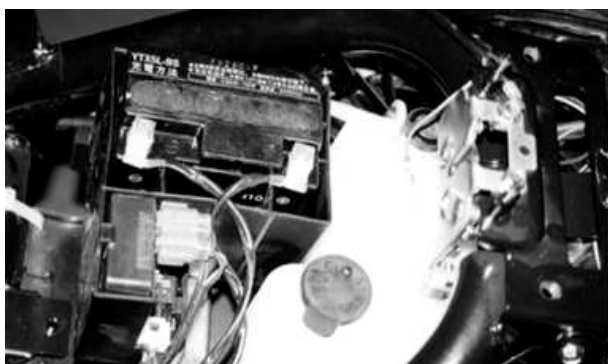

# 16. BATTERY/CHARGING SYSTEM

## CHARGING SYSTEM

### CURRENT TEST

- \* Use a fully charged battery (12.8V min.) to check the charging system.

Warm up the engine before taking readings. Connect an electric tester across the battery terminals.

Disconnect the red wire from the fuse terminal and connect an ammeter between the red wire lead and the fuse terminal. Attach a tachometer to the engine.

Start the engine and gradually increase the engine speed to measure the limit voltage and current.

**Limit Voltage/Current:** 14~15V/0.5A max. (5000rpm max.)

If the limit voltage is not within the specified range, check the regulator/rectifier.

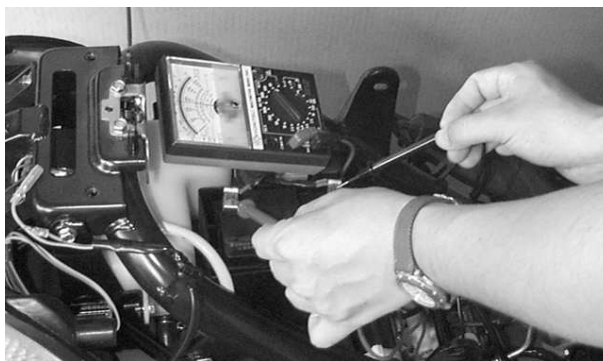
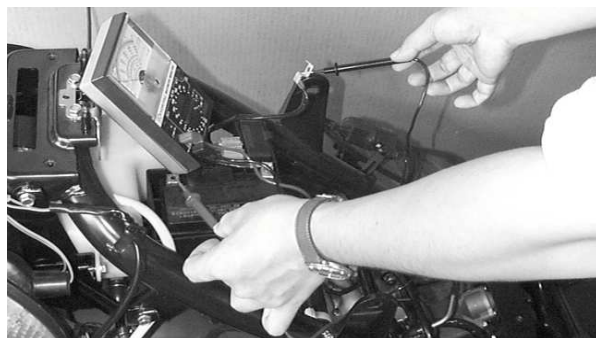

### PERFORMANCE TEST

Engine Speed	2500rpm	6000rpm
Charging Current	1.3A min.	2.0A min.

- \* When measuring the charging current, disconnect the wire from the regulator/rectifier wire coupler.

If the readings do not meet the specified values, check the regulator/rectifier.

### A.C. GENERATOR INSPECTION

- \* Inspect with the engine installed.

Remove the met-in box. (⇒2-4)  
Disconnect the A.C. generator connector.  
Measure the resistances between the charging coil terminals (white-blue/yellow) and lighting coil terminals (yellow-green).

**Resistances:**

Charging coil	white-green	0.2~1.2Ω
Lighting coil	yellow-green	0.3~1.0Ω

A.C. Generator Connector





# 16. BATTERY/CHARGING SYSTEM

## RESISTOR INSPECTION

Remove the frame front cover. (⇒2-3)  
 Measure the resistance between the resistor B pink wire and ground.  
 Measure the resistance between the resistor A green/black wire and ground.

### Resistances:

- Resistor A: 9.9~10.5Ω
- Resistor B: 5.6~6.2Ω

\* Faulty resistor is the cause of faulty operation of the auto bystarter.

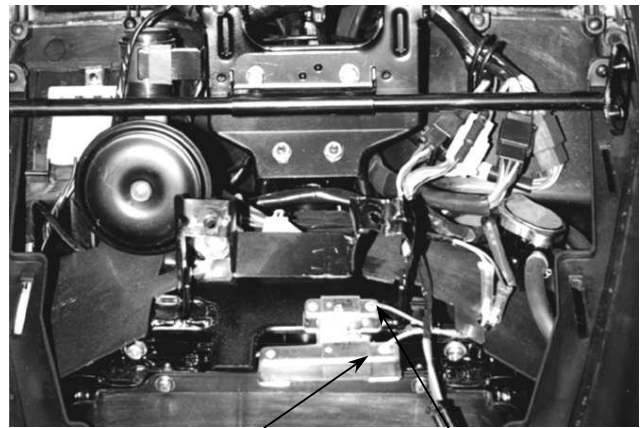

Resistor A

Resistor B

## REGULATOR/RECTIFIER INSPECTION

Remove the frame body cover. (⇒2-3)  
 Disconnect the regulator/rectifier wire coupler and remove the bolt to remove the regulator/rectifier.

Measure the resistances between the terminals.  
 Replace the regulator/rectifier if the readings are not within the specifications in the table below.

\* Due to the semiconductor in circuit, it is necessary to use a specified tester for accurate testing. Use of an improper tester in an improper range may give false readings.  
 • Use a Sanwa Electric Tester (07208-0020000) or Kowa Electric Tester (TH-5H). The proper range for testing is listed below.

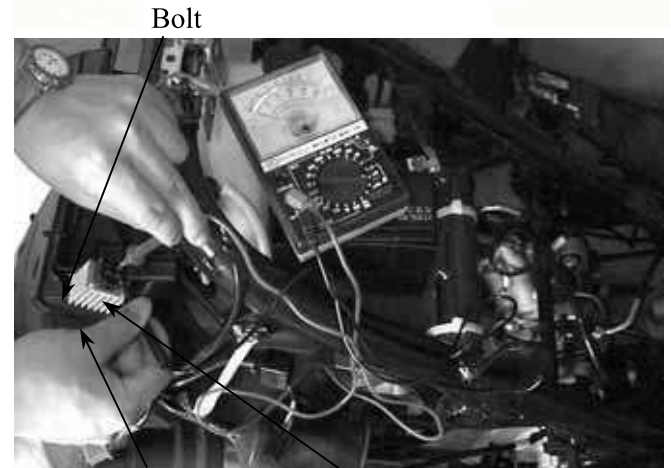

Bolt

Coupler

Regulator/Rectifier

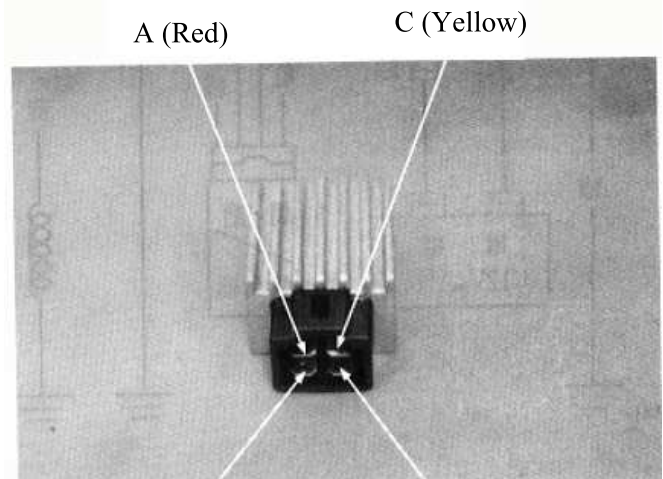

A (Red)

C (Yellow)

B (White)

D (Green)

Model	Brand	Range
SP-10D	Sanwa	KΩ
TH-5H	Kowa	100Ω

Probe⊕ Probe(-)	A (R)	B (W)	C (Y)	D (G)
A (R)		∞	∞	∞
B (W)	3-10KΩ		∞	∞
C (Y)	∞	∞		33-35KΩ
D (G)	∞	∞	33-35KΩ	



# 17. IGNITION SYSTEM

---

---

## IGNITION SYSTEM

---

IGNITION SYSTEM LAYOUT -----	17-1
SERVICE INFORMATION-----	17-2
TROUBLESHOOTING-----	17-2
SPARK PLUG-----	17-3
IGNITION COIL INSPECTION -----	17-3
A.C. GENERATOR INSPECTION -----	17-4
CDI UNIT INSPECTION-----	17-4

# 17. IGNITION SYSTEM

## IGNITION SYSTEM LAYOUT

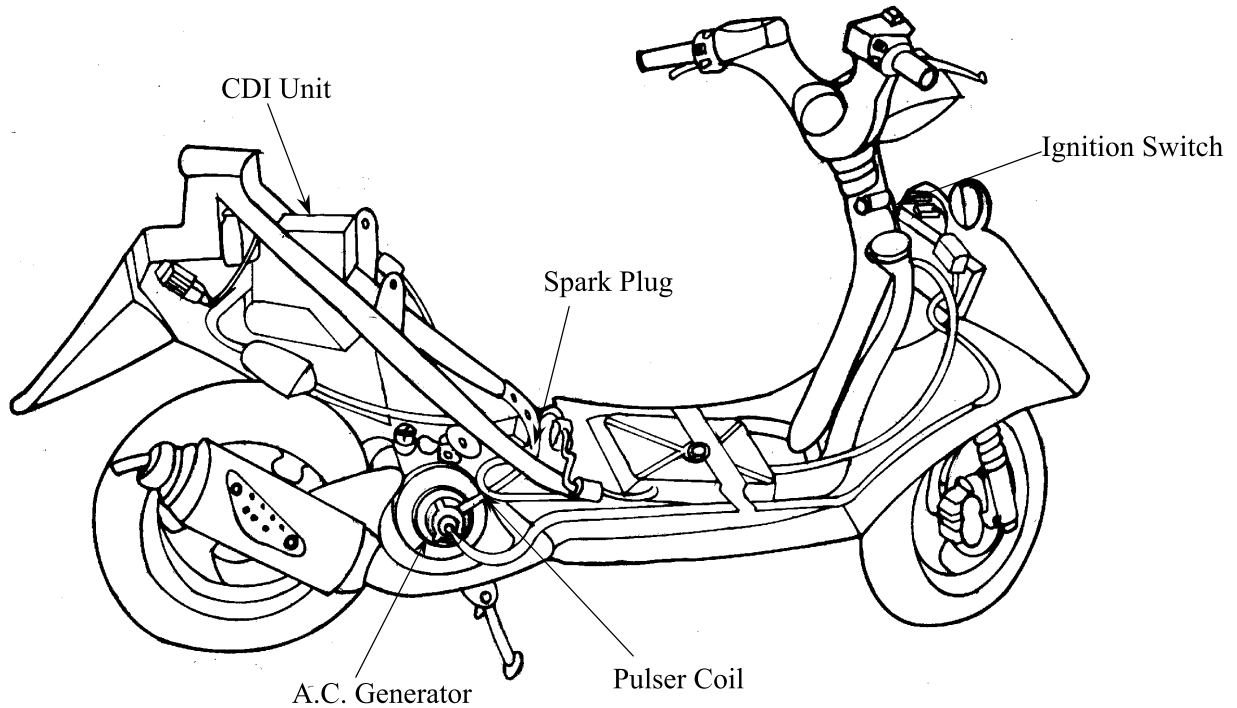

## IGNITION CIRCUIT

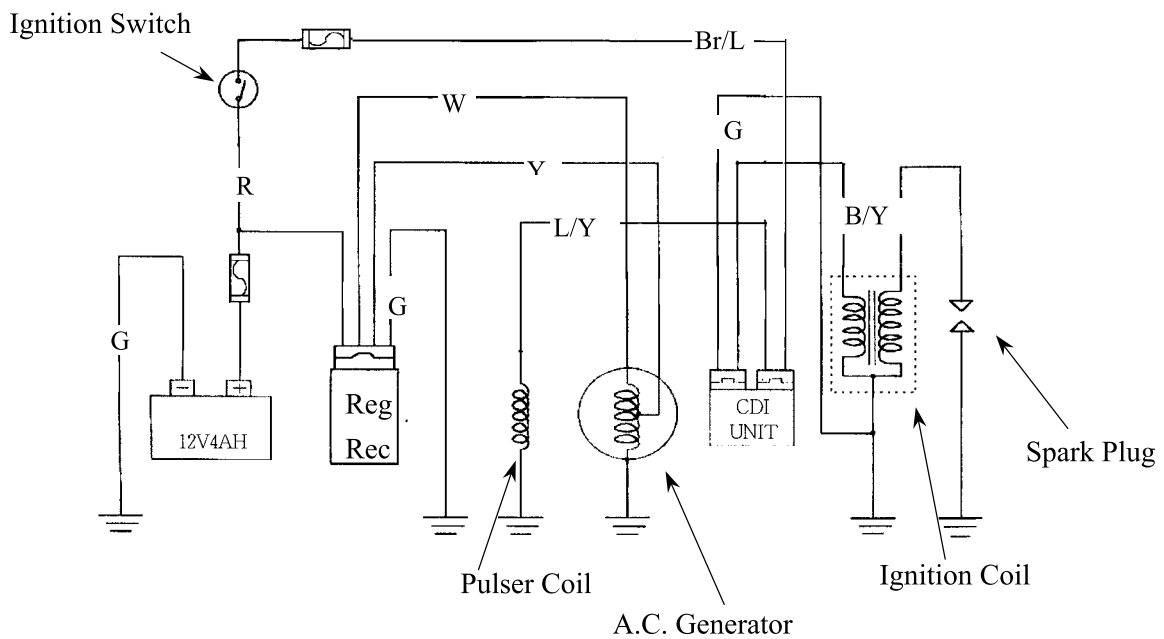

# 17. IGNITION SYSTEM

## SERVICE INFORMATION

### GENERAL INSTRUCTIONS

- Check the ignition system according to the sequence specified in the Troubleshooting. (⇒1-28)
- The ignition system adopts CDI unit and the ignition timing cannot be adjusted.
- If the timing is incorrect, inspect the CDI unit and A.C. generator and replace any faulty parts.  
Inspect the CDI unit with a CDI tester
- Loose connector and poor wire connection are the main causes of faulty ignition system. Check each connector before operation.
- Use of spark plug with improper heat range is the main cause of poor engine performance.
- The inspections in this section are focused on maximum voltage. The inspection of ignition coil resistance is also described in this section.
- Inspect the ignition switch according to the continuity table specified in page 20-3.
- Inspect the spark plug referring to Section 3.
- Remove the A.C. generator and pulser coil referring to Section 10.

### SPECIFICATIONS

Item		Standard	
Spark plug	SH10BA	BR8HSA	
	SH10AA	BR6HSA	
Spark plug gap		0.8~1.0mm	
Ignition timing		13.5°±2° BTC/2000rpm	
Ignition coil resistance (20°C)	Primary coil	0.153~0.187Ω	
	Secondary coil	without plug cap	3.24~3.96KΩ
		with plug cap	6.99~10.21KΩ
Pulser coil resistance (20°C)		50~170Ω	
Exciter coil resistance (20°C)		50~350Ω	
Ignition coil primary side max. voltage		244V	
Pulser coil max. voltage		10.5V	
Exciter coil max. voltage		244V	

### TESTING INSTRUMENT

Electric tester

### TROUBLESHOOTING

#### No spark at plug

- Faulty spark plug
- Poorly connected, broken or shorted wire
- Faulty ignition switch
- Faulty ignition coil
- Faulty CDI unit
- Faulty A.C. generator

#### Engine starts but turns poorly

- Ignition primary circuit
  - Faulty ignition coil
  - Poorly connected wire or connector
  - Poorly contacted ignition switch
- Ignition secondary circuit
  - Faulty ignition coil
  - Faulty spark plug
  - Faulty high-tension wire
  - Poorly insulated plug cap
- Improper ignition timing
  - Faulty A.C. generator
  - Stator not installed properly
  - Faulty CDI unit

# 17. IGNITION SYSTEM

## SPARK PLUG

For spark plug inspection and adjustment, refer to page (3-5).

## IGNITION COIL INSPECTION

Remove the seat and met-in box. (⇒2-3)  
Remove the ignition coil



Ignition Coil

## IGNITION COIL PERFORMANCE TEST

Test the ignition coil using a CDI tester.

- \* Correctly operate the CDI tester following the manufacturer's instructions.

When there is no spark at the spark plug, replace the ignition coil with a new one.

Spark Plug    CDI Tester    Special Coupler (KB7)

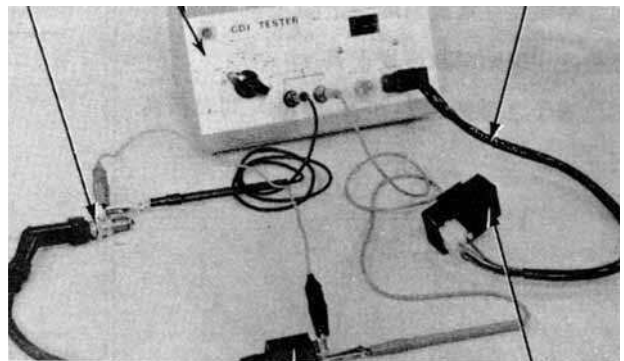

Ignition Coil

CDI Unit

Ignition Coil

Primary Coil

## IGNITION COIL CONTINUITY TEST

Inspect the continuity of the ignition coil, primary coil and secondary coil.

- \* This is a general test. Accurate ignition coil test must be performed with a CDI tester.

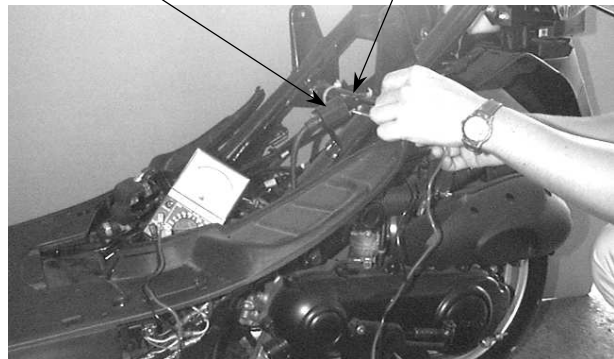

Measure the ignition coil resistances at 20°C.

Primary coil	0.153~0.187Ω
Secondary coil without plug cap	3.24~3.96KΩ
Secondary coil with plug cap	6.99~10.21KΩ

Ignition Coil

Secondary Coil

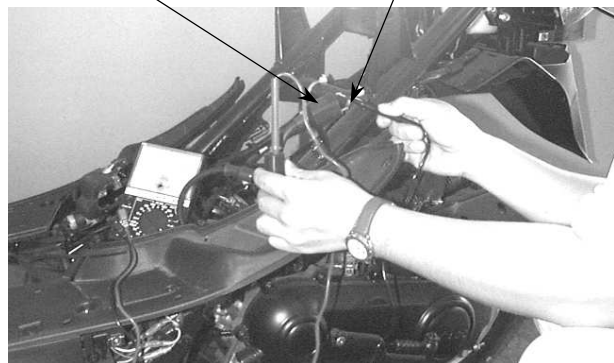

# 17. IGNITION SYSTEM

## A.C. GENERATOR INSPECTION

For A.C. generator removal/installation, refer to pages 9-3 and 9-5.

Disconnect the pulser coil wire coupler.  
Measure the pulser coil resistance between the blue/yellow wire and ground.



A.C. Generator Connector

**Resistance (20°C):** 80~160Ω

\* Measure the resistance in the XΩ range.

For pulser coil replacement, refer to pages 9-3 and 9-5.

Pulser Coil Wire Coupler

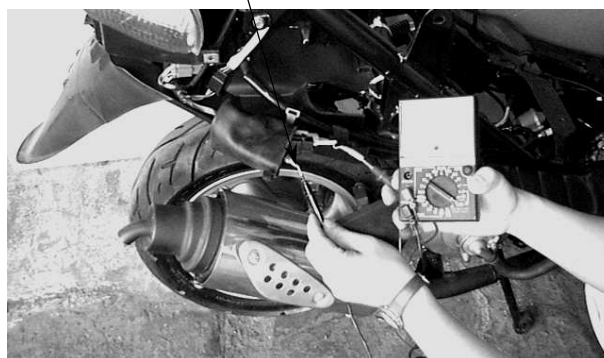

## CDI UNIT INSPECTION

Remove the met-in box. (⇒2-3)  
Disconnect the CDI coupler and remove the CDI unit.  
Inspect the CDI unit performance using the CDI tester.

\* Correctly operate the CDI tester following the manufacturer's instructions.

Connect the CDI unit to the CDI tester special coupler (KB7). Adjust the CDI tester switch range.

CDI Tester

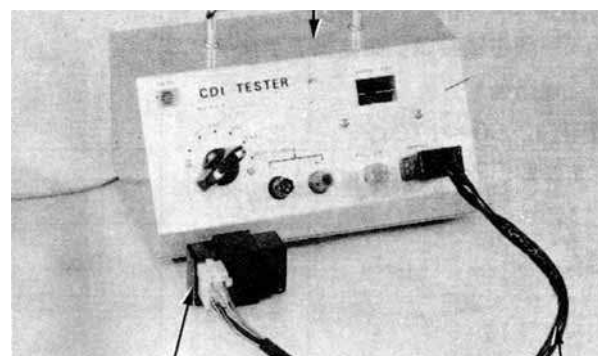

CDI Unit

CDI Tester Special Coupler

Switch	Good CDI	Faulty CDI
1. OFF	No spark	—
2. P	↑	—
3. EXT	↑	Good spark
4. ON1	Good spark	No spark
5. ON2	Good spark	No spark

# 17. IGNITION SYSTEM

## RESISTANCE INSPECTION

Measure the resistance between the terminals. Replace the CDI unit if the readings are not within the specifications in the table below.

- \*
- Due to the semiconductor in circuit, it is necessary to use a specified tester for accurate testing. Use of an improper tester in an improper range may give false readings.
  - Use a Sanwa Electric Tester (07308-0020000) or Kowa Electric Tester (TH-5H).
  - In this table, “Needle swings then returns” indicates that there is a charging current applied to a condenser. The needle will then remain at “∞” unless the condenser is discharged.

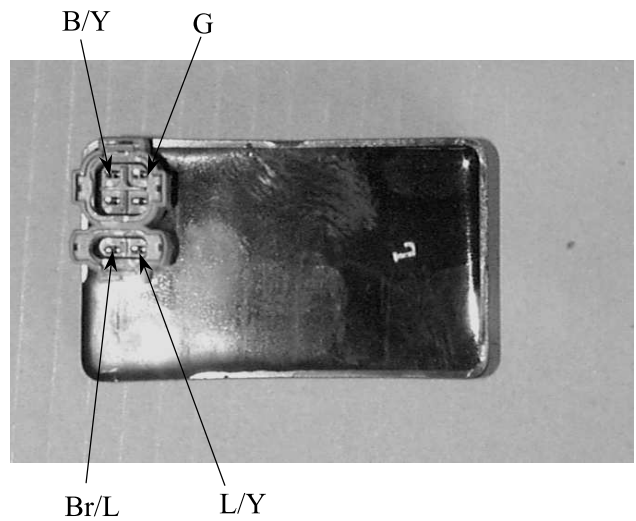

Use the x KΩ range for the Sanwa Tester.  
Use the x 100Ω range for the Kowa Tester.

Unit: KΩ

Probe⊕ (-)Probe	Blue / Yellow	Brown/ Blue	Green	Black/ Yellow
Blue / Yellow		∞	1~100	∞
Brown/ Blue	100~∞		1~100	∞
Green	1~∞	∞		∞
Black/ Yellow	1~100	∞	0.1~50	

# 18. STARTING SYSTEM

---

---

## STARTING SYSTEM

---

STARTING SYSTEM LAYOUT -----	18-1
SERVICE INFORMATION-----	18-2
TROUBLESHOOTING-----	18-2
STARTER MOTOR -----	18-3
STARTER RELAY INSPECTION-----	18-3

# 18. STARTING SYSTEM

## STARTING SYSTEM LAYOUT

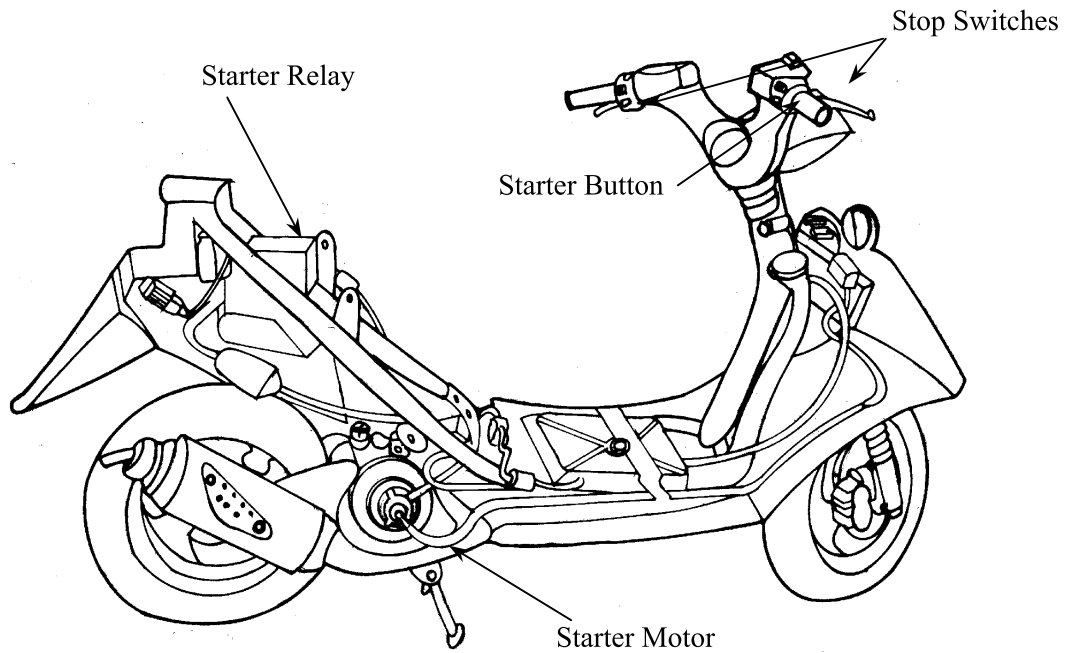

## STARTING CIRCUIT

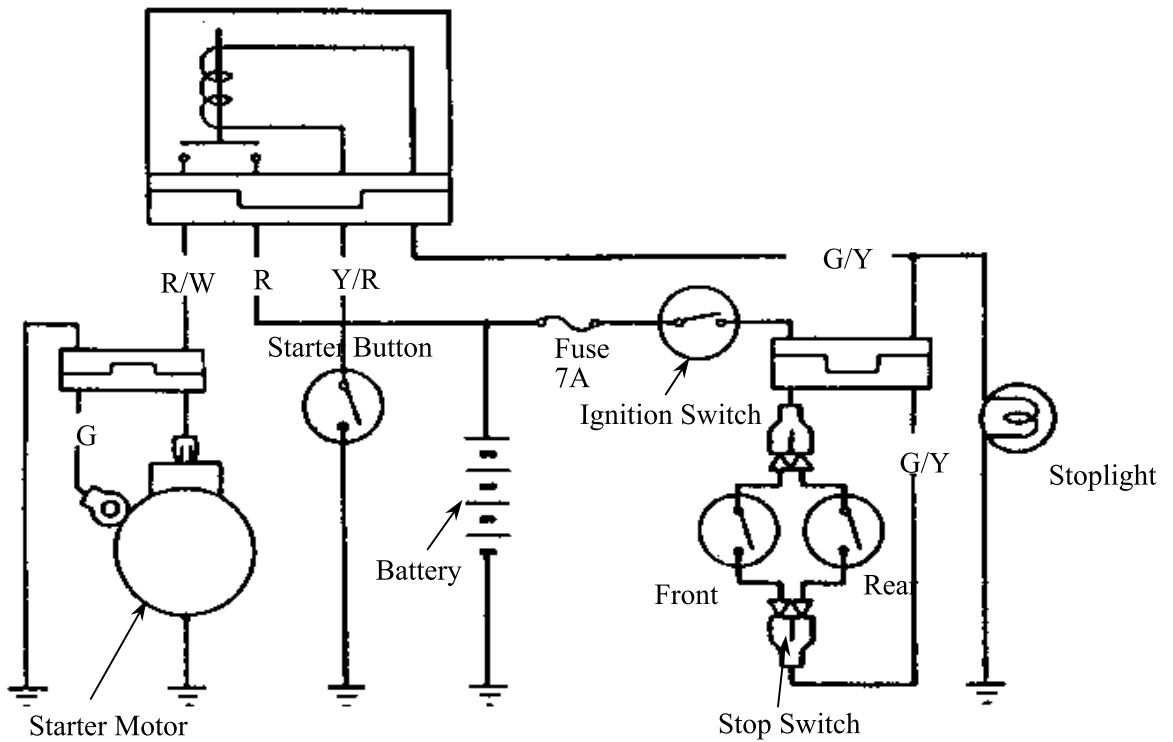



# 18. STARTING SYSTEM

---

## SERVICE INFORMATION

### GENERAL INSTRUCTIONS

- The removal of starter motor can be accomplished with the engine installed.
- For the starter clutch removal, refer to page 7-14.
- After the starter clutch is installed, be sure to add the engine oil and coolant and then bleed air from the cooling system.

### TORQUE VALUES

Starter motor mounting bolt      0.7~1.1kg-m

### SPECIAL TOOLS

Flywheel holder

Flywheel puller

### TROUBLESHOOTING

#### Starter motor won't turn

- Fuse burned out
- Weak battery
- Faulty ignition switch
- Faulty starter clutch
- Faulty front or rear stop switch
- Faulty starter relay
- Poorly connected, broken or shorted wire
- Faulty starter motor

#### Lack of power

- Weak battery
- Loose wire or connection
- Foreign matter stuck in starter motor or gear

#### Starter motor rotates but engine does not start

- Faulty starter pinion
- Starter motor rotates reversely
- Weak battery

# 18. STARTING SYSTEM

---

## STARTER MOTOR

### STARTER MOTOR REMOVAL

Disconnect the starter motor cable.  
Remove the two bolts attaching the starter motor and remove the starter motor.

The installation sequence is the reverse of removal.

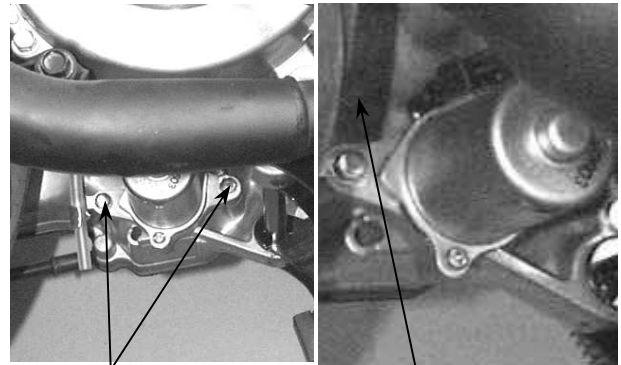

Mounting Bolts

Starter Motor Cable

### STARTER RELAY INSPECTION

Remove the battery cover.  
Disconnect the starter relay coupler and then remove the starter relay.

Starter Relay

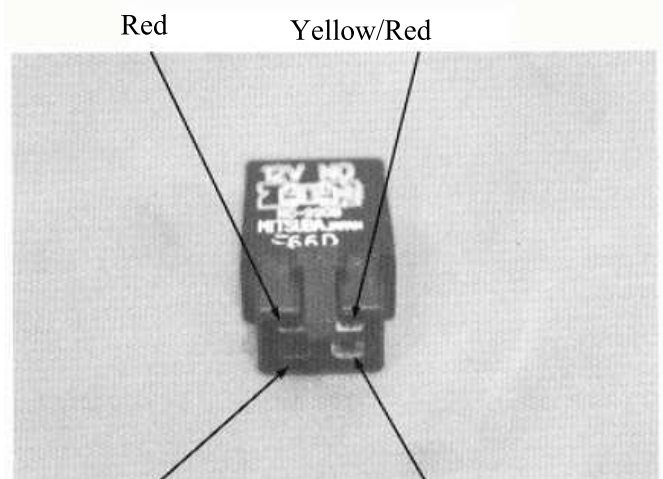
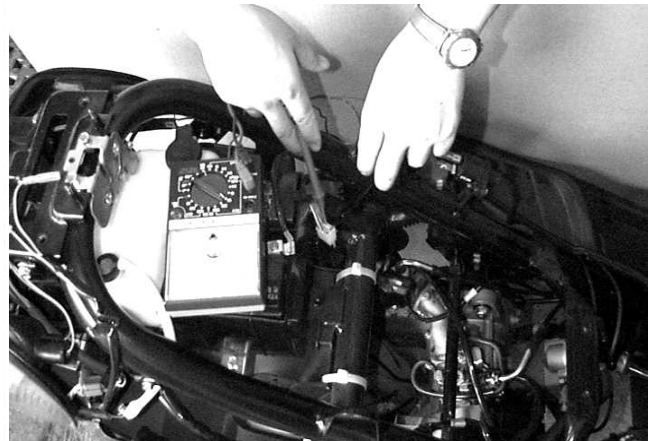

Red

Yellow/Red

Red/White

Green/Yellow

Connect the starter relay green/yellow terminal to the 12V battery positive (+) terminal and the relay yellow/red terminal to the battery negative (-) terminal. Check for continuity between the starter relay red and red/white terminals. The relay is normal if there is continuity.

# 19. SWITCHES/HORN/FUEL UNIT/THERMOSTATIC SWITCH /TEMPERATURE GAUGE/INSTRUMENTS/LIGHTS

---

19

---

## SWITCHES/HORN/FUEL UNIT/THERMOSTATIC SWITCH/TEMPERATURE GAUGE/ INSTRUMENTS/LIGHTS

---

ELECTRICAL EQUIPMENT LAYOUT-----	19-1
SERVICE INFORMATION-----	19-2
TROUBLESHOOTING-----	19-2
SWITCHES-----	19-3
HORN INSPECTION -----	19-5
FUEL UNIT -----	19-5
THERMOSTATIC SWITCH -----	19-6
TEMPERATURE GAUGE-----	19-6
INSTRUMENTS-----	19-7
LIGHTS -----	19-8

# 19. SWITCHES/HORN/FUEL UNIT/THERMOSTATIC SWITCH /TEMPERATURE GAUGE/INSTRUMENTS/LIGHTS

---

## ELECTRICAL EQUIPMENT LAYOUT

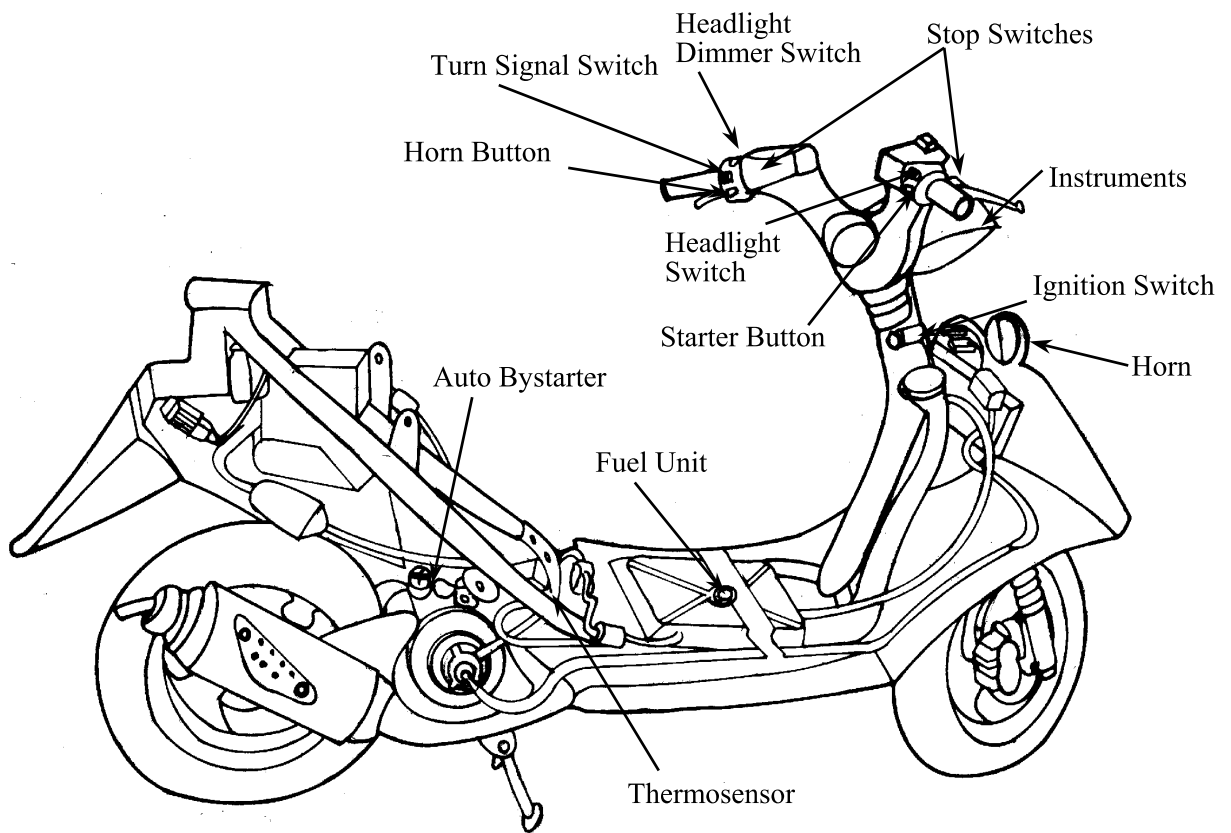

# 19. SWITCHES/HORN/FUEL UNIT/THERMOSTATIC SWITCH /TEMPERATURE GAUGE/INSTRUMENTS/LIGHTS

---

## SERVICE INFORMATION

### GENERAL INSTRUCTIONS

- After installation of each switch, a continuity check must be performed. A continuity check can usually be made without removing the part from the motorcycle.

### TESTING INSTRUMENT

Electric tester

### SPECIAL TOOL

Fuel unit wrench

## TROUBLESHOOTING

### Lights do not come on when ignition switch is "ON"

- Burned bulb
- Faulty switch
- Poorly connected, broken or shorted wire

### Temperature gauge does not register correctly

- Faulty temperature gauge
- Faulty thermosensor
- Broken or shorted wire between temperature gauge and thermosensor

### Fuel gauge pointer does not move or register correctly

- Faulty fuel gauge
- Faulty fuel unit
- Poorly connected wire between fuel gauge and fuel unit
- Fuse burned out

## SPECIFICATIONS

Fuse	20A
Headlight bulb	12V 35W/35W
Turn signal light bulb	12V 10W
Stoplight/taillight	12V 5W
License plate light	12V 3.4W
Instrument light	12V 1.7W
Position light	12V 3W/5W
Turn signal indicator light	12V 10W

# 19. SWITCHES/HORN/FUEL UNIT/THERMOSTATIC SWITCH /TEMPERATURE GAUGE/INSTRUMENTS/LIGHTS

## SWITCHES

### IGNITION SWITCH INSPECTION

Remove the frame front covers. (⇒2-5)  
 Disconnect the ignition switch wire couplers.  
 Check for continuity between the wire terminals.

Color Position	R	B/W	G	B
LOCK		○	○	
OFF		○	○	
ON	○			○

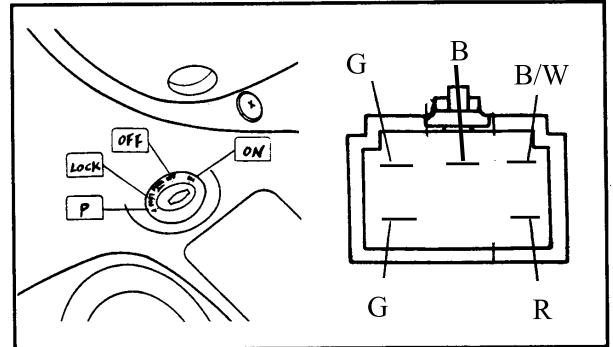

Ignition Switch

### HEADLIGHT SWITCH INSPECTION

Remove the frame front covers. (⇒2-5)  
 Disconnect the headlight switch wire couplers. Check for continuity between the wire terminals.

Color Position	Y	BR/W	BR	L/W	P
■	○				○
P	○	○	○		
H	○		○	○	

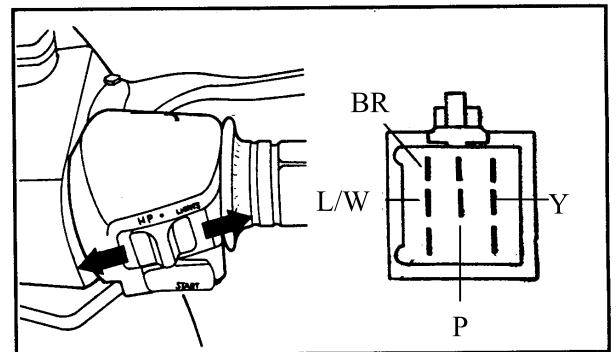

Headlight Switch

### STARTER SWITCH INSPECTION

Remove the frame front covers. (⇒2-5)  
 Disconnect the starter switch wire couplers.  
 Depress the starter button and check for continuity between the wire terminals.

Color Position	Y/R	G
FREE		
PUSH	○	○

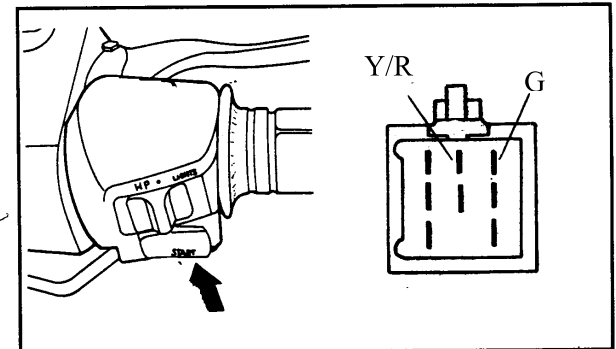

Starter Switch

### PASSING SWITCH

Remove the front upper cover. (⇒2-5)  
 Disconnect the headlight switch wire couplers. Check for continuity between the passing switch wire terminals.

Color Position	L	L/W
FREE		
PUSH	○	○

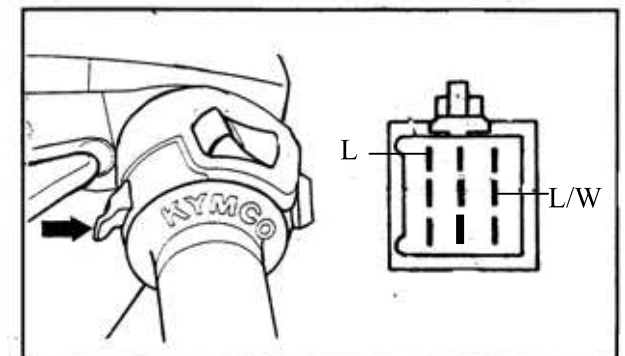

Passing

# 19. SWITCHES/HORN/FUEL UNIT/THERMOSTATIC SWITCH /TEMPERATURE GAUGE/INSTRUMENTS/LIGHTS

## HORN BUTTON INSPECTION

Remove the frame front covers. (⇒2-5)  
 Disconnect the horn wire couplers.  
 Depress the horn button and check for continuity between the wire terminals.

Color Position	LG	BR/L
FREE		
PUSH	○	○

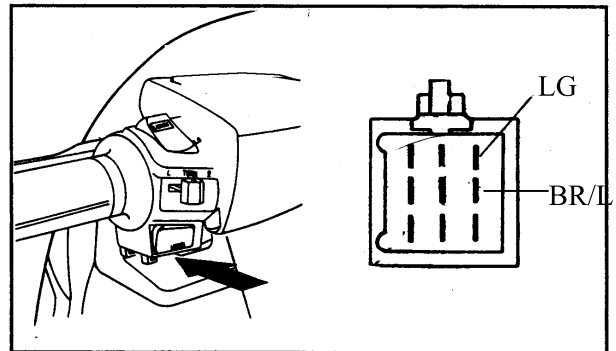

Horn Button

## TURN SIGNAL SWITCH INSPECTION

Remove the frame front covers. (⇒2-5)  
 Disconnect the turn signal switch wire couplers and turn on the turn signal switch.  
 Check for continuity between the wire terminals.

Color Position	SB	O	GR
L		○	○
N			
R	○		○

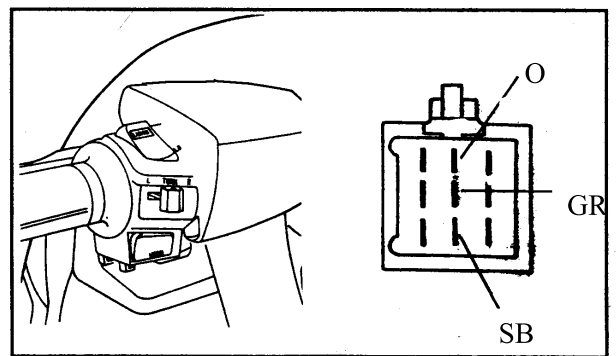

Turn Signal Switch

## DIMMER SWITCH INSPECTION

Remove the frame front covers. (⇒2-5)  
 Disconnect the headlight dimmer switch wire couplers.  
 Turn on the dimmer switch and check for continuity between the wire terminals.

Color Position	L/W	L	W
LO	○		○
N	○	○	○
HI	○		○

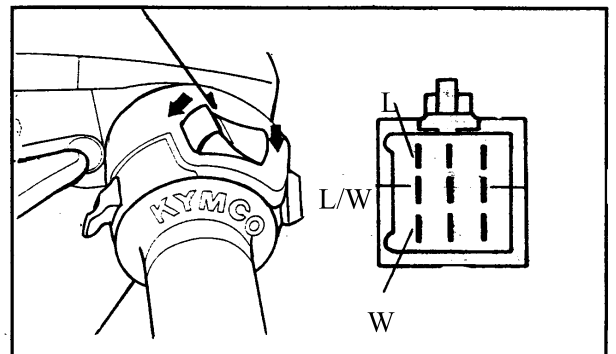

Dimmer Switch

## STOP SWITCH INSPECTION

Remove the frame front covers. (⇒2-5)  
 Disconnect the front/rear stop switch wire couplers.  
 Check for continuity between the wire terminals when the front brake lever is applied.

Color Position	BR/L	G/Y
FREE		
APPLY	○	○

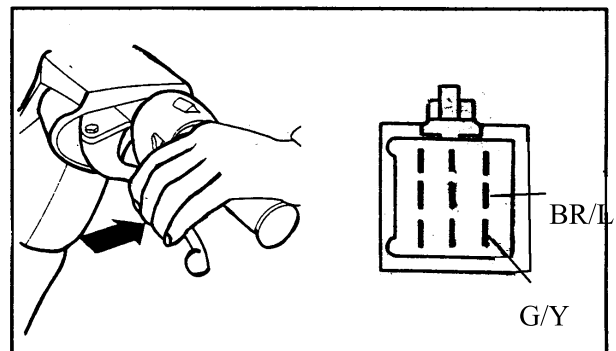

Stop Switch

# 19. SWITCHES/HORN/FUEL UNIT/THERMOSTATIC SWITCH /TEMPERATURE GAUGE/INSTRUMENTS/LIGHTS

## HORN INSPECTION

Remove the front upper cover. (⇒2-5)  
 Disconnect the horn wire couplers.  
 The horn is normal if it sounds when a 12V battery is connected across the horn wire terminals.



Horn

## FUEL UNIT

### FUEL UNIT INSPECTION

Remove the fuel unit.  
 Disconnect the fuel unit wire connectors.  
 Measure the resistance between the fuel unit wire terminals with the float at upper and lower positions.

Wire Terminals	Upper	Lower
Y/W~G	33~45Ω	500~850Ω
L/W~G	400~700Ω	100~200Ω
Y/W~L/W	450~750Ω	450~750Ω

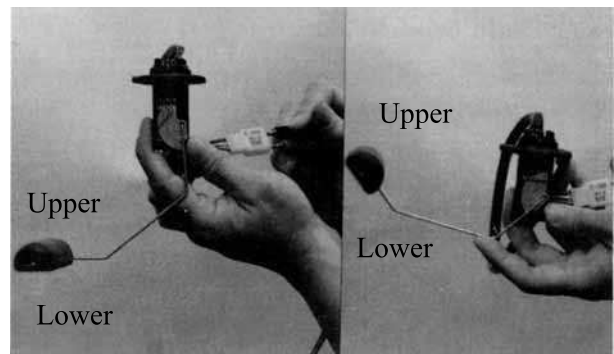

Fuel Unit

### FUEL GAUGE INSPECTION

Connect the fuel unit wire connectors and turn the ignition switch "ON".

\* Before performing the following test, operate the turn signals to determine that the battery circuit is normal.

Check the fuel gauge needle for correct indication by moving the fuel unit float up and down.

Float Position	Needle Position
Upper	"F" (Full)
Lower	"E" (Empty)

Wire Terminals	Needle Position
Y/W~G	From E to F
L/W~G	From F to E

The fuel gauge is normal if it operates as above indicated. If not, check for loosely tightened nuts, poorly connected terminals or shorted wires.

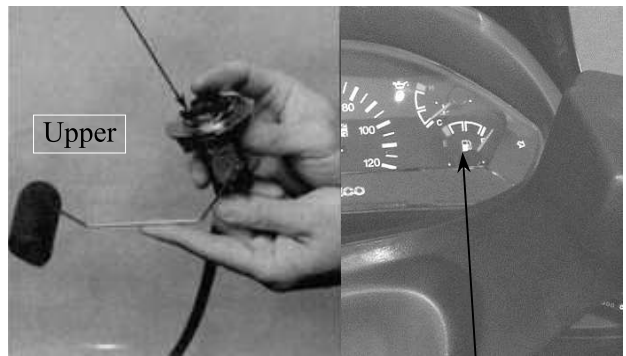

Fuel Gauge



Needle moves from F to E.



# 19. SWITCHES/HORN/FUEL UNIT/THERMOSTATIC SWITCH /TEMPERATURE GAUGE/INSTRUMENTS/LIGHTS

## OIL METER

### INSPECTION

Remove the met-in box. (⇒2-4)  
 Remove the frame body cover. (⇒2-4)  
 Disconnect the oil meter wire connectors and remove the oil meter. Keep the oil meter float at the lower position.  
 Measure the resistances between the wire terminals as ① and ② shown in the left figure.

Wire Terminals	Resistance
Green/Red(+)-Black(-)	5 ~ 16Ω
Green(-)-Black(+)	∞

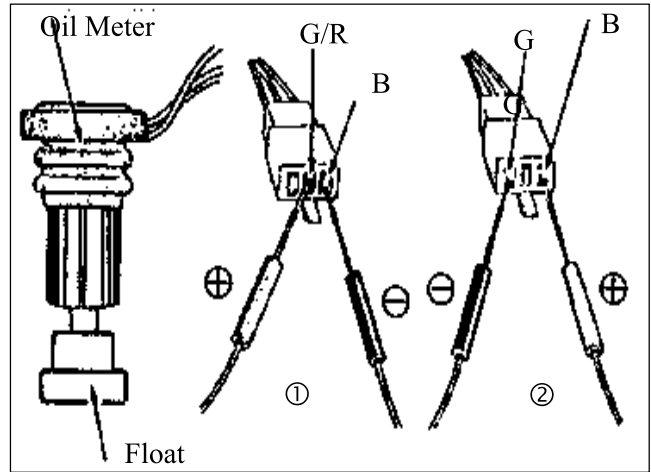

\* Before removing the oil meter, be sure to drain the motor oil and do not allow sparks or flames near the working area.

### Oil Meter Operation Inspection

Connect the oil meter wire connectors and turn the ignition switch ON.  
 Measure the resistance between the wire terminals with the float at upper position.

Green/Red(+)-Black(-)	About 340Ω
-----------------------	------------

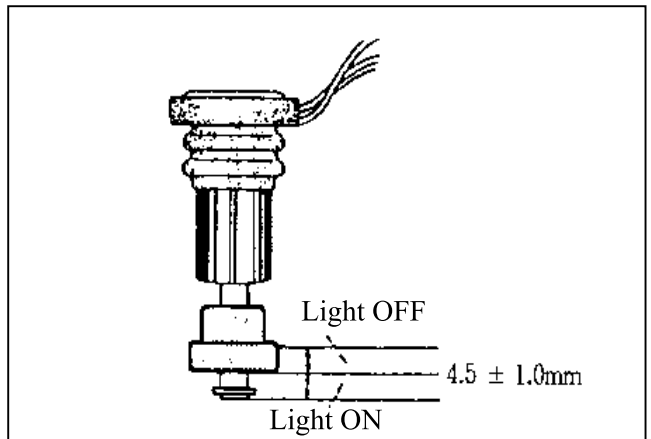

\* Before performing the following test, operate the turn signals to determine that the battery circuit is normal.

## TEMPERATURE GAUGE

Disconnect the wire from the thermosensor and ground it to the engine.  
 Turn the ignition switch ON.  
 The temperature gauge needle should move all the way to "H".

\* Do not leave the thermosensor wire grounded for longer than 5 seconds or the temperature gauge will be damaged.



## 19. SWITCHES/HORN/FUEL UNIT/THERMOSTATIC SWITCH /TEMPERATURE GAUGE/INSTRUMENTS/LIGHTS

---

### INSTRUMENTS

#### REMOVAL

Remove the front upper cover. (⇒2-5)  
Disconnect the instrument wire couplers and connectors.  
Disconnect the speedometer cable.

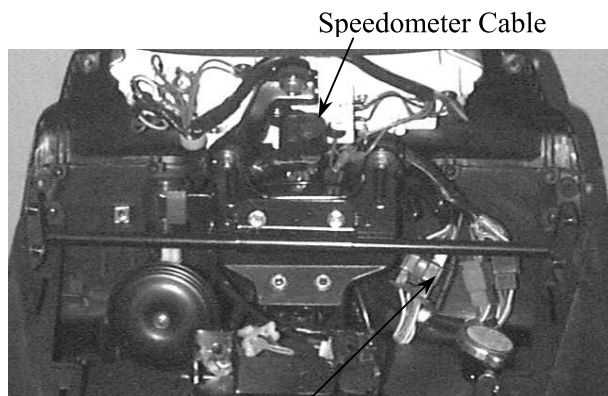

Remove the four instrument cover and leg shield screws.  
Remove the two instrument holder bolts.  
Remove the instruments.

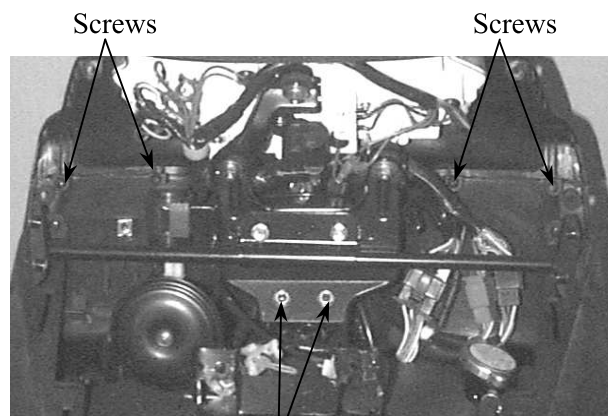

#### DISASSEMBLY/ASSEMBLY

Remove the three instrument holder nuts.  
Remove the holder.  
Remove the four screws to disassemble the instruments and instrument cover .  
Assemble the instruments in the reverse order of disassembly.

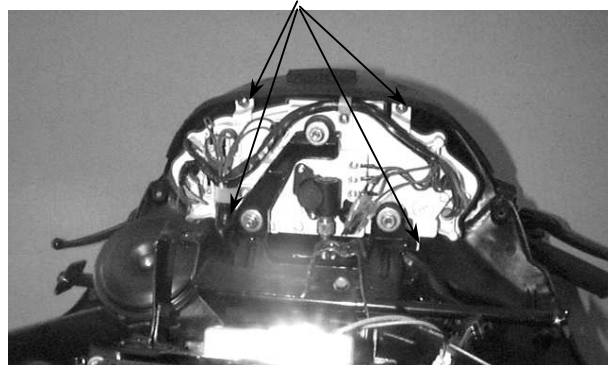

#### INSTALLATION

The installation sequence is the reverse of removal.

## 19. SWITCHES/HORN/FUEL UNIT/THERMOSTATIC SWITCH /TEMPERATURE GAUGE/INSTRUMENTS/LIGHTS

---

### LIGHTS

#### HEADLIGHT BULB REPLACEMENT

Remove the front upper cover. (⇒2-5)  
Disconnect the headlight and turn signal light wire couplers.  
Remove the rubber boot from the bulb socket.  
Remove the bulb socket and replace the bulb.  
Install the bulb socket, aligning the bulb socket tab with the groove.  
Install the rubber boot.  
Install the front cover in the reverse order of removal.

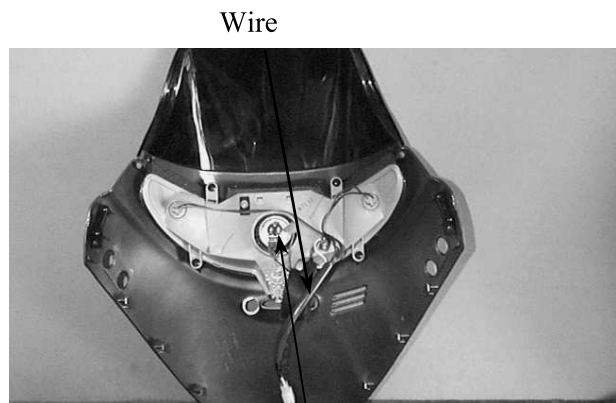

Wire

#### FRONT POSITION LIGHT BULB REPLACEMENT

Remove the front upper cover. (⇒2-5)  
Disconnect the headlight and turn signal light wire couplers.  
Remove the bulb sockets by turning them counterclockwise.  
Remove the bulbs and replace them with new ones.

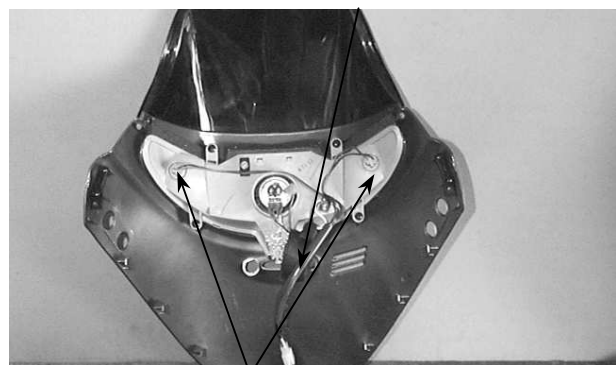

Wire

Front Position Light Bulb Sockets

#### FRONT TURN SIGNAL LIGHT BULB REPLACEMENT

Remove the two screws attaching the turn signal light shell.  
Remove the bulb and replace with a new one.

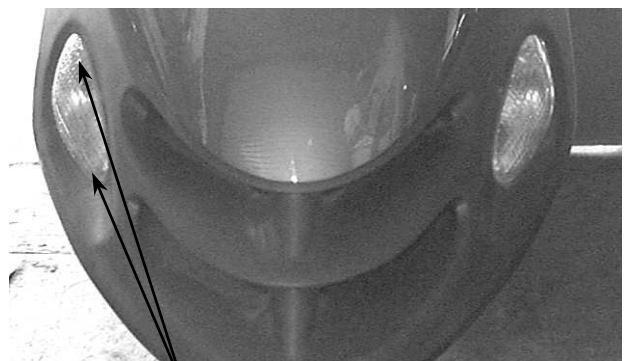

Screws

#### TAILLIGHT/REAR TURN SIGNAL LIGHT BULB REPLACEMENT

Remove the rear protective cover. (⇒2-3)  
Remove the two screws attaching the rear light shell and remove the light shell.  
Remove the bulbs and replace with new ones.  
The installation sequence is the reverse of removal.

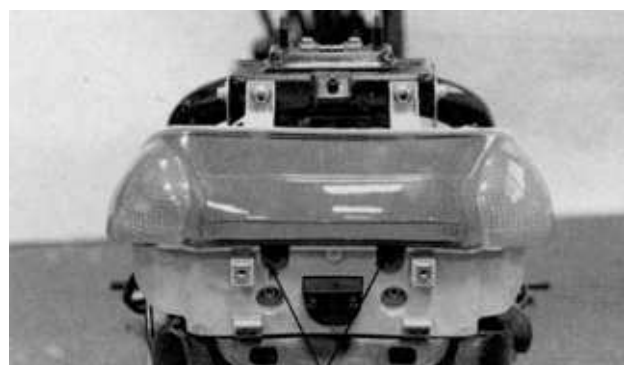

Screws

## **20. HIGH-SPEED TIRE**

---

**20**

### **HIGH-SPEED TIRE (TUBELESS TIRE)**

---

HIGH-SPEED TIRE CONSTRUCTION & FEATURES -----	20- 2
HIGH-SPEED TIRE MAINTENANCE PRECAUTIONS -----	20- 4
HIGH-SPEED TIRE REMOVAL/INSTALLATION -----	20- 5
HIGH-SPEED TIRE REPAIR -----	20-16

## 20. HIGH-SPEED TIRE

### HIGH-SPEED TIRE CONSTRUCTION & FEATURES

#### INNER LINER

A layer of rubber (inner liner) which replaces the inner tube is stuck to the inside wall of the high-speed tire. The inner liner is made of thick rubber, a material that high-pressure air can not pass through. The liner can not be lengthened like other inner tubes, so when nails are inserted into the tire, breaks will not be enlarged because the nails are suppressed to avoid air leaks. When tire break occurs, the inserted nails will spring out to make the tire run under low pressure. It is very dangerous because the tire temperature will raise highly to make tire wobble during riding. Therefore, riders must be very careful to check tire pressure and inserted nails before riding at high-speed.

- Tire pressure
- Tire deformation and damage
- Tire groove depth and abnormal wear

**Tire Depth:** Front : 0.8mm  
Rear : 0.8mm

- Imbedded metals, stones, or other foreign matters

The bead base where tire and rim contact is wrapped by rubber fabrics called tire bead in order to reinforce its function. The fabrics is specially adopted for the high-speed tire to keep its air density because air can not pass through this material. Also, the fabrics can keep the tire from damage when the tire falls off, and protect tire from damage due to friction of wheel rim while riding.

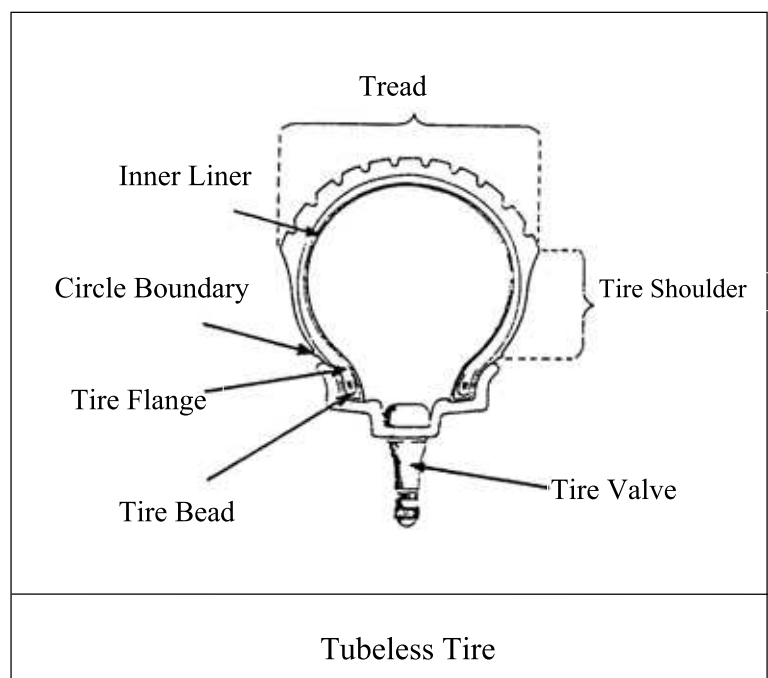
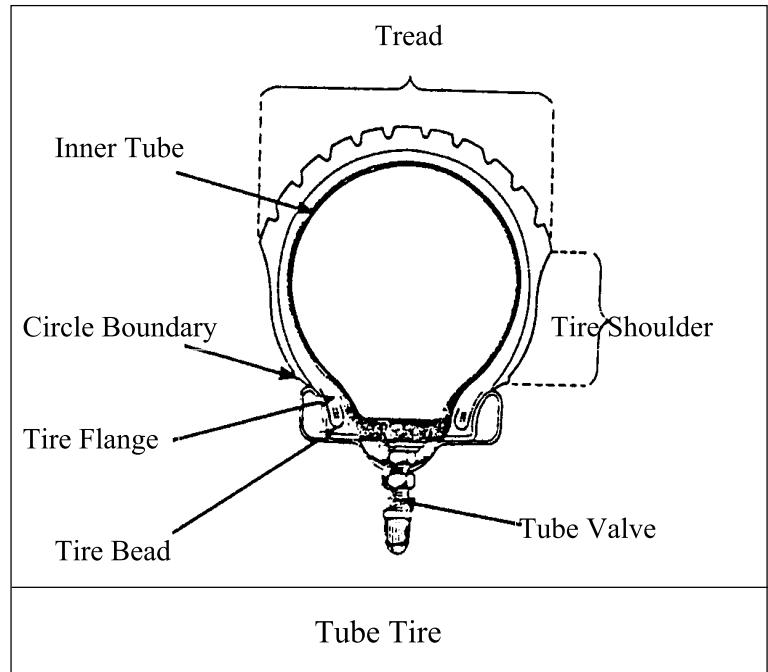

## 20. HIGH-SPEED TIRE

### TIRE FLANGE BEVEL ANGLE

If the tire flange radius is smaller than the wheel rim radius, the tire and wheel can be locked tightly. Take the advantage of tire bead bevel angle to enlarge tire bead so that the tire and rim can combine with each other precisely. Consequently, it can prevent air leaks and tire will not fall off the rim when tire break or low pressure occurs.

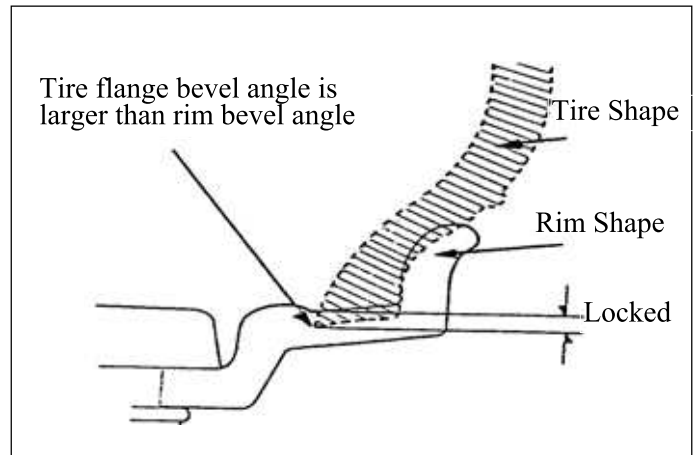

### METHOD TO IDENTIFY A HIGH-SPEED TIRE

For distinguishing a high-speed tire from a tube-tire, the word "TUBELESS" is stamped on the side wall of the high-speed tire. A tire without this word cannot be used as a high-speed tire.

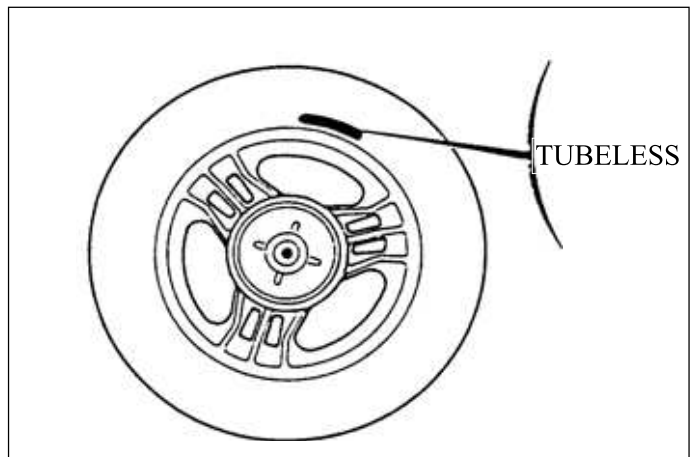

### RIM USED FOR HIGH-SPEED TIRE

For the purpose of preventing tire from falling off the wheel rim while driving, there are special requirements on the size, shape and pressure density of rim used for high-speed tire. It is necessary to use special rims.

Refer to the Figure shown for distinction. Air leaks occur easily when the wheel rim is deformed. Avoid driving on rugged road and crashing against stones. When replacing the high-speed tire, also replace the valve as a set.

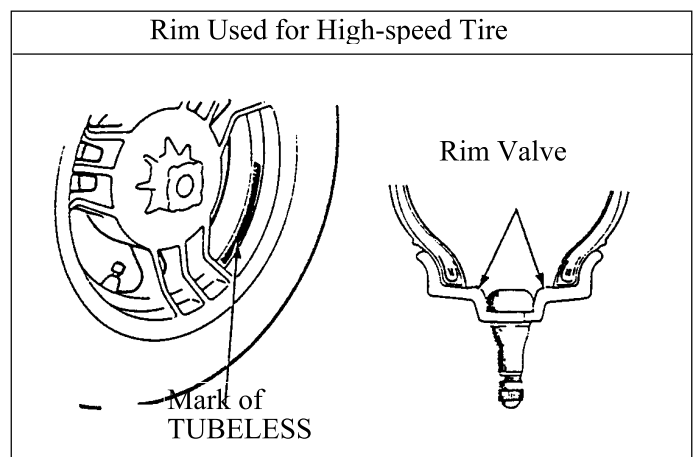

- \* When replacing the high-speed tire, use a tire of the same specification.

## 20. HIGH-SPEED TIRE

### RIM VALVE USED FOR HIGH-SPEED TIRE

Air-tight valve is specially designed for rim valve of a high-speed tire.

### AIR-TIGHT VALVE

A rubber of special shape is used to cover around the valve hole. The spring of rubber can prevent air leaks. Install the valve from the inner side of the rim and then pull it out through the rim valve hole with a special tool.

- \* Use only the KYMCO recommended air-tight valve.

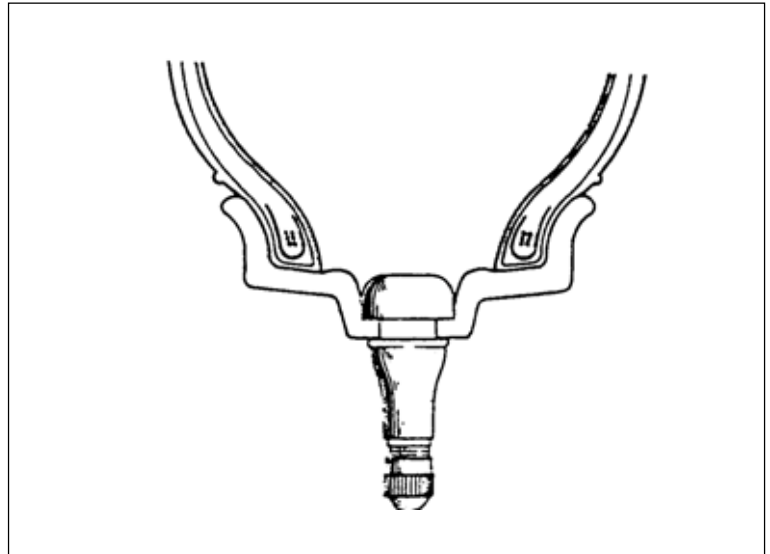

### HIGH-SPEED TIRE FEATURES

- Air will not release quickly when a nail is inserted into the tire. It is the same as the tube-tire that tire break may occur to a high-speed tire when nails or other objects are inserted into it. However, when a nail is inserted into a high-speed tire, external rubber and internal anti-leak rubber will grip the nail tightly to prevent air leaks. If the nail is deeply inserted, air will not release quickly to avoid sudden slipping of steering handlebar.

- EXCELLENT COOLING PERFORMANCE

Because the high-speed tire is tubeless, the air within the tire will contact the rim directly. Heat produced during driving can be dissipated through the rim. Heat affects the rubber greatly and if the tire temperature is not high, the tire service life can be prolonged.

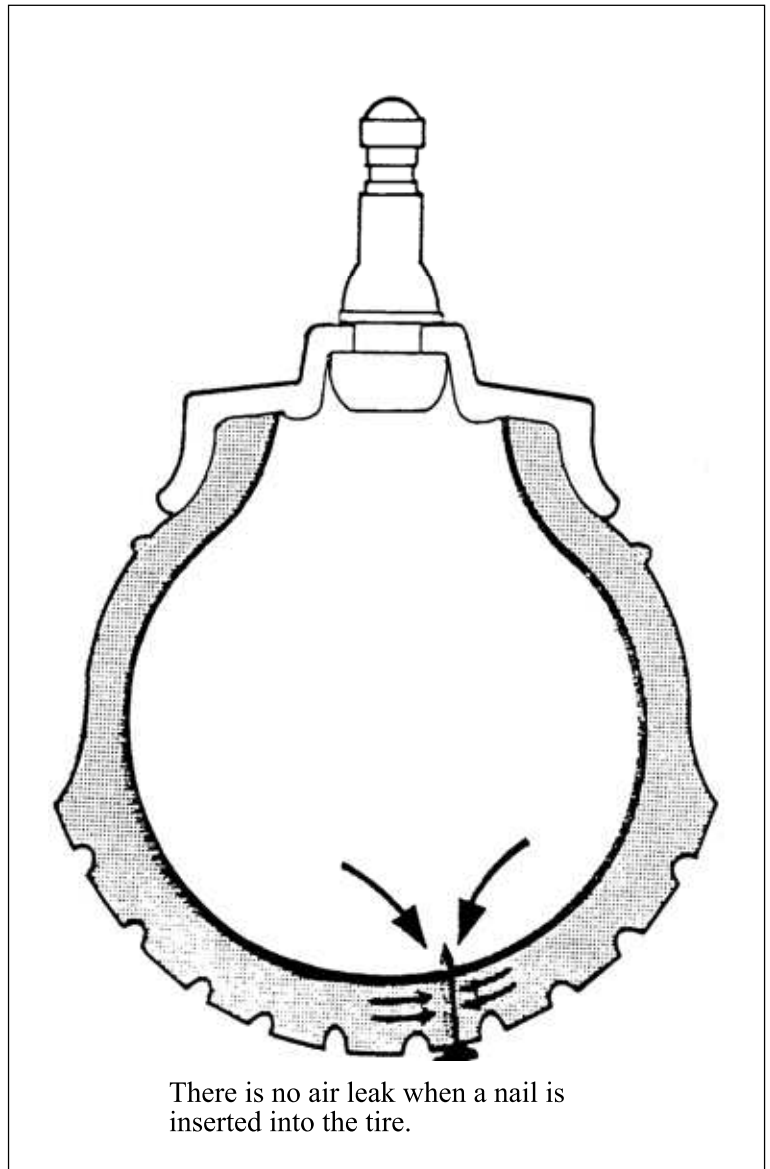

# 20. HIGH-SPEED TIRE

## PRECAUTIONS FOR HIGH SPEED TIRE STORAGE

### •STORAGE METHODS

If the space within the tire bead of a high-speed tire is narrower than the width of its rim, it is hard to install the tire to the rim and pump air into the tire. Therefore, it is better to put cardboard within the tire bead and put tires in order.

Tires deform easily if they are piled horizontally. Avoid doing so.

As to the reused tires, the structure of the rim remains the same. Install the valve cap when the tire pressure is lowered to 1/2 of the specified pressure.

### •PLACE FOR STORAGE

The place used for storage should avoid the following conditions:

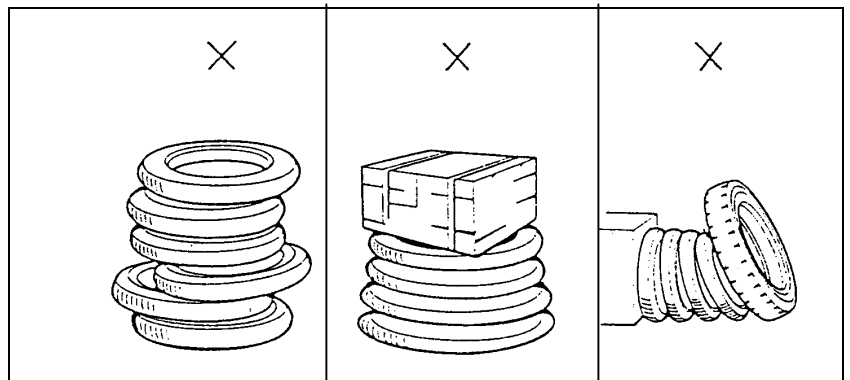
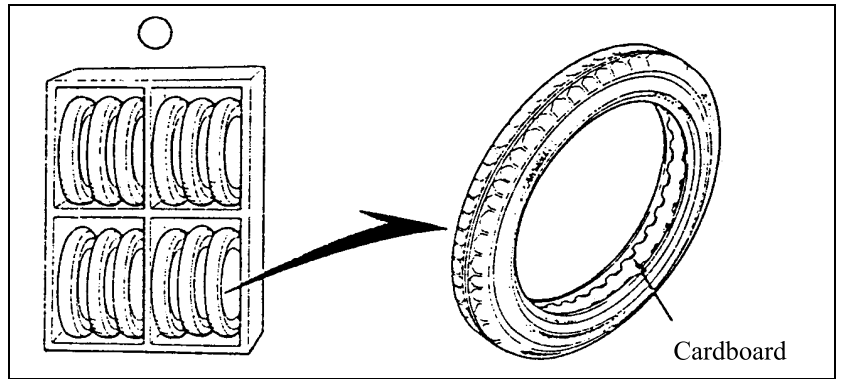

① A place where produces ozone (a place near motors or chargers)

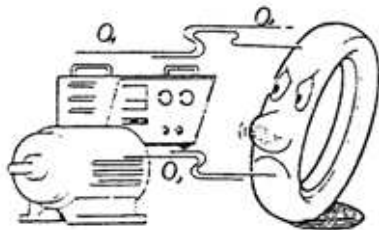

② A place where produces heat (a place near stoves or steam pipes)

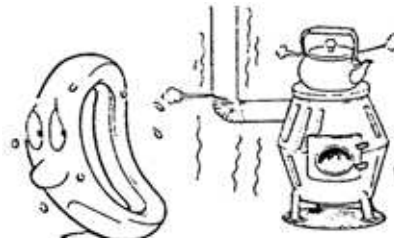

③ A place with oils or lubricants (especially in service working area)

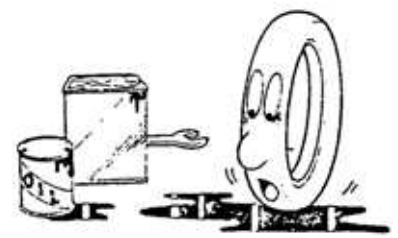

④ A place with direct sunshine

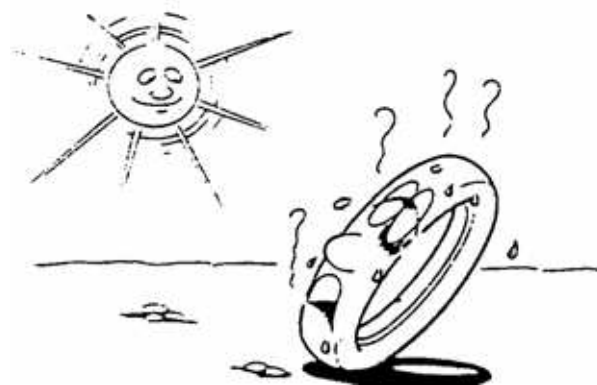

⑤ A place with high moisture

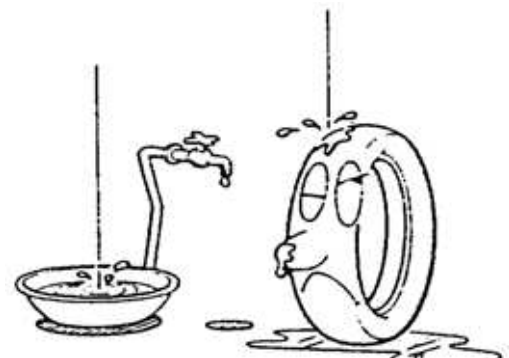



## 20. HIGH-SPEED TIRE

---

### HIGH-SPEED TIRE REMOVAL/INSTALLATION

In comparison with the tube-tire, the following points must be noticed when removing and installing a high-speed tire.

- When removing the high-speed tire, avoid damaging the tire bead (special plastic seat), tire liner (internal anti-leak material) and rim flange (bead base).
- Apply vegetable soapy water to the contact area between the tire bead and rim, and use a tire iron for installation.
- It will cause tire deformation when removing the tire forcedly as the figure shown. Be sure to remove the tire following the instructions given in the manual.
- The tight joint of tire and rim can prevent air leaks. As long as the rim is deformed, air leaks will occur easily. Therefore, do not remove or install the tire forcedly. Use special tools and rim protector for servicing. Frequently check if there is any deformed part and do not use tools of poor quality.
- Rust and rubber materials on bead base are the main cause of air leaks. Remove them thoroughly.
- Be sure to remove and install the tire following the procedures provided in the manual.

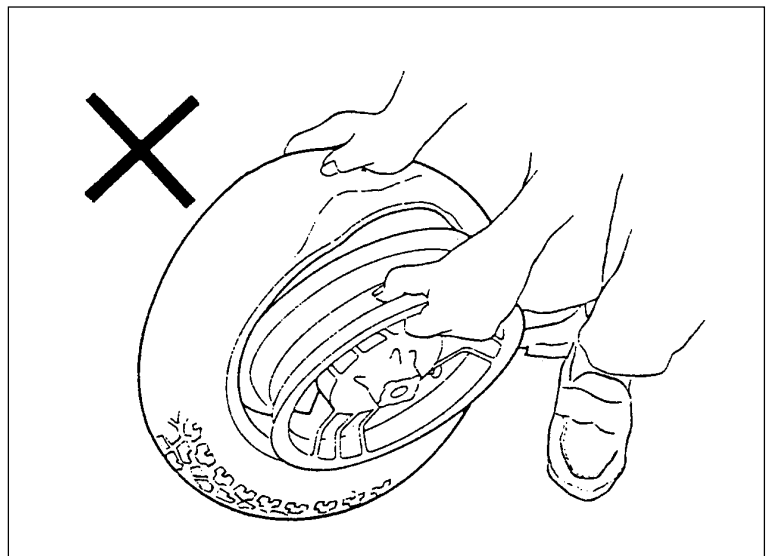
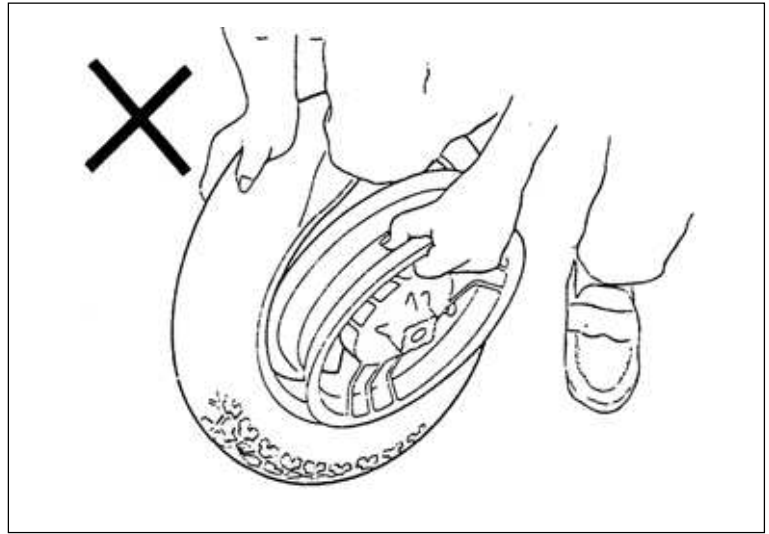

\*

- When removing or installing a high-speed tire, do not damage the axle bearing. Draw or pull the rubber on the rim lower part.
- It is difficult to remove a tire when the rim valve is pressed by tire flange. In this situation, do not remove it forcedly because the rim valve hole will be damaged.

## 20. HIGH-SPEED TIRE

### TOOLS & PARTS REQUIRED FOR SERVICING

- ① Tire iron
- ② Wheel rim protector
- ③ Knife
- ④ Water pan and probe
- ⑤ Vegetable soapy water
- ⑥ Pressure gauge
- ⑦ Valve core assembly tool
- ⑧ Valve assembly tool
- ⑨ Rim valve used for high-speed tire
- ⑩ Valve core
- ⑪ High-speed tire

High-speed tire  
Model: KYMCO DINK50  
Tire size: 110/70-12 (Front)  
130/70-12 (Rear)

Make sure to use KYMCO-recommend high-speed tire and rim valve.

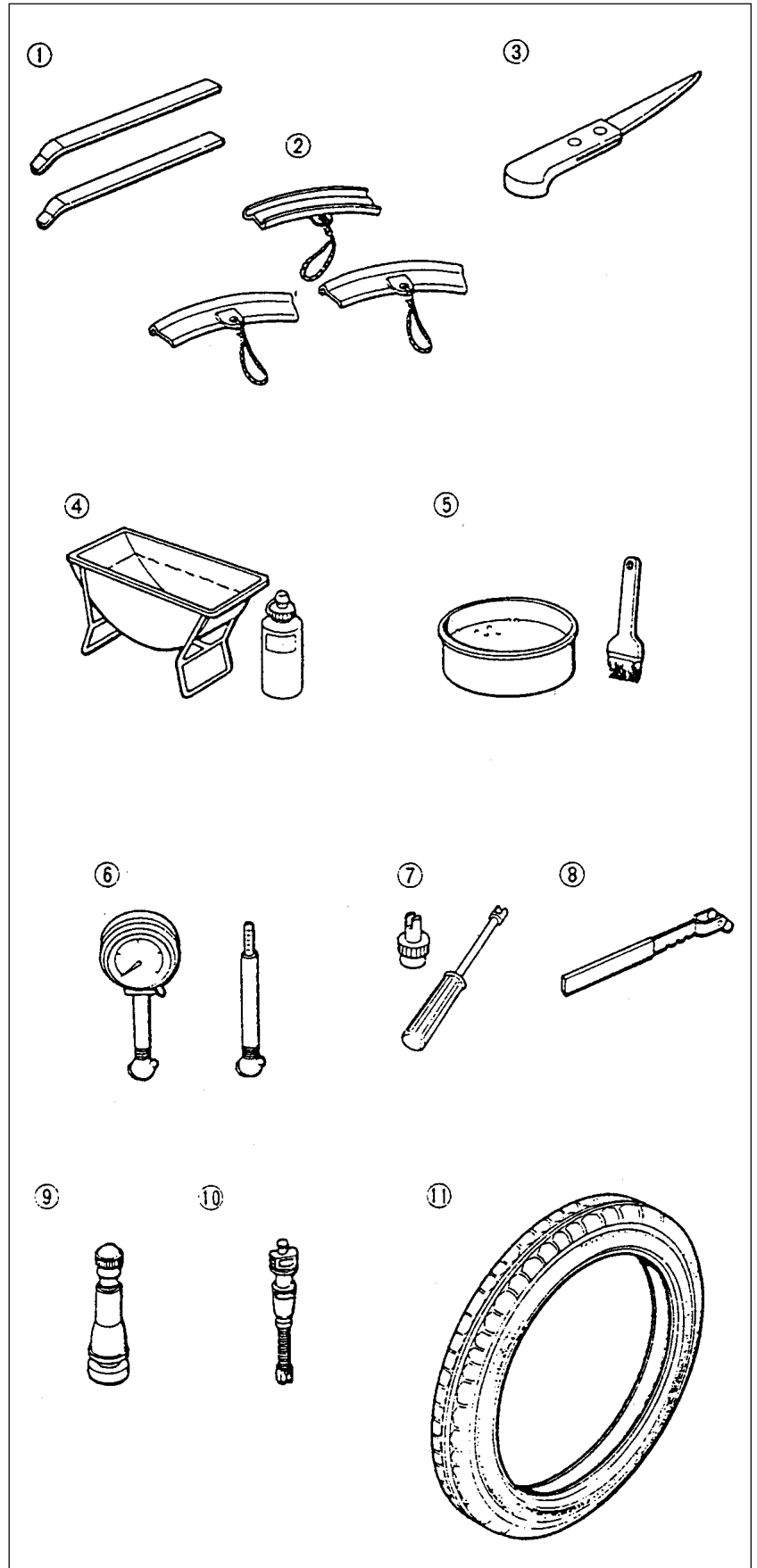

## 20. HIGH-SPEED TIRE

### REMOVAL METHODS

① Use the valve core assembly tool to take the valve core out and bleed air from the tire.

\* When removing the valve core, be careful that the high tire pressure may force out the valve

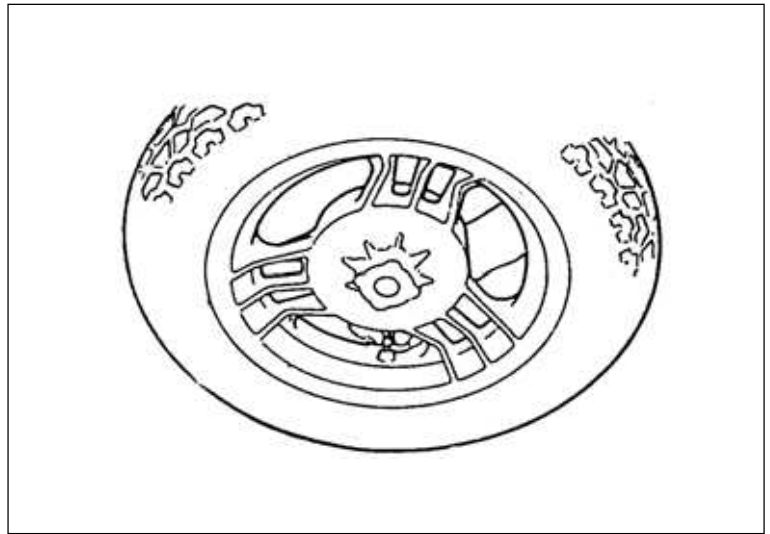

② If there is no special tool to pry off the tire bead, use your feet to do this as the figure shown.

\* • Don't step on the wheel rim and spoke wire.  
• Before installing the tire, make sure that the rim and axle bearing are not damaged. Be careful during installation.

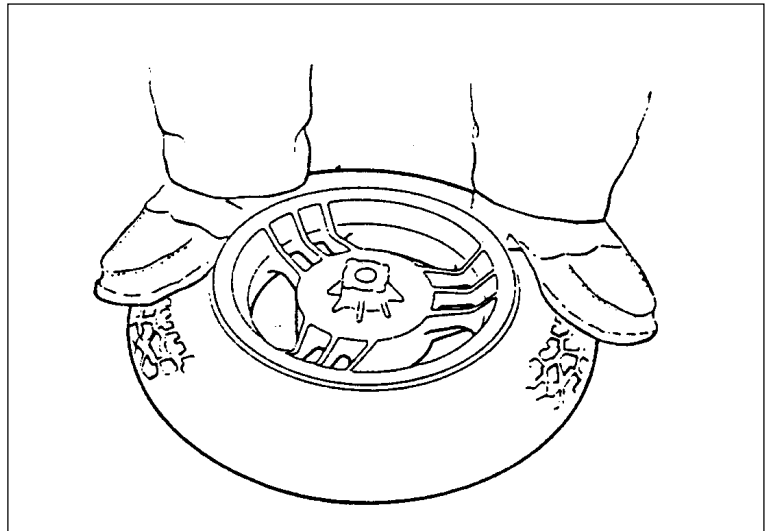

③ After the tire bead is separated from the rim and before removing the tire, press the tire bead at the back of the valve into the rim groove completely. Then push the tire to the same side.

\* It is easier to remove the tire when it is pushed to the same side of rim.

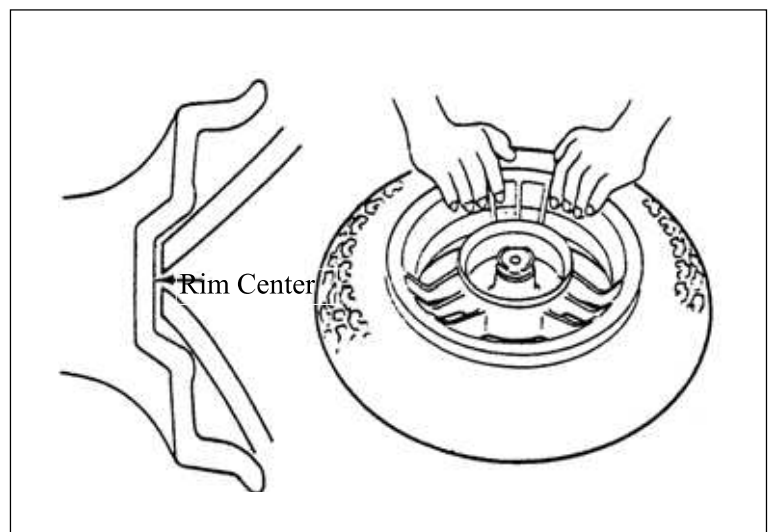

## 20. HIGH-SPEED TIRE

④ Apply vegetable soapy water to the area between the rim and tire and install the rim protector at the rim side. Then insert the tire iron to pry off the tire bead from the rim. At this time, the tire bead at the back side of the valve is in the rim groove completely. After making sure the above mentioned is done, remove the tire by following the sequence of 1→2→3→4.

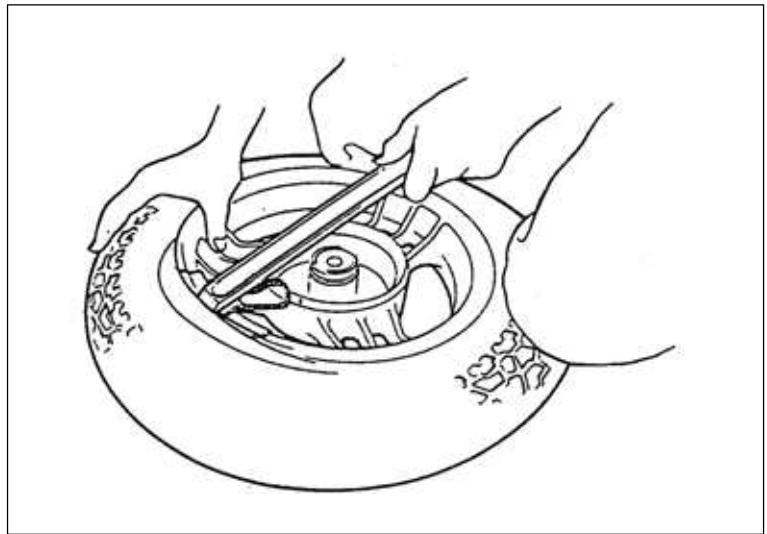

\* Do not use a tool other than the tire iron for motorcycle tire removal. Use the wheel rim protector for removal.

⑤ Insert the second tire iron 30~50mm from the first one. Then separate the tire bead from the rim.

\* If you want to separate the tire bead from the rim only by one tire iron, the tire bead will be deformed due to using too much force. The rim will also be damaged seriously. Avoid this way of removal.

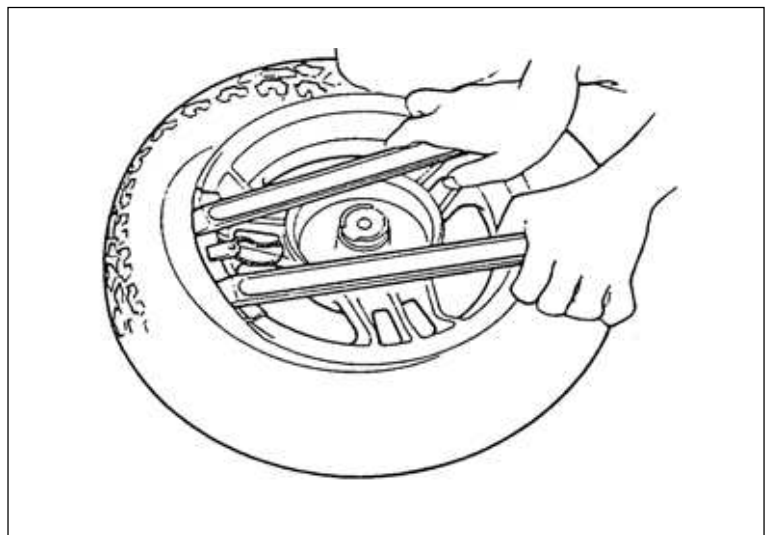

⑥ It is the same as ⑤. Use the first tire iron to pry off tire bead from the rim, then use the second one to pry off another part of the tire rim from the rim (distance: 30~50mm) slowly.

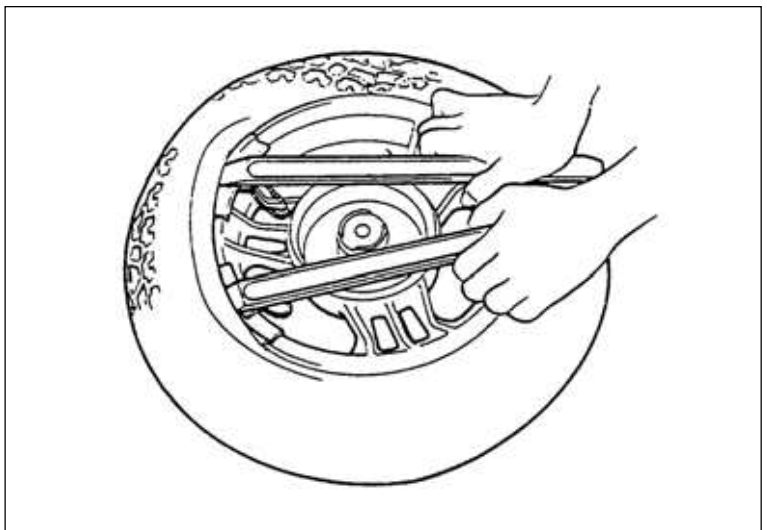
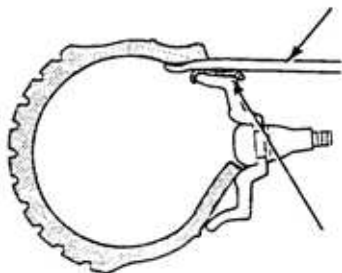

## 20. HIGH-SPEED TIRE

---

⑦ The procedure is the same as ⑤ and ⑥. If 1/3 of the tire bead is separated from the rim, the whole tire is easily taken off.

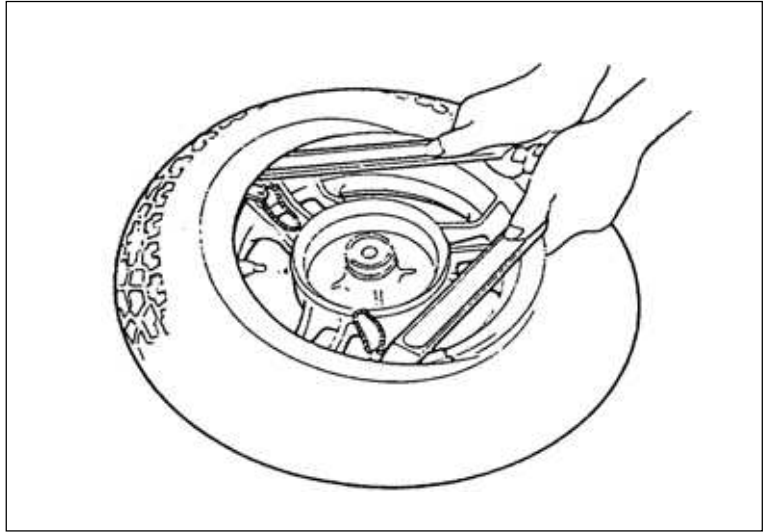

⑧ When 1/2 of the tire bead is pried off the rim, the tire will be easily removed by using only one tire iron.

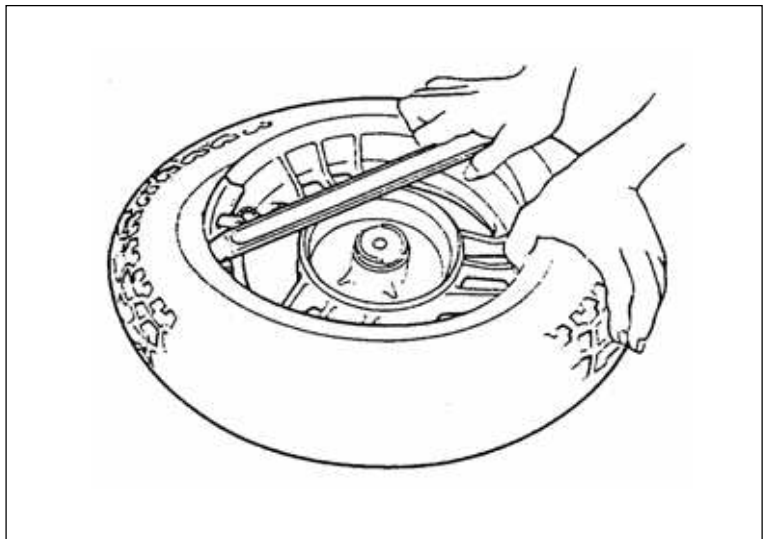

⑨ The bead at the back side can be pried off in the same procedures described in ④ ~ ⑧.

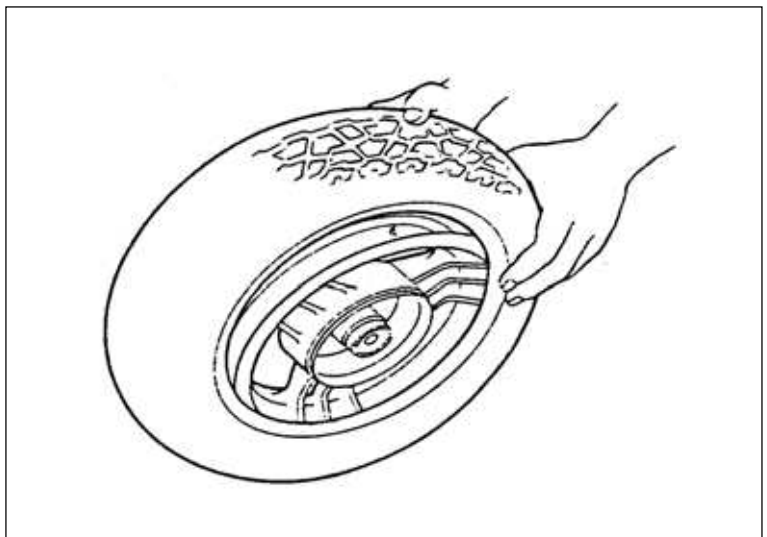

## 20. HIGH-SPEED TIRE

- ⑩ Take out the rim from the tire.  
Check the rim valve for damage.  
Replace any faulty parts.

\* When the tire is replaced, replace the valve as a set.

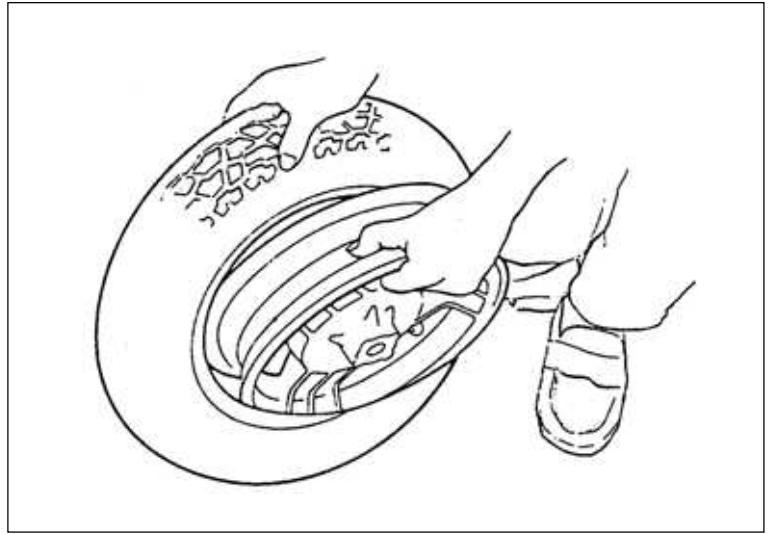

### RIM VALVE REMOVAL

Cut the rim valve from its bottom.

\* Be careful not to damage the rim valve hole.

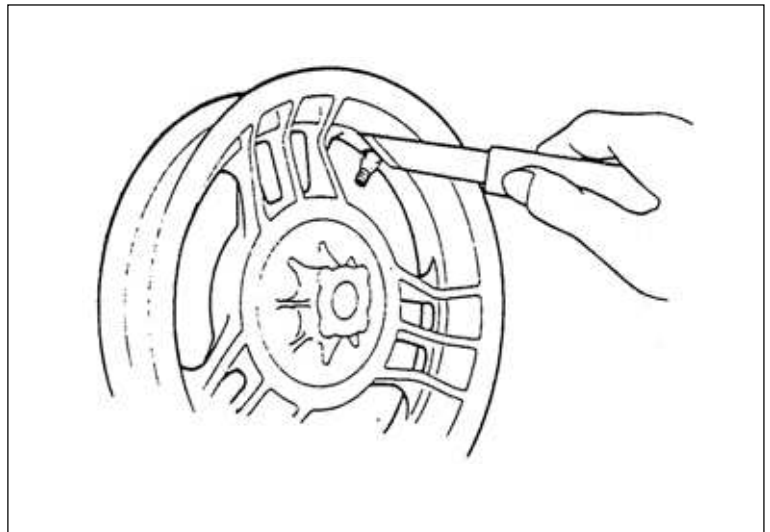

### RIM VALVE INSTALLATION

Apply vegetable soapy water to facilitate the installation of rim valve. Apply after other foreign objects are removed.

- Apply around the valve when installation.
- Apply to the tire bead while assembling the tire and rim.

\* Do not use oil or gasoline. Use vegetable soapy water only.

Apply vegetable soapy water to the inner side of rim valve and then use a special tool to pull the valve out.

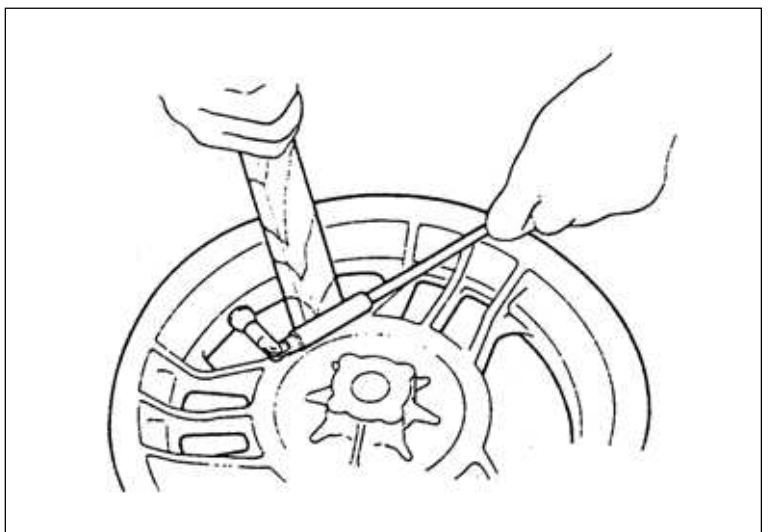

## 20. HIGH-SPEED TIRE

### RIM AND TIRE INSPECTION

#### RIM INSPECTION

Check the rim and remove rust and rubber materials from the rim.

Air leak will be caused by rim deformation or cracks.

When the tire or rim has cracks, do not repair them and immediately replace with a new one.

#### THE DEPTH AND WIDTH OF TIRE SCAR IS OVER 0.5MM AND 1.0MM

#### TIRE INSPECTION

The tire cannot be repaired and must be replaced with a new one under the following conditions.

- Tire crack or break is caused by a foreign object of 6mm outer radius.
- The layer of tire-contact part falls off.
- Worn tire tread.
- Worn tire bead.
- Broken tire bead stiffener or other bead damage.
- Broken fabrics.
- Deflection caused by dragging force.
- Rubber cutting damage.
- Abnormal internal anti-leak rubber.
- Side wall breaks or damage.
- Tire tread depth is under 0.8mm

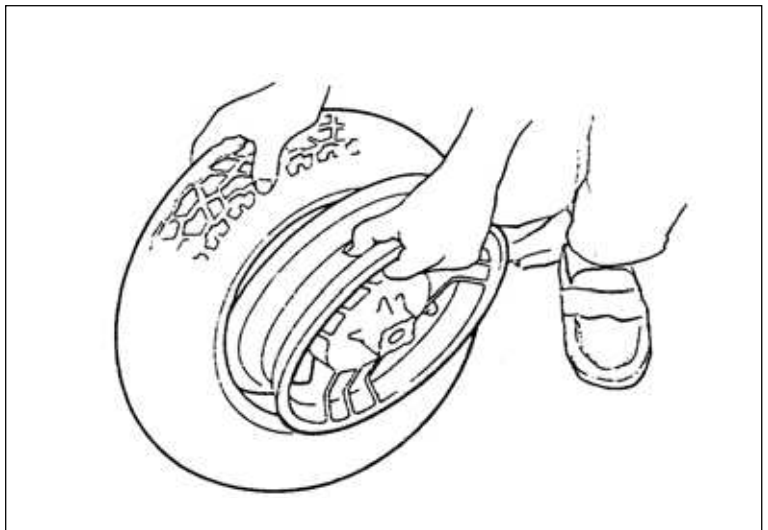
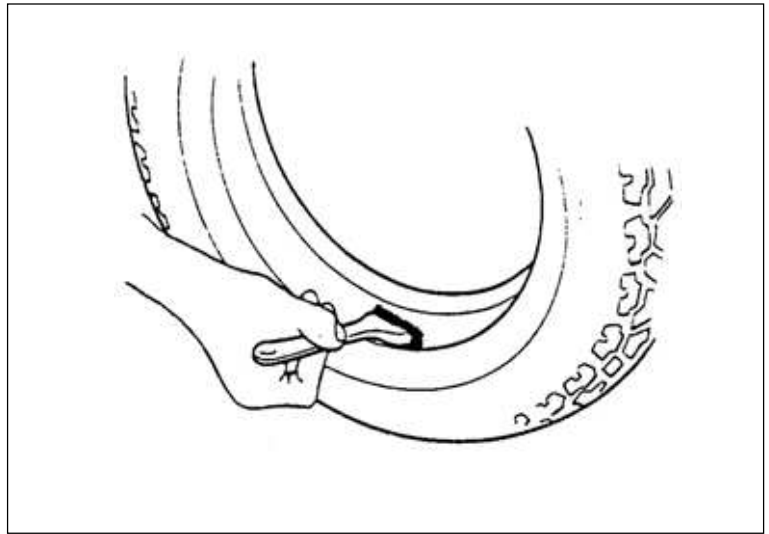

### INSTALLATION

Before installation, check the tire inside for damage.

\*

When the tire is deformed, repair and correct the deformed part by hand.

Apply vegetable soapy water to the right and left sides of tire bead. Keep the tire upright and start to install the tire from the back of the rim valve according to the order of 1→2→3→4. Then, push the tire into the rim by hand to the part where hands can reach in.

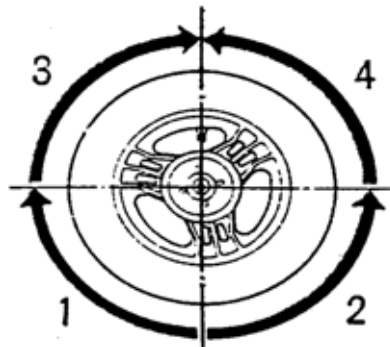

## 20. HIGH-SPEED TIRE

Put the wheel horizontally and put the rim protector on the rim. Use 2 tire irons to install the tire bead into the rim slowly (30~50mm).

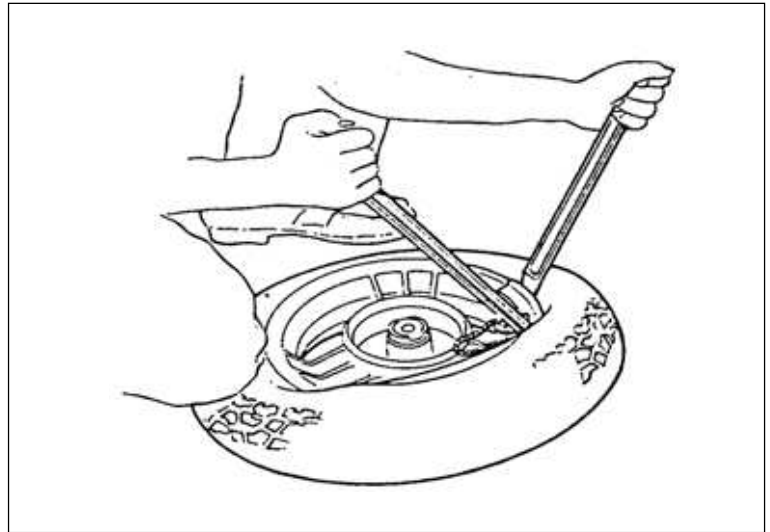

Use 2 tire irons to install the tire bead for the last 50~60mm part. By this way, one side of the tire bead is installed.

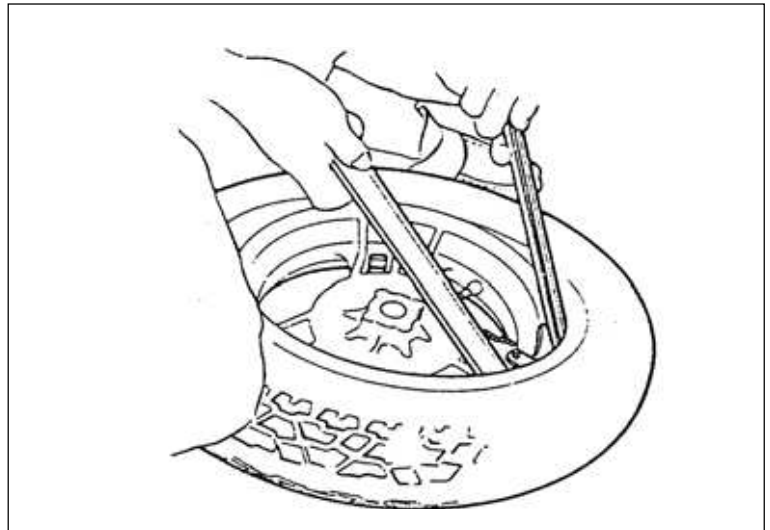

The installation of the other side of tire bead should be started from the opposite side of the tire valve according to the order of 1→2→3→4.

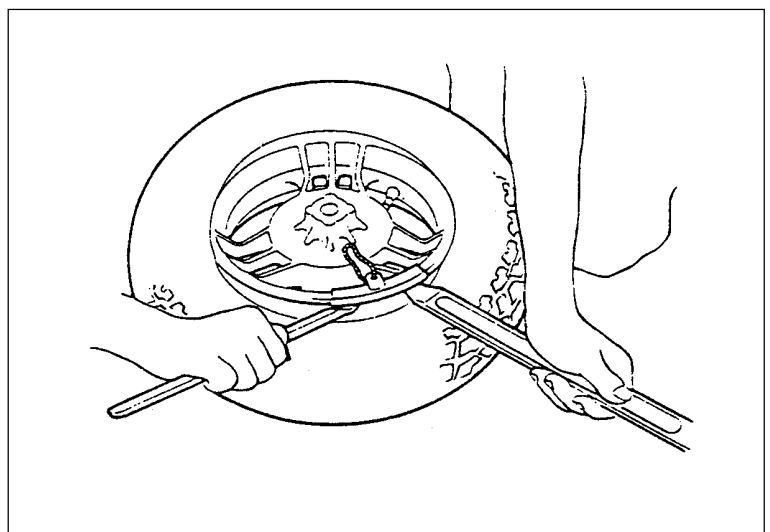
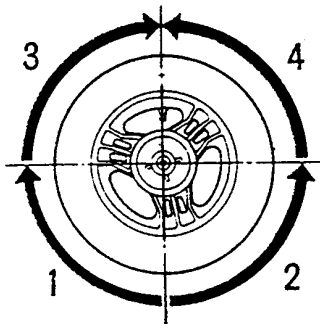



## 20. HIGH-SPEED TIRE

---

Install the rim protector and insert 2 tire irons at an interval of 30mm to install the tire bead into the rim. Press to hold the installed part of tire bead by knees.

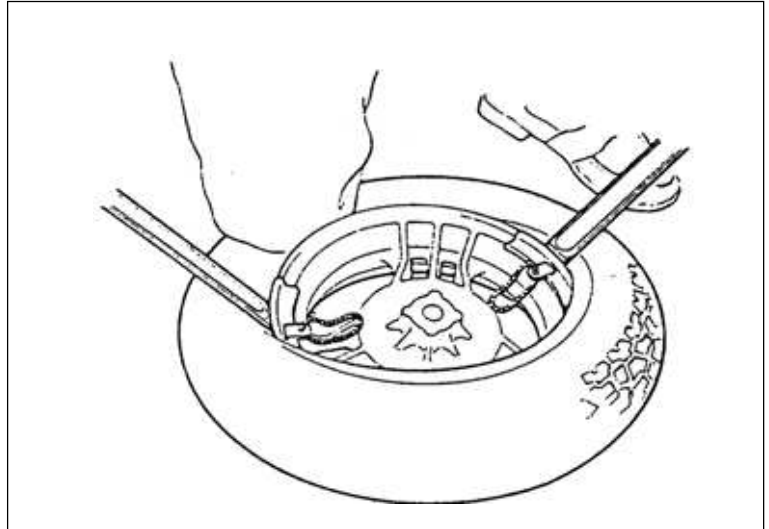

After 1/2 of tire bead is installed, insert 2 tire irons at an interval of 30 ~ 40mm to finish the installation in order.

- \* Both tire irons should be pulled out at the same time.
- \* The already installed part should be pressed.

The pulled-out tire iron should be inserted beside the other tire iron which hasn't been pulled out.

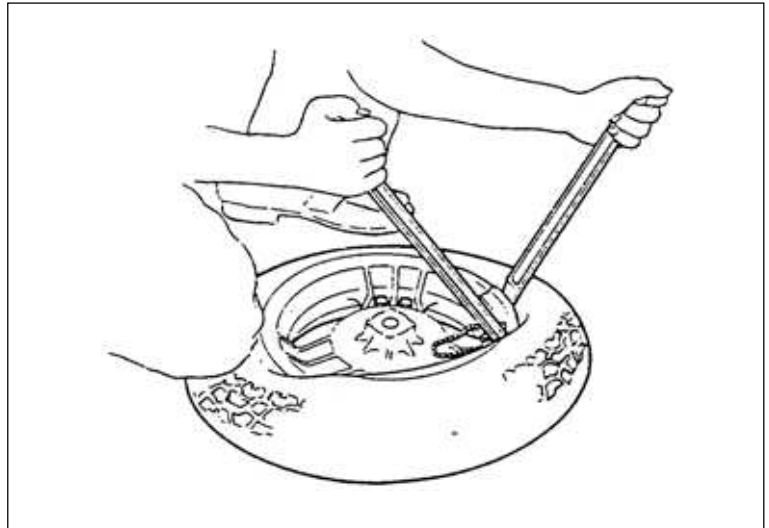

After 2/3 of the tire bead is installed into the rim, make sure if the installed tire bead is completely inserted into the rim groove.

- \* If the tire bead is not completely inserted into the rim groove, it will be more difficult to install the rest part of the tire bead. Moreover, the rim bead is easily damaged.

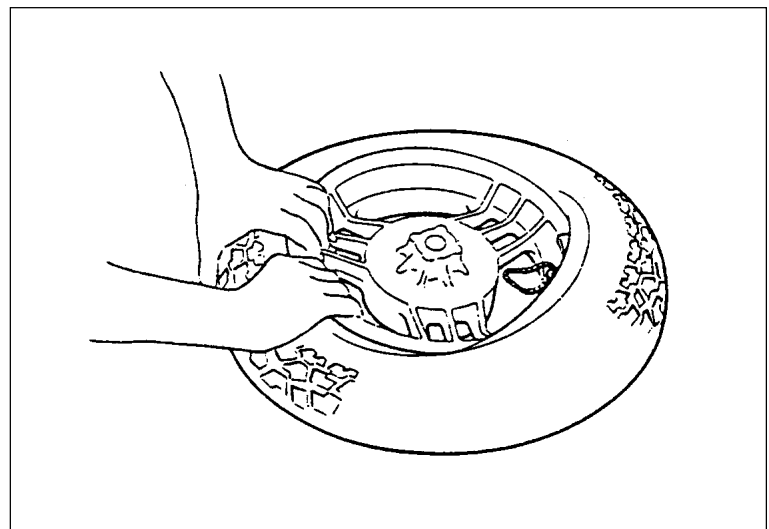

## 20. HIGH-SPEED TIRE

---

If 50~60mm of the tire bead is not installed, use 2 tire irons to install the rest part of tire bead.

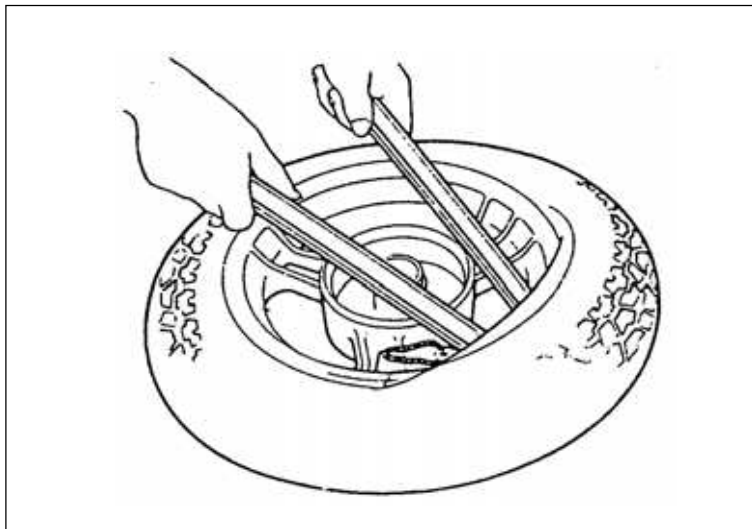

Use the valve core installer to install the valve core.

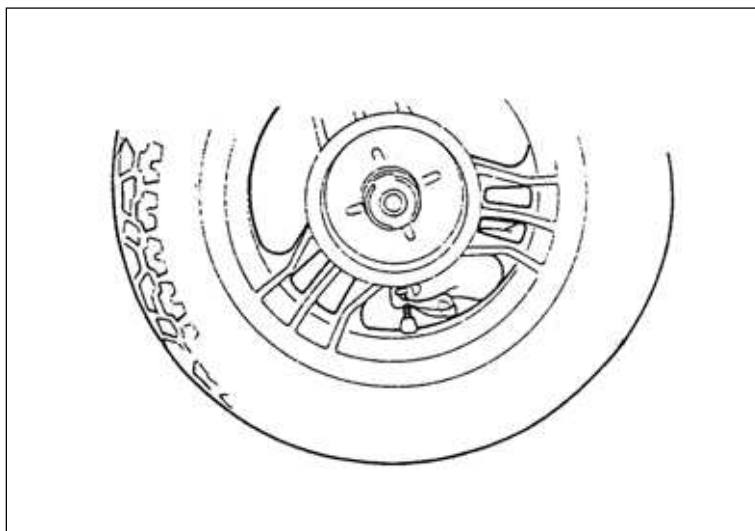

Apply vegetable soapy water to both sides of the tire bead.

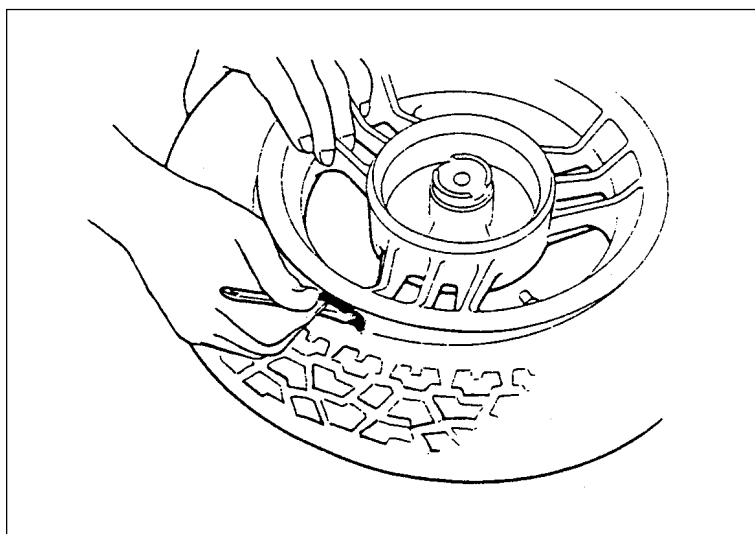

## 20. HIGH-SPEED TIRE

---

In order to ensure that the tire and the rim are well combined, raise the wheel and rotate it. Press around the tire by hand for several times to see if the tire is perfectly combined with the rim.

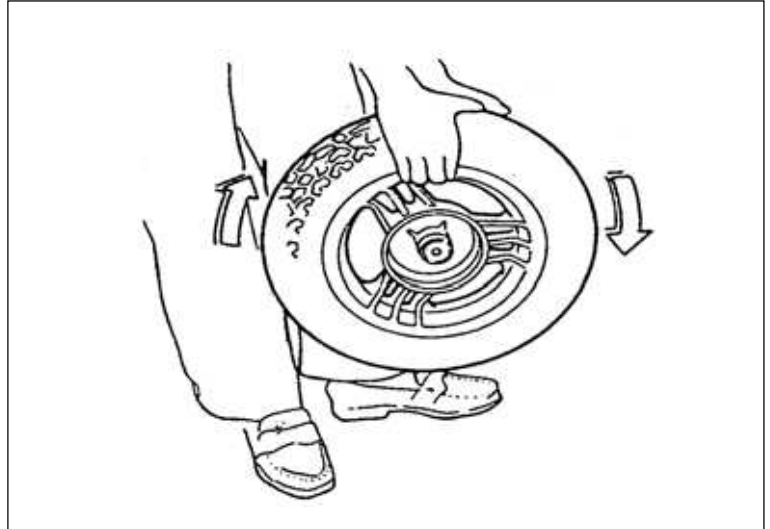

Pump the tire up to the specified tire pressure. If there is air leak between tire bead and rim after pumping, turn the valve down and press the upper side of the tire with hand to rotate the tire and pump the air in.

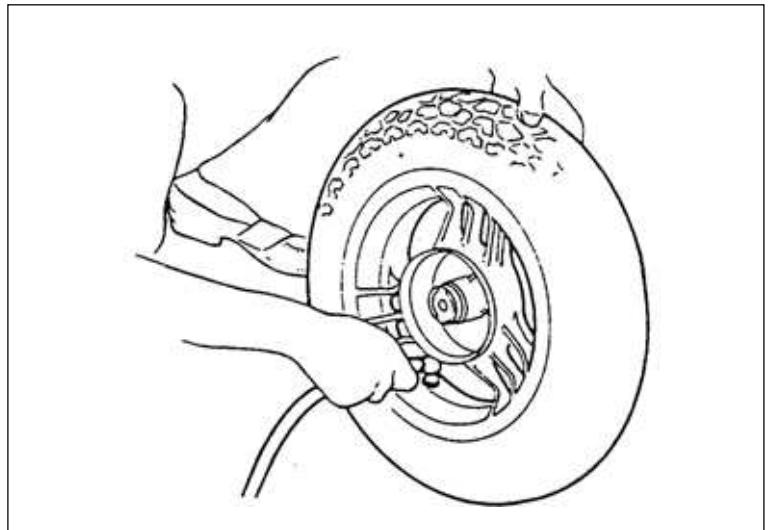

After pumping with specified air pressure, make sure if the tire bead is well installed into the rim.

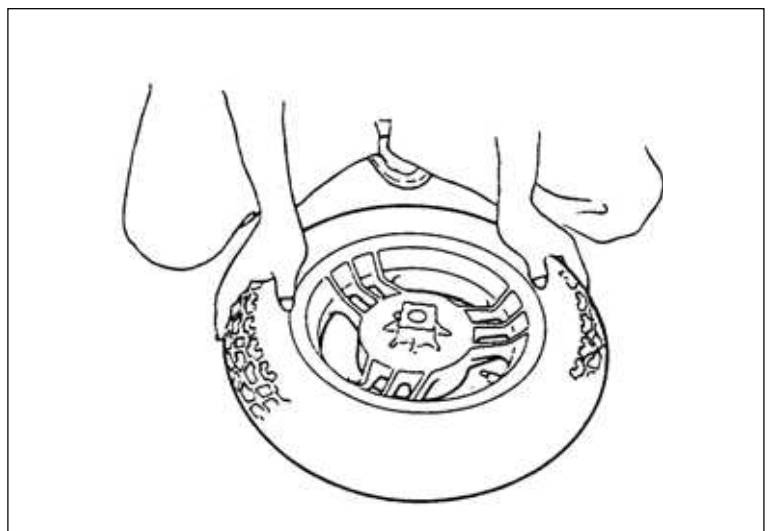

## 20. HIGH-SPEED TIRE

---

### HIGH-SPEED TIRE REPAIR

Repair the tire using the repair methods and repair agents recommended by the manufacturers.

### REPAIR PROCEDURES

- First remove the tire from the wheel.
- Find the crack and mark it.  
Take out foreign objects and check if the tire can be repaired.
- Tire repair  
Repair methods are divided into external and internal repairs.  
Perform the external repair first and then the internal repair.  
When repair agent is used, follow the instructions provided by the manufacturer.
- Remove dust and dirt from the tire bead.  
Clean out the tire inside. Recheck the repaired portion and make sure there is no other damage.
- Install the tire and wheel rim.

\*

- Check the rim valve when removing the tire and wheel rim.
- The gum on the repaired portion may not completely stick to the tire within 24 hours after repair, be careful to control the driving speed for safety.