

PREFACE

This Service Manual describes the technical features and servicing procedures for the **KYMCO X-Town 300 ABS**

Section 1 contains the precautions for all operations stated in this manual. Read them carefully before any operation is started.

Section 2 is the removal/installation procedures for the frame covers which are subject to removal/installation frequency during maintenance and servicing operations.

Section 3 describes the inspection/adjustment procedures, safety rules and service information for each part, starting from periodic maintenance.

Sections 5 to 12 give instructions for disassembly, assembly and adjustment of engine parts. Section 13 is the AFI system. Section 14 to 15 is the removal/ installation of chassis. Section 16 to 19 states the testing and measuring methods of electrical equipment.

Most sections start with an assembly or system illustration and troubleshooting for the section. The subsequent pages give detailed procedures for the section.

The information and contents included in this manual may be different from the motorcycle in case specifications are changed.

KWANG YANG MOTOR CO., LTD.
QUALITY TECHNOLOGY DEPT.
EDUCATION SECTION

TABLE OF CONTENTS

ENGINE	GENERAL INFORMATION	1
	EXHAUST MUFFLER/FRAME COVERS	2
	INSPECTION/ADJUSTMENT	3
	LUBRICATION SYSTEM	4
	ENGINE REMOVAL/INSTALLATION	5
	CYLINDER HEAD/VALVES	6
	CYLINDER/PISTON	7
	DRIVE AND DRIVEN PULLEYS/V-BELT	8
	FINAL REDUCTION	9
	A.C. GENERATOR/STARTER CLUTCH	10
	CRANKCASE/CRANKSHAFT	11
	COOLING SYSTEM	12
	FUEL INJECTION SYSTEM	13
CHASSIS	STEERING HANDLEBAR/FRONT WHEEL/FRONT BRAKE/FRONT SHOCK ABSORBER/FRONT FORK	14
	REAR BRAKE/REAR FORK/REAR WHEEL/REAR SHOCK ABSORBER`	15
ELECTRICAL EQUIPMENT	BATTERY/CHARGING SYSTEM	16
	IGNITION SYSTEM	17
	STARTING SYSTEM	18
	LIGHTS SWITCHES / FUEL PUMP	19
	EVAPORATIVE EMISSION CONTROL SYSTEM	20
ABS	ANTI-LOCK BRAKE SYSTEM	21

1. GENERAL INFORMATION



GENERAL INFORMATION

SERIAL NUMBER-----	1-1
SPECIFICATION -----	1-2
SERVICE PRECAUTIONS-----	1-5
TORQUE VALUES-----	1-9
SPECIAL TOOLS -----	1-10
LUBRICATION POINTS -----	1-11
CABLE & HARNESS ROUTING-----	1-13
TROUBLESHOOTING -----	1-14

1. GENERAL INFORMATION

SERIAL NUMBER

Location of Frame Serial Number
(inside luggage box)



Location of Vehicle Identification
Number (VIN)



Location of Engine Serial Number

1. GENERAL INFORMATION

SPECIFICATIONS

Name		X-Town 300 ABS
Model No.		KS60AB
Overall length		2250 mm
Overall width		800 mm
Overall height		1385 mm
Wheel base		1545 mm
Engine type		4 stroke O.H.C.
Displacement		275.6 cc
Fuel Used		92# nonleaded gasoline
Curb weight (kg)	Front wheel	78
	Rear wheel	117
	Total	195
Max. weight (kg)	Front wheel	125
	Rear wheel	220
	Total	345
Ground clearance (mm)		150
Braking distance (m)		7.9m / 40 km/hr
Min. turning radius (m)		2.6
Engine part		
Starting system		Starting motor
Type		Gasoline 4-cycle
Cylinder arrangement		Single cylinder
Combustion chamber type		Semi-sphere
Valve arrangement		O.H.C. 4V
Bore x stroke (mm)		72.7 * 66.4
Compression ratio		10.6:1
Compression pressure (kg/cm ² -rpm)		15
Max. output (kw/rpm)		17.05 / 8000
Max. torque (N.m/rpm)		22.5 / 6500
Intake Timing	Open	13° BTDC
	Close	38° BTDC
Exhaust Timing	Open	40° BTDC
	Close	3° BTDC
Valve clearance	Intake	0.1
	Exhaust	0.1
Idle speed (rpm)		1600±100 rpm
Cooling Type		Liquid cooling
Lubrication type		Forced pressure & wet sump
Oil pump type		Inner/outer rotor

Oil filter type		Full-flow filtration
Oil capacity		1.1 liter
Exchanging capacity		0.9 liter
Fi injection system		
Air cleaner type & No		Paper element, wet
Fuel capacity		13 liters
Brand		Keihin
Throttle Body		Butterfly type
Venturi diameter (mm)		32
Fuel pump pressure		3.0 bar
Electrical system		
Ignition type		ECU
Ignition timing		10° BTDC / idle 33° / 6500min
Spark plug		DPR6EA-9
Spark plug gap		0.8~0.9mm
Battery Capacity		12V12AH
Transmission system		
Clutch type		Dry multi-disc
Transmission type		CVT
Operation type		Auto centrifugal
Reduction gear type		Two-stage reduction
Reduction ratio	1 st	1
	2 nd	7.3
Moving device		
Tire type		Tubeless
Tire spec.	Front wheel	120/80-14 58S
	Rear wheel	150/70-13 64S
Tire pressure (kg/cm ²)	Front wheel	2.0
	Rear wheel	2.25
Wheel material		Aluminium
Turning angle	Left	40°
	Right	40°
Brake type	Front	ABS
	Rear	ABS
Damping Device		
Suspension type	Front	Telescope
	Rear	Swing arm
Shock absorber stroke	Front	110 mm
	Rear	100 mm

1. GENERAL INFORMATION

SERVICE PRECAUTIONS

- Make sure to install new gaskets, O-rings, circlips, cotter pins, etc. when reassembling.

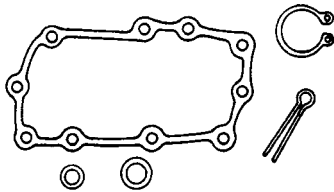

- When tightening bolts or nuts, begin with larger-diameter to smaller ones at several times, and tighten to the specified torque diagonally.

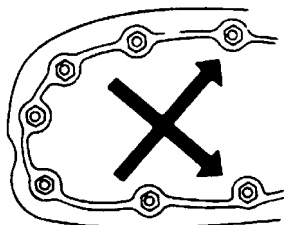

- Use genuine parts and lubricants.

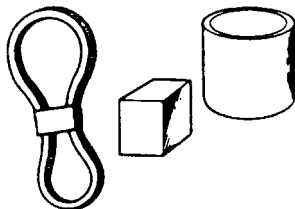

- When servicing the motorcycle, be sure to use special tools for removal and installation.



- After disassembly, clean removed parts. Lubricate sliding surfaces with engine oil before reassembly.

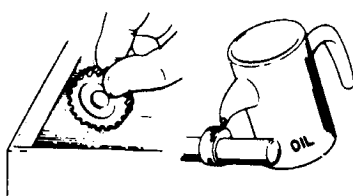

- Apply or add designated greases and lubricants to the specified lubrication points.

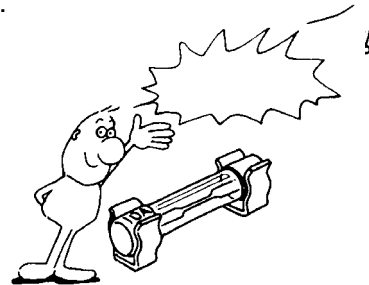

- When two persons work together, pay attention to the mutual working safety.

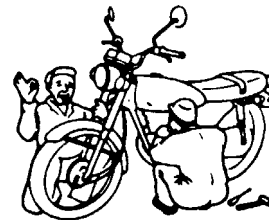

- Disconnect the battery negative (-) terminal before operation.
- When using a spanner or other tools, make sure not to damage the motorcycle surface.

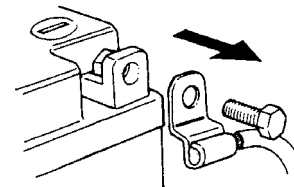

- After operation, check all connecting points, fasteners, and lines for proper connection and installation.
- When connecting the battery, the positive (+) terminal must be connected first.
- After connection, apply grease to the battery terminals.
- Terminal caps shall be installed securely.

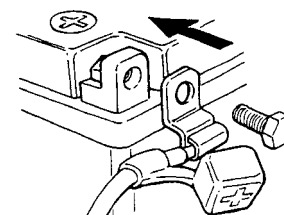

- If the fuse is burned out, find the cause and repair it. Replace it with a new one according to the specified capacity.

1. GENERAL INFORMATION

- After operation, terminal caps shall be installed securely.

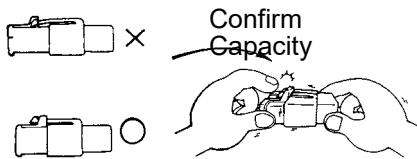

- When taking out the connector, the lock on the connector shall be released before operation.

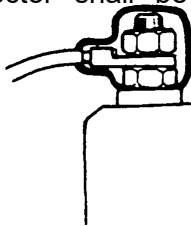

- Hold the connector body when connecting or disconnecting it.
- Do not pull the connector wire.

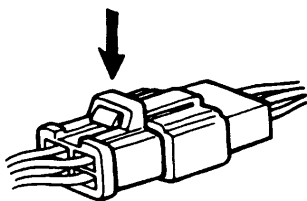

- Check if any connector terminal is bending, protruding or loose.

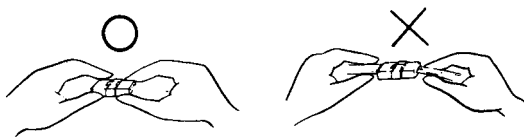

- The connector shall be inserted completely.
- If the double connector has a lock, lock it at the correct position.
- Check if there is any loose wire.

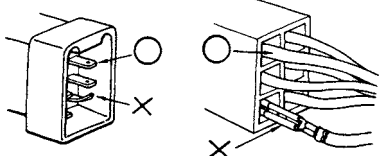

- Before connecting a terminal, check for damaged terminal cover or loose negative terminal.

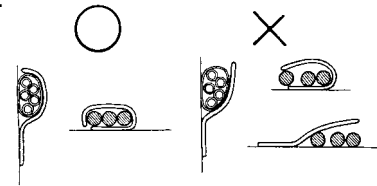

- Check the double connector cover for proper coverage and installation.

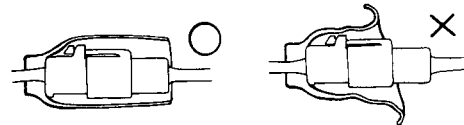

- Insert the terminal completely.
- Check the terminal cover for proper coverage.
- Do not make the terminal cover opening face up.

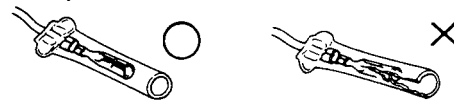

- Secure wire harnesses to the frame with their respective wire bands at the designated locations. Tighten the bands so that only the insulated surfaces contact the wire harnesses.

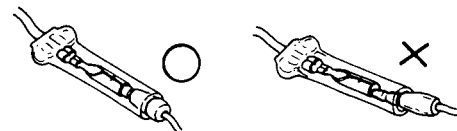

- After clamping, check each wire to make sure it is secure.

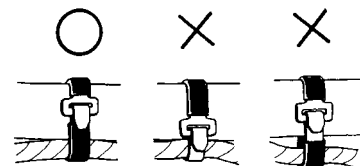

1. GENERAL INFORMATION

- Do not squeeze wires against the weld or its clamp.

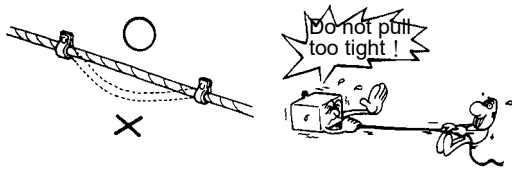

- After clamping, check each harness to make sure that it is not interfering with any moving or sliding parts.

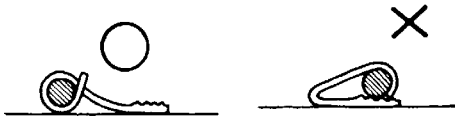

- When fixing the wire harnesses, do not make it contact the parts that will generate high heat.

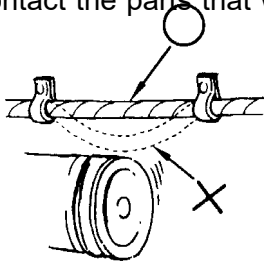

- Route wire harnesses to avoid sharp edges or corners. Avoid the projected ends of bolts and screws.
- Route wire harnesses passing through the side of bolts and screws. Avoid the projected ends of bolts and screws.

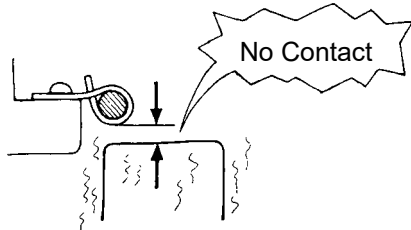

- Route harnesses so they are neither pulled tight nor have excessive slack.

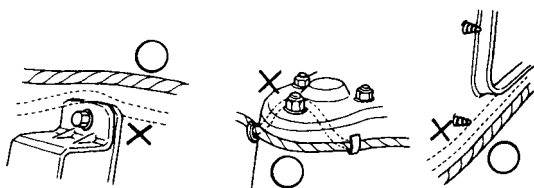

- Protect wires and harnesses with electrical tape or tube if they contact a sharp edge or corner.

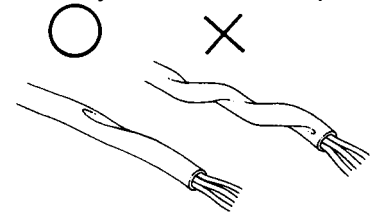

- When rubber protector cover is used to protect the wire harnesses, it shall be installed securely.

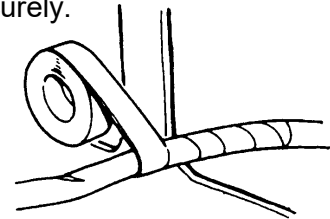

- Do not break the sheath of wire.
- If a wire or harness is with a broken sheath, repair by wrapping it with protective tape or replace it.

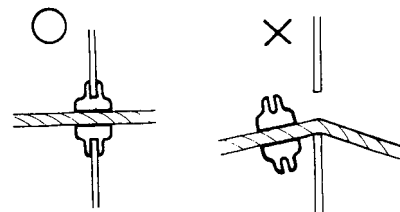

- When installing other parts, do not press or squeeze the wires.

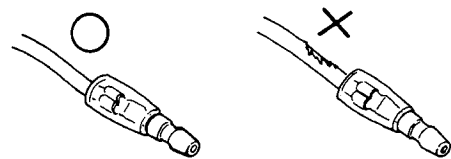

- After routing, check that the wire harnesses are not twisted or kinked.

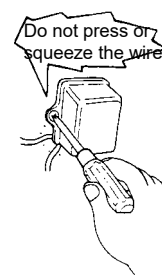

1. GENERAL INFORMATION

- Wire harnesses routed along with handlebar should not be pulled tight, have excessive slack or interfere with adjacent or surrounding parts in all steering positions.

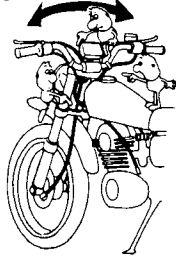

- When a testing device is used, make sure to understand the operating methods thoroughly and operate according to the operating instructions.

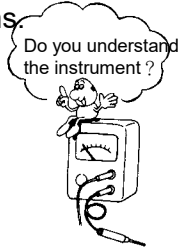

- Be careful not to drop any parts.

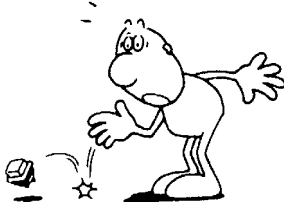

- When rust is found on a terminal, remove the rust with sand paper or equivalent before connecting.

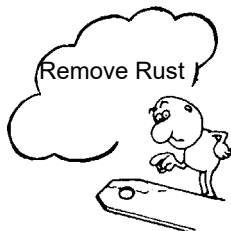

1. GENERAL INFORMATION

■ Symbols:

The following symbols represent the servicing methods and cautions included in this service manual.



: Apply engine oil to the specified points. (Use designated engine oil for lubrication.)



: Apply grease for lubrication.



: Transmission Gear Oil (90#)



: Use special tool.



: Caution



: Warning

1. GENERAL INFORMATION

TORQUE VALUES

STANDARD TORQUE VALUES

Item	Torque (kgf-m)	Item	Torque (kgf-m)
5mm bolt, nut	0.45~0.6	5mm screw	0.45~0.6
6mm bolt, nut	0.8~1.2	6mm screw, SH bolt	0.7~1.1
8mm bolt, nut	1.8~2.5	6mm flange bolt, nut	1.0~1.4
10mm bolt, nut	3.0~4.0	8mm flange bolt, nut	2.4~3.0
12mm bolt, nut	5.0~6.0	10mm flange bolt, nut	3.0~4.5

ENGINE

Item	Qty	Thread size (mm)	Torque (kgf-m)	Remarks
Cylinder head stud bolt:				
1.Stud bolt (Inlet pipe side)	2	6	0.7~1.1	Double end bolt
2.Stud bolt (EX pipe side)	2	8	0.7~1.1	Double end bolt
Cylinder head stud nut	4	10	3.4~3.8	
Right crankcase cover bolt	15	6	1.0~1.4	
Left crankcase cover bolt	15	6	1.0~1.4	
Bolt B stud 10*180	4	10	1.0~1.4	Apply oil to thread
Valve adjusting lock nut	4	5	0.7~1.1	Apply oil to thread
Cam sprocket bolt	2	6	1.0~1.4	
Transmission oil check/drain bolt	2	8	0.8~1.2	
Engine oil drain bolt	1	12	2.0~3.0	
Clutch outer nut	1	12	5.0~6.0	
Starter motor mounting bolt	2	6	1.0~1.4	
Mission case bolt	6	8	1.8~2.2	
Drive face nut	1	14	9.0~10.0	Apply oil to thread
Drive plate comp	1	28	5.0~6.0	
Cam chain tensioner bolt	2	6	1.0~1.4	
Cam chain tensioner pivot	1	8	0.8~1.2	
Oneway clutch bolt	3	8	1.8~2.2	Apply thread lock
ACG flywheel nut	1	14	5.5~6.5	
Spark plug	1	12	1.5~2.0	
Water pump impeller	1	7	1.0~1.4	Left thread

1. GENERAL INFORMATION

TORQUE VALUES FRAME

Item	Qty	Thread size (mm)	Torque (kgf-m)	Remarks
Steering:				
1.Stem lock nut	1	BC1	6.0~8.0	
2.Handle post bolt	1	10	4.0~5.0	U - nut
3.Bridge bolt	1	8	2.4~3.0	
4.Race nut (head)	1	BC1	1.8~2.2	
Brake:				
1.Front/Rear caliper bolt	1	10	3.0~4.0	
2.Brake hose bolt	1	10	3.0~4.0	
3.Disk bolt	5	8	3.2~3.8	
Engine hanger:				
1.Fram side	2	14	6.0~7.0	U - nut
2.Engine side	1	10	4.5~5.5	U - nut
Rear fork bolt	2	10	3.0~4.0	
Speed sensor cable	1	6	1.0~1.4	
O2 sensor	1	12	2.0~3.0	
Rear carrier	4	8	2.0~2.8	
Front axle nut	1	14	1.5~2.5	
Rear axle nut	1	16	11~13	U - nut
Rear cushion upper/lower bolt	1	10	3.5~4.5	

1. GENERAL INFORMATION

SPECIAL TOOLS

Tool Name	Tool No.	Remarks	Ref. Page
Flywheel puller	E003	A.C. generator flywheel removal	4.10
Tappet adjuster	E012	Tapper adjustment	3.7
Oil seal & bearing installer	E014	Oil seal & bearing install	9.10.11
Flywheel holder	E021	A.C. generator flywheel holding	4.10
Clutch spring compressor	E053	Clutch disassembly	9
#41 Nut & Fitting	E028	Clutch disassembly	9
Thread protector	E029	Protect the crankshaft's thread	10
Bearing puller 10,12,15,18mm	E037	Bearing removal	10
Valve cotter installer	E051	Valve cotter installation	7
Lock nut socket wrench	F002	Steering stem removal or install	12

1. GENERAL INFORMATION

LUBRICATION POINTS

FRAME

The following is the lubrication points for the frame.

Use grease for parts not listed.

Apply engine oil or grease to cables and movable parts not specified. It will avoid abnormal noise and damage the durability of the motorcycle.



1. GENERAL INFORMATION

CABLE & HARNESS ROUTING

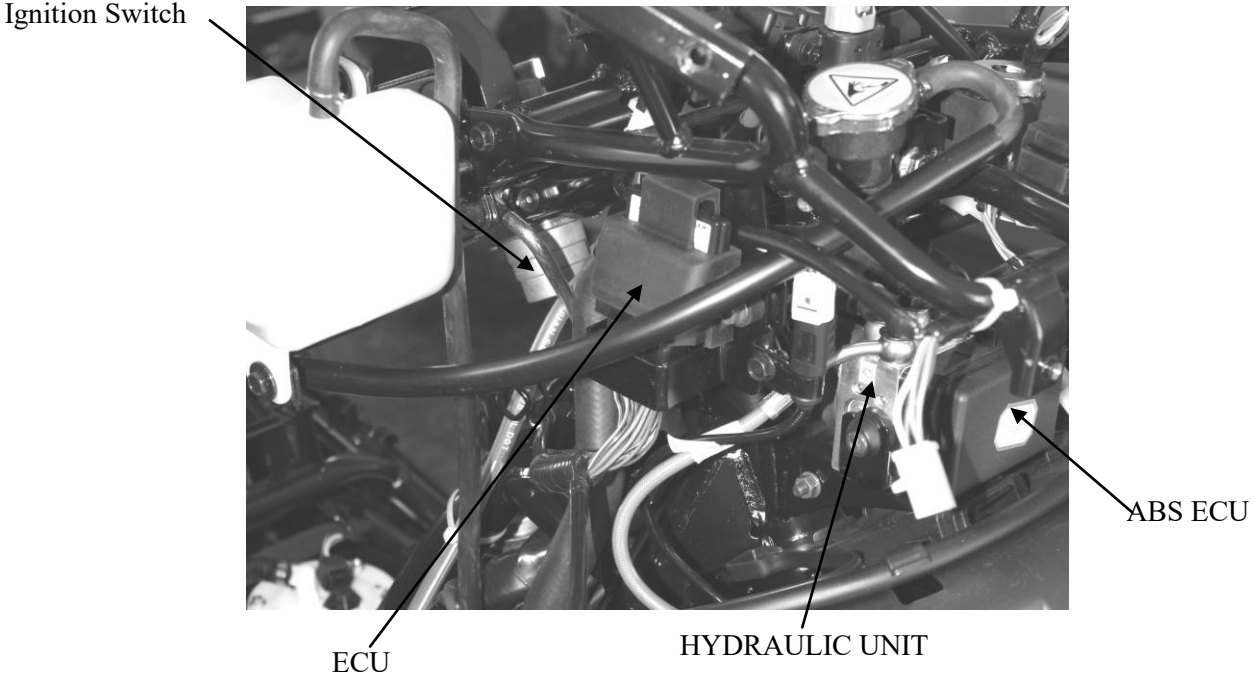
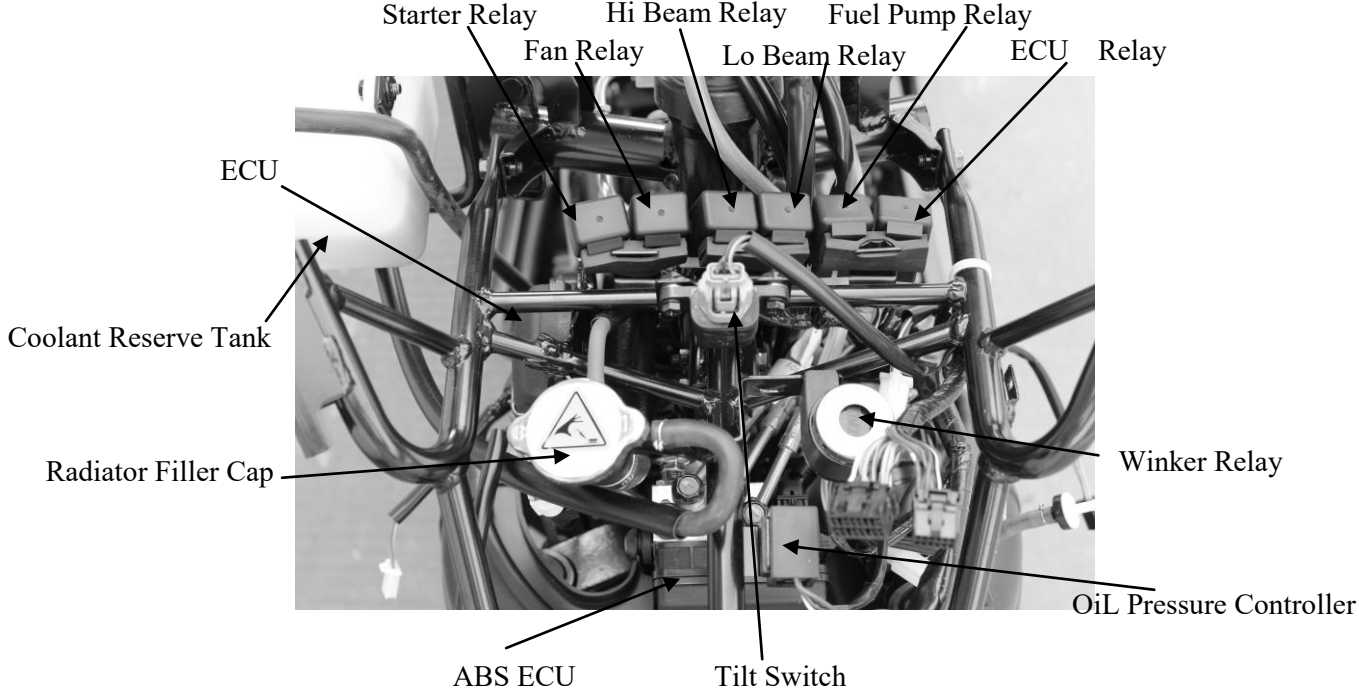

1. GENERAL INFORMATION

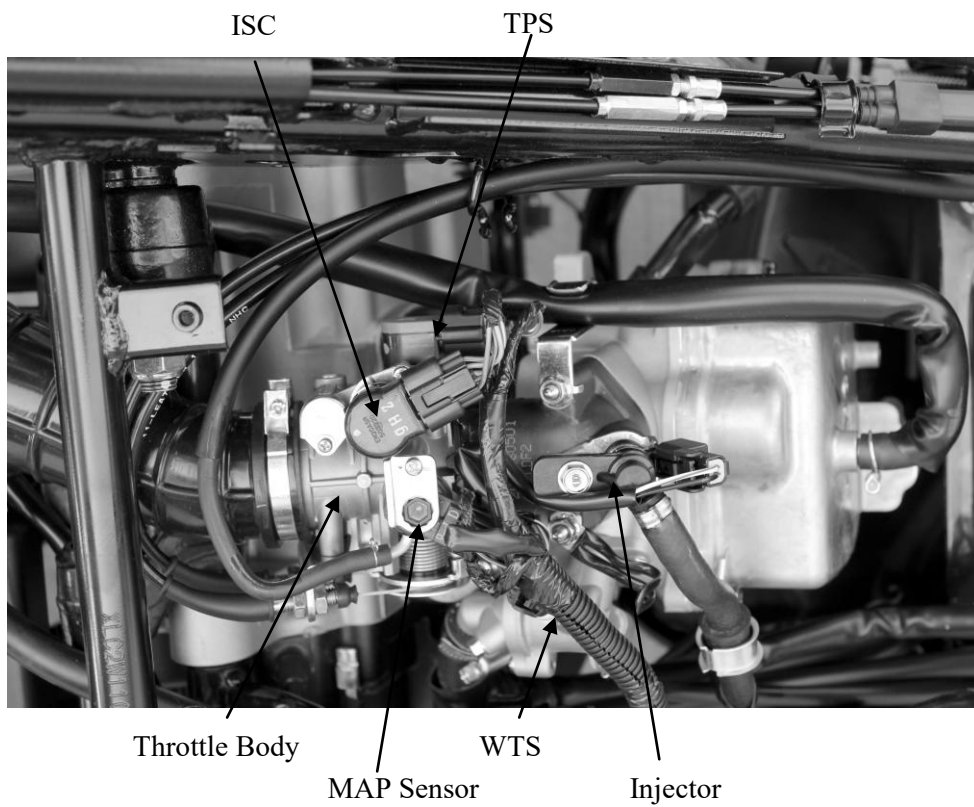

1. GENERAL INFORMATION

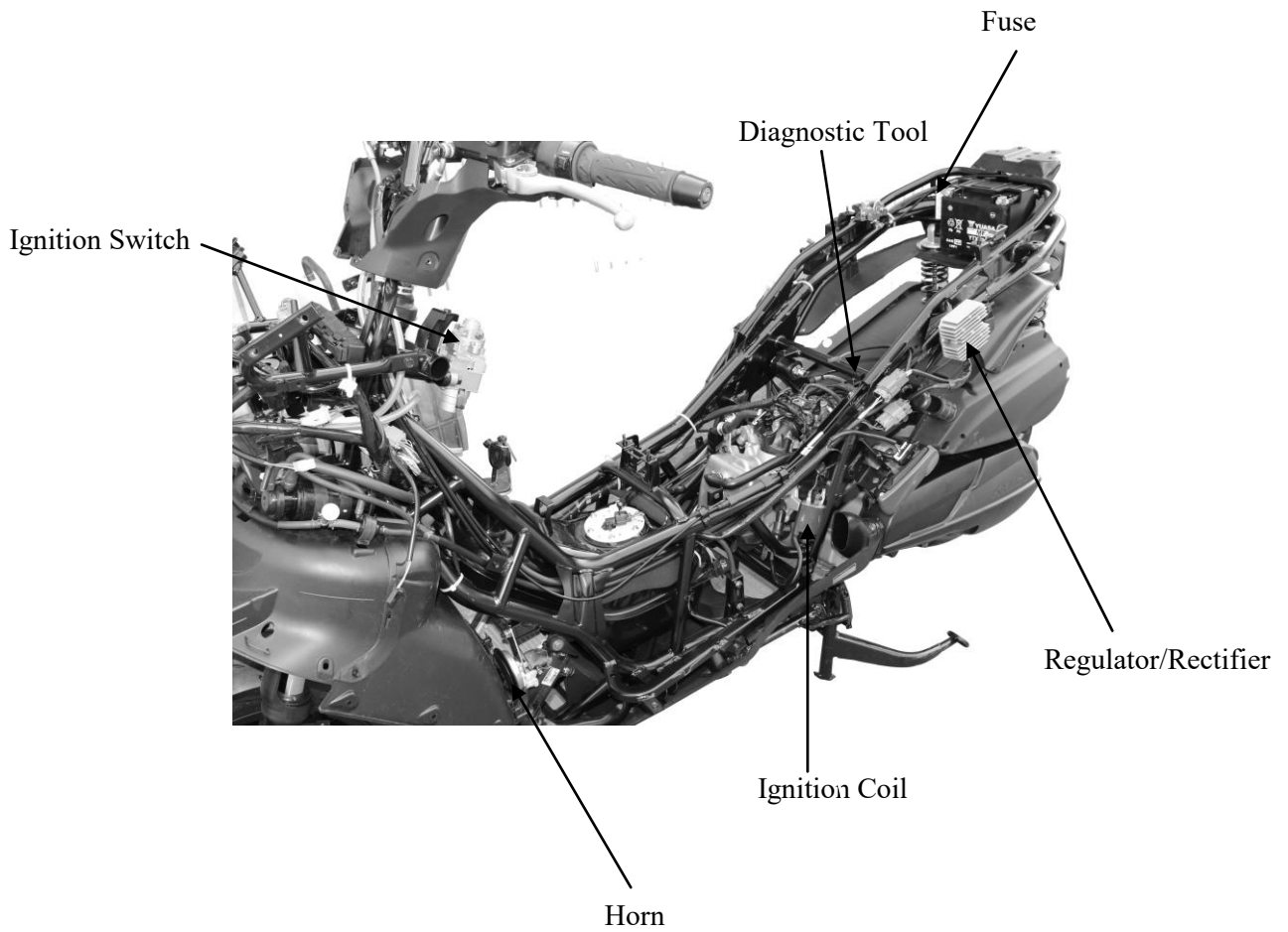

1. GENERAL INFORMATION

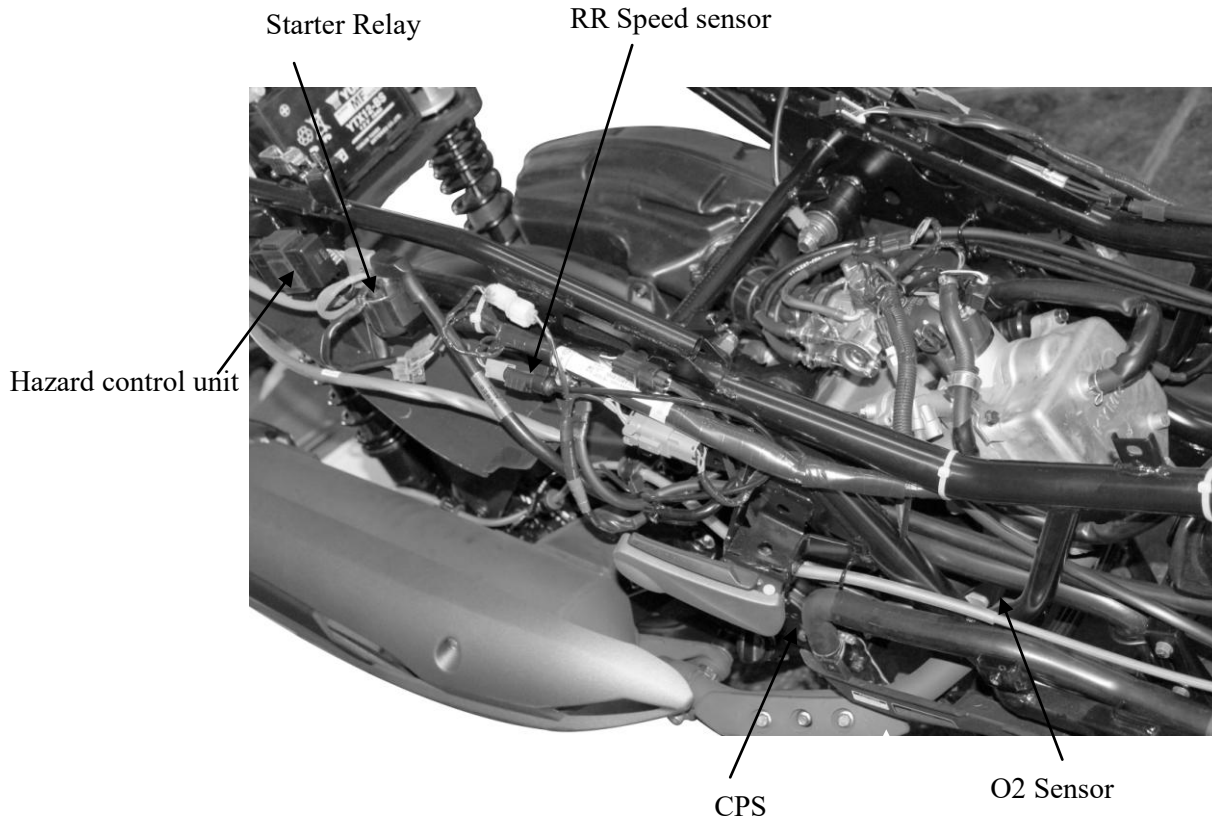

1. GENERAL INFORMATION

TROUBLESHOOTING

ENGINE WILL NOT START OR IS HARD TO START

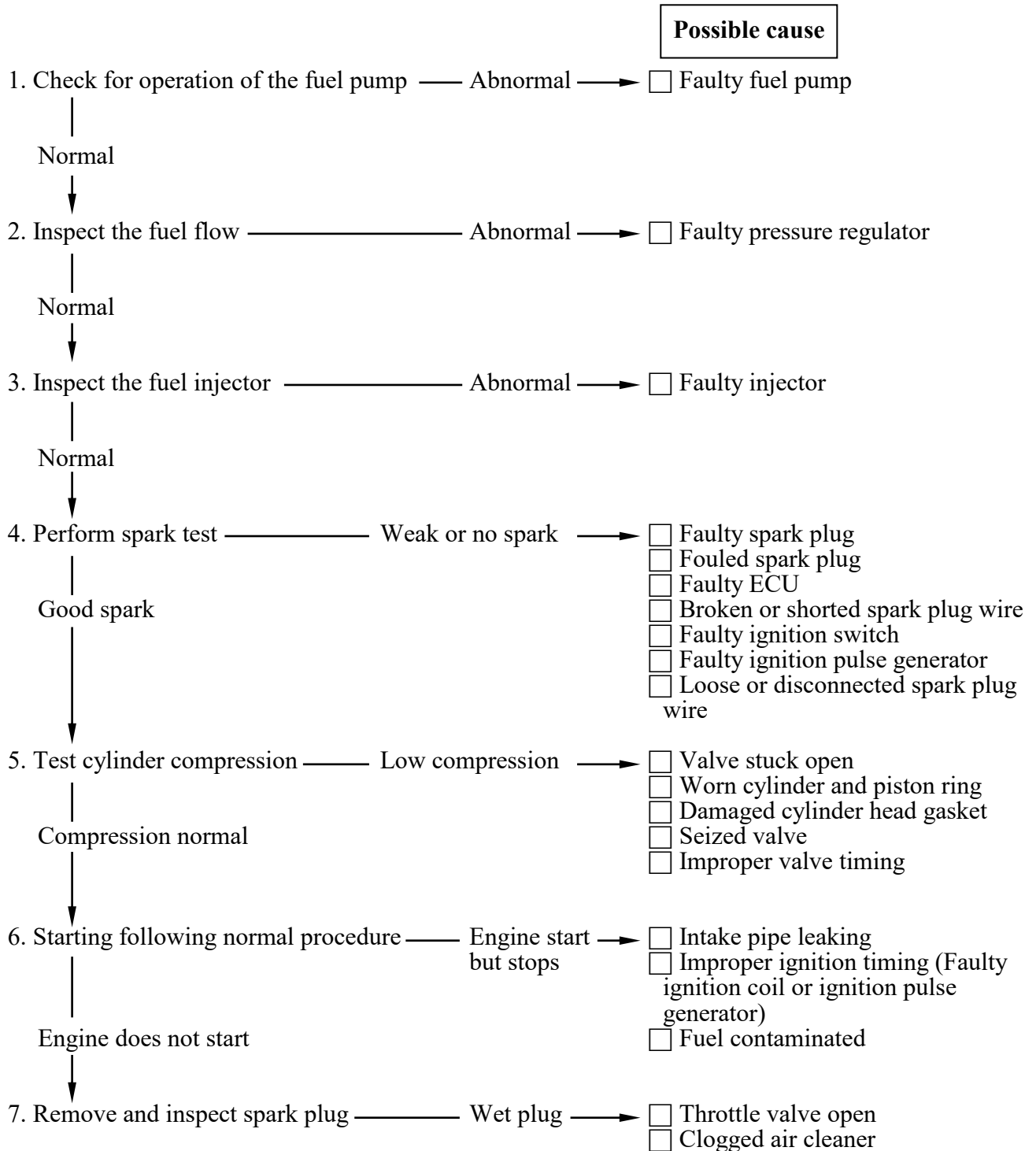

1. GENERAL INFORMATION

ENGINE LACKS POWER

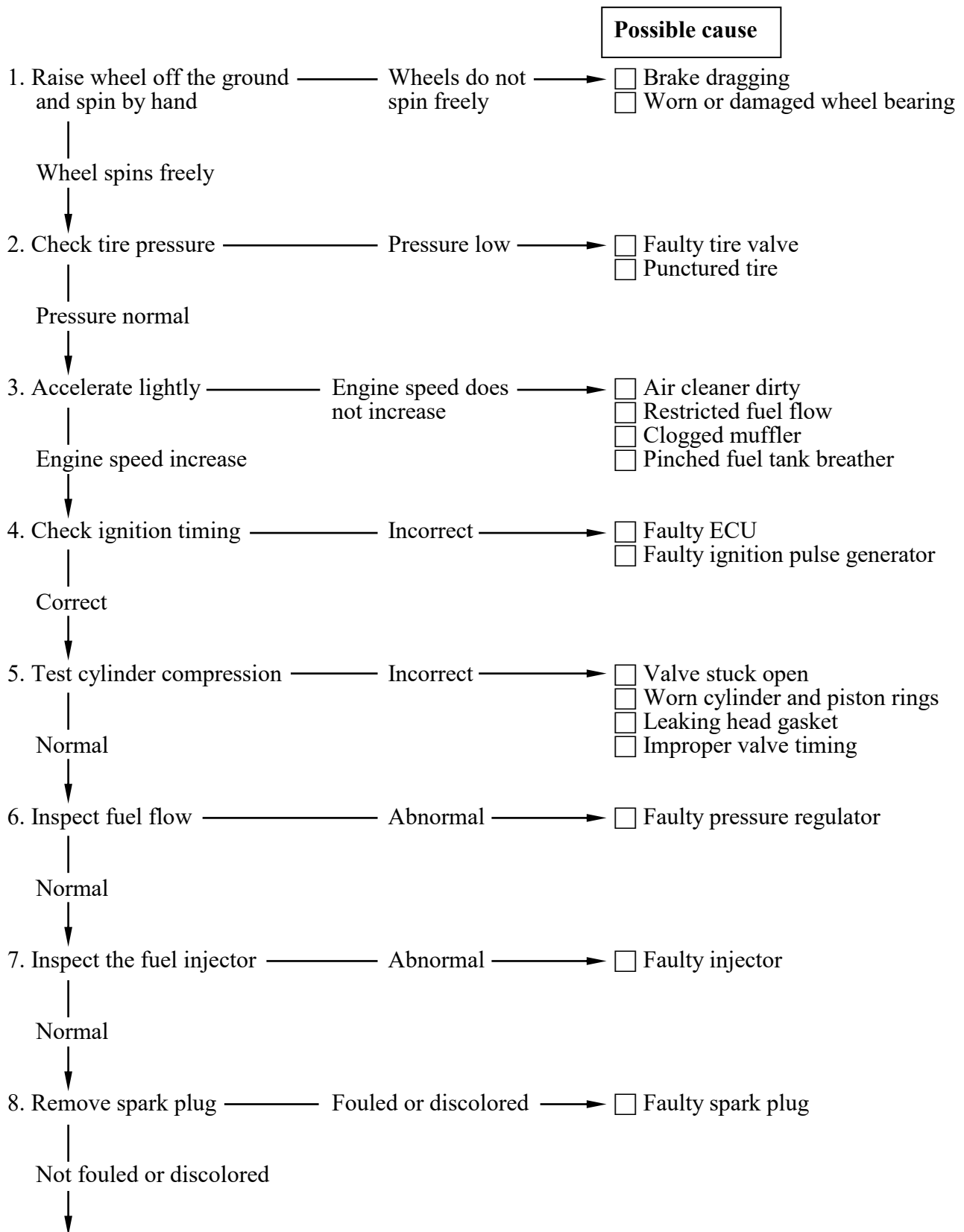

1. GENERAL INFORMATION

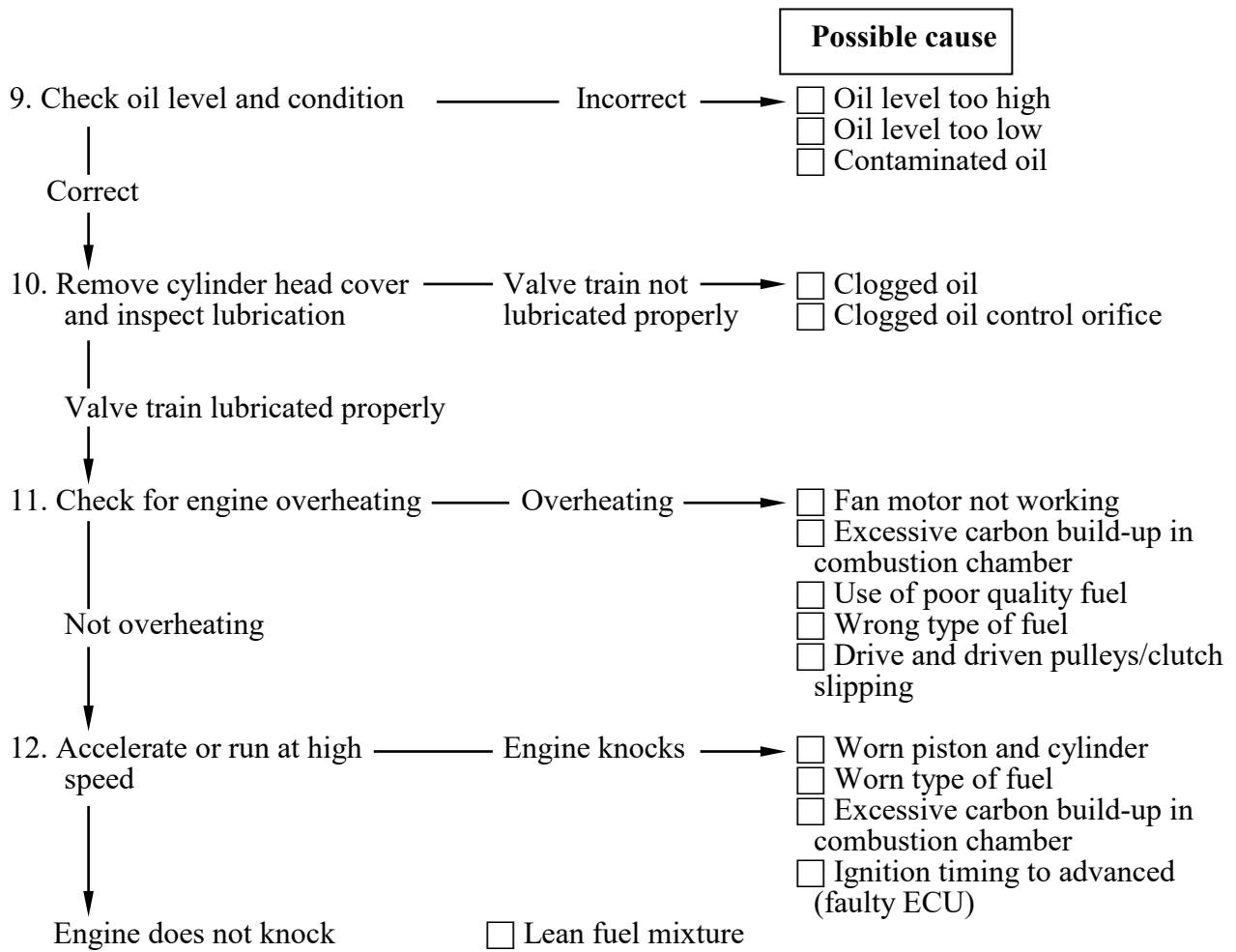

1. GENERAL INFORMATION

POOR PERFORMANCE AT LOW AND IDLE SPEED

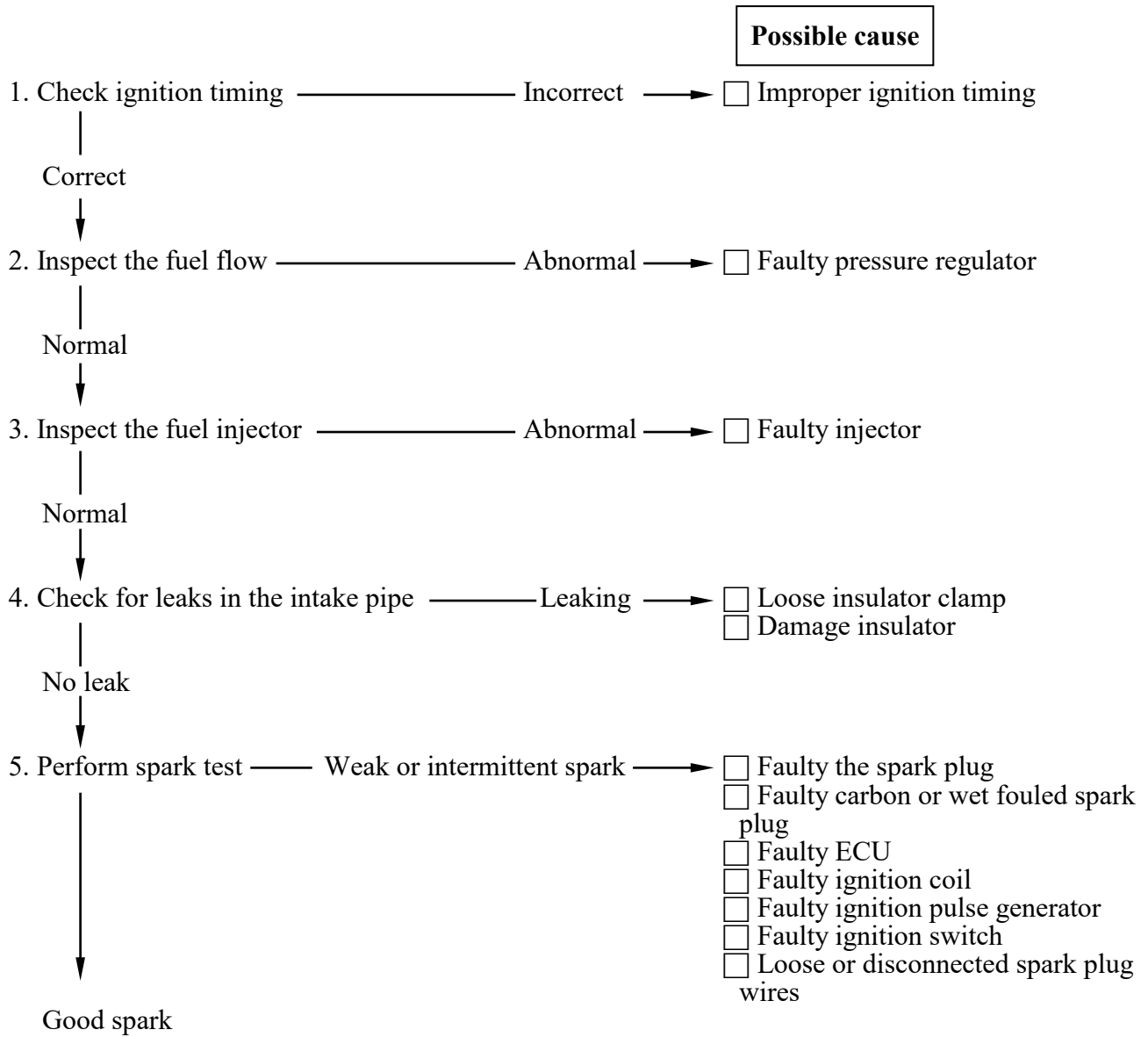

1. GENERAL INFORMATION

POOR PERFORMANCE AT HIGH SPEED

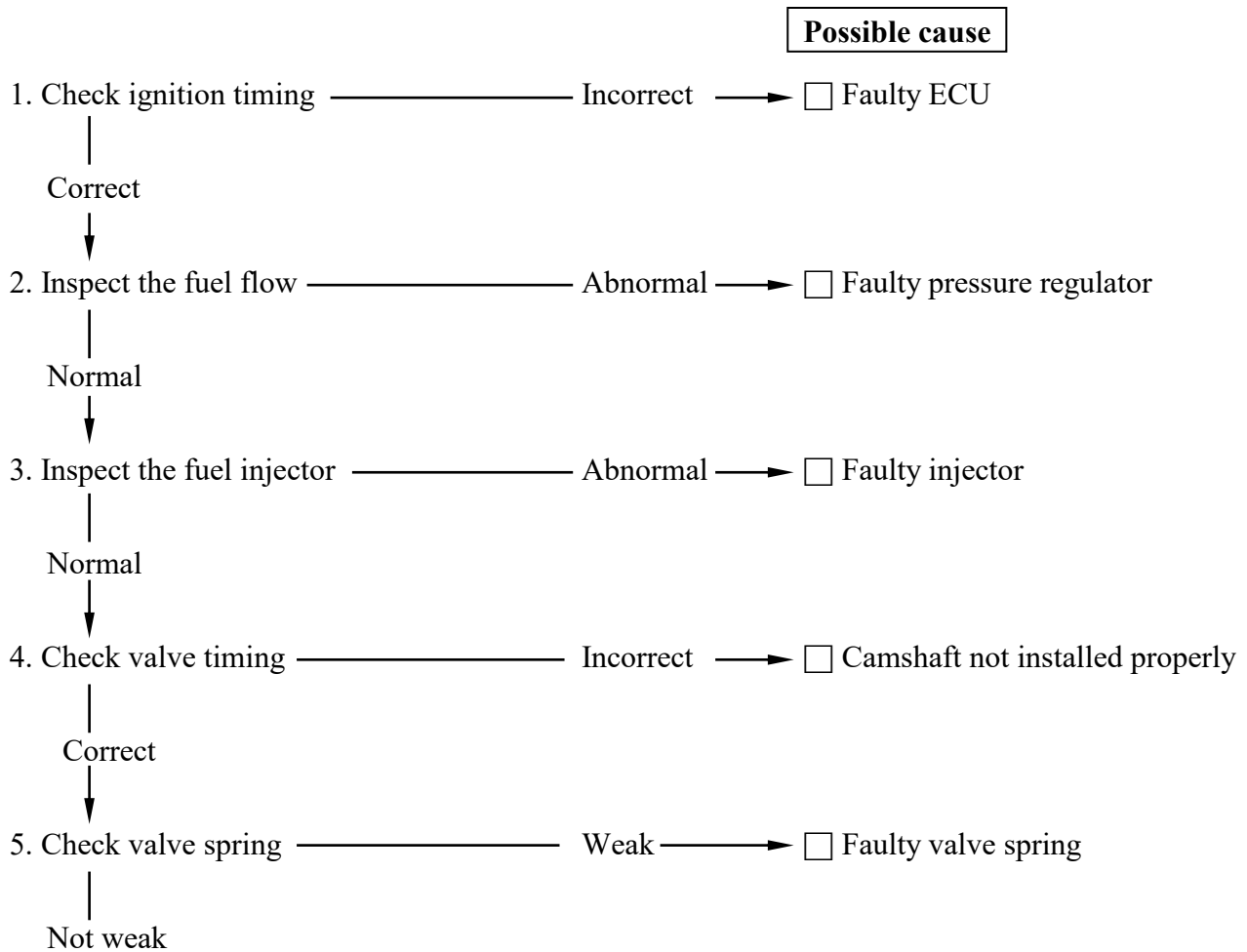

POOR HANDLING

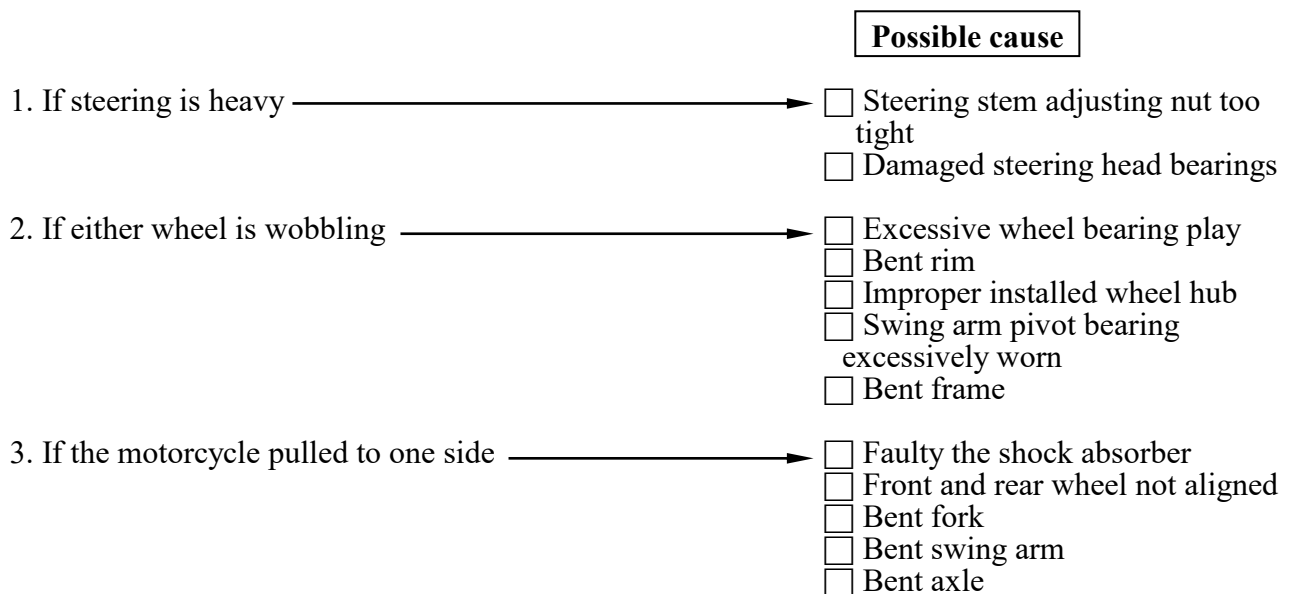

2. EXHAUST MUFFLER/FRAME COVERS

EXHAUST MUFFLER/FRAME COVERS

SERVICE INFORMATION-----	2- 1
TROUBLESHOOTING-----	2- 1
FASTENER REMOVAL AND REINSTALLATION-----	2- 2
FRAME COVERS REMOVAL/INSTALLATION-----	2- 3
EXHAUST MUFFLER -----	2-14

2. EXHAUST MUFFLER/FRAME COVERS

SERVICE INFORMATION

GENERAL INSTRUCTIONS

- When removing frame covers, use care not to pull them by force because the cover joint claws may be damaged.
- Make sure to route cables and harnesses according to the Cable & Harness Routing.

TORQUE VALUES

Exhaust muffler pipe nuts	1.8~2.2 kgf-m
Exhaust muffler brake /RR Fork	3.2~3.8 kgf-m
RR fork/Engine case	3.0~4.0 kgf-m

TROUBLESHOOTING

Noisy exhaust muffler

- Damaged exhaust muffler
- Exhaust muffler joint air leaks

Lack of power

- Caved exhaust muffler
- Clogged exhaust muffler
- Exhaust muffler air leaks

2. EXHAUST MUFFLER/FRAME COVERS

FASTENER REMOVAL AND REINSTALLATION

REMOVAL

Depress the head of fastener center piece .
Pull out the fastener.

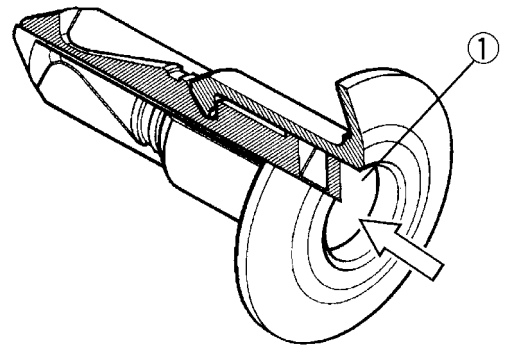

INSTALLATION

Let the center piece stick out toward the head so that the pawls  close.
Insert the fastener into the installation hole.

* To prevent the pawl  from damage, insert the fastener all the way into the installation hole

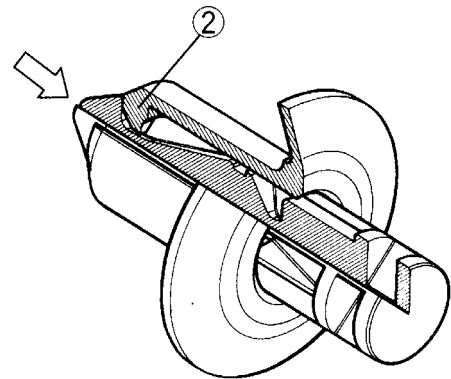

Push in the head of center piece until it becomes flush with the fastener outside face.

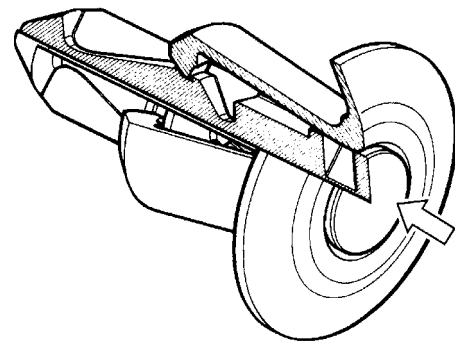

2. EXHAUST MUFFLER/FRAME COVERS

FRAME COVERS REMOVAL/ INSTALLATION

SEAT

Unlock the seat with the ignition key.
Open the seat.
Remove the two nuts and seat damper unit.
Remove the two nuts and the seat.

Installation is in the reverse order of removal.



LUGGAGE BOX

Unlock the seat with the ignition key.
Open the seat.

Remove two bolts, and two nuts then lift
luggage box.

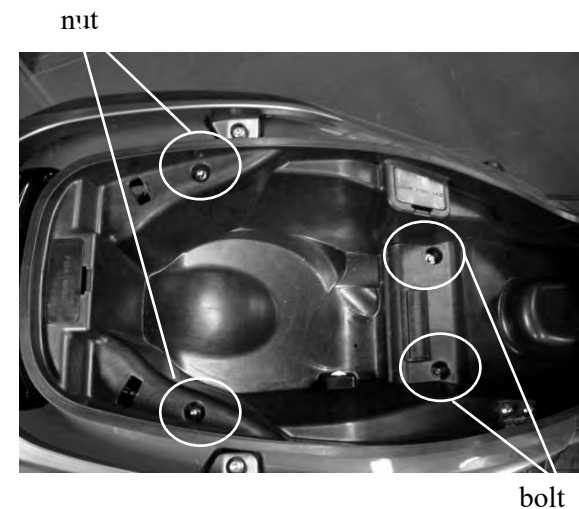

Disconnect the luggage box light connector,
then remove the luggage box.

Installation is in the reverse order of removal.



2. EXHAUST MUFFLER/FRAME COVERS

CENTER COVER

Remove the luggage box.

Remove the center cover.

* During removal, do not pull the joint claws forcedly to avoid damage.

Installation is in the reverse order of removal.

Center Cover

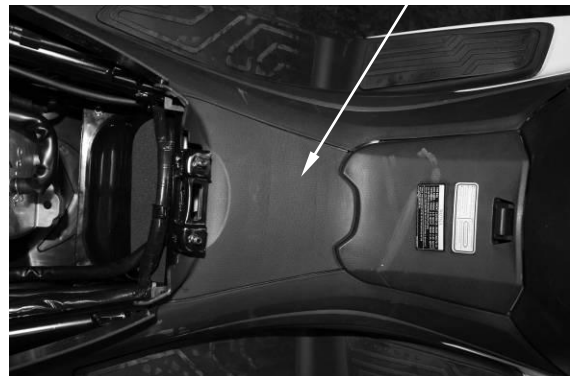

Remove the fuel tank cover by pushing the tank cover downward

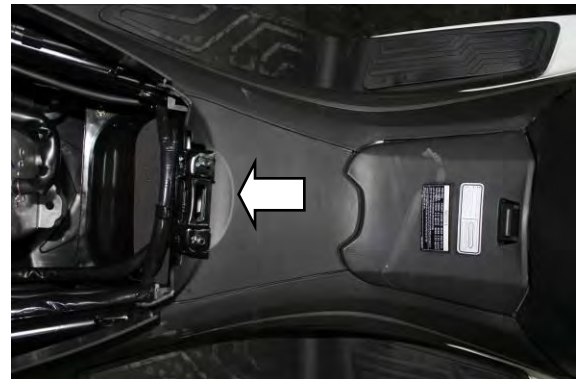

Rear carrier Cover

REAR CARRIER.

Remove two fasteners and then remove the rear carrier cover



Remove four bolts and then remove the rear carrier.



2. EXHAUST MUFFLER/FRAME COVERS

Installation is in the reverse order of removal.

BODY COVER

Remove the seat and luggage box(2-3)
Remove the rear carrier cover(2-4).
Remove the rear carrier(2-4).

Remove two fasteners and then remove the rear center cover



Rear Center Cover



Remove two nuts

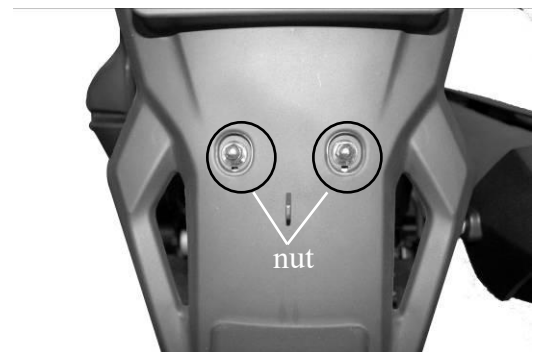

Remove two bolts and two fasteners



2. EXHAUST MUFFLER/FRAME COVERS

Disconnect the taillight connector,
then remove the body cover.

Installation is in the reverse order of removal.



UPPER/LOWER HANDLEBAR COVER

Remove the four screws and then remove
upper handlebar cover.



Remove the two screws, then remove the
bottom handlebar cover.

Disconnect the throttle cable refer to the
“**THROTTLE BODY /TPS**” section, then
pull the throttle cable out from the lower
cover. Remove the lower cover.

Installation is in the reverse order of removal.



2. EXHAUST MUFFLER/FRAME COVERS

WINDSHIELD/WINDSHIELD GARNISH

Remove five bolts and windshield garnish.



FRONT CENTER COVER

Remove the windshield
 Remove two screws and fastener then remove the front center cover.
 Remove the front cover.
 Installation is in the reverse order of removal

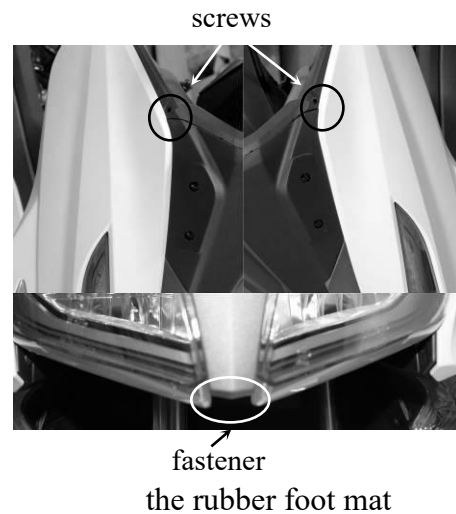

RIGHT/LEFT FOOT SKIRT

- ① Pull the rubber foot mat off
- ② Remove the 6 screws attaching to the right or left skirt.
- ③ Remove the 6 fastener under the body
- ④ Remove the foot skirt

* During removal, do not pull the joint claws forcedly to avoid damage.

Installation is in the reverse order of removal.



2. EXHAUST MUFFLER/FRAME COVERS

FRONT COVER

Remove two bolts.



Remove fourteen screws from the inner cover.



Remove ten fastener from the cowl under.

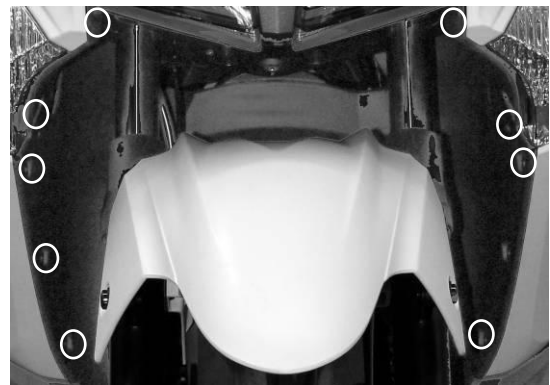

Disconnect the headlight/position light connector and right/left turn signal light connectors.



2. EXHAUST MUFFLER/FRAME COVERS

Remove the front cover

Installation is in the reverse order of removal.

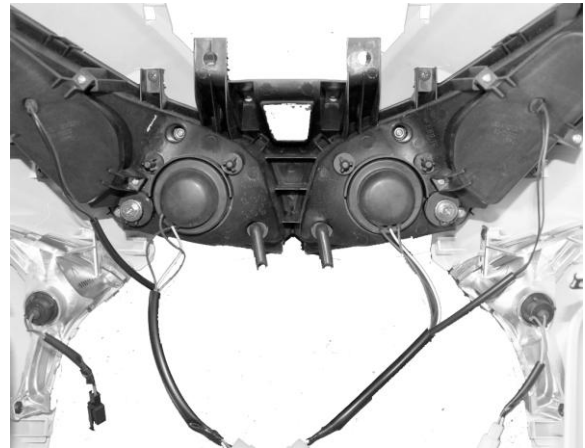

FRONT FENDER

Remove four screws attaching to the front fender.

Installation is in the reverse order of removal.

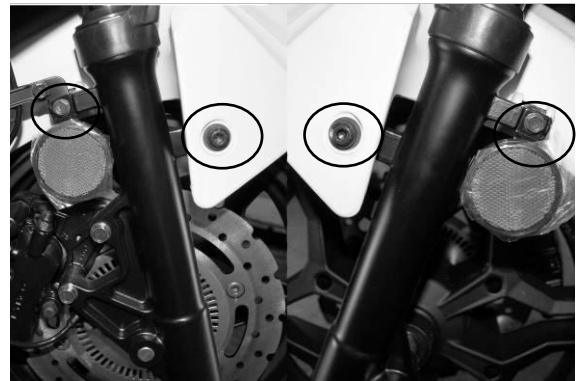

RIGHT/LEFT FLOORBOARD

Remove the body cover (2-5) .
Remove the front cover (2-8)
Remove four screws and two bolts then
remove right/left floorboard.

Installation is in the reverse order of removal.

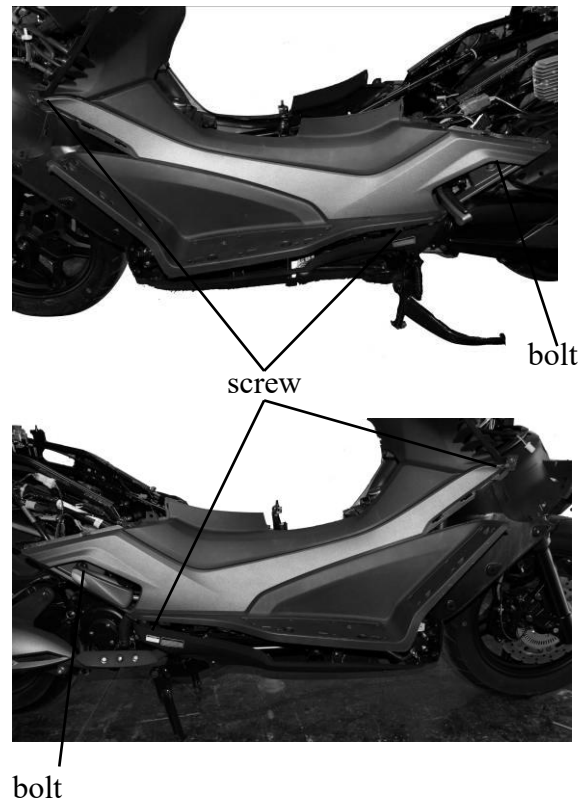

2. EXHAUST MUFFLER/FRAME COVERS

INNER COVER

- Remove the front cover.
- Remove right/left floorboard.
- Remove one screws
- Remove the ignition key garnish
- Remove remove the handler panel.

* During removal, do not pull the joint claws forcedly to avoid damage.



reserve tank lid

Remove one screws then remove the reserve tank lid



screw

2. EXHAUST MUFFLER/FRAME COVERS

Remove six screws and two bolts

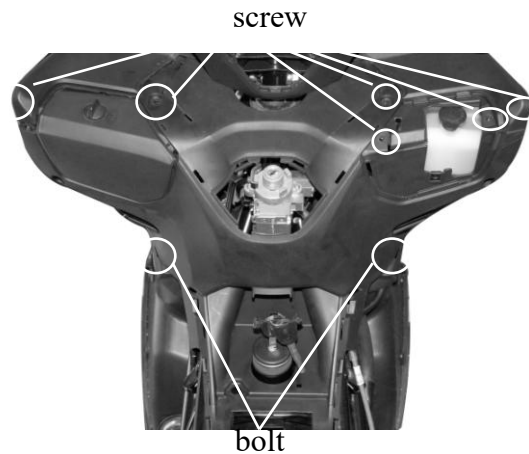

Remove one screw, connect the left front box
assy and inner cover
Disconnect the DC power connectors.

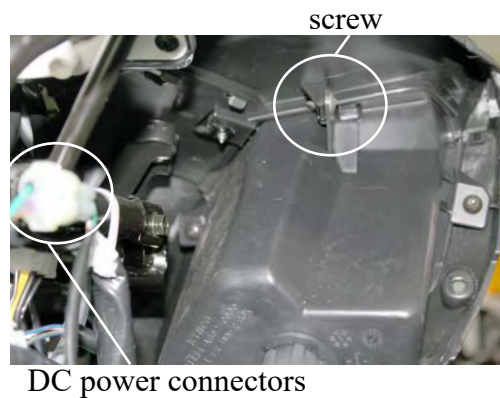

Remove the fuel tank fill cap and collection
of fuel spill tank .



Remove the inner cover.
Installation is in the reverse order of removal.



2. EXHAUST MUFFLER/FRAME COVERS

METER PANEL

Remove the front cover
Remove the inner cover.
Disconnect the speedometer wires



Remove two bolts then remove meter panel
Installation is in the reverse order of removal.

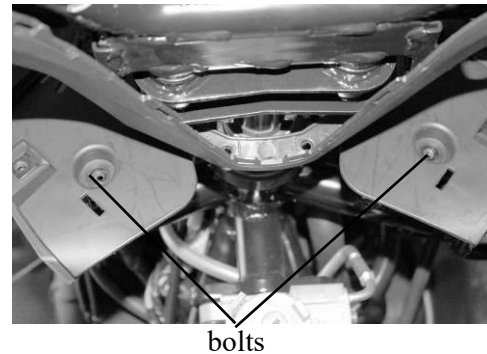

FRONT INNER FENDER

Remove canistr-pcv and room temp sensor .
Remove four screws, connect front inner fender and the coolant tank cover
Remove front inner fender

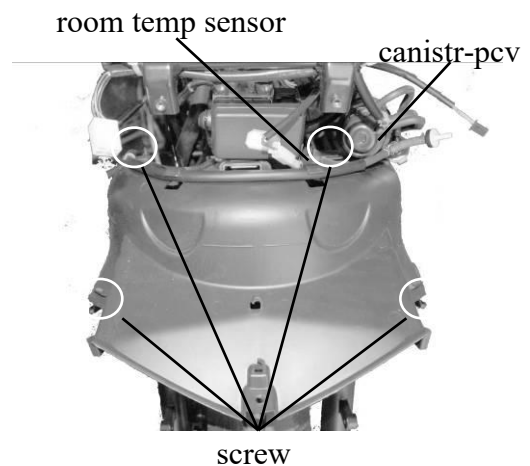

Installation is in the reverse order of removal.

COOLANT TANK COVER

Remove two fasteners.
Remove the coolant tank cover

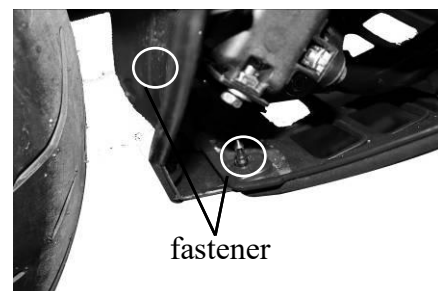

2. EXHAUST MUFFLER/FRAME COVERS

UNDER COVER

Remove four bolts
Remove the under cover.

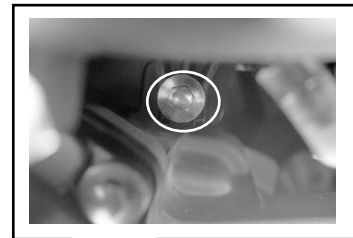
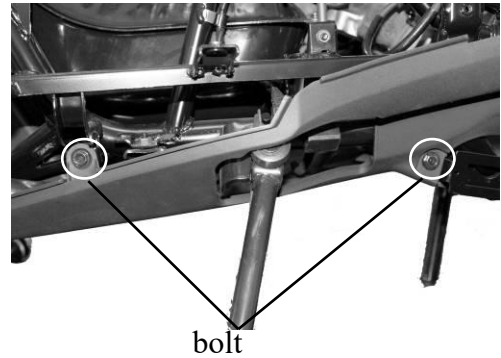

TIRE FENDER

Remove the body cover.
Remove four bolts attaching to the tire fender
Installation is in the reverse order of removal.

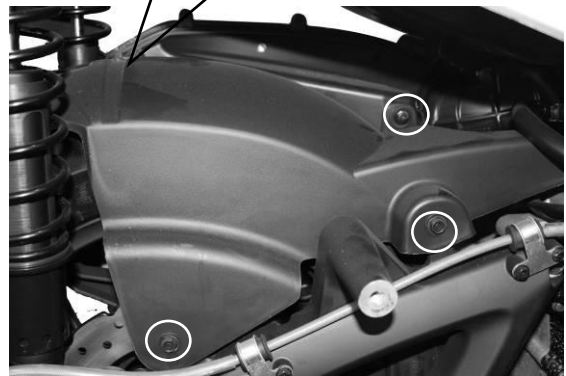

FENDER, REAR INNER

Remove rear cushion two bolts

Remove five bolts

Remove fender rear inner



Rear cushion

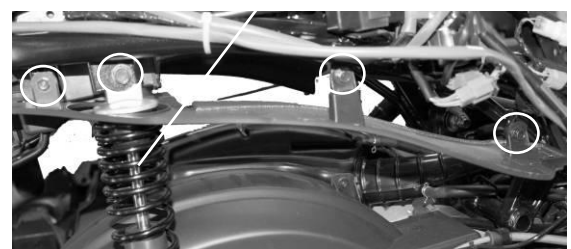

2. EXHAUST MUFFLER/FRAME COVERS

EXHAUST MUFFLER

REMOVAL

Disconnect the connector with O₂ heater/O₂ sensor.



Remove the two exhaust pipe joint nuts

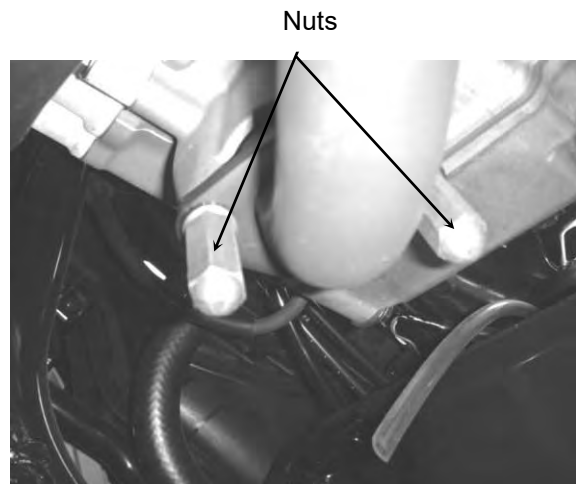

Remove three muffler mount bolts and muffler and gasket.



2. EXHAUST MUFFLER/FRAME COVERS

INSTALLATION

Replace the gasket with a new one.
Install the exhaust muffler and three mounting bolt.

Install and tighten the two exhaust pipe joint nuts to the specified torque

Torque: 20 N•m (2 kgf•m,)

Tighten the three mounting bolts

Torque: 35 N•m (3.5 kgf•m,)



Gasket

3. INSPECTION/ADJUSTMENT



INSPECTION / ADJUSTMENT

SERVICE INFORMATION	3- 1
MAINTENANCE SCHEDULE.....	3- 2
THROTTLE OPERATION.....	3- 3
ENGINE OIL	3- 4
RESERVE TANK	3- 5
AIR CLEANER	3- 6
SPARK PLUG	3- 6
VALVE CLEARANCE.....	3- 7
CYLINDER COMPRESSION	3- 7
FINAL REDUCTION GEAR OIL	3- 8
DRIVE BELT.....	3- 8
BRAKE SYSTEM.....	3- 9
CLUTCH SHOE WEAR.....	3-10
SUSPENSION.....	3-10
NUTS/BOLTS/FASTENERS.....	3-11
WHEELS/TIRES.....	3-11
STEERING HANDLEBAR.....	3-11
SIDE STAND	3-12

3. INSPECTION/ADJUSTMENT

SERVICE INFORMATION

GENERAL

 WARNING
--

- Before running the engine, make sure that the working area is well ventilated. Never run the engine in a closed area. The exhaust contains poisonous carbon monoxide gas, which may cause death to people.
- Gasoline is extremely flammable and is explosive under some conditions. The working area must be well ventilated and do not smoke or allow flames or sparks near the working area or fuel storage area.

SPECIFICATIONS

ENGINE

Throttle grip free play : 2~6 mm
 Spark plug : NGK: DPR6EA-9
 Spark plug gap : 0.8 mm ~ 0.9 mm
 Valve clearance : IN: 0.10 mm EX: 0.10 mm
 Idle speed : 1600±100 rpm

Engine oil capacity:

Cylinder compression: 15 kg/cm²
 At disassembly : 1.1 Liter Ignition timing : ECU
 At change : 0.9 Liter Coolant type : Water Cooling

Gear oil capacity :

At disassembly : 0.23 Liter
 At change : 0.18 Liter

TIRE

	1 Rider	2 Riders
Front	2.0 kg/cm ²	2.0 kg/cm ²
Rear	2.25 kg/cm ²	2.25 kg/cm ²

TIRE SPECIFICATION

Front : 120/80-14 58S
 Rear : 150/70-13 64S

TORQUE VALUES

Front axle nut : 2 kg-m
 Rear axle nut : 12 kg-m

SPECIAL TOOL

Tappet Adjuster E012

3. INSPECTION/ADJUSTMENT

Maintenance schedule

Perform the pre-ride inspection at each scheduled maintenance period. This interval should be judged by odometer reading or months, whichever comes first.

Maintenance schedule legend

I: INSPECT AND CLEAN, ADJUST, LUBRICATE OR REPLACE IF NECESSARY

C: CLEAN R: REPLACE A: ADJUST L: LUBRICATE

The maintenance schedule on the following two pages specifies the maintenance required to keep your X-Town 300i scooter in peak operating condition. Maintenance work should be performed in accordance with KYMCO standards and specifications by properly trained and equipped technicians. Your KYMCO dealer meets all of these requirements.

* Should be serviced by your KYMCO dealer, unless you have the proper tools, service data and are technically qualified.

** In the interest of safety, we recommend these items be serviced only by your KYMCO dealer. KYMCO recommends that your KYMCO dealer road test your scooter after each periodic maintenance service is completed.

ITEM	FREQUENCY	WHICHEVER COMES FIRST							
		ODOMETER READING							
		X 1000 km	1	3	6	9	12	15	18
		X1000 mi	0.6	2	4	6	8	10	12
	MONTH		3	6	9	12	15	18	
AIR CLEANER			R	R	R	R	R	R	
SPARK PLUG				I		R		I	
THROTTLE OPERATION			I	I	I	I	I	I	
VALVE CLEARANCE		A				A			
FUEL LINE						I			
CRANKCASE		C	C	C	C	C	C	C	
ENGINE OIL		R	R	R	R	R	R	R	
ENGINE OIL SCREEN		C	C	C	R	C	C	R	
ENGINE IDLE SPEED				I		I		I	
TRANSMISSION OIL		R		R		R		R	
DRIVE BELT				I	I	I	R	I	
RADIATOR COOLANT		Replace at every 10000km or every year							
CLUTCH SHOE WEAR				I		I		I	
BRAKE FLUID		Replace at every 10000km or every year							
BRAKE PAD WEAR			I	I	I	I	I	I	
BRAKE SYSTEM			I	I	I	I	I	I	
BRAKE LIGHT SWITCH			I	I	I	I	I	I	
STEERING BEARINGS			I	I	I	I	I	I	
HEADLIGHT AIM			I	I	I	I	I	I	
NUTS,BOLTS,FASTENE			I	I	I	I	I	I	
WHEEL/TIRES			I	I	I	I	I	I	
CVT FILTER				C		C		C	
INJECTOR			D	D	C	D	D	C	
ENGINE LIMIT LEVER		Inspection every 10000km, replacement every 30000Km							
RUBBER GASKET									

3. INSPECTION/ADJUSTMENT

THROTTLE OPERATION

Check the throttle grip for smooth movement.
Measure the throttle grip free play.

Free Play: 2~6 mm

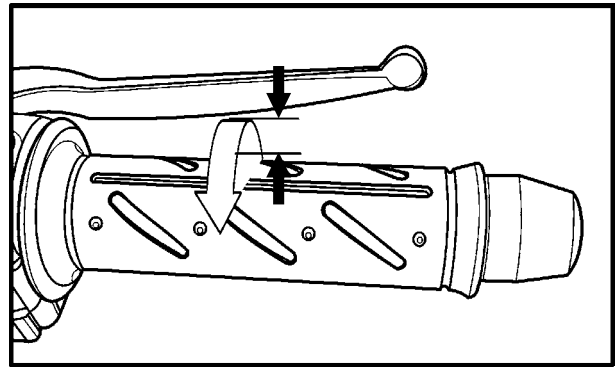

Major adjustment of the throttle grip free play is made with the adjusting nut at the throttle body side. Adjust by loosening the lock nut and turning the adjusting nut.

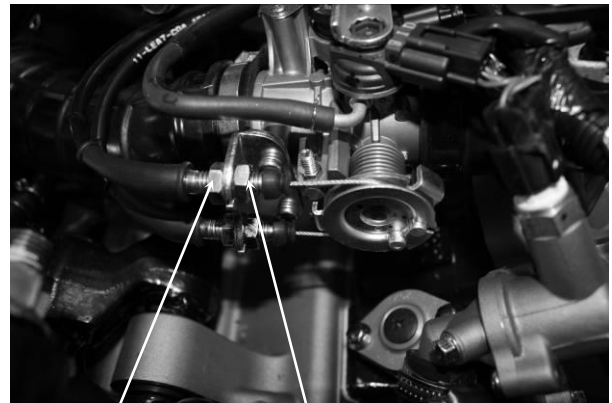

Adjusting Nut

Lock Nut

Minor adjustment is made with the adjusting nut at the throttle grip side.

Slide the rubber cover(1) out and adjust by loosening the lock nut(3) and turning the adjusting nut(2).

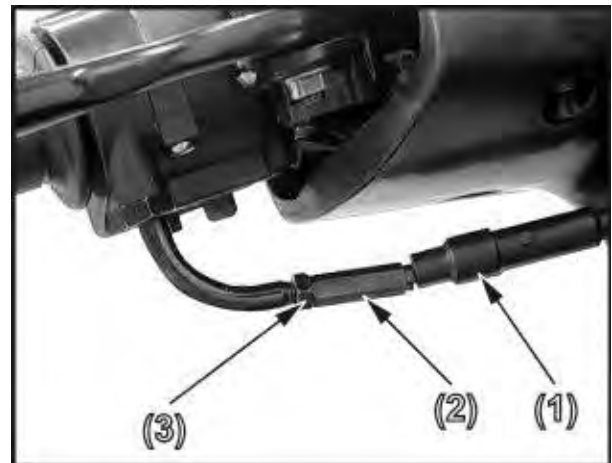

3. INSPECTION/ADJUSTMENT

ENGINE OIL

OIL LEVEL INSPECTION

Stop the engine and support the scooter upright on the level ground.
Wait for 2~3 minutes and check the oil level with the dipstick. Do not screw in the dipstick when checking the oil level.



OIL CHANGE

Remove the oil drain bolt to drain the engine oil.
Install the aluminum washer and tighten the oil drain bolt.

Torque: 2.5 kg-m

- * • Replace the aluminum washer with a new one if it is deformed or damaged.

Pour the recommended oil through the oil filler hole.



Oil Drain Bolt

OIL CAPACITY

Engine oil capacity: 1.1 L
Engine oil exchanging capacity: 0.9 L
Engine Oil Viscosity : SAE 5W50

OIL FILTER REPLACEMENT

Remove the oil filler cap attaching the right-under crankcase cover.

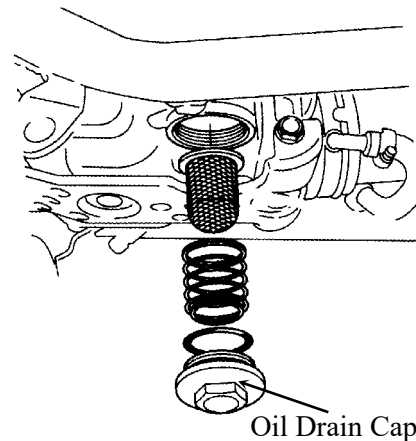

Oil Drain Cap

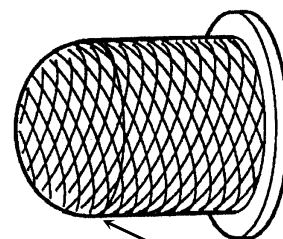

Oil Strainer Screen

3. INSPECTION/ADJUSTMENT

RESERVE TANK

COOLANT LEVEL INSPECTION

The coolant reservoir is in the front in the box. Check the coolant level through the inspection window ① at the left side skirt while the engine is at the normal operating temperature, with the scooter in an upright position. If the level is below the "LOW" level line ③, remove the left foot mat, remove the lid screw ④, the reservoir lid ⑤, and the reservoir tank cap ⑥ to add coolant until it reaches the "FULL" level line ②.

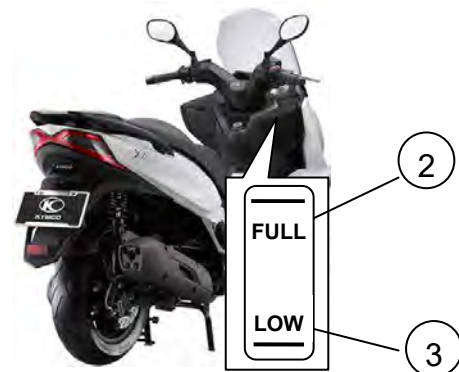
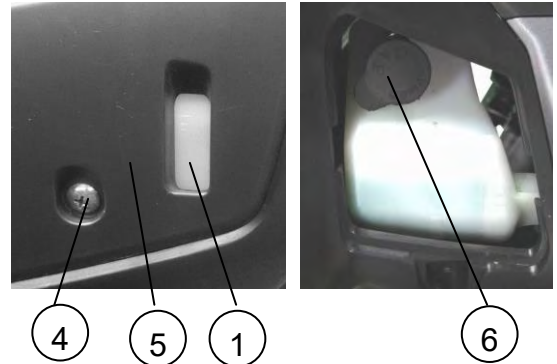

* Add coolant to the reserve tank only. Do not attempt to add coolant by removing the radiator cap. Coolant in the radiator is under pressure and is very hot and can cause serious burns.

3. INSPECTION/ADJUSTMENT

AIR CLEANER

AIR FILTER REPLACEMENT

Remove the body cover.
 Remove seven screws attaching to the air cleaner cover.
 Remove six screws attaching to the filter.
 Check the filter and replace it if it is excessively dirty or damaged.

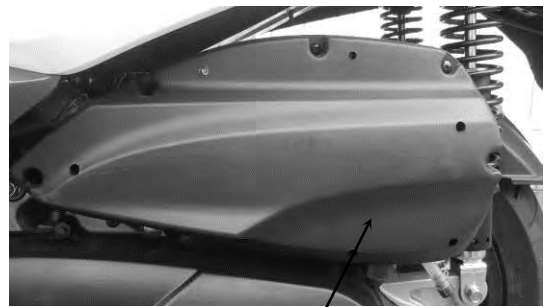

Air Cleaner Cover

CHANGE INTERVAL

More frequent replacement is required when riding in unusually dusty or rainy areas.

- *
 • The air cleaner element has a viscous type paper element. Do not clean it with compressed air.
 • Be sure to install the air cleaner element and cover securely.

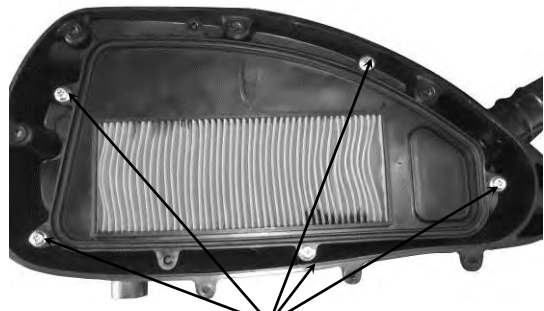

Bolts

SPARK PLUG

Remove the spark plug cap and spark plug.
 Check the spark plug for wear and fouling deposits.
 Clean any fouling deposits with a spark plug cleaner or a wire brush.

Specified Spark Plug: NGK-DPR6EA-9

Measure the spark plug gap.

Spark Plug Gap: 0.8 ~0.9 mm

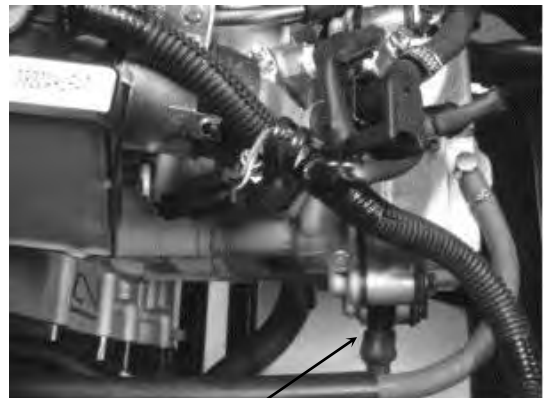

Spark Plug

- *
 • When installing, first screw in the spark plug by hand and then tighten it with a spark plug wrench.

Torque: 17.2 N-m

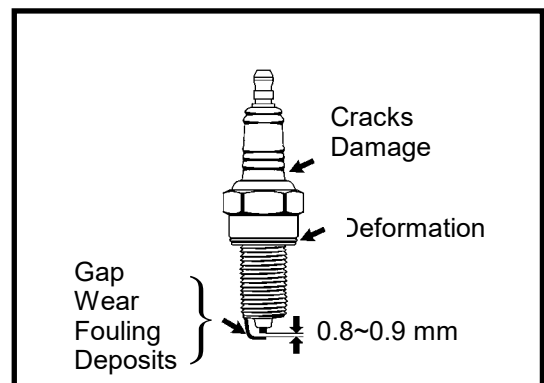

3. INSPECTION/ADJUSTMENT

VALVE CLEARANCE

- * • Inspect and adjust valve clearance while the engine is cold (below 35°C).

Remove the seat assy and luggage box.
Remove the four bolts and then cylinder head cover.

Turn the A.C. generator flywheel to the top dead center (TDC) on the compression stroke so that the "T" mark on the flywheel aligns with the index mark on the left crankcase cover.

Inspect and adjust valve clearance.

Valve Clearance: IN: 0.10 mm
EX: 0.10 mm

Loosen the lock nut and adjust by turning the adjusting nut

Special

Valve Adjuster E012
Feeler Gauge

- * • Check the valve clearance again after the lock nut is tightened.

Cylinder Head Cover

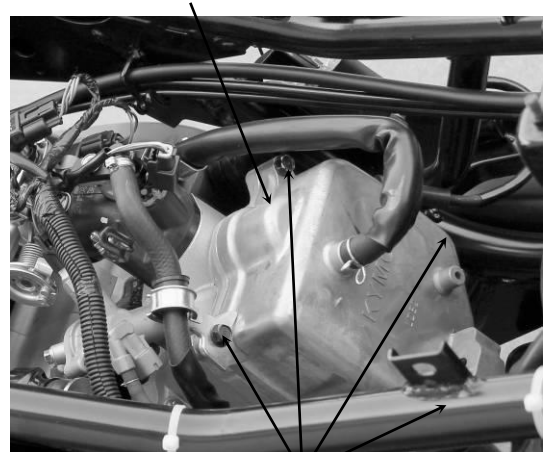

Bolts

Index Mark

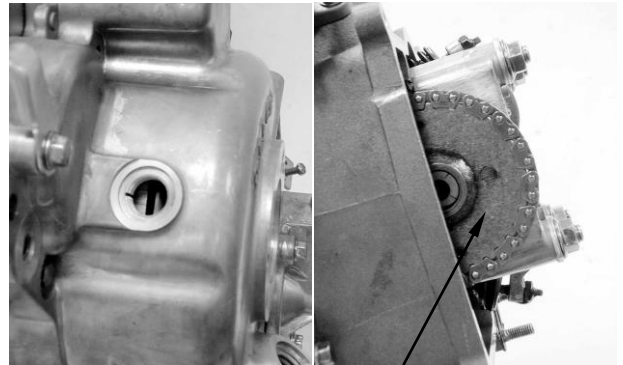

"T" Mark

Punch Mark

CYLINDER COMPRESSION

Warm up the engine before compression test.

Remove the center cover and luggage box.

Remove the spark plug.

Insert a compression gauge.

Open the throttle fully and push the starter button to test the compression.

Max. Compression: 15 kg/cm²

If the compression is low, check for the following:

- Leaky valves
- Valve clearance too small
- Leaking cylinder head gasket
- Worn piston rings
- Worn piston/cylinder

If the compression is high, it indicates that carbon deposits have accumulated on the combustion chamber and the piston head.

Valve Wrench

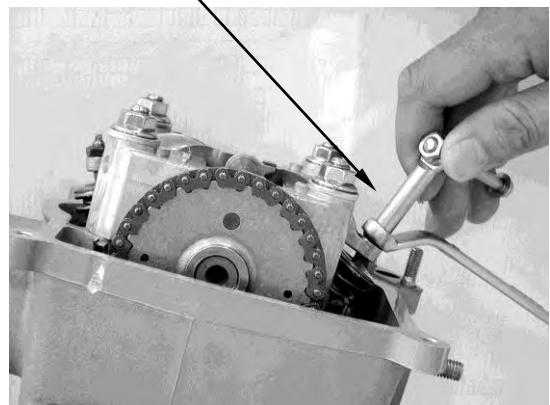

3. INSPECTION/ADJUSTMENT

FINAL REDUCTION GEAR OIL

- * Place the scooter on its main stand on level ground.

Remove the transmission fluid drain bolt.
 Remove the transmission fluid filler bolt, then slowly rotate the rear wheel to drain the fluid.
 Fill the transmission with the recommend fluid to the capacity listed below.

Transmission fluid type: SAE 90
Transmission fluid capacity: 0.23 L
Transmission fluid exchanging capacity: 0.18 L

Install the transmission filler bolt and tighten it to the specified torque.

DRIVE BELT

Remove the left crankcase cover.
 Inspect the drive belt for cracks or excessive wear.
 Replace the drive belt with a new one if necessary and in accordance with the Maintenance Schedule.

CVT Check/Clean

Change or clean the air filter every 5000km
 Remove set screws on the left crankcase cap
 Remove screws on the clapboard
 On the left crankcase
 Remove the air filter, change or clean
 <Install method>
 Install in the reverse order
 <clean method>
 Clean the sponge with compressed air and
 Clean the stain on left inner crankcase



Oil Filler Bolt



Oil Drain Bolt

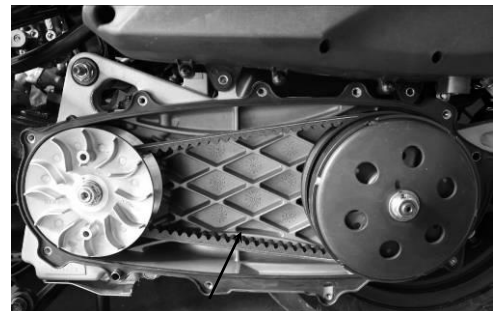

Drive Belt



3. INSPECTION/ADJUSTMENT

BRAKE SYSTEM

There is adjuster on each brake lever. Each adjuster has four positions so that the released lever position can be adjusted to suit the rider's hands.

To adjust the distance of the lever from the handlebar grip, push the lever (1) forward and turn the adjuster knob (2) to align the number with the arrow mark (3) on the lever holder.



BRAKE DISK/BRAKE PAD

Check the brake disk surface for scratches, unevenness or abnormal wear.

Check if the brake disk runout is within the specified service limit.

Check if the brake pad wear exceeds the wear indicator line.



* Keep grease or oil off the brake disk to avoid brake failure.

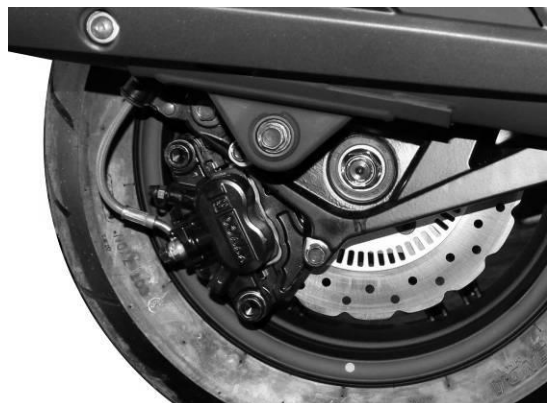

BRAKE FLUID

Turn the steering handlebar upright and check if both brake fluid levels is at the upper limit. If the brake fluid is insufficient, fill to the upper limit.

Specified Brake Fluid: DOT-4

* The brake fluid level will decrease if the brake pads are worn.

Brake fluid reservoir



3. INSPECTION/ADJUSTMENT

CLUTCH SHOE WEAR

Start engine and check the clutch operation by increasing the engine speed gradually. If the motorcycle tends to creep or the engine stop, check the clutch shoes for wear and replace if necessary.



SUSPENSION

FRONT

Check the action of the front shock absorbers by compressing them several times.

Check the entire shock absorber assembly for oil leaks, looseness or damage.



REAR

Each shock absorber(4) on your scooter has 5 spring preload adjustment positions for different load or riding conditions.

Use a pin spanner(5) to adjust the rear shock spring preload. Position 1 is for light loads and smooth road conditions. Position 3 to 5 increase spring preload for a stiffer rear suspension and can be used when the scooter is heavily loaded.

Be certain to adjust both shock absorbers to the same spring preload positions.

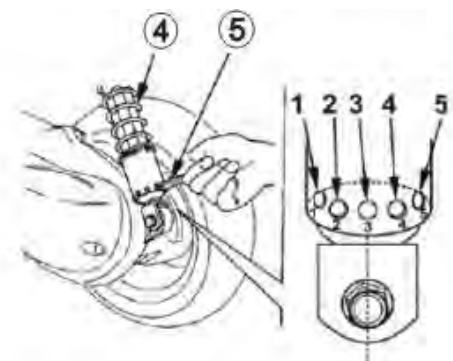

3. INSPECTION/ADJUSTMENT

NUTS/BOLTS/FASTENERS

Check all important chassis nuts and bolts for looseness.

Tighten them to their specified torque values if any looseness is found.

WHEELS/TIRES

Check the tires for cuts, imbedded nails or other damages.

Check the tire pressure.

- * • Tire pressure should be checked when tires are cold.

Tire Pressure

	1 Rider	1 Rider (with passenger)
Front	2.0kg/cm ²	2.00 kg/cm ²
Rear	2.25kg/cm ²	2.25 kg/cm ²

Tire Size:

Front 120/80-14 58S
Rear 150/70-13 64S

Check the front axle nut for looseness.

Check the rear axle nut for looseness.

If the axle nuts are loose, tighten them to the specified torques.

Torque:

Front axle nut 2 kg-m
Rear axle nut 12 kg-m

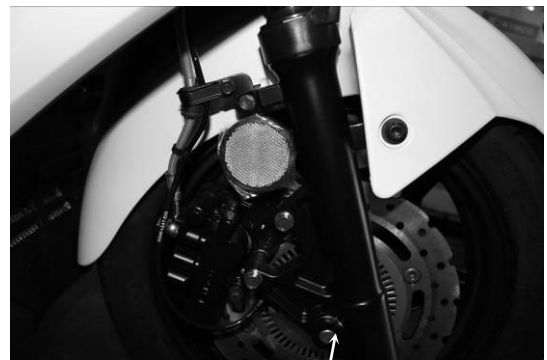
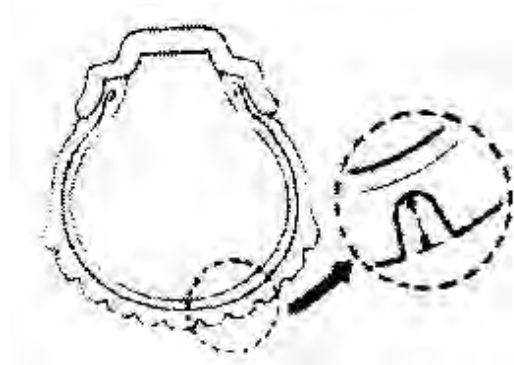

Front Axle Nut

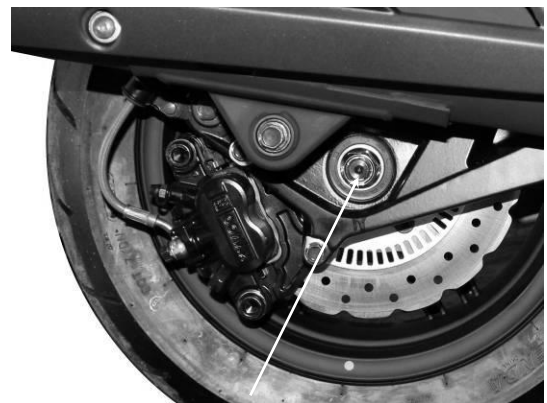

Rear Axle Nut

STEERING HANDLEBAR

Raise the front wheel off the ground and check that the steering handlebar rotates freely.

If the handlebar moves unevenly, binds, or has vertical movement, adjust the steering head bearing.



3. INSPECTION/ADJUSTMENT

SIDE STAND

Your scooter's side stand is not only necessary when you park, but it contains an important safety feature. This feature cuts-off the ignition if you try to ride the scooter when the side stand is down. Perform the following side stand inspection.

INTERLOCK FUNCTION CHECK

Check the side stand ignition cut-off system,

1. Place the scooter on its center stand.
2. Put the side stand up and start the engine.
3. Lower the side stand. The engine should stop as you put the side stand down.

* If the side stand system does not operate as described, see your KYMCO dealer for service.



Engine limit lever rubber gasket

Engine limit lever rubber gasket is made of rubber, Deterioration and friction is normal, so it needs inspection and replacement: inspect every 10000km and replace every 30000km.

Removal

1. Remove the engine hanger fixing nut, and remove the engine hanger bolt.
2. Remove the engine limit lever nut and remove the rubber gasket ①.
3. Remove the limit lever and remove the gasket ②.

Install the new gaskets in reverse order.

Torque:

Engine hanger nut torque: 60-70 NM

Engine limit lever nut torque: 40-50 NM

* 1. The bumping points of gasket ① should be placed towards the vehicle head.

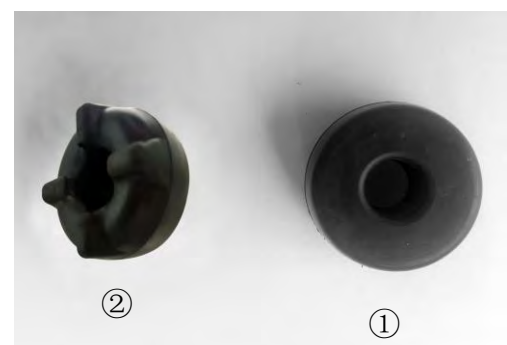
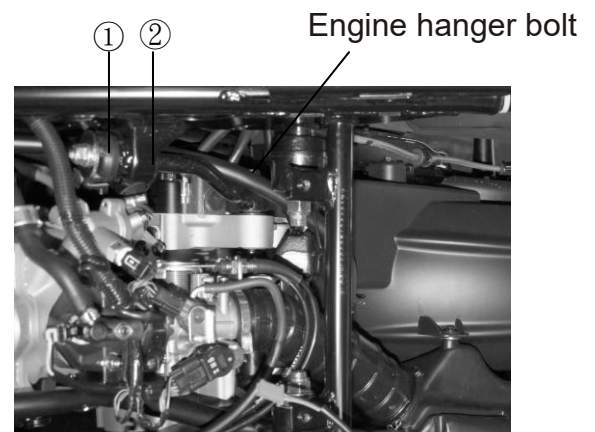

4. LUBRICATION SYSTEM

4

LUBRICATION SYSTEM

LUBRICATION SYSTEM DIAGRAM -----	4- 1
SERVICE INFORMATION-----	4- 3
TROUBLESHOOTING-----	4- 5
OIL PRESSURE SWITCH -----	4- 6
OIL PUMP-----	4- 7

4. LUBRICATION SYSTEM

X-Town300 ABS

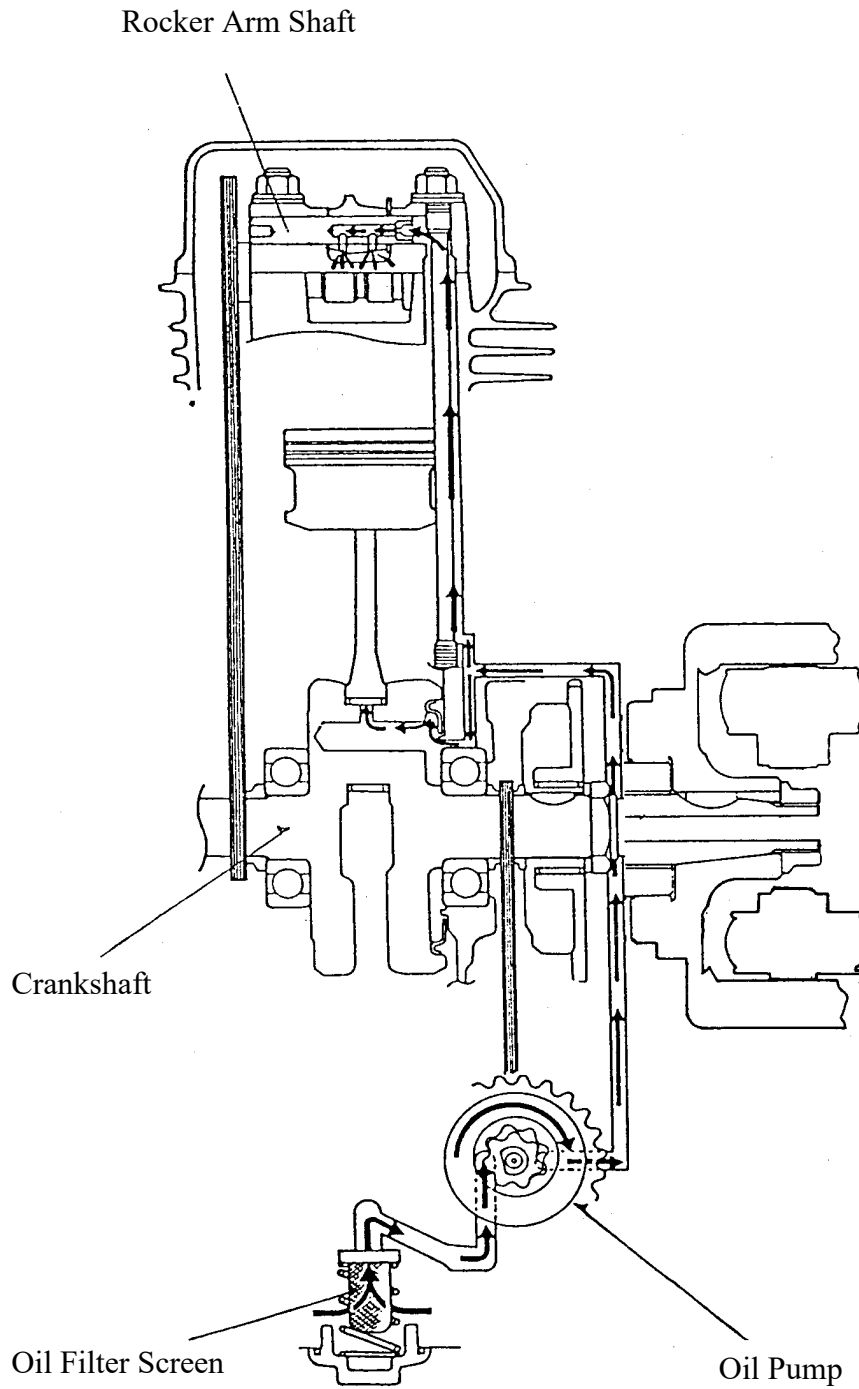

4. LUBRICATION SYSTEM

SERVICE INFORMATION

GENERAL INSTRUCTIONS

- The oil pump service may be done with the engine installed in the frame.
- When removing and installing the oil pump use care not to allow dust or dirt to enter the engine.
- If any portion of the oil pump is worn beyond the specified service limits, replace the oil pump as an assembly.
- After the engine has been installed check that there are no oil leaks and that oil pressure is correct.
- For oil pressure indicator inspection, refer to section 20 of this manual.

SPECIFICATIONS

Unit: mm (in)

ITEM		STANDARD	SERVICE LIMIT
Engine oil capacity	At draining	0.9 liter (0.95 US qt, 0.8 Imp qt)	—
	At disassembly	1.1 liter (1.17 US qt, 1 Imp qt)	—
Recommended engine oil		KYMCO 4-stroke oil or equivalent motor oil API service classification SJ Viscosity: SAE 5W-50	—
Oil pump rotor	Tip clearance	0.15 (0.006) max	0.2 (0.008)
	Body clearance	0.15 – 0.2 (0.006 – 0.008)	0.25 (0.01)
	Side clearance	0.04 – 0.09 (0.0016 – 0.0036)	0.12 (0.0048)

TORQUE VALUES

Oil pump screw	3 N•m (0.3kgf•m, 2 lbf•ft)
Oil pressure switch	22 N•m (2.2 kgf•m, 16 lbf•ft) Apply sealant to threads.
Oil strainer screen cap	15 N•m (1.5 kgf•m, 11 lbf•ft) Apply oil to the threads and seating surface.

TOOLS

Oil filter wrench A120E00052

4. LUBRICATION SYSTEM

TROUBLESHOOTING

Oil level low

- Oil consumption
- External oil leak
- Worn piston ring
- Incorrect piston ring installation
- Worn valve guide or seal

Oil contamination (White appearance)

- From coolant mixing with oil
 - Faulty water pump mechanical seal
 - Faulty head gasket
 - Water leak in crankcase

No oil pressure

- Oil level too low
- Oil pump drive chain broken
- Oil pump drive sprocket broken
- Oil pump damaged (pump shaft)
- Internal oil leak

Low oil pressure

- Pressure relief valve stuck open
- Clogged oil filter and strainer screen
- Oil pump worn or damaged
- Internal oil leak
- Incorrect oil being used
- Oil level too low

High oil pressure

- Pressure relief valve stuck closed
- Plugged oil filter, gallery, or metering orifice
- Faulty oil pump

Seized engine

- No or low oil pressure
- Clogged oil orifice/passage
- Internal oil leak
- Non-recommended oil used

Oil contamination

- Deteriorated oil
- Faulty oil filter
- Worn piston ring (White appearance with water or moisture)
 - Damaged water pump mechanical seal
 - Damaged head gasket
 - Oil relief not frequent enough

Oil pressure warning indicator does not work

- Faulty oil pressure switch
- Short circuit in the indicator wire
- Low or no oil pressure

4. LUBRICATION SYSTEM

OIL PRESSURE SWITCH

CHECK

Start the engine.
Check the oil pressure indicator goes out after one or two seconds. If the oil pressure indicator stay on, stop the engine immediately and determine the cause.



OIL CONTROLLER

If oil pressure is lower than 0.15kg/cm²
And six seconds later, the oil indicator
Will be flashing

Advantage

This oil controller can prevent the oil
Warning indicator from flashing when
Suddenly braking

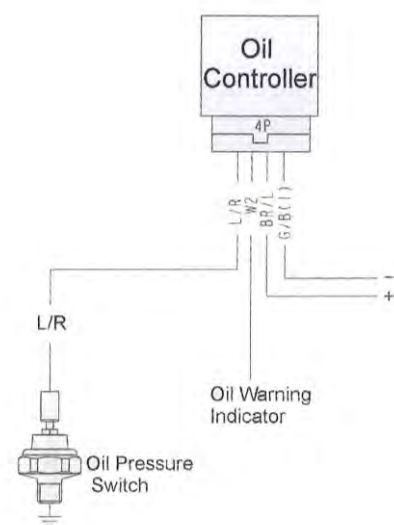

4. LUBRICATION SYSTEM

OIL PUMP

REMOVAL

Remove the flywheel

Remove the attaching bolt and oil separator cover.

* When removing and installing the oil pump, use care not to allow dust or dirt to enter the engine..

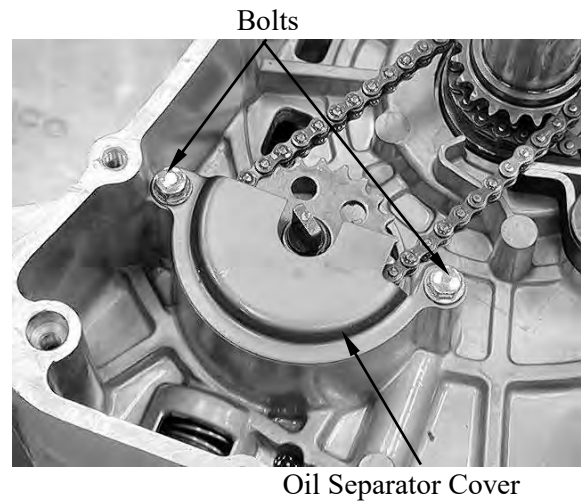

Remove snap ring.

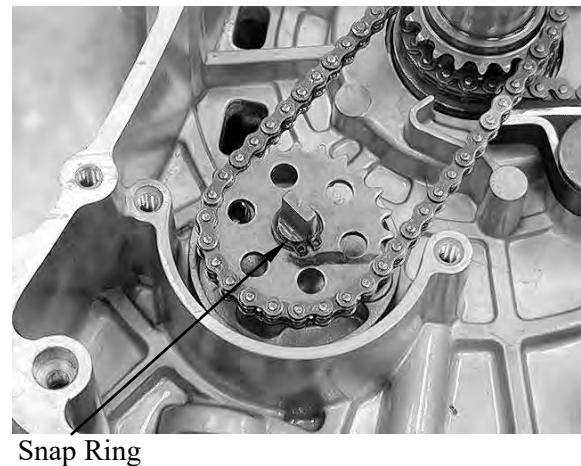

Remove the oil pump driven gear, then remove the oil pump drive chain.

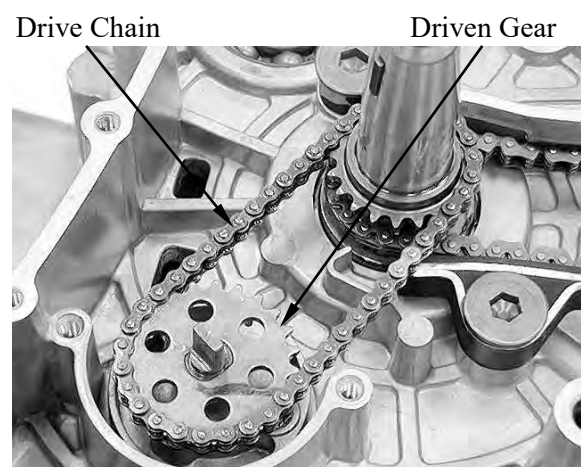

4. LUBRICATION SYSTEM

Remove the two oil pump bolts to remove the oil pump.

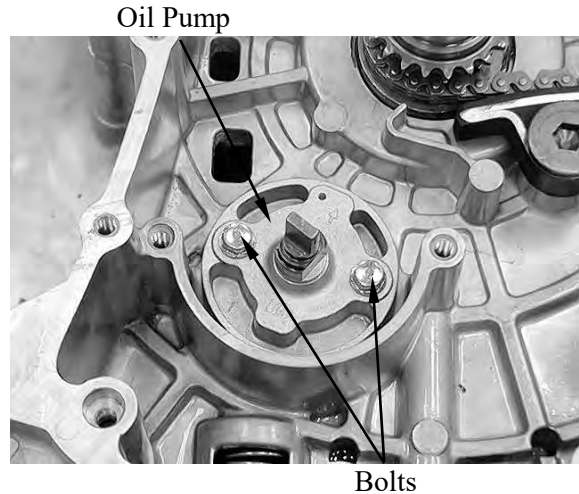

DISASSEMBLY

Remove the screw and oil pump cover.

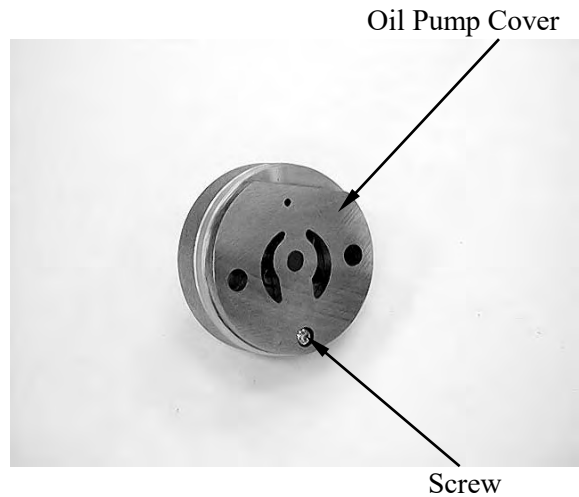

Remove the dowel pin, oil pump shaft, oil pump outer rotor and inner rotor.

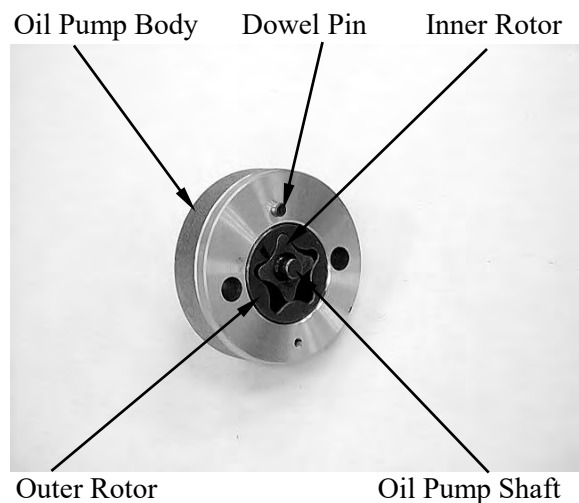

4. LUBRICATION SYSTEM

INSPECTION

Temporarily install the oil pump shaft.
Install the outer and inner rotors into the oil pump body.

Measure the tip clearance.

Service limit: 0.2 mm (0.008 in)

* Measure at several points and use the largest reading to compare the service limit.

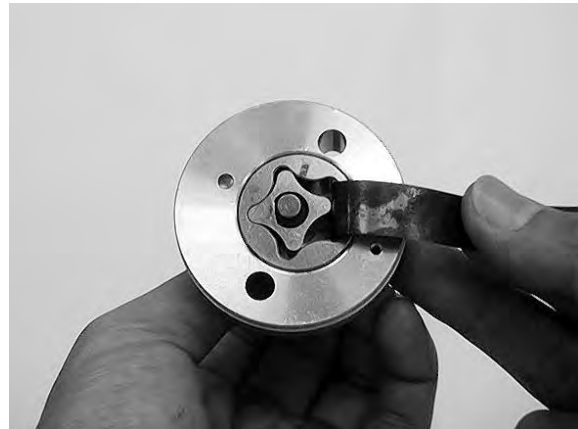

Measure the pump body clearance.

Service limit: 0.25 mm (0.01 in)

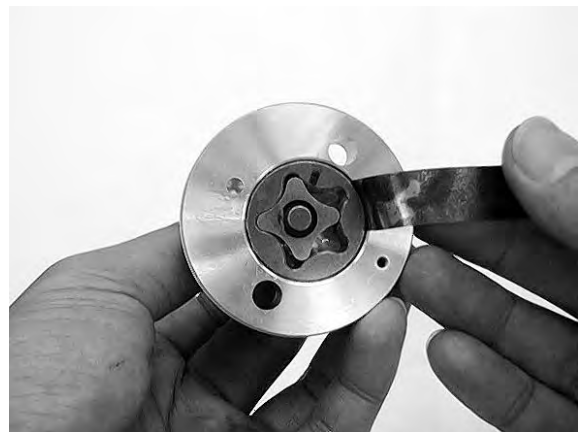

Measure the side clearance with the straight edge and feeler gauge.

Service limit: 0.12 mm (0.0048 in)

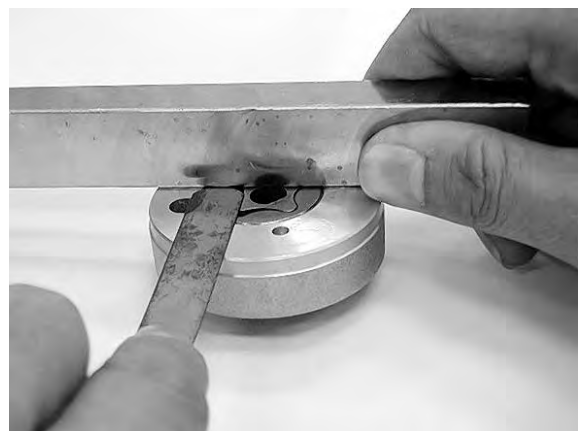

4. LUBRICATION SYSTEM

ASSEMBLY

Dip all parts in clean engine oil.

Install the outer rotor into the oil pump body.

Install the inner rotor into the outer rotor.

Install the oil pump shaft.

Install the dowel pin onto the oil pump body.

Install the oil pump cover onto the oil pump body by aligning the dowel pin.

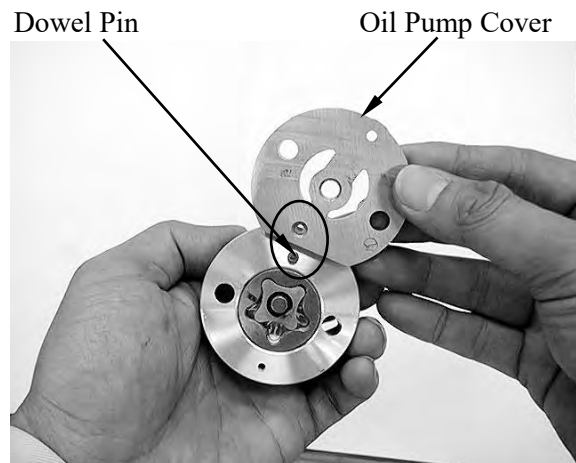

Install and tighten the screw to the specified torque.

Torquor: 3 N•m (0.3kgf•m, 2 lbf•ft)

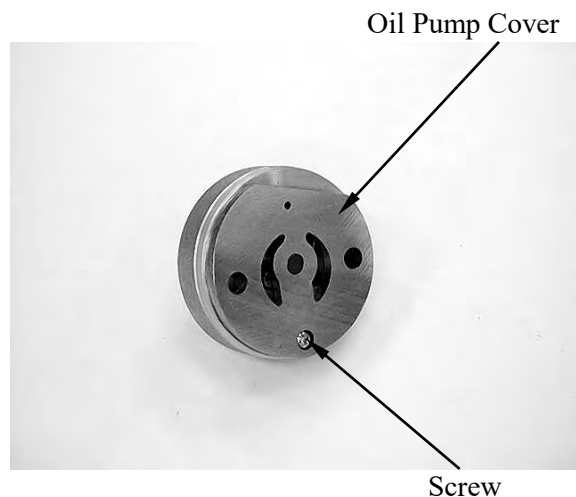

INSTALLATION

Install the oil pump and tighten the two bolts securely.

* Make sure the pump shaft rotates freely and arrow on the oil pump is upside.

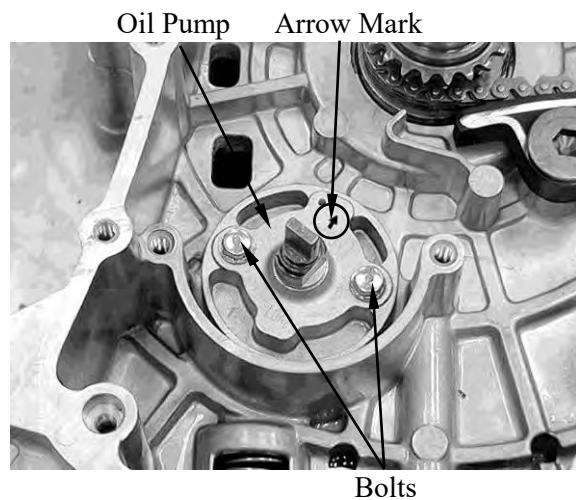

4. LUBRICATION SYSTEM

Install the oil pump driven sprocket and drive chain.

Install the snap ring.

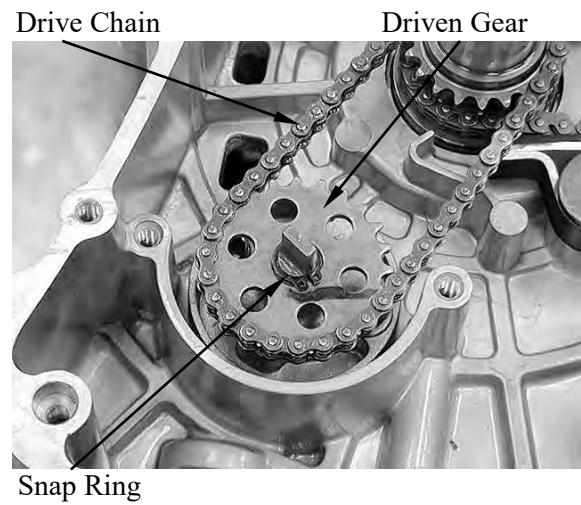

Install the oil separator cover properly and tighten two bolts securely as shown.

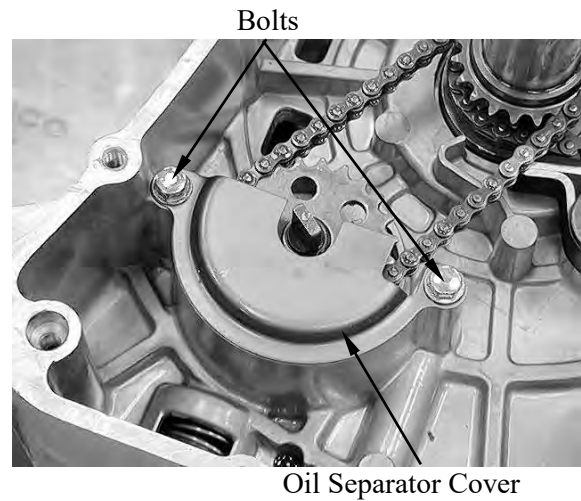

5

ENGINE REMOVAL/INSTALLATION

SERVICE INFORMATION-----	5-1
ENGINE REMOVAL/INSTALLATION-----	5-2
ENGINE HANGER -----	5-6

5. ENGINE REMOVAL/INSTALLATION

SERVICE INFORMATION

GENERAL INSTRUCTIONS

- A floor jack or other adjustable support is required to support and maneuver the engine. Be careful not to damage the scooter body, cables and wires during engine removal.
- Use shop towels to protect the scooter body during engine removal.
- Drain the coolant before removing the engine.
- After the engine is installed, fill the cooling system with coolant and be sure to bleed air from the water jacket. Start the engine to check for coolant leaks.
- Before removing the engine, the rear brake caliper must be removed first. Be careful not to bend or twist the brake fluid tube.

SPECIFICATIONS

Engine oil capacity:

At disassembly: 1.1 L

At change: 0.9L

Coolant capacity:

Radiator and Hose 1100 cc

Reserve tank: 250 cc

Total capacity: 1350 cc

TORQUE VALUES

90101-LKF5-E00	Engine hanger (Engine side)	5.0 kgf-m (50 N-m)
90106-LKF5-E00	Engine hanger (Frame side)	6.5 kgf-m (65 N-m)
95801-08055	Rear fork mount bolts	3.5 kgf-m (35 N-m)
90305-LBD4-900	Rear axle nut	12.0 kgf-m (120 N-m)
95801-10035-00	Rear cushion lower/upper mount bolts	4.0 kgf-m (40 N-m)

5. ENGINE REMOVAL/INSTALLATION

ENGINE REMOVAL/INSTALLATION

REMOVAL

Remove the air cleaner

Disconnect the connector including of ISC, Throttle body, TPS, WTS, MAP sensor and injector.

Disconnect the O2 sensor connector.

Disconnect the throttle cables.

Disconnect the Regulator/Rectifier connector.

Disconnect the starter relay wire from starter motor.

Disconnect the ACG and CPS connector

Remove a bolt from fuel hose guide.

Disconnect the fuel hose from fuel injector.

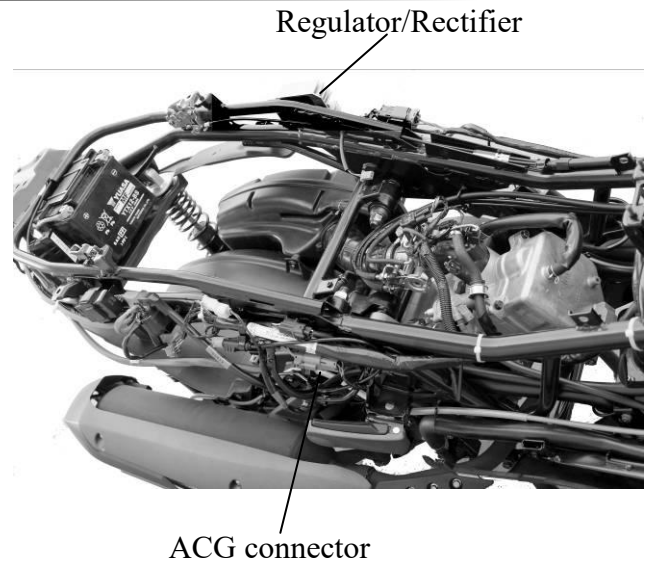

Disconnect the input water hose.



5. ENGINE REMOVAL/INSTALLATION

Remove the muffler.

Remove the rear fork mounting bolts ① attaching to the crankcase.

Torque: 3.5 kgf-m (35 N-m)

Remove the rear axle nut ②.

Torque: 12.0 kgf-m (120 N-m)

Remove two bolts ③ attaching to the rear brake caliper.

Torque: 3.2 kgf-m (32 N-m)

Disconnect the rear wheel speed sensor bolt ④ attaching to the rear fork mounting

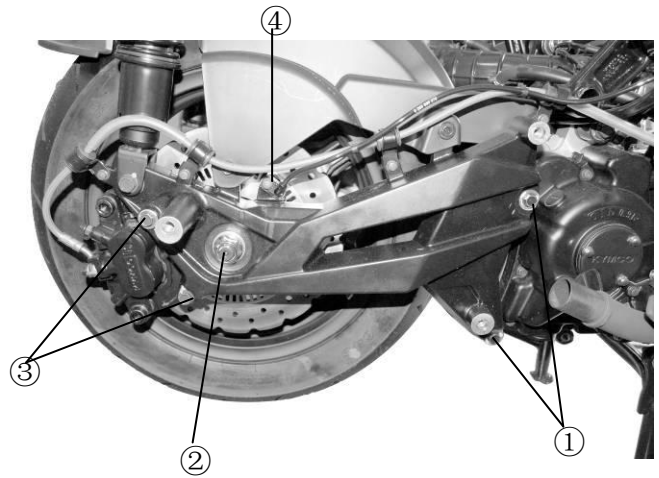

Disconnect the alternator connector ⑤.

Disconnect the ignition pulse generator connector ⑥.

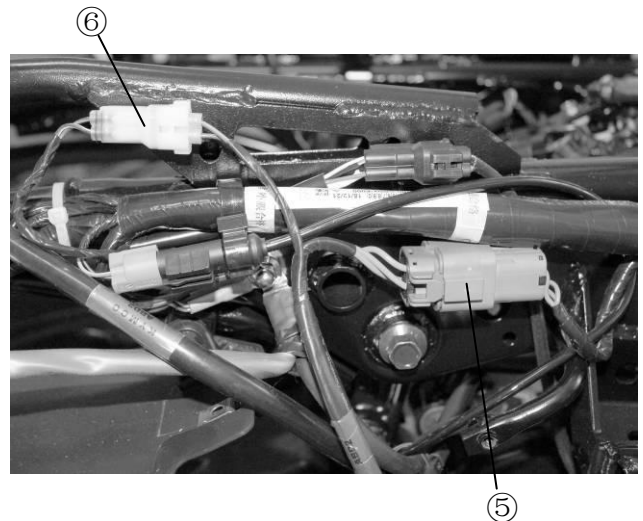

Release the rubber cap and remove the terminal screw ⑦ to disconnect the start motor cable from the start motor.

Remove the bolt and engine ground cable.



5. ENGINE REMOVAL/INSTALLATION

Remove the spark plug cap.



Spark Plug Cap

Disconnect the lower radiator hose from lower radiator pipe.



Radiator Hose

Remove the right and left rear cushion lower mount bolts.

Torque: 4.0 kgf-m (40N-m)



Mount Bolt

5. ENGINE REMOVAL/INSTALLATION

Remove the engine mount nut and pull it out.
Remove the engine from the frame.

* At removing the engine, be careful not to catch your hand or finger between the engine hanger and crankcase.

Torque: 6.5 kgf-m (65 N-m)



Mount Nut

INSTALLATION

Installation is in the reverse order of removal.

After installation, inspect and adjust the following:

- Throttle grip free play
 - Fill the cooling system with coolant and start the engine to bleed air from the system.
- API/ABV Reset (Refer to chapter14, page 17)

5. ENGINE REMOVAL/INSTALLATION

ENGINE HANGER

REMOVAL

Remove the engine mount nut and pull it out.

* Be careful to put the engine down.

Remove the left/right engine hanger mount bolt.

Remove the engine from frame.

INSTALLATION

Installation is in the reverse order of removal.

Tighten the engine hanger mount bolts to the specified torque.

Torque: 6.5 kgf-m (65 N-m)

Mount Nut

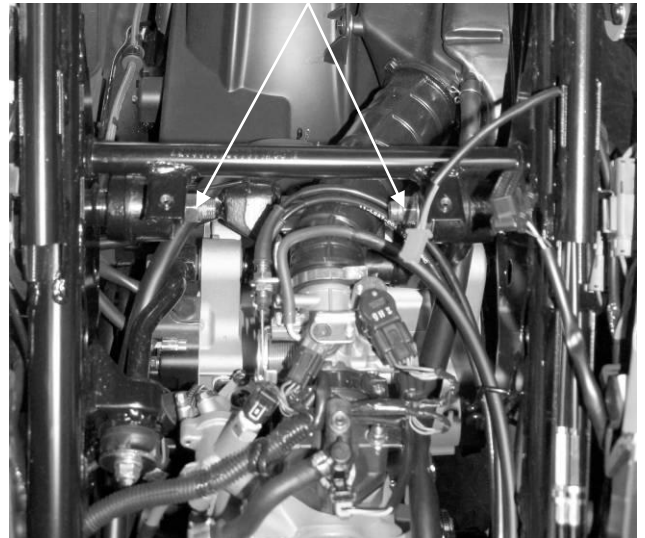

6. CYLINDER HEAD/VALVES

6

CYLINDER HEAD/VALVES

SCHEMATIC DRAWING	6-1
SERVICE INFORMATION	6- 2
TROUBLESHOOTING	6- 3
CYLINDER HEAD COVER REMOVAL	6- 4
CAMSHAFT REMOVAL	6- 4
CYLINDER HEAD REMOVAL.....	6- 6
CYLINDER HEAD DISASSEMBLY	6- 7
CYLINDER HEAD ASSEMBLY	6- 8
CYLINDER HEAD INSTALLATION	6- 9
CAMSHAFT INSTALLATION.....	6- 9
CYLINDER HEAD COVER INSTALLATION.....	6-11

6. CYLINDER HEAD/VALVES

SCHEMATIC DRAWING

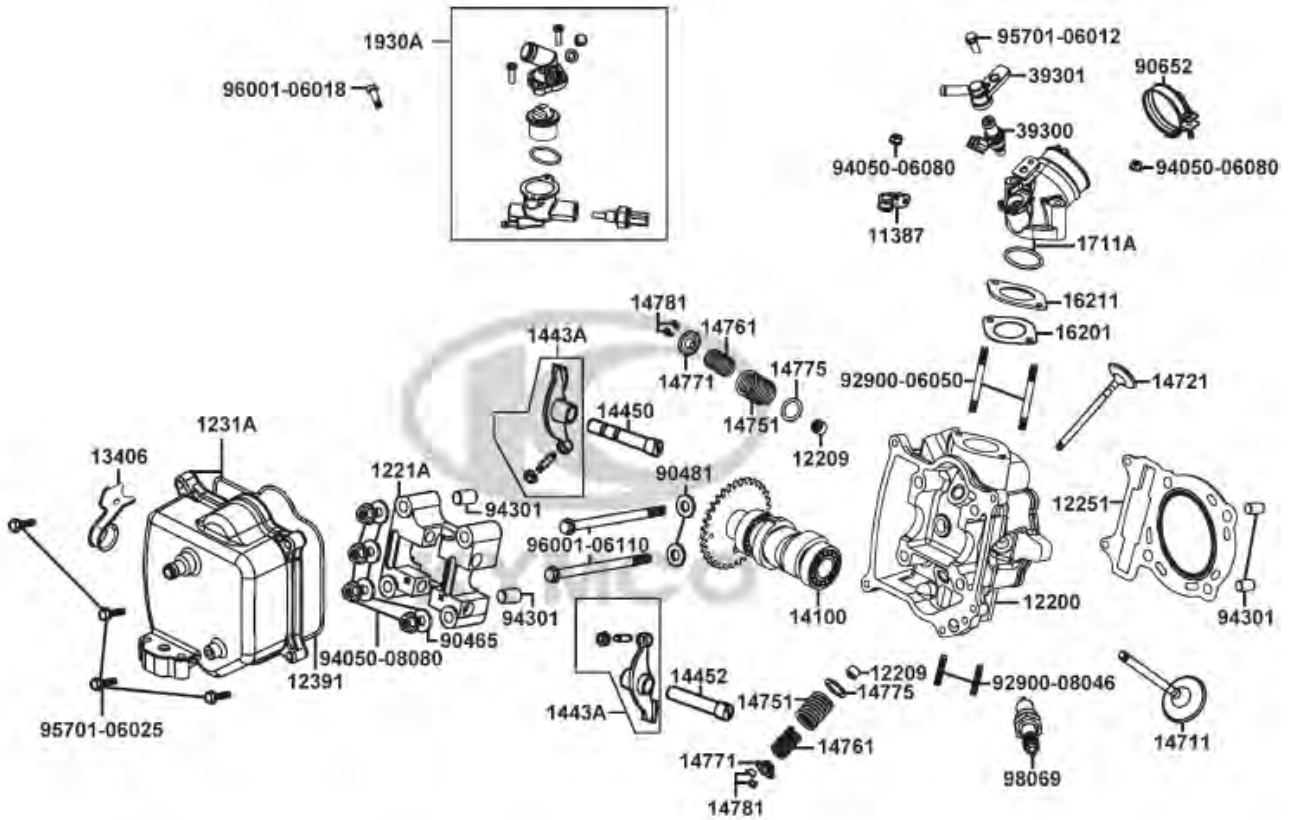

6. CYLINDER HEAD/VALVES

SERVICE INFORMATION

GENERAL INSTRUCTIONS

- The cylinder head can be serviced with the engine installed in the frame. Coolant in the radiator and water hoses must be drained.
- When assembling, apply molybdenum disulfide grease or engine oil to the valve guide movable parts and valve arm sliding surfaces for initial lubrication.
- The valve rocker arms are lubricated by engine oil through the engine oil passages. Clean and unclog the oil passages before assembling the cylinder head.
- After disassembly, clean the removed parts and dry them with compressed air before inspection.
- After removal, mark and arrange the removed parts in order. When assembling, install them in the reverse order of removal.

SPECIFICATIONS

Unit: mm (in)

Item		Standard	Service Limit
Valve clearance (cold)	IN	0.1 mm (0.004 in)	—
	EX	0.1 mm (0.004 in)	—
Cylinder head compression pressure		15 kg/cm ² (213 psi, 1500 kPa)	—
Cylinder head warpage		—	0.05 (0.002)
Camshaft cam height	IN	34.2987 (1.371948)	34.14 (1.3656)
	EX	34.1721 (1.366884)	34.02 (1.3608)
Valve rocker arm I.D.	IN	10 (0.4)~10.015 (0.4006)	10.1 (0.404)
	EX	10 (0.4)~10.015 (0.4006)	10.1 (0.404)
Valve rocker arm shaft O.D.	IN	9.972 (0.399)~9.987 (0.3995)	9.9 (0.396)
	EX	9.972 (0.399)~9.987 (0.3995)	9.9 (0.396)
Valve stem O.D.	IN	4.975 (0.199)~4.99 (0.1996)	4.925 (0.197)
	EX	4.955 (0.1982)~4.97 (0.1988)	4.915 (0.1966)
Valve guide I.D.	IN	5 (0.2)~5.012 (0.2005)	5.03 (0.2012)
	EX	5 (0.2)~5.012 (0.2005)	5.03 (0.2012)
Valve stem-to-guide clearance	IN	0.01 (0.004)~0.037 (0.0015)	0.08 (0.0032)
	EX	0.03 (0.0012)~0.057 (0.0023)	0.1 (0.004)

TORQUE VALUES

Cylinder head cap nut	25 N•m (2.5 kgf•m, 18 lbf•ft)	Apply engine oil to threads
Valve clearance adjusting nut	9 N•m (0.9 kgf•m, 6.5 lbf•ft)	Apply engine oil to threads
Cylinder head cover bolt	12 N•m (1.2 kgf•m, 8.6 lbf•ft)	

SPECIAL TOOL

Valve spring compressor	E063
-------------------------	------

6. CYLINDER HEAD/VALVES

TROUBLESHOOTING

- The poor cylinder head operation can be diagnosed by a compression test or by tracing engine top-end noises.

Poor performance at idle speed

- Compression too low

Compression too low

- Incorrect valve clearance adjustment
- Burned or bent valves
- Incorrect valve timing
- Broken valve spring
- Poor valve and seat contact
- Leaking cylinder head gasket
- Warped or cracked cylinder head
- Poorly installed spark plug

Compression too high

- Excessive carbon build-up in combustion chamber

White smoke from exhaust muffler

- Worn valve stem or valve guide
- Damaged valve stem oil seal

Abnormal noise

- Incorrect valve clearance adjustment
- Sticking valve or broken valve spring
- Damaged or worn camshaft
- Worn cam chain tensioner
- Worn camshaft and rocker arm

6. CYLINDER HEAD/VALVES

CYLINDER HEAD COVER REMOVAL

Remove the met-in box.
Remove the body cover and center cover.
Disconnect the breather hose to air cleaner.
Remove the cylinder head cover four bolts.
Remove the cylinder head cover.

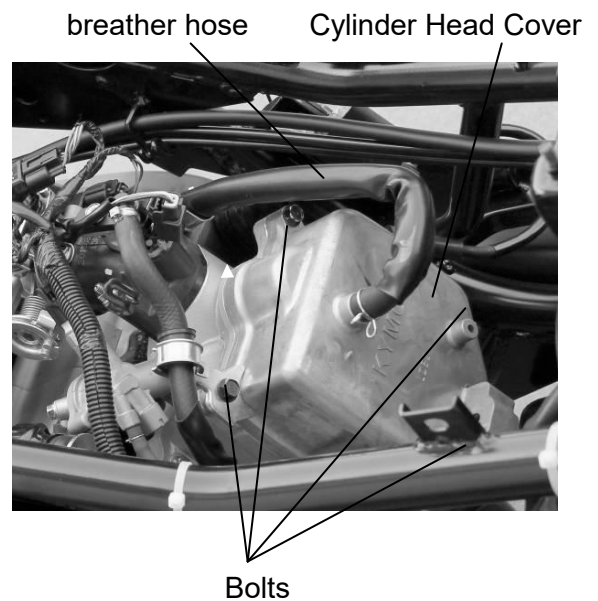

CAMSHAFT REMOVAL

Remove the injector and inlet pipe.
Remove two screws attaching the thermostat.

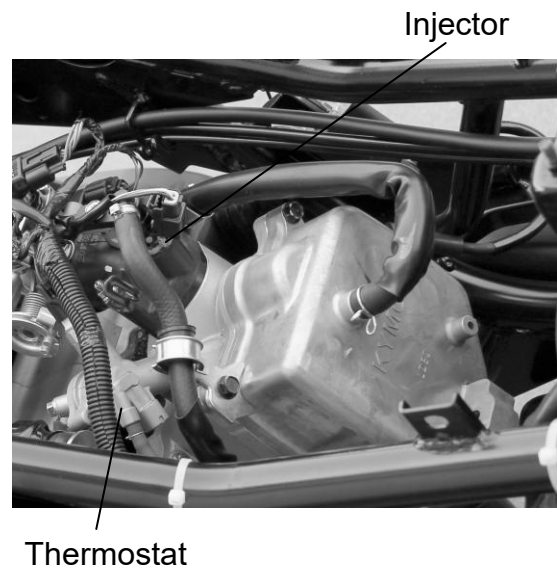

Turn the cam chain tensioner screw clockwise to tighten it.

Torque: 1.0 kgf-m (9.8 N-m)

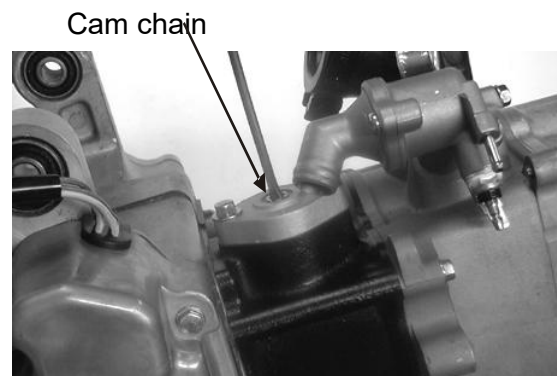

6. CYLINDER HEAD/VALVES

Remove the four cap nuts attaching the camshaft holder.

- * • Diagonally loosen the cylinder head cap nuts in 2 or 3 times.

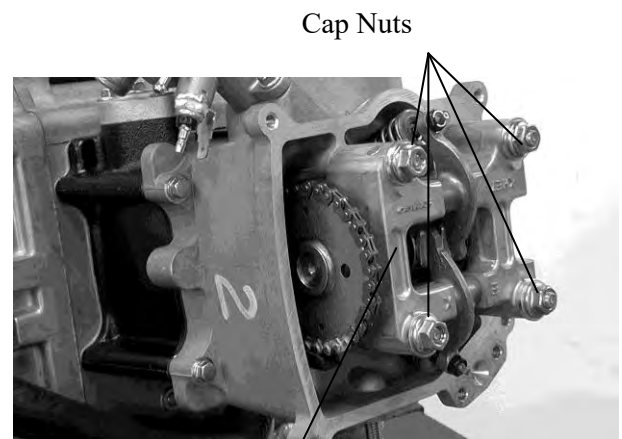

Cap Nuts

Camshaft Holder

Remove the camshaft holder and dowel pins.

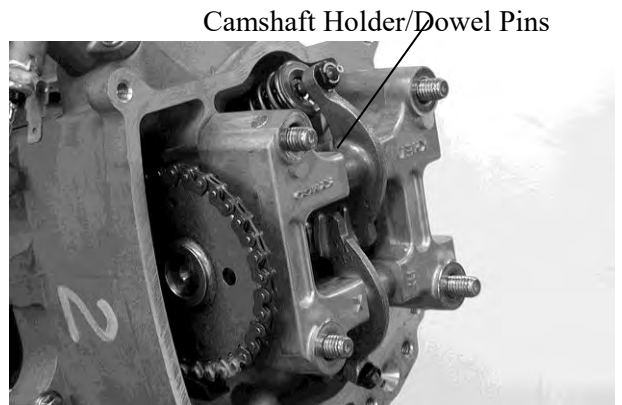

Camshaft Holder/Dowel Pins

Remove the camshaft gear from the cam chain to remove the camshaft.



Cam Chain

Camshaft Gear

6. CYLINDER HEAD/VALVES

INSPECTION

Camshaft

Check each cam lobe for wear or damage.
Measure the cam lobe height.

Service Limits: IN : 34.14 mm (1.3656 in)
EX: 34.02 mm (1.3608 in)

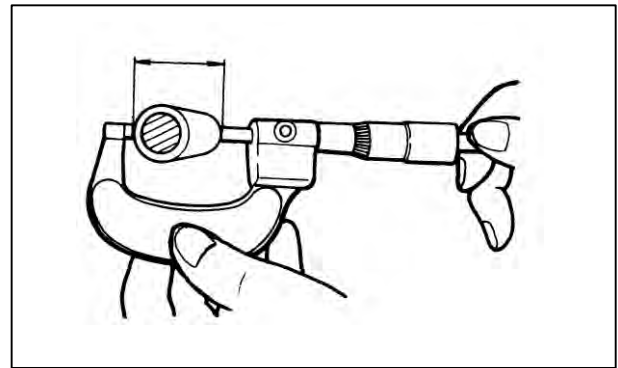

Check each camshaft bearing for play or damage. Replace the camshaft assembly with a new one if the bearings are noisy or have excessive play.

* If the surface of rocker arm is worn, check each cam lobe for wear or damage.



6. CYLINDER HEAD/VALVES

REMOVAL

Remove the camshaft .

Remove the rocker arm shafts and then remove the rocker arms.

INSPECTION

Camshaft holder

Inspect the bearing surface of camshaft holder for scoring, scratches, or evidence of insufficient lubrication.

Rocker arm shaft

Inspect the rocker arm shaft for blue discoloration or grooves.

If any defects are found, replace the rocker arm shaft with a new one, then inspect lubrication system.

Measure each rocker arm shaft O.D.

Measure the I.D. of each rocker arm.

Measure arm to shaft clearance.

Replace as a set if out of specification.

Service limits: 0.1 mm (0.004 in)

Inspect the rocker arm bore, cam lobe contact surface and adjuster surface for wear/pitting/scratches/blue discoloration.

If any defects are found, replace the rocker arm shaft with a new one, then inspect lubrication system.

Measure each rocker arm shaft O.D.

Measure the I.D. of each rocker arm.

Measure arm to shaft clearance.

Replace as a set if out of specification.

Service limits: 0.1 mm (0.004 in)

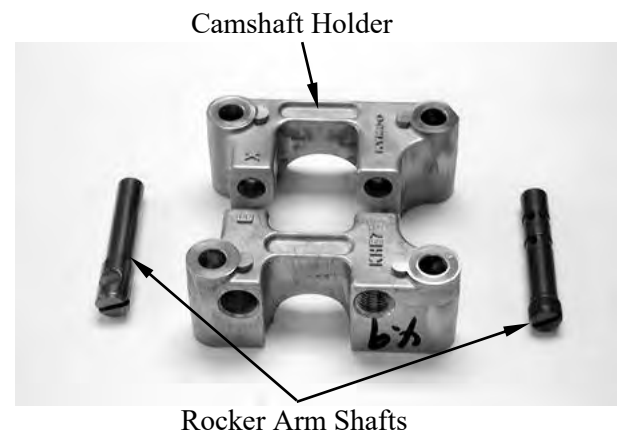
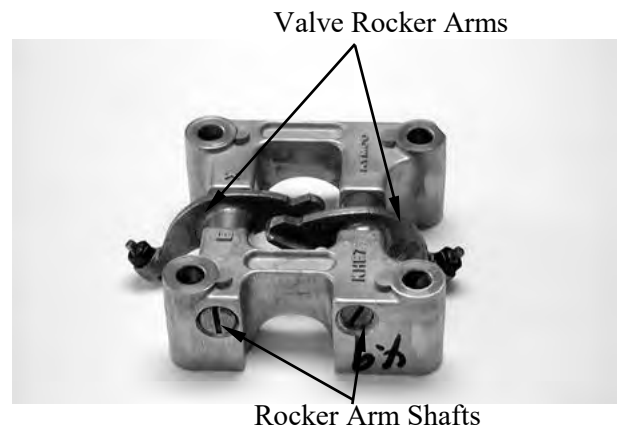

6. CYLINDER HEAD/VALVES

REMOVAL

First drain the coolant from the radiator and water jacket, then remove the thermostat water hose.

Remove the camshaft.

Remove the carburetor and intake pipe.

Remove the two cylinder bolts.

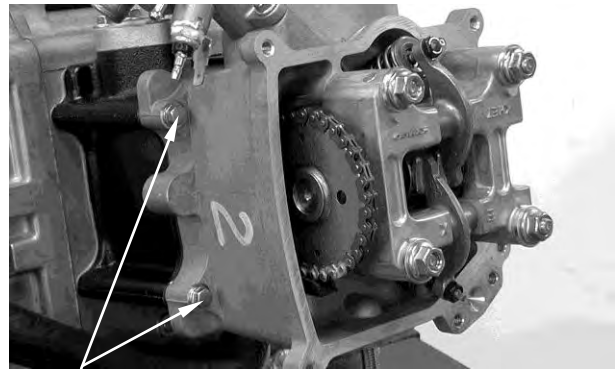

Cylinder Bolts

Remove the bolt attaching the thermostat housing and the thermostat housing.
Remove the cylinder head.

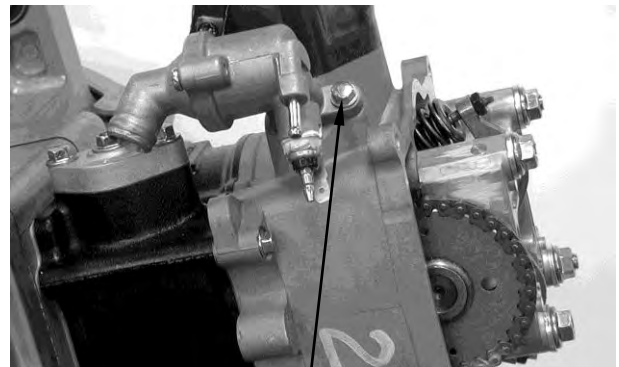

Bolt

Remove the dowel pins and cylinder head gasket.
Remove the cam chain guide.
Remove all gasket material from the cylinder head mating surface.

* Be careful not to drop any gasket material into the engine.

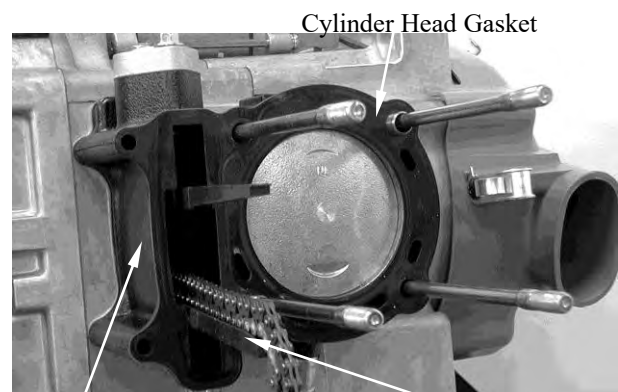

Cylinder

Cam Chain Tensioner Slipper

6. CYLINDER HEAD/VALVES

CYLINDER HEAD DISASSEMBLY

Remove the valve spring cotters, retainers, springs, spring seats, oil seals and valves using a valve spring compressor.

*

- Be sure to compress the valve springs with a valve spring compressor.
- Mark all disassembled parts to ensure correct reassembly.

Valve Spring Compressor

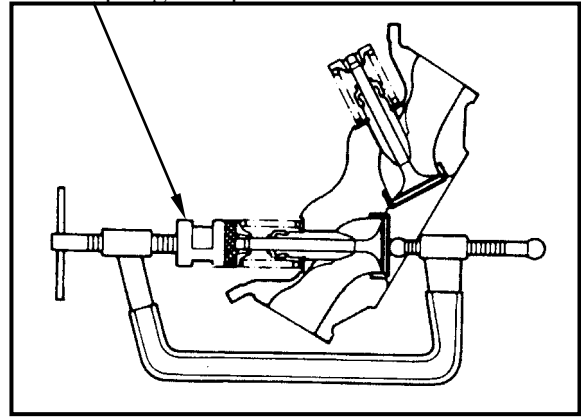

Special tool:

Valve Spring Compressor A120E00040

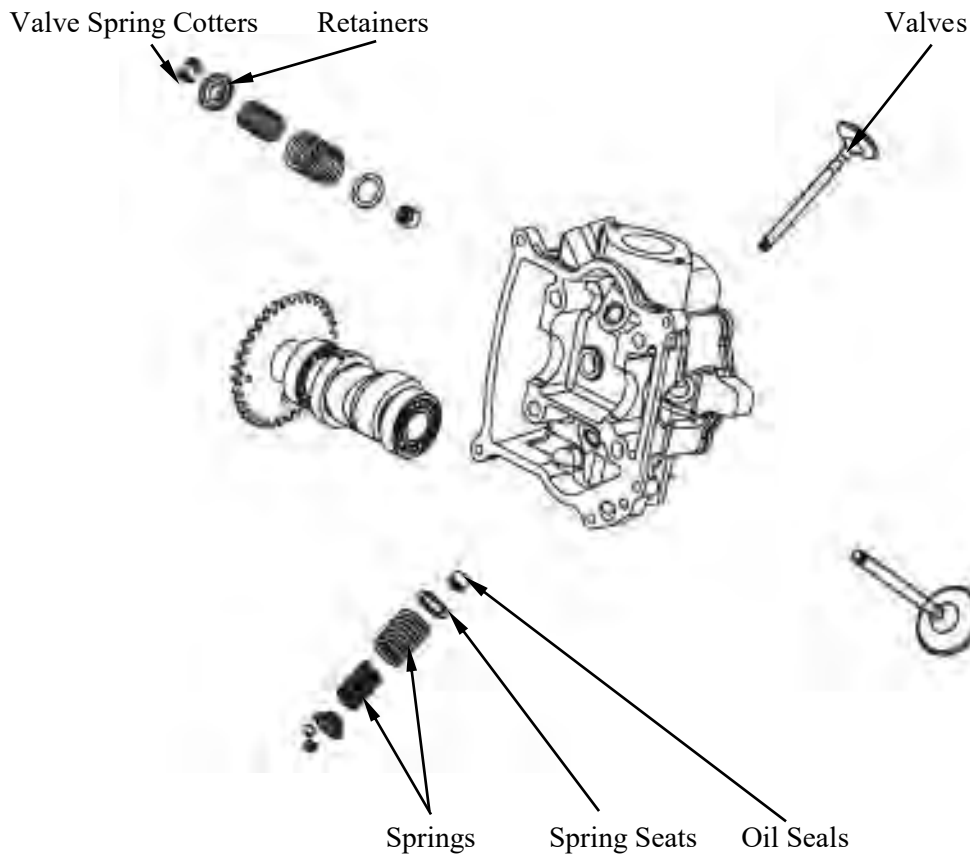

6. CYLINDER HEAD/VALVES

VALVE /VALVE GUIDE INSPECTION

Inspect each valve for bending, burning, scratches or abnormal stem wear.
If any defects are found, replace the valve with a new one.

Check valve movement in the guide.

Measure each valve stem O.D.

Measure each valve guide I.D.

Subtract each valve stem O.D. from the corresponding guide I.D. to obtain the stem-to-guide clearance.

Service limits:

IN: 0.08 mm (0.0032 in)

EX: 0.1 mm (0.004 in)

* If the stem-to-guide clearance exceeds the service limits, replace the cylinder head is necessary.

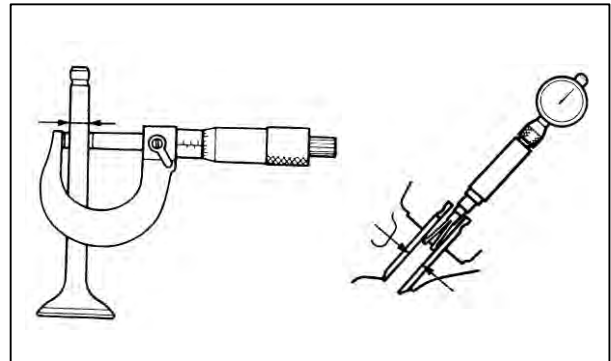

CYLINDER HEAD INPECTION

Check the spark plug hole and valve areas for cracks.

Check the cylinder head for warpage with a straight edge and feeler gauge.

Service Limit: 0.05 mm (0.002 in)

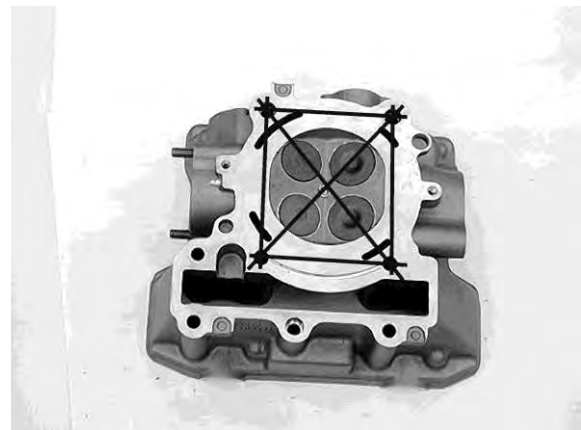

VALVE SPRING INSPECTION

Measure the free length of the inner and outer valve springs.

Service Limit:

Inner: 29.1 mm (1.164 in)

Outer: 39.2 mm (1.568 in)

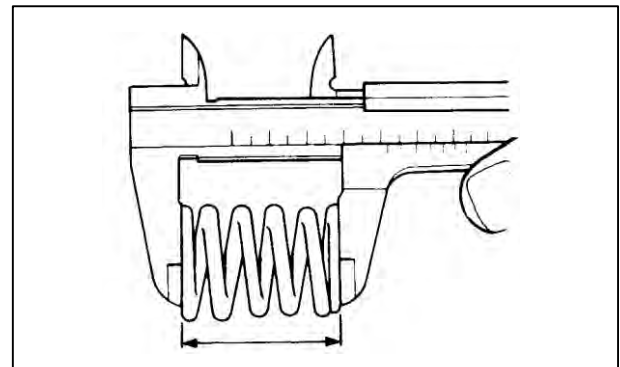

6. CYLINDER HEAD/VALVES

Measure compressed force (valve spring) and installed length.

Replace if out of specification.

Standard:

Inner: 2.95 kg (at 26.6 mm, 1.064 in)

Outer: 10.45 kg (at 29.6 mm, 1.184 in)

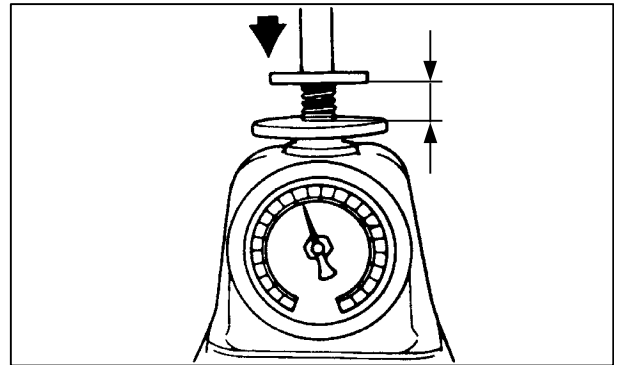

Measure the spring tilt.

Replace if out of specification.

Standard:

Inner: 0.81 mm (0.0324 in)

Outer: 1.07 mm (0.0428 in)

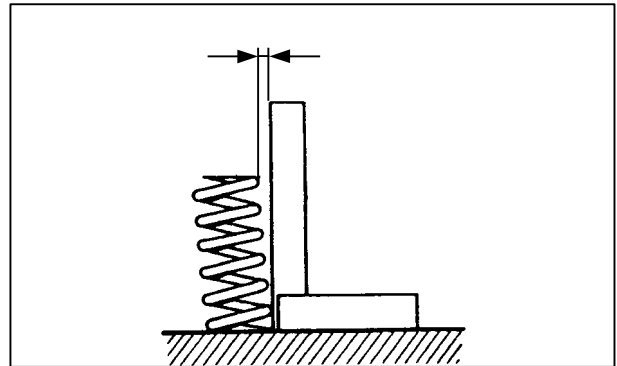

ASSEMBLY

Install the valve spring seats and oil seal.

* Be sure to install new oil seal.

Lubricate each valve with engine oil and insert the valves into the valve guides.
Install the valve springs and retainers.
Compress the valve springs using the valve spring compressor, then install the valve cotters.

* • When assembling, a valve spring compressor must be used.
• Install the cotters with the pointed ends facing down from the upper side of the cylinder head.

Valve Spring Compressor

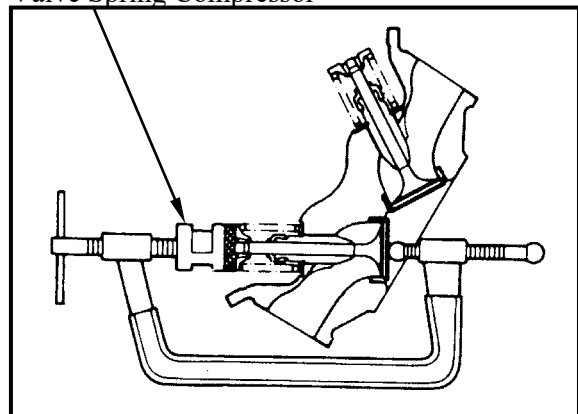

Special tool:

Valve Spring Compressor A120E00040

6. CYLINDER HEAD/VALVES

INSTALLATION

Install the cam chain guide.
Install the dowel pins and a new cylinder head gasket.

Gasket

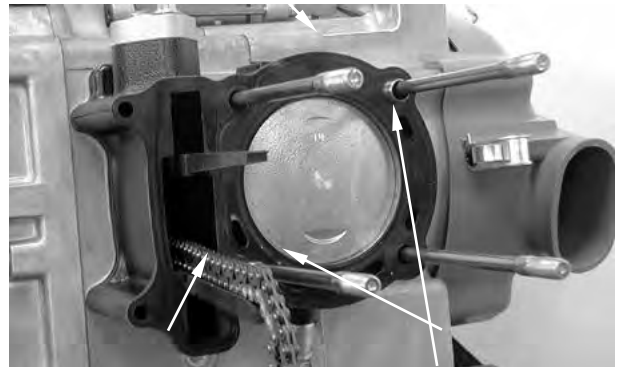

Install the cylinder head and take out the cam chain

Cam Chain

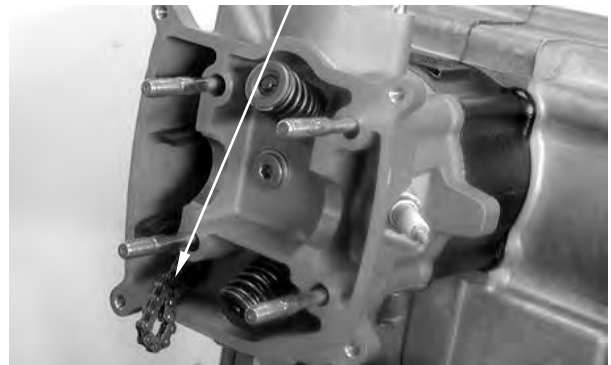

Assemble the camshaft holder.
First install the intake and exhaust valve rocker arms; then install the rocker arm shafts.

- * **•** Install the exhaust valve rocker arm shaft on the “EX” side of the camshaft holder and the exhaust rocker arm shaft is shorter.
- Clean the intake valve rocker arm shaft off any grease before installation.
- Align the cutout on the exhaust valve rocker arm shaft with the bolt of the camshaft holder.

Valve Rocker Arms



6. CYLINDER HEAD/VALVES

Turn the A.C. generator flywheel so that the “T” mark on the flywheel aligns with the index mark on the right crankcase cover. Keep the round hole on the camshaft gear facing up and align the punch marks on the camshaft gear with the cylinder head surface (Position the intake and exhaust cam lobes down.) and install the cam chain over the camshaft gear.

Install the dowel pins.

Punch Marks

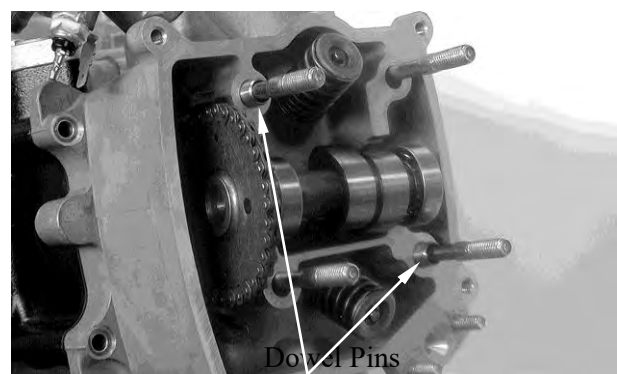
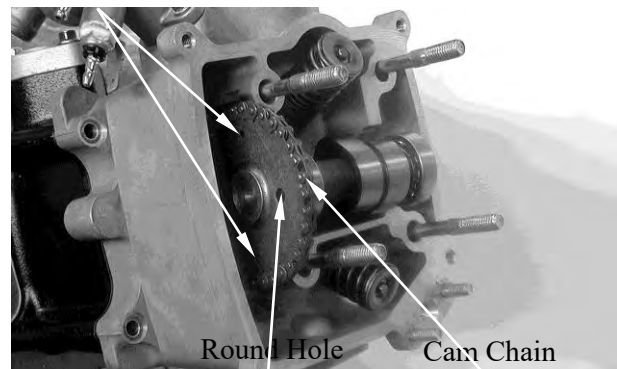

Camshaft Holder/Dowel Pins

Install the camshaft holder, washers and nuts on the cylinder head. Tighten the four cylinder head cap nuts and two cylinder bolts to the specified torque.

Torque:

Cylinder head cap nut:

25 N•m (2.5 kgf•m, 18 lbf•ft)

Apply engine oil to threads

Cylinder bolt: 10 N•m (1 kgf•m, 7 lbf•ft)

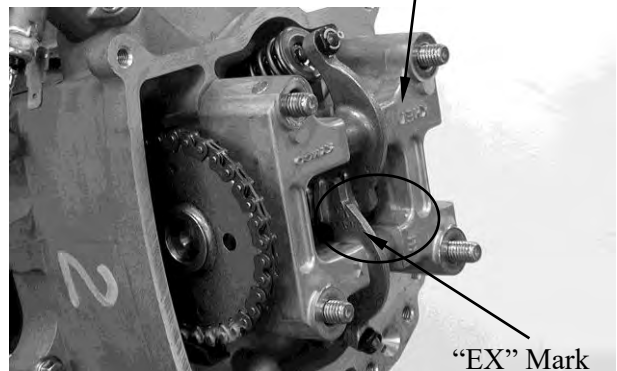

Washer

- ***
- Install the camshaft holder with the “EX” mark face exhaust valve side.
 - Apply engine oil to the threads of the cylinder head cap nuts.
 - Diagonally tighten the cylinder head cap nuts in 2~3 times.
 - First tighten the cylinder head cap nuts and then tighten the cylinder bolts to avoid cracks.

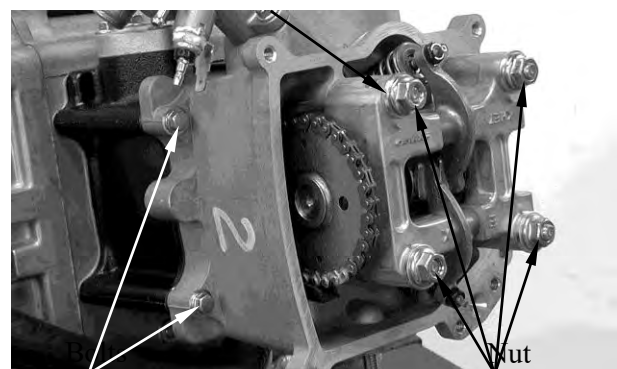

6. CYLINDER HEAD/VALVES

Turn the cam chain tension screw counterclockwise to release it.

Tensioner Screw

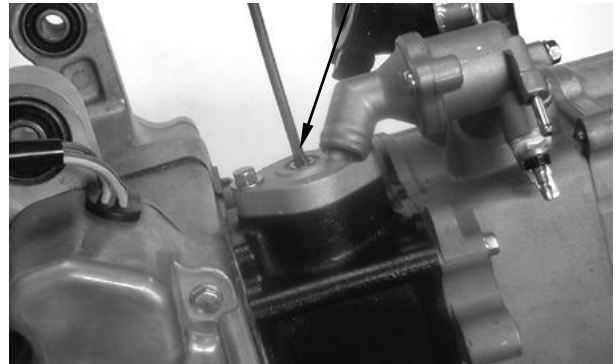

Apply engine oil to a new O-ring and install it.

Tighten the cam chain tension cap screw.

* Be sure to install the gasket into the groove properly.

O-ring

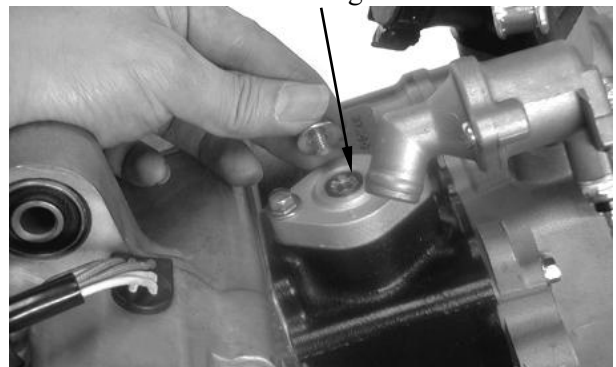

Adjust the valve clearance.

Install a new cylinder head cover O-ring and install the cylinder head cover.

* Be sure to install the O-ring into the groove properly.

Install and tighten the cylinder head cover bolts.

Torque: 10 N•m (1 kgf•m, 7 lbf•ft)

Cylinder Head Cover

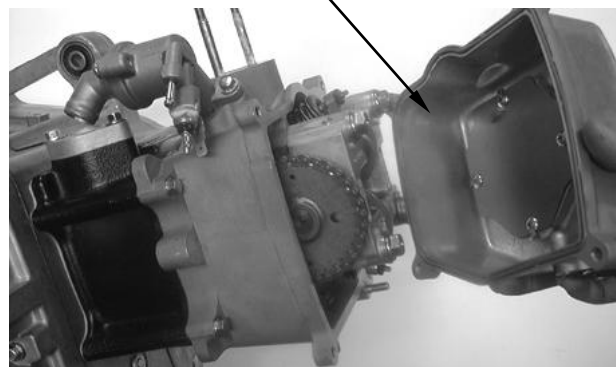

7. CYLINDER/PISTON

7

CYLINDER/PISTON

SCHEMATIC DRAWING	7-1
SERVICE INFORMATION	7-2
TROUBLESHOOTING	7-2
CYLINDER REMOVAL	7-3
PISTON REMOVAL	7-3
PISTON INSTALLATION	7-7
CYLINDER INSTALLATION	7-7

7. CYLINDER/PISTON

SCHEMATIC DRAWING

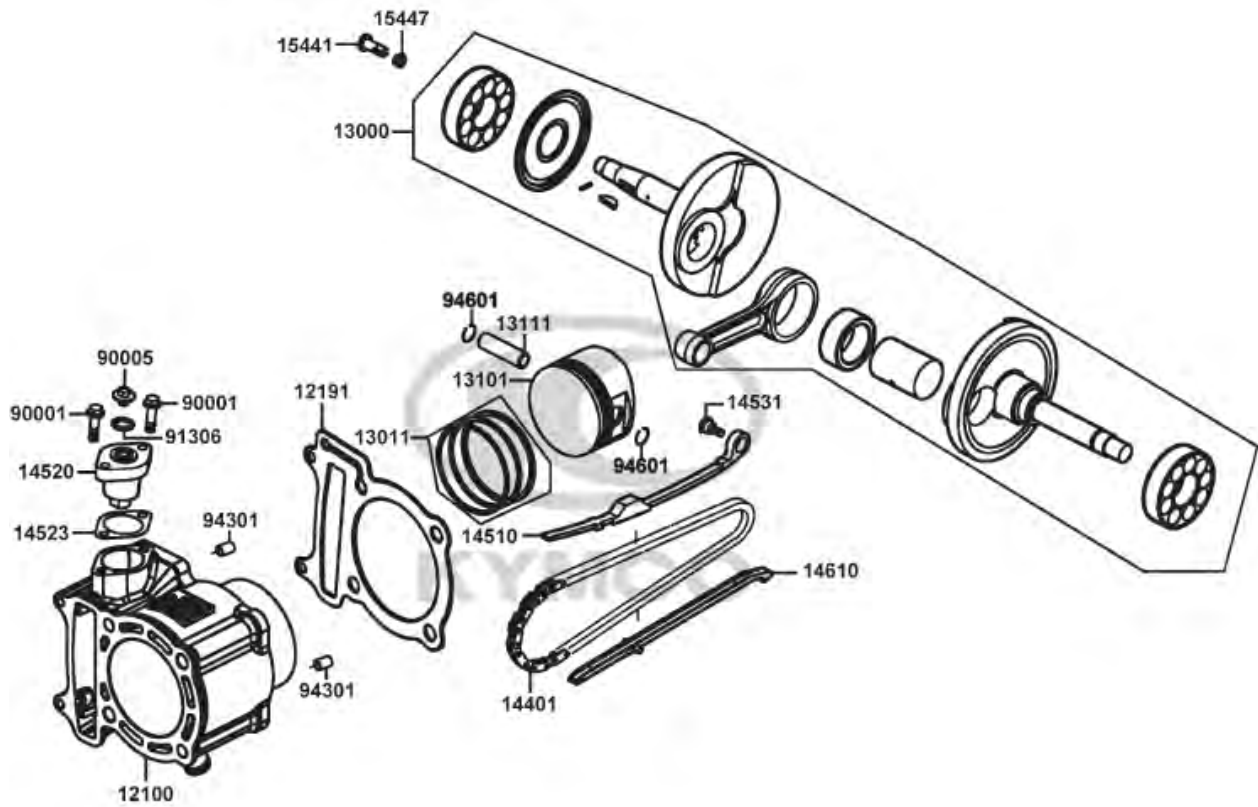

7. CYLINDER/PISTON

SERVICE INFORMATION

GENERAL INSTRUCTIONS

- The cylinder and piston can be serviced with the engine installed in the frame.
- When installing the cylinder, use a new cylinder gasket and make sure that the dowel pins are correctly installed.
- After disassembly, clean the removed parts and dry them with compressed air before inspection.

SPECIFICATIONS

Unit: mm (in)

Item		Standard	Service Limit	
Cylinder	I.D.	72.75 (2.91)~72.7015 (2.90806)	72.8 (2.912)	
	Warpage	0.01 (0.0004)	0.05 (0.002)	
	Cylindricity	0.01 (0.0004)	0.1 (0.004)	
	True roundness	0.01 (0.0004)	0.1 (0.004)	
Piston, piston ring	Ring-to-groove clearance	top	0.03 (0.0012)~0.065 (0.0026)	0.08 (0.003)
		Second	0.015 (0.0006)~0.05 (0.002)	0.65 (0.0026)
	Ring end gap	top	0.15 (0.006)~0.3 (0.012)	0.5 (0.02)
		Second	0.03 (0.012)~0.45 (0.018)	0.65 (0.026)
		Oil side rail	0.2 (0.008)~0.7 (0.028)	1 (0.04)
	Piston O.D.	72.67 (2.9068)~72.69 (2.9076)	72.6 (2.904)	
	Piston O.D. measuring position	9 mm from bottom of skirt	—	
	Piston-to-cylinder clearance	0.01 (0.0004)~0.045 (0.0018)	0.1 (0.004)	
Piston pin hole I.D.	17.002 (0.68008)~17.008 (0.68032)	17.04 (0.6816)		
Piston pin O.D		16.994 (0.67976)~17 (0.68)	16.96 (0.6784)	
Piston-to-piston pin clearance		0.002 (0.0001)~0.014 (0.0006)	0.02 (0.001)	
Connecting rod small end I.D. bore		17.016 (0.68064)~17.034 (0.68136)	17.06 (0.6824)	

TROUBLESHOOTING

- When hard starting or poor performance at low speed occurs, check the crankcase breather for white smoke. If white smoke is found, it means that the piston rings are worn, stuck or broken.

Compression too low or uneven compression

- Worn or damaged cylinder and piston rings
- Worn, stuck or broken piston rings

Excessive smoke from exhaust muffler

- Worn or damaged piston rings
- Worn or damaged cylinder and piston

Compression too high

- Excessive carbon build-up in combustion chamber or on piston head

Abnormal noisy piston

- Worn cylinder, piston and piston rings
- Worn piston pin hole and piston pin
- Incorrectly installed piston

7. CYLINDER/PISTON

REMOVAL

Remove the cylinder head.

Remove the water hose from the cylinder.
Remove the cylinder head gasket and dowel pine.

Remove the cam chain guide.
Remove the cylinder.

Remove the cylinder gasket and dowel pins.
Clean any gasket material from the cylinder surface.

Remove the piston pin clip.

* Place a clean shop towel in the crankcase to keep the piston pin clip from falling into the crankcase.

Press the piston pin out of the piston and remove the piston.

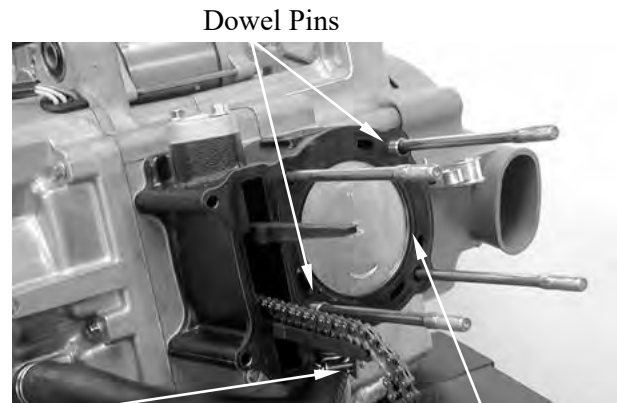

Water Hose Gasket

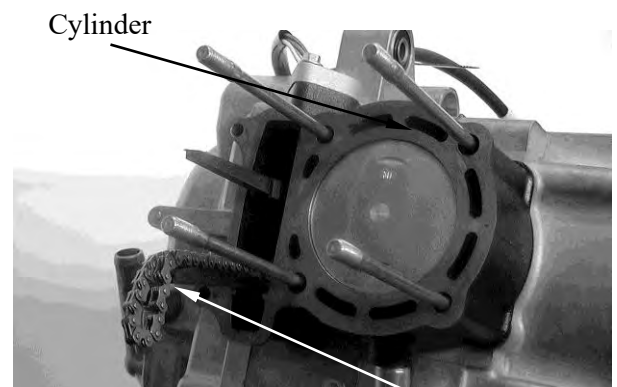

Cam Chain Guide

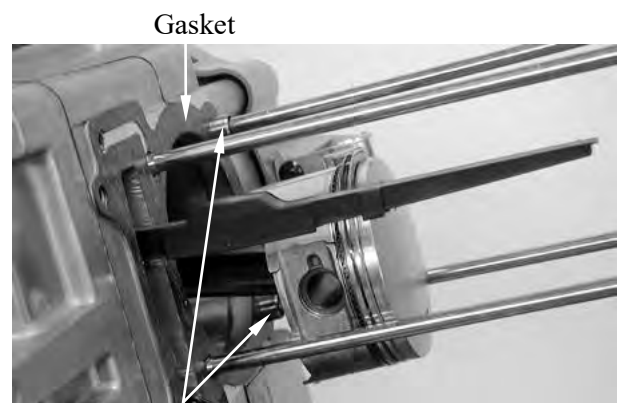

Dowel Pins

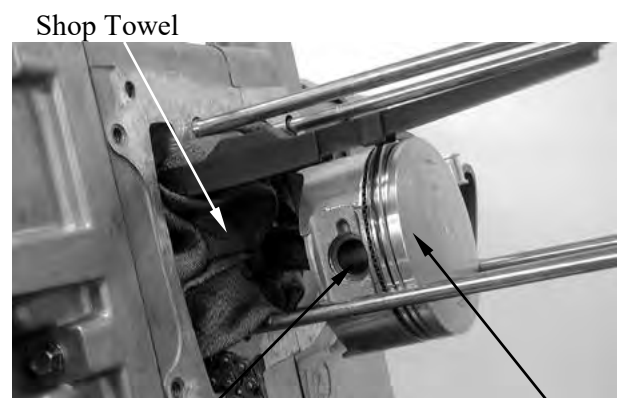

Piston Pin Piston

7. CYLINDER/PISTON

PISTON RING REMOVAL

Spread each piston ring and remove it by lifting up at a point opposite the gap

* Do not damage the piston ring by spreading the ends too far.

Clean carbon deposits from the piston ring grooves.

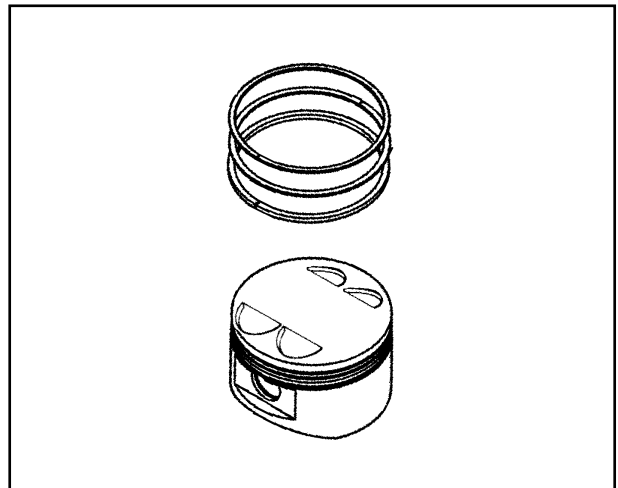

INSPECTION

Piston ring

Inspect the piston rings for movement by rotating the rings. The rings should be able to move in their grooves without catching.

Push the ring until the outer surface of the piston ring is nearly flush with the piston and measure the ring-to-groove clearance.

Service Limits: Top: 0.08 mm (0.003 in)
2nd: 0.065 mm (0.0026 in)

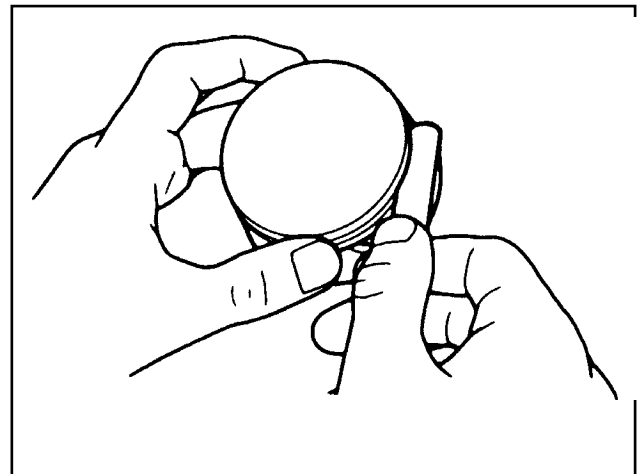

Insert each piston ring into the bottom of the cylinder squarely.

* Use the piston head to push each piston ring into the cylinder.

Measure the piston ring end gap.

Service Limit:

Top: 0.5 mm (0.02 in)
2nd: 0.65 mm (0.026 in)
Oil ring: 1 mm (0.04 in)

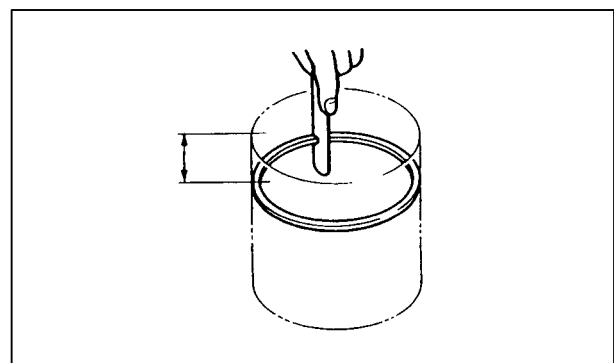

7. CYLINDER/PISTON

Piston/Piston pin

Measure the piston O.D. at the point (A) from the bottom and 90° to the piston pin hole.

Service Limit:

72.6 mm (2.904 in) at (A): 9 mm

Calculate the cylinder-to-piston clearance

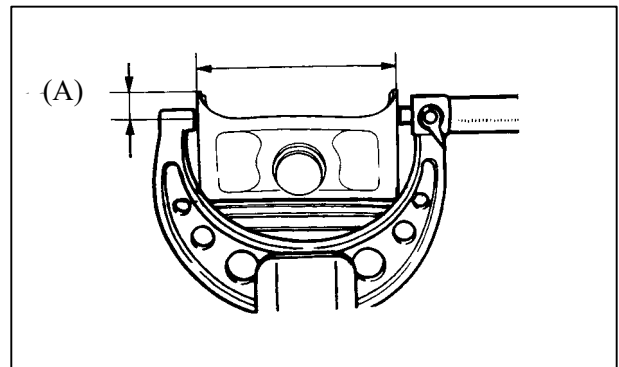

Measure the piston pin hole. Take the maximum reading to determine the I.D..

Service Limit: 17.04 mm (0.6816 in)

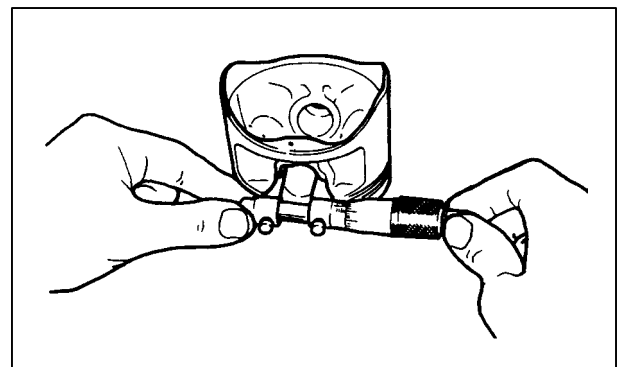

Measure the piston pin O.D. at piston and connecting rod sliding areas.

Service Limit: 16.96 mm (0.6784 in)

Measure the piston-to-piston pin clearance.

Service Limit: 0.002 mm (0.0001 in)

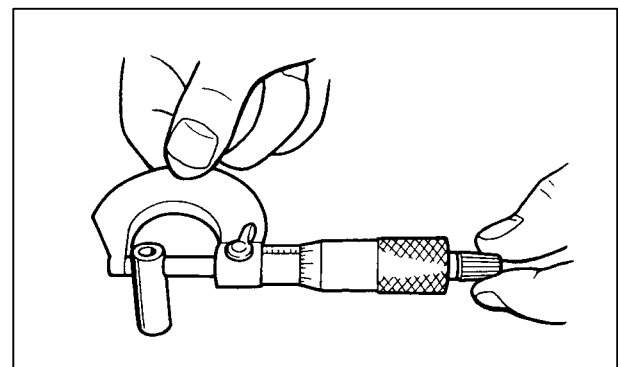

7. CYLINDER/PISTON

Cylinder

Check the cylinder for warpage with a straight edge and feeler gauge in the directions shown.

Service Limit: 0.05 mm (0.002 in)

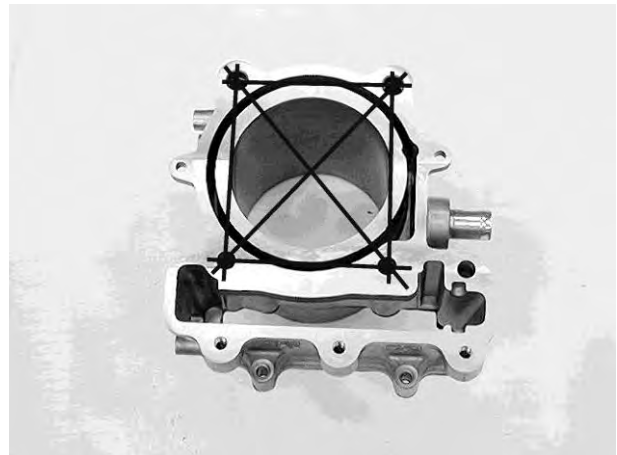

Check the cylinder wall for wear or damage. Measure and record the cylinder I.D. at three levels in an X and Y axis. Take the maximum reading to determine the cylinder wear.

Service Limit: 72.8 mm (2.912 in)

Calculate the piston-to-cylinder clearance. Take a maximum reading to determine the clearance. Refer to page 10-7 for measurement of the piston O.D..

Service Limit: 0.1 mm (0.004 in)

Calculate the taper and out-of-round at three levels in an X and Y axis. Take the maximum reading to determine them.

Service Limit:

Taper: 0.1 mm (0.004 in)

Out-of-round: 0.1 mm (0.004 in)

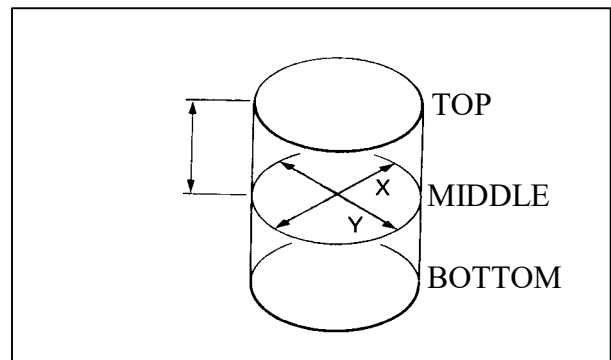

7. CYLINDER/PISTON

Measure the connecting rod small end I.D..

Service Limit: 17.06 mm (0.6824 in)

Calculate the connecting rod-to-piston pin clearance.

Service Limit: 0.06 mm (0.002 in)

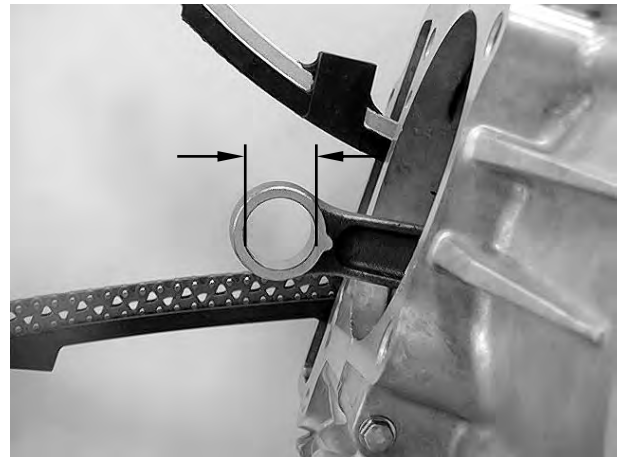

PISTON RING INSTALLATION

Carefully install the piston rings into the piston ring grooves with the markings facing up.

* Be careful not to damage the piston and rings.

- ♦ Do not confuse the top and second rings.
- ♦ To install the oil ring, install the oil ring, then install the side rails.

Stagger the piston ring end gaps 120° degrees apart from each other.

Stagger the side rail end gaps as shown.

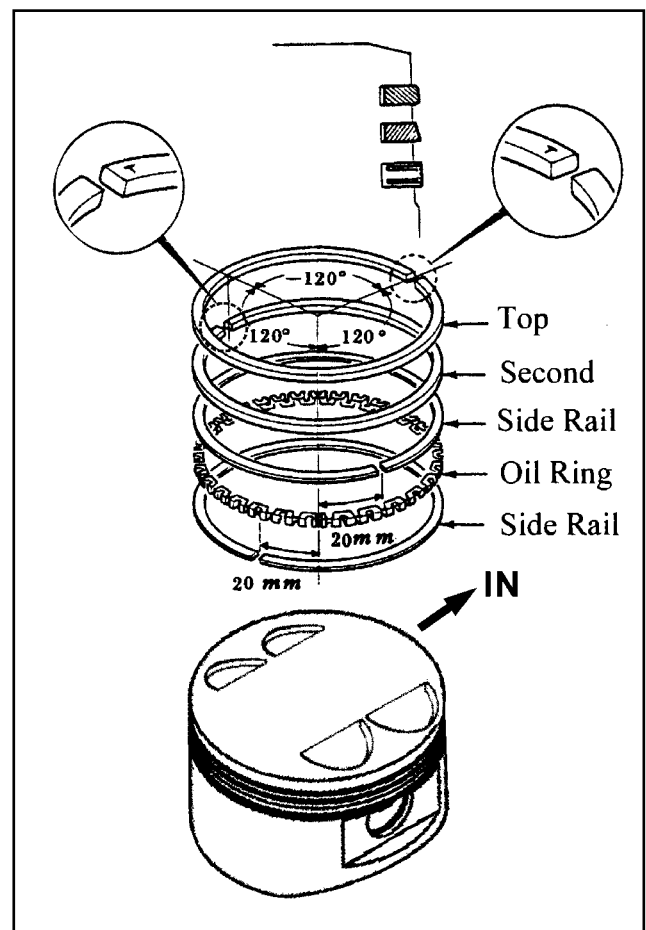

7. CYLINDER/PISTON

CYLINDER/PISTON INSTALLATION

Remove any gasket material from the crankcase surface.

- *
 - Be careful not to drop foreign matters into the crankcase.



Install the piston, piston pin and a new piston pin clip.

- *
 - Position the piston "IN" mark on the intake valve side.
 - Place a clean shop towel in the crankcase to keep the piston pin clip from falling into the crankcase.

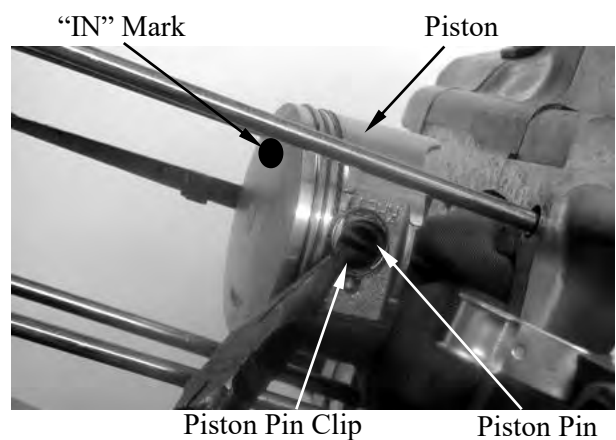

Install the dowel pins and a new cylinder gasket on the crankcase.

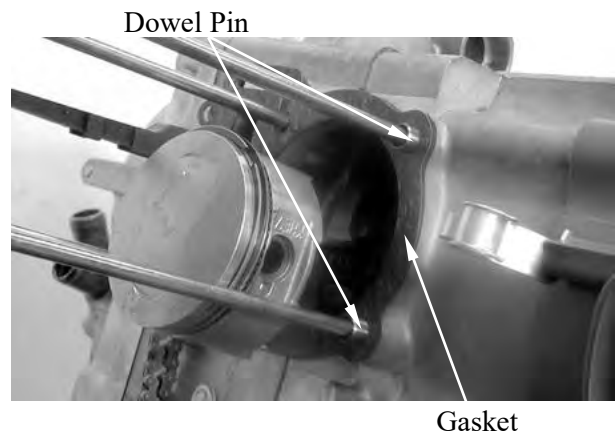

Coat the cylinder bore, piston and piston rings with clean engine oil. Carefully lower the cylinder over the piston by compressing the piston rings.

- *
 - Be careful not to damage or break the piston rings.
 - The piston ring end gaps should not be parallel with or at 90° to the piston pin.

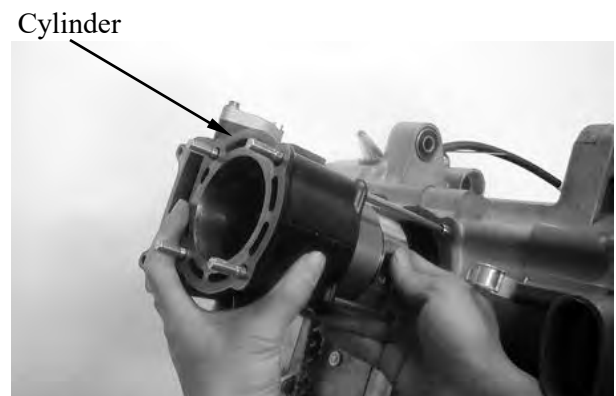

7. CYLINDER/PISTON

Install the cam chain guide.

- * • Insert the tab on the cam chain guide into the cylinder groove.

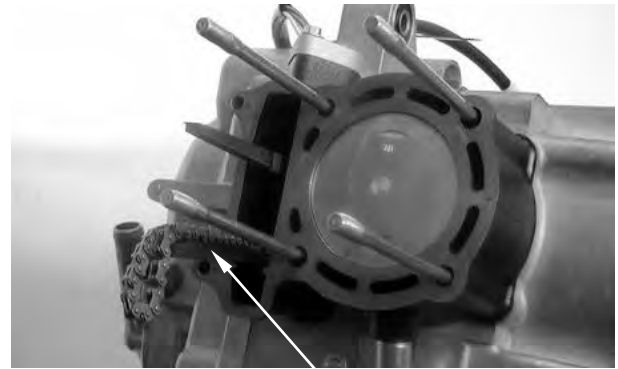

Cam Chain Guide

Install the cylinder gasket and dowel pins.
Connect the water hose to the cylinder.

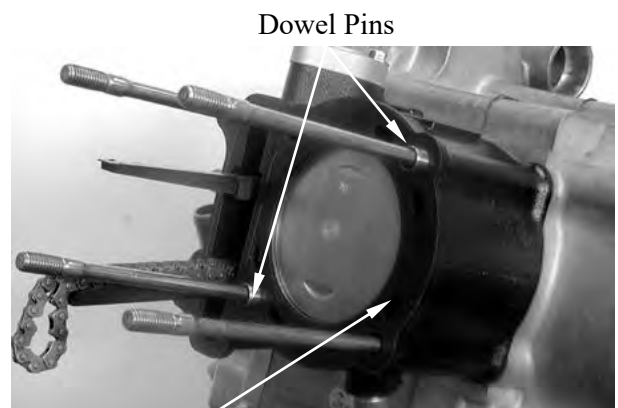

Dowel Pins

Gasket

8. DRIVE AND DRIVEN PULLEYS/ V-BELT



X-Town300 ABS

DRIVE AND DRIVEN PULLEYS/V-BELT

SCHEMATIC DRAWING	8- 1
SERVICE INFORMATION	8- 2
TROUBLESHOOTING	8- 2
LEFT CRANKCASE COVER	8- 3
DRIVE PULLEY.....	8- 3
CLUTCH OUTER/DRIVEN PULLEY/V-BELT	8- 3



8. DRIVE AND DRIVEN PULLEYS/ V-BELT

SCHEMATIC DRAWING

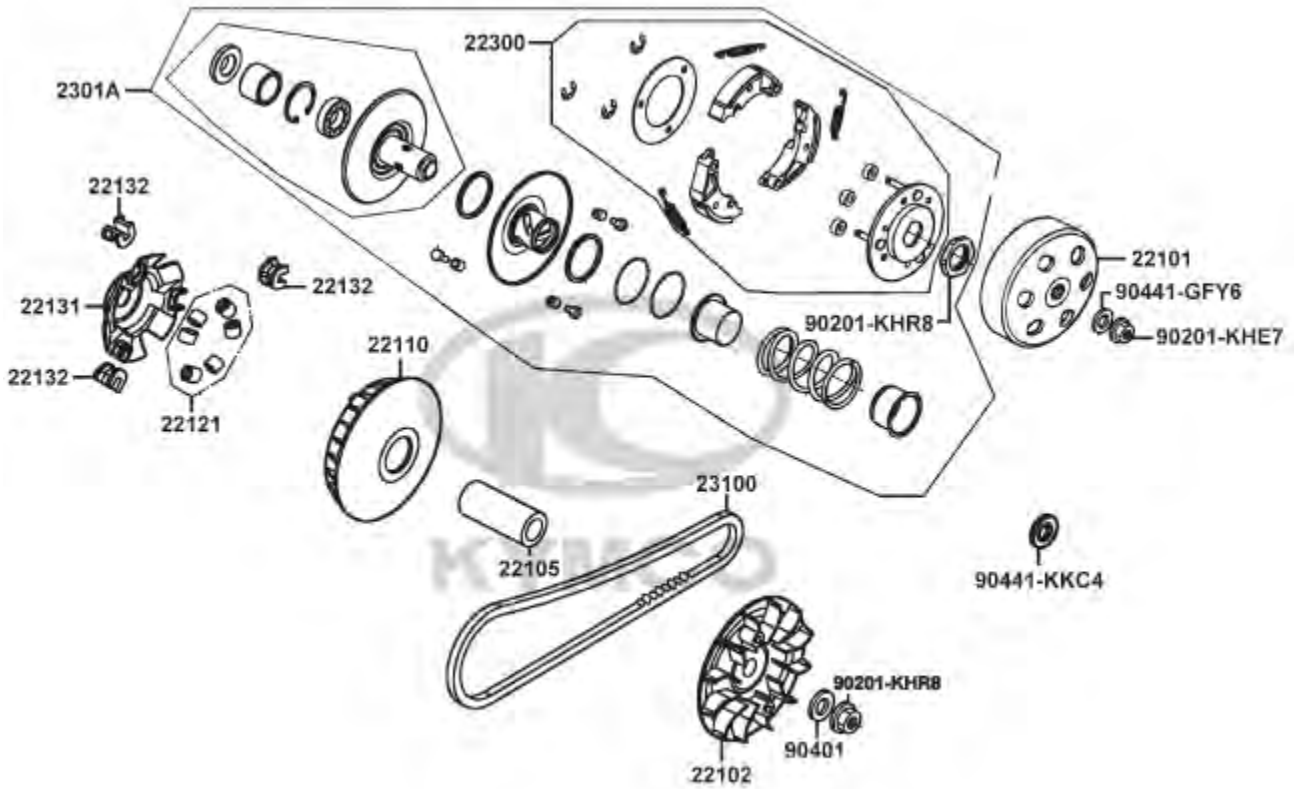

8. DRIVE AND DRIVEN PULLEYS/ V-BELT

SERVICE INFORMATION

GENERAL INSTRUCTIONS

- The drive pulley, clutch and driven pulley can be serviced with the engine installed.
- Avoid getting grease and oil on the drive belt and pulley faces. Remove any oil or grease from them to minimize the slipping of drive belt and drive pulley.

SPECIFICATIONS

Item	Standard (mm)	Service Limit (mm)
Clutch lining thickness	4.0	2.0
Clutch outer I.D.	152.1 ~ 152.2	152.2
Weight roller O.D	19.92 ~ 20.08	20

TORQUE VALUES

Drive face nut	9.5 kgf-m (93.1 N-m)	Apply oil
Clutch outer nut	5.5 kgf-m (54 N-m)	
Clutch drive plate nut	5.5 kgf-m (54 N-m)	

SPECIAL TOOLS

Universal holder	E017
Clutch spring compressor/#41 Nut & Fitting	E053 & E028

TROUBLESHOOTING

Engine starts but motorcycle won't move

- Worn drive belt
- Broken ramp plate
- Worn or damaged clutch lining
- Broken driven face spring

Lack of power

- Worn drive belt
- Weak driven face spring
- Worn weight roller
- Faulty driven face

Engine stalls or motorcycle creeps

- Broken clutch weight spring

8. DRIVE AND DRIVEN PULLEYS/ V-BELT

LEFT CRANKCASE COVER

REMOVAL

Remove the bolts attaching to the left crankcase cover.
Remove the gasket and dowel pins.



Left Crankcase Cover

Dowel Pins

DRIVE PULLEY

DRIVE PULLEY FACE REMOVAL

Remove the left crankcase cover.
Hold the drive pulley using a universal holder and remove the drive face nut and washer.
Remove the drive pulley face.



Universal HolderE017

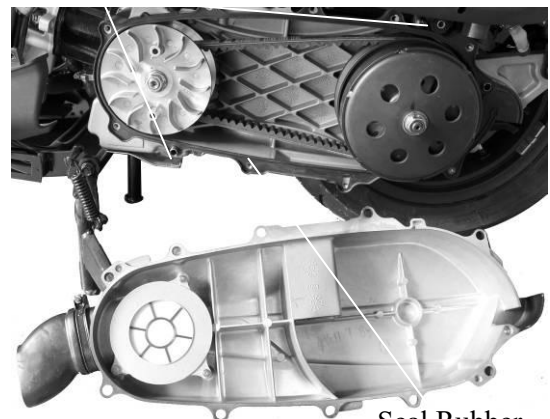

Seal Rubber

Drive Pulley Face

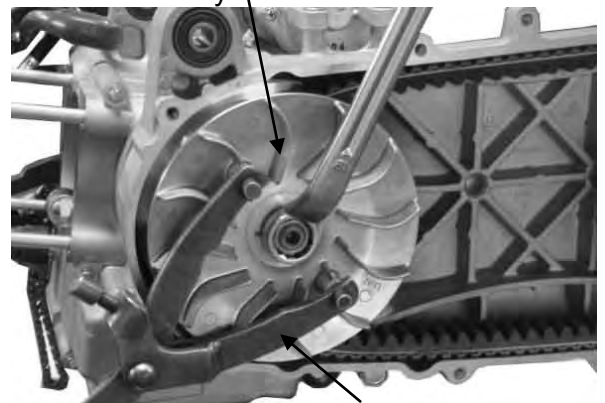

Universal Holder
Nut

CLUTCH OUTER/DRIVEN PULLEY/V-BELT

REMOVAL

Remove the drive pulley face.
Hold the clutch outer with the universal holder and remove the clutch outer nut, bushing and washer.

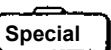

Universal HolderE017

Remove the clutch outer, driven pulley and belt together.

Remove the drive belt from the movable drive face.



Movable Drive Face

8. DRIVE AND DRIVEN PULLEYS/ V-BELT

INSPECTION

Check the drive belt for cracks, separation or abnormal or excessive wear.

Replace a new belt at every 15,000km.

- * • Use specified genuine parts for replacement.



MOVABLE DRIVE FACE ASSEMBLY

Remove the pulley face, clutch outer, driven pulley and belt.

Remove the movable drive face assembly.

Remove the drive pulley collar.

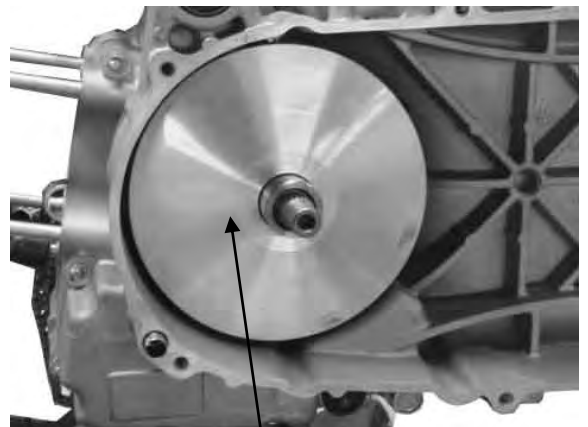

Movable Drive Face Assembly

DISASSEMBLY

Remove the ramp plate.

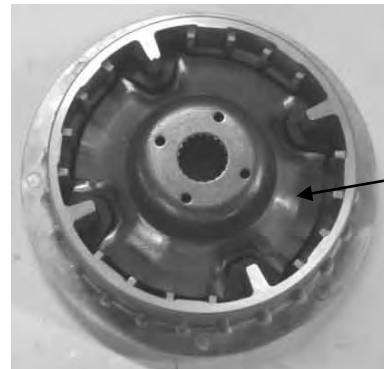

Ramp Plate

Remove the weight rollers.

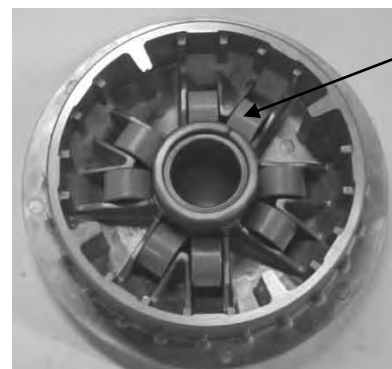

Weight Roller

8. DRIVE AND DRIVEN PULLEYS/ V-BELT

INSPECTION

Check each weight roller for wear or damage.



Check the movable drive face bushing for wear or damage.



ASSEMBLY

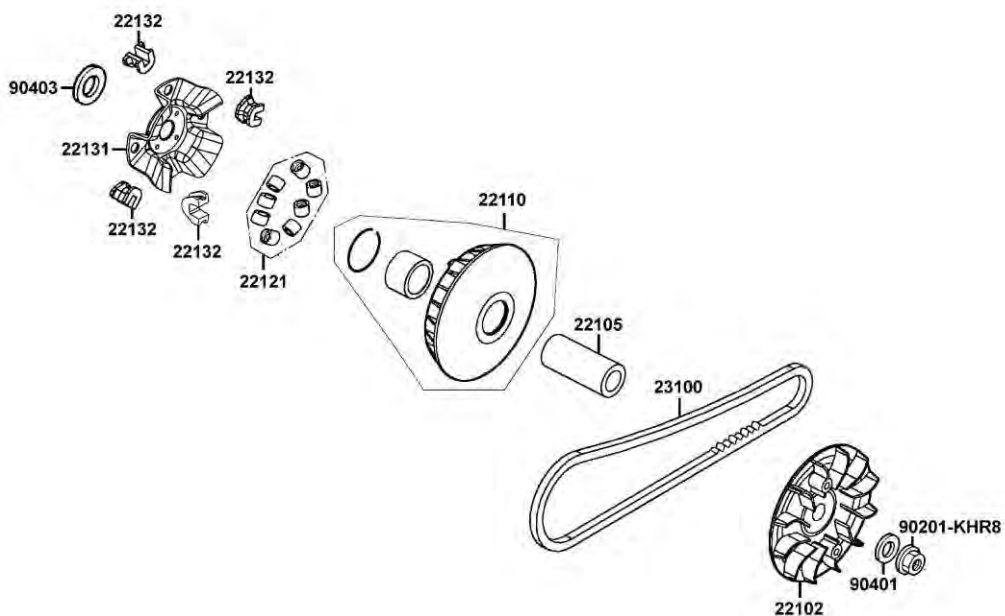

8. DRIVE AND DRIVEN PULLEYS/ V-BELT

Install the weight rollers into the movable drive face.

- * The direction of all weight rolls is same. The color side is towards to clockwise.

Install the ramp plate.

Insert the drive pulley collar into the movable drive face.

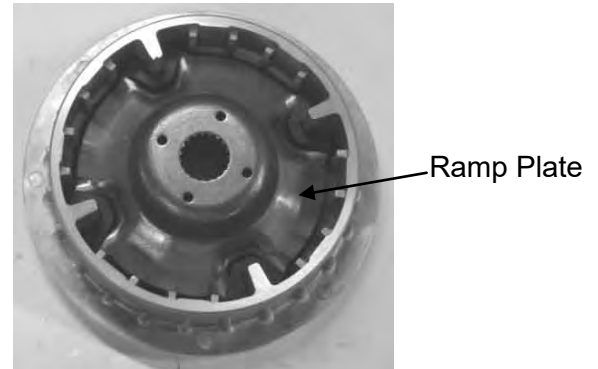

INSPECTION

Inspect the clutch outer for wear or damage. Measure the clutch outer I.D.

Service Limit: 153.5 mm replace if over

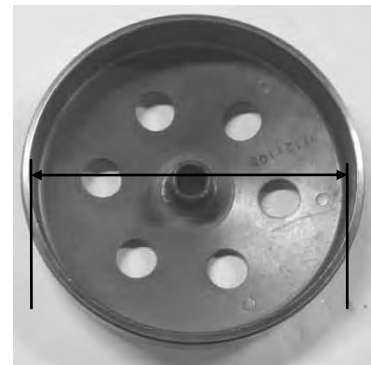

Check the clutch shoes for wear or damage. Measure the clutch lining thickness.

Service Limit: 2.0 mm replace if below

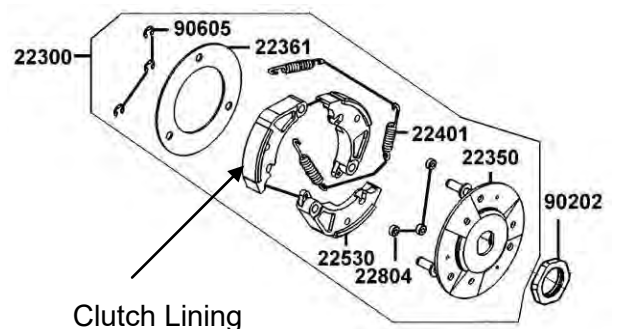

8. DRIVE AND DRIVEN PULLEYS/ V-BELT

CLUTCH/DRIVEN PULLEY DISASSEMBLY

Hold the clutch/driven pulley assembly with the clutch spring compressor.

Set the tool in a vise and remove the clutch drive plate nut.

* Be sure to use a clutch spring compressor to avoid spring damage.

Special

- Clutch Spring Compressor E053
- Fittings & Nut Wrench, 41mm E033

Loosen the clutch spring compressor and disassemble the clutch/driven pulley assembly.
Remove the seal collar.

Pull out the guide roller pins and guide rollers.
Remove the movable driven face from the driven face.

Remove the oil seal from the movable driven face.

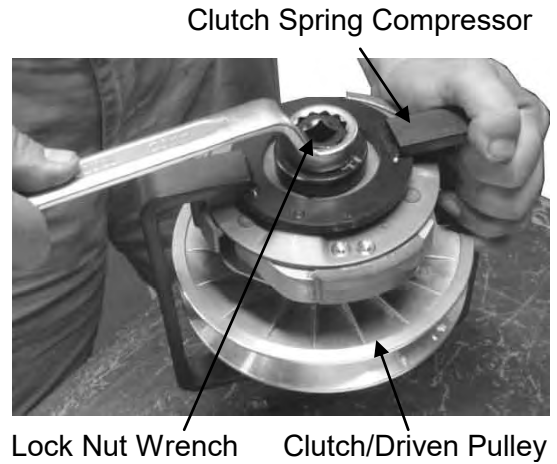

ASSEMBLY

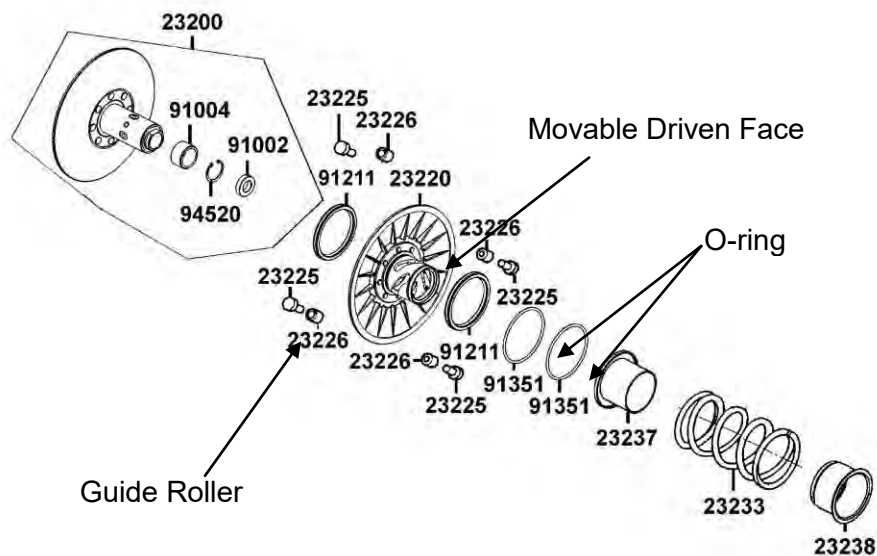

8. DRIVE AND DRIVEN PULLEYS/ V-BELT

INSPECTION

Measure the driven face spring free length.

Service Limit: 136 mm replace if below

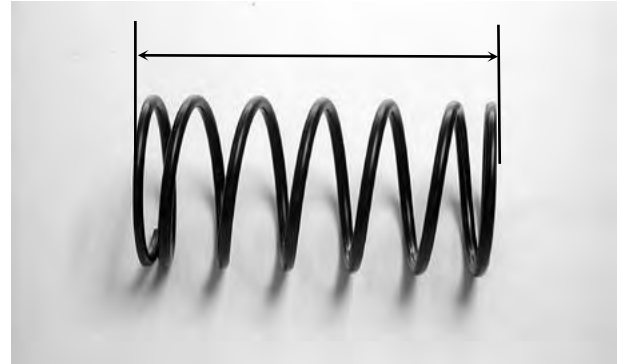

DRIVEN PULLEY FACE BEARING REPLACEMENT

Check the bearings for play and replace them if they have excessive play.

Drive the inner needle bearing out of the driven pulley face.

- * Discard the removed bearing and replace with a new one.

Remove the snap ring and drive the outer bearing out of the driven face.

- * Discard the removed bearing and replace with a new one.

Apply grease to the outer bearing.
Drive a new outer bearing into the driven face with the sealed end facing up.

Seat the snap ring in its groove.
Apply grease to the driven face bore areas.

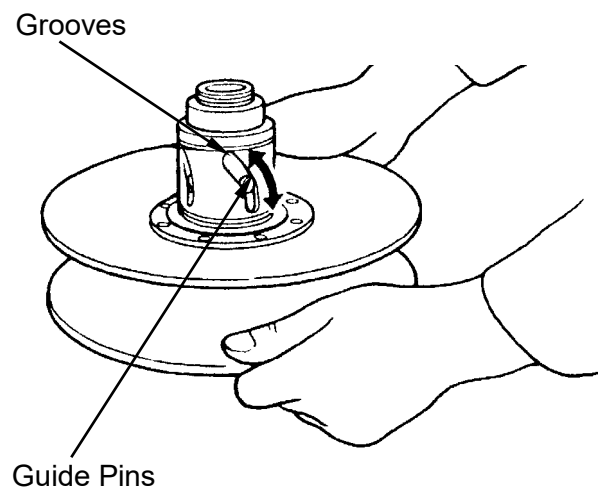

8. DRIVE AND DRIVEN PULLEYS/ V-BELT

Press a new needle bearing into the driven face.

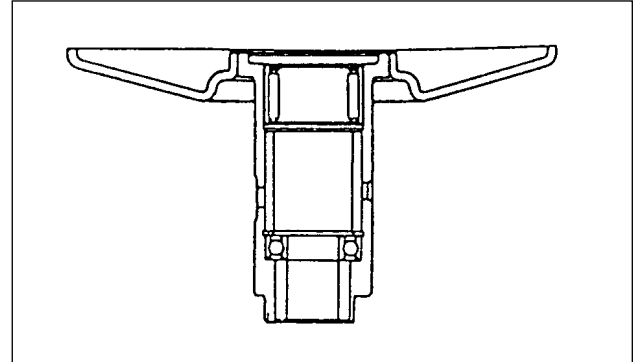

CLUTCH DISASSEMBLY

Remove the clips and retainer plate to disassemble the clutch.

- * • Keep grease off the clutch linings.

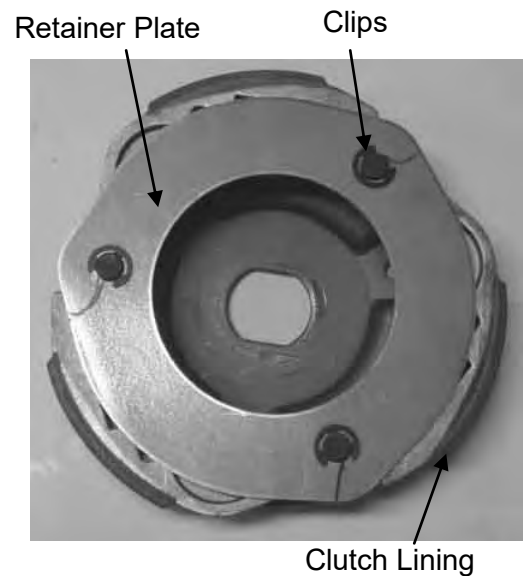

8. DRIVE AND DRIVEN PULLEYS/ V-BELT

CLUTCH ASSEMBLY

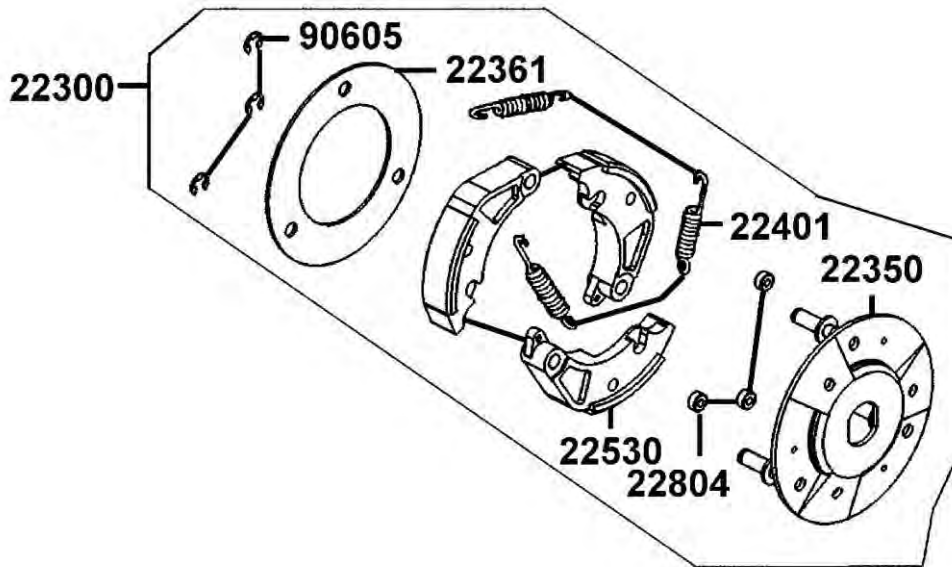

Install the damper rubbers on the drive plate pins.
Install the clutch weights/shoes and clutch springs onto the drive plate.
Install the retainer plate and secure with the clips.

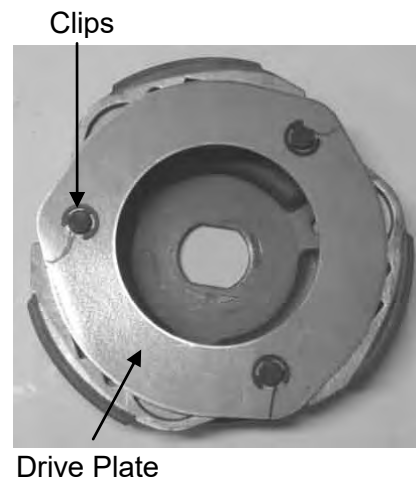

CLUTCH / DRIVEN PULLEY ASSEMBLY

Clean the pulley faces and remove any grease from them.
Apply grease to the O-rings and install them onto the moveable driven face.



8. DRIVE AND DRIVEN PULLEYS/ V-BELT

Install the movable driven face onto the driven face.

Apply grease to the guide rollers and guide roller pins and then install them into the holes of the driven face.

Install the seal collar.
Remove any excessive grease.

- * Be sure to clean the driven face off any grease.

Set the driven pulley assembly, driven face spring and clutch assembly onto the clutch spring compressor.

- * Align the flat surface of the driven face with the flat on the clutch drive plate.

Compress the tool and install the drive plate nut.

Set the tool in a vise and tighten the drive plate nut to the specified torque.

Torque: 75 N-m

- * Be sure to use a clutch spring compressor to avoid spring damage.

Special

Clutch Spring Compressor
E053

Fittings & Nut Wrench, 41mm E033

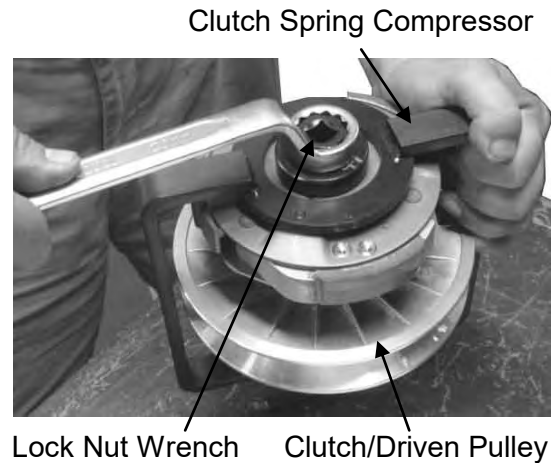
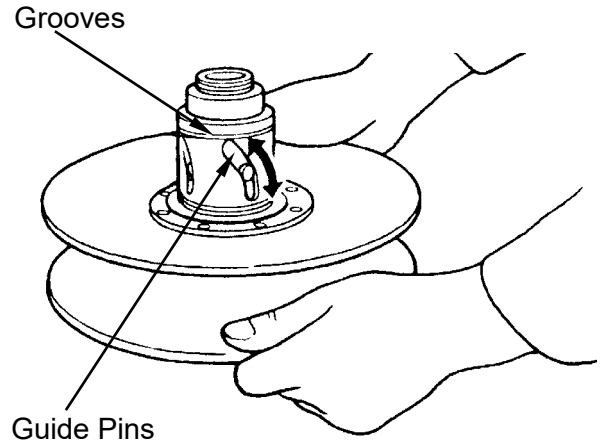

8. DRIVE AND DRIVEN PULLEYS/ V-BELT

INSTALLATION

Install the movable drive face assembly and drive pulley collar onto the crankshaft.

Drive Pulley Collar

Movable Drive Face Assembly

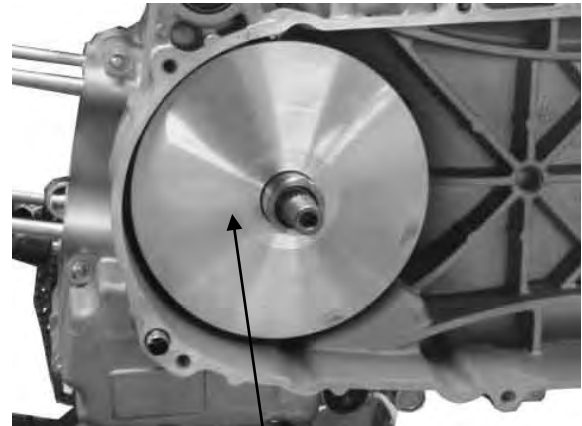

Movable Drive Face Assembly

Put the drive belt on the driven pulley.
Put the drive belt on the drive pulley collar.
Install the clutch/driven pulley and clutch outer onto the drive shaft.

- * • Keep grease off the drive shaft.



Nut

Clutch Outer

Install washer and the clutch outer nut.
Hold the clutch outer with the universal holder to tighten clutch outer nut.

Torque: 54 N-m

Special

Universal Holder E017

Install the drive pulley face, washer and drive face nut.
Hold the drive pulley with the universal holder and tighten the drive face nut.

Torque: 93.1 N-m

- * • Do not get oil or grease on the drive belt or drive pulley faces.

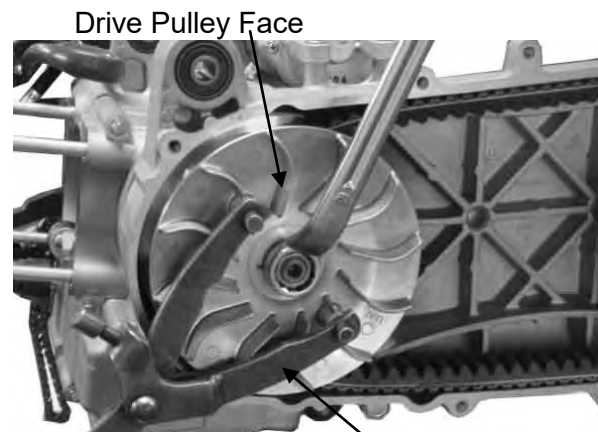

Drive Pulley Face

Universal Holder

8. DRIVE AND DRIVEN PULLEYS/ V-BELT

Install the left crankcase cover.



Left Crankcase Cover

9. FINAL REDUCTION

FINAL REDUCTION

SCHEMATIC DRAWING	9-1
SERVICE INFORMATION	9-2
TROUBLESHOOTING	9-2
FINAL REDUCTION DISASSEMBLY	9-3
FINAL REDUCTION INSPECTION	9-3
FINAL REDUCTION ASSEMBLY	9-5



9. FINAL REDUCTION

SCHEMATIC DRAWING

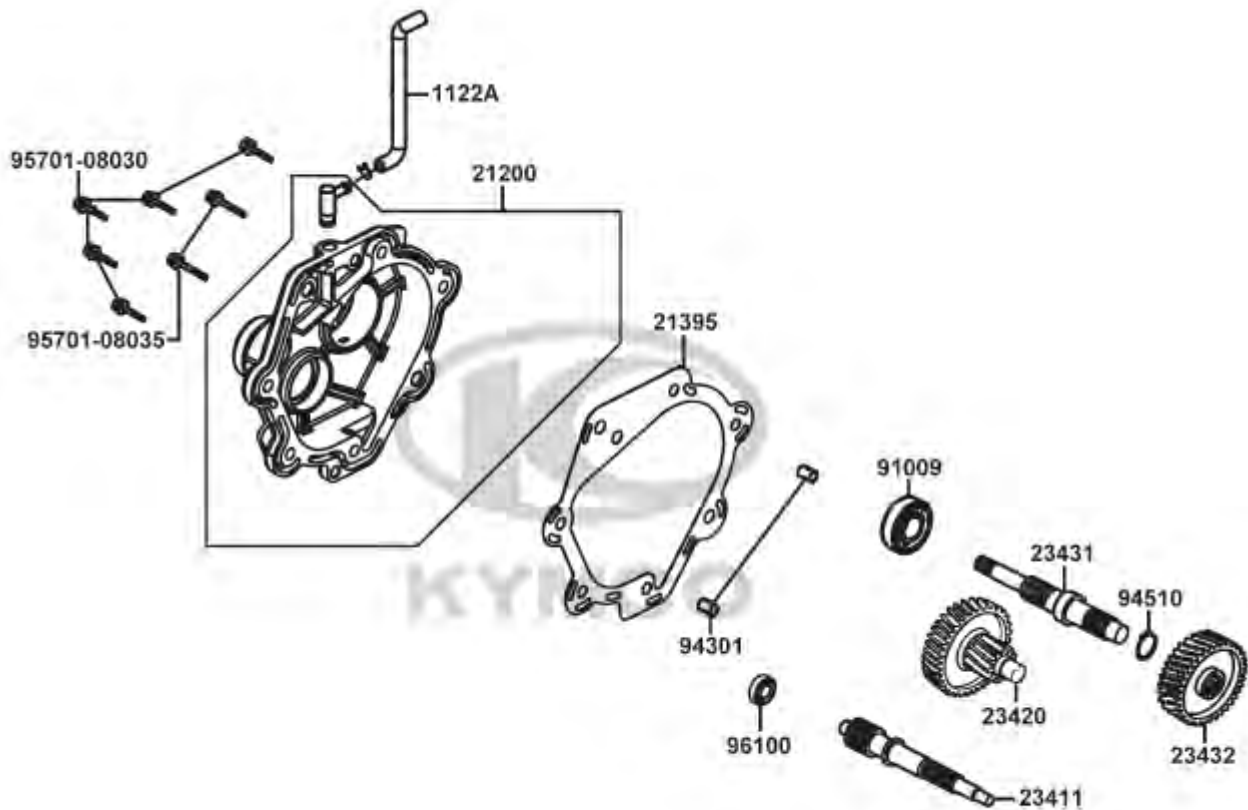

9. FINAL REDUCTION

SERVICE INFORMATION

GENERAL INSTRUCTIONS

- The servicing operations of this section can be made with the engine installed.
- When replacing the drive shaft, use a special tool to hold the bearing inner race for this operation.

SPECIFICATIONS

Specified Oil: SAE 90#

Oil Capacity:

At disassembly: 0.23 L (0.2 Imp qt, 0.24 US qt)

At change: 0.18 L (0.19 US qt, 0.16 Imp qt)

TORQUE VALUES

Transmission case cover bolt 27 N•m (2.7 kgf•m, 20 lbf•ft)

Oil drain bolt 20 N•m (2 kgf•m, 15 lbf•ft)

Oil filler bolt 20 N•m (2 kgf•m, 15 lbf•ft)

SPECIAL TOOLS

Bearing puller A120E00037

Oil seal & bearing driver A120E00014

Universal bearing puller A120E00030

TROUBLESHOOTING

Engine starts but motorcycle won't move

- Damaged transmission
- Seized or burnt transmission
- Faulty drive and driven pulleys/clutch

Abnormal noise

- Worn, seized or chipped gears
- Worn bearing

Oil leaks

- Oil level too high
- Worn or damaged oil seal
- Cracked crankcase

9. FINAL REDUCTION

FINAL REDUCTION DISASSEMBLY

Remove the exhaust muffler.
Remove the rear brake caliper.
Remove the right rear shock absorber.
Remove the rear fork.
Remove the rear wheel.

Drain the transmission gear oil into a clean container.

Remove the eight bolts and transmission cover.

Remove the gasket and dowel pins.

Remove the final gear shaft.

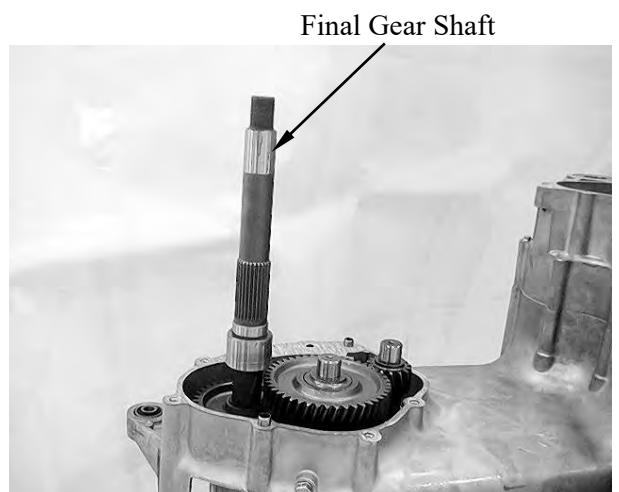
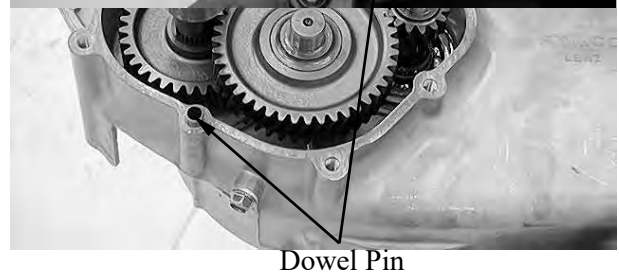
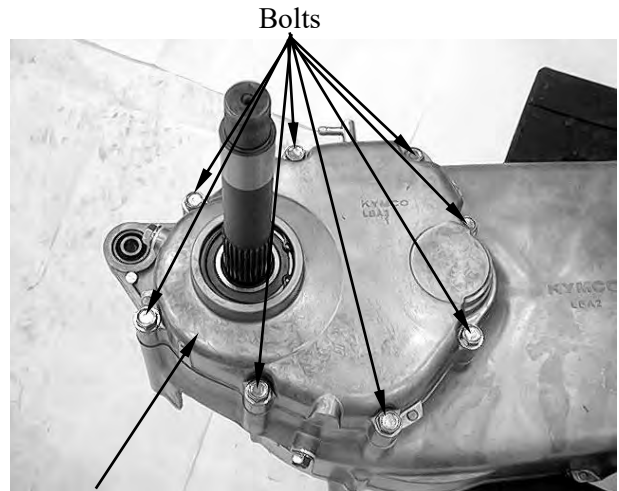

9. FINAL REDUCTION

Remove the countershaft.

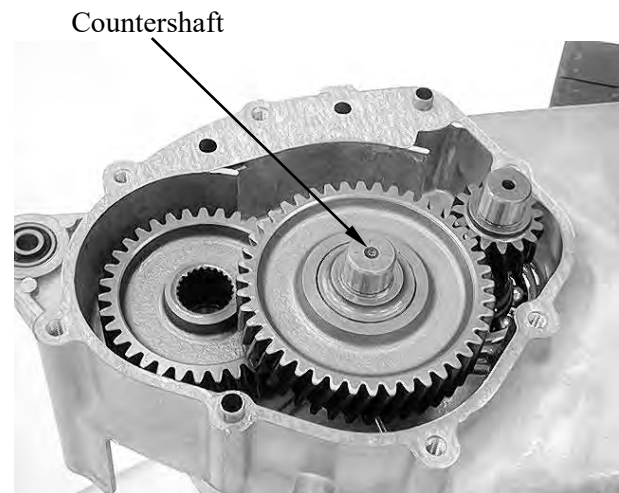

Remove the final gear.

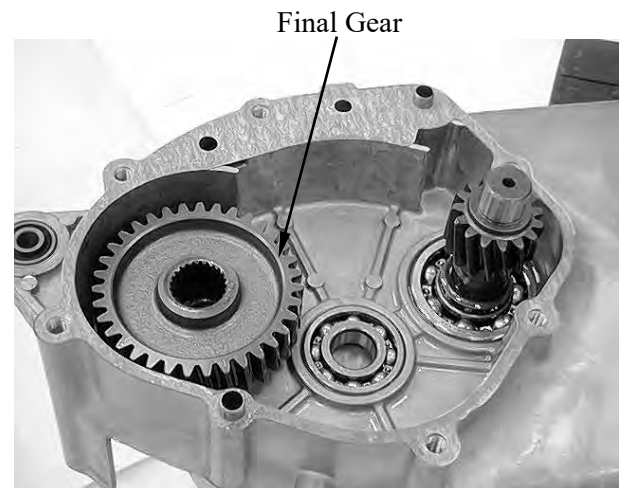

Remove the driven pulley.

Press the driveshaft out of the left crankcase.

Check the drive shaft for wear or damage.

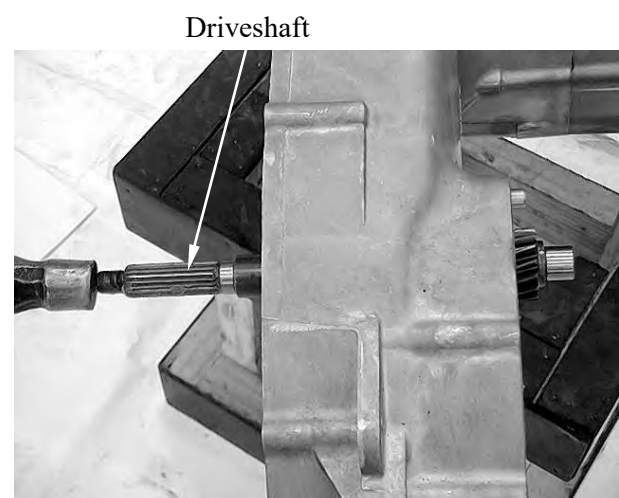

9. FINAL REDUCTION

Remove the driveshaft oil seal and bearing from the transmission case.



If the bearing is left on the driveshaft, remove it with the special tool.

Special tool:

Universal bearing puller A120E00030

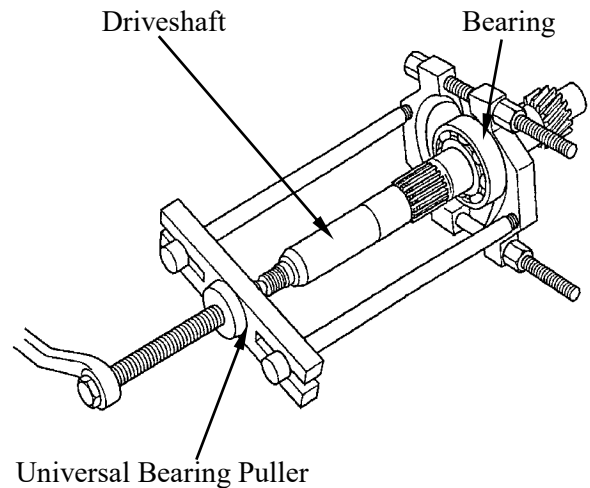

FINAL REDUCTION INSPECTION

Check the driveshaft, countershaft, final gear and final gear shaft for wear or damage.



9. FINAL REDUCTION

Check the oil seal and bearings in the left crankcase for wear or damage.

BEARING REPLACEMENT (TRANSMISSION CASE)

Remove the countershaft or final gear shaft bearing using the special tool.

Special tool:

Bearing puller A120E00037

Driveshaft Bearing

Bearing Puller

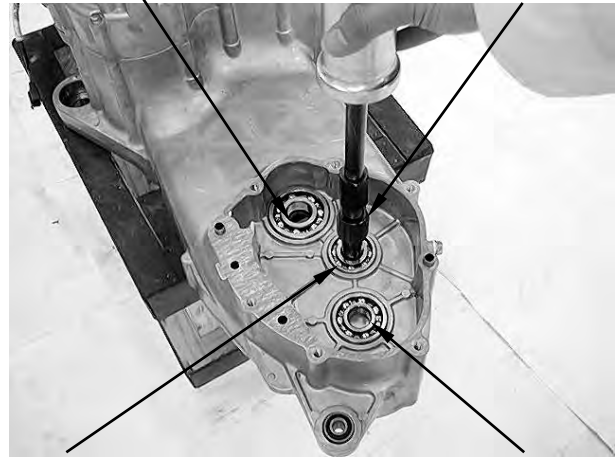

Countershaft Bearing

Final Gear Shaft Bearing

Apply engine oil to new bearings cavities.
Drive new bearings into the transmission case.

Special tool:

Oil seal & bearing driver A120E00014

Oil Seal & Bearing Driver

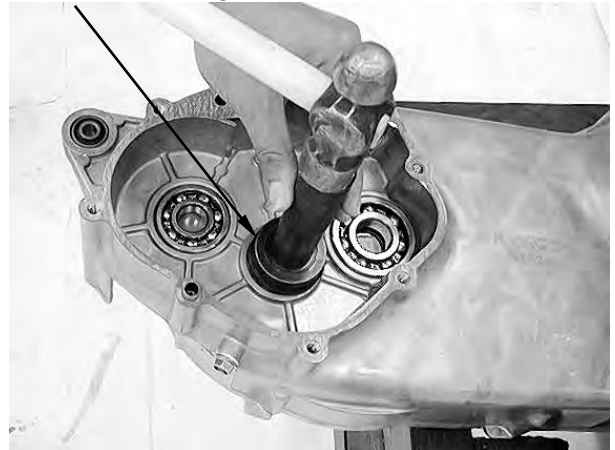

BEARING REPLACEMENT (TRANSMISSION COVER)

Remove the final gear shaft oil seal.

Oil Seal



9. FINAL REDUCTION

Remove the final gear shaft bearing.

Final Gear Shaft Bearing

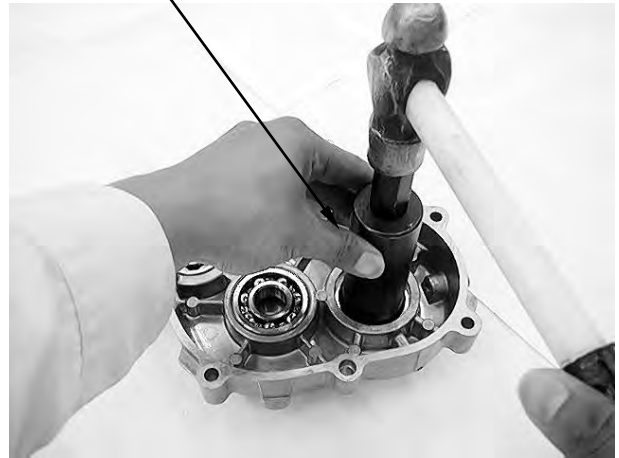

Remove the countershaft or drive shaft bearing using the special tool.

Special tool:

Bearing puller A120E00037

Countershaft Bearing



Drive Shaft Bearing

9. FINAL REDUCTION

Apply engine oil to new bearings cavities.
Drive new bearings into the transmission cover.

Special tool:

Oil seal & bearing driver A120E00014

Oil Seal & Bearing Driver



Apply engine oil to new final gear shaft bearing cavity.
Drive new bearing into the transmission cover.

Special tool:

Oil seal & bearing driver A120E00014



Oil Seal & Bearing Driver

Install the bearing snap ring.

Snap Ring



9. FINAL REDUCTION

Apply oil to a new final gear shaft oil seal lip and outer surface.

Install the final gear shaft oil seal.

Oil Seal



FINAL REDUCTION ASSEMBLY

Install the final gear to the transmission case.

Final Gear



Install the countershaft to the transmission case.

Countershaft

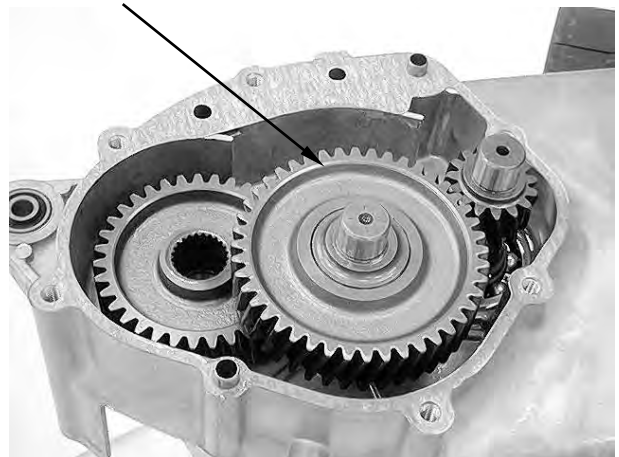

9. FINAL REDUCTION

Install the final gear shaft to transmission case.

Install the dowel pins.

Clean the mating surfaces of the left crankcase and transmission cover.

Install the new gasket.

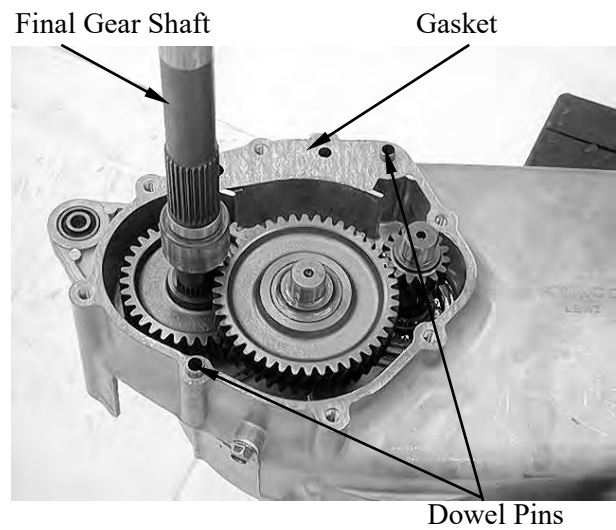

Install the transmission cover and tighten the eight bolts in a crisscross pattern in 2 – 3 steps to the specified torque.

Torque: 27 N•m (2.7 kgf•m, 20 lbf•ft)

Fill the transmission case with the recommended oil .

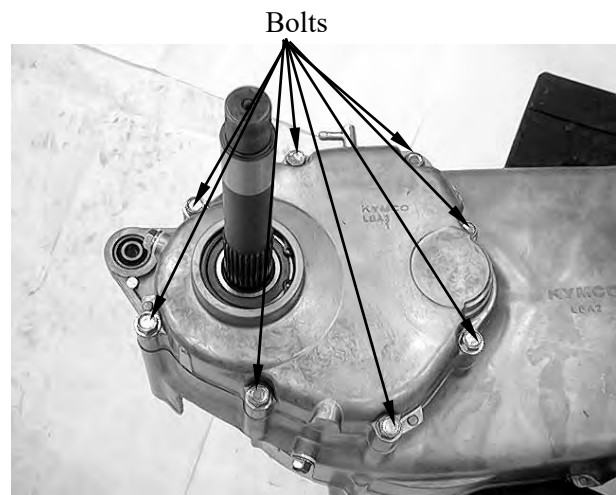

10. A.C. GENERATOR/STARTER CLUTCH

A.C. GENERATOR/STARTER CLUTCH

SCHEMATIC DRAWING	10-1
SERVICE INFORMATION	10-2
TROUBLESHOOTING	10-2
RIGHT CRANKCASE COVER REMOVAL	10-3
STATOR REMOVAL.....	10-3
FLYWHEEL REMOVAL.....	10-4
STARTER CLUTCH	10-4
FLYWHEEL INSTALLATION	10-6

10

10. A.C. GENERATOR/STARTER CLUTCH

SCHEMATIC DRAWING

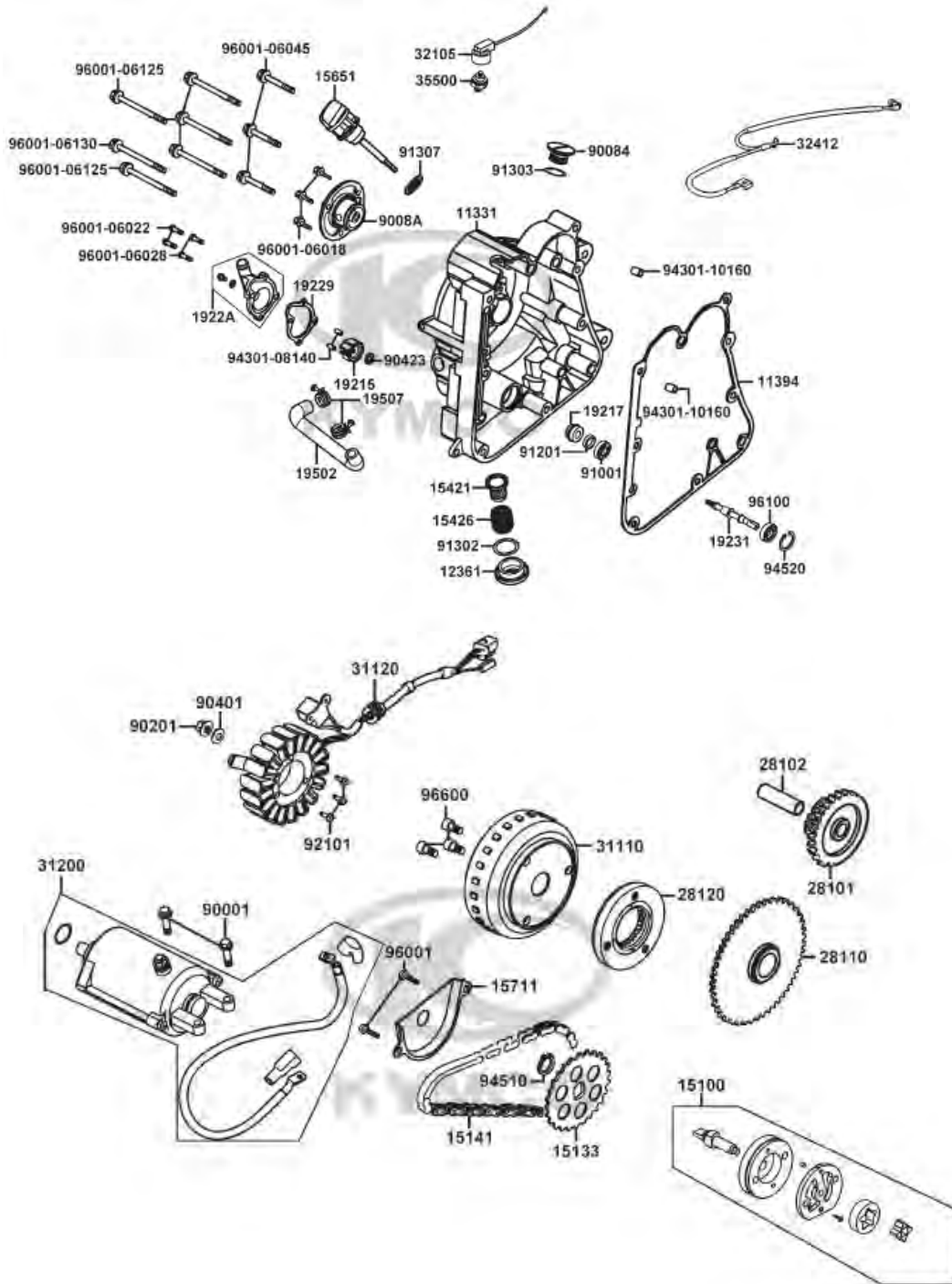

10. A.C. GENERATOR/STARTER CLUTCH

SERVICE INFORMATION

GENERAL INSTRUCTIONS

- All operations and inspections in this section can be made with the engine installed.
- Should drain the coolant before removing the right crankcase cover.
- Be careful not to drain the coolant when the engine temperature is high. (Perform this operation when the engine is cold.)
- Drain the coolant into a clean container.
- Drain the engine oil into a clean container before removing the right crankcase cover.
- When the right crankcase cover is installed, fill with the recommended engine oil and coolant. Remember to bleed air from the water hose.

SPECIFICATIONS

Engine oil: SAE 5W/50#
API-SJ above

Engine quality: Synthetic

Oil capacity at change: 1.1 Liter

Coolant capacity:

Radiator and Hose capacity: 1.10 liter

Reserve tank capacity: 0.25 liter

SPECIAL TOOLS

Flywheel puller E003

Flywheel holder E021

SPECIFICATIONS

Item	Standard (mm)	Service Limit (mm)
Starter driven gear I.D.	22.026 (0.88104)~22.045	22.1 (0.884)
Starter driven gear O.D.	42.195 (1.6878)~42.208	41.5 (1.66)

TORQUE VALUES

Flywheel nut : 5.5~6.5 kgf-m (58.8 N-m)

TROUBLESHOOTING

Refer to chapter 1 for A.C. generator troubleshooting.

Starter motor rotates but engine does not start

- Faulty starter clutch
- Starter motor rotates reversely
- Weak battery

10. A.C. GENERATOR/STARTER CLUTCH

RIGHT CRANKCASE COVER REMOVAL

Disconnect the water hoses from the water pump cover.

Disconnect the water hoses from the right crankcase cover.

Remove 9 bolts attaching the right crankcase cover and the cover.

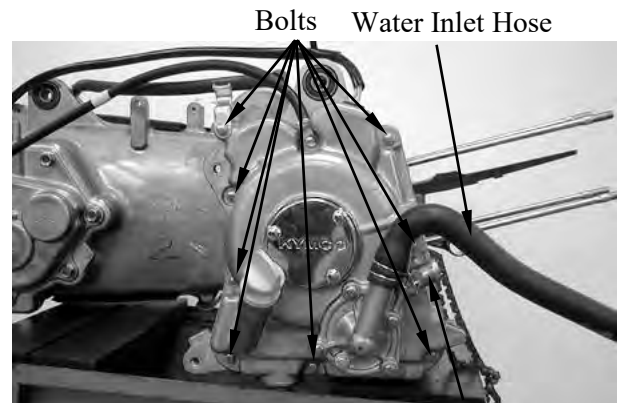

STATOR REMOVAL

Remove the two pulse coil mount screws.

Remove the three stator mount bolts, grommet and the stator from the right crankcase cover.

* When removing the pulsar coil and stator, be careful not to damage them to avoid short-circuit or broken wire.

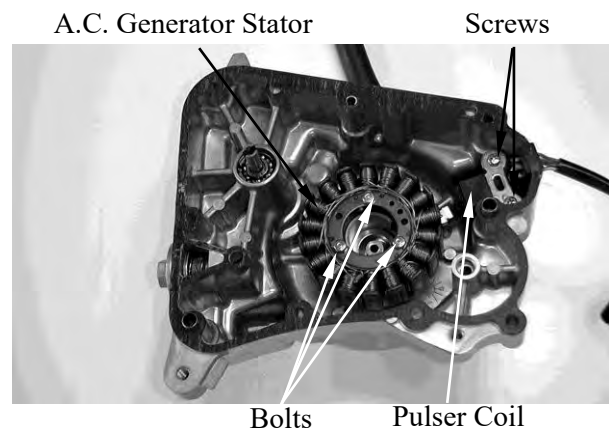

INSTALLATION

Install the stator and tighten the stator mount bolts to the specified torque.

Torque: 12 N•m (1.2 kgf•m, 9 lbf•ft)

Apply sealant to the grommet seating surface and install it to the cover groove properly.

Install the pulse coil and tighten mount bolts to the specified torque.

Torque: 12 N•m (1.2 kgf•m, 9 lbf•ft)

Clean the mating surfaces of the right crankcase and cover.

Install the dowel pins and gasket.

Install the right crankcase cover and tighten the bolts in a crisscross pattern in 2 or 3 steps.

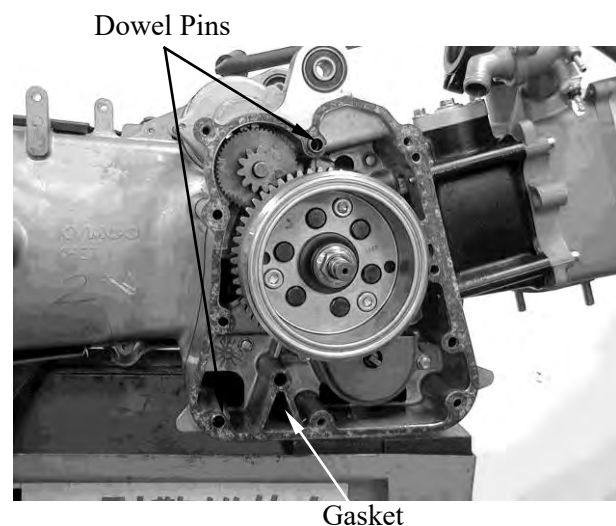

10. A.C. GENERATOR/STARTER CLUTCH

FLYWHEEL/STARTER CLUTCH REMOVAL

Remove the right crankcase cover.

Hold the flywheel with the special tool and
loosen the flywheel nut.

Special tool:

Flywheel holder A120E00021

Remove the flywheel nut and washer.

Remove the flywheel/starter driven gear
assembly using the special tool.

Special tool:

Flywheel puller A120E00003

Remove the woodruff key.

Flywheel Holder Nut/Washer

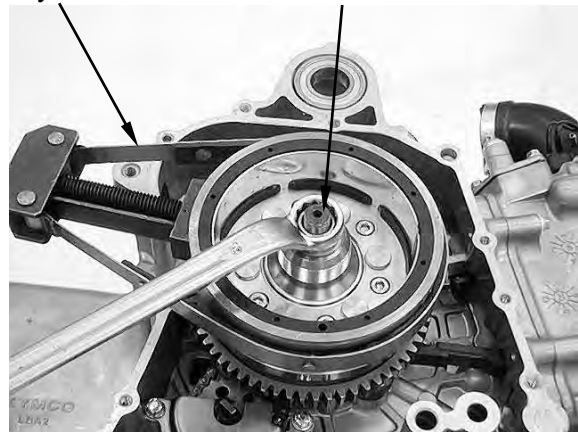

Flywheel Puller



Woodruff Key

10. A.C. GENERATOR/STARTER CLUTCH

Remove the reduction gear and shaft.

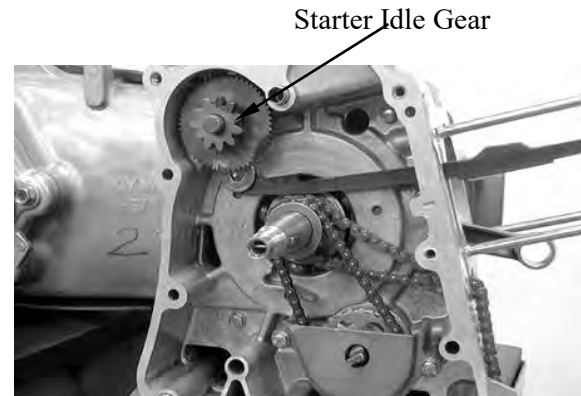

Inspect the reduction gear and shaft for wear or damage.

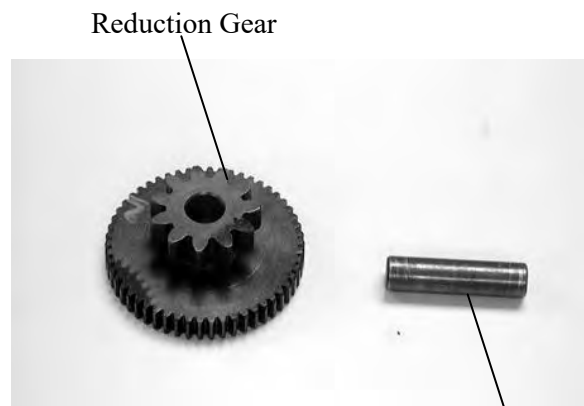

INSPECTION

Check the operation of the sprag clutch by turning the driven gear. You should be able to turn the driven gear clockwise smoothly, but the gear should not turn counterclockwise.

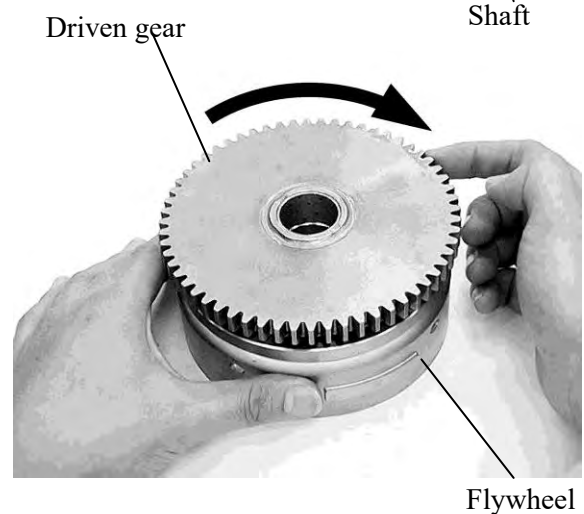

Remove the starter driven gear by turning the driven gear.

Check the starter driven gear teeth for wear or damage.

Measure the starter driven gear boss O.D..
Service limit: 41.5.6 mm (1.66 in)

Measure the starter driven gear bushing I.D..
Service limit: 22.1 mm (0.884 in)

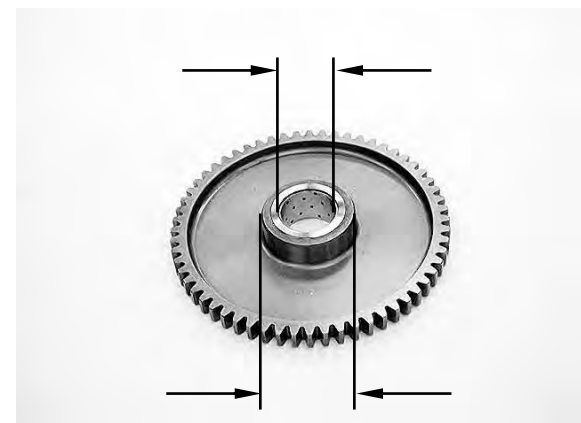

10. A.C. GENERATOR/STARTER CLUTCH

Apply oil to the starter reduction gear.
Install the starter reduction gear to the right crankcase.

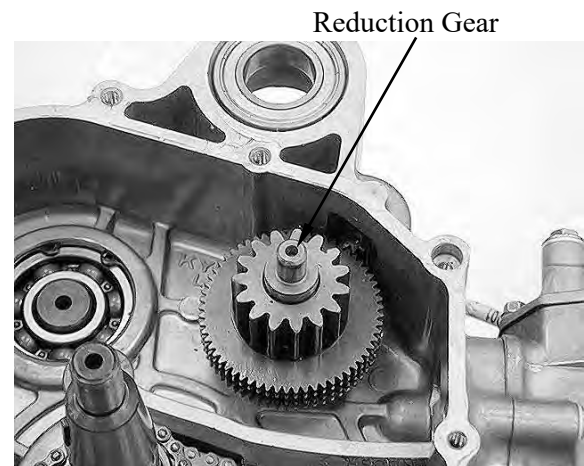

Apply oil to the starter reduction gear and shaft.
Install the starter reduction gear and shaft to the right crankcase.

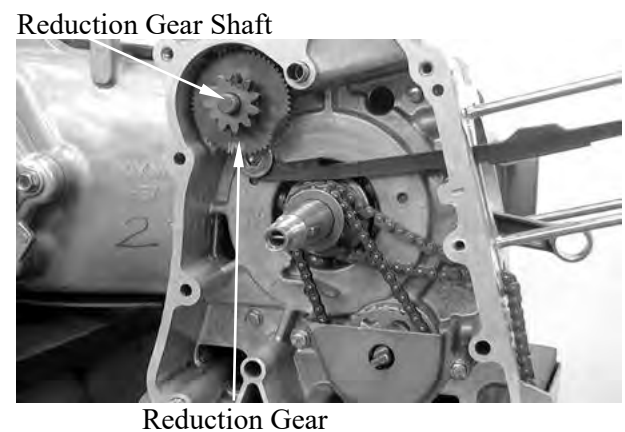

Apply molybdenum oil solution to the starter driven gear bushing.
Install the starter driven gear by turning the driven gear clockwise.

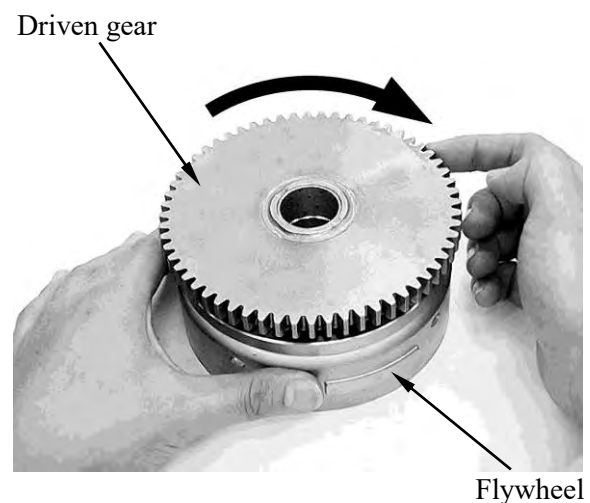

10. A.C. GENERATOR/STARTER CLUTCH

Clean any oil from tapered portion of the crankshaft.

Install the woodruff key in the crankshaft key groove.



Woodruff Key

Clean any oil from the tapered portion of the flywheel I.D..

Install the flywheel/driven gear onto the crankshaft, aligning the key way with woodruff key.

Apply oil to the washer and flywheel nut threads and seating surface.

Install the washer and flywheel nut to the crankshaft.

Hold the flywheel with the special tool and tighten the flywheel nut to the specified torque.

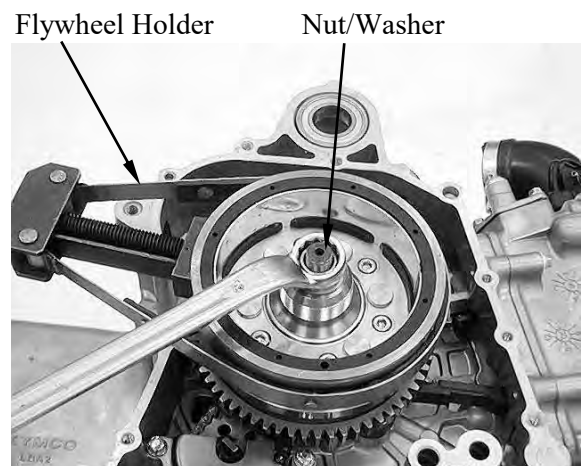

Special tool:

Flywheel holder A120E00021

Torque: 55 N•m (5.5 kgf•m, 40 lbf•ft)

11. CRANKCASE/CRANKSHAFT

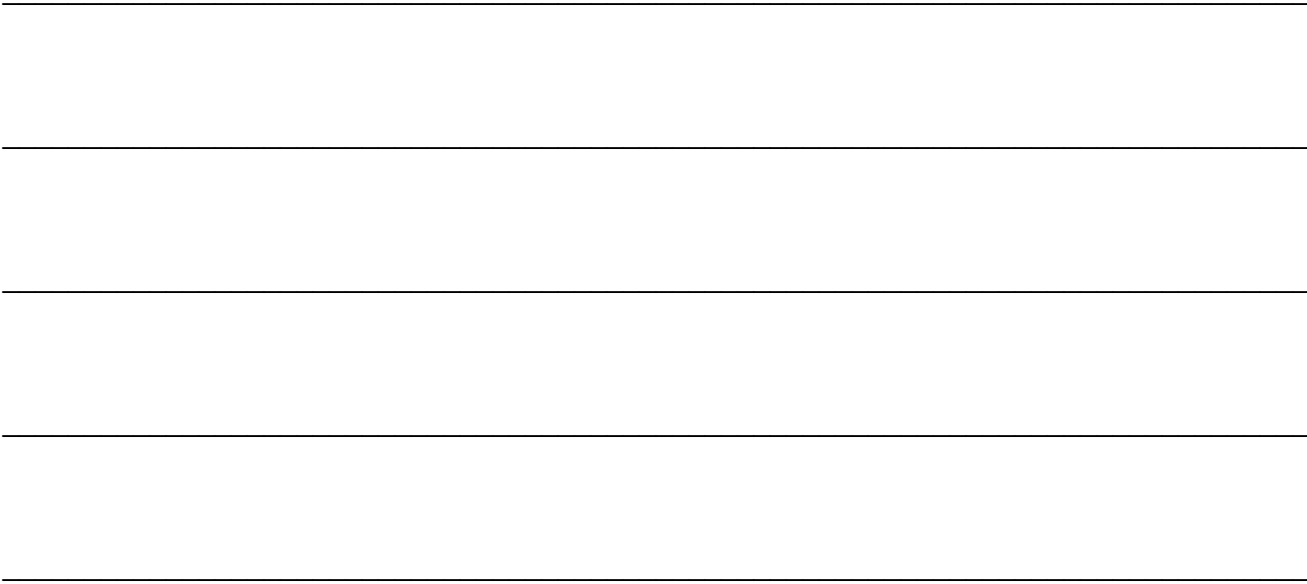

CRANKCASE/CRANKSHAFT

SCHEMATIC DRAWING	11-1
SERVICE INFORMATION	11-2
TROUBLESHOOTING	11-2
CRANKCASE SEPARATION.....	11-3
CRANKSHAFT INSPECTION.....	11-4
CRANKCASE ASSEMBLY.....	11-5

11. CRANKCASE/CRANKSHAFT

SCHEMATIC DRAWING

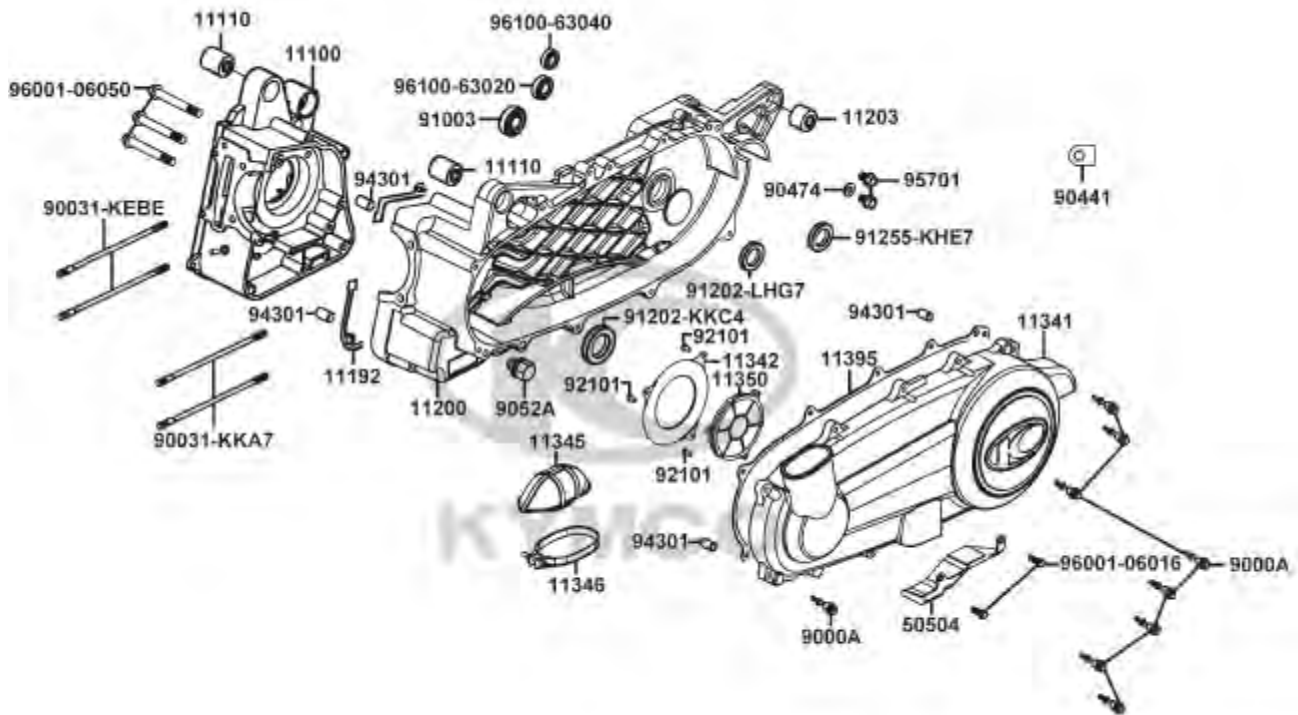

11. CRANKCASE/CRANKSHAFT

SERVICE INFORMATION

GENERAL INSTRUCTIONS

- This section covers crankcase separation to service the crankshaft. The engine must be removed for this operation.
- When separating the crankcase, never use a driver to knock the crankcase forcedly to prevent damaging the mating surfaces.
- When installing the crankcase, do not use an iron hammer to tap it.
- When installing the crankcase or crankshaft, must be replaced in pair.
- The following parts must be removed before separating the crankcase.

Cylinder head

Cylinder/piston

Right crankcase cover/drive and driven pulley

A.C. generator/starter clutch

Rear wheel/rear shock absorber

Starter motor

Oil pump

SPECIFICATIONS

	Item	Standard (mm)	Service Limit (mm)
Crankshaft	Connecting rod big end side clearance	0.15~0.35	0.6
	Connecting rod big end radial clearance	0~0.008	0.05

TORQUE VALUES

Crankcase cover bolt 1.0~1.4 kgf-m (11.8 N-m)

Cam chain tensioner pivot 0.8~1.2 kgf-m (9.8 N-m)

TROUBLESHOOTING

Excessive engine noise

- Excessive bearing play
- Excessive crankpin bearing play
- Worn piston pin and piston pin hole

11. CRANKCASE/CRANKSHAFT

REMOVAL

Remove the cam chain guide bolt.

Remove the cam chain guide and cam chain



INSPECTION

Cam chain guide

Inspect the cam chain slipper surface of the cam chain guide for wear or damage.



Cam chain

Inspect the cam chain for cracks or stiff.

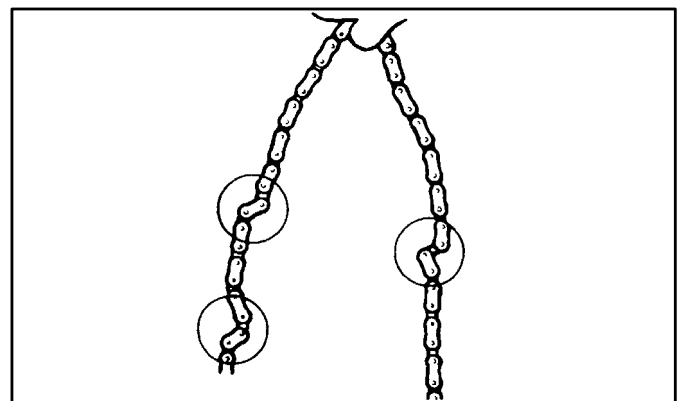

11. CRANKCASE/CRANKSHAFT

CRANKCASE SEPARATION

Place the crankcase with the left crankcase down and remove the right crankcase from the left crankcase.

- * **Never use a driver to pry the crankcase mating surfaces apart.**

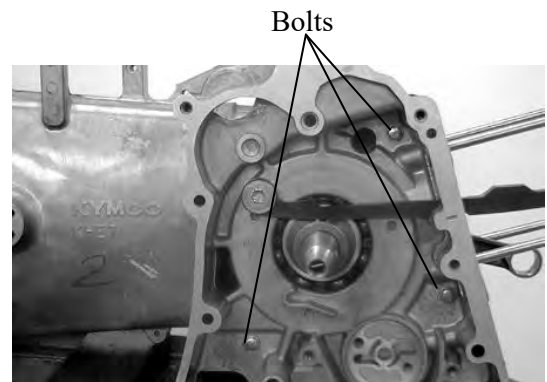

Remove the gasket and dowel pins.

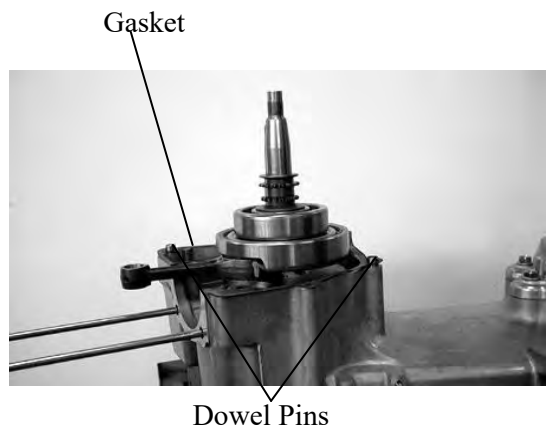

Remove the crankshaft from the left crankcase.

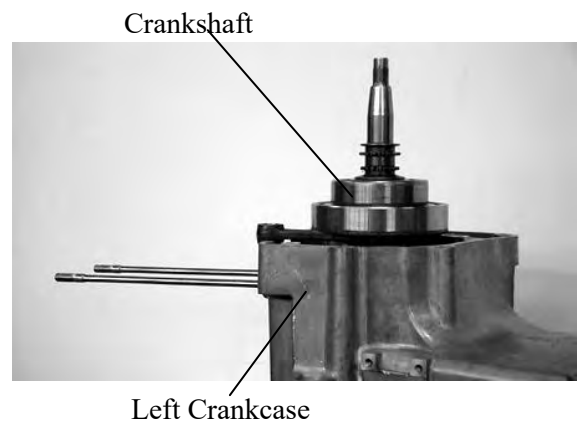

CRANKSHAFT INSPECTION

Measure the crankshaft runout.
Service Limit: 0.1 mm (0.004 in)

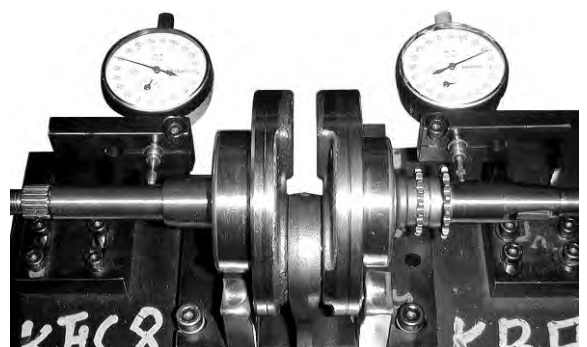

11. CRANKCASE/CRANKSHAFT

Measure the connecting rod big end side clearance.

Service Limit: 0.6 mm (0.024 in)

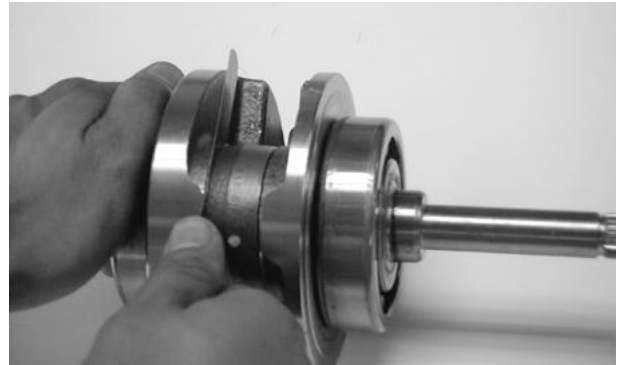

Measure the connecting rod small end I.D.

Service Limit: 17.06 mm (0.6824 in)



CRANKCASE ASSEMBLY

Clean off all gasket material from the crankcase mating surfaces.

- *

<ul style="list-style-type: none">• Avoid damaging the crankcase mating surfaces.



11. CRANKCASE/CRANKSHAFT

Install a new oil seal into the left crankcase.

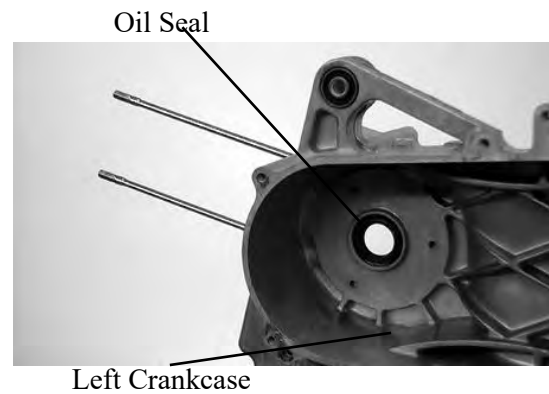

Place the left crankcase down and install the crankshaft into the left crankcase.

- *

<ul style="list-style-type: none">• Avoid damaging the oil seal.• Apply grease to the lip of the oil seal.



Install the two dowel pins and a new gasket.

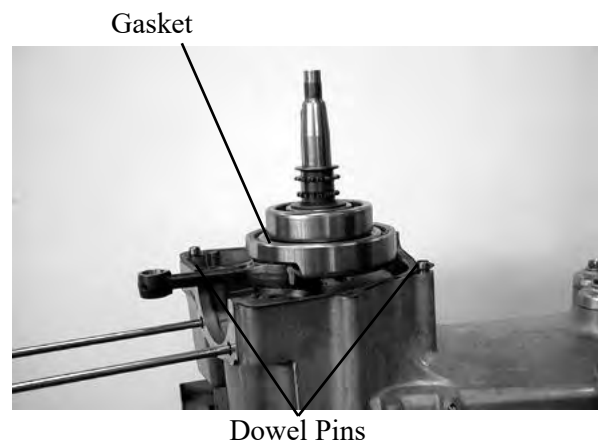

11. CRANKCASE/CRANKSHAFT

Place the right crankcase over the crankshaft and onto the left crankcase.

- * **Install the right crankcase squarely and do not tap it with an iron or plastic hammer.**

Install and tighten the right and left crankcase attaching bolts.

Torque: 12 N•m (1.2 kgf•m, 9 lbf•ft)

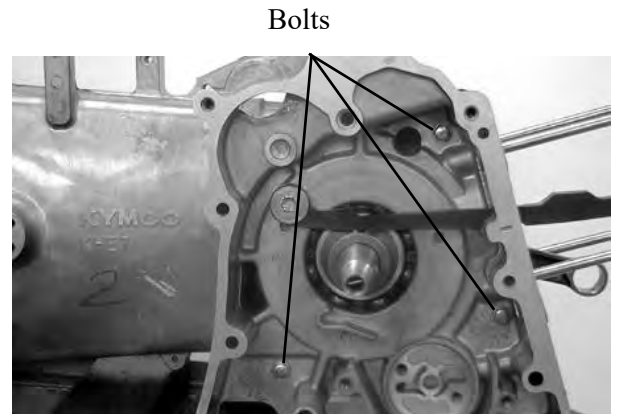

Install the cam chain.
Install the cam chain tensioner slipper.
Install and tighten the cam chain tensioner slipper bolt.

Torque: 10 N•m (1 kgf•m, 10 lbf•ft)

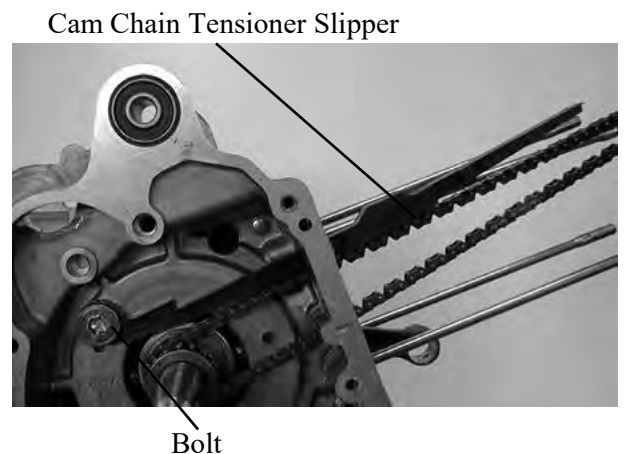

12. COOLING SYSTEM

COOLING SYSTEM

SCHEMATIC DRAWING	12- 1
SERVICE INFORMATION	12- 2
TROUBLESHOOTING	12- 2
COOLING SYSTEM TESTING	12- 4
RADIATOR.....	12- 4
WATER PUMP.....	12- 8
THERMOSENSOR.....	12-11
THERMOSTAT	12-12

12. COOLING SYSTEM

SCHEMATIC DRAWING

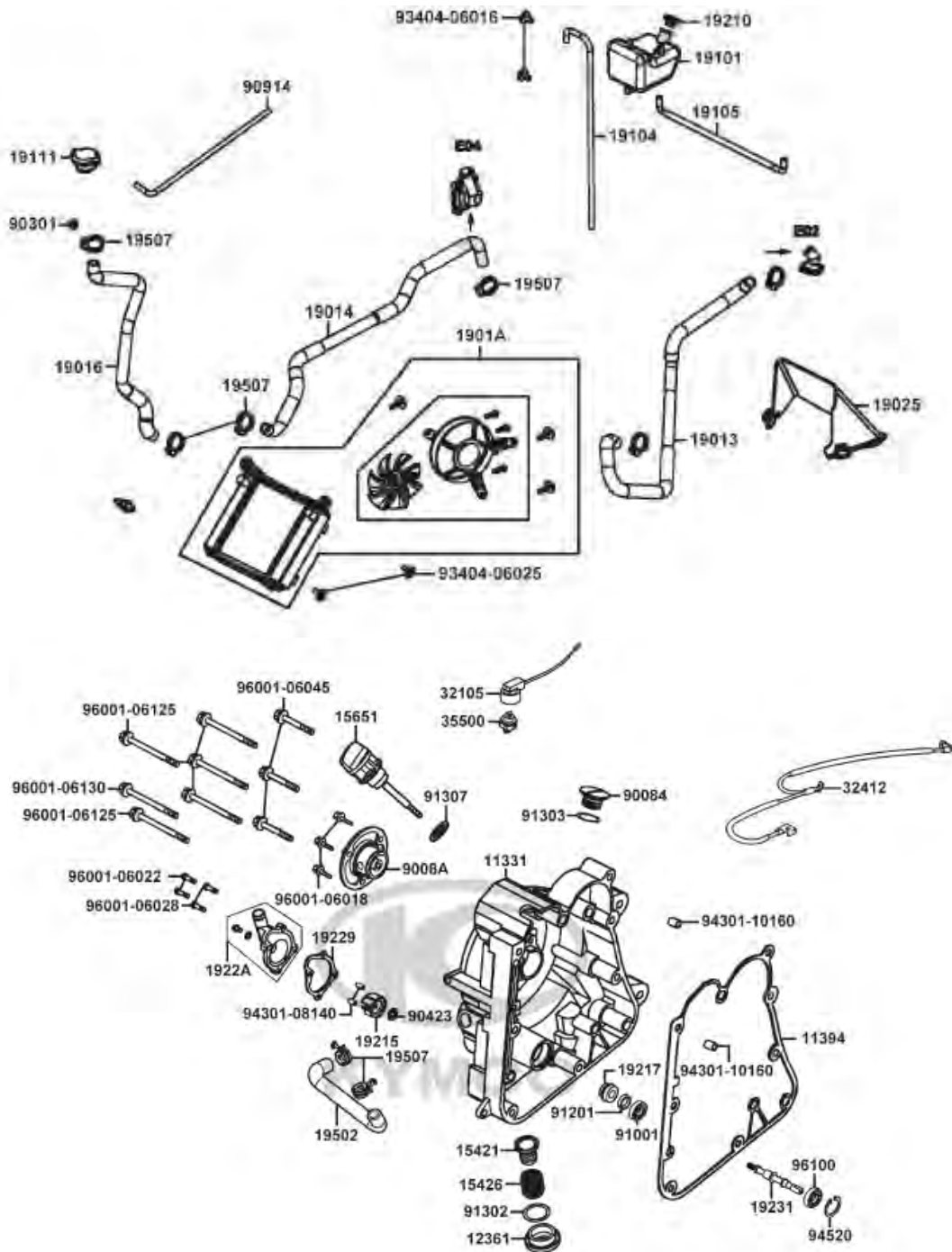

12. COOLING SYSTEM

SERVICE INFORMATION

GENERAL INSTRUCTIONS

- The water pump must be serviced after removing the engine. Other cooling system service can be done with the engine installed in the frame.
- The engine must be cool before servicing the cooling system.
When the coolant temperature is over 100°C, never remove the radiator cap to release the pressure because the boiling coolant may cause danger.
- Avoid spilling coolant on painted surfaces because the coolant will corrode the painted surfaces. Wash off any spilled coolant with fresh water as soon as possible.
- After servicing the system, check for leaks with a cooling system tester.

TORQUE VALUES

Water pump impeller	1.0~1.4 kgf-m (11.8 N-m)
Water pump cover bolt	1.0~1.4 kgf-m (11.8 N-m)

TROUBLESHOOTING

Engine temperature too high

- Faulty temperature gauge or thermosensor
- Faulty radiator cap
- Faulty thermostat
- Insufficient coolant
- Passages blocked in hoses or water jacket
- Clogged radiator fins
- Passages blocked in radiator
- Faulty water pump

Coolant leaks

- Faulty pump mechanical (water) seal
- Deteriorated O-rings
- Damaged or deteriorated water hoses

Temperature gauge shows the wrong temperature

- Faulty temperature gauge or thermosensor
- Faulty thermostat

SPECIFICATIONS

Radiator cap relief pressure		0.9±0.15 kg/cm ²	
Thermostat temperature	Begins to open	85°C	
	Full-open	90°C	
	Valve lift	3.5~4.5 mm	
Coolant capacity		Total 1350 cc	Radiator and hose: 1100cc Reserve tank: 250 cc

12. COOLING SYSTEM

COOLANT GRAVITY CHART

Temp. °C Coolant concentration	0	5	10	15	20	25	30	35	40	45	50
5%	1.009	1.009	1.008	1.008	1.007	1.006	1.005	1.003	1.001	0.009	0.997
10%	1.018	1.107	1.017	1.016	1.015	1.014	0.013	1.011	1.009	1.007	1.005
15%	1.028	1.027	1.026	1.025	1.024	1.022	1.020	1.018	1.016	1.014	1.012
20%	1.036	1.035	1.034	1.033	1.031	1.029	1.027	1.025	1.023	1.021	1.019
25%	1.045	1.044	1.043	1.042	1.040	1.038	1.036	1.034	1.031	1.028	1.025
30%	1.053	1.051	1.051	1.049	1.047	1.045	1.043	1.041	1.038	1.035	1.032
35%	1.063	1.062	1.060	1.058	1.056	1.054	1.052	1.049	1.046	1.043	1.040
40%	1.072	1.070	1.068	1.066	1.064	1.062	1.059	1.056	1.053	1.050	1.047
45%	1.080	1.078	1.076	1.074	1.072	1.069	1.056	1.063	1.062	1.057	1.054
50%	1.086	1.084	1.082	1.080	1.077	1.074	1.071	1.068	1.065	1.062	1.059
55%	1.095	1.093	1.091	1.088	1.085	1.082	1.079	1.076	1.073	1.070	1.067
60%	1.100	1.098	1.095	1.092	1.089	1.086	1.083	1.080	1.077	1.074	1.071

COOLANT MIXTURE (WITH ANTI-RUST AND ANTI-FREEZING EFFECTS)

Freezing Point	Mixing Rate	KYMCO SIGMA Coolant Concentrate	Distilled Water
-9°C	20 %	344cc	1375cc
-15°C	30 %	516cc	1203cc
-25°C	40 %	688cc	1031cc
-37°C	50 %	860cc	859cc
-44.5°C	55 %	945cc	774cc

*

- Use coolant of specified mixing rate. (The mixing rate of 860cc KYMCO SIGMA coolant concentrate + 859cc distilled water is 50%.)
- Do not mix coolant concentrate of different brands.
- Do not drink the coolant, which is poisonous.
- The freezing point of coolant mixture shall be 5°C lower than the freezing point of the riding area.

12. COOLING SYSTEM

COOLING SYSTEM TESTING RADIATOR CAP INSPECTION

Install the radiator cap onto the radiator tester and apply specified pressure to it. It must hold specified pressure for at least six seconds.

- * Apply water to the sealing cap surface before testing.

Radiator Cap Relief Pressure:
0.9±0.15 kg/cm²

Install the radiator tester onto the radiator and apply specified pressure to it. It must hold specified pressure for at least six seconds.

Check the water hoses and connectors for leaks.

- * The test pressure should not exceed 1.05 kg/cm². Excessive pressure can damage the radiator and its hose connectors.

RADIATOR

RADIATOR INSPECTION

Remove the front cover.

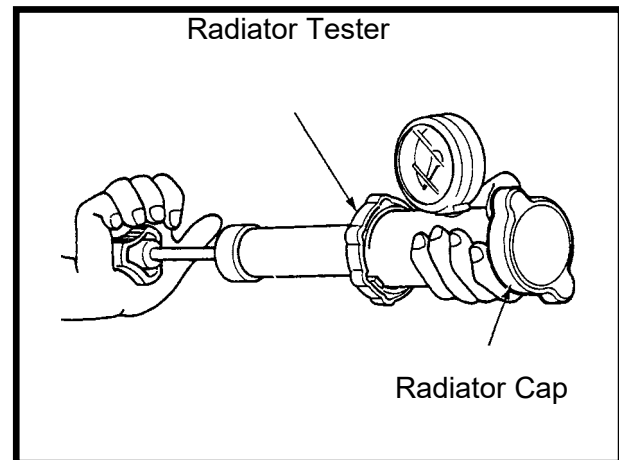

12. COOLING SYSTEM

Inspect the radiator soldered joints and seams for leaks.

Blow dirt out from between core fins with compressed air. If insects are clogging the radiator, wash them off. Carefully straighten any bent fins.

RADIATOR REMOVAL

Drain the coolant.

Disconnect the outlet tube of the reserve tank.

Remove the overflow tube clamp and disconnect the overflow tube.

Disconnect the air vent tube from the radiator filler.

Disconnect the fan motor wire coupler.

Loosen the hose band and disconnect the upper hose and lower hose from the radiator.

Disconnect the thermostatic switch wire coupler.

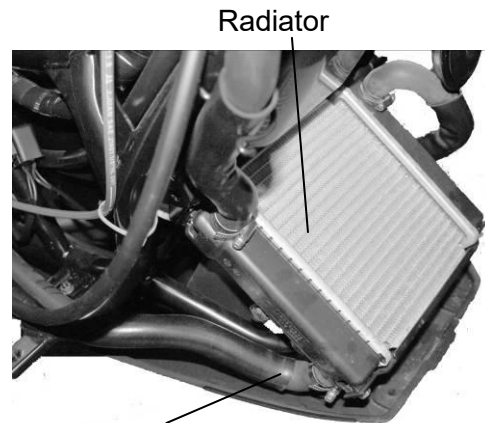

Outlet Tube of Reserve Tank



Overflow Tube

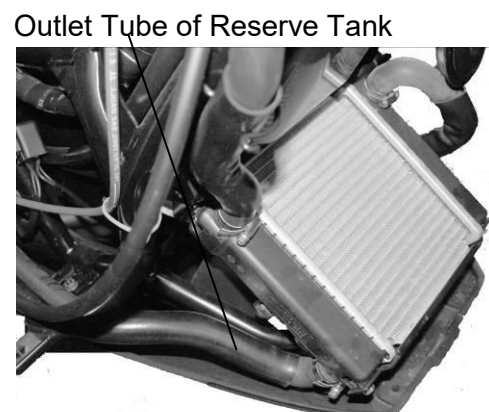

Outlet Tube of Reserve Tank

12. COOLING SYSTEM

Remove three bolts on the radiator.
Remove the radiator.

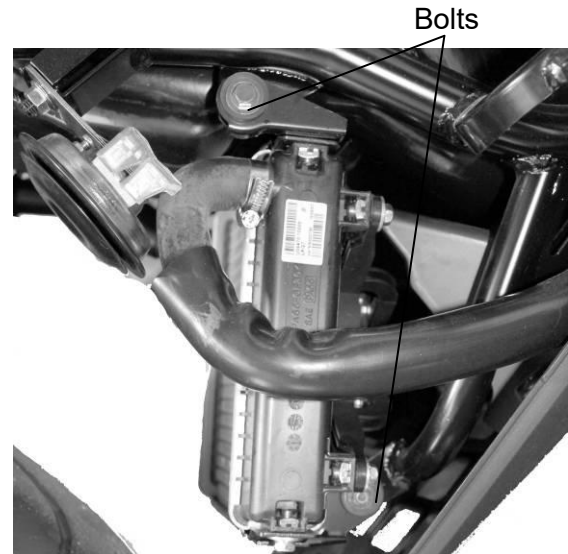

RADIATOR DISASSEMBLY

Remove three bolts and then remove the fan rubber from the radiator.

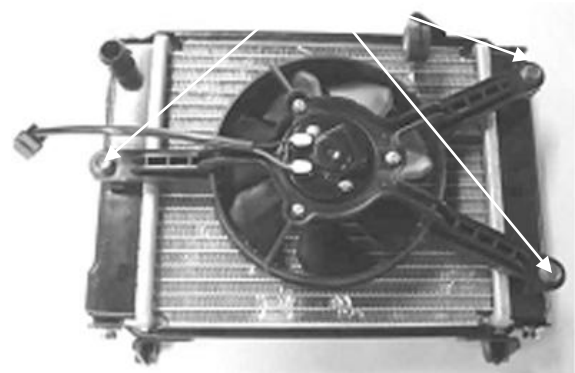

Check fan motor by battery.



12. COOLING SYSTEM

RADIATOR INSTALLATION

Install the fan rubber on the radiator with three bolts.

Install the radiator on the radiator bracket with three bolts/nuts.

Connect the upper and lower hoses and secure them with hose bands.

Connect the thermostatic switch wire.

Connect the fan motor wire couplers.

Connect the overflow tube and secure with the tube clamp.

Fill the radiator with coolant.

Connect the vent tube to the radiator filler.

After installation, check for coolant leaks.

Connect the outlet tube of the reservoir and secure with the tube clamp.

Air Vent Tube

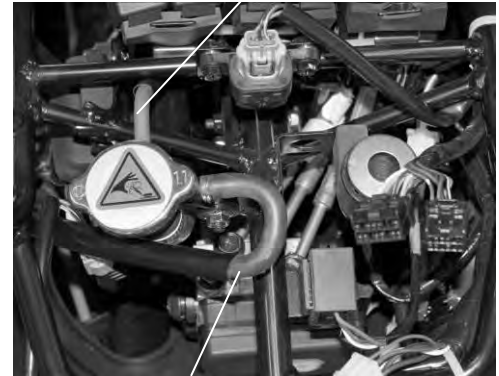

Overflow Tube

- * If you want to refill the coolant, the following procedure must be checked.
1. Please make the radiator filler and the air vent tube to be separated.
 2. Start the engine, filled in the coolant till the coolant flowed out from the air vent tube.

12. COOLING SYSTEM

WATER PUMP

MECHANICAL SEAL (WATER SEAL) INSPECTION

Inspect the telltale hole for signs of mechanical seal coolant leakage.

If the mechanical seal is leaking, remove the right crankcase cover and replace the mechanical seal.

Right Crankcase Cover



Water Pump

WATER PUMP/IMPELLER REMOVAL

Remove the coolant inlet hose and outlet hose.

Remove four bolts and the water pump cover, gasket and 2 dowel pins.

Remove the water pump impeller.

* The impeller has left hand threads.

Impeller Seal Washer (Porcelain)



Mechanical (Water) Seal

Inspect the mechanical (water) seal and seal washer if wear or damage.

* The mechanical seal and seal washer must be replaced as a set.



Water pump shaft

12. COOLING SYSTEM

WATER PUMP SHAFT REMOVAL

Disconnect the water hose from the right crankcase cover.
 Remove bolts attaching the right crankcase cover.
 Remove the water pump bearing snap ring from the water pump assembly.
 Remove the water pump shaft and inner bearing.
 Remove the water pump shaft outer bearing.

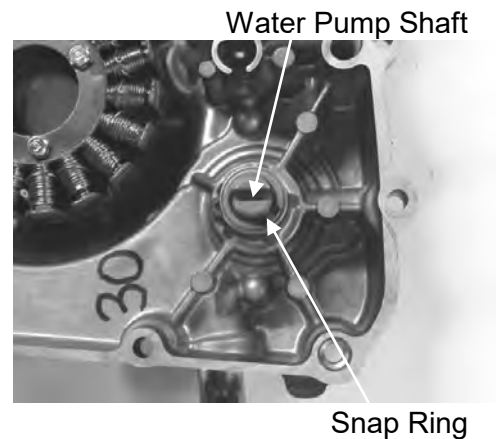

MECHANICAL SEAL REPLACEMENT

Drive the mechanical seal out of the water pump assembly from the inside.

* Apply sealant to the right crankcase cover of a new mechanical seal and then drive in the mechanical seal.

WATER PUMP SHAFT INSTALLATION

Drive a new water pump shaft outer bearing into the water pump assembly from the inside.
 Install the water pump shaft and shaft inner bearing into the water pump assembly.
 Install the snap ring to secure the inner bearing properly.

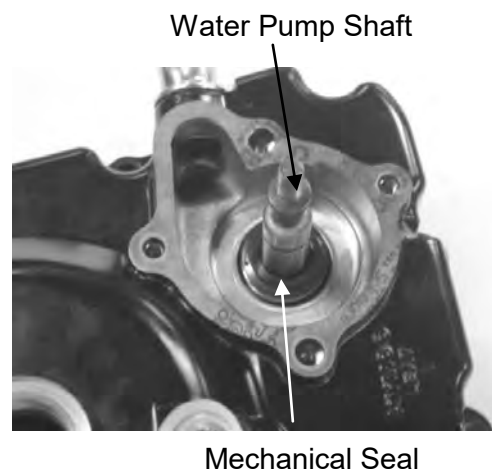

12. COOLING SYSTEM

Install the dowel pins and a new gasket and then install the water pump assembly to the right crankcase cover.
Tighten 9bolts to secure the right crankcase cover.

* When installing the water pump assembly, aligning the groove on the water pump shaft with the tab on the oil pump shaft.

WATER PUMP/IMPELLER INSTALLATION

When the mechanical seal is replaced, a new seal washer must be installed to the impeller.

Install the impeller onto the water pump shaft.

Torque: 1.0~1.4 kgf-m (11.8 N-m)

* The impeller has left hand threads.

Install two dowel pins and a new gasket.
Install the water pump cover and tighten the 4 bolts.

Torque: 1.0~1.4 kgf-m (11.8 N-m)

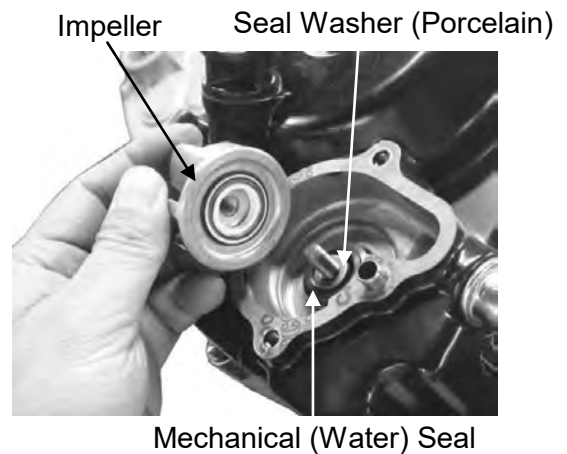

12. COOLING SYSTEM

THERMOSENSOR

THERMOSENSOR REMOVAL

Remove the met-in box and carrier.
Remove the body cover, center cover and rear fender cover A.

Drain the coolant.

Disconnect the thermosensor wire.

Remove the thermosensor.



Thermosensor

THERMOSENSOR INSPECTION

Suspend the thermosensor in a pan of water over a burner and measure the resistance through the sensor as the water heats up.

Temperature(°C)	50	80	100	120
Resistance(Ω)	154	52	27	16

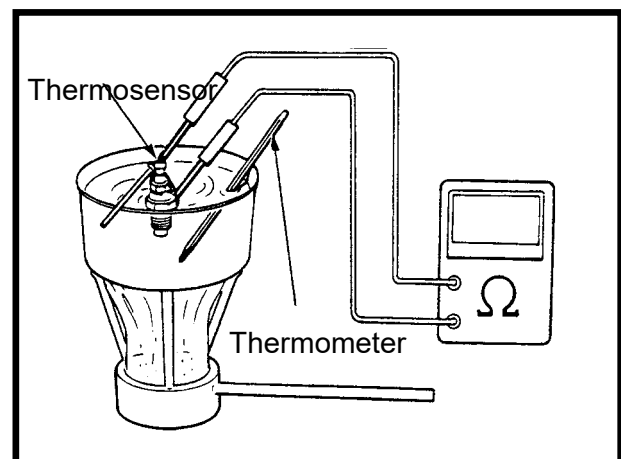

12. COOLING SYSTEM

THERMOSTAT THERMOSTAT REMOVAL

Remove the met-in box and carrier.
Remove the body cover, center cover and rear fender cover A.

Drain the coolant.

Disconnect the thermosensor wire from the thermosensor.

Disconnect the water hose from the thermostat housing.

Disconnect the air vent tube from the thermostat housing.

Remove the mounting bolt and the thermostat housing from the cylinder head.



Bolts

Remove two bolts and separate the thermostat housing halves.

Remove the thermostat from the thermostat housing.

THERMOSTAT INSPECTION

Suspend the thermostat in a pan of water over a burner and gradually raise the water temperature to check its operation.



Thermostat

Technical Data

Begins to open	80°C
Full-open	85°C
Valve lift	3.5~4.5mm

- * Do not make the thermostat touch the pan as it will give a false reading.
- * Replace the thermostat if the valve stays open at room temperature.
- * Test the thermostat after it is opened for about 5 minutes and holds the temperature at 70°C.

THERMOSTAT INSTALLATION

- * Replace the O-ring with a new one and apply grease to it.

Fill the cooling system with the specified coolant.

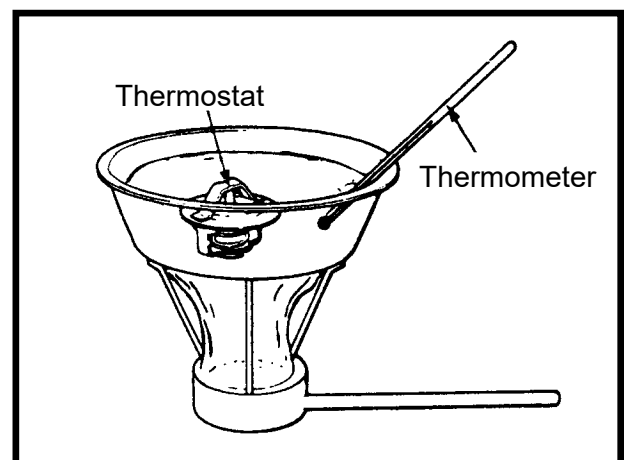

FUEL INJECTION SYSTEM

SERVICE INFORMATION-----	13- 1
SPECIFICATIONS -----	13- 2
INJECTION SYSTEM DIAGRAM -----	13- 3
PARTS LOCATION -----	13- 4
TROUBLESHOOTING-----	13- 6
SELF-DIAGNOSTIC PROCEDURES WITHOUT DIAGNOSTIC TOOL -----	13- 7
EFI SELF-DIAGNOSIS CHECK ENGINE LAMP (CELP) FAILURE CODES-----	13-8
SELF-DIAGNOSIS RESET PROCEDURE -----	13- 9
CELP FAILURE CODES LIST -----	13-10
TPS/ISC RESET -----	13-13
FUEL PUMP -----	13-14
FUEL CUT-OFF RELAY -----	13-16
TILT SWITCH -----	13-17
ELECTRONIC CONTROL UNIT (ECU)-----	13-18
FUEL INJECTOR -----	13-20
WTS SENSOR -----	13-22
O ² SENSOR -----	13-23
THROTTLE BODY/MAP/ISC/TPS -----	13-24
DIAGNOSTIC TOOL CONNECTOR-----	13-27
DIAGNOSTIC TOOL OPERATION INSTRUCTIONS-----	13-28
VEHICLE CAN NOT BE STARTED -----	13-40
MANUAL TROUBLE SHOOTING PROCEDURE-----	13-41

SERVICE INFORMATION

GENERAL INSTRUCTIONS

- Scooter services can be done with the engine installed in the frame.
- Be sure to relieve the fuel pressure before fuel pump or fuel hose removal.
- Bending or twisting the control cables will affect operation and could cause the cables to stick or bind, resulting in loss of vehicle control.
- Work in a fully ventilated area. Smoking or allowing flames or sparks in the work area or where gasoline is stored can cause a fire or explosion.
- Do not apply the Carburetor Cleaners to the inside of the throttle body, which is coated with molybdenum.
- Do not snap the throttle valve from fully open to fully close after the throttle cable has been removed; it may cause incorrect idle speed.
- Do not loosen or tighten the painted bolts and screws of the throttle body. Loosening or tightening them can cause throttle and idle valve synchronization failure.
- Seal the cylinder head intake ports with tape or a clean towel to prevent dirt and debris from entering the intake ports after the throttle body has been removed.
- Do not damage the throttle body. It may cause incorrect throttle and idle valve synchronization.
- Do not take the fuel pump on the ground downward.
- Always replace the packing when the fuel pump is removed.
- The electronic fuel injection system is equipped with the self-diagnostic system. If the Check Engine Lamp “CELP” illuminate while riding, follow the self-diagnostic procedures to solve the problem.
- A faulty FI problem is often related to poorly connected or corroded connectors. Check those connections before proceeding.
- When disassembling the fuel injection parts, note the location of the O-rings. Replace them with new ones upon reassembly.
- Do not disconnect the battery negative (-) or positive (+) cable while engine is running, it may cause ECU damage.
- **Do not disconnect or connect the ECU connector during the ignition switch “ON”; it may cause the ECU damage.**

13. FUEL INJECTION SYSTEM



X-Town300 ABS

SPECIFICATIONS

ITEM		SPECIFICATIONS
Throttle body identification number		ABD2
Idle speed		1600±100 rpm
Throttle grip free play		2~6 mm (1/16~1/4 in)
Fuel injector resistance (at 20°C/68°F)		11.7±0.6 Ω
Fuel pump resistance (at 20°C/68°F)	Float at full position	1100±33 Ω
	Float at empty position	100±3 Ω
Fuel pump standard pressure (at 40 L/Hr)		294±6 kPa (3 Bar)
Water temperature sensor resistance	At -20°C/-4°F	18.8 KΩ
	At 40°C/104°F	1.136 KΩ
	At 100°C/212°F	0.1553 KΩ
Intake pressure sensor (MAP) pressure (at 1~4.2 V)		13.332 kPa (0.13332 kgf/cm ² , 1.89 psi)~ 119.99 kPa (1.1999 kgf/cm ² , 17.04 psi)
Inductive ignition coil		Primary: 3.57~4.83 Ω Secondary: 10.42~14.49K Ω
Throttle position sensor (TPS) resistance (at 20°C/68°F)		3500~6500 Ω
Crank position sensor voltage (at 200 rpm)		100~130 Ω
O ² heater sensor resistance (at 20°C/68°F)		6.7~9.5 Ω (engine warming condition)
Tilt switch voltage	Standard	0.4~1.4 V
	Over 65° (fall down)	3.7~4.4 V

INJECTION SYSTEM DIAGRAM

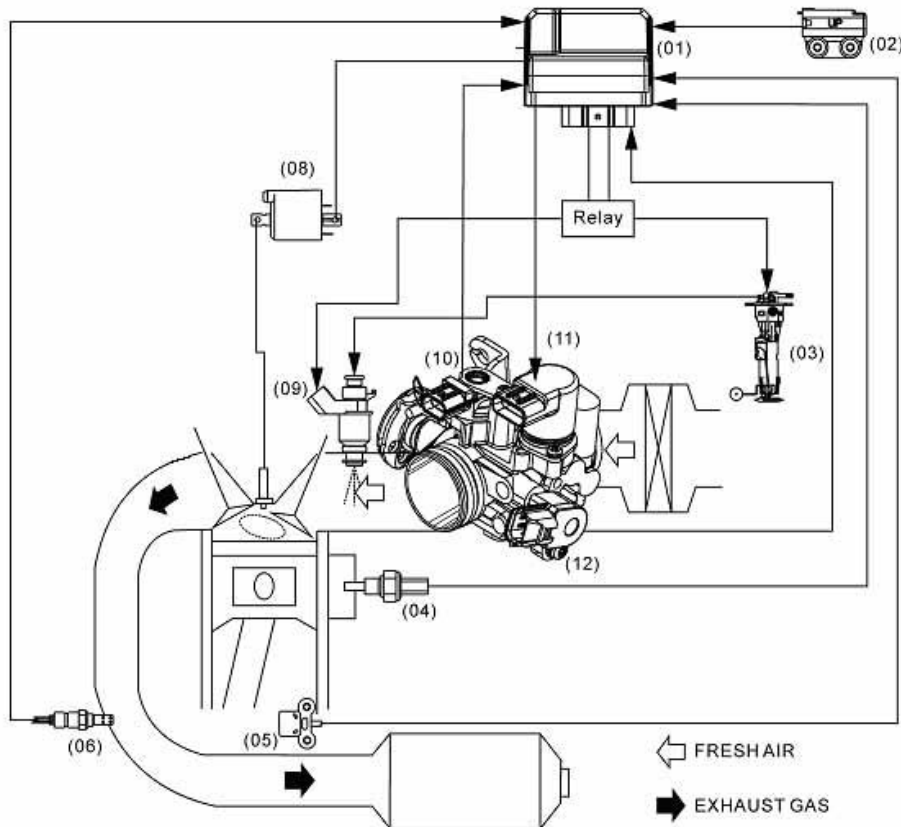

No.	FULL NAME	ABBREVIATIONS
(01)	Electronic control unit	ECU
(02)	Tilt switch (Angle detect sensor)	ROLL
(03)	Fuel pump/Fuel level unit	FP
(04)	Water temperature sensor	WTS sensor
(05)	Crank position sensor (Pulser)	CPS
(06)	Oxygen/Oxygen heater sensor	O ² /O ² Heat sensor
(08)	Inductive ignition coil	IG
(09)	Fuel injector (Nozzle)	INJ
(10)	Intake pressure sensor	MAP sensor
(11)	Idle air bypass valve	ISC
(12)	Throttle position sensor	TPS

13. FUEL INJECTION SYSTEM

PARTS LOCATION

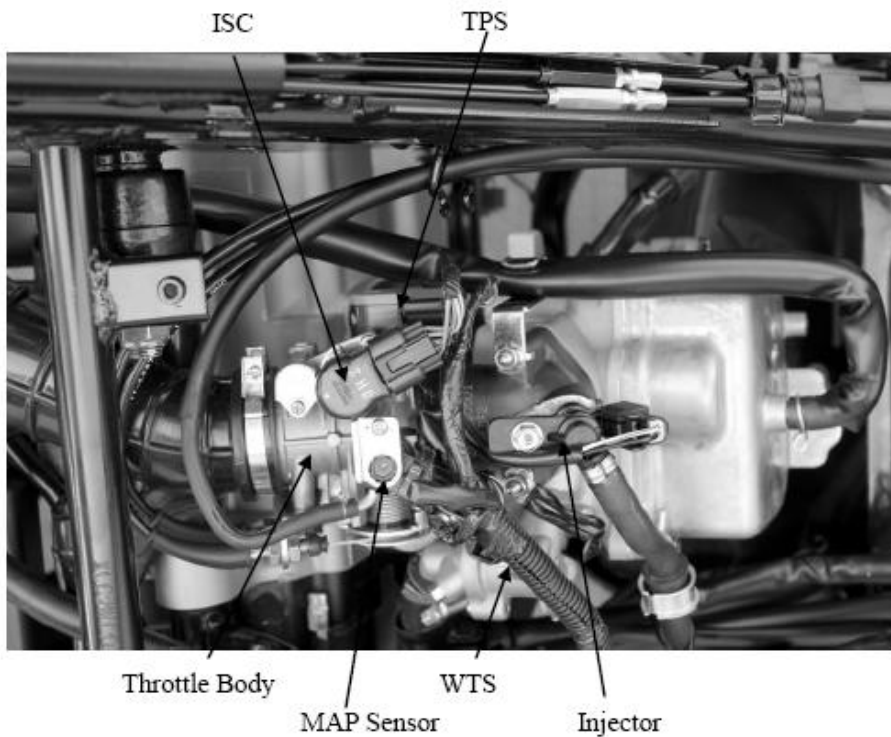
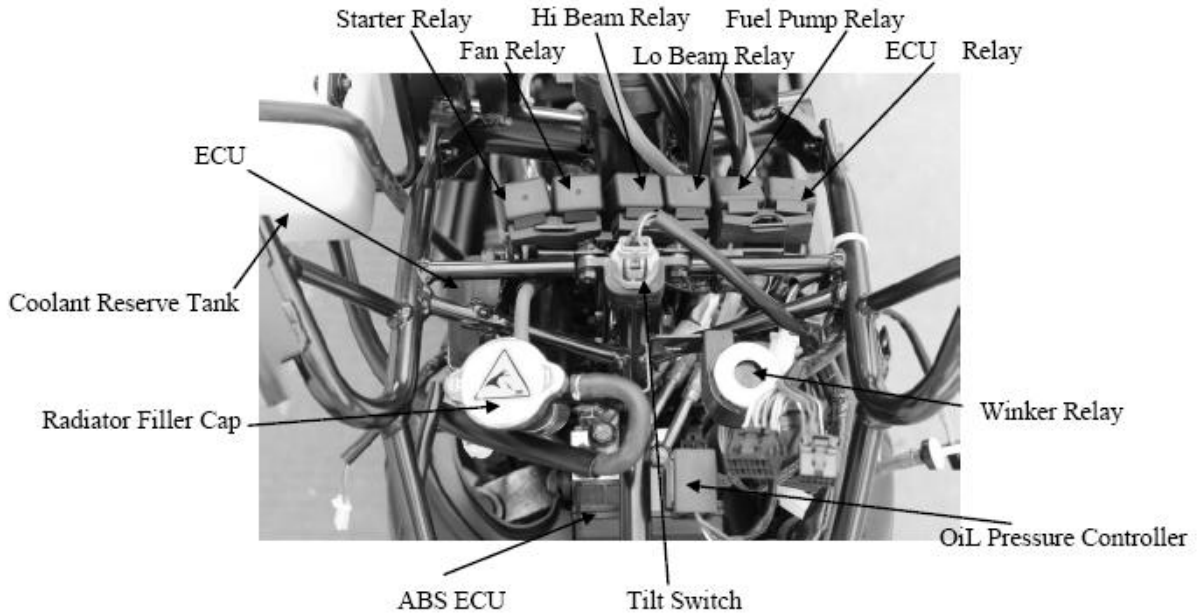

13. FUEL INJECTION SYSTEM

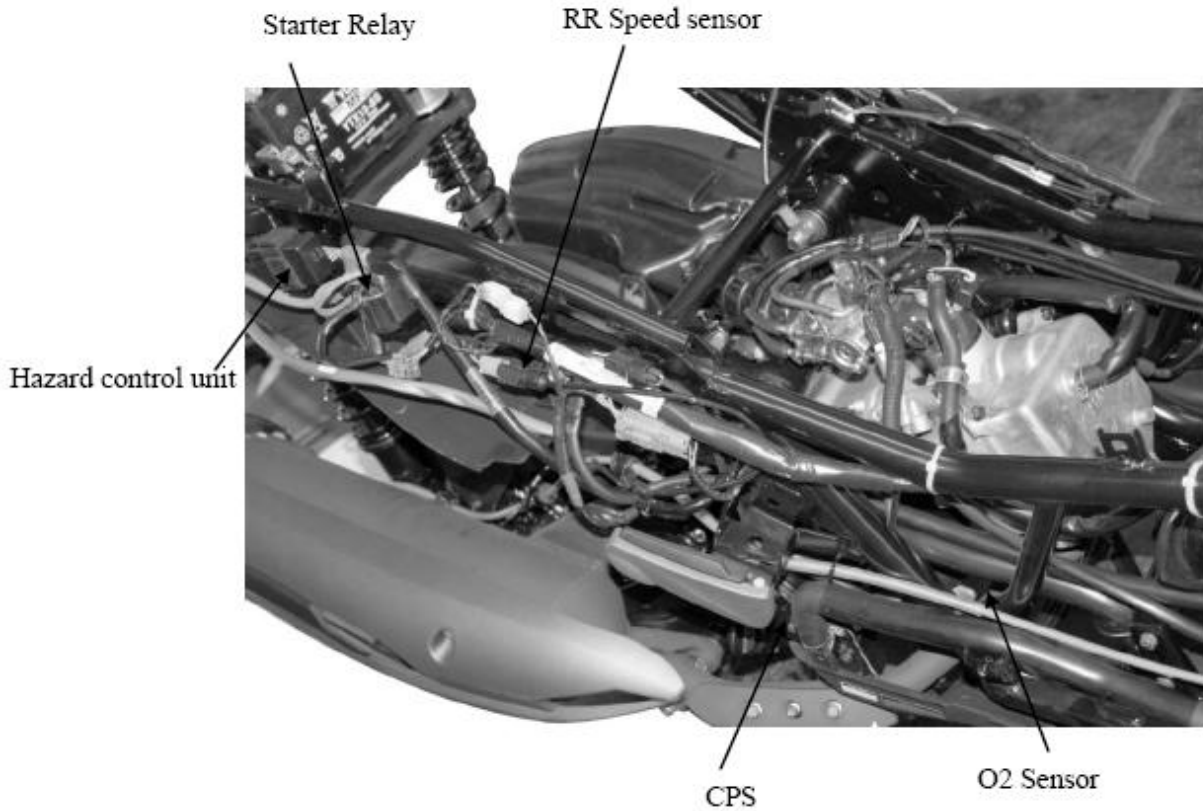
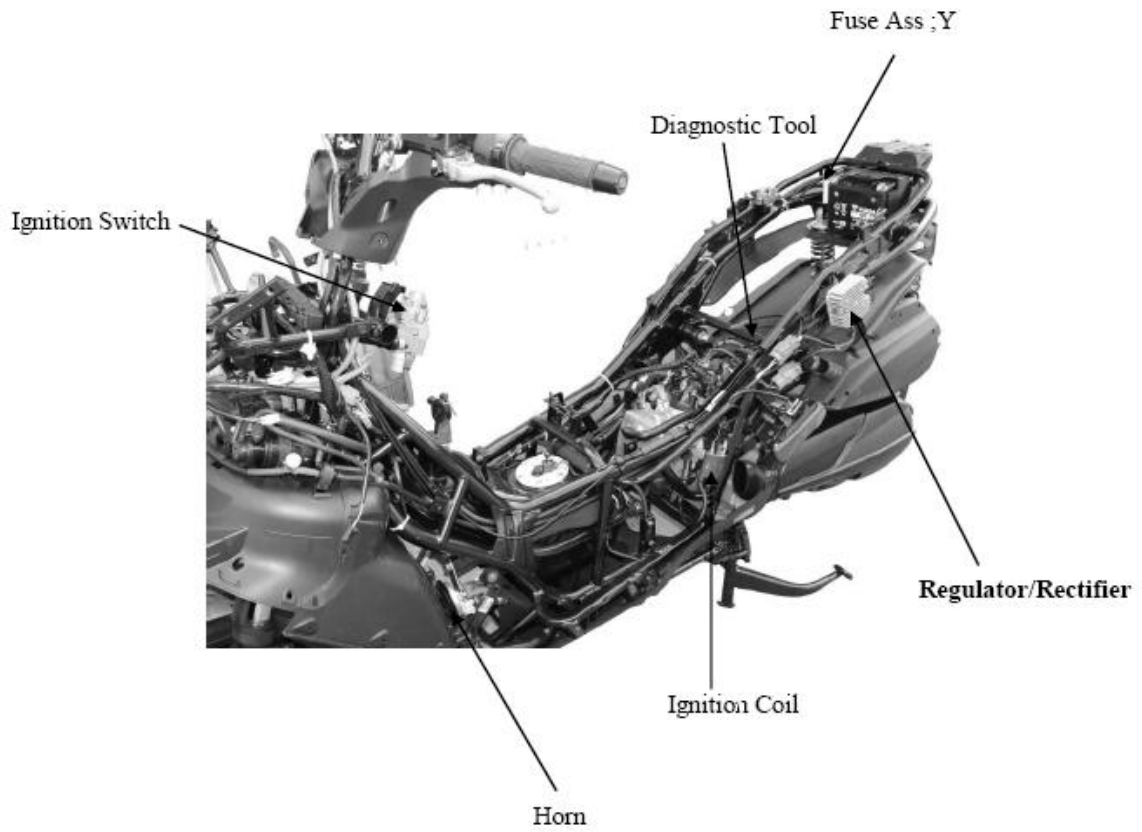

13. FUEL INJECTION SYSTEM

TROUBLESHOOTING

Engine fail to start

- Intake manifold air leak
- Fuel contaminated/deteriorated
- Pinched or clogged fuel hose
- Faulty fuel pump
- Clogged fuel filter, throttle body
- Sticking fuel injector needle
- Faulty fuel pump operating system
- Carbon deposit stayed on the fuel injector
- Spark plug dirty
- Fuel pressure incorrect

Engine stall, hard to start, rough idling

- Intake air leak
- Fuel contaminated/deteriorated
- Pinched or clogged fuel hose
- Idle speed fail to adjust
- Fail to perform PTS/ISC reset

Backfiring or misfiring during acceleration

- Ignition system malfunction

Poor performance (drive ability) and poor fuel economy

- Pinched or clogged fuel hose
- Faulty injector

SELF-DIAGNOSTIC PROCEDURES WITHOUT DIAGNOSTIC TOOL

SELF-DIAGNOSTIC PROCEDURES

* It can be performed without diagnostics program.

Place the scooter on its main stand.

Put the side stand up and the engine stop switch is at "RUN".

- Turn key to On position.
- The CELP will be lighting all along and then off.
- If the engine has problem, the CELP will blink to show the failure codes.
- There're 12 failure codes for the KEHIN system.

If the vehicle gets more failure codes, the CELP will be blinking from a lower number, then show the higher number after three seconds. All failure codes would be appeared repeatedly.

* No matter when the "CELP" illuminated while riding condition, should find out the cause of the problem as soon as

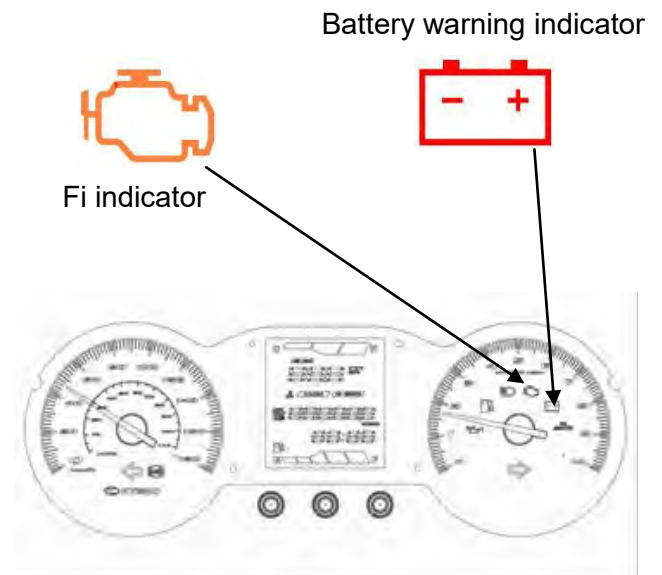
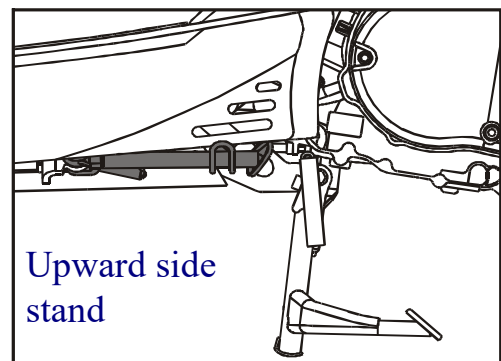

EFI SELF-DIAGNOSIS CHECK ENGINE LAMP (CELP) FAILURE CODES

The “CELP” denotes the failure codes. When the indicator lights for one second that is equal to ten.

For example: one longer blink illumination and two shorter blinks (0.5 second x 2) of the indicator is equal to 12 blinks. Follow code 12.

If more than a damaged part has occurred, the “CELP” begins blinking in order.

For example: If the indicator blinks six times, then shows one second illumination and two blinks, so there are two failures have occurred. Follow code 6 and 12.

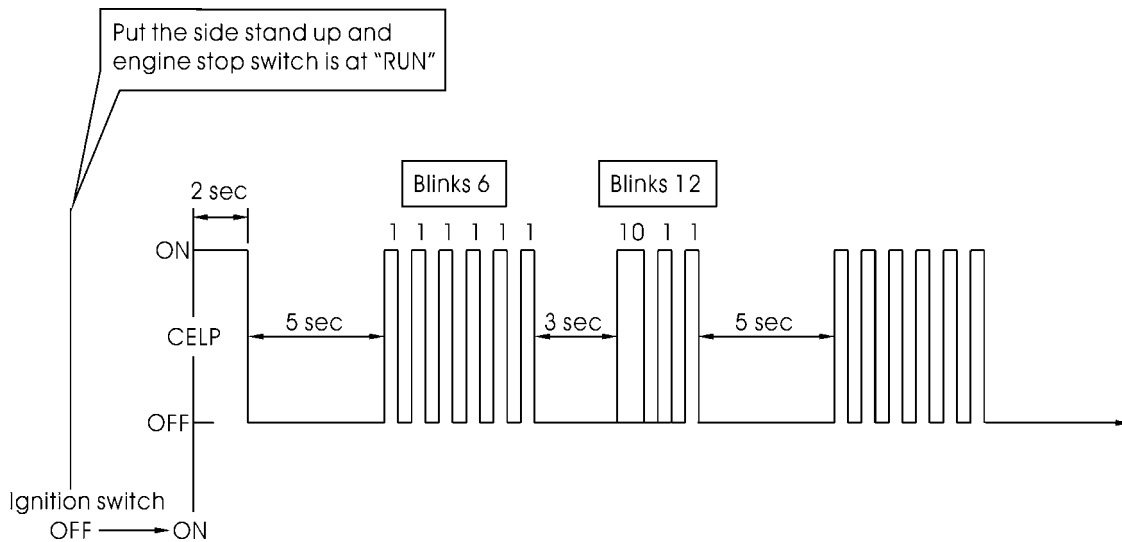

SELF-DIAGNOSIS RESET PROCEDURE

1. Put the side stand up and engine stop switch is at "RUN".
2. Turn the key to the ON position and wait for ten seconds.
3. Fully open the throttle and wait for ten seconds.
4. Release the throttle.
5. The indicator will blink twice (0.5 second) after five seconds quickly.
6. Self-diagnosis memory data is disappeared after the CELP lamp is off.

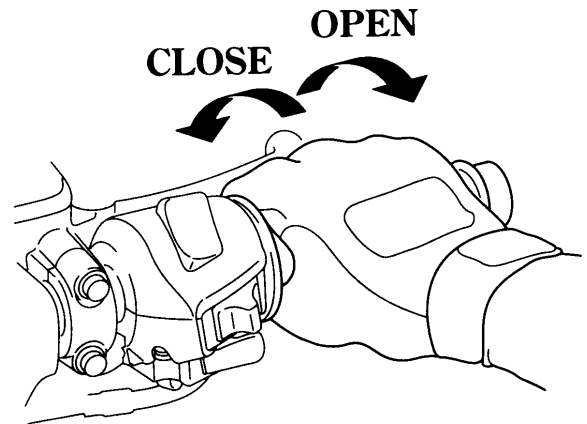

* The self-diagnosis can not be reset when has still problem inside the system.

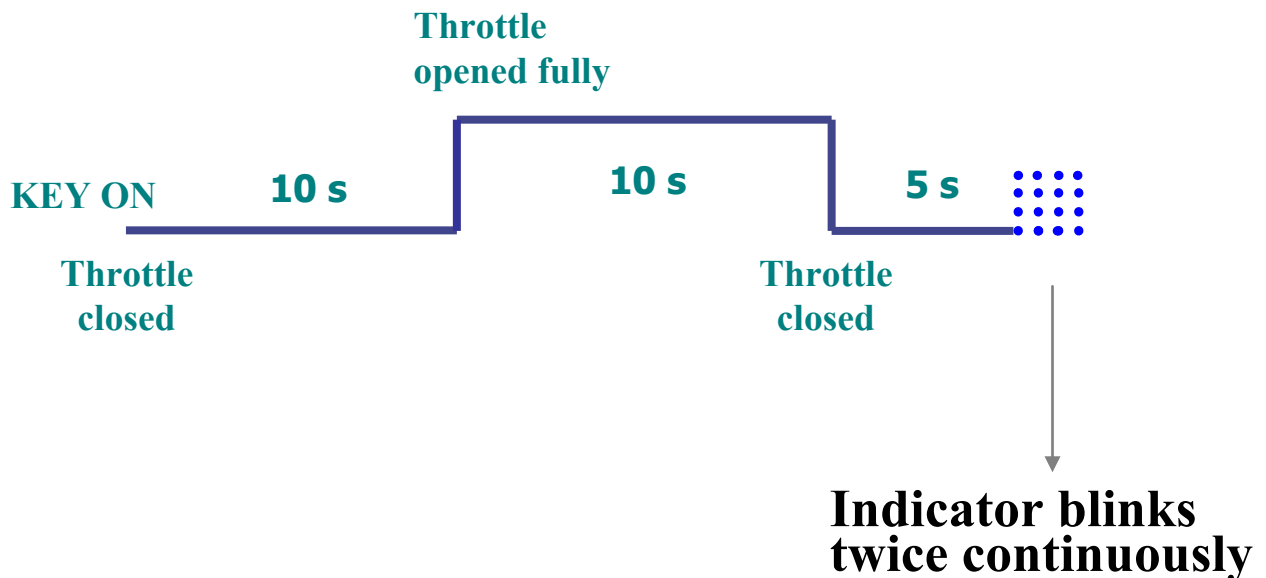

CELP FAILURE CODES LIST

Blinks	Failure Codes (diagnostic tool)	Contents	Causes	Symptoms
06	P0120	Faulty TPS	<ul style="list-style-type: none"> ● Faulty TPS voltage range (0.3~4.5 V) ● Loose or poor connection on TPS Sensor ● Open or short circuit on the TPS wire ● Faulty TPS itself. 	Engine operates normally
09	P0105	Faulty MAP	<ul style="list-style-type: none"> ● Faulty MAP voltage range (1~4.2 V) ● Loose or poor connection on MAP Sensor ● Open or short circuit on MAP wire ● Faulty MAP itself 	Engine operates normally
12	P0115	Faulty WTS (water temperature)	<ul style="list-style-type: none"> ● Faulty ECT Ω range (-20°C: 18.8 Ω/40°C: 1.136 Ω/100°C: 0.1553 Ω) ● Loose or poor connection on ECT ● Open or short circuit on ECT wire ● Faulty ECT 	Engine operates normally
15	P1630	Faulty Tilt switch (Roll)	<ul style="list-style-type: none"> ● Faulty Tilt switch voltage range (inclined angle <65°: 0.4~1.4 V/ Inclined angle >65°: 3.7~4.4 V) ● Loose or poor connection on Tilt switch ● Open or short circuit in Tilt switch wire ● Faulty tilt switch 	Engine operates normally
17	P0130	Faulty O ² sensor	<ul style="list-style-type: none"> ● Faulty O² sensor voltage range (A/F below 14.7: > 0.7V/ A/F over 14.7: < 0.18 V) ● Loose or poor connection on O² sensor ● Open or short circuit on O² sensor wire ● Faulty O² sensor 	Engine operates normally
33	P0201	Faulty injector (Nozzle)	<ul style="list-style-type: none"> ● Faulty Fuel injector Ω range (9.945~13.5 Ω) ● Loose or poor connection on injector ● Open or short circuit on injector wire ● Faulty fuel injector 	Engine fail to be operated

13. FUEL INJECTION SYSTEM



X-town300 ABS

Blinks	Failure Codes (diagnostic tool)	Contents	Causes	Symptoms
37	P0351	Faulty inductive ignition coil	<ul style="list-style-type: none"> ● Faulty Inductive ignition coil Ω range ($4.2 \Omega \pm 15\%$) ● Loose or poor connection on inductive ignition coil ● Open or short circuit on inductive ignition coil wire ● Faulty inductive ignition coil 	Engine fail to be operated
41	P0230	Faulty fuel pump	<ul style="list-style-type: none"> ● Faulty Fuel pump Ω range (F: $1100 \pm 33 \Omega$ E: $100 \pm 3 \Omega$) ● Loose or poor connection on fuel pump ● Open or short circuit on fuel pump wire ● Faulty fuel pump 	Engine fail to be operated
43	P0480	Fan relay	<ul style="list-style-type: none"> ● Fan relay fault 	Fan is not moving
45	P0135	Faulty O ² sensor heater	<ul style="list-style-type: none"> ● Faulty O² sensor heater Ω range ($6.7 \Omega \sim 9.5 \Omega$) ● Loose or poor connection on O² sensor heater ● Open or short circuit on O² sensor heater wire ● Faulty O² sensor heater 	Engine starts normally but not smooth
49	P1505	Faulty ISC	<ul style="list-style-type: none"> ● Loose or poor contacts on ISC ● Open or short circuit in ISC wire ● Faulty ISC 	Engine operates normally
66	P0335	Faulty CPS	<ul style="list-style-type: none"> ● Loose or poor connection on CPS sensor ● Open or short circuit on CPS wire ● Faulty CPS sensor 	Engine starts normally but not smooth

SPARK PLUG ANTI-FLOOD

When have not failure code occurs and pressing starter switch repeatedly, can still not start the engine, maybe the spark plug is wet by fuel, perform the spark plug anti-flood to purge the fuel in the engine.

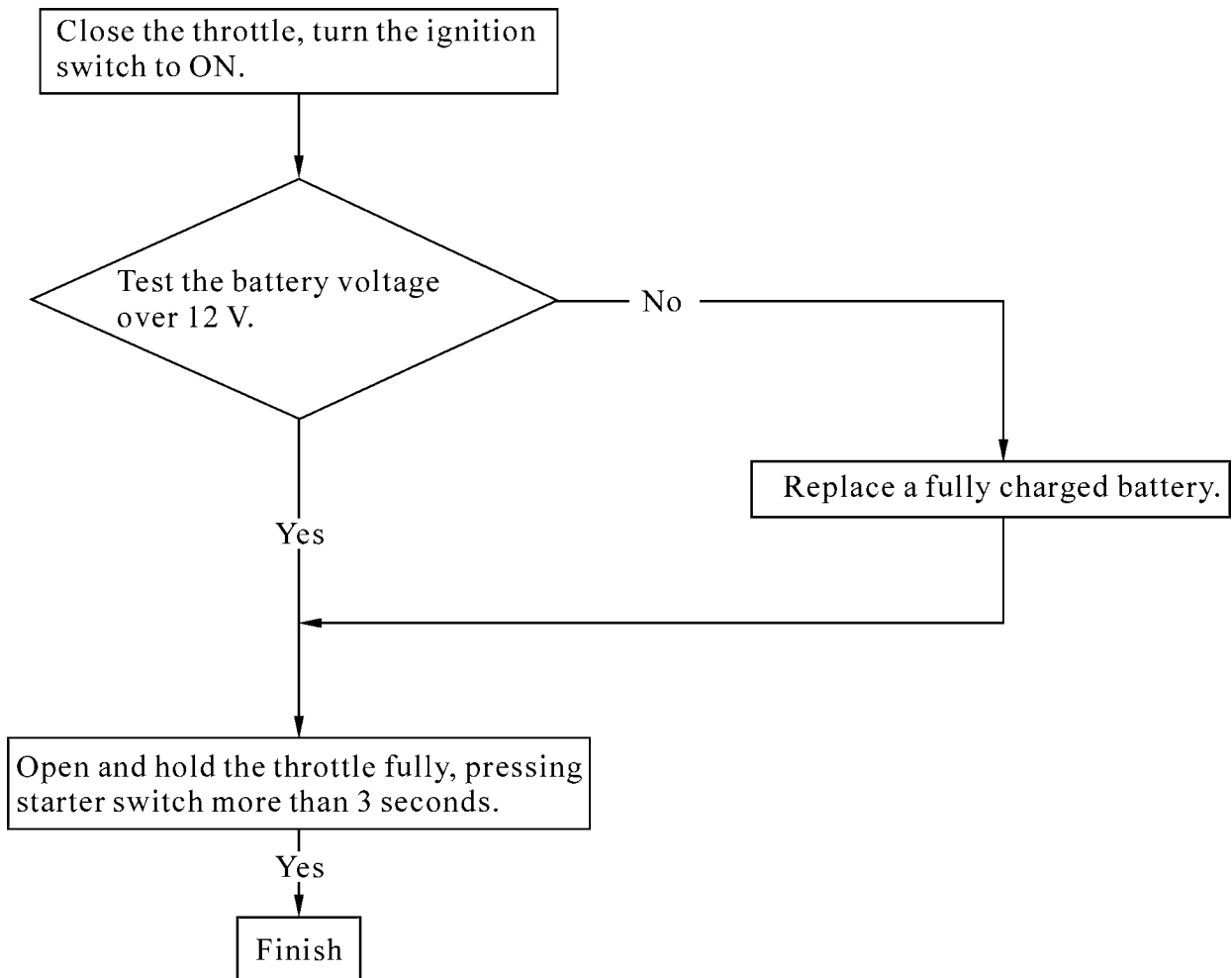

TPS/ISC RESET

- If close or open the throttle grip randomly, the ECU may record the incorrect TPS when the ECU or the throttle body has been reinstalled. It can cause hard to start engine or idling speed is not smooth when engine installation.
- ISC has a motor inside, which controls ISC valve to obtain smooth idling speed. The ECU may record the incorrect ISC position during the engine speed isn't working when the ECU or the throttle body has been reinstalled. It can cause engine stop, hard to start engine or rough idling speed.

The throttle position sensor (TPS) and idle air bypass valve (ISC) have to be reset when throttle body, MAP, TPS, ISC or ECU has been reinstalled.

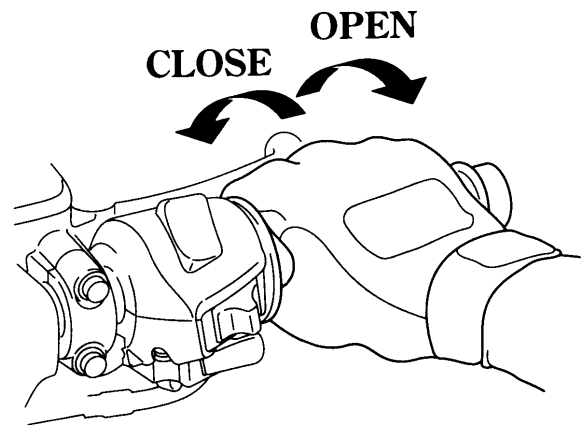

TPS/ISC RESET PROCEDURE

1. Put the side stand up and engine stop switch is at "RUN".
2. Turn the key to the OFF position.
3. Fully open the throttle and hold.
4. Turn the key to the ON position.
5. Release the throttle after waiting for eight seconds.
6. Turn the key to the OFF position.
7. Waiting for two seconds
8. Turn the key to the ON position.
9. Waiting for two seconds
10. TPS and ISC have been reset successfully.

If fail to reset, repeat the steps from 1 to 10.

FUEL PUMP

INSPECTION

Put the side stand up and the engine stop switch is at "RUN"

Disconnect the fuel pump/fuel unit connector.

Connect the multimeter (+) probe to the Red/Black terminal and the multi-meter (-) probe to the Green terminal.

Turn the ignition switch to "ON" and measure the voltage between the terminals.

It should be shown the current battery voltage for a few seconds.

If there is still battery voltage, replace the fuel pump.

If there is not any battery voltage, inspect the following:

- Fuse B (10 A)
- Fuel cut-off relay
- ECU

Measure the resistance between the Red/Black and Green terminals of the fuel pump side connector.

Standard (at 20°C/68°F): 1.9±0.3 Ω

Fuel level sensor inspection

Measure the resistance between the Yellow/White and Green terminals of the fuel pump side connector.

Standard (at 20°C/68°F):

Float at full position	1100±3 Ω
Float at empty position	100±3 Ω

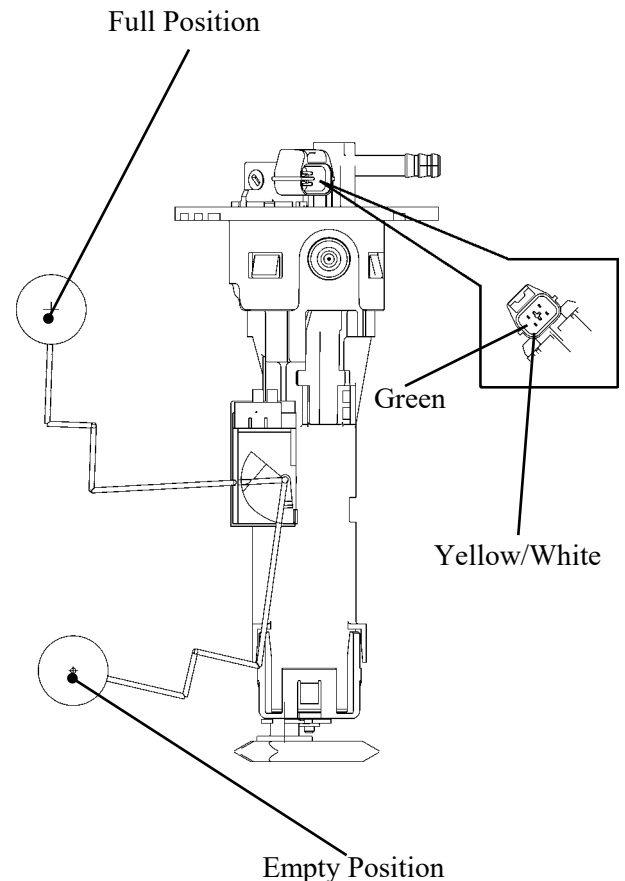

REMOVAL

Disconnect the connector and fuel band from the fuel pump.

Remove the six screws onto the fuel pump.

Remove the fuel pump and O-ring.

Fuel Pump Connector

Hose band

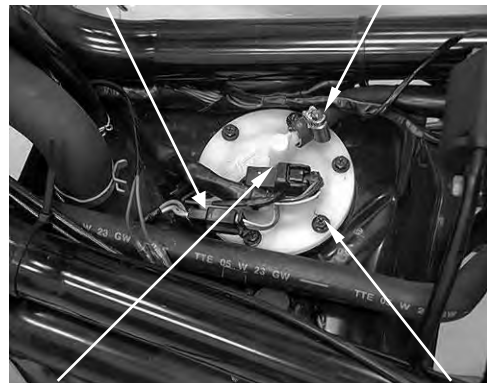

Connector

Screw

INSTALLATION

Replace a new O-ring on the fuel tank.

Don't damage the fuel pump wire and ensure the connector rearward carefully.

Torque: 0.35 kgf-m (3.5 N-m, 2.5 lbf-ft)



O-ring

FUEL OUTPUT PRESSURE INSPECTION

Turn the key to the OFF position.

Use the fuel hose clamp.

Disconnect the fuel hose from the fuel injector.

Connect the fuel pressure gauge.

Turn the key to the ON position.

Check the fuel pressure.

Standard:3.0 Bar

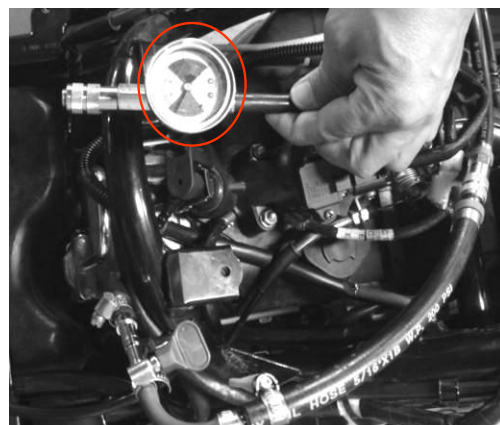
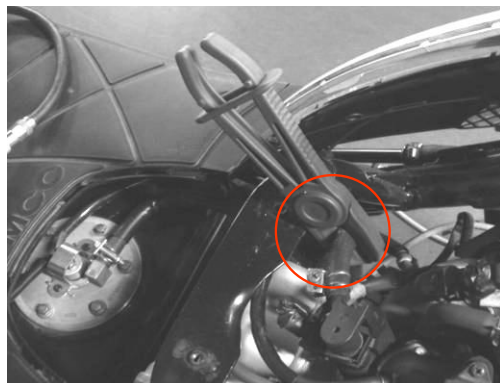

* **If the fuel output pressure is less than 3.0 bar, may fail to start the engine or in trouble in case of riding.**

FUEL CUT-OFF RELAY

INSPECTION

Remove the fuel cut-off relay.
Connect the ohmmeter to the fuel cut-off relay connector terminals.

Connection: Black – Red/Black

Connect 12 V battery with the fuel cut-off relay connector.

Connection: Blue/Black – Black

There should be continuity only when 12 V battery connected.
If there is not continuity when the 12 V battery is connected, replace a fuel cut-off relay.

REMOVAL

Disconnect the fuel cut-off relay connector and remove it from frame.

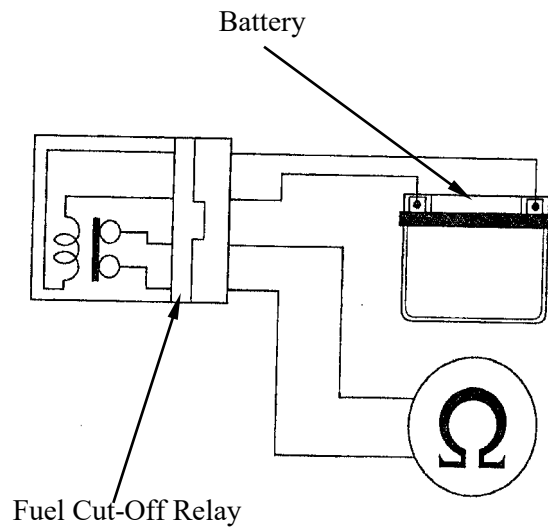

OiL Pressure Controller Fuel Pump Relay

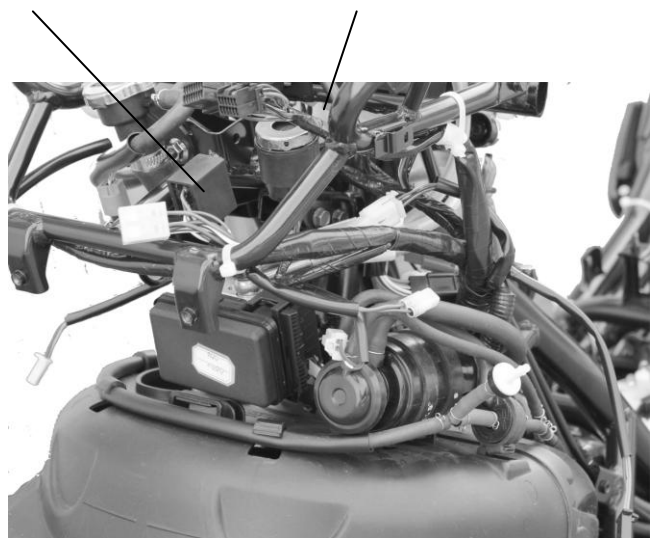

13. FUEL INJECTION SYSTEM

TILT SWITCH

INSPECTION

Support the scooter level surface.
Put the side stand up and engine stop switch is at "RUN".

Turn the ignition switch to "OFF"
Remove the screws, washers and tilt switch.

***** Do not disconnect the tilt switch connector during inspection.

Place the tilt switch vertical as shown, and turn the ignition switch to "ON".

Measure the voltage between the following terminals of the tilt switch connector with the connector connected.

Terminal	Normal
Violet/Red (+) – Green/Pink (-)	5 V (ECU voltage)
Black/Blue (+) – Green/Pink (-)	0.4~1.4 V

Incline the tilt switch 65 ± 10 degrees to the left or right with the ignition switch turned to "ON".

Measure the voltage between the following terminals of the tilt switch connector with the connector connected.

Terminal	Normal
Violet/Red (+) – Green/Pink (-)	5 V (ECU voltage)
Black/Blue (+) – Green/Pink (-)	3.7~4.4 V

If repeat this test, first turn the ignition switch to "OFF", then turn the ignition switch to "ON".

REMOVAL/INSTALLATION

Disconnect the connector and remove two screws.

Remove the Tilt switch.

Installation is in the reverse order of removal.

***** Install the tilt switch with its "UP" mark facing up.

Tighten the mounting screws securely.

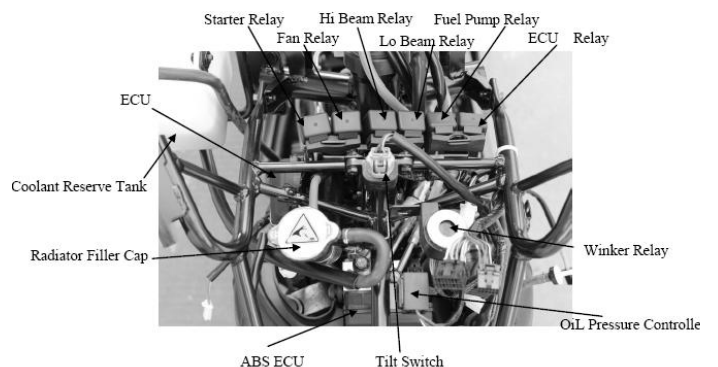

ELECTRIC CONTROL UNIT (ECU)

REMOVAL/INSTALLATION

- * • Do not disconnect or connect the ECU connector during the ignition switch "ON"; it may cause the ECU damaged.
- The throttle position sensor (TPS) and idle air bypass valve (ISC) have to be reset when throttle body, MAP, TPS, ISC or ECU has been reinstalled.

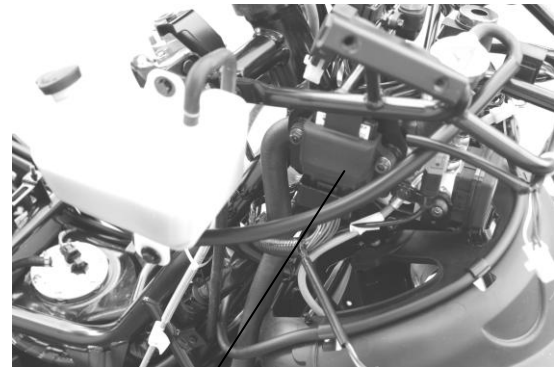

ECU

Disconnect the ECU connector and remove the ECU from the frame.

Installation is in the reverse order of the removal.

INSPECTION

Disconnect and remove the ECU from the frame.

Check for continuity between pin 9 and 10 of the ECU side connector.

There should be continuity at all times.

Check for continuity between each pins 2, 23 and 4 of the ECU side connector.

There should be continuity at all times.

Check for continuity between pin 4 and 10 of the ECU side connector.

There should be no continuity at all times.

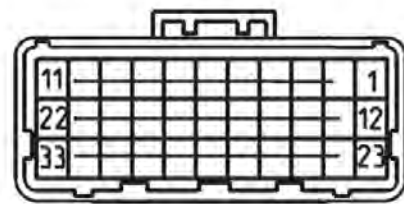
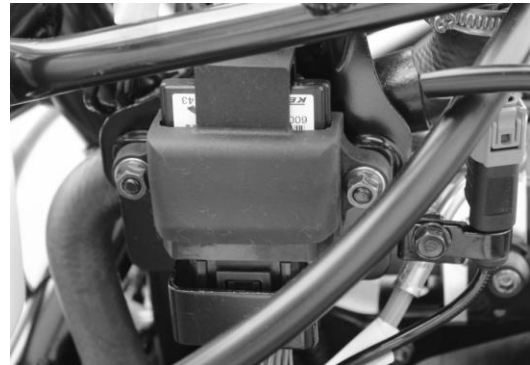

ECU PIN FUNCTION

PIN NO.	NAME	FUNCTION	PIN NO.	NAME	FUNCTION
1	IGP	Ignition power	18	MIL	Multi indicator lamp (ECLP)
2	LG	Logic ground	19	FLPR	Fuel pump relay
3	HEGO	HEGO sensor	20	ISCBP	Idle speed control (ISC) B (+)
4	SG	Sensor ground	21	ISCAP	Idle speed control (ISC) A (+)
5	TH	Throttle position sensor	22	HEGO HT	HEGO HT sensor (O2 HT sensor)
6	VCC	Sensor power output (+5V)	23	CRK-M	Crank pulse sensor ground
7	BATT	Battery	24	TW	Water temperature sensor
8	FAN	FAN RELAY	25	—	—
9	PG1	Power ground 1	26	ROLL	Roll sensor
10	PG2	Power ground 2	27	PM	Manifold pressure sensor (Intake pressure sensor)
11	IG	Ignition coil	28	SOL	—
12	CRK-P	Crank pulse sensor	39	—	—
13	—	—	30	K-LINE	Diagnostic tool
14	—	—	31	ISCBN	Idle speed control (ISC) / B (-)
15	TEST	—	32	ISCAN	Idle speed control (ISC) / A (-)
16	INJ	Injection	33	NE	Meter
17	—	—			

FUEL INJECTOR

INSPECTION

Disconnect the fuel injector connector.
Measure the resistance between 2 pins of the fuel injector connector.

Standard: $11.7 \pm 0.6 \Omega$ (at 20°C/68°F)

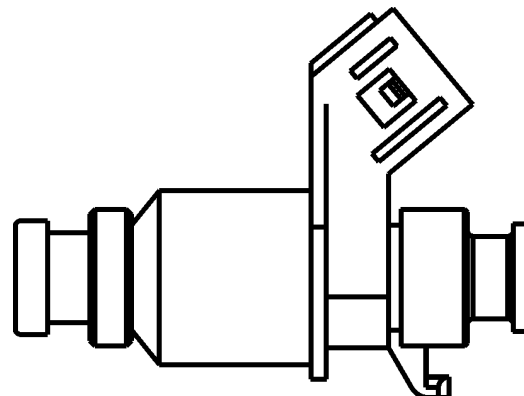

REMOVAL

Disconnect the connector from the fuel injector.
Remove the bolt of the fuel injector.
Take out of the fuel pipe and fuel injector from the Inlet pipe.
Remove the fuel injector from the fuel pipe.

*

Ensure the fuel pipe without any pressure, then remove the fuel injector.
STEP 1: Disconnect the fuel pump relay or fuel pump connector.
STEP 2: Turn the key to the ON position. Starting the engine till the engine stop working.

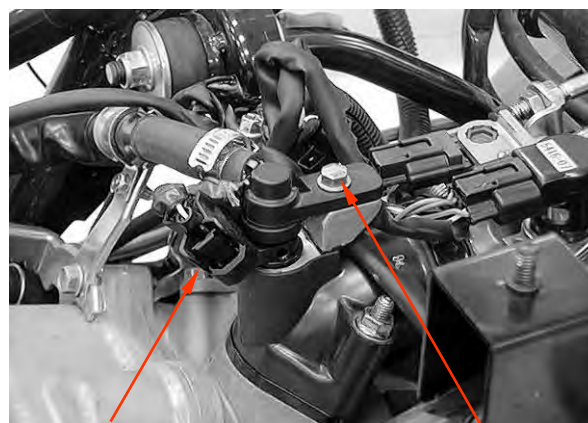

Connector

Bolt

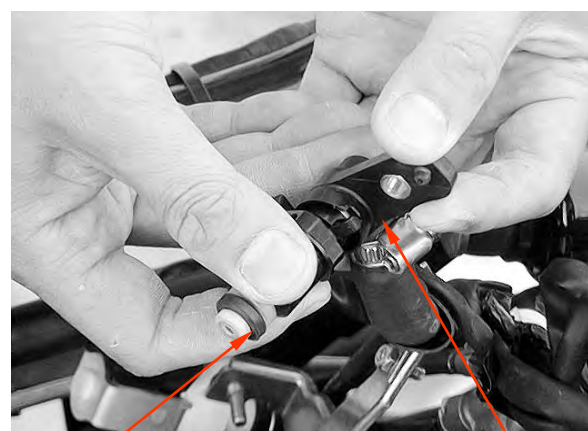

O-ring

Fuel Injector

INSTALLATION

Apply the engine oil to a new O-ring.
Install the fuel injector into the fuel pipe.
Ensure the tab of the fuel injector inserted into the groove of the fuel pipe.

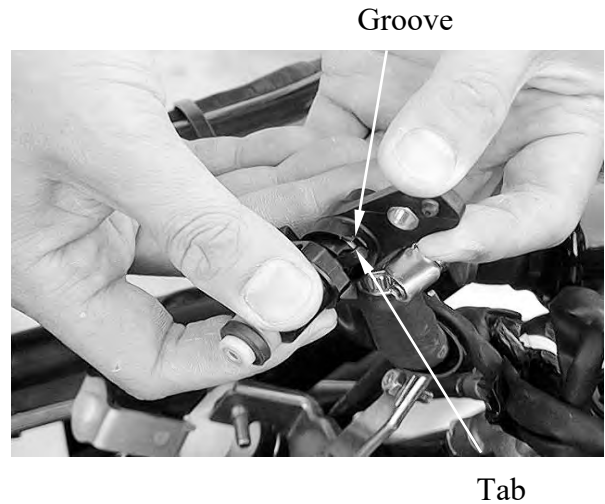

Install the fuel pipe into the intake manifold by aligning the dowel pin.
Be careful not to damage the O-ring.
Tighten the fuel pipe mounting bolt.

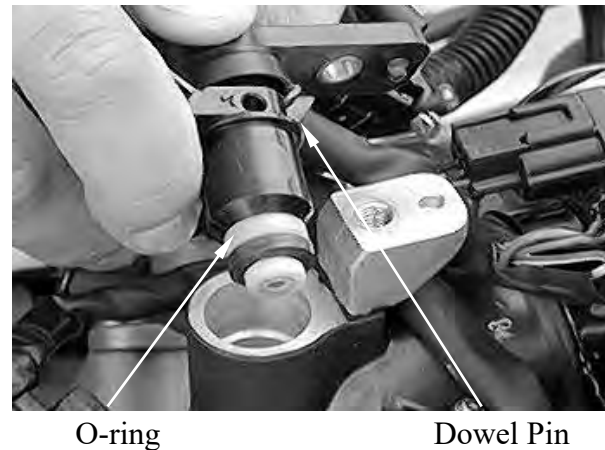

FUEL INJECTOR CLEANING

PROBLEM

1. Fuel Injector cannot output the fuel.
2. The Injector injection time (ms) is shorter or longer.

Standard: < 1.6ms

ANALYSIS

Injector block (With some carbons).

TROUBLESHOOTING

1. Use the specified injector cleaner.
2. Pouring the liquid of carburetor cleaner until half container.
3. Connect the battery as picture.
4. The injector cleaner with the flash relay.
5. Keeping the fuel Injector operation.
6. Waiting for 20~30 minutes.
7. Cleaning the carbons completely.

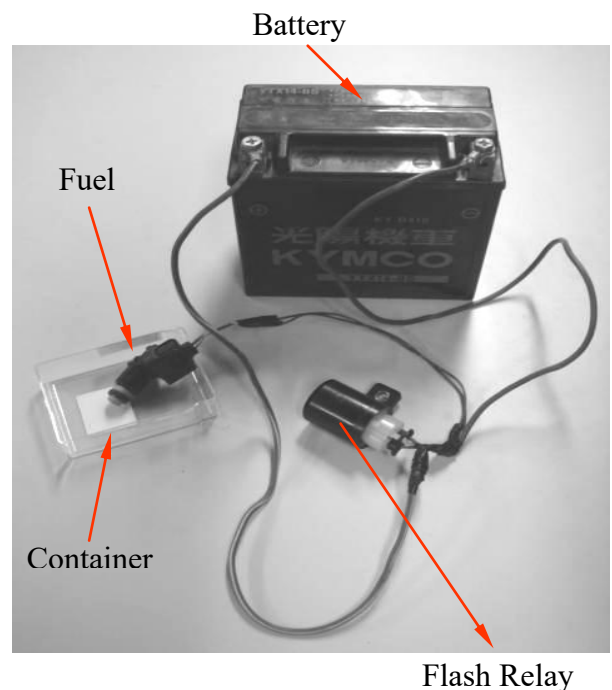

WTS SENSOR (Water Temperature Sensor)

REMOVAL / INSTALLATION

Drain the coolant from the cooling system.
Disconnect the WTS sensor connector from the sensor.

Remove the WTS sensor and O-ring.

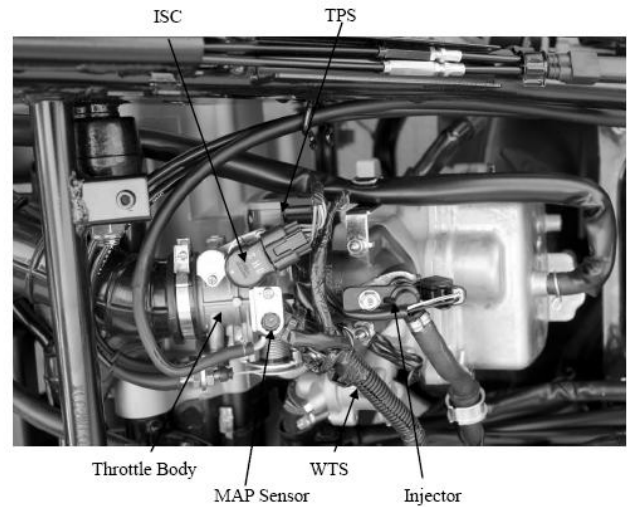

Install a new O-ring and WTS sensor.

* Always replace an O-ring with a new one.

Tighten the WTS sensor to the specified torque.

Torque: 1.2 kgf-m (12 N-m, 8.6 lbf-ft)

Connect the WTS sensor connector.

Fill the cooling system with the recommended coolant.

INSPECTION

Measure the resistance at the WTS sensor terminals.

STANDARD

°C	-20	40	100
KΩ	18.8	1.136	0.1553

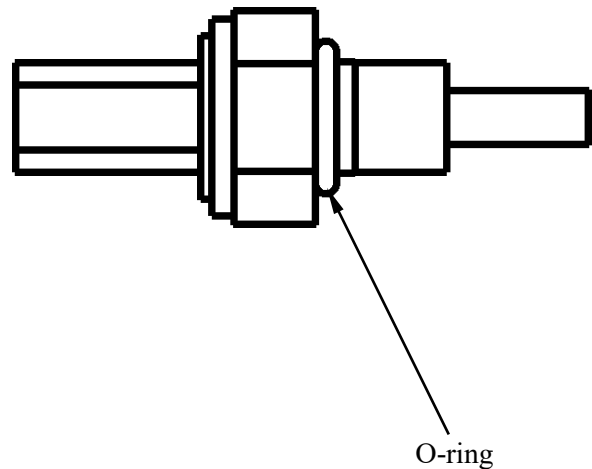

O² SENSOR

The O² sensor issues signal to ECU when the temperature is over 350°C during the engine is working.

The temperature is up to 350°C earlier than the muffler for O² heater sensor. So the O² sensor begins performance.

The function of O² sensor only controls the fuel injector operation.

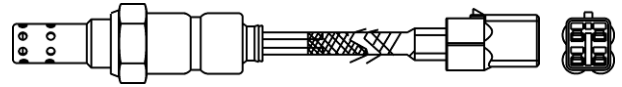

INSPECTION

Disconnect the O² sensor connector.

Measure the resistance between each White wire terminals of the O² sensor side connector.

Standard: 7.7±1.2 Ω (at 20°C/68°F)

REMOVAL/INSTALLATION

Disconnect the O² sensor connector and then remove it from exhaust muffler.

Installation is in the reverse order of removal.

Apply anti-seize compound on the surface of thread area before O² sensor

Tighten the O² sensor to specified torque.

Torque: 2.5 kgf-m (25 N-m, 18 lbf-ft)

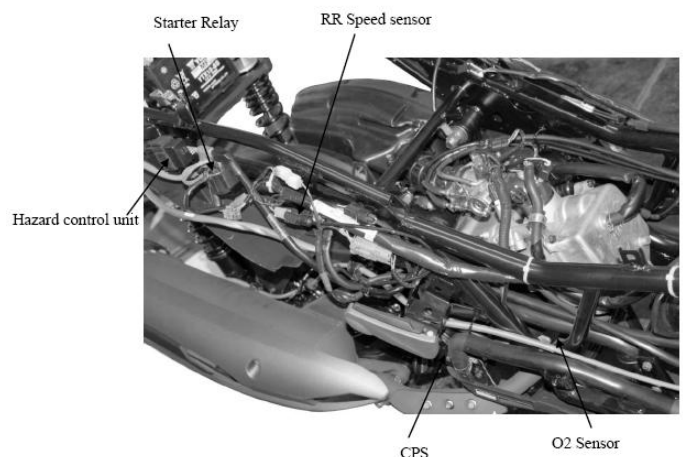

THROTTLE BODY/MAP/ISC/TPS

- Turn off the ignition switch while replacement.
- Check and confirm if the voltage is over 12V by a voltmeter after replacement.
- Check and confirm if the other connectors are installed correctly after replacement.
- Do not damage the throttle body, it may cause the throttle and idle valve isn't synchronization.
- The throttle body is preset in KYMCO factory, do not disassemble it by a wrong way.
- Do not loosen or tighten the painted bolts and screws for the throttle body. Loosen or tighten them can cause the throttle and idle valve to synchronization failure.
- **TPS and ISC have to be reset after the throttle body MAP, TPS, ISC or ECU has been reinstalled.**



MAP INSPECTION

Support the scooter on a level surface.
Put the side stand up and engine stop switch is at "RUN".

Turn the ignition switch to "ON" position.

Measure if the ECU voltage outputs to the MAP between the following terminals of the MAP connector.

Terminal	Normal
Violet/Red (+) – Green/Pink (-)	5 V

TPS INSPECTION

Support the scooter on a level surface.

Put the side stand up and engine stop switch is at "RUN".

Turn the ignition switch to "ON".

Measure if the ECU voltage outputs to TPS between the following terminals of the TPS connector.

Terminal	Normal
Violet/Red (+) – Green/Pink (-)	5 V

Throttle position sensor (TPS) resistance (at 20°C/68°F) 3500~6500 Ω

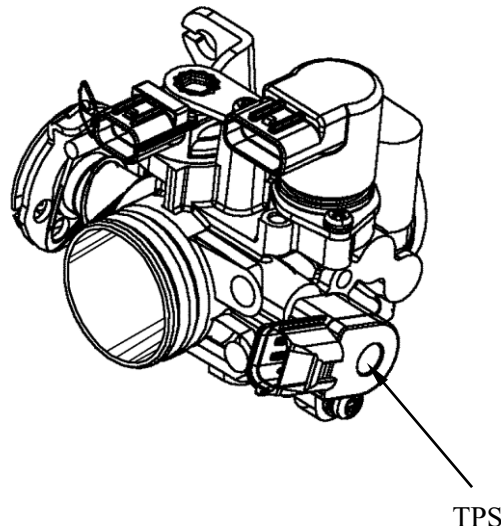

REMOVAL

Loosen the throttle cables with the adjusting nuts.

Disconnect the throttle cable ends from throttle seat.

Cable Ends

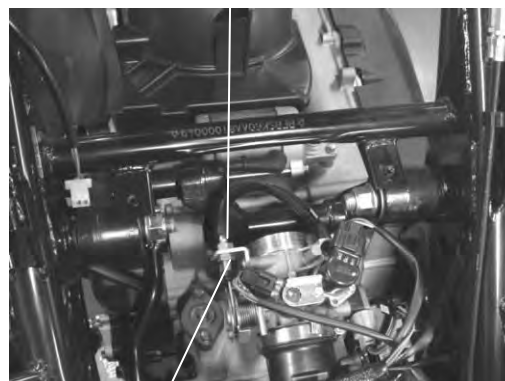

Adjusting Nuts

Disconnect the TPS, ISC and MAP sensor connectors.

Loosen the air cleaner connecting hose band screw.

Loosen the intake manifold band screw.

Remove the throttle body, MAP sensor, TPS sensor and ISC sensor as a set.

ISC Sensor MAP Sensor

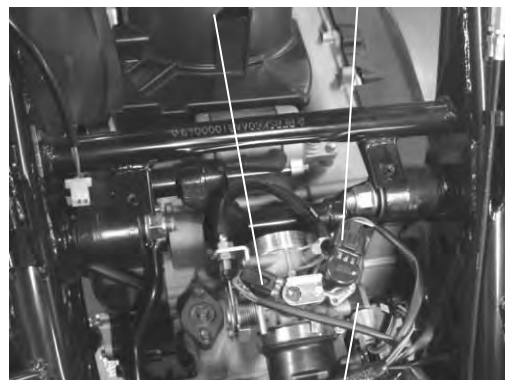

TPS Sensor

DISASSEMBLY

* The throttle position sensor (TPS) and idle air bypass valve (ISC) have to be reset when the throttle body MAP, TPS, ISC or ECU has been reinstalled.

Remove the screw and then remove the ISC and set plate.

Remove the screw and set plate.

Remove the MAP

Remove the screw AND then remove the TPS.

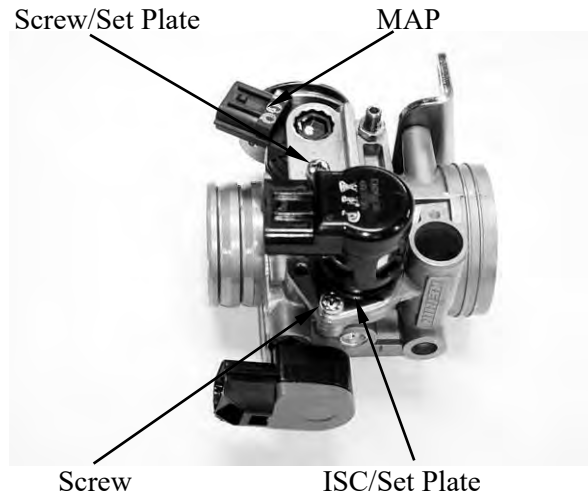

ASSEMBLY

* The throttle position sensor (TPS) and idle air bypass valve (ISC) have to reset when the throttle body MAP, TPS, ISC or ECU has been reinstalled.

Apply oil onto a new O-ring.

When install the TPS onto the throttle body, being careful not to damage the O-ring.

Install and tighten the screw securely.

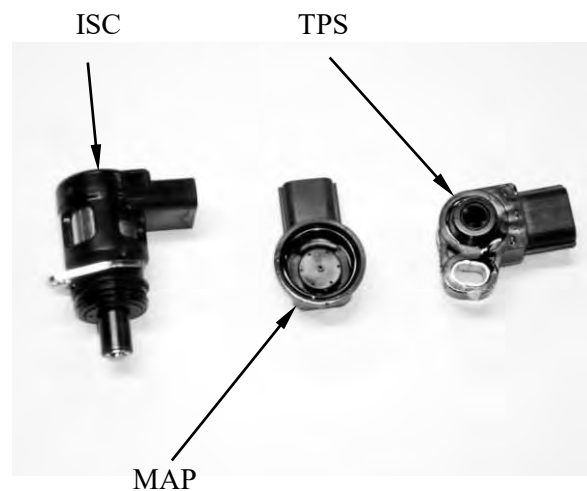
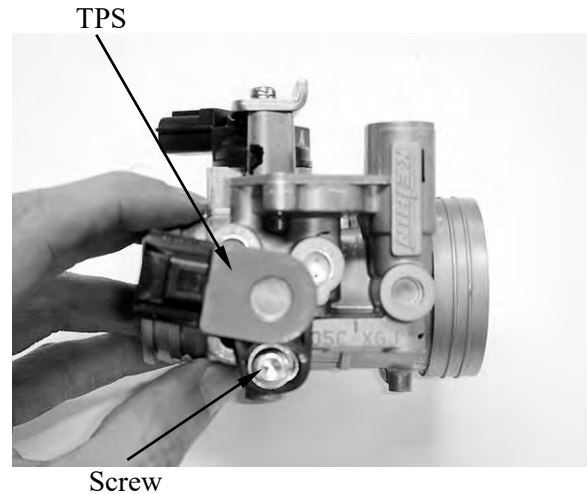

13. FUEL INJECTION SYSTEM

Apply oil onto a new O-ring.

When install the MAP onto the throttle body, being careful not to damage the O-ring.

* Always replace an O-ring with a new one.

Install the set plate and tighten the screw securely.

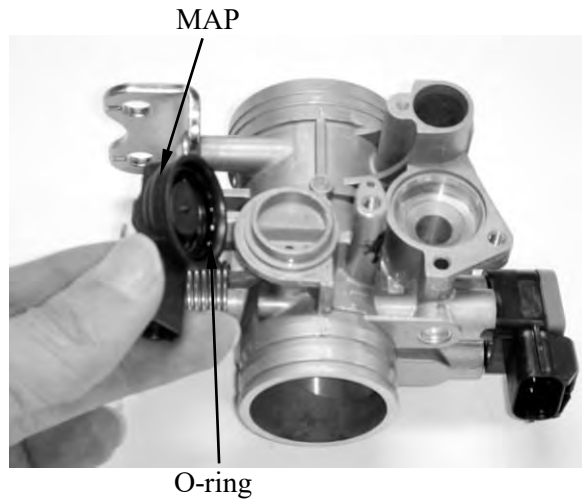

Apply oil onto a new O-ring.

When install the ISC and set plate onto the throttle body, being careful not to damage the O-ring.

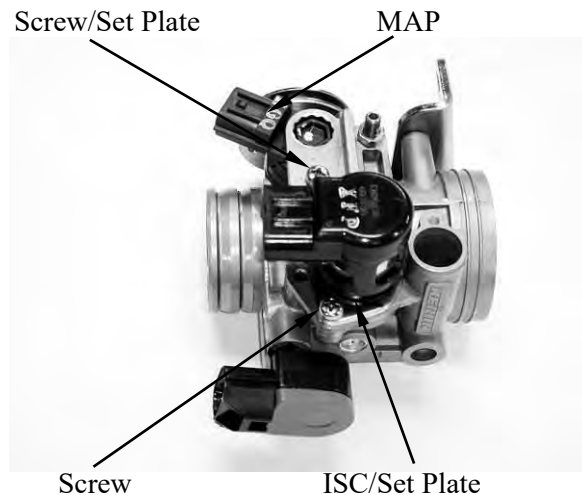

DIAGNOSTIC TOOL CONNECTOR

INSPECTION

Put the side stand up and engine stop switch is at "RUN".

Turn the ignition switch to "ON"

Measure the voltage between the following terminals of the diagnostic tool connector with PDA tester.

Terminal	Normal
Black (+) – Green (-)	Battery voltage
White/Yellow (+) – Green (-)	Battery voltage – 1 V

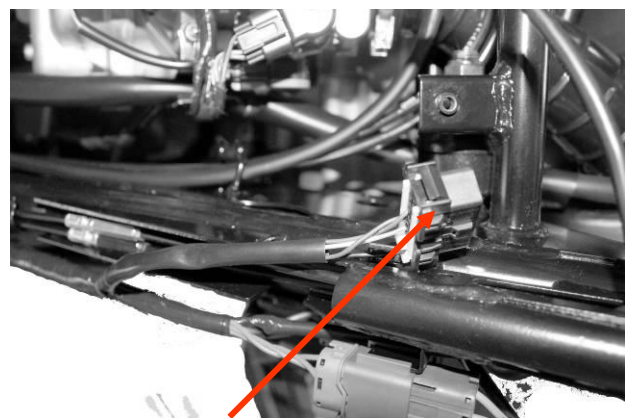

Diagnostic Connector



FI DIAGNOSTIC TOOL OPERATION INSTRUCTIONS 3620A-LEB2-E00

Note: For EURO models

Use the Sub cord, OBD diagnostics connector (part number:36205-LFA7-E00) to connect between vehicle and diagnostic tool.



To: Vehicle

To Diagnostic tool

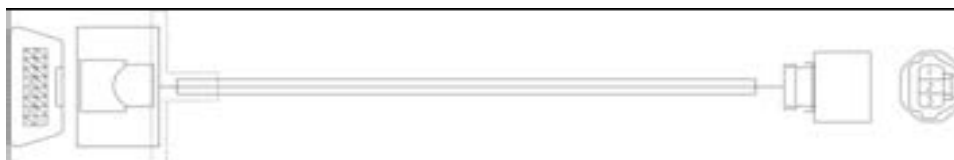

FI DIAGNOSTIC TOOL

- This tool is developed by KYMCO and for KYMCO vehicle only.
- Please refer to the specification when serving this vehicle.
- This tool is without battery inside. The power is provided from vehicle.
- This software can be updated with computer for new model through the USB cable. The power required of tool is connected with 12V battery.
- For connection, please connect this tool with the connector of ECU. It's available when turning on the ignition switch.
- The side stand must be upward when serving the diagnostic procedure.
- The function includes ECU version, model name, data analysis and reset.
 - ECU version: includes model name, ECU number, identifications number and software version.
 - Failure codes: DTC reading, DTC clearing and troubleshooting.
 - Data analysis: For ECU's software inspection.
 - Reset: For the setting function adjustment.

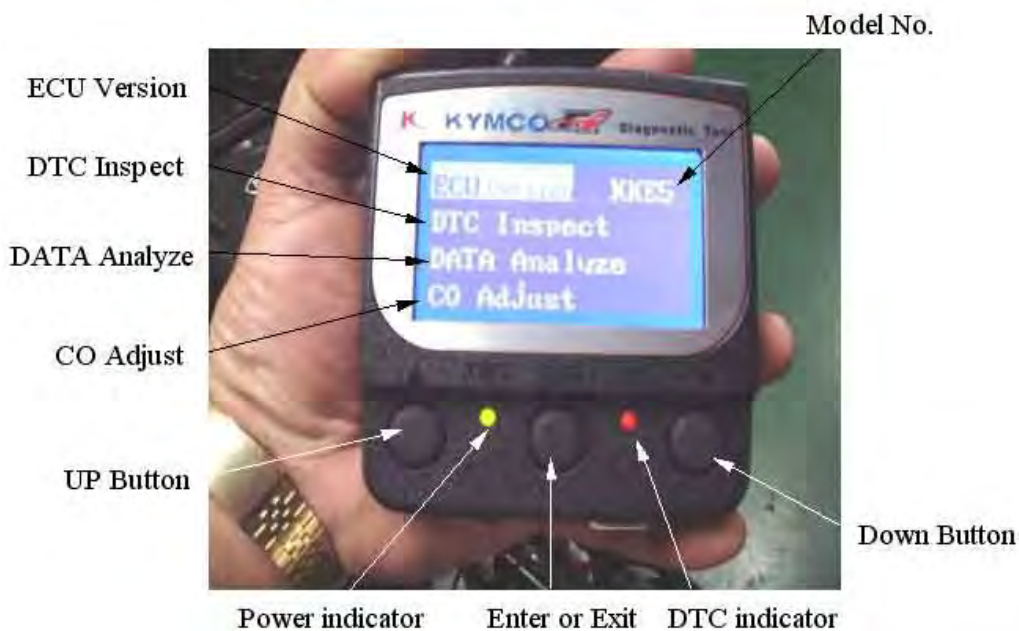

13. FUEL INJECTION SYSTEM

DTC INSPECTION PROCEDURE

Showing four functions on the screen when switching on power.



ABD2 is for
X-Town300 ABS

- A). ECU version: Including of model name, ECU number, identifications number and software version.

Press the " Enter " button

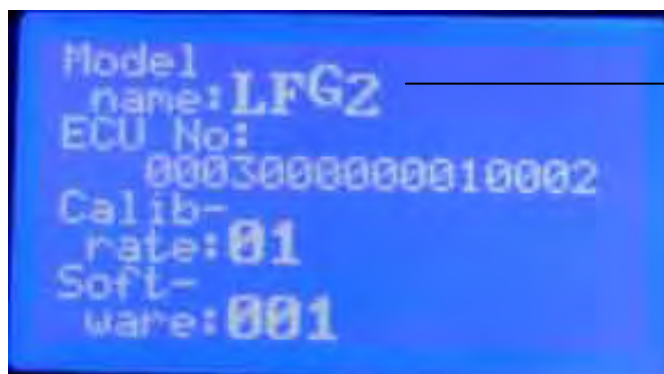

ABD2 is for
X-Town300 ABS

B). Press the " Down " button and then turn to the first page.



ABD2 is for
X-Town300 ABS

C). Press the " Enter " button to check the DTC failure code



ABD2 is for
X-Town300 ABS

13. FUEL INJECTION SYSTEM

D). Press the " Enter " button

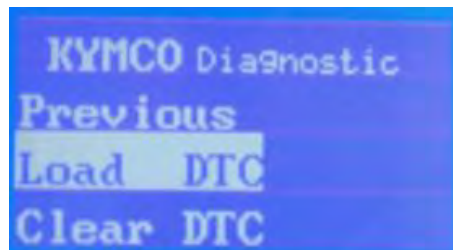

E). Press the " Enter " button

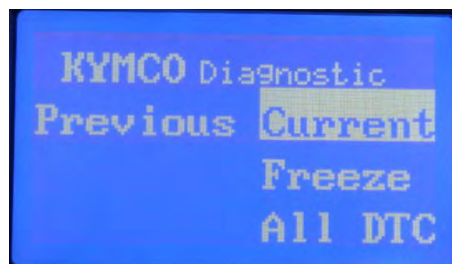

F). Display what's DTC number on this DTC-List.

Press the " Enter " button and then turn to the previous page

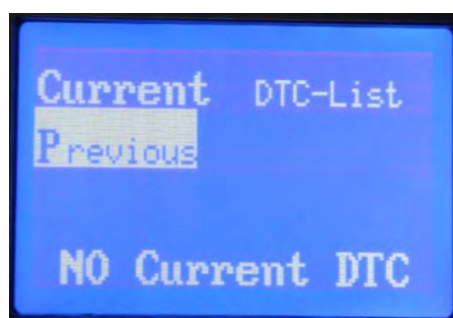

13. FUEL INJECTION SYSTEM

G). Press the " UP " button

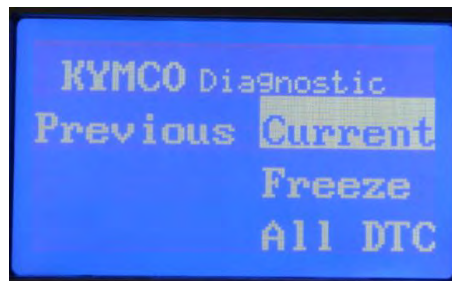

H). Press the " Enter " button and then turn to the previous page with red color.

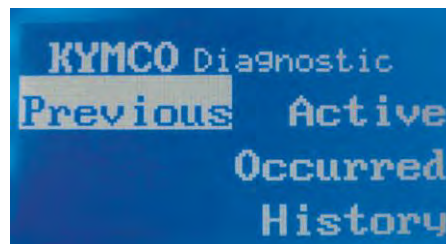

I). Press the " UP " button

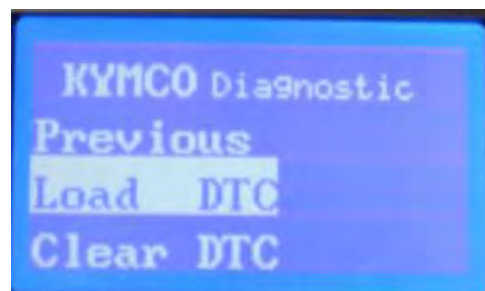

13. FUEL INJECTION SYSTEM

J). Press the " Enter " button and then turn to the first page.



ABD2 is for
X-Town300ABS



ABD2 is for
X-Town300ABS

13. FUEL INJECTION SYSTEM

三. DTC CLEAR PROCEDURE

A). Check the DTC



ABD2 is for
X-Town300ABS

B). Press the " Enter " button



ABD2 is for
X-Town300ABS

C). Choose " Load DTC "
Press the " Down " button

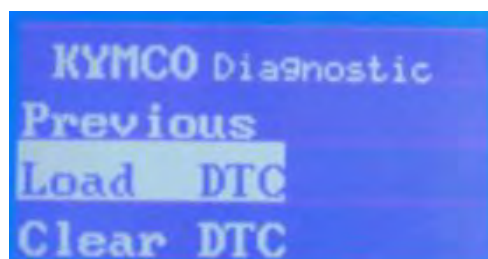

13. FUEL INJECTION SYSTEM

D). Press the " Enter " button and the indicator is lighting.

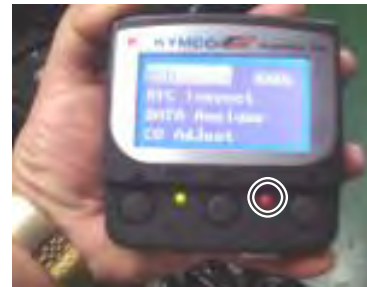
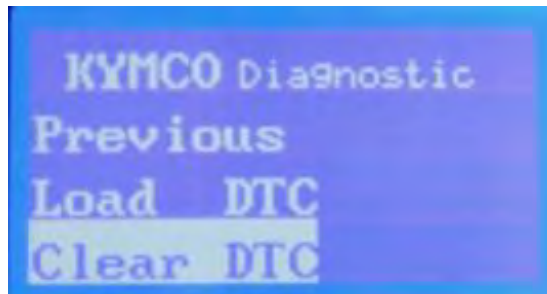

E). Clearing DTC completed if the indicator is off.

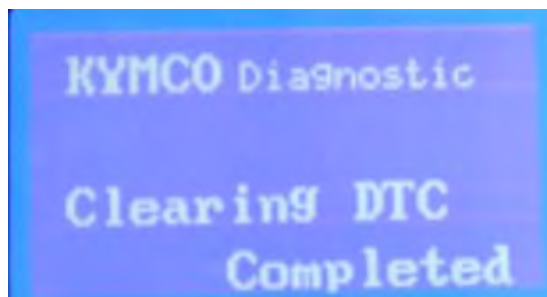

13. FUEL INJECTION SYSTEM

四. DATA ANALYSIS PROCEDURE

A). Press the " Down " twice



ABD2 is for
X-Town300ABS

B). Choose " Data Analyze"

Press the " Enter " button to enter page 01

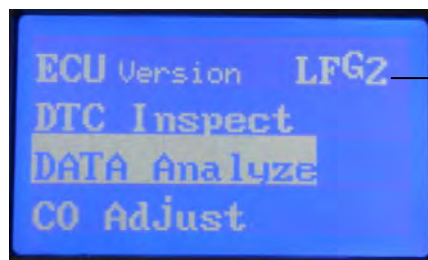

ABD2 is for
X-Town300ABS

C). Down-page 01

The measure figures including of Engine speed, Battery voltage and DTC number.

Press the " Down " button to enter page 02.

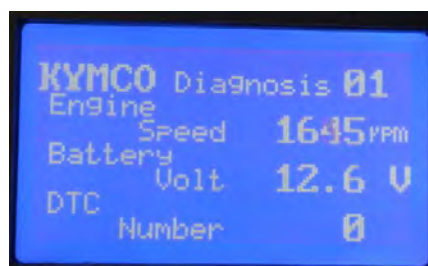

13. FUEL INJECTION SYSTEM

D). Down-page 02

The measure figures including of TPS position, Intake pressure and Intake air temperature.

Press the “ Down” button to enter page 03.

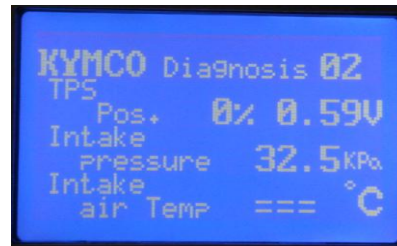

E). Down-page 03

The measure figures including of Atmosphere pressure, Fuel Injector interval and Ignition advance timing.

Press the “ Down” button to enter page 04.

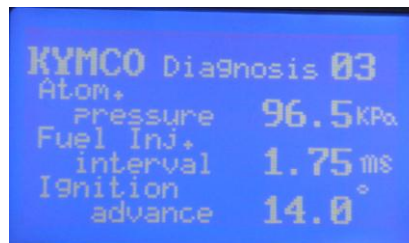

F). Down-page 04

The measure figures including of Engine temperature, O2 sensor voltage and O2 heater activation.

Press the “ Down” button to enter page 05.



13. FUEL INJECTION SYSTEM

G). Down-page 05

The measure figures including of ISC target, ISC step and ISC learn step.

Press the " Down " button to enter page 06.



H). Down-page 06

The measure figures including of ISC motor state.

Press the " Down " button to enter page 07.



I). Down-page 07

The measure figures including of Cut Out voltage.

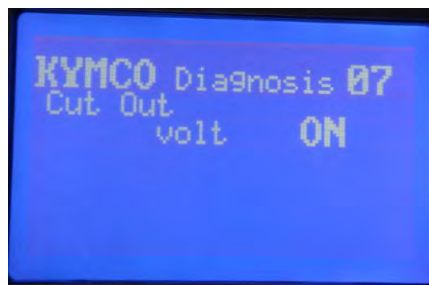

J). Press the " UP " to the previous page.

13. FUEL INJECTION SYSTEM

Vehicle can not be started – Handling method (Steps)

Preliminary Checking: 6 basic inspection

1. Is the battery with voltage (12 V or higher)
2. Key-On and listen for any action with Fuel Pump / Fuel Pump Relay (It will turn off automatically in 5-10 seconds)
3. Key-On to check for any failure lamp light up on dashboard.
4. Is the Idle screw of Throttle Valve being changed or loose?
5. Has the vehicle under regular service? Is the gas station a good one?
6. Is the spark plug the correct model of specified by the vehicle builder?

Vehicle can not be started?

Check for any Failure code. (Failure Lamp on / How to tell the Failure code?)

Turn on power to see if the engine inspection / failure lamp off?

If it flashes continuously or light up for long time, the vehicle is at failure -> read the Failure Code?

Methods:

1. Reading DTC from speedometer, if diagnosis tool is not available.
2. Reading DTC from Diagnosis tool, if it is available.

13. FUEL INJECTION SYSTEM

Manual Trouble Shooting Procedure

How to read DTC from speedometer?

New Phase 5 Fuel Injection Engine Vehicle DTC Reading:

Automatic indication – ECU upgrade version (with Oxygen sensor):
Reading DTC from speedometer directly.

Key On → light off in 2 seconds. When the engine inspection lamp is light up again, it starts to deliver failure code. If no show, there is without any failure.

Note:

1. The “CELP” denotes the failure codes. When the indicator lights for 1 second it is equivalent 10 blinks. For example, a 1 second illumination and two blinks (0.5 second x 2) of the indicator equals 12 blinks. Refer to DTC 12.
2. If more than one failure occurs, the “CELP” shows the blinks in the occurred order. For example, if the indicator blinks 6 times, then shows one second illumination and two blinks, two failures have occurred. Refer to DTC 6 and DTC 12.

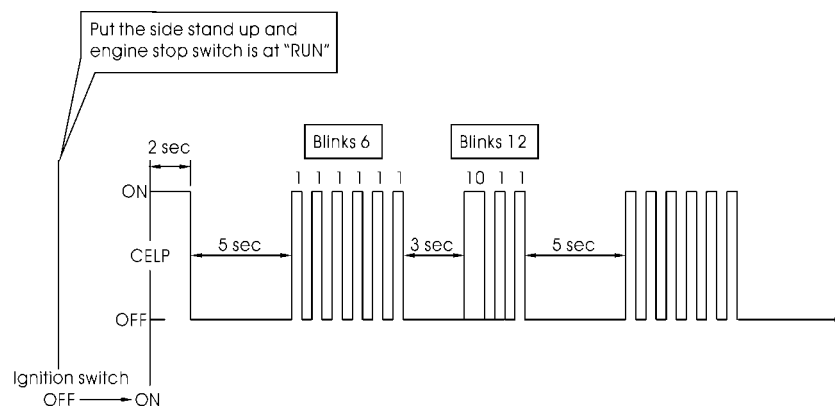

After excluding trouble, how the DTC can be cleared? Confirm the failure is excluded.

- Turn on power but maintain not started and keep the engine inspection lamp light up for 4 cycles. If it is off automatically, it means the historical DTC is cleared automatically.
- Use diagnosis tool: clear Historical Failure code
- Check again to confirm DTC is excluded.
Turn on power again. When there is no residual historical failure cod. Start the engine and if no failure lamp is on or flashing, it is Okay.

**HANDLEBAR/FRONT WHEEL/FRONT BRAKE/
FRONT SHOCK ABSORBER/STEERING STEM**

SERVICE INFORMATION-----	14- 1
TROUBLESHOOTING-----	14- 2
HANDLEBAR -----	14- 3
FRONT WHEEL -----	14- 6
FRONT BRAKE FLUID-----	14- 9
FRONT BRAKE PAD -----	14-12
BRAKE DISC INSPECTION -----	14-13
FRONT SHOCK ABSORBER-----	14-14
STEERING STEM-----	14-15

SERVICE INFORMATION

GENERAL INSTRUCTIONS

- Remove the motorcycle frame covers before removing the front wheel, steering handlebar, front shock absorber and front fork. Jack the motorcycle front wheel off the ground and be careful to prevent the motorcycle from falling down.
- During servicing, keep oil or grease off the brake pads and brake disk.

SPECIFICATIONS

Unit: mm (in)

Item	Standard	Service Limit
Axle shaft runout	—	0.2 mm (0.008 in)
Brake disk thickness	3.8 ~ 4.2 (0.15 ~ 0.165)	0.3 mm (0.012 in)
Brake disk runout	—	—
Brake master cylinder I.D.	12.7 ~ 12.74 (0.508 ~ 0.5096)	—
Brake master cylinder piston O.D.	12.65 ~ 12.68 (0.506 ~ 0.5072)	—
Brake caliper piston O.D.	26.93 ~ 26.96 (1.0602 ~ 1.0614)	—
Brake caliper cylinder I.D.	27 ~ 27.05 (1.063 ~ 1.065)	—

TORQUE VALUES

Handlebar lock nut	45 N-m (4.5 kgf-m)
Steering stem lock nut	70 N-m (7.0kgf-m)
Steering stem pinch bolt	27 N-m (2.7 kgf-m)
Front axle	20 N-m (2.0 kgf-m,)
Master cylinder reservoir cover screw	1.6N-m (0.16 kgf-m)
Master cylinder holder bolt	12 N-m (1.2 kgf-m)
Brake lever pivot bolt	2.0 N-m (0.2 kgf-m)
Brake lever pivot nut	10.0 N-m (1.0 kgf-m)
Brake light switch screw	1.0 N-m (0.1 kgf-m)
Brake caliper mounting bolt	35 N-m (3.5 kgf-m)
	ALOC bolt: replace with a new one.
Brake caliper bleed screw	5.5N-m (0.55 kgf-m)
Brake hose oil bolt	35 N-m (3.5 kgf-m)

SPECIAL TOOLS

Lock nut wrench	F00002
Oil seal and bearing installer	E00014
Bearing puller	E00037
Lock nut wrench	F00023
Ball cone remover	F00009
Ball cone installer	F00019

TROUBLESHOOTING

Hard steering (heavy)

- Excessively tightened steering stem top cone race
- Broken steering balls
- Insufficient tire pressure

Steers to one side or does not track straight

- Uneven front shock absorbers
- Bent front fork
- Bent front axle or uneven tire

Poor brake performance

- Worn brake pads
- Contaminated brake pad surface
- Deformed brake disk
- Air in brake system
- Deteriorated brake fluid
- Worn brake master cylinder piston oil seal
- Clogged brake fluid line
- Unevenly worn brake caliper

Front wheel wobbling

- Bent rim
- Loose front axle
- Bent spoke plate
- Faulty tire
- Improperly tightened axle nut

Soft front shock absorber

- Weak shock springs
- Insufficient damper oil

Front shock absorber noise

- Slider bending
- Loose fork fasteners
- Lack of lubrication

HANDLEBAR

REMOVAL

Remove the lower handlebar cover and front cover.

Remove two bolts and disconnect the brake light switch wire, then remove the rear brake master cylinder.

Remove the two bolts and disconnect the brake light switch wire, then remove the front brake master cylinder.

Remove the inner cover.

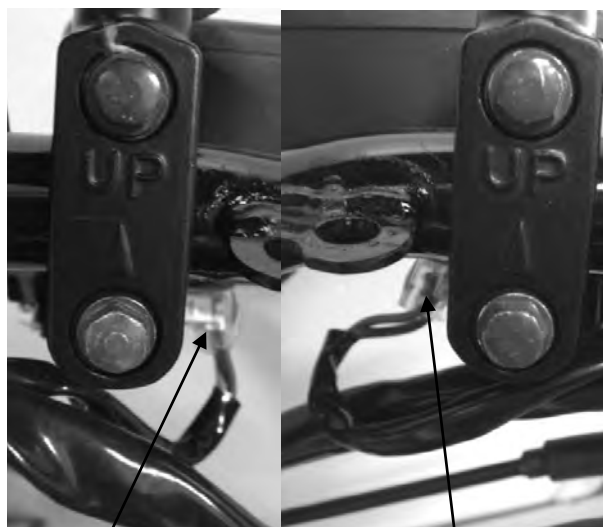

Brake Light
Switch Wire

Front Light
Switch Wire

Remove the handlebar lock nut and take out the bolt.

Remove the handlebar and collar.

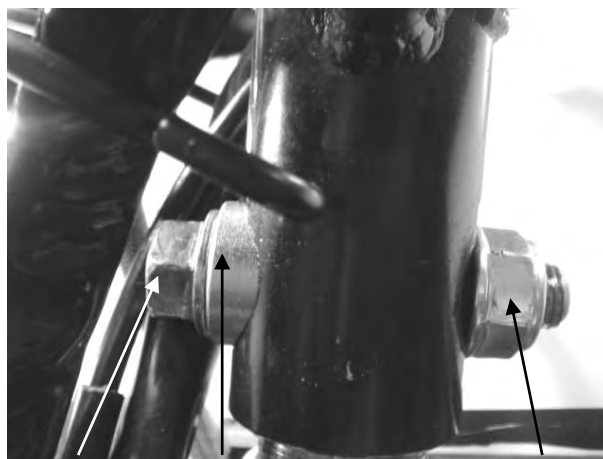

Bolt

Collar

Lock nut

INSTALLATION

Install the handlebar onto the steering stem and install the handlebar collar, lock nut and bolt.

Tighten the bolt to the specified torque.

Torque: 4.5 kgf-m (45 N-m, 32 lbf-ft)



14. HANDLEBAR/FRONT WHEEL/FRONT BRAKE/ FRONT SHOCK ABSORBER/STEERING STEM

Install the front and rear master cylinders and connect the brake light switch wires.



DISASSEMBLY

Remove two screws attaching to the right handlebar switch.



Screws

Disconnect the throttle cable from the throttle grip.
Remove the right handlebar switch.

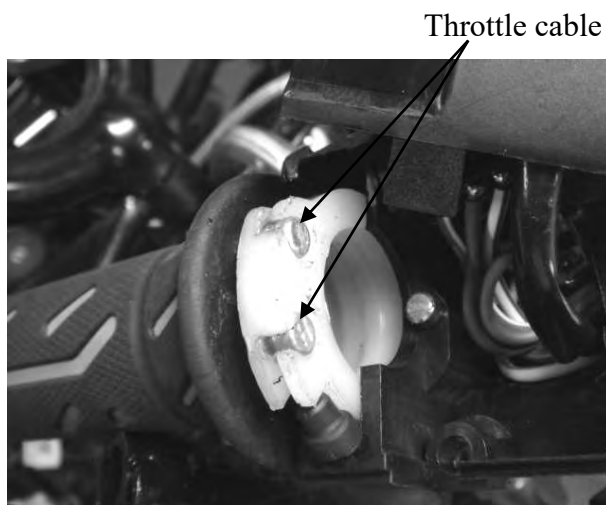

Remove two screws and then remove the left handlebar switch.



Screws

ASSEMBLY

Install the left handlebar switch.

* Align the pin on the left handlebar switch with the hole on the handlebar.

Install and tighten the two screws securely.

Install the right handlebar switch.

* Align the pin on the right handlebar switch with the hole on the handlebar.

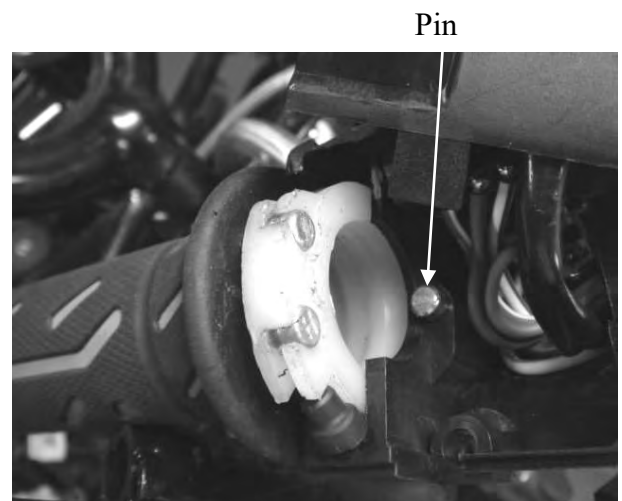

Pin

Lubricate the throttle grip front end with grease and then connect the throttle cable to the throttle grip.

Install and tighten the two screws.

FRONT WHEEL

REMOVAL

The scooter front wheel off the ground.
Remove the bolt and then pull out the axle.
Remove the front wheel and collar.

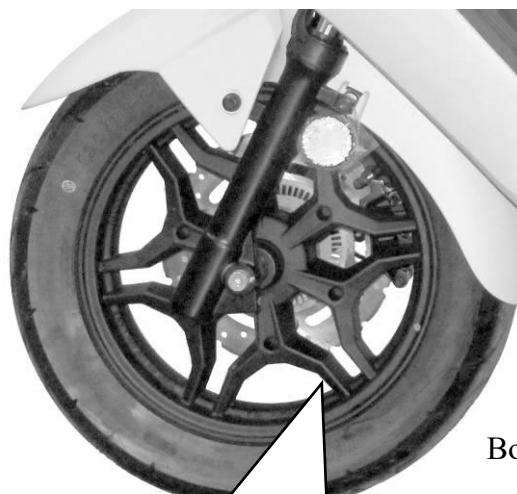

Bolt



AXLE RUNOUT INSPECTION

Set the axle in V blocks and measure the runout using a dial gauge.

The actual runout is 1/2 of the total indicator reading.

Service Limit: 0.2 mm (0.008 in)

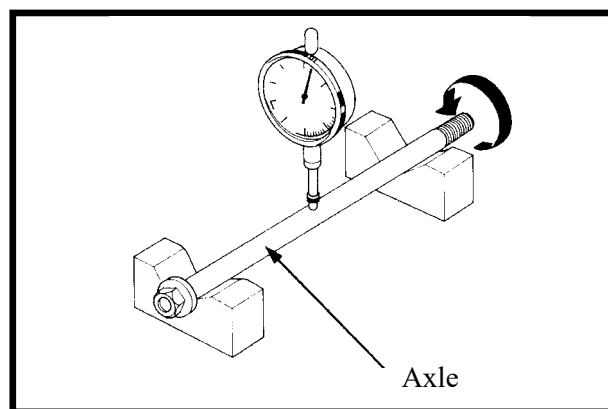

WHEEL RIM INSPECTION

Check the wheel rim runout.

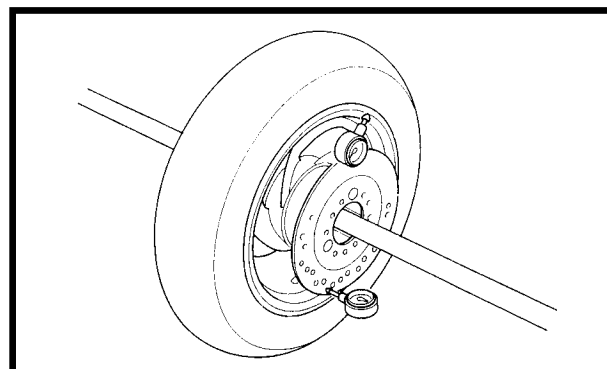

INSTALLATION

Apply grease to the collar, then install the collar onto the wheel.

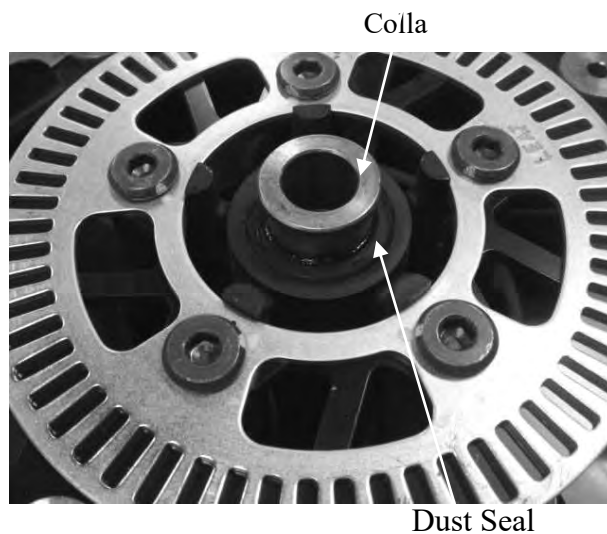

Install the speedometer speed wheel sensor.

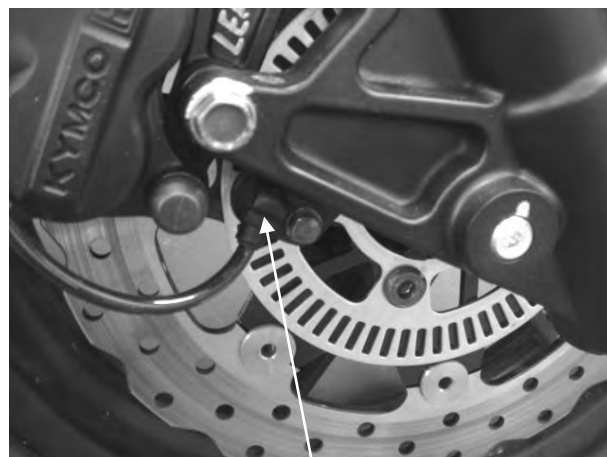

DISASSEMBLY

Remove the side collar and dust seal.

Turn the inner race of each bearing with your finger to see if they turn smoothly and quietly. Also check if the outer race fits tightly in the hub.

Replace the bearings if the races do not turn smoothly, quietly, or if they fit loosely in the hub.

Remove the front wheel bearing by using the special tool.

Special tool:

Bearing puller E00037

Remove the distance collar from wheel.

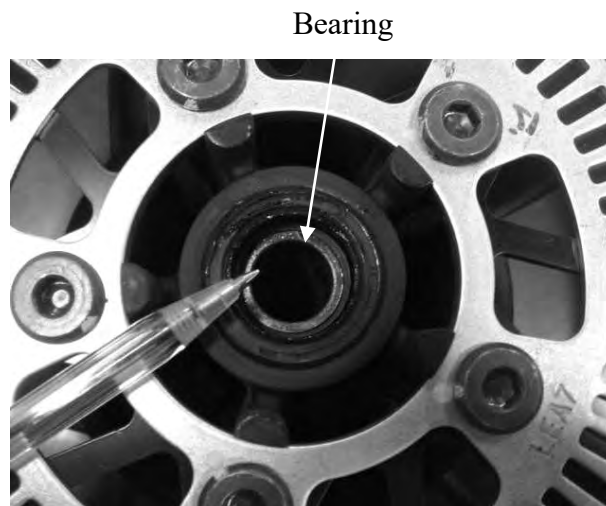

14.HANDLEBAR/FRONT WHEEL/FRONTBRAKE/ FRONT SHOCK ABSORBER/STEERING STEM

Remove the front wheel bearing by using the special tool.

Special tool:

Bearing puller E00037

ASSEMBLY

Install the front wheel bearing by using the special tool.

Special tool:

Bearing installer E00014

Install the distance collar.

Install the front wheel bearing by using the special tool.

Apply grease to the collar, then install the collar onto the wheel.

Bearing

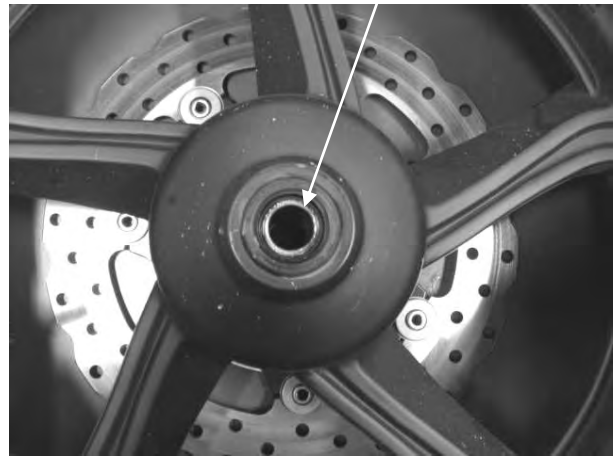

FRONT BRAKE FLUID

FLUID REPLACEMENT/AIR BLEEDING

- * —————
- A contaminated brake disc or pad reduces stopping power. Discard contaminated pads and clean a contaminated disc with a high quality brake degreasing agent.
 - Do not allow foreign material to enter the system when filling the reservoir.
 - Avoid spilling brake fluid on painted, plastic or rubber parts. Place a rag over these parts whenever the system is serviced.



BRAKE FLUID DRAINING

Make sure that the master cylinder parallel to the ground before removing the reservoir cover.

Remove two screws.

Remove the reservoir cover, diaphragm plate and diaphragm.

Connect a bleed hose to the bleed valve.



Loosen the bleed valve and apply the brake lever.

Stop operating the brake when no more fluid flows out of the bleed valve.

BRAKE FLUID FILLING/AIR BLEEDING

* Do not mix different types of fluid since they are not compatible.

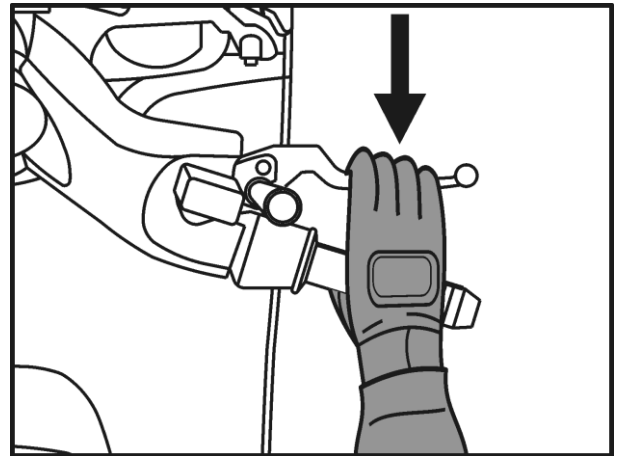

Fill the master cylinder with DOT 4 to the upper level.

Connect a commercially available brake bleeder to the front caliper bleed valve.

Check the fluid level often while bleeding the brake to prevent air from being pumped into the system.

Pump the brake bleeder and loosen the front caliper bleed valve. Add fluid when the fluid level in the master cylinder is low to prevent drawing air into the system.

Repeat the above procedures until no air bubbles appear in the plastic hose.

Close the front caliper bleeding valve and operate the front brake lever.

If it's still spongy, bleeding the system again.

If the brake bleeder is not available, perform the following procedure.

Pump up the system pressure with the brake lever until there are no air bubbles in the fluid flowing out of the reservoir small hole and lever resistance is felt.

1. Pump the brake lever several times, then squeeze the brake lever all the way and loosen the bleed valve 1/4 turn. Wait several seconds and close the bleed valve.

* Do not release the brake lever until the bleed valve has been closed.

2. Release the brake lever slowly until the bleed valve has been closed. Add fluid when the fluid level in the master cylinder is low to prevent drawing air into the system.
3. Repeat the steps 1 - 2 until there are no air bubbles in the bleed hose.

After bleeding air completely, tighten the bleed valve to the specified torque.

Torque: 6 N-m (0.6 kgf-m, 4.3 lbf-ft)

Fill the reservoir to the casting ledge with DOT 4 to the upper level.

Install the diaphragm, set plate and reservoir cover and tighten the screws to the specified torque.

Torque: 2 N-m (0.2 kgf-m, 1.1 lbf-ft)

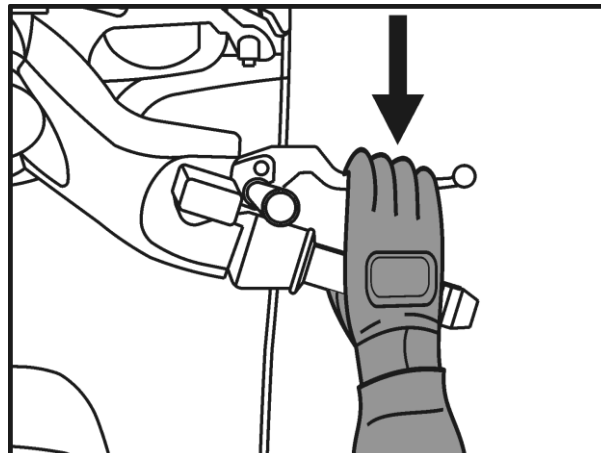

FRONT BRAKE PAD

BRAKE PAD REPLACEMENT

Remove the two caliper mounting bolts, then remove the caliper.



Bolts

Brake Pads

Remove the brake pads.



* Always replace the brake pads in pairs to ensure even disc pressure.



Install new pads so that their ends rest on the pad retainer on the brake properly.



Install the pad pin by pushing the pads against the pad spring to align the pad pin holes in the pads and caliper.

Install the front caliper onto the fork leg and then install and tighten the new two caliper mounting bolts to the specified torque.

Torque: 35 N-m (3.5 kgf-m)

Tighten the pad pins to the specified torque.

Torque: 18 N-m (1.8 kgf-m, 13 lbf-ft)



BRAKE DISC INSPECTION

Visually inspect the brake disc for damage or cracks.

Measure the brake disc thickness.

Service limits: 3 mm (0.12 in)

Replace the brake disc if the smallest measurement is less than the service limit.

Measure the brake disc warpage.

Service limits: 0.3 mm (0.012 in)



FRONT SHOCK ABSORBER

REMOVAL

Remove the front cover and front fender.
Remove the front brake caliper
Remove the front wheel
Remove the speed wheel sensor bolt and then remove the brake hose guide from right front shock absorber.
Remove the speedometer cable guide from left front shock absorber.
Remove two mounting bolts and then remove the right/left front shock absorber.



Speed Wheel Sensor

INSTALLATION

Installation is in the reverse order of removal.

* Tighten the shock absorber mounting bolt to the specified torque.

Torque: 2.7 kgf-m (27 N-m, 19.5 lbf-ft)

Specified Oil: SS#8
Oil Capacity: 185 cc

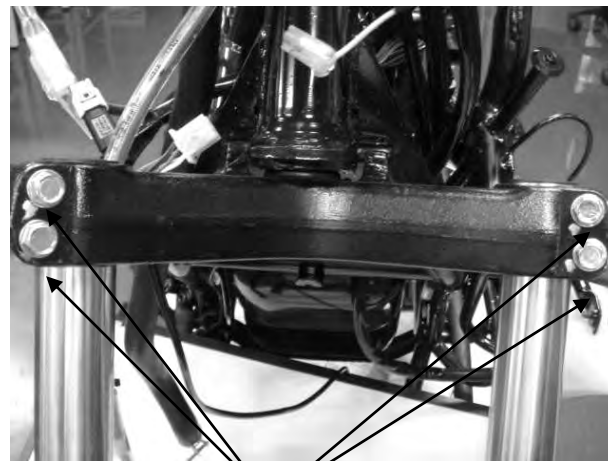

Mounting Bolts

INSPECTION

Inspect the following items and replace if necessary.

- Front shock absorber tube bending, damage or wear
- Weak front shock absorber spring
- Damper and damper rod bending
- Oil seal damage or wear



STEERING STEM

REMOVAL

Remove the steering handlebar.
Remove the front brake hose and speed wheel sensor connector from the guide.



Hold the steering stem top cone race and

remove the steering stem lock nut by using the special tool.

Special tool:

Lock nut wrench F00002



Lock Nut Wrench



Top Cone Race



Remove the top cone race and washer.
Remove the steering stem.

* Be careful not to lose the steel balls (26 on top race and 19 on bottom race).

Special tool:

Lock nut wrench F00023

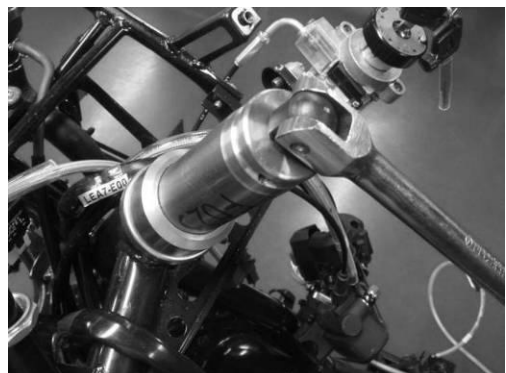

14. HANDLEBAR/FRONT WHEEL/FRONT BRAKE/ FRONT SHOCK ABSORBER/STEERING STEM

Inspect the ball races, cone races and steel balls for wear or damage. Replace if necessary.

Remove the top balls.

Remove the upper ball race by using a chisel if necessary.

Ball



Top Ball Cone Race

Remove the bottom balls.

Remove the bottom ball race by using a pipe if necessary.

Bottom Ball Race

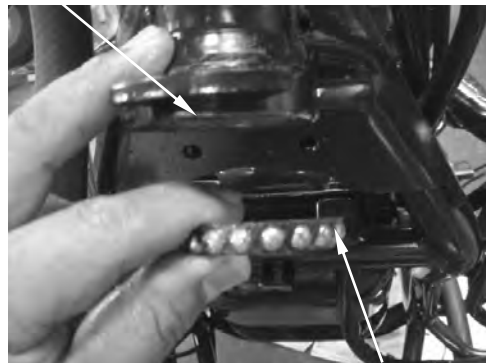

Bottom Balls

Remove the bottom cone race by using a chisel if necessary.

* Be careful not to damage the steering stem.

Bottom Cone Race



INSTALLATION

Install the new bottom cone race onto the steering stem.

Install the new upper and bottom ball races into the frame.

Apply grease to the top and bottom ball races and install new steel balls on the top ball race and new steel balls on the bottom ball race.

Install the steering stem.



Apply grease to the top cone race and install it.

Tighten the top cone race and then turn the steering stem right and left several times to make steel balls contact each other closely.

*

Check the steering stem rotates freely without vertical play.



Special tool:

Lock nut wrench F00023

Install the steering stem lock nut and tighten it to the specified torque by using the special tool while holding the top cone race.

Torque: 7 kgf-m (70 N-m)

Special tool:

Lock nut wrench F00002



15. REAR BRAKE/REAR FORK/REAR WHEEL/REAR SHOCK ABSORBER



X-Town300 ABS

15

REAR BRAKE/REAR FORK/REAR WHEEL/ REAR SHOCK ABSORBER

SCHEMATIC DRAWING	15-1
SERVICE INFORMATION	15-2
TROUBLESHOOTING	15-2
REAR BRAKE	15-3
REAR FORK	15-6
REAR WHEEL	15-7
REAR SHOCK ABSORBER	15-7

15. REAR BRAKE/REAR FORK/REAR WHEEL/REAR SHOCK ABSORBER



X-Town300 ABS

SCHEMATIC DRAWING

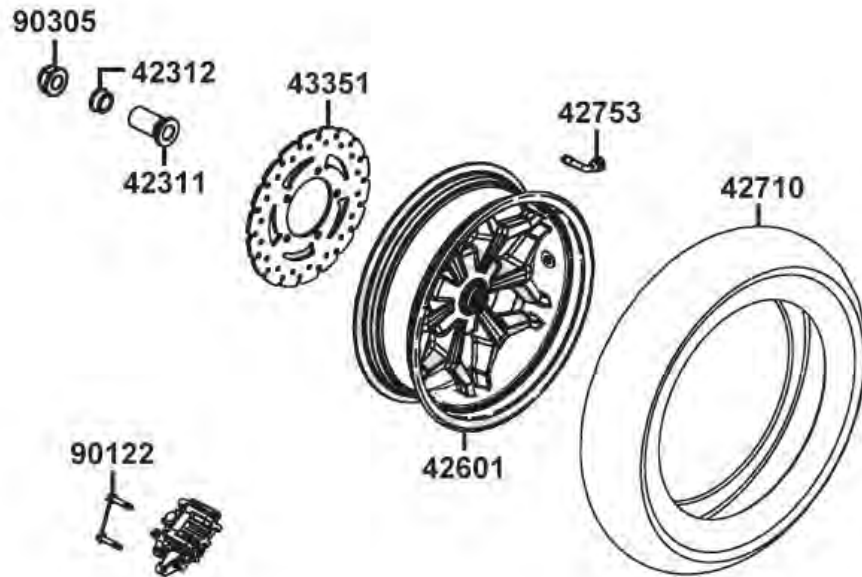
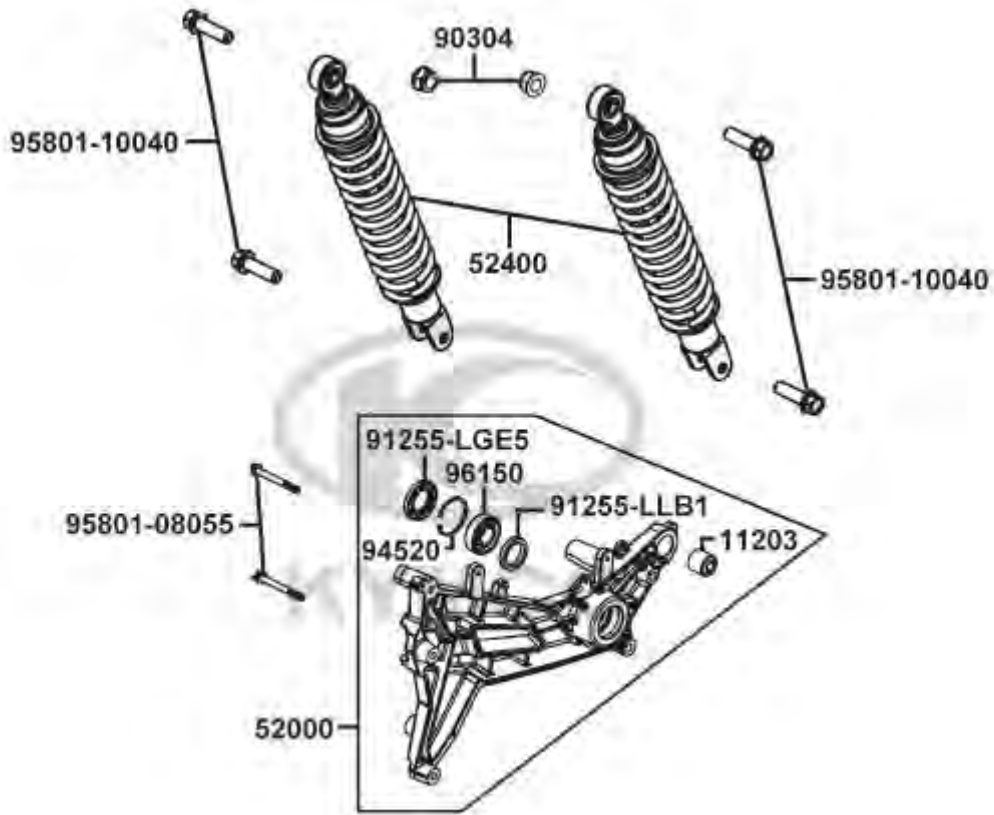

15. REAR BRAKE/REAR FORK/REAR WHEEL/REAR SHOCK ABSORBER



X-Town300 ABS

SERVICE INFORMATION

GENERAL INSTRUCTIONS

- When performing the services stated in this section, the engine and exhaust muffler must be cold to avoid scalding.
- During servicing, keep oil or grease off the brake pads and brake disk.

SPECIFICATIONS

Item	Standard (mm)
Rear wheel rim runout	—
Rear brake disk thickness	5.0
Rear brake disk runout	—
Rear brake master cylinder I.D.	25.33 ~ 25.36
Rear brake master cylinder piston O.D.	25.40 ~ 25.45

TORQUE VALUES

Exhaust muffler lock bolt	35 N-m (4 kgf-m)
Exhaust muffler pipe nut	20 N-m (2 kgf-m)
Rear axle nut	120 N-m (12 kgf-m)
Rear shock absorber lower mount bolt	40 N-m (4 kgf-m)
Rear shock absorber upper mount bolt	40 N-m (4 kgf-m)
Rear brake caliper holder bolt	35 N-m (3.5 kgf-m)

TROUBLESHOOTING

Rear wheel wobbling

- Bent rim
- Faulty tire
- Axle not tightened properly

Soft rear shock absorber

- Weak shock absorber spring
- Damper oil leaks

Rear wheel noise

- Worn rear wheel axle bearings
- Worn rear fork bearings
- Deformed rear fork

Poor brake performance

- Air in brake system
- Deteriorated brake fluid
- Contaminated brake pad surface
- Worn brake pads
- Clogged brake fluid line
- Deformed brake disk
- Unequal worn brake caliper

15. REAR BRAKE/REAR FORK/REAR WHEEL/REAR SHOCK ABSORBER

REAR BRAKE

REAR BRAKE CALIPER REMOVAL

First remove the exhaust muffler.
Remove the rear brake fluid tube bolt and disconnect the brake fluid tube.
Remove two bolts attaching the rear brake caliper.
Remove the rear brake caliper.

* When removing the brake fluid tube, use shop towels to cover plastic parts and coated surfaces to avoid damage.

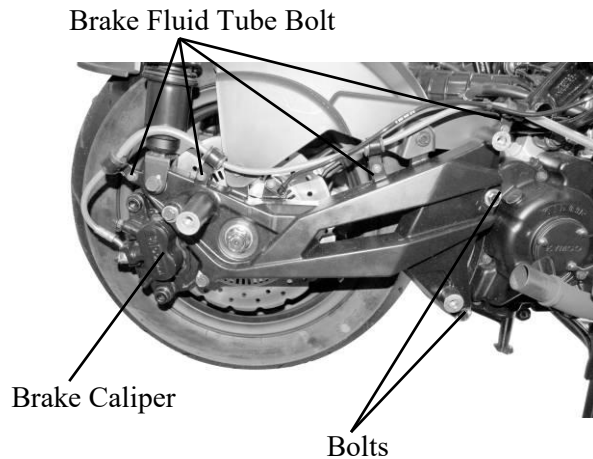

INSPECTION

Inspect the brake pads and brake disk.
Measure the brake disk thickness.
Visually check the brake pad thickness .



Brake Disk

DISASSEMBLY

Remove two brake pads dowel pins and three bolts from the brake caliper.
Remove the brake pads.

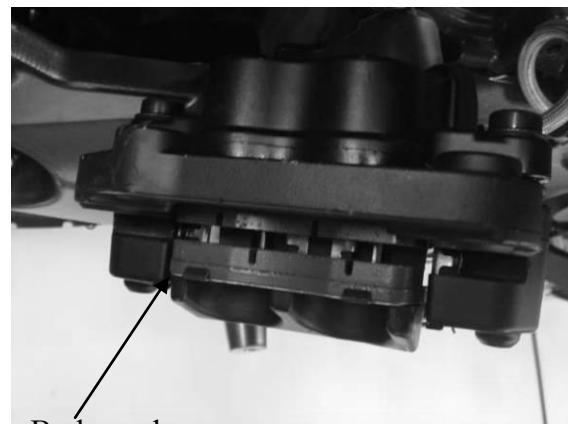

Brake pads

15. REAR WHEEL/REAR BRAKE/ REAR SUSPENSION

Remove the piston from the brake caliper.
If necessary, use compressed air to squeeze out the piston through the brake fluid inlet opening and place a towel under the caliper to avoid contamination caused by the removed piston.
Check the piston cylinder for scratches or wear and replace if necessary.

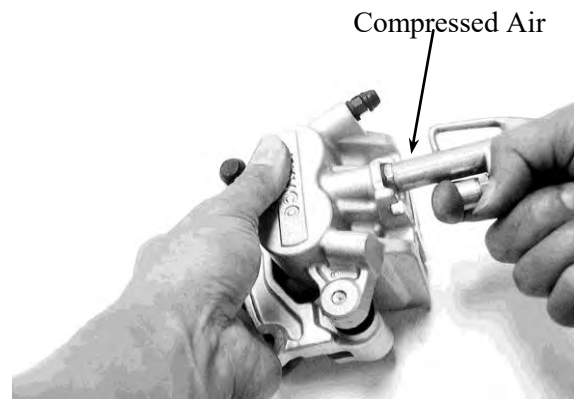

Check the caliper cylinder for scratches or wear and measure the cylinder bore.



ASSEMBLY

Install the two spring plates onto the groove of the caliper.



15. REAR WHEEL/REAR BRAKE/ REAR SUSPENSION

* Make sure the spring plate next to the brake pad dowel pin orientation.

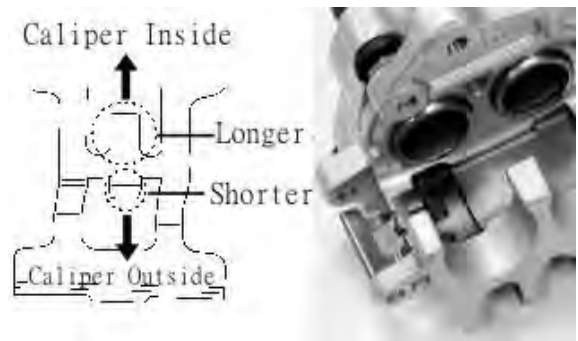

Install two brake pads.

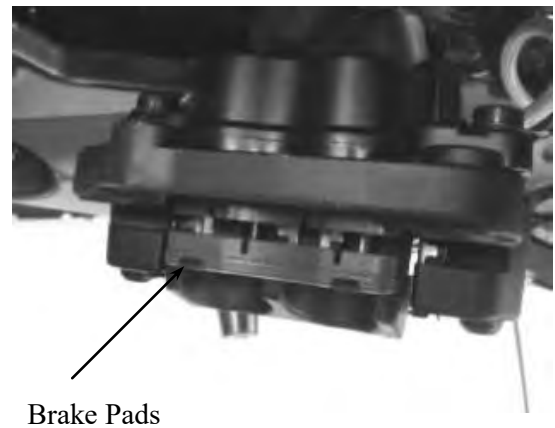

INSTALLATION

Install the brake caliper to the rear fork and tighten the two bolts.

Torque: 35 N-m (3.5 kgf-m)

Connect the brake fluid tube to the brake caliper and install fluid tube bolt, copper washers and tighten the fluid tube bolt.

Fill the brake reservoir with the specified brake fluid and bleed air from the brake system.

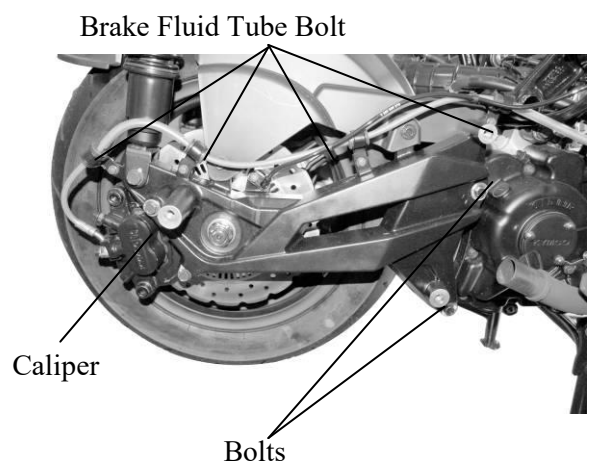

* When installing the brake fluid tube, be sure to install the two copper sealing washers.

15. REAR WHEEL/REAR BRAKE/ REAR SUSPENSION

REAR FORK

REMOVAL

Remove the exhaust muffler.

Remove the rear brake caliper.

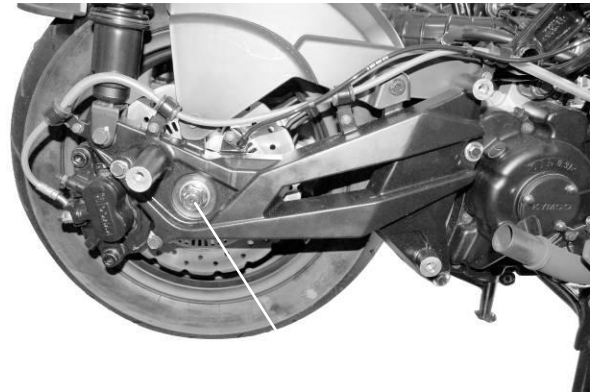

Bear Axle Nut

Remove the right rear shock absorber lower mount bolt.

Remove the rear axle nut and remove the collar.

Remove the rear fork.

The installation sequence is the reverse of removal.

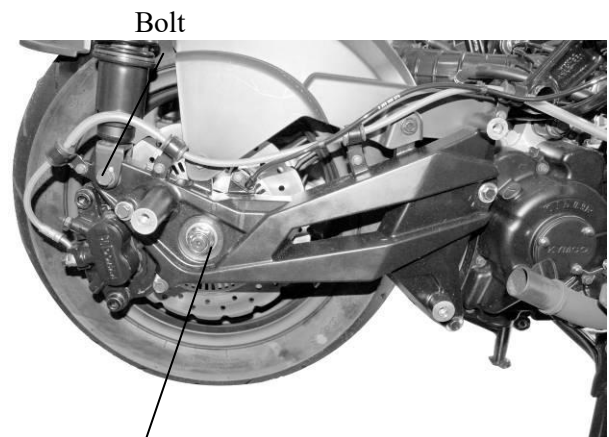

Bolt

Bear Axle Collar

15. REAR WHEEL/REAR BRAKE/ REAR SUSPENSION

REAR WHEEL REMOVAL

- Remove the exhaust muffler.
- Remove the rear brake caliper.
- Remove the rear fork.
- Remove the rear axle collar.
- Remove the rear wheel.



Bear Axle Collar

INSTALLATION

The installation sequence is the reverse of removal.

Torque:

- Rear shock absorber lower mount bolt: 40 N-m (4 kgf-m)
- Rear axle nut 120 N-m (12 kgf-m)

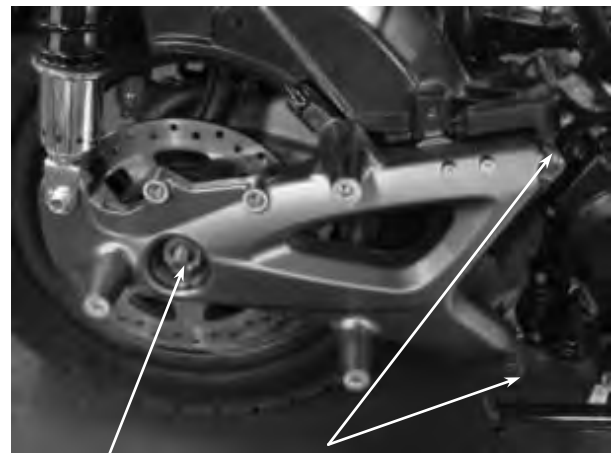

Bear Axle Collar Bolts

REAR SHOCK ABSORBER REMOVAL

- Remove the met-in box and carrier.
- Remove the body cover, center cover and rear fender A together.
- Remove the right/left rear shock absorber upper and lower mount bolts.
- Remove the right and left rear shock absorbers.

INSTALLATION

Install the rear suspension in the reverse order of removal.

Torque:

- Upper Mount Bolt: 40 N-m (4 kgf-m)
- Lower Mount Bolt: 40 N-m (4 kgf-m)



Bolts

15. REAR WHEEL/REAR BRAKE/ REAR SUSPENSION

Suspension

Each shock absorber ⑨ on your scooter has 5 spring preload adjustment positions for different load or riding conditions.

Use a pin spanner ⑩ to adjust the rear shock spring preload. Position 1 is for light loads and smooth road conditions. Position 3 to 5 increase spring preload for a stiffer rear suspension and can be used when the scooter is heavily loaded. Be certain to adjust both shock absorbers to the same spring preload positions.

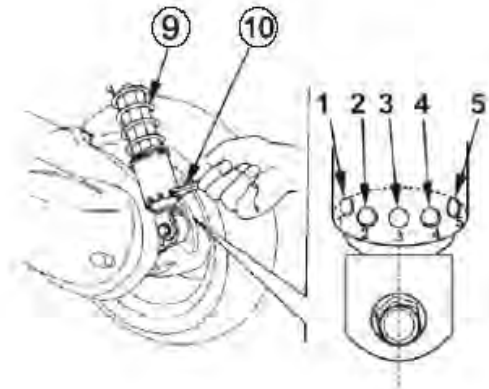

Standard spring preload position: 3

⚠ CAUTION

Always adjust the shock absorber pre-load position in sequence (1-2-3-4-5 or 5-4-3-2-1). Attempting to adjust directly from 1 to 5 or 5 to 1 may damage the shock absorber.

16. BATTERY/CHARGING SYSTEM

16

BATTERY/CHARGING SYSTEM

CHARGING SYSTEM LAYOUT -----	16-1
CHARGING CIRCUIT -----	16-1
SERVICE INFORMATION-----	16-2
TROUBLESHOOTING-----	16-3
BATTERY CHARGING -----	16-4
CHARGING SYSTEM -----	16-6
REGULATOR/RECTIFIER -----	16-6

16. BATTERY/CHARGING SYSTEM

CHARGING SYSTEM LAYOUT

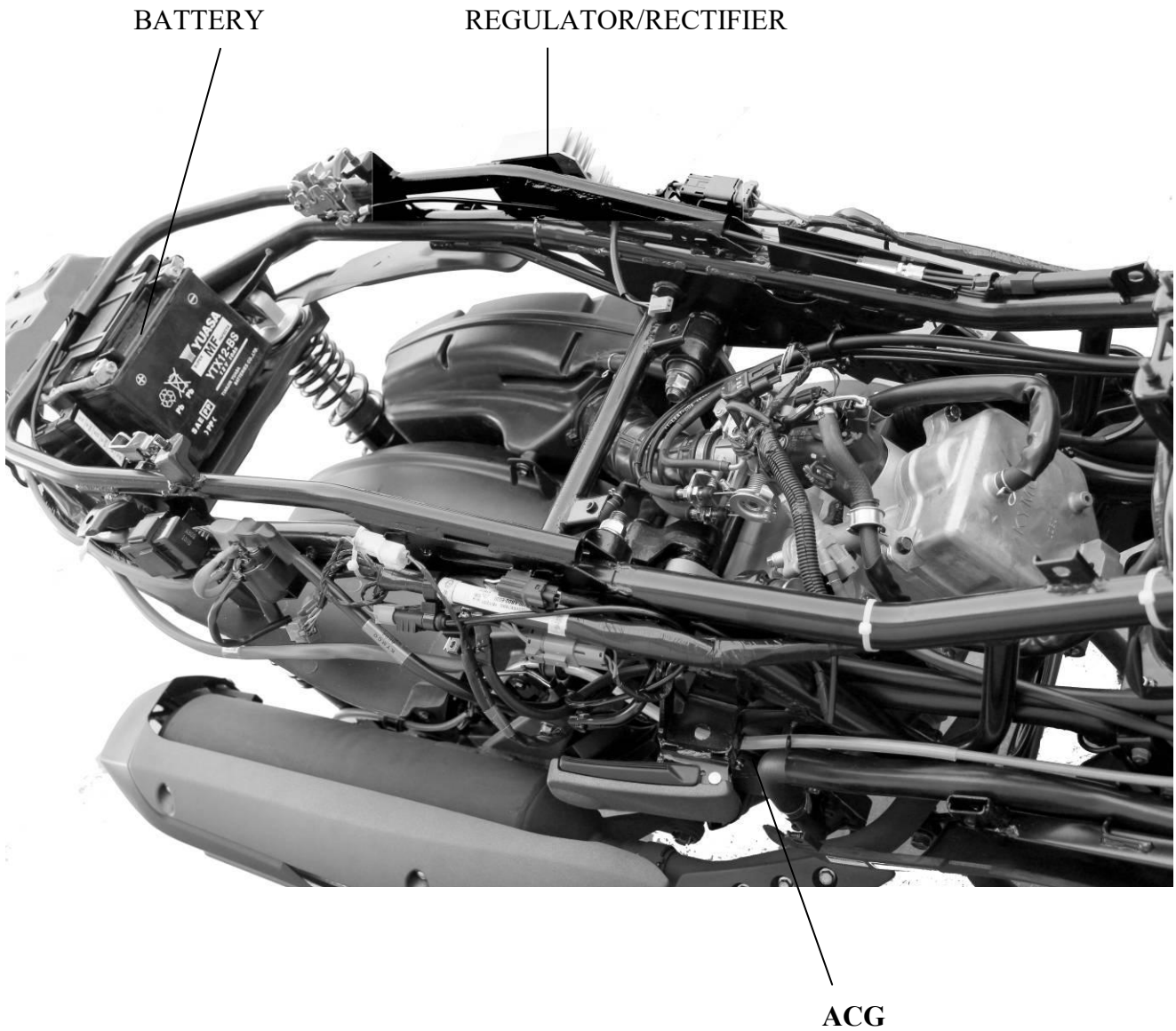

16. BATTERY/CHARGING SYSTEM

SERVICE INFORMATION

GENERAL INSTRUCTIONS

* The battery electrolyte (sulfuric acid) is poisonous and may seriously damage the skin and eyes. Avoid contact with skin, eyes, or clothing. In case of contact, flush with water and get prompt medical attention

- The battery can be charged and discharged repeatedly. If a discharged battery is not used for a long time, its service life will be shortened. Generally, the capacity of a battery will decrease after it is used for 2~3 years. A capacity-decreased battery will resume its voltage after it is recharged but its voltage decreases suddenly and then increases when a load is added.
- When a battery is overcharged, some symptoms can be found. If there is a short circuit inside the battery, no voltage is produced on the battery terminals. If the rectifier won't operate, the voltage will become too high and shorten the battery service life.
- If a battery is not used for a long time, it will discharge by itself and should be recharged every 3 months.
- A new battery filled with electrolyte will generate voltage within a certain time and it should be recharged when the capacity is insufficient. Recharging a new battery will prolong its service life.
- Inspect the charging system according to the sequence specified in the Troubleshooting.
- Do not disconnect and soon reconnect the power of any electrical equipment because the electronic parts in the regulator/rectifier will be damaged. Turn off the ignition switch before operation.
- It is not necessary to check the MF battery electrolyte or fill with distilled water.
- Check the load of the whole charging system.
- Do not quick charge the battery. Quick charging should only be done in an emergency.
- Remove the battery from the motorcycle for charging.
- When replacing the battery, do not use a traditional battery.
- When charging, check the voltage with an electric tester.

SPECIFICATIONS

Item		Standard	
Battery	Capacity	12V12AH	
	Voltage (20°C)	Fully charged	13.2V
		Insufficient charged	< 12.3V
	Charging current	1.2A* 5~10H	

16. BATTERY/CHARGING SYSTEM

TROUBLESHOOTING

No power

- Dead battery
- Disconnected battery cable
- Fuse burned out
- Faulty ignition switch

Low power

- Weak battery
- Loose battery connection
- Charging system failure
- Faulty regulator/rectifier

Intermittent power

- Loose battery cable connection
- Loose charging system connection
- Loose connection or short circuit in ignition system

Charging system failure

- Loose, broken or shorted wire or connector
- Faulty regulator/rectifier
- Faulty A.C. generator

16. BATTERY/CHARGING SYSTEM

BATTERY

REMOVAL

The battery is in the battery box below seat.

1. Remove the seat.
2. Remove the met-in box
3. Remove the battery retainer.

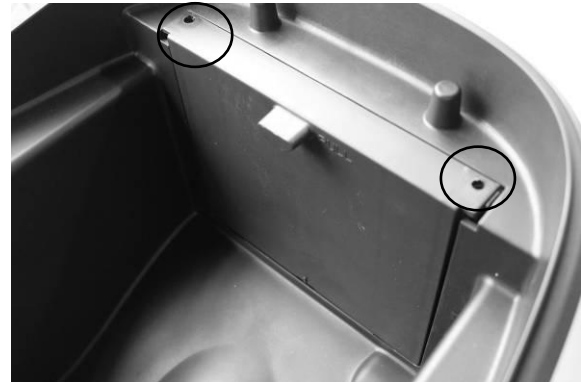

4. Pull battery out to expose the terminal leads
5. Disconnect the negative (-) terminal lead from the battery first, then disconnect the positive (+) terminal lead.
6. Remove the battery from the battery box.

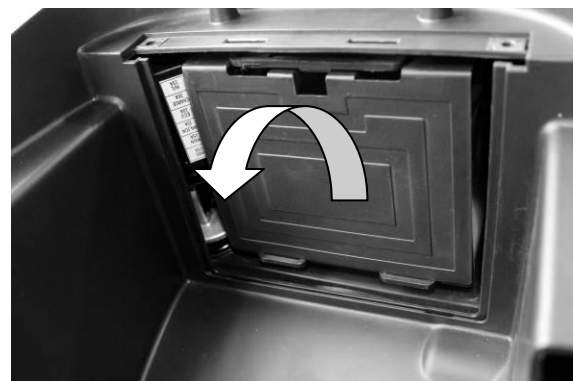

BATTERY INSTALLATION

Install in the reverse order of the removal.

* When install the battery, first connect the positive (+) cable and then negative (-) cable to avoid short circuit.

VOLTAGE INSPECTION

Remove the battery cover.

Measure the battery voltage by using a commercially available digital multimeter.

Voltage (20°C/68°F):

Fully charged: 13.0 ~ 13.2 V

Insufficient charged: < 12.3 V

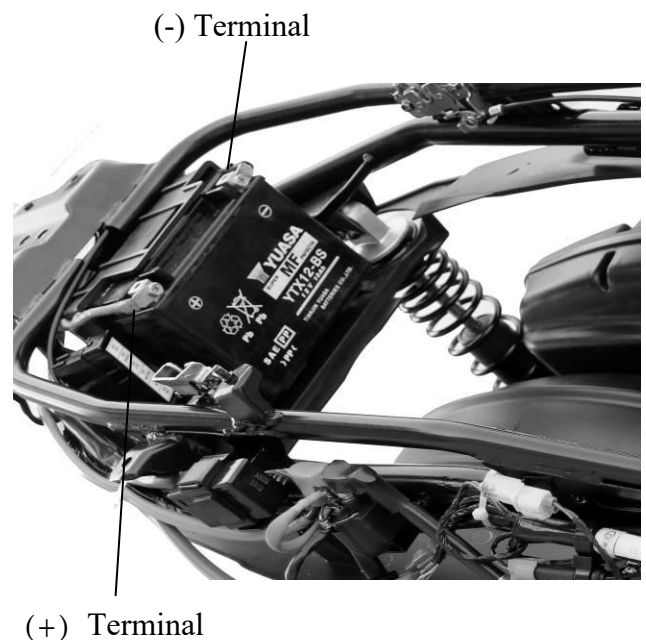

16. BATTERY/CHARGING SYSTEM

BATTERY CHARGING

Remove the battery

Connect the charger positive (+) cable to the battery positive (+) terminal.

Connect the charger negative (-) cable to the battery negative (-) terminal.

* Turn the power ON/OFF at the charger, not at the battery terminals.

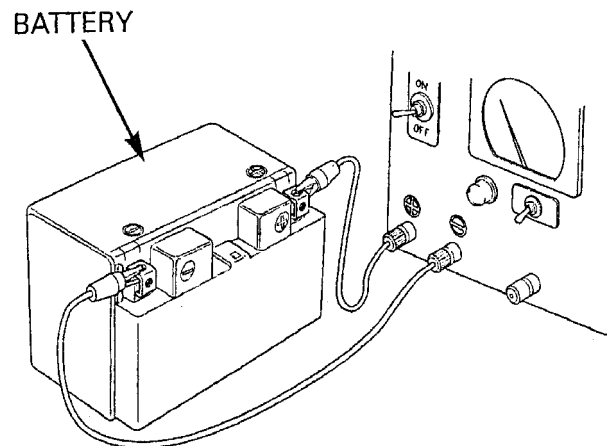

CHARGING CURRENT:

Standard: 1.2A / 5~10 Hours

For battery charging, do not exceed the charging current and time specified on the battery. Using excessive current or extending the charging time may damage the battery.

CHARGING VOLTAGE INSPECTION

Be sure that the battery is in good condition before performing this test.

* Do not disconnect the battery or any cable in the charging system without first switching off the ignition switch. Failure to follow this precaution can damage the tester or electrical



Start the engine and warm it up to the operating temperature; stop the engine.

Connect the multimeter between the positive (+) and negative (-) terminals of the battery.

To prevent short, make absolutely certain which are the positive (+) and negative (-) terminals or cable.

With the headlight on and turned to the high beam position, restart the engine.

Measure the voltage on the multimeter when the engine runs at 5000 rpm.

Standard:

Battery charging voltage 13.5~ 14.5V

16. BATTERY/CHARGING SYSTEM

REGULATOR/RECTIFIER

WIRE HARNESS INSPECTION

Remove the luggage box
Disconnect the regulator/rectifier connectors.
Check the connectors for loose contacts of
corroded terminals.

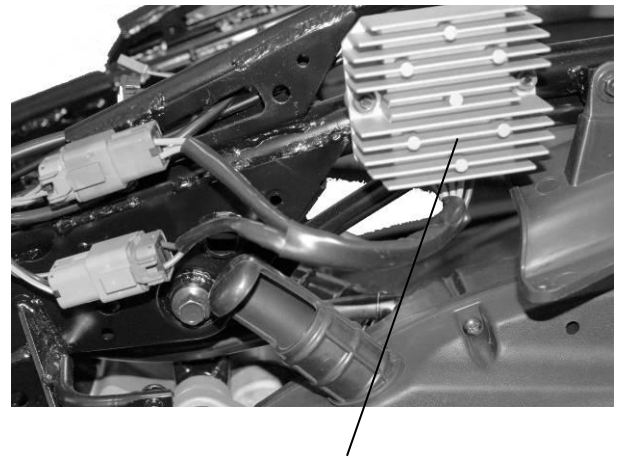

Regulator/Rectifier

BATTERY WIRE

Measure the voltage between the Red/White
wire terminal and ground.
There should be battery voltage at all times.



GROUND WIRE

Check the continuity between the Green wire
terminal and ground.
There should be continuity at all times.



16. BATTERY/CHARGING SYSTEM

CHARGING COIL WIRE

Measure the resistance between each Yellow wire terminals.

Standard: 0.4 ~ 0.6 Ω (20°C/68°F)

Disconnect the regulator/rectifier connector.
Check for continuity between each Yellow wire terminal regulator/rectifier side and ground.

There should be no continuity.



Regulator/Rectifier

REMOVAL/INSTALLATION

Remove the side body cover.

Disconnect the regulator/rectifier connectors.

Remove the two bolts, regulator/rectifier.

Installation is in the reverse order of removal.

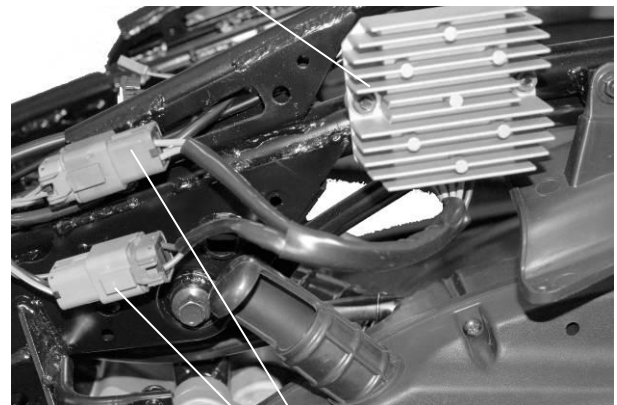

Connectors

17. IGNITION SYSTEM

IGNITION SYSTEM

IGNITION SYSTEM LAYOUT	17-1
SERVICE INFORMATION	17-2
TROUBLESHOOTING	17-2
SPARK PLUG	17-3
IGNITION COIL INSPECTION	17-3
A.C. GENERATOR INSPECTION	17-4
TILT SWITCH INSPECTION	17-4

17. IGNITION SYSTEM

IGNITION SYSTEM LAYOUT

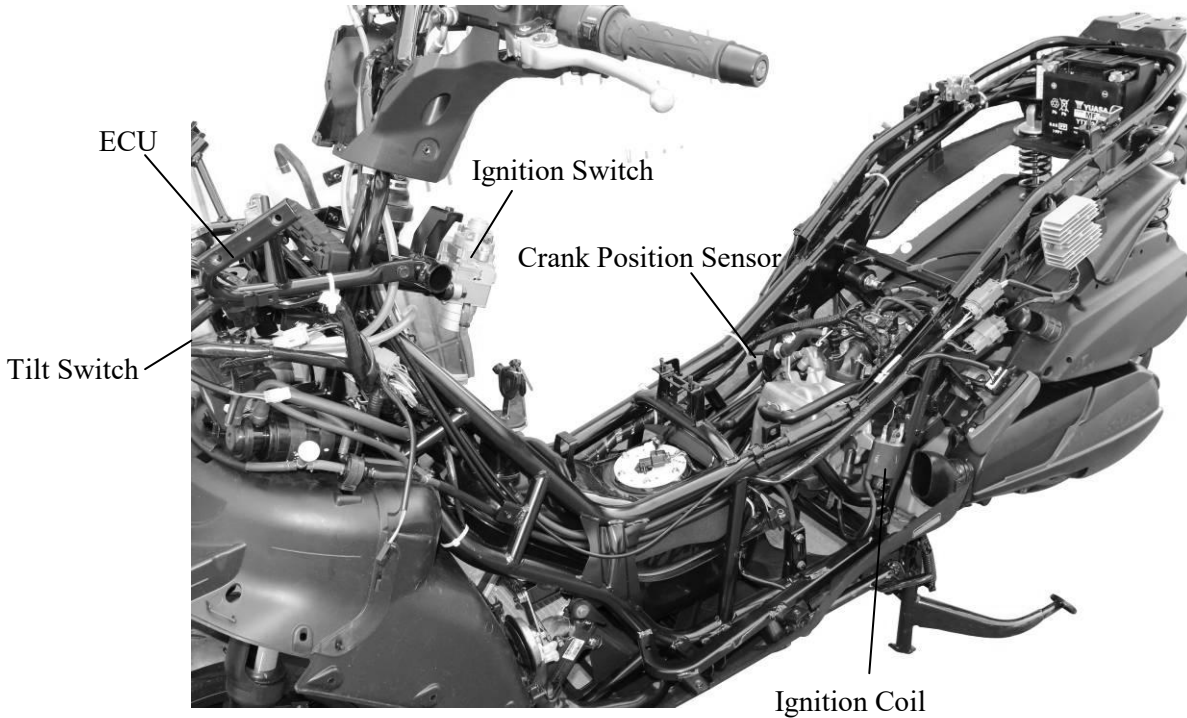

IGNITION CIRCUIT

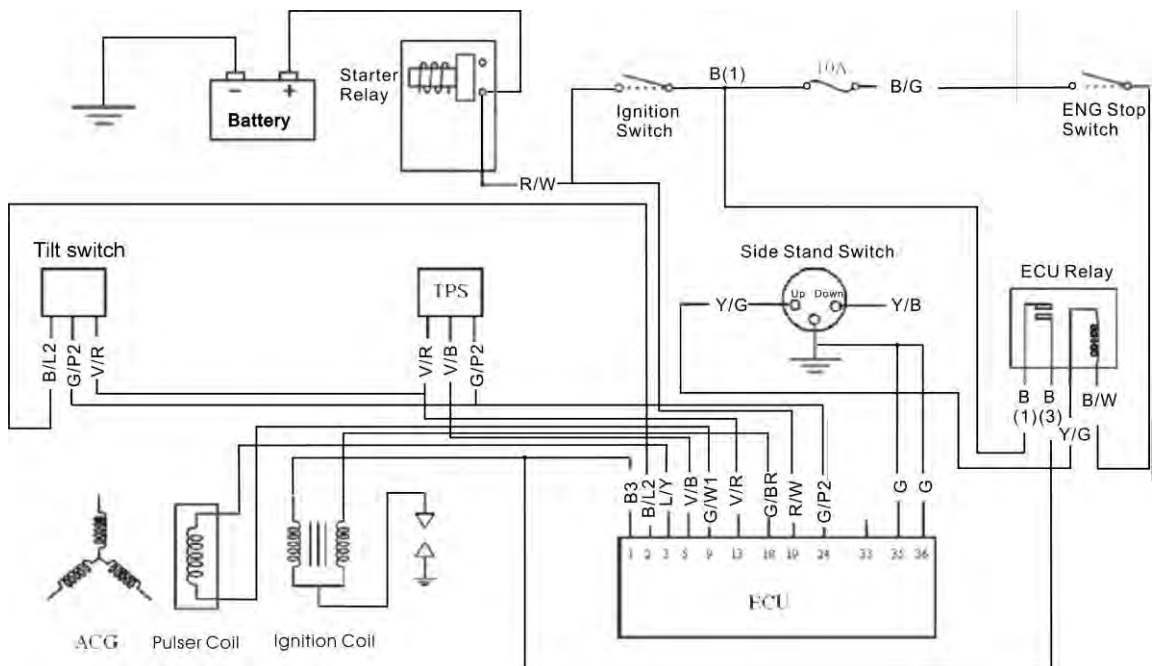

17. IGNITION SYSTEM

SERVICE INFORMATION

GENERAL INSTRUCTIONS

- Some electrical components may be damaged if terminals or connectors are connected or disconnected while the ignition switch is "ON" and current is present.
- When servicing the ignition system, always follow the steps in the troubleshooting on page 17-2.
- The ignition timing cannot be adjusted since the ignition control module is already adjusted in factory.
- The ignition control module or ECU maybe damaged if dropped or the connector is disconnected when the key is " ON " , the excessive voltage may damage the ignition control module or ECU. Always turn off the ignition switch before servicing.
- A faulty ignition system is often related to poor connections. Check those connections before proceeding.
- Make sure the battery is adequately charged. Using the starter motor with weak battery results in a slower engine cranking speed as well as no spark at the spark plug.
- Use a spark plug of the correct heat range. Using spark plug with an incorrect heat range can damage the engine.

SPECIFICATIONS

Item		Standard
Spark plug	Standard type	NGK DPR6EA-9
Spark plug gap		0.8 ~ 0.9 mm
Inductive Ignition Coil	Primary coil	3.57~4.83Ω
	Secondary coil with plug cap	10.42~14.49 KΩ
Throttle Position Sensor		3500~6500Ω
Fuel Pump		1.9 Ω about
Fuel Injector		11.7±0.6Ω
Water Temperature Sensor		2.076KΩ±10% (25℃)
Oxygen Sensor (engine warming condition)		6.7Ω~9.5Ω
Crank Position Sensor		115Ω±15Ω
Tilt Switch		0.4V~1.4V(normal) 3.7V~4.4V (fall down)

TROUBLESHOOTING

No peak voltage

- Short circuit in engine stop switch or ignition switch wire.
- Faulty engine stop switch or ignition switch.
- Loose or poorly connected ignition control module connectors.
- Open circuit or poor connection in ground wire of the ignition control module.
- Faulty crank position sensor.
- Faulty ignition control module.

Peak voltage is normal, but no spark jumps at the plug

- Faulty spark plug or leaking ignition coil secondary current.
- Faulty ignition coil.

17. IGNITION SYSTEM

SPARK PLUG

For spark plug inspection and adjustment, refer to page 3-5.

IGNITION COIL INSPECTION

Remove the seat and met-in box. (⇒2-6)
Remove the ignition coil.

Ignition Coil



IGNITION COIL CONTINUITY TEST

Inspect the continuity of the ignition coil, primary coil and secondary coil.

* This is a general test. Accurate ignition coil test must be performed with an ignition unit tester.

Primary Coil

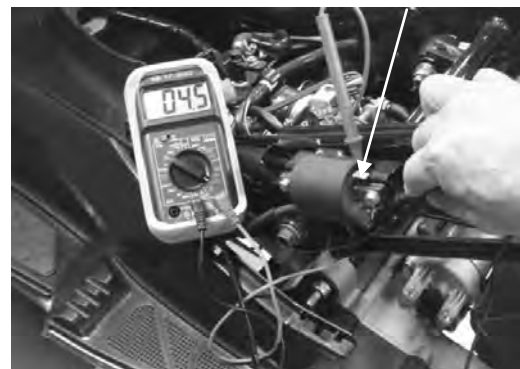

Secondary Coil with plug cap



Measure the ignition coil resistances at 20°C.

Primary coil	3.57~4.83 Ω
Secondary coil with plug cap	10 ~ 14 KΩ
Secondary coil without plug cap	6 ~10 KΩ

Secondary Coil without plug cap



17. IGNITION SYSTEM

A .C. GENERATOR INSPECTION

CRANK POSITION SENSOR INSPECTION

* This test is performed with the stator installed in the engine.

Remove the seat and met-in box.
 Disconnect the Crank Position Sensor Wire Coupler.
 Measure the resistance between the blue/yellow and green/white wire terminals.

Blue/Yellow~Green/White	115Ω±15Ω
-------------------------	----------

TILT SWITCH INSPECTION

Support the scooter level surface.
 Put the side stand up and engine stop switch is at "RUN".
 Turn the ignition switch to "OFF".
 Remove the screws, washers and tilt switch.

* Do not disconnect the tilt switch connector during inspection.
 The capacity of battery must be fully charged.

Place the tilt switch vertical as shown at the ignition switch "ON". Measure the voltage as below.

Terminal	Standard
Violet/Red (+) – Green/Pink (-)	5 V (ECU voltage)
Black/Blue (+) – Green/Pink (-)	0.4 ~ 1.4 V less

Incline the tilt switch 65±10 degrees to the left or right at the ignition switch "ON". Measure the voltage as below.

Terminal	Standard
Violet/Red (+) – Green/Pink (-)	5 V (ECU voltage)
Black/Blue (+) – Green/Pink (-)	3.7 ~ 4.4 V

If repeat this test, first turn the ignition switch to "OFF", then turn the ignition switch to "ON".



Crank Position Sensor Wire Coupler



Tilt Switch Connector Screws



"UP" Mark

17. IGNITION SYSTEM

REMOVAL/INSTALLATION

Disconnect the connector and remove two screws, then remove tilt switch.

Installation is in the reverse order of removal.

- * Install the tilt switch with its “up” mark facing up.

Tighten the mounting screws securely.

Tilt Switch Connector Screws



18. STARTING SYSTEM

18

STARTING SYSTEM

STARTING SYSTEM LAYOUT	18-1
SERVICE INFORMATION	18-2
TROUBLESHOOTING	18-2
STARTER MOTOR	18-3
STARTER RELAY INSPECTION.....	18-4

18. STARTING SYSTEM

STARTING SYSTEM LAYOUT

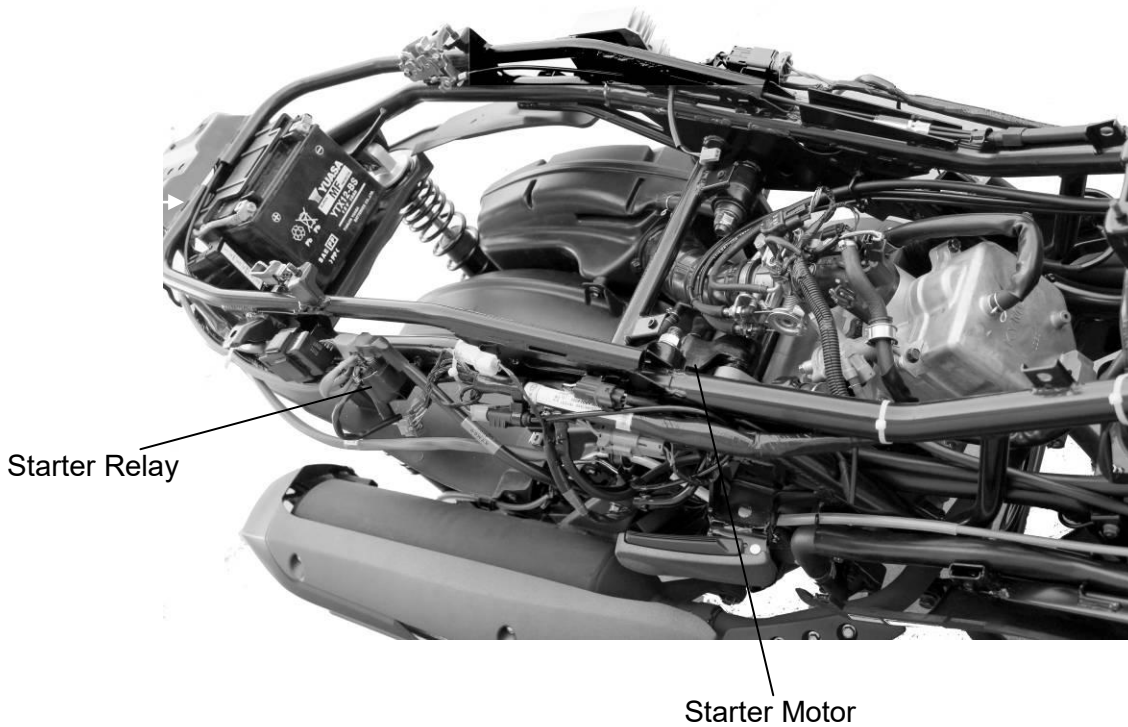

STARTING CIRCUIT

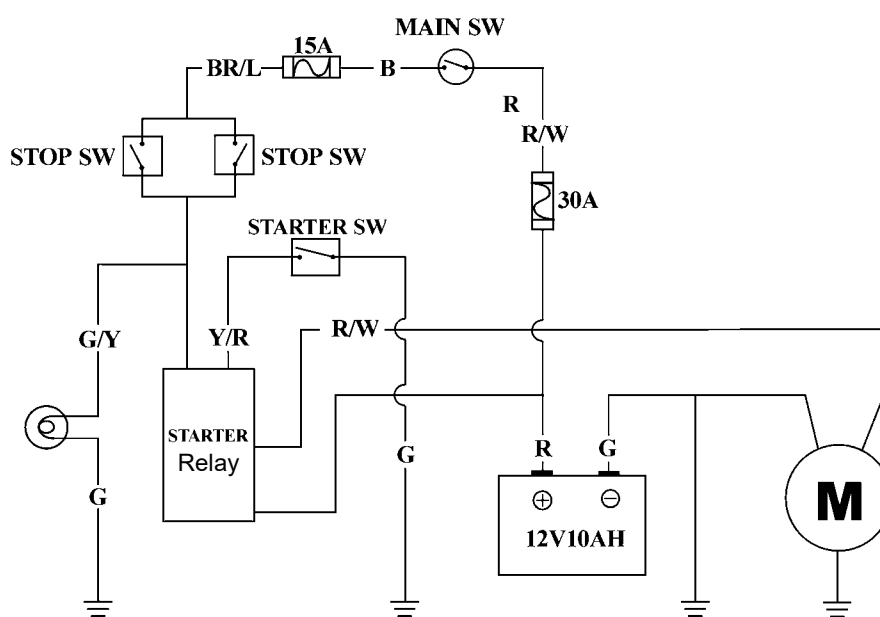

18. STARTING SYSTEM

SERVICE INFORMATION

GENERAL INSTRUCTIONS

- The removal of starter motor can be accomplished with the engine installed.
- After the starter clutch is installed, be sure to add the engine oil and coolant and then bleed air from the cooling system.

SPECIFICATIONS

Item	Standard (mm)	Service Limit (mm)
Starter motor brush length	12.5mm	8.5mm

TORQUE VALUES

Starter motor mounting bolt	6.7~10.8 N-m
Starter motor case screw	2.9~4.9 N-m
Starter clutch bolt	9.8~13.7 N-m

SPECIAL TOOLS

Flywheel holder	E021
Flywheel puller	E003

TROUBLESHOOTING

Starter motor won't turn

- Fuse burned out
- Weak battery
- Faulty ignition switch
- Faulty starter clutch
- Faulty front or rear stop switch
- Faulty starter relay
- Poorly connected, broken or shorted wire
- Faulty starter motor

Lack of power

- Weak battery
- Loosed wire or connection
- Foreign matter stuck in starter motor or gear

Starter motor rotates but engine does not start

- Faulty starter pinion
- Starter motor rotates reversely
- Weak battery

18. STARTING SYSTEM

STARTER MOTOR

REMOVAL

* Before removing the starter motor, turn the ignition switch OFF and remove the battery ground. Then, turn on the ignition switch and push the starter button to make sure the starter motor can't operate securely.

Remove the seat, met-in box and carrier.
Remove the body cover, center cover and rear fender A together.
Remove the nut goes to the starter relay and relax cable band to disconnect the starter motor cable.

Remove two start motor mounting bolts and the motor.

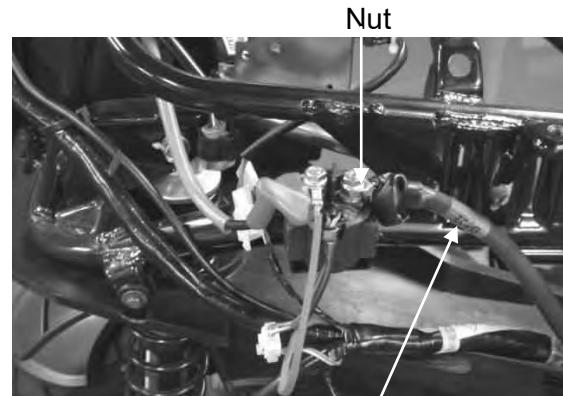

Nut
Starter Motor Cable

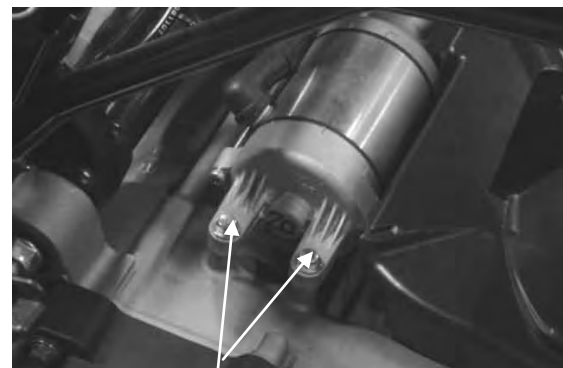

Bolts

18. STARTING SYSTEM

INSTALLATION

Connect the starter motor cable.
 Check the O-ring for wear or damage and replace if necessary.
 Apply grease to the O-ring and install it to the starter motor.
 Tighten the two mounting bolts.

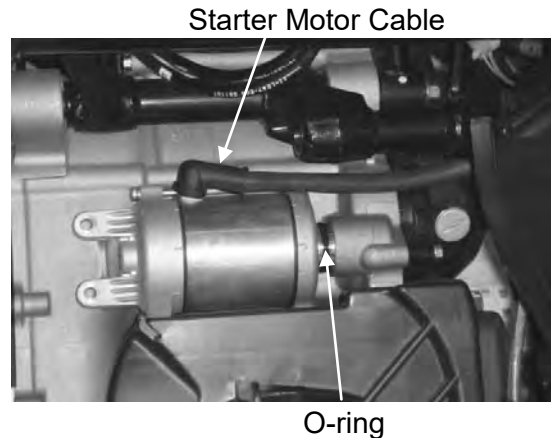

STARTER RELAY INSPECTION

Disconnect the starter relay wire connector.
 Check for continuity between the yellow/red wire and green/yellow wire.
 There should be continuity when the starter button is depressed.
 If there is no continuity, check the starter button for continuity and inspect the wire.



Yellow/Red Wire

OPERATION TEST

Connect the electric meter to the starter relay terminals that connect to the battery positive cable and the starter motor cable.
 Connect a fully charged battery across the starter relay yellow/red and green/yellow wire terminals.
 Check for continuity between the starter relay large terminals. The relay is normal if there is continuity and hear sounds.

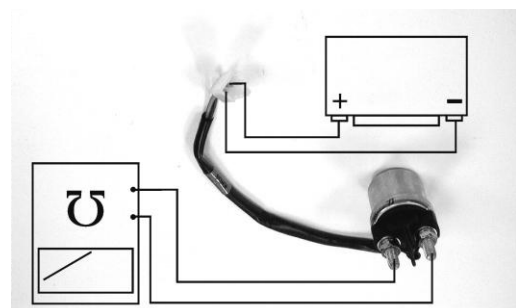

Starter Relay test chart

19. LIGHTS SWITCHES/ FUEL PUMP

LIGHTS/METERS/SWITCHES

SERVICE INFORMATION-----	19- 1
BULB REPLACEMENT -----	19- 2
BRAKE LIGHT SWITCH-----	19- 6
IGNITION SWITCH -----	19- 6
HANDLEBAR SWITCH -----	19- 7
LUGGAGE BOX LIGHT SWITCH -----	19- 9
FUEL PUMP -----	19-10
SIDE STAND SWITCH -----	19-13
HORN -----	19-14

19. LIGHTS SWITCHES/ FUEL PUMP

ELECTRICAL EQUIPMENT LAYOUT

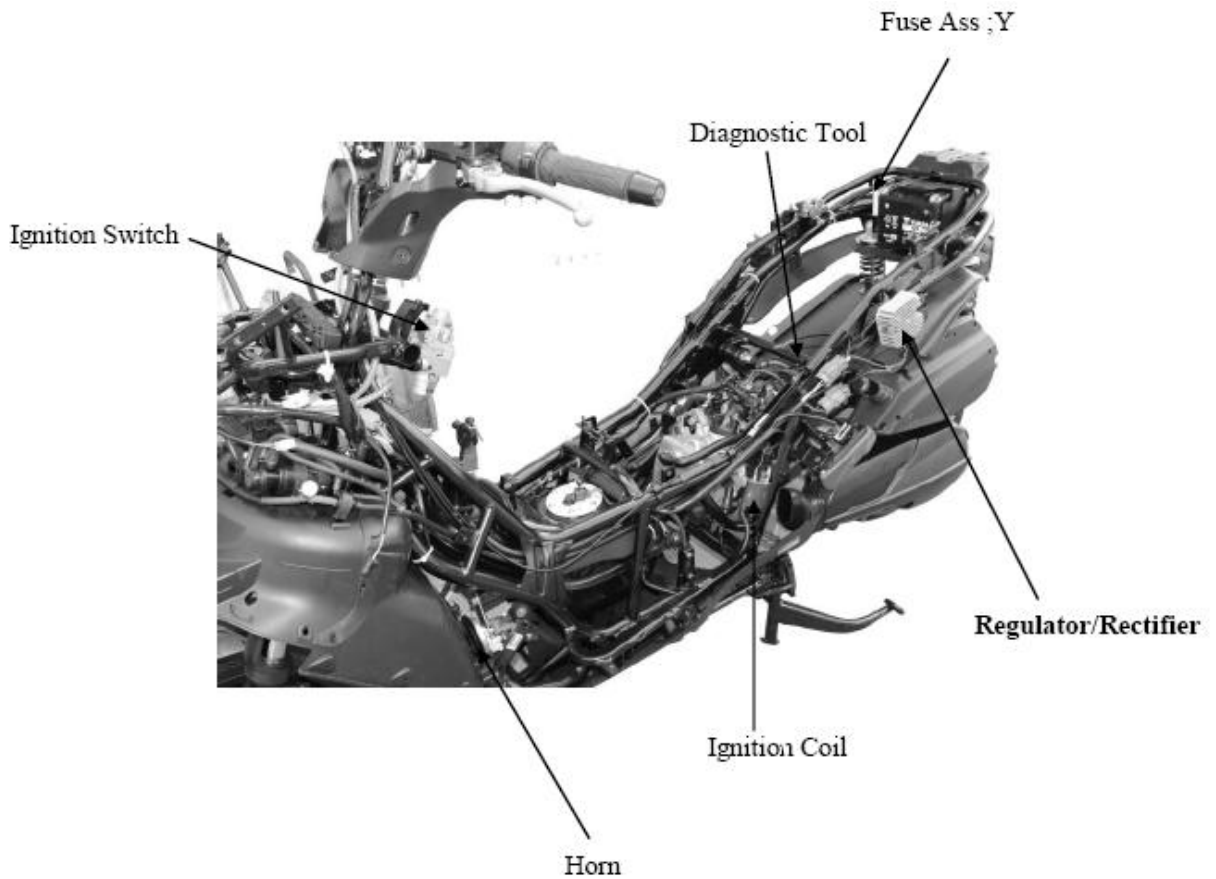
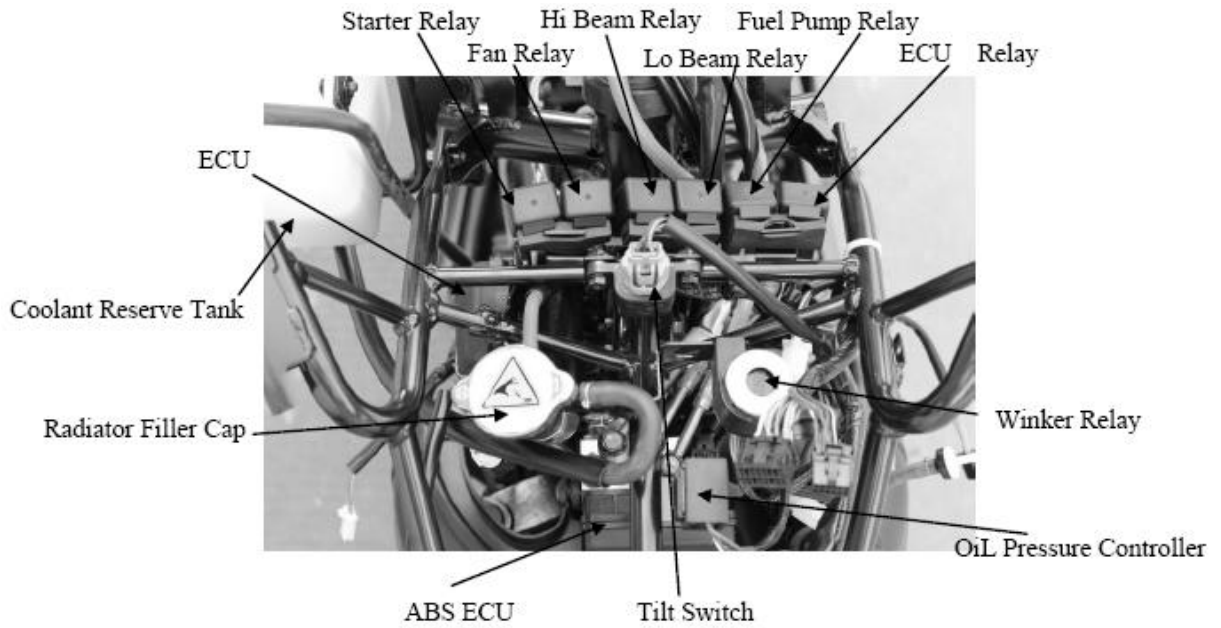

19. LIGHTS SWITCHES/ FUEL PUMP

SERVICE INFORMATION

GENERAL

* A halogen head light bulb becomes very hot while the head light is on, and remains for a while after it is turned off. Be sure to let it cool down before servicing.

- Note the following when replacing the halogen headlight bulb
 - ™ Wear clean gloves while replacing the bulb. Do not put finger prints on the headlight bulb, as they may create hot spots on the bulb and cause it to fail.
 - ™ If you touch the bulb with your bare hands, clean it with a cloth moistened with alcohol to prevent its early failure.
 - ™ Be sure to install the dust cover after replacing the bulb.
- Check the battery condition before performing any inspection that requires proper battery voltage.
- A continuity test can be made with the switches installed on the scooter.
- Route the wires and cables properly after servicing each component.

TROUBLESHOOTING

Lights do not come on when ignition switch is "ON"

- Burned bulb
- Faulty switch
- Poorly connected, broken or shorted wire

Temperature gauge does not register correctly

- Faulty temperature gauge
- Faulty thermosensor
- Broken or shorted wire between the temperature gauge and thermosensor

Fuel gauge does not work or wrong show figures

- Faulty fuel gauge
- Faulty fuel unit
- Poorly connected wire between fuel gauge and fuel unit
- Fuse burned out

SPECIFICATIONS

Fuse	10A,15A,30A
Headlight bulb	12V 35W/35W *2
Turn signal light bulb	12V 21W(Front) / 10W(Rear)
Stoplight/taillight	12V 21/5W

19. LIGHTS SWITCHES/ FUEL PUMP

BULB REPLACEMENT

LICENSE LIGHT

Remove the seat assembly and luggage box.
Remove the body covers.
Disconnect the license bulb socket.
Remove the bulb and replace with a new one.



19. LIGHTS SWITCHES/ FUEL PUMP

HEADLIGHT

* A halogen headlight bulb becomes hot while the headlight is ON and remains for a while after it is turned OFF. Be sure to let it cool down before servicing.

REMOVAL

Remove the front cover
Disconnect the headlight cover
Disconnect the headlight connector from the headlight bulb.
Remove snap ring on the headlight.

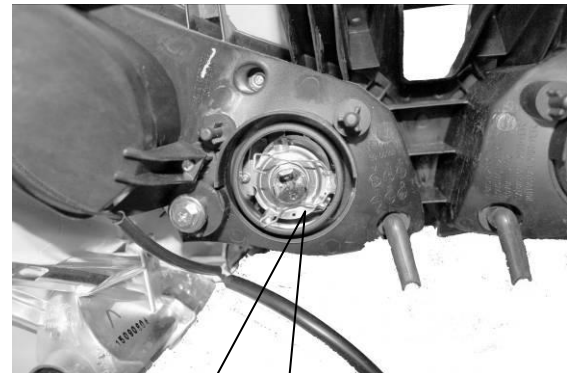
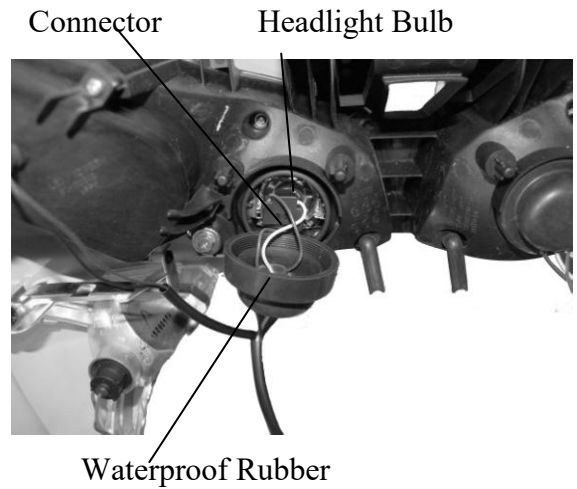

INSTALLATION

Install a new bulb into the headlight case.
Install the headlight and snap ring.
Install connect the headlight connector

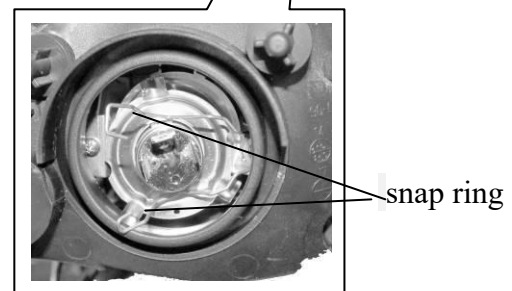

19. LIGHTS SWITCHES/ FUEL PUMP

Put the headlight wires into the headlight unit and then cover the waterproof rubber.

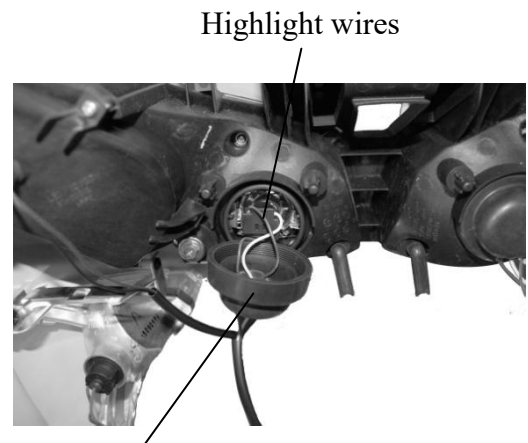

Waterproof Rubber

Press the waterproof rubber around with hand until its seat.

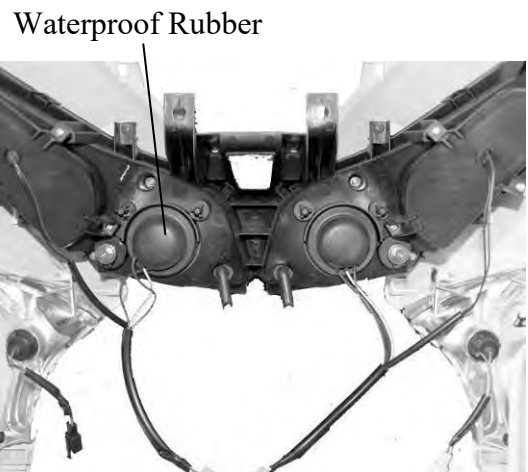

INSPECTION

Confirm if the waterproof rubber is covered firmly.

* If the waterproof rubber isn't installed firmly, the headlamp is possible to be burned out after water into the headlight unit.

19. LIGHTS SWITCHES/ FUEL PUMP

FRONT TURN SIGNAL LIGHT

Remove the front cover.
Turn the bulb socket, then remove the front turn signal light.



Push and turn the bulb counterclockwise to remove it, then replace with a new one.

Installation is in the reverse order of removal.



TAILLIGHT/BRAKE LIGHT/REAR TURN SIGNAL LIGHT

Remove the seat and met-in, then remove the taillight bulb socket.



19. LIGHTS SWITCHES/ FUEL PUMP

REAR TURN SIGNAL LIGHT

Remove four

Push and turn the bulb counterclockwise to remove it, then replace with a new one.

Installation is in the reverse order of removal.



Rear Turn Signal Light



19. LIGHTS SWITCHES/ FUEL PUMP

BRAKE LIGHT SWITCH

Remove the upper handlebar cover.
 Disconnect front or rear brake light switch connectors and check for continuity between the switch terminals.
 There should be continuity with the front or rear brake lever squeezed, and there should be no continuity with the front or rear brake lever is released.



Front Brake Light Switch



Rear Brake Light Switch

IGNITION SWITCH

INSPECTION

Remove the front cover.
 Disconnect the ignition switch connector and check the ignition switch for continuity at the switch side connector terminals.
 Continuity should exist between the color code wires as follows:

COMB SW

	BAT2	IG	E	BAT1	HA
LOCK		○—○			
OFF		○—○		○—○	
ON	○—			○—○	
COLOR	B	B/W	G	R	B/L



19. LIGHTS SWITCHES/ FUEL PUMP

RIGHT HANDLEBAR SWITCH

INSPECTION

Remove the front cover

Disconnect the right handlebar switch connector and check for continuity at switch side connector terminals.

Continuity should exist between the color code wires as follows:

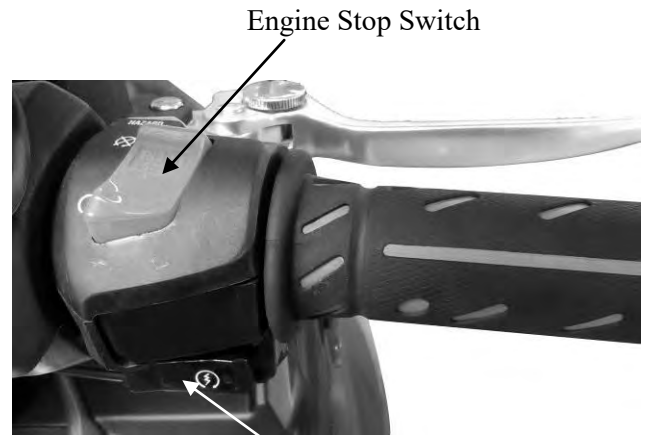

Starter Switch

STARTER SW		
	E	ST
FREE		
PUSH	○	○
COLOR	G	Y/R

ENGINE STOP SW		
	IG	BAT3
OFF		
RUN	○	○
COLOR	B/W	B/G

19. LIGHTS SWITCHES/ FUEL PUMP

LEFT HANDLEBAR SWITCH

INSPECTION

Disconnect the left handlebar switch connector and check for continuity at switch side connector terminals.

Continuity should exist between the color code wires as follows:

WINKER SW

	WR	R	L
R	○	○	
N			
L	○		○
COLOR	GR	SB	O

HORN SW

	BAT4	HO
FREE		
PUSH	○	○
COLOR	BR/L	LG

DIMMER SW

	HL	HI	LO
LO	○		○
(N)	○	○	○
HI	○	○	
COLOR	W/L	L	W

PASSING SW

	BAT4	HI
FREE		
PUSH	○	○
COLOR	BR/L	L

Dimmer Switch

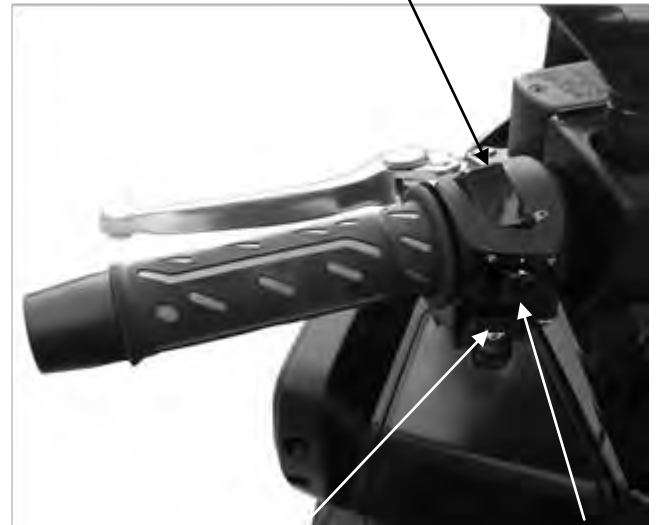

Horn Switch Turn Signal light Switch

Passing Switch



LUGGAGE BOX LIGHT SWITCH

INSPECTION

Remove the luggage box

Disconnect the luggage box light switch connector and check the luggage box light switch for continuity between the switch terminals.

There should be no continuity with the luggage box light switch pushed, and there should be continuity with the luggage box light switch is released.

Luggage box light switch

Connector



19. LIGHTS SWITCHES/ FUEL PUMP

FUEL PUMP

REMOVAL

Remove the seat and met-in

Remove the center cover

Remove the fuel pump connector

Be sure to relieve the fuel pressure before removing fuel pump or fuel hose.

Remove the six nuts and fuel unit connectors then remove the fuel hose.

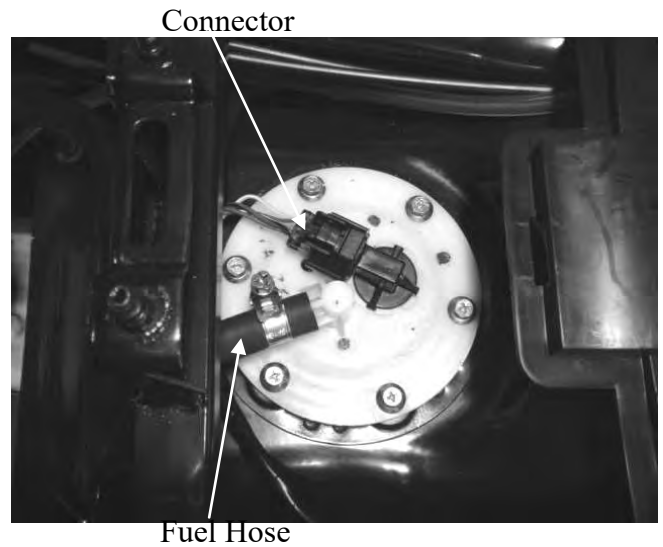

Remove the fuel pump



Check the fuel pump O-ring.

If was damage, replace a new one.

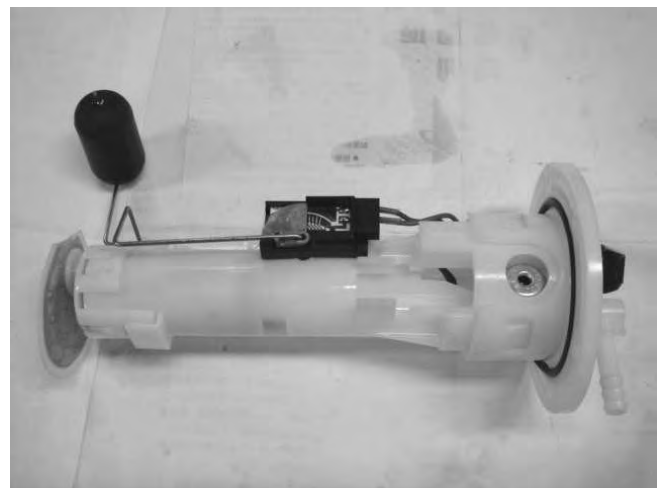

19. LIGHTS SWITCHES/ FUEL PUMP

INSPECTION

Connect the fuel unit wire connectors and turn the ignition switch "ON".

* Before performing the following test, operate the turn signals to determine that the battery circuit is normal.

Measure the resistance between the Red/Black and Green wire of the fuel unit connector.

Standard (at 20°C/68°F):

Float at full position	About 1100 Ω
Float at empty position	About 100 Ω

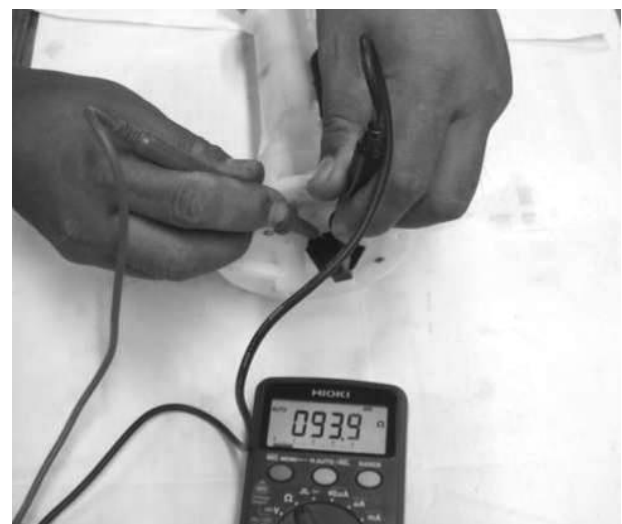
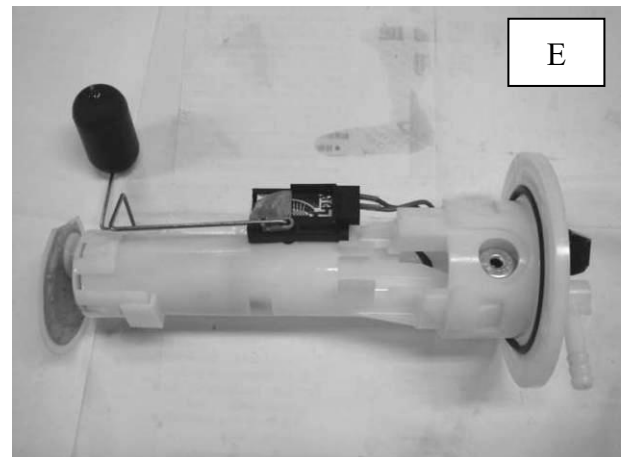
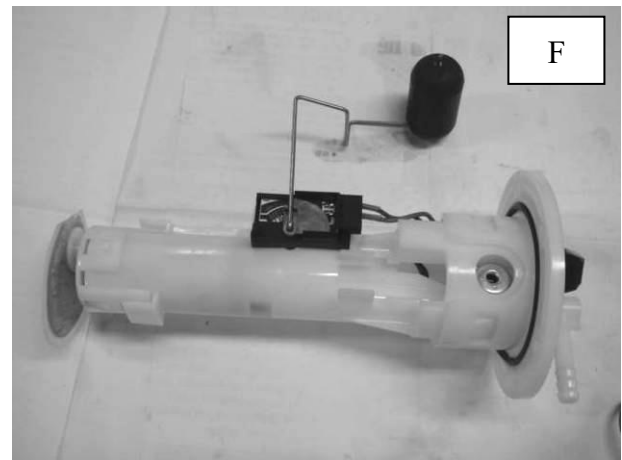

19. LIGHTS SWITCHES/ FUEL PUMP

SIDE STAND SWITCH

INSPECTION

Remove the luggage box.

Side stand switch is located on side stand.

Disconnect the side stand switch connector.

There should be continuity between the Yellow/Green and Green with the side stand is up.

There should be continuity between the Yellow/Black and Green with the side stand is down.

Connector

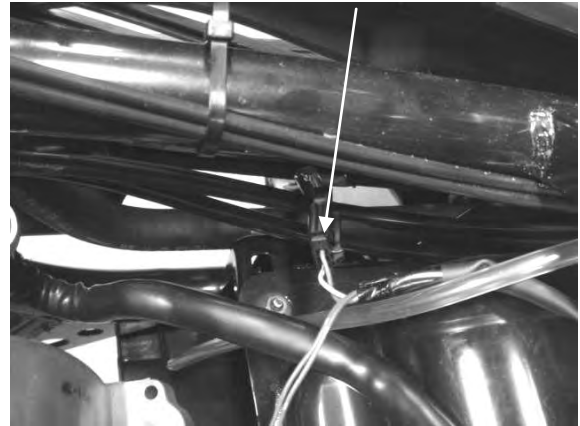

UP



DOWN

19. LIGHTS SWITCHES/ FUEL PUMP

HORN

INSPECTION

Remove the front cover.

Disconnect the horn connectors from the horn.

Connect a 12 V battery to the horn terminals.

The horn is normal if it sounds when the 12 V battery is connected across the horn terminals.



20. EVAPORATIVE EMISSION CONTROL SYSTEM

20

EVAPORATIVE EMISSION CONTROL SYSTEM

SCHEMATIC DRAWING	20-1
EVAPORATIVE EMISSION CONTROL SYSTEM FUNCTION.....	20-2
TROUBLESHOOTING.....	20-2
SERVICE INFORMATION	20-3
PERGE CONTROL VALVE	20-4
CHARCOAL CANISTER.....	20-6

20. EVAPORATIVE EMISSION CONTROL SYSTEM

SCHEMATIC DRAWING

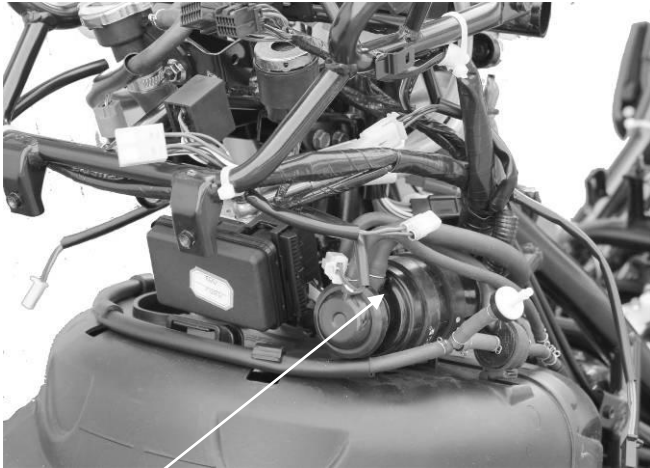

Charcoal Canister/ Purge Control Valve

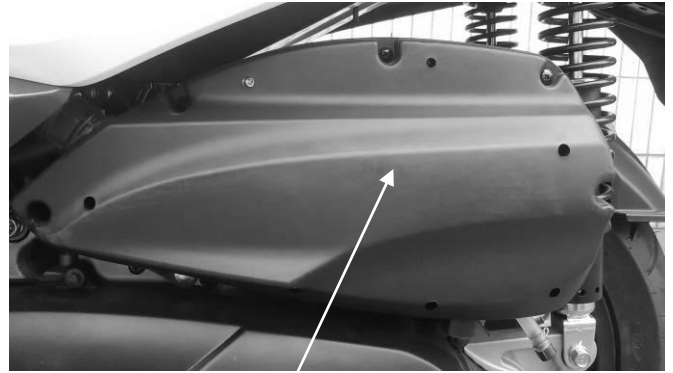

Air Cleaner

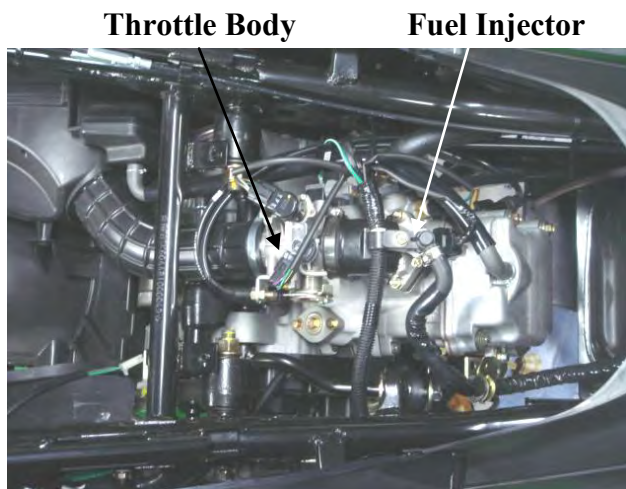

Throttle Body

Fuel Injector

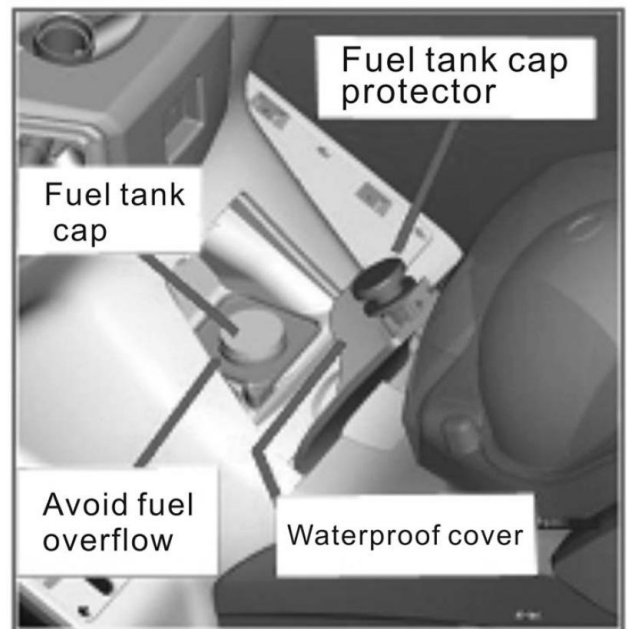

Fuel tank cap protector

Fuel tank cap

Avoid fuel overflow

Waterproof cover

20. EVAPORATIVE EMISSION CONTROL SYSTEM

EVAPORATIVE EMISSION CONTROL SYSTEM FUNCTION

FOREWORD:

The Evaporative Emission Control System is abbreviated to E.E.C. System. This device collects the fuel vapor from the fuel tank and then the fuel vapor is drawn into the engine for re-burning to avoid air pollution caused by the fuel vapor diffused into the air.

FUNCTION

Item	Purpose	Function
Purge Control Valve	Control vaporized HC from fuel tank not to diffuse into the air.	The charcoal canister absorbs vaporized HC from the fuel tank. When the engine is running and the purge control valve is open, the fuel vapor in the charcoal canister is drawn into the engine for re-burning.
Charcoal Canister	Absorb and store the vaporized HC from the fuel tank and carburetor.	The vaporized HC is absorbed in the charcoal canister and the specified volume of HC in the emission should not exceed 2g.
P.C.V. System	Completely recover the HC from blow-by gas in the crankcase for re-burning.	Through the P.C.V. system, the blow-by gas from the crankcase is separated into fuel vapor and fuel and then drawn into the cylinder for re-burning.

TROUBLESHOOTING

Engine loses power or runs erratic at idle speed

1. Clogged P.C.V. system
2. Clogged air cleaner
3. Faulty purge control valve
4. Loose or broken E.E.C. system tubes

Engine idles or accelerates roughly

1. Faulty fuel cut-off valve
2. Faulty purge control valve
3. Clogged or faulty charcoal canister

20. EVAPORATIVE EMISSION CONTROL SYSTEM

SERVICE INFORMATION

GENERAL INSTRUCTIONS

- Do not smoke or allow flames or sparks near the working area.
- Note the locations of tubes for proper installation.
- Replace any damaged tube with a new one.
- Make sure to tighten the connector of each tube securely.

TOOLS

- Vacuum pump — A937X — 014 — XXXX
- Pressure pump —

SPECIFICATIONS

Purge control valve vacuum pressure	45mm/Hg
Charcoal canister capacity	90cc

A. LEAKAGE TEST PIPING DIAGRAM

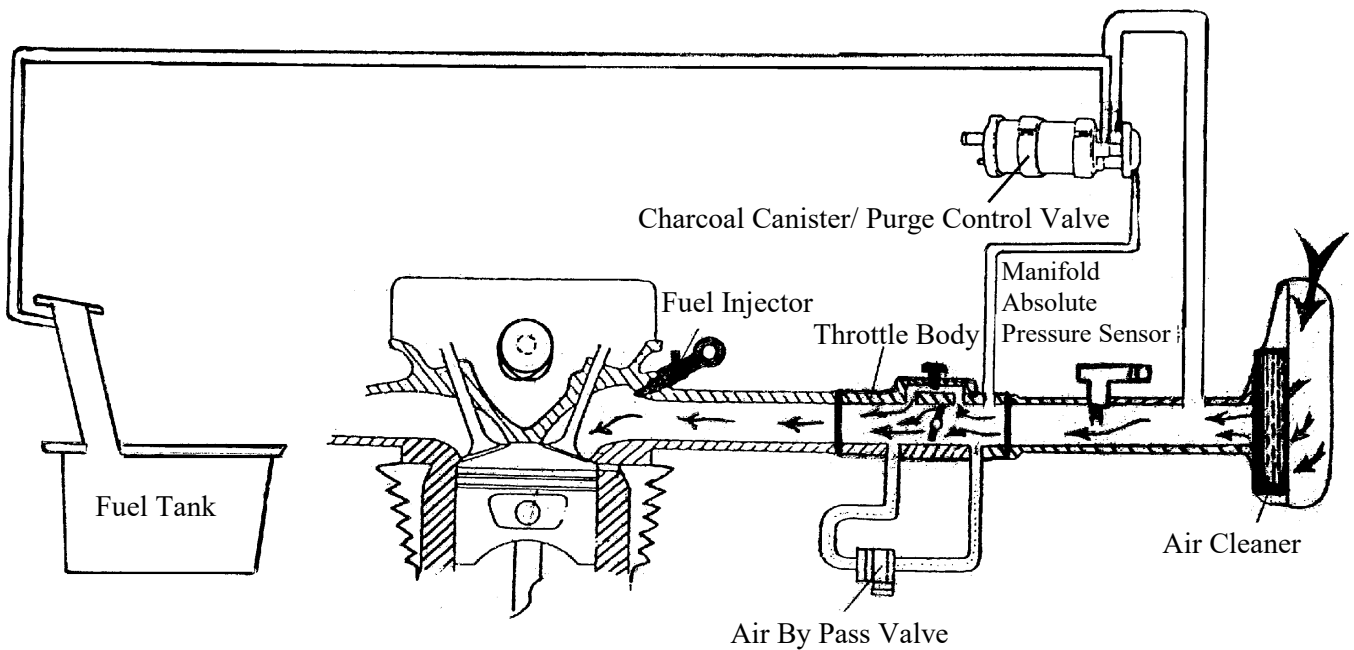

20. EVAPORATIVE EMISSION CONTROL SYSTEM

PURGE CONTROL VALVE REMOVAL

1. Remove the front cover.
2. Disconnect the purge control valve vacuum tube that goes to the throttle body and the tubes that go to the air cleaner and charcoal canister. Remove the charcoal canister/purge control valve.

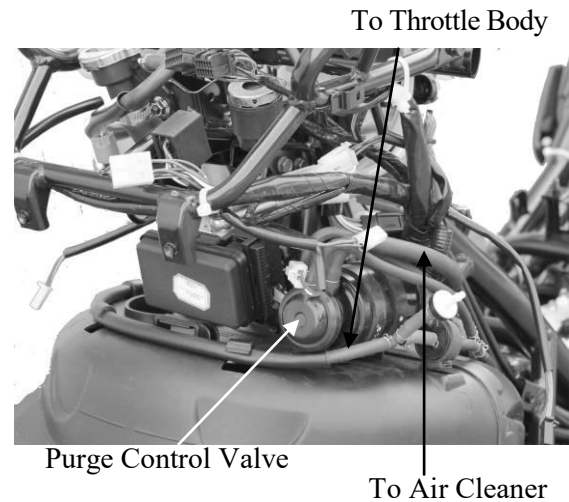

INSPECTION

Connect a vacuum pump to the purge control valve tube that goes to the air cleaner and apply vacuum pressure of 250mm/Hg. The specified vacuum must be maintained for one minute. Replace the purge control valve with a new one if vacuum is not maintained.

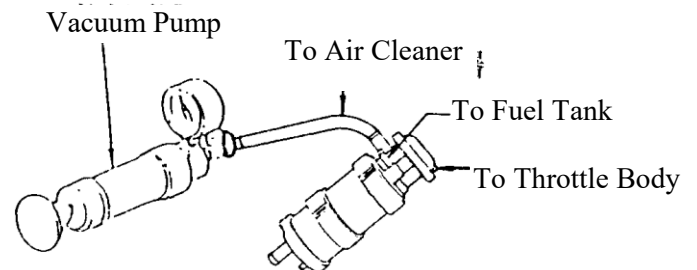

Connect a vacuum pump to the purge control valve tube that goes to the carburetor vacuum tube and apply vacuum pressure of 45mm/Hg. The specified vacuum must be maintained for one minute. Replace the purge control valve with a new one if vacuum is not maintained.

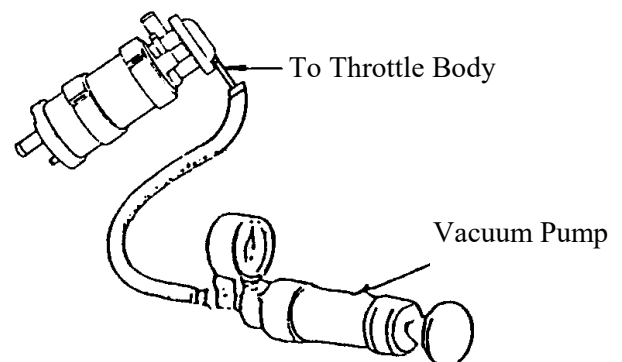

20. EVAPORATIVE EMISSION CONTROL SYSTEM

PURGE CONTROL VALVE FLOW INSPECTION

1. Connect a vacuum pump to the purge control valve vacuum tube and apply vacuum pressure of 45mm/Hg.
2. Connect a pressure pump to the tube that goes to the charcoal canister and apply pressure. The flow must be over 9.4 liters per minute and replace the purge control valve with a new one if the specified flow is not reached.

* To prevent damage to the purge control valve, do not use high air pressure sources. Use a hand operated pressure pump only.

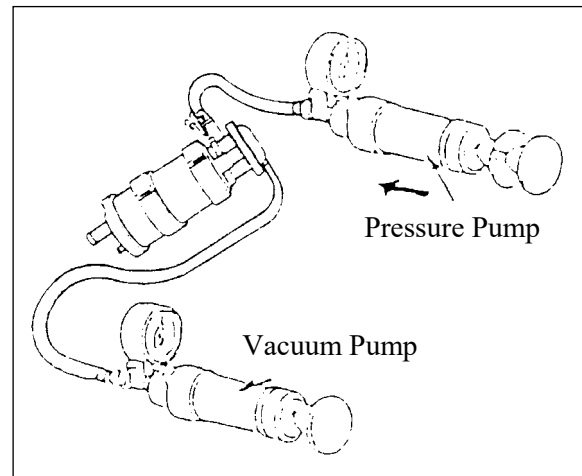

INSTALLATION

1. Install the purge control valve in the reverse order of removal.
2. Route and reconnect the purge control valve tubes properly and securely.

* Be careful not to bend, twist or kink the tubes during installation.

20. EVAPORATIVE EMISSION CONTROL SYSTEM

CHARCOAL CANISTER

REMOVAL

1. Remove the front cover.
2. Disconnect the charcoal canister tubes that go to the fuel tank and purge control valve.
3. Remove the charcoal canister.

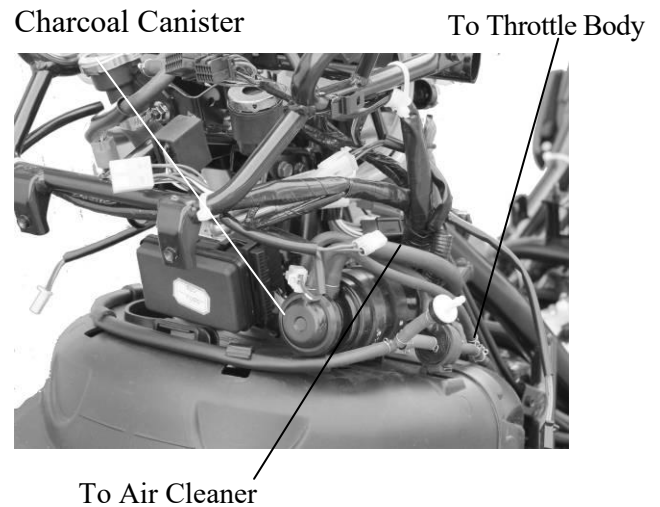

INSPECTION

1. Plug the tube that goes to the fuel tank and plug the blow-by tube. Then connect a hose to the canister. Blow the hose with mouth. The charcoal canister is normal if air can be blown into it. If clogged, replace it with a new one.
2. Check the charcoal for cracks and replace if necessary.

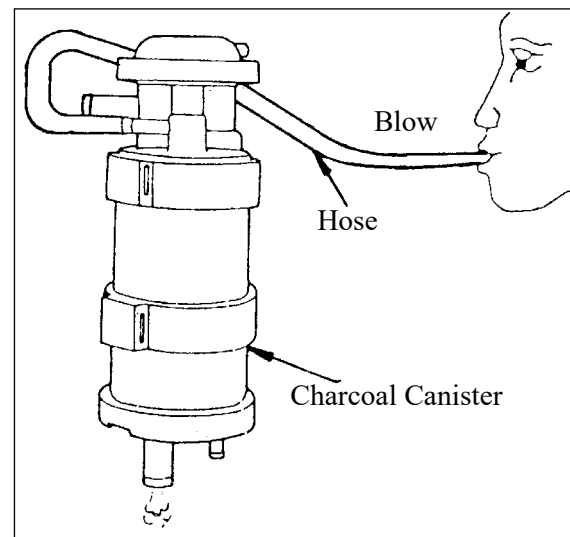

INSTALLATION

Install the charcoal canister in the reverse order of removal.

- The charcoal canister must be installed to its original position to avoid affecting its performance.
- Do not bend, twist or kink the tubes during installation.

ANTI-LOCK BRAKE SYSTEM (ABS)

21

ABS Indicator Light-----	21-01
ABS Introduction-----	21-02
ABS Parts Location -----	21-03
Wheel Speed -----	21-04
ABS ECU & ABS Hydraulic Unit -----	21-06
ABS ECU GUARANTEE-----	21-07
Diagnostic Tool Operation -----	21-08
Bosch ABS8m DTC List -----	21-14

21 . ANTI-LOCK BRAKE SYSTEM (ABS)

ABS Indicator Light

The ABS indicator light in the meter position. This light will come on when the ignition switch is turned on and goes off shortly after the vehicle starts moving at speed 6km/hr min. It stays off.

If something is wrong with the ABS, the indicator comes on and remains it. When the indicator light is on the ABS doesn't function but if the ABS fails, the conventional brake system will still work normally.

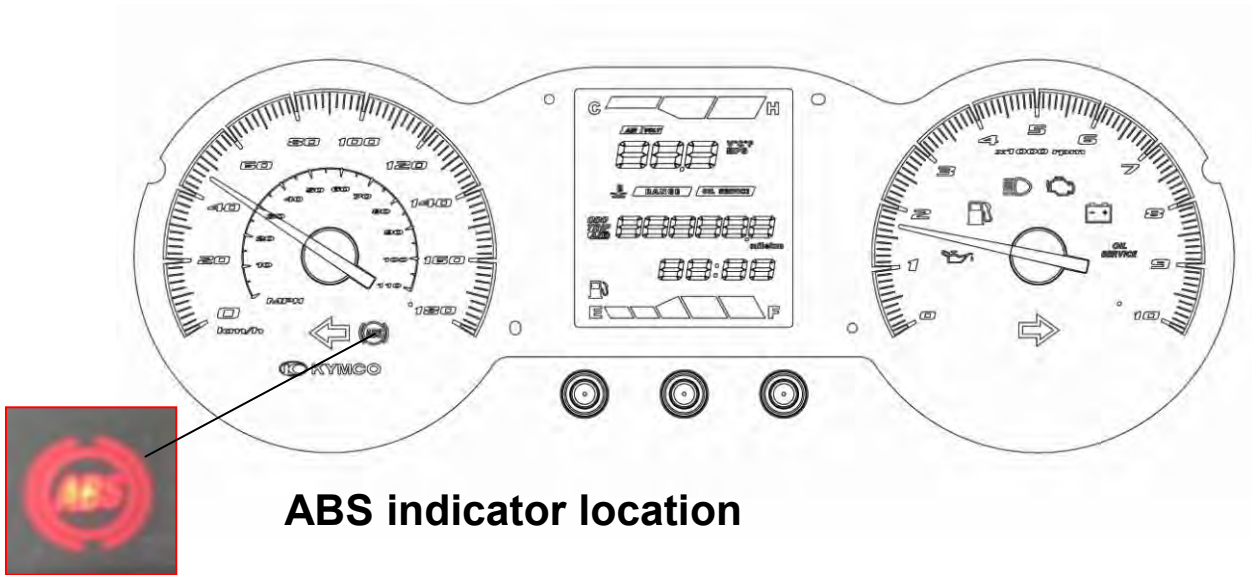

21 . ANTI-LOCK BRAKE SYSTEM (ABS)

ABS Introduction

ABS is designed to help prevent the wheels from locking up when the brakes are applied hard while running straight. The ABS automatically regulates brake force.

Intermittently gaining gripping force and braking force helps prevent wheel lock-up and allows stable steering control while stopping.

Brake control function is identical to that of conventional vehicle .The brake lever is used for the front brake and rear brake.

Although the ABS provides stability while stopping by preventing wheel lock-up, remember the following characteristics:

- ABS can not compensate for adverse road conditions, misjudgment or improper application of brakes. You must take the same care as with vehicle not equipped with ABS.
- ABS isn't designed to shorten the braking distance. On loose, uneven or downhill surfaces, the stopping distance of a vehicle with ABS may be longer than that of an equivalent vehicle without ABS. Use special caution in such areas.
- ABS will help prevent wheel lock-up when braking in straight line but it cannot control wheel slip, which may be caused by braking during cornering. When turning a corner, it is better to limit braking to the light application of both brakes or not to brake at all. Reduce your speed before you get into the corner.
- The computer could inter-grade in the ABS compare vehicle speed with wheel speed. Since non-recommended tires can affect wheel speed, they may confuse, Which can extend distance.

*** *Use of non-recommended tires may cause malfunctioning of ABS and lead to extended braking distance. The rider could have an accident as a result. Always use standard for this recommended vehicle.***

NOTICE:

- When the ABS is functioning, you may feel a pulsing in the brake lever. This is normal. You need not suspend applying brakes.
- ABS does not function at speeds of approx. 10 km/h or below.
- ABS does not function if battery is discharged or battery power supply malfunction. (Light will come on)

21 . ANTI-LOCK BRAKE SYSTEM (ABS)

Parts Location

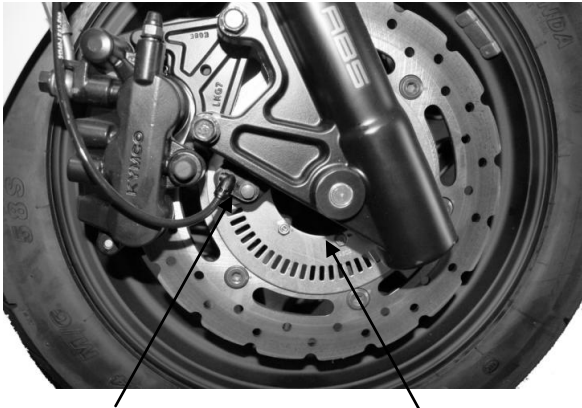

Front Wheel speed Sensor Front Wheel speed Sensor Rotor

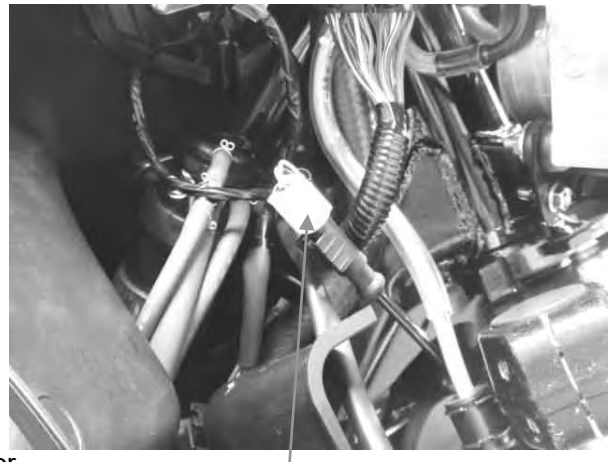

Front Wheel speed Sensor's connector

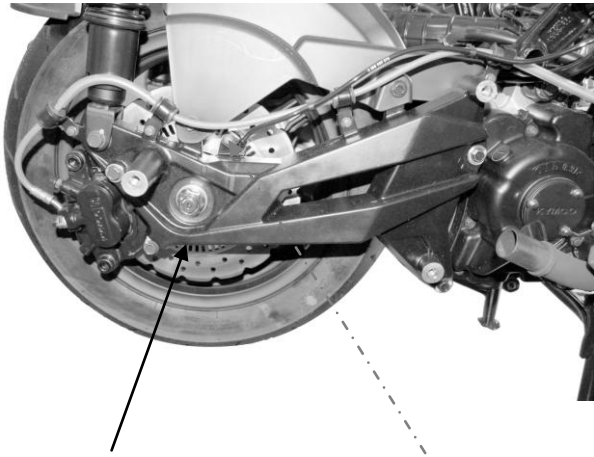

Front Wheel speed Sensor Rotor Rear Wheel speed Sensor



Rear Wheel speed Sensor's connector

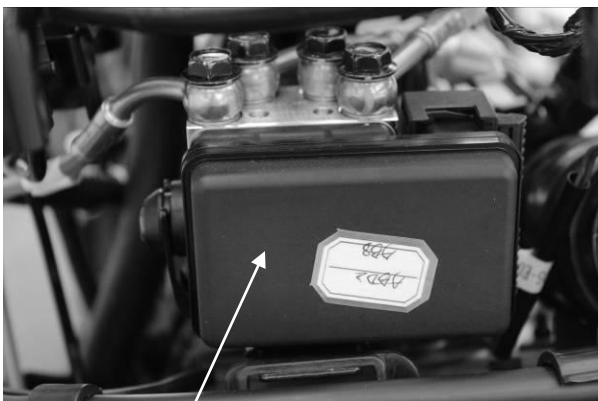

ABS ECU & ABS Hydraulic Unit

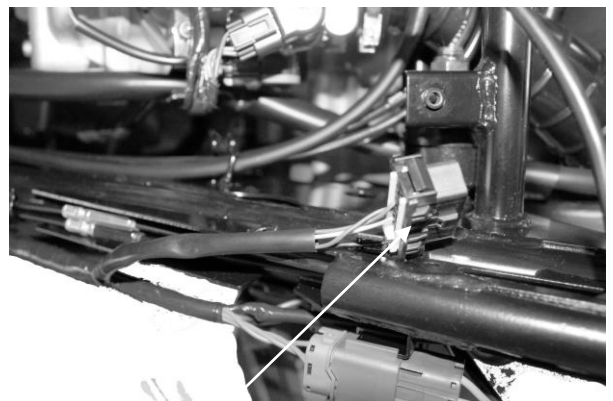

ABS diagnosis tool Connector (Near battery position)

21 . ANTI-LOCK BRAKE SYSTEM (ABS)

WHEEL SENSOR

REMOVAL & INSPECTION

Remove the front wheel speed sensor.

Install the front wheel speed sensor.

Front Wheel Speed Sensor



Front Wheel Speed Sensor Rotor

Remove a bolt attaching to the front wheel speed sensor

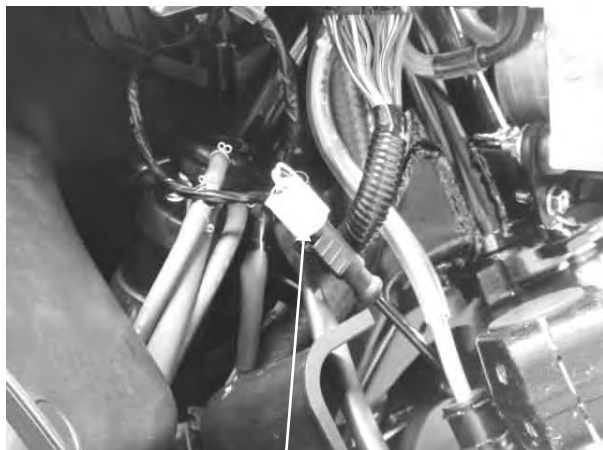

Front Wheel speed Sensor's connector

Remove the connector of front wheel speed sensor

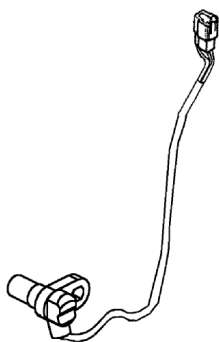

<Front Wheel Speed Sensor>

※ **Standard clearance:** Less than 0.8mm between the Front wheel speed sensor and Front Wheel Speed Sensor Rotor

21 . ANTI-LOCK BRAKE SYSTEM (ABS)

Remove the rear wheel speed sensor.

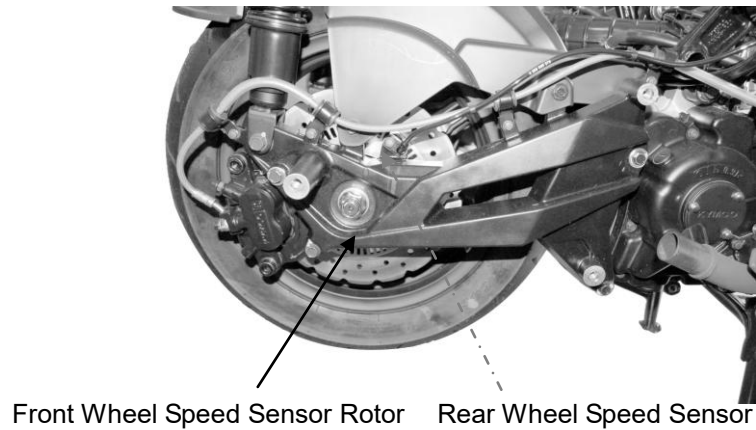

Remove the connector of rear wheel speed sensor

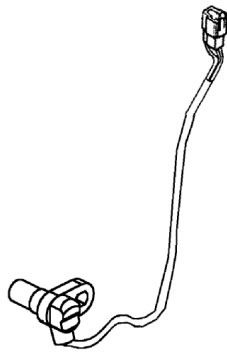

<Rear Wheel Speed Sensor>



※ **Standard clearance: Less than 0.8mm between the Front wheel speed sensor and Front Wheel Speed Sensor Rotor**

21 . ANTI-LOCK BRAKE SYSTEM (ABS)

ABS ECU REMOVAL& INSTALLATION

The coupler is used for automobile's waterproof. Please take care of operation.

Please keep a good ventilating about ECU in order to prevent the ABS ECU from high temperature.

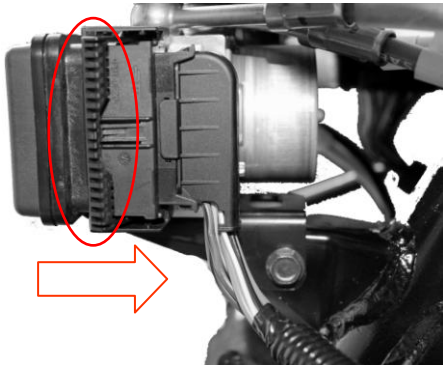

(一) Push upward

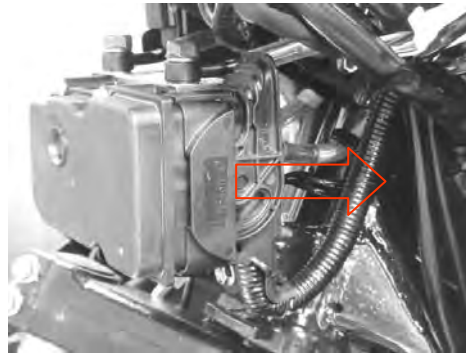

(二) Take right out

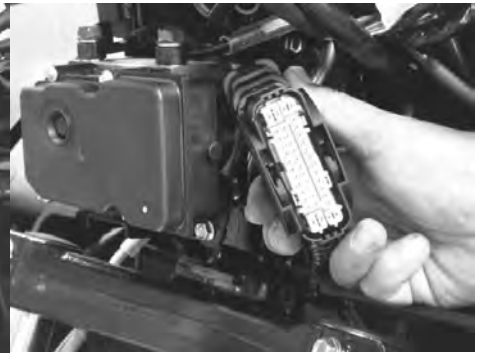

(三) Finished

ABS ECU & ABS Hydraulic Unit

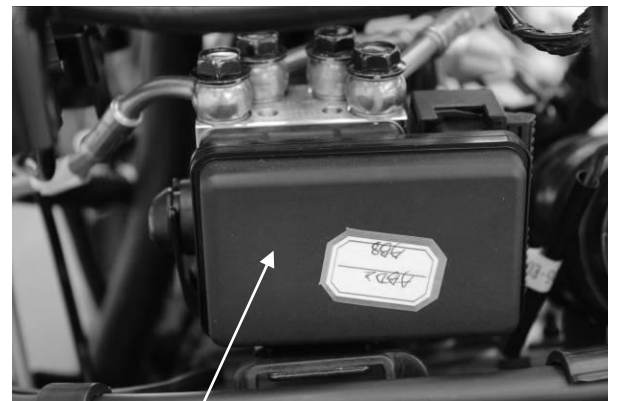

ABS ECU & ABS Hydraulic unit

Remove the screws attaching to the Hydraulic Unit.

To install the sensor is in the reverse order of removal.

(1)Oil boltsX4 Torque: 35N.m(3.5kgf.m)

(2)Nutx2:8N.m (0.8 kgf.m)

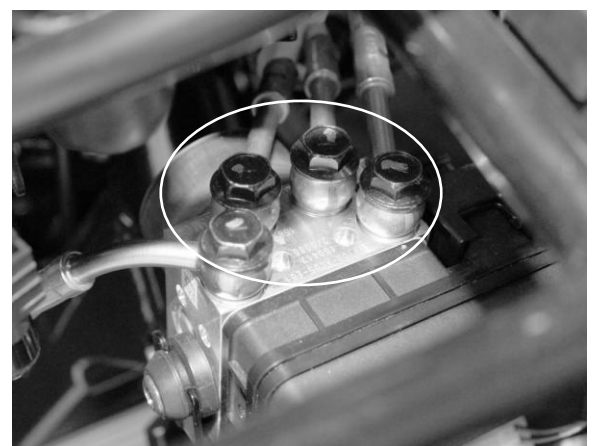

*** When replacing a new Hydraulic Unit, don't need to drain the brake fluid.**

21 . ANTI-LOCK BRAKE SYSTEM (ABS)

DIAGNOSTIC TOOL OPERATION

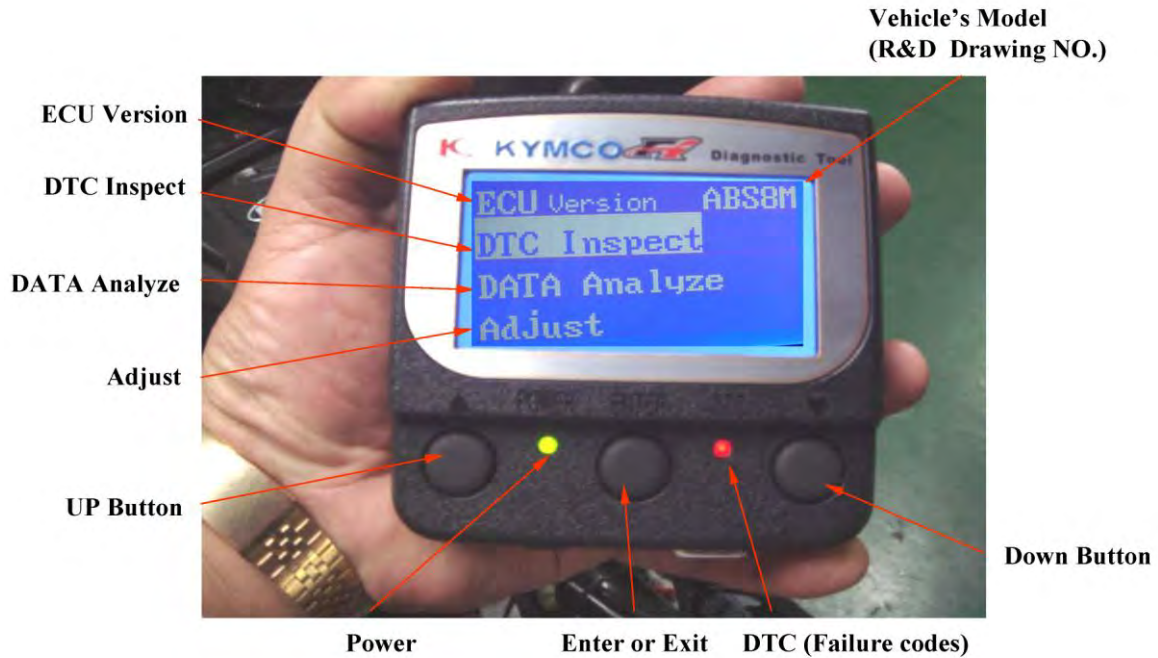

1. Connect the KYMCO Fi Diagnostic tool
2. Put the side stand upward and ENG. stop switch is at "RUN" position.
3. Connect the diagnostic tool connector. (KYMCO Fi Diagnostic tool Power comes from vehicle's Battery)



Self-Diagnostic Tool Connector

21 . ANTI-LOCK BRAKE SYSTEM (ABS)

4. Choose Fi ECU Version and then push down button for three times.



5. Choose No.2 ABS SYS ECU and then push up button to previous.

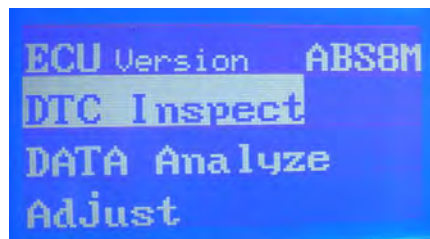
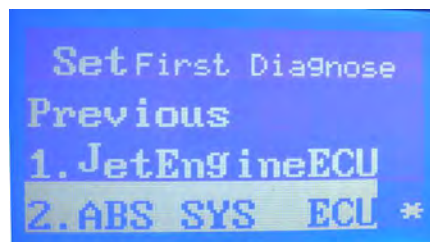

6. Confirming ECU Version and then enter ABS system.

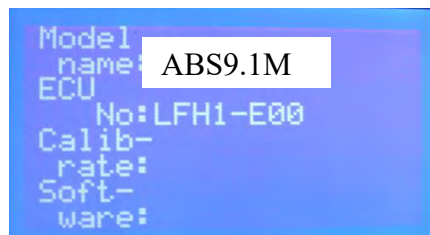

21 . ANTI-LOCK BRAKE SYSTEM (ABS)

7. Choose ECU Version and then push “Enter” button.

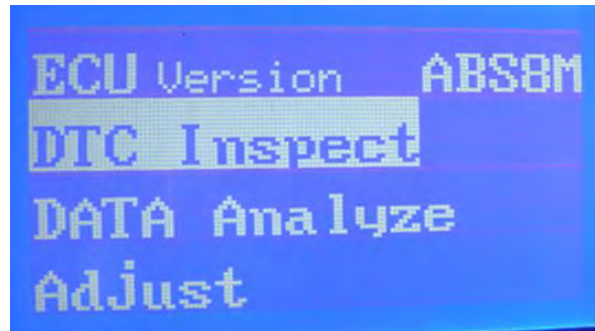

8. Confirm ABS ECU Version if is LEA7-E00

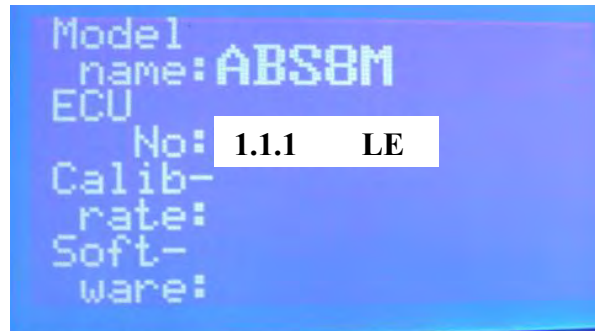

9. Choose DTC Inspect

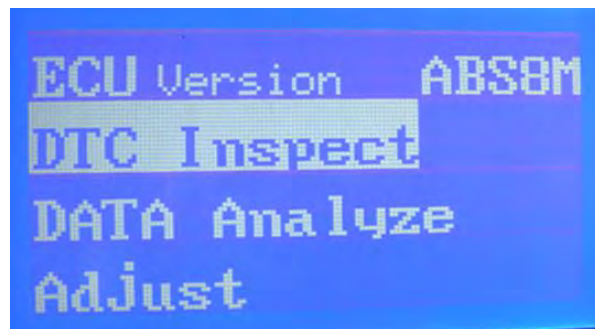

21 . ANTI-LOCK BRAKE SYSTEM (ABS)

10. Load DTC (Active 、 Occurred 、 History)

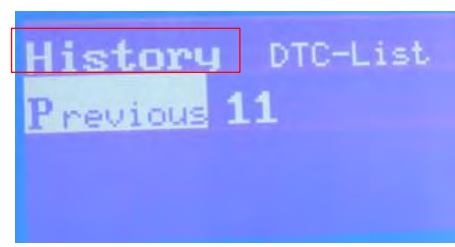
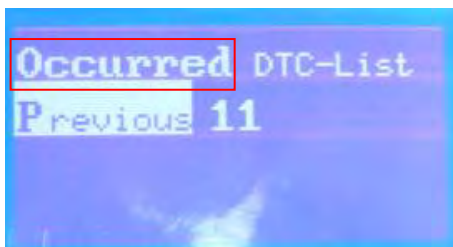
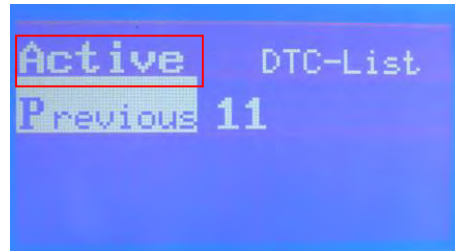
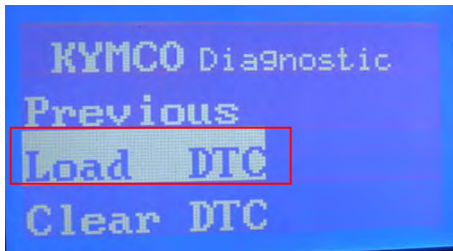

DTC DISPLAYED

1. Rear wheel speed sensor disconnect

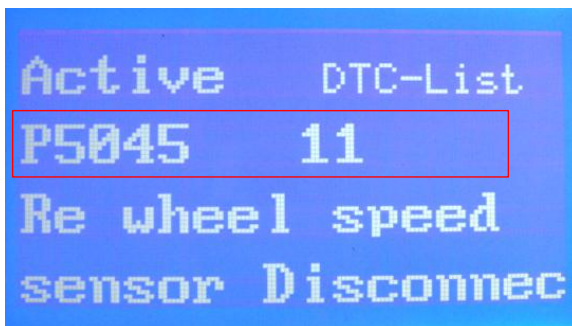

2. Front wheel speed sensor disconnect

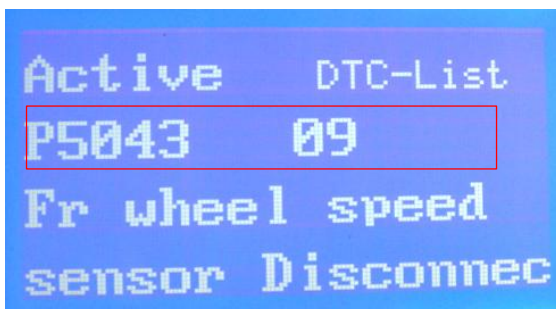

21 . ANTI-LOCK BRAKE SYSTEM (ABS)

DTC CLEARED

1. Choose “Clear DTC” and then push “Enter” button.

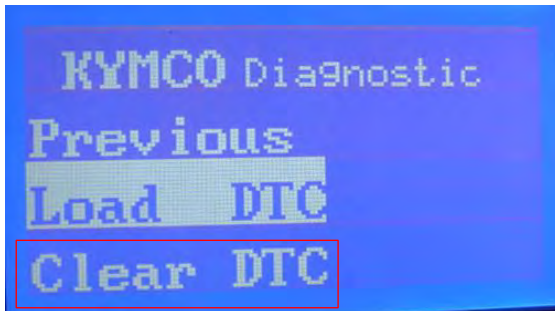

2. Clearing DTC completed until the DTC red lamp is off.



DATA ANALYZE

1. Choose “DATA Analyze” and then push “Enter” button

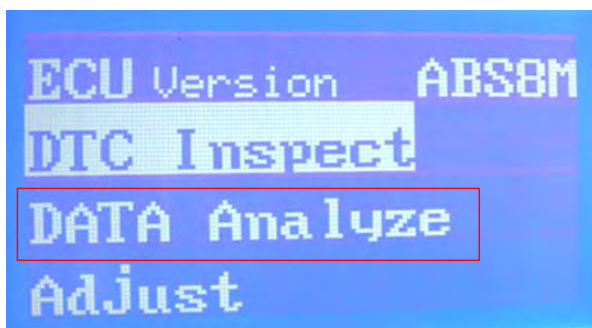

21 . ANTI-LOCK BRAKE SYSTEM (ABS)

2. Front wheel speed & Rear wheel speed & Battery volt

Battery volt: Standard 9.6~16.7V

KYMCO Diagnosis 01

Fr Speed 5 km/hr

Re Speed 5 km/hr

Battery Volt 12.6V

* You can turn the front or rear wheel to check if the wheel speed is figured.

21 . ANTI-LOCK BRAKE SYSTEM (ABS)

Bosch ABS8m DTC List

Bosch ABS8m DTC LIST		
Code NO (Diagnostic Tool) 3620A-LEB2- E00	DTC (PDA)	description
01	5013	Rear Inlet Valve malfunction (EV)
02	5014	Rear Outlet Valve malfunction (AV)
03	5017	Front Inlet Valve malfunction (EV)
04	5018	Front Outlet Valve malfunction (AV)
05	5019	Valve Relay malfunction (Failsafe relay)
06	5025	Deviation between Wheel speeds (WSS GENERIC)
07	5035	Pump Motor malfunction
08	5042	Front wheel speed sensor malfunction-Plausibility
09	5043	Front wheel speed sensor Disconnection/gnd Short/U z Short
10	5044	Rear wheel speed sensor malfunction - Plausibility
11	5045	Rear wheel speed sensor Disconnection/gnd Short/U z Short
12	5052	Power Supply malfunction (Under Voltage)
13	5053	Power Supply malfunction (Over Voltage)
14	5055	ECU malfunction