

**By KWANG YANG Motor Co., Ltd.
1st Edition, Aug. 2012
All rights reserved. Any reproduction or
unauthorized use without the written
permission of KWANG YANG Motor Co., Ltd.
is expressly prohibited.
T100-LKG5-A1**

PREFACE

This Service Manual describes the technical features and servicing procedures for the KYMCO **K-XCT 125i**.

Section 1 contains the precautions for all operations stated in this manual. Read them carefully before any operation is started.

Section 2 is the removal/installation procedures for the frame covers which are subject to removal/installation frequency during maintenance and servicing operations.

Section 3 describes the inspection/adjustment procedures, safety rules and service information for each part, starting from periodic maintenance.

Sections 5 to 11 give instructions for disassembly, assembly and adjustment of engine parts. Section 13-14 is the AFI system. Section 15 to 16 is the removal/ installation of chassis. Section 17 to 20 states the testing and measuring methods of electrical equipment.

Most sections start with an assembly or system illustration and troubleshooting for the section. The subsequent pages give detailed procedures for the section.

The information and contents included in this manual may be different from the motorcycle in case specifications are changed.

KWANG YANG MOTOR CO., LTD.
QUALITY TECHNOLOGY DEPT.
EDUCATION SECTION

TABLE OF CONTENTS

ENGINE	GENERAL INFORMATION	1
	EXHAUST MUFFLER/FRAME COVERS	2
	INSPECTION/ADJUSTMENT	3
	LUBRICATION SYSTEM	4
	ENGINE REMOVAL/INSTALLATION	5
	CYLINDER HEAD/VALVES	6
	CYLINDER/PISTON	7
	DRIVE AND DRIVEN PULLEYS	8
	FINAL REDUCTION	9
	A.C. GENERATOR/STARTER CLUTCH	10
	CRANKCASE/CRANKSHAFT	11
	COOLING SYSTEM	12
	Fi DIAGNOSTIC TOOL OPERATION	13
	FUEL INJECTION SYSTEM	14
CHASSIS	HANDLEBAR/FRONT WHEEL/FRONT BRAKE/FRONT SHOCK ABSORBER/STEERING STEM	15
	REAR BRAKE/REAR FORK/REAR WHEEL/REAR SHOCK ABSORBER	16
ELECTRICAL EQUIPMENT	BATTERY/CHARGING SYSTEM	17
	IGNITION SYSTEM	18
	STARTING SYSTEM	19
	LIGHTS/METERS/SWITCHES	20

1. GENERAL INFORMATION



GENERAL INFORMATION

SERIAL NUMBER	1-1
SPECIFICATION	1-2
SERVICE PRECAUTIONS	1-3
TORQUE VALUES	1-8
SPECIAL TOOLS	1-10
LUBRICATION POINTS	1-12
TROUBLESHOOTING	1-14

1. GENERAL INFORMATION

Identification Numbers Record

Identification Numbers Record

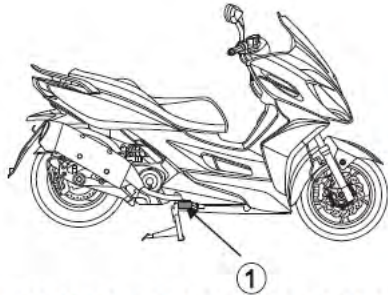

1. VEHICLE IDENTIFICATION NUMBER (VIN)

2. ENGINE SERIAL NUMBER (ESN)

3. FRAME SERIAL NUMBER (VIN)

Record the Vehicle Identification Number ①, Engine Serial Number ② and Frame Serial Number ③ in the boxes above for future reference (to assist you in ordering parts from your authorized KYMCO dealer or for reference in case the vehicle is stolen).

1. GENERAL INFORMATION

SPECIFICATIONS

Oil filter type	Full-flow filtration	
Oil capacity	1.2 liter	
Exchanging capacity	1.0 liter	
Fi injection system		
Air cleaner type & No	Paper element, wet	
Fuel capacity	10 liters	
Brand	Synerject	
Throttle Body	Butterfly type	
Venturi diameter (mm)	27	
Fuel pump pressure	3 bar	
Electrical system		
Ignition type	ECU	
Ignition timing	4° ~ 32°	
Spark plug	CR7E	
Spark plug gap	0.7mm	
Battery Capacity	12V10AH	
Transmission system		
Clutch type	Dry multi-disc	
Transmission type	CVT	
Operation type	Auto centrifugal	
Reduction gear type	Two-stage reduction	
Reduction ratio	1 st	0.83 ~ 2.2
	2 nd	10.41
Moving device		
Tire type	Tubeless	
Tire spec.	Front wheel	120/70-14
	Rear wheel	150/70-13
Tire pressure (kg/cm ²)	Front wheel	2.0
	Rear wheel	2.25
Wheel material	Aluminium	
Turning angle	Left	40°
	Right	40°
Brake type	Front	Disk brake
	Rear	Disk brake
Damping Device		
Suspension type	Front	Telescope
	Rear	Swing arm
Shock absorber stroke	Front	110 mm
	Rear	93 mm

Name	K-XCT 125i	
Model No.	SK25BA	
Overall length	2120 mm	
Overall width	785 mm	
Overall height	1280 mm	
Wheel base	1450 mm	
Engine type	4 stroke O.H.C.	
Displacement	124.8 cc	
Fuel Used	92# nonleaded gasoline above	
Curb weight (kg)	Front wheel	-
	Rear wheel	-
	Total	157
Max. weight capacity (kg)	Front wheel	-
	Rear wheel	-
	Total	247
Ground clearance (mm)	140	
Braking distance (m)	7.9m / 40 km/hr	
Min. turning radius (mm)	2450	
Engine part		
Starting system	Starting motor	
Type	Gasoline 4-cycle	
Cylinder arrangement	Single cylinder	
Combustion chamber type	Semi-sphere	
Valve arrangement	O.H.C.4V	
Bore x stroke (mm)	φ 54 * 54.5	
Compression ratio	11.2:1	
Compression pressure (kg/cm ²)	15	
Max. output (ps/rpm)	10.6 / 9000	
Max. torque (kg-m/rpm)	12.0 / 7000	
Intake Timing	Open	8° BTDC
	Close	31° BTDC
Exhaust Timing	Open	6° BTDC
	Close	32° BTDC
Valve clearance	Intake	0.10
	Exhaust	0.10
Idle speed (rpm)	1800±100 rpm	
Cooling Type	Liquid cooling	
Lubrication type	Forced pressure & wet sump	
Oil pump type	Inner/outer rotor	

1. GENERAL INFORMATION

SERVICE PRECAUTIONS

- Make sure to install new gaskets, O-rings, circlips, cotter pins, etc. when reassembling.

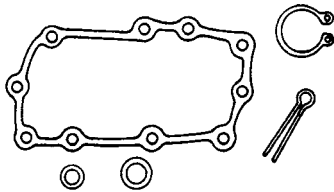

- When tightening bolts or nuts, begin with larger-diameter to smaller ones at several times, and tighten to the specified torque diagonally.

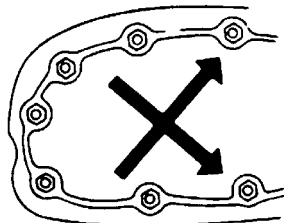

- Use genuine parts and lubricants.

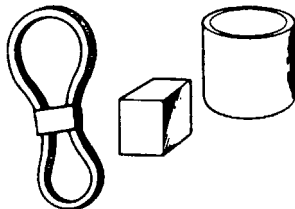

- When servicing the motorcycle, be sure to use special tools for removal and installation.

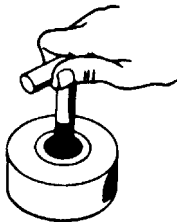

- After disassembly, clean removed parts. Lubricate sliding surfaces with engine oil before reassembly.

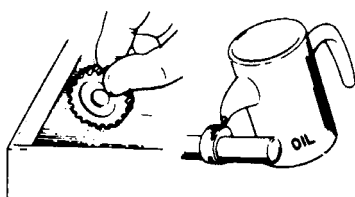

- Apply or add designated greases and lubricants to the specified lubrication points.

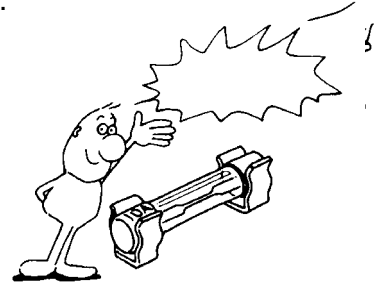

- When two persons work together, pay attention to the mutual working safety.

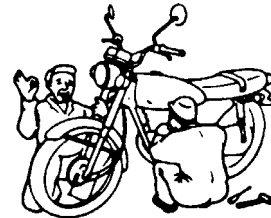

- Disconnect the battery negative (-) terminal before operation.
- When using a spanner or other tools, make sure not to damage the motorcycle surface.

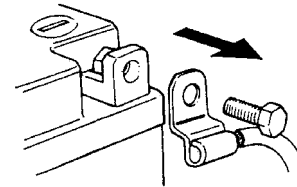

- After operation, check all connecting points, fasteners, and lines for proper connection and installation.
- When connecting the battery, the positive (+) terminal must be connected first.
- After connection, apply grease to the battery terminals.
- Terminal caps shall be installed securely.

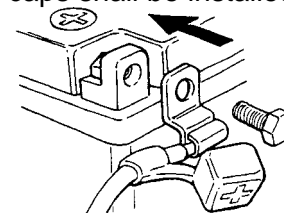

- If the fuse is burned out, find the cause and repair it. Replace it with a new one according to the specified capacity.

1. GENERAL INFORMATION

- After operation, terminal caps shall be installed securely.

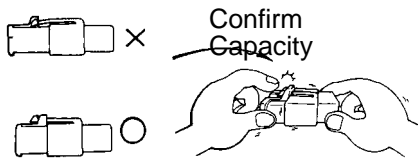

- When taking out the connector, the lock on the connector shall be released before operation.

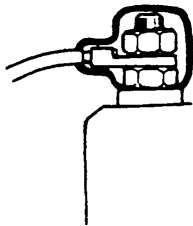

- Hold the connector body when connecting or disconnecting it.
- Do not pull the connector wire.

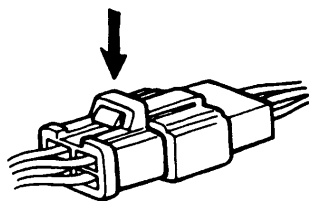

- Check if any connector terminal is bending, protruding or loose.



- The connector shall be inserted completely.
- If the double connector has a lock, lock it at the correct position.
- Check if there is any loose wire.

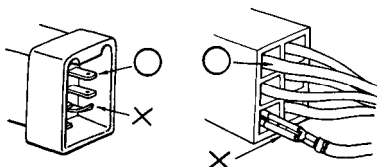

- Before connecting a terminal, check for damaged terminal cover or loose negative terminal.

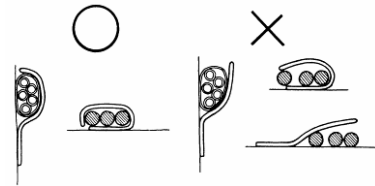

- Check the double connector cover for proper coverage and installation.

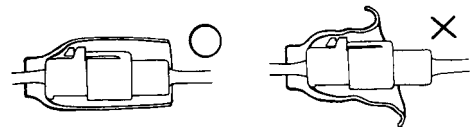

- Insert the terminal completely.
- Check the terminal cover for proper coverage.
- Do not make the terminal cover opening face up.

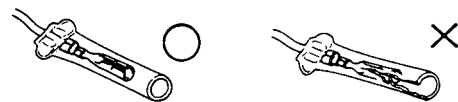

- Secure wire harnesses to the frame with their respective wire bands at the designated locations. Tighten the bands so that only the insulated surfaces contact the wire harnesses.

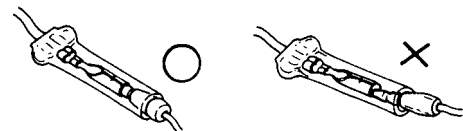

- After clamping, check each wire to make sure it is secure.

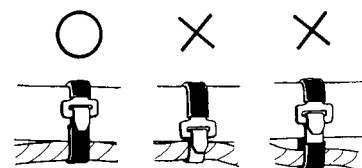

1. GENERAL INFORMATION

- Do not squeeze wires against the weld or its clamp.

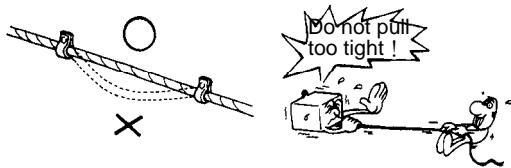

- After clamping, check each harness to make sure that it is not interfering with any moving or sliding parts.

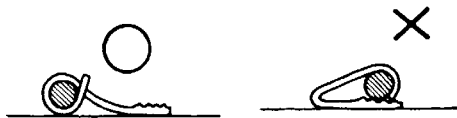

- When fixing the wire harnesses, do not make it contact the parts that will generate high heat.

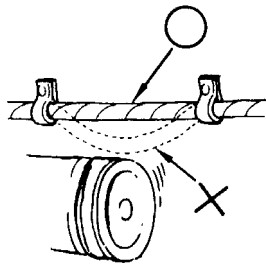

- Route wire harnesses to avoid sharp edges or corners. Avoid the projected ends of bolts and screws.
- Route wire harnesses passing through the side of bolts and screws. Avoid the projected ends of bolts and screws.

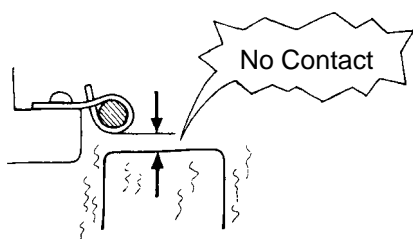

- Route harnesses so they are neither pulled tight nor have excessive slack.

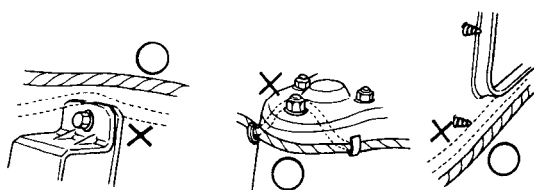

- Protect wires and harnesses with electrical tape or tube if they contact a sharp edge or corner.

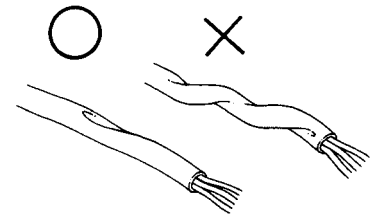

- When rubber protector cover is used to protect the wire harnesses, it shall be installed securely.

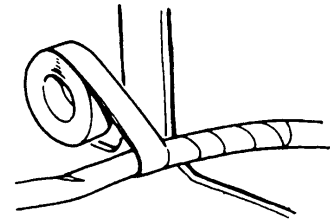

- Do not break the sheath of wire.
- If a wire or harness is with a broken sheath, repair by wrapping it with protective tape or replace it.

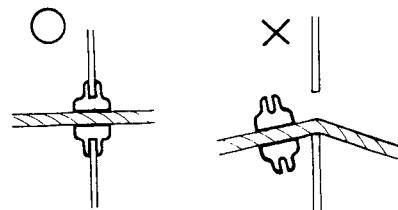

- When installing other parts, do not press or squeeze the wires.

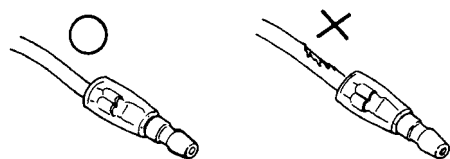

- After routing, check that the wire harnesses are not twisted or kinked.

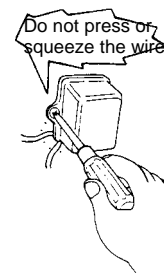

1. GENERAL INFORMATION

- Wire harnesses routed along with handlebar should not be pulled tight, have excessive slack or interfere with adjacent or surrounding parts in all steering positions.

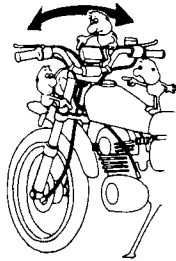

- When a testing device is used, make sure to understand the operating methods thoroughly and operate according to the operating instructions.

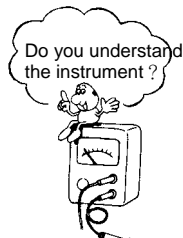

- Be careful not to drop any parts.

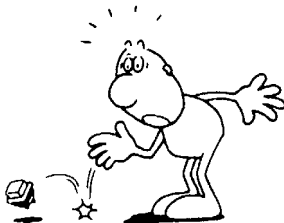

- When rust is found on a terminal, remove the rust with sand paper or equivalent before connecting.

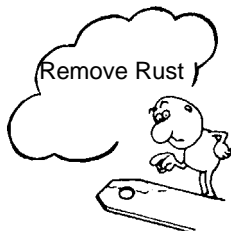

1. GENERAL INFORMATION

■ Symbols:

The following symbols represent the servicing methods and cautions included in this service manual.



Engine Oil

: Apply engine oil to the specified points. (Use designated engine oil for lubrication.)



Grease

: Apply grease for lubrication.



Gear Oil

: Transmission Gear Oil (90#)



: Use special tool.



: Caution



: Warning

1. GENERAL INFORMATION

TORQUE VALUES

STANDARD TORQUE VALUES

Item	Torque (kgf-m)	Item	Torque (kgf-m)
5mm bolt, nut	0.45~0.6	5mm screw	0.45~0.6
6mm bolt, nut	0.8~1.2	6mm screw, SH bolt	0.7~1.1
8mm bolt, nut	1.8~2.5	6mm flange bolt, nut	1.0~1.4
10mm bolt, nut	3.0~4.0	8mm flange bolt, nut	2.4~3.0
12mm bolt, nut	5.0~6.0	10mm flange bolt, nut	3.0~4.5

ENGINE

Item	Qty	Thread dia.(mm)	Torque (kgf-m)	Remarks
Cylinder head bolt A		6	0.7~1.1	
Cylinder head bolt B		6	0.7~1.1	
Oil filter screen cap		30	2.0~3.0	
O2 sensor		12	0.7~1.1	
Cylinder head cover		6	0.8~0.9	
Tappet adjusting hole cap		30	1.0~2.0	
Cam chain set plate		6	1.0~1.4	
Engine oil drain bolt		12	2.0~3.0	
Clutch outer nut		12	5.0~6.0	
Clutch drive plate nut		28	5.0~6.0	
Starter motor mounting bolt		6	0.8~1.2	
Oil pump bolt		6	0.7~1.1	
Drive face nut		12	5.5~6.5	
Spark plug		10	1.0~1.4	
A.C. Generator flywheel		12	5.0~6.0	
Cam chain tensioner pivot		6	0.8~1.2	

1. GENERAL INFORMATION

TORQUE VALUES FRAME

FRAME					
Item	Qty	Thread size (mm)	Torque		Remarks
			kgf-m	lb-ft	
Steering:					
1. Stem lock nut	1	BC1	6.0-8.0	43.40-57.86	
2. Handle post bolt	1	10	4.0-5.0	28.93-36.17	U-nut
3. Bridge bolt	1	8	2.4-3.0	17.36-21.70	
4. Race nut (head)	1	BC1	1.8-2.2	13.02-15.91	
Brake:					
1. Front/Rear caliper bolt	1	10	3.0-4.0	21.70-28.93	
2. Brake hose bolt	1	10	3.0-4.0	21.70-28.93	
3. Disk bolt	5	8	3.2-3.8	23.15-27.48	
Engine hanger:					
1. Frame side	2	14	6.0-7.0	43.40-50.63	U-nut
2. Engine side	1	10	4.5-5.5	32.55-39.78	U-nut
Rear fork bolt	2	10	3.0-4.0	21.70-28.93	
Speed sensor cable	1	6	1.0-1.4	7.23-10.13	
O2 sensor	1	12	2.0-3.0	14.47-21.70	
Rear carrier	4	8	2.0-2.8	14.47-20.25	
Front axle	1	14	1.5-2.5	10.84-18.08	
Rear axle nut	1	16	11-13	79.56-94.03	U-nut
Rear cushion upper/lower bolt	1	10	3.5-4.5	25.32-32.55	
Suspension:					
Shock absorber mounting bolt			4	28.93	
Fuel Pump Bolts	6		0.35	2.5	

1. GENERAL INFORMATION



SPECIAL TOOLS

Tool Name	Tool No.	Illustration (Note: the special tools may differ slightly from those shown in the figure of this manual.)
Flywheel puller (Refer to the “ STARTER CLUTCH ” section in the chapter 10.)	A120E00003	
Oil seal and bearing installer	A120E00014	
Universal holder (Refer to the “ DRIVE PULLEY, DRIVE BELT AND DRIVEN PULLEY ” section in the chapter 8.)	A120E00017	
Flywheel holder (Refer to the “ STARTER CLUTCH ” section in the chapter 10.)	A120E00021	
Clutch spring compressor (Refer to the “ DRIVE PULLEY, DRIVE BELT AND DRIVEN PULLEY ” section in the chapter 8.)	A120E00034	
Valve adjuster (Refer to the “ VALVE CLEARANCE ” section in the chapter 3.)	A120E00036	

(Cont'd)

1. GENERAL INFORMATION

SPECIAL TOOLS

Tool Name	Tool No.	Illustration (Note: the special tools may differ slightly from those shown in the figure of this manual.)
Bearing puller	A120E00037	
Valve spring compressor (Refer to the “ CYLINDER HEAD ” section in the chapter 6.)	A120E00040	
Lock nut wrench (Refer to the “ STEERING STEM ” section in the chapter 15.)	A120F00023	
Lock nut wrench (Refer to the “ STEERING STEM ” section in the chapter 15.)	A120F00002	
Bottom Ball Race Remove special tool/ Top Ball Cone Race Remove special tool (Refer to the “ STEERING STEM ” section in the chapter 15.)	A120F00009	
Bottom Ball Race Install special tool Top Ball Cone Race Install special tool (Refer to the “ STEERING STEM ” section in the chapter 15.)	A120F00019	

1. GENERAL INFORMATION

LUBRICATION POINTS

FRAME

The following is the lubrication points for the frame.

Use grease for parts not listed.

Apply engine oil or grease to cables and movable parts not specified. It will avoid abnormal noise and damage the durability of the motorcycle.

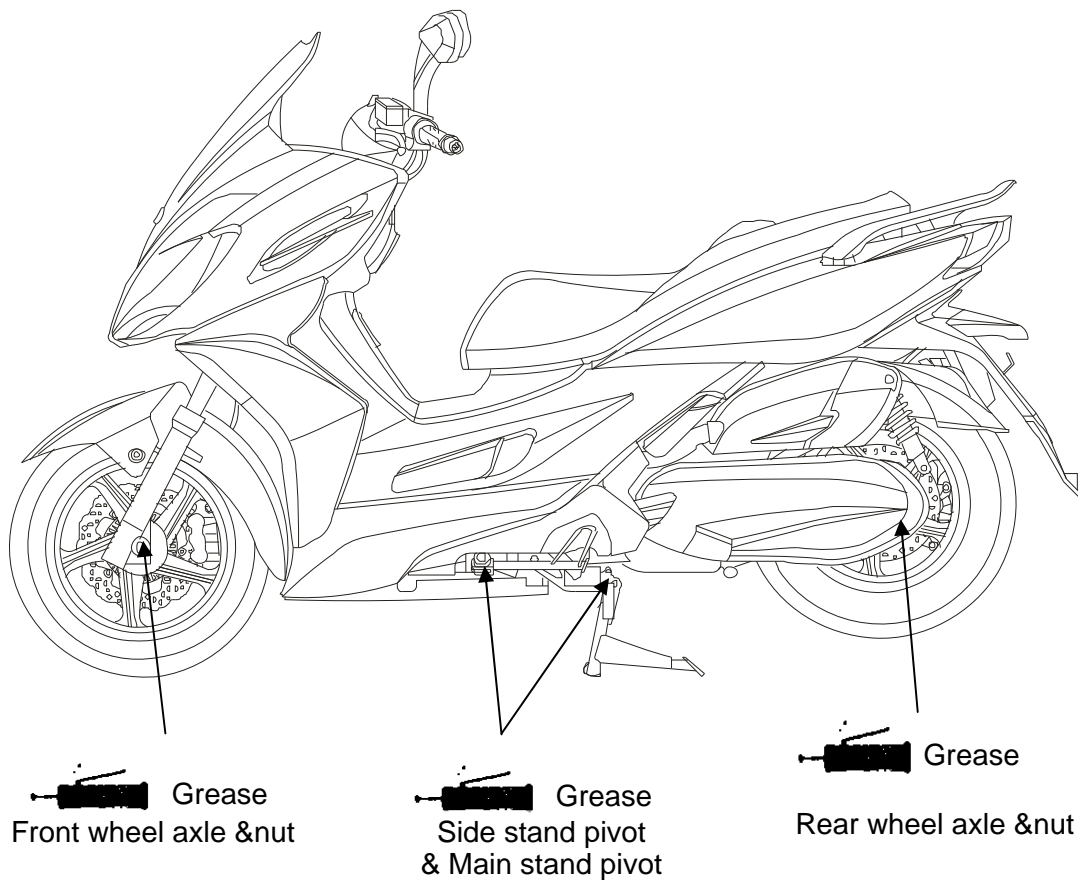

1. GENERAL INFORMATION

ENGINE

Lubrication Points	Lubricant
Valve guide/valve stem movable part Cam lobes Valve rocker arm friction surface Cam chain Cylinder lock bolt and nut Piston surroundings and piston ring grooves Piston pin surroundings Cylinder inside wall Connecting rod/piston pin hole Connecting rod big end Crankshaft R/L side oil seal Starter reduction gear engaging part Countershaft gear engaging part Final gear engaging part Bearing movable part O-ring face Oil seal lip	<ul style="list-style-type: none"> •Genuine KYMCO Engine Oil (SAE15W-40) •API , SJ Engine Oil
Starter idle gear Friction spring movable part/shaft movable part Shaft movable grooved part	High-temperature resistant grease
A.C. generator connector Transmission case breather tube	Adhesive

1. GENERAL INFORMATION

TROUBLESHOOTING

ENGINE WILL NOT START OR IS HARD TO START

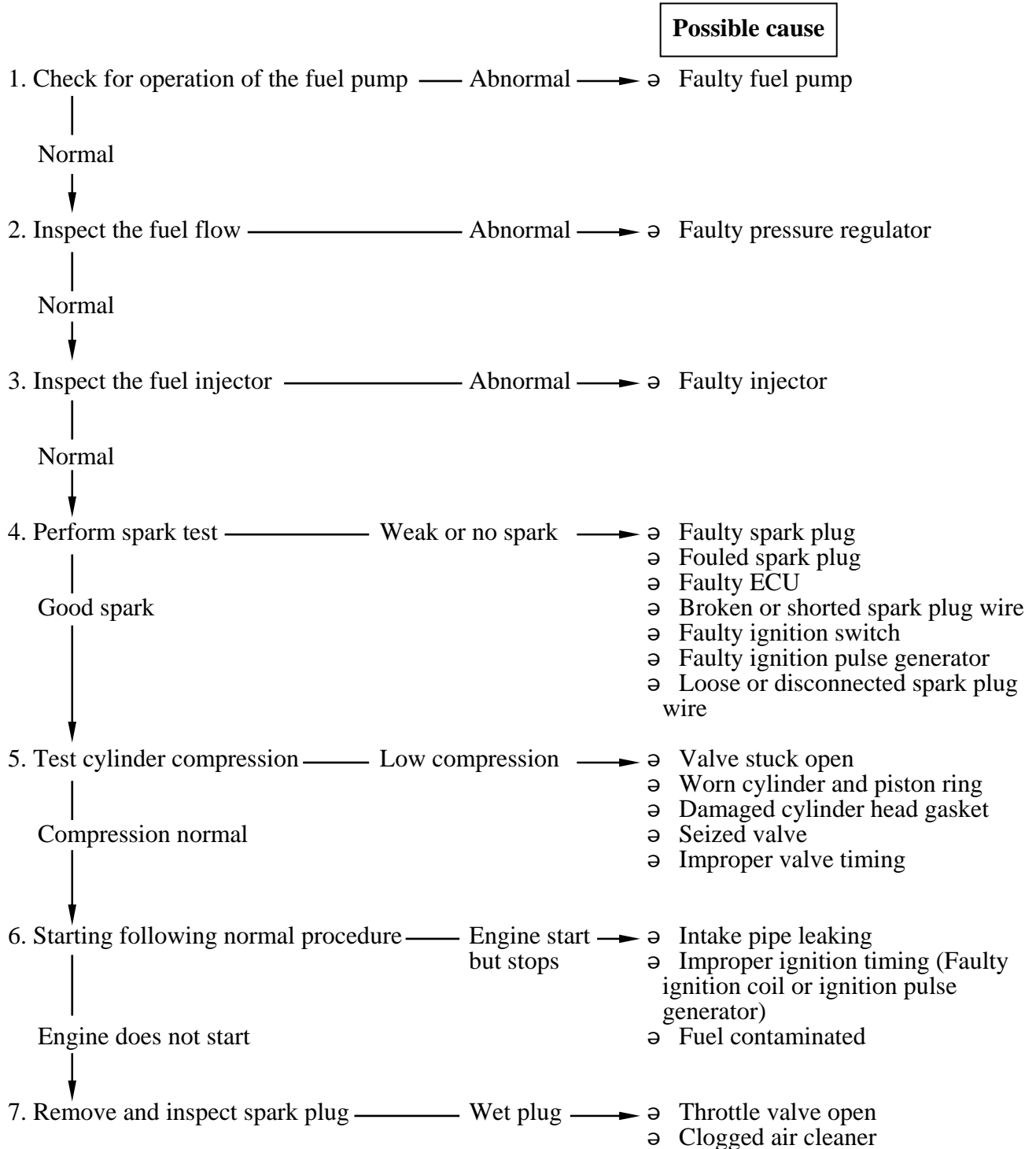

1. GENERAL INFORMATION

ENGINE LACKS POWER

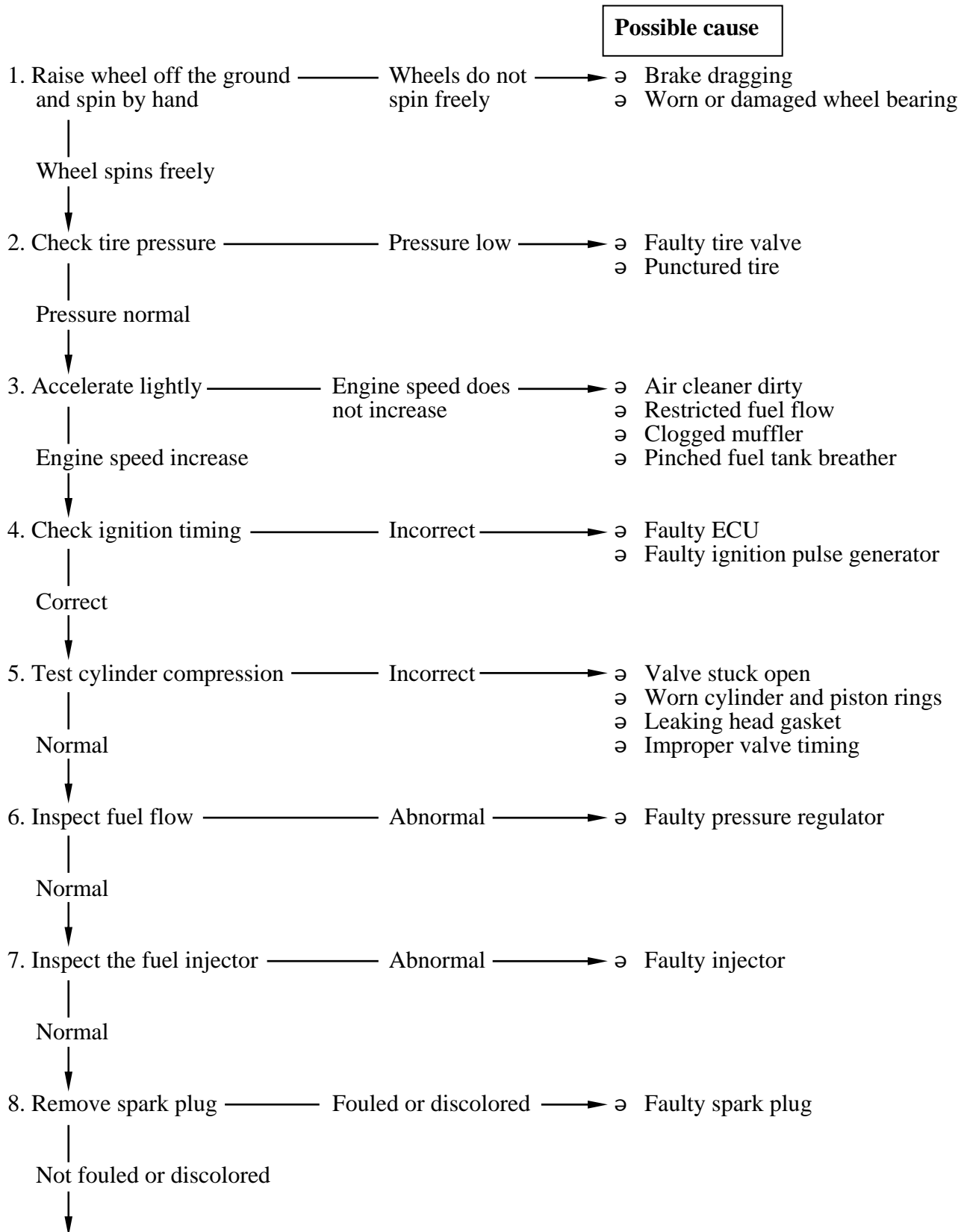

1. GENERAL INFORMATION

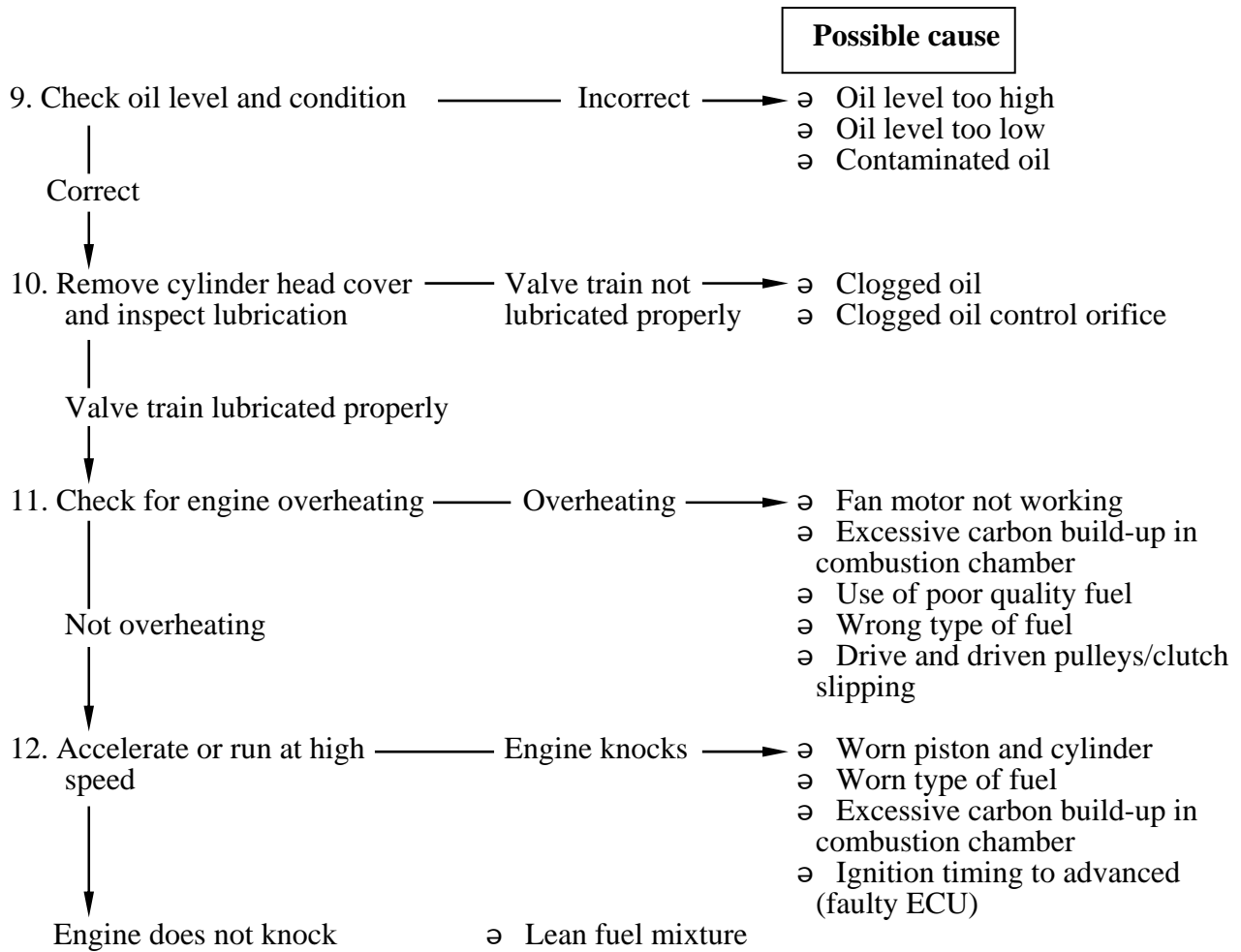

1. GENERAL INFORMATION

POOR PERFORMANCE AT LOW AND IDLE SPEED

Possible cause

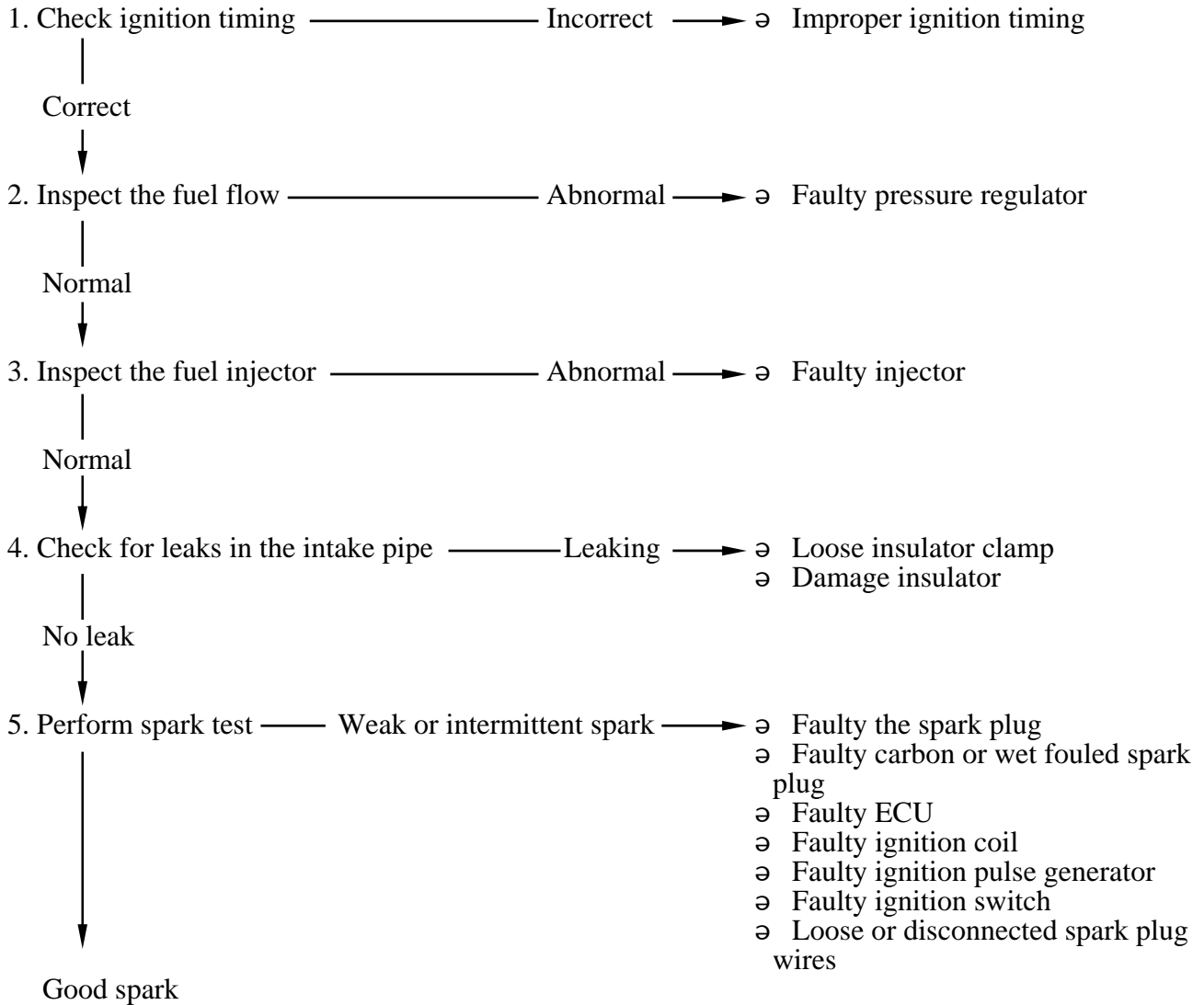

1. GENERAL INFORMATION

POOR PERFORMANCE AT HIGH SPEED

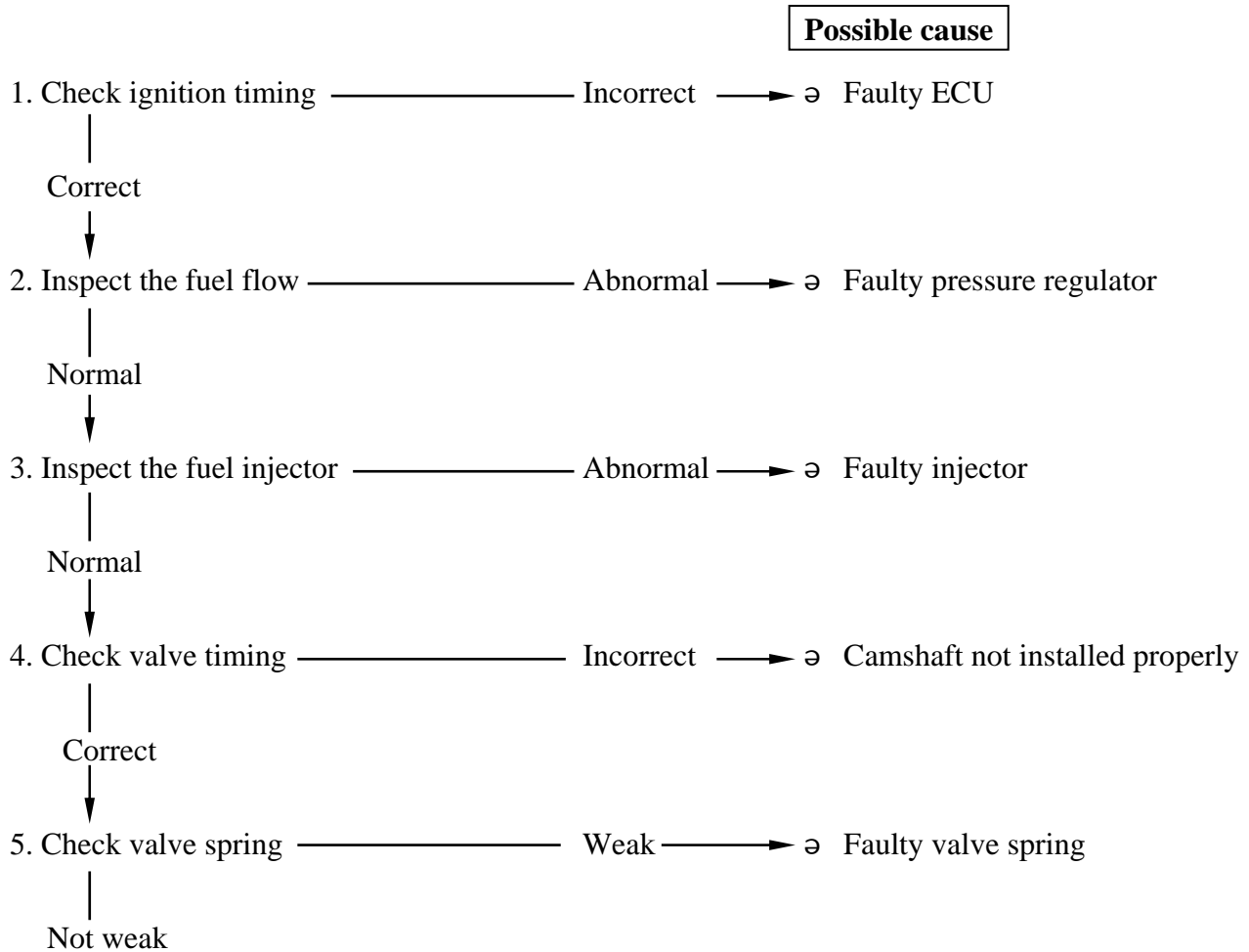

POOR HANDLING

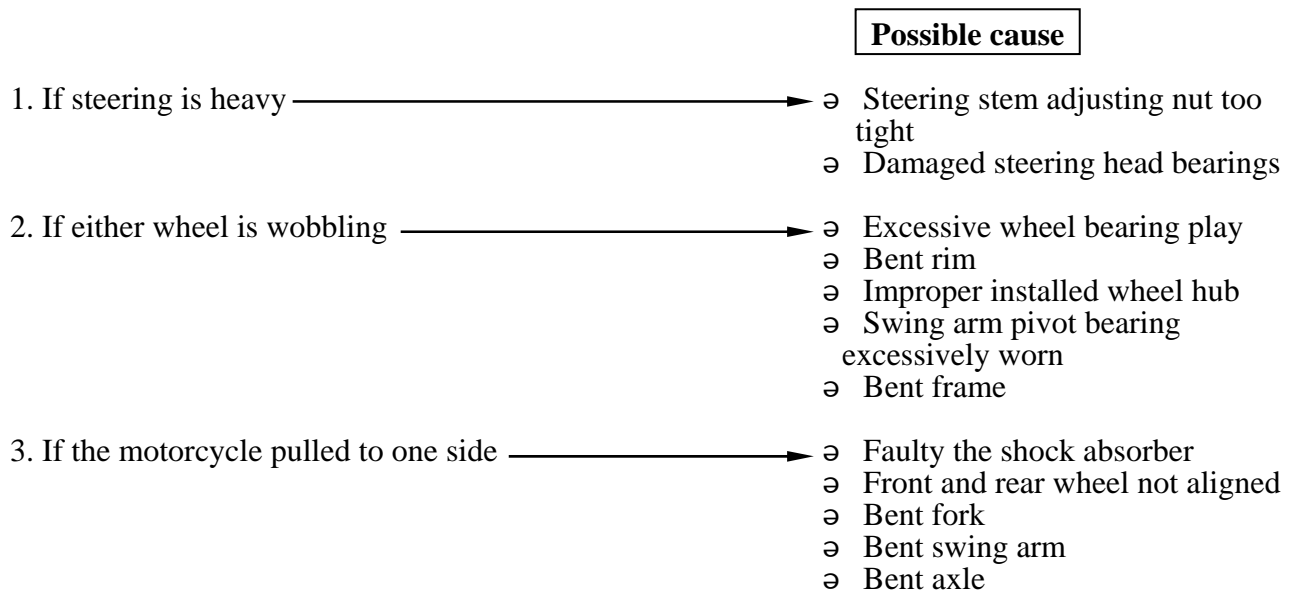

2. EXHAUST MUFFLER/FRAME COVERS

2

EXHAUST MUFFLER/FRAME COVERS

- Exhaust System1-2~1-13
- Luggage Box.....1-14~1-16
- Seat.....1-17~1-19
- Rear Carrier1-20~1-22
- Body Cover1-23~1-32
- Windshield1-33~1-36
- Front Cover Meter1-37~1-38
- Side Molding A.....1-39~1-48
- Side Cover1-49~1-59
- Front Fender1-60~1-63
- Center Cover.....1-64~1-66
- Under Cover.....1-67~1-68
- Rear Meter Cover.....1-69~1-72
- Floorboard1-73~1-78
- Leg Shield1-79~1-83
- Handle Cover1-84~1-89
- Rear Tire Fender1-90~1-94
- Stands1-95~1-99

2. EXHAUST MUFFLER/FRAME COVERS

SERVICE INFORMATION

GENERAL INSTRUCTIONS

- When removing frame covers, use care not to pull them by force because the cover joint claws may be damaged.
- Make sure to route cables and harnesses according to the Cable & Harness Routing.

TORQUE VALUES

Exhaust muffler pipe nuts	1.8~2.2 kgf-m
Exhaust muffler brake /RR Fork	3.2~3.8 kgf-m
RR/Engine case	3.0~4.0 kgf-m

TROUBLESHOOTING

Noisy exhaust muffler

- Damaged exhaust muffler
- Exhaust muffler joint air leaks

Lack of power

- Caved exhaust muffler
- Clogged exhaust muffler
- Exhaust muffler air leaks

2. EXHAUST MUFFLER/FRAME COVERS

Exhaust System

General Instructions

- When removing frame covers, use care not to pull them by force because the cover joint claws may be damaged.
- Make sure to route cables and harnesses according to the Cable & Harness Routing.

Troubleshooting

Noisy exhaust muffler

- Damaged exhaust muffler
- Exhaust muffler joint air leaks

Lack of power

- Caved exhaust muffler
- Clogged exhaust muffler
- Exhaust muffler air leaks

Removal



2. EXHAUST MUFFLER/FRAME COVERS

●



Remove the two exhaust pipe joint nuts with a 12 mm deep well socket.



Remove the O2 sensor wire band.



Unplug the O2 sensor connector.

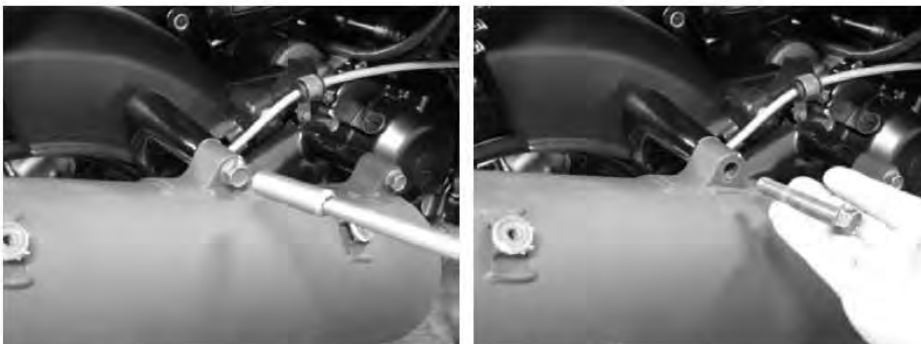

Remove the three muffler mounting bolts with a 14 mm socket.

2. EXHAUST MUFFLER/FRAME COVERS



Remove the exhaust system.



Remove the exhaust pipe gasket and discard it.

2. EXHAUST MUFFLER/FRAME COVERS

O2 Sensor

Removal



Remove the O² sensor with a 17 mm wrench. Use care not to pinch the wires.

The O² sensor issues signal to ECU when the temperature is over 350°C while the engine is running.

Test the O² sensor at room temperature.

Use a digital multimeter set to ohms of resistance to inspect the O² sensor.

2. EXHAUST MUFFLER/FRAME COVERS



Measure the resistance between the white wire terminals of the O² sensor connector.

Replace the O² sensor if the reading is out of specification.

ITEM	SPECIFICATIONS
O ² heater sensor resistance (at 20°C/68°F)	6.7 - 9.5 Ω (engine warming condition)

2. EXHAUST MUFFLER/FRAME COVERS

Heat Shields



Remove the muffler heat shield bolts.

2. EXHAUST MUFFLER/FRAME COVERS



To remove the four bolts to free the heat shield on the muffler.



Remove the heat shield.

2. EXHAUST MUFFLER/FRAME COVERS

Installation

Heat Shields



Install the heat shields and tighten the bolts securely.

O² Sensor



Apply anti-seize compound to the threads of the O² sensor. Install the O² sensor and tighten it to specification with a 17 mm wrench. Use care not to pinch the wires.

Item	Torque	
	N-m	lb-ft
O ² Sensor	25	18

2. EXHAUST MUFFLER/FRAME COVERS

Exhaust System



Insert a new exhaust pipe gasket into the exhaust port.

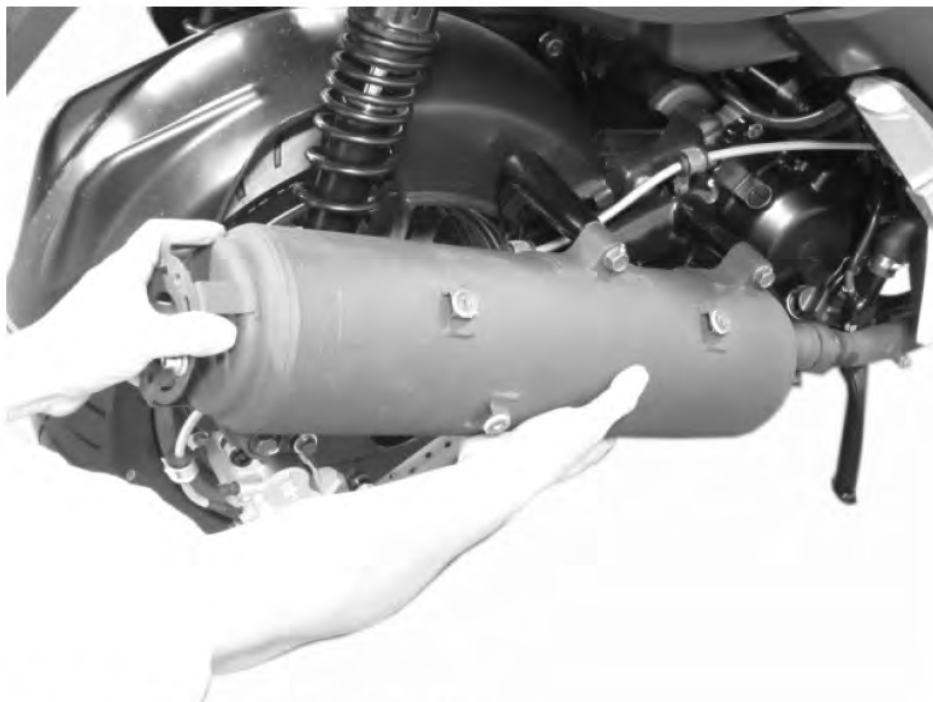

Fit the exhaust system into place

2. EXHAUST MUFFLER/FRAME COVERS



Install the two exhaust pipe joint nuts with a 12 mm deep well socket. Do not tighten.



Install the three muffer mounting bolts and tighten to specification with a socket.

Item	Torque	
	N-m	kgf-m
Muffer Mounting Bolts	35	3.5

2. EXHAUST MUFFLER/FRAME COVERS



Tighten the two exhaust pipe joint nuts to specification with a 12 mm deep well socket.

Item	Torque	
	N-m	kgf-m
Exhaust Pipe Joint Nuts	20	2

If the exhaust pipe and muffler were separated installed the muffler clamp securely.



Plug in the O² sensor.



Install a new O² sensor clamp.

2. EXHAUST MUFFLER/FRAME COVERS

Luggage Box

Removal



Remove the four luggage bolts with a 10 mm socket.



Remove the two luggage nuts with a 10 mm socket.

2. EXHAUST MUFFLER/FRAME COVERS



Lift up the luggage box to unplug the luggage box light connector.

Remove the luggage box.

Installation



Plug in the luggage box light connector.

Install the luggage box.



2. EXHAUST MUFFLER/FRAME COVERS



Install the four luggage bolts and tighten securely with a 10 mm socket.



Remove the two luggage nuts with a 10 mm socket.

Install the seat.

2. EXHAUST MUFFLER/FRAME COVERS

Seat

Removal



Insert the key and turn it counterclockwise.

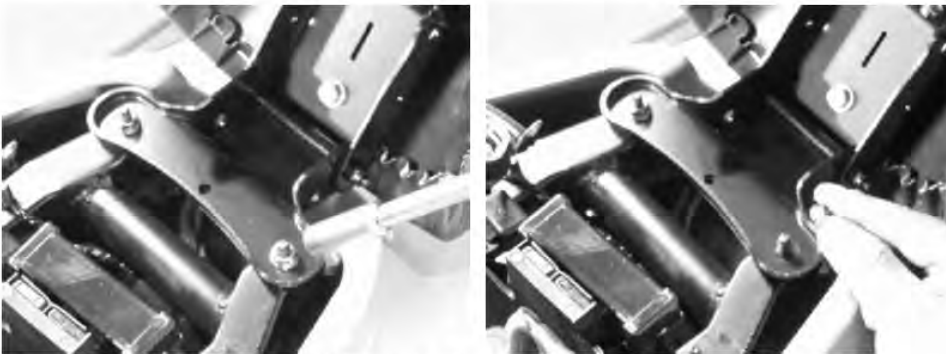

Remove the two seat hinge nuts with a 10 mm socket.

2. EXHAUST MUFFLER/FRAME COVERS

Seat Latch Cable



The seat latch cable runs from the ignition switch to the seat latches.

The cable must be adjusted periodically so that the latches will open correctly.

Open the seat.



Loosen the lock nuts and turn the adjusters as needed to adjust the seat latch cable operation.

There is one adjuster for each latch. Tighten the locknuts securely when finished.

2. EXHAUST MUFFLER/FRAME COVERS

Installation

Install the seat onto the hinge.



Install the two seat hinge nuts and tighten securely with a 10 mm socket.

2. EXHAUST MUFFLER/FRAME COVERS

Rear Carrier

Removal



Pry off the carrier bolt covers with a small flat blade screwdriver, the arrow mark indicates the pry point.

2. EXHAUST MUFFLER/FRAME COVERS

K-XCT 125i



Remove the four carrier bolts with a 6 mm Allen.



Remove the carrier each side.

2. EXHAUST MUFFLER/FRAME COVERS

Installation



Install the carrier.



Install the four carrier bolts on each side with a 6 mm Allen.



Push on the carrier bolt covers.

2. EXHAUST MUFFLER/FRAME COVERS

Body Cover

Removal



Remove the two rear center cover screws with a #2 Phillips.

2. EXHAUST MUFFLER/FRAME COVERS



Carefully unhook the tabs on both side of the rear center cover.

Remove the rear center cover.



Remove the four lower body cover nuts with a 10 mm socket.

2. EXHAUST MUFFLER/FRAME COVERS

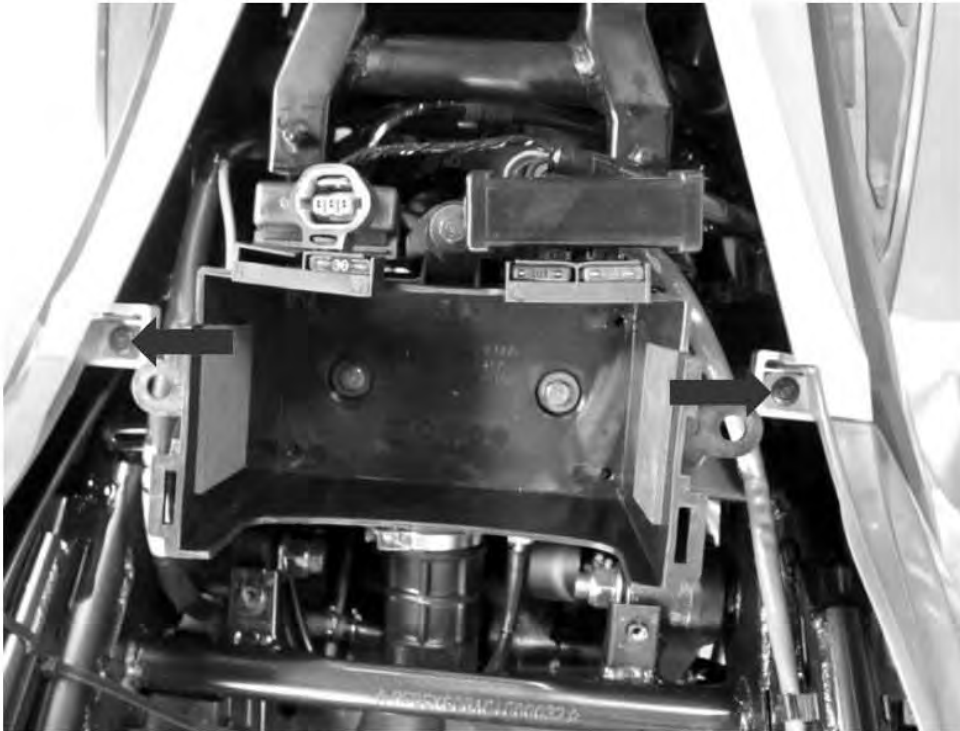

Remove the two plastic screws from the front of the body cover.



Carefully unhook the tabs on both sides of the body cover.

2. EXHAUST MUFFLER/FRAME COVERS

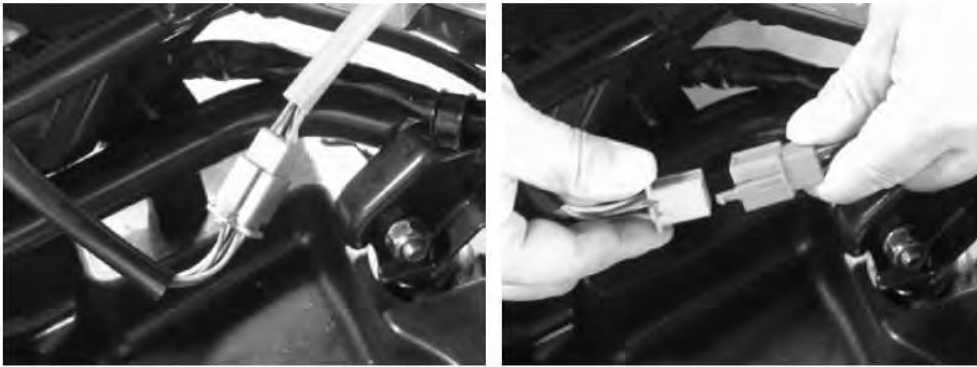

Unplug the taillight connector.



Remove the body cover.

2. EXHAUST MUFFLER/FRAME COVERS

Disassembly

Rear Center Molding



Remove the two Rear Center Molding screws with a #2 Phillips.
Remove the rear center molding.

2. EXHAUST MUFFLER/FRAME COVERS

Rear Fender



Remove the rear fender screws with a #2 Phillips.

Carefully unhook the tabs on both sides of the rear fender.



Remove the rear fender.

2. EXHAUST MUFFLER/FRAME COVERS

Taillight Assembly



Remove the eight taillight assembly screws with a #2 Phillips.



Unhook the taillight section and separate from the body cover.

Remove the taillight assembly

2. EXHAUST MUFFLER/FRAME COVERS

License Light



Remove the two license light assembly screws with a screwdriver

Disconnect the connector license light.

Remove the license light assembly.

Installation



Fit the body cover into place.

2. EXHAUST MUFFLER/FRAME COVERS



Plug in the taillight connector.

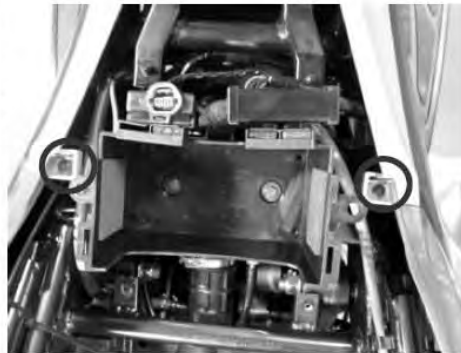

Carefully push the hooks into the corresponding tabs on both sides of the body cover.

Install the two screws on both sides of the body cover.



2. EXHAUST MUFFLER/FRAME COVERS



Install the four lower body cover nuts and tighten securely with a 10 mm socket.



Carefully install the rear center cover.



Install the two rear center cover screws and tighten securely with a #2 Phillips.

2. EXHAUST MUFFLER/FRAME COVERS

Windshield

Removal



Remove the hidden bolt with a 10 mm socket.



Depress the head of the fastener center piece.
Pull out the fastener.

2. EXHAUST MUFFLER/FRAME COVERS



Carefully pull out the front cover with a thinner driver on each side.



Lightly slap downward at the front cover on each side.

2. EXHAUST MUFFLER/FRAME COVERS



Remove the front cover.



Remove the four bolts with a 12mm socket on each side.



Remove the windshield.

2. EXHAUST MUFFLER/FRAME COVERS

Installation

Install the windshield.



Install the four windshield bolts and tighten securely with a 12mm socket.

There are two bolts on each side.



Install the center cover carefully. Install the push pin



Install the hidden bolt and tighten securely with a 10 mm socket. Close the cover.

2. EXHAUST MUFFLER/FRAME COVERS

Front Cover Meter

Removal



Remove the two front cover meter mounting nuts with a 10 mm socket



Remove the two screws mounting on the front cover meter on each side.



Remove the front cover meter

2. EXHAUST MUFFLER/FRAME COVERS

Install



Install the front cover meter



Install the two screws mounting on the front cover meter on each side.



Install the two screws mounting on the front cover meter on each side.

2. EXHAUST MUFFLER/FRAME COVERS

Side Molding A

Removal



Remove the side molding mounting nuts with a 10 mm socket.



Carefully depress the front inner cover.

2. EXHAUST MUFFLER/FRAME COVERS



Carefully pull out the side molding and leg shield with a thinner driver on each side.



Carefully pull off the side molding with hand.

2. EXHAUST MUFFLER/FRAME COVERS



Carefully pull out the side molding and side skirt with hand on each side.

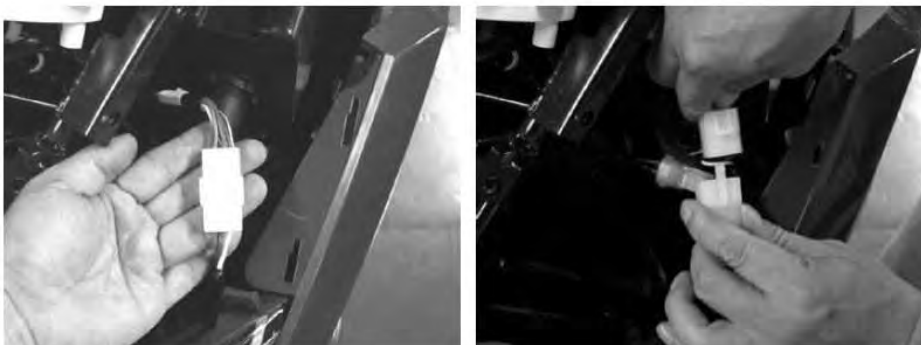

Unplug the headlight leads.

2. EXHAUST MUFFLER/FRAME COVERS



Gently pull the side molding forward and free the tabs.

Disassembly

Light Assembly



2. EXHAUST MUFFLER/FRAME COVERS

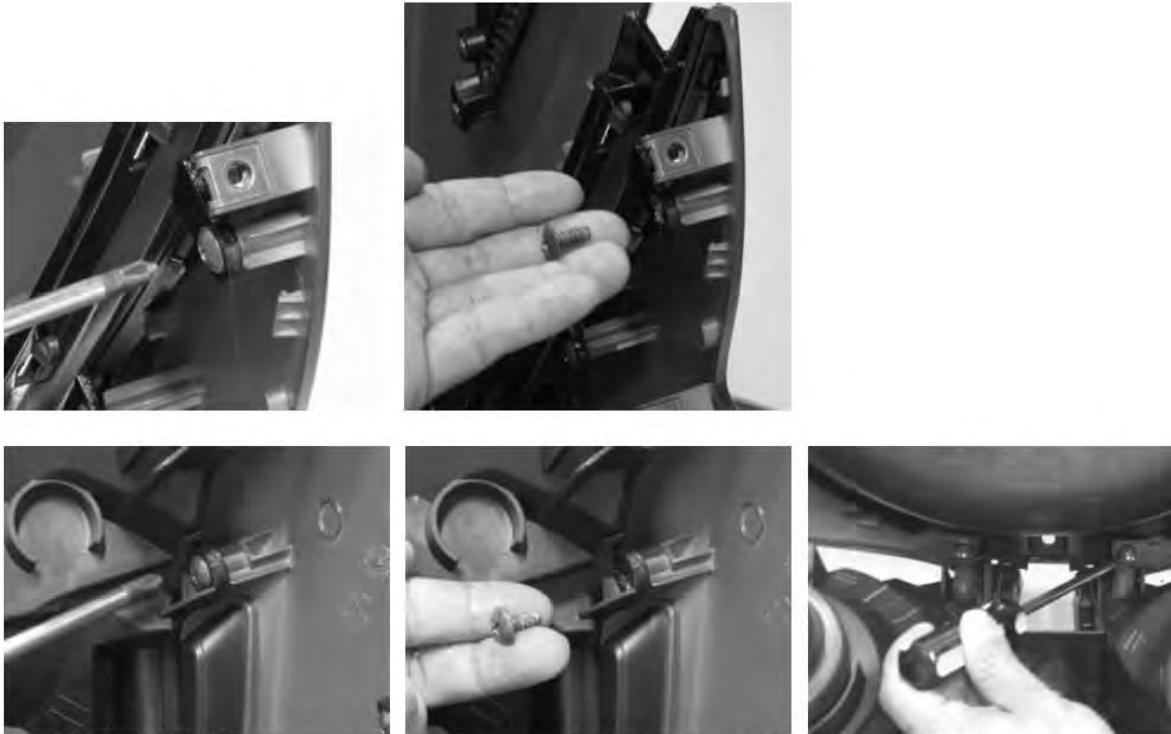

Remove the eight light assembly mounting screws with a #2 Phillips.



Separate the light assembly from the side molding A.

2. EXHAUST MUFFLER/FRAME COVERS

Side Piece

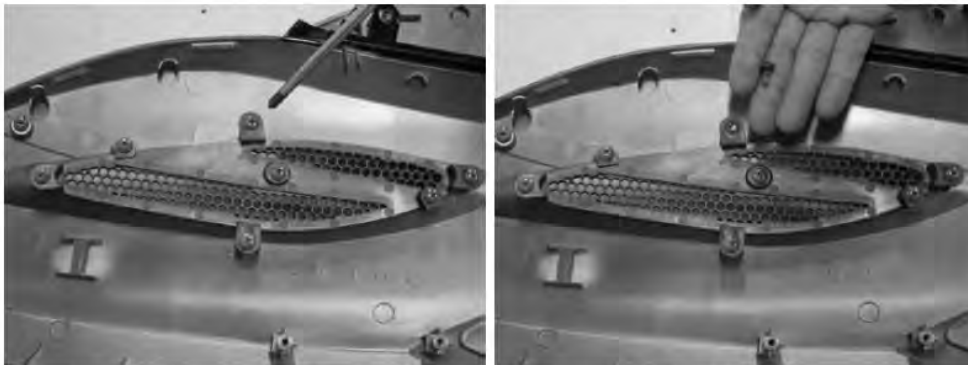

Remove the eight side piece screws with a #2 Phillips.

Assembly

Side Piece



Install the eight side piece screws and tighten securely with a #2 Phillips.

2. EXHAUST MUFFLER/FRAME COVERS

Light Assembly



Install the eight light assembly mounting screws and tighten securely with a #2 Phillips.

2. EXHAUST MUFFLER/FRAME COVERS



Install the headlight assembly on the side molding A.

Installation

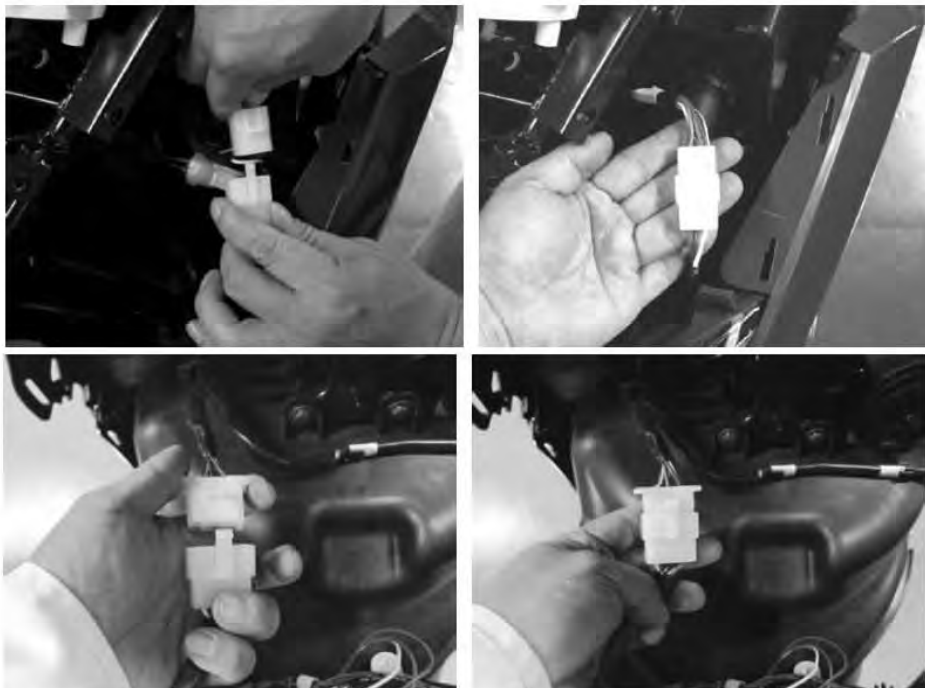

Plug in the headlight and turn signal leads.

2. EXHAUST MUFFLER/FRAME COVERS



Align front cover tabs. Install the front cover.



Carefully Align the side molding and side skirt with hand on each side.

2. EXHAUST MUFFLER/FRAME COVERS



Carefully Align the side molding and leg shield



Install the two front cover mounting nuts with a 10 mm socket.

2. EXHAUST MUFFLER/FRAME COVERS

Side Skirt



Removal



Pull up the footboard rubber covers.



Remove the four screws mounting the footboard with a #2 Phillips.

2. EXHAUST MUFFLER/FRAME COVERS



Remove the six leg shield mounting screws with a #2 Phillips.

There are three screws on each side.

2. EXHAUST MUFFLER/FRAME COVERS

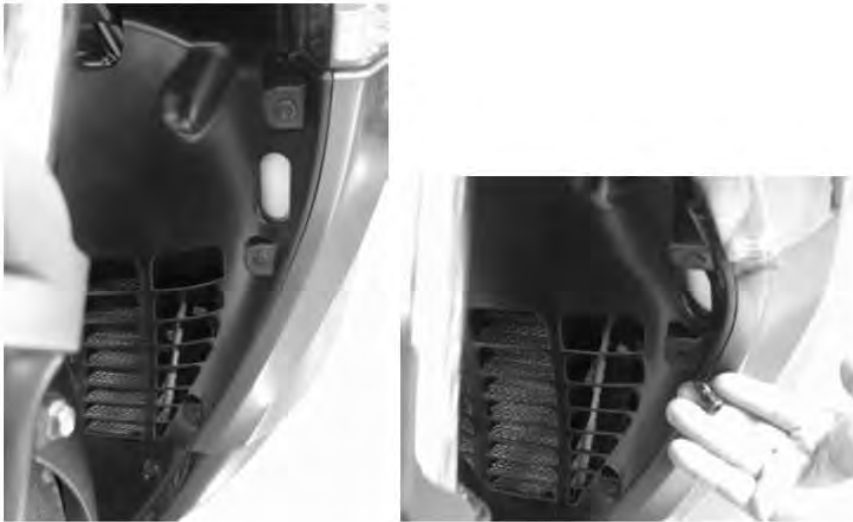

Remove the six lower fairing push pins on each side including the undercover.

2. EXHAUST MUFFLER/FRAME COVERS



Remove the left lower bolt under the side skirt with a 10mm socket.



Gently separate the floorboard from the side skirt. Carefully free the tabs.



Remove the cover side skirt after the turn signal leads removed.

2. EXHAUST MUFFLER/FRAME COVERS



Remove the two cover side skirt mounting screws with a #2 Phillips.

Disassembly



Remove the two screws from the side board A with a #2 Phillips.

2. EXHAUST MUFFLER/FRAME COVERS



Separate the Side skirt and side board A.



Remove the three cover side skirt mounting screws with a #2 Phillips.



Carefully pull out the cover side skirt from side skirt.

2. EXHAUST MUFFLER/FRAME COVERS



Remove the three winker assembly mounting screws with a #2 Phillips.



Remove the winker assembly from the cover side skirt.

2. EXHAUST MUFFLER/FRAME COVERS

Assembly

Winker Assembly



Install the three winker assembly mounting screws with a #2 Phillips.



Install the three screws onto the cover side skirt.

2. EXHAUST MUFFLER/FRAME COVERS

Installation



Install the side skirt. Carefully fit the upper tabs of the side board A into the floorboard. Install the side board A while aligning the tabs.



Install the four screws under the footboard rubber cover with a #2 Phillips on each side. Tighten them securely.



Install the left lower bolt under the footboard rubber cover with a 10mm socket.

2. EXHAUST MUFFLER/FRAME COVERS



Install the footboard rubber covers.

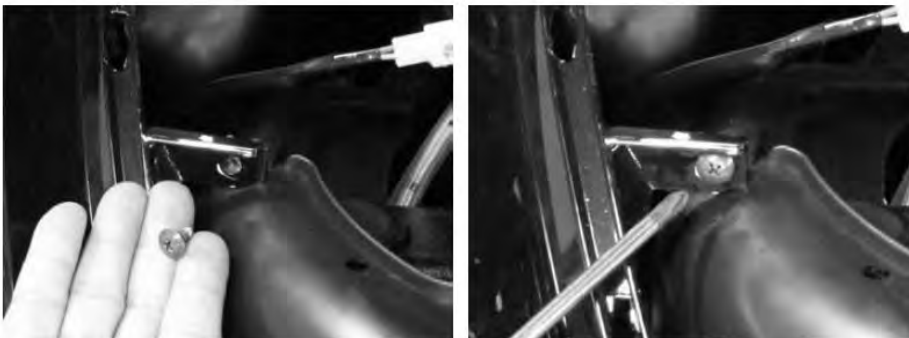

Install the two cover side skirt mounting screws with a #2 Phillips.



Connect the turn signal leads removed.

2. EXHAUST MUFFLER/FRAME COVERS



Install the six leg shield mounting screws with a #2 Phillips.

There are three screws on each side.



Install the six lower fairing push pins on each side including the undercover.

2. EXHAUST MUFFLER/FRAME COVERS

Front Fender

Removal



Remove the left forward front fender bolt with a 6 mm Allen.



Remove the left rear fender bolt with a 10 mm socket.



Remove the right forward front fender bolt with a 6 mm Allen.

2. EXHAUST MUFFLER/FRAME COVERS



Remove the right rear fender bolt with a 10 mm socket.



Remove the front fender from the forks.

2. EXHAUST MUFFLER/FRAME COVERS

Installation



Guide the fender between the forks.



Install the right rear fender bolt with a 10 mm socket.



Install the right forward front fender bolt with a 6 mm Allen.

2. EXHAUST MUFFLER/FRAME COVERS



Install the left rear fender bolt with a 10 mm socket.



Install the left forward front fender bolt with a 6 mm Allen.

2. EXHAUST MUFFLER/FRAME COVERS

Center Cover

Removal

Note: Do not force the cover and damage the claws.

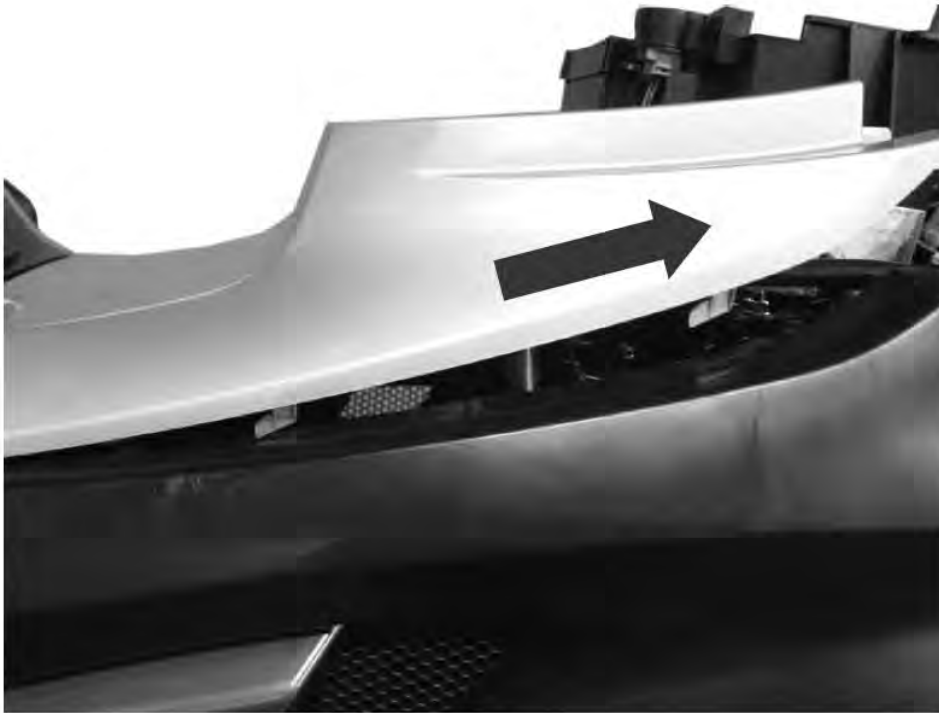

Pull the center cover back and up to free the claws and then move the cover backward to free it from the scooter.

2. EXHAUST MUFFLER/FRAME COVERS



Remove the center cover.

Installation



Place the center cover on the scooter.

2. EXHAUST MUFFLER/FRAME COVERS



Push the cover down and forward to lock in the claws.

2. EXHAUST MUFFLER/FRAME COVERS

Under Cover

Removal

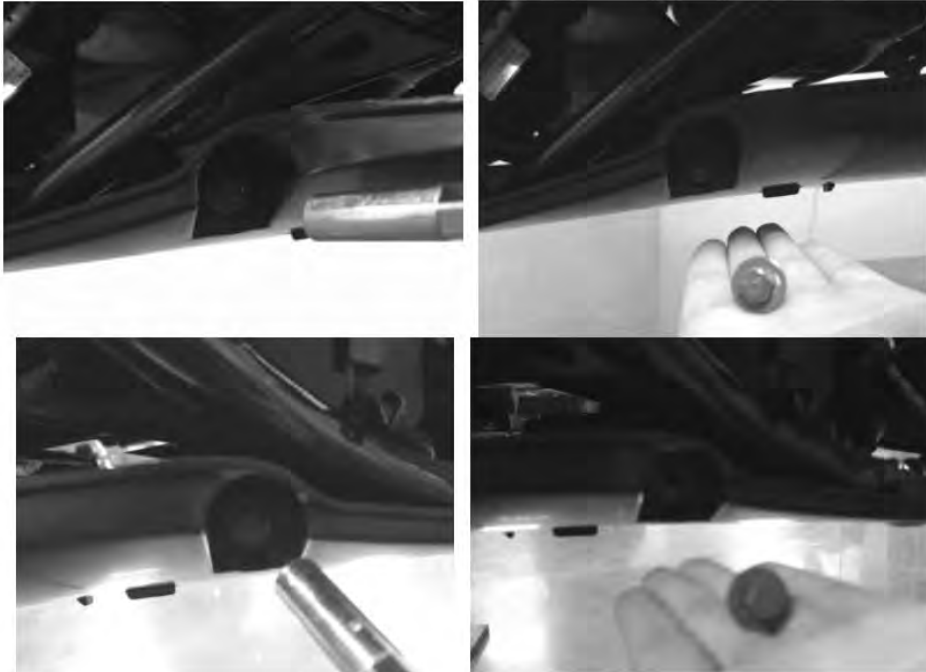

Remove the two cover bolts mounting the under cover each side with a 10 mm socket.



Remove the under cover.

2. EXHAUST MUFFLER/FRAME COVERS

Installation

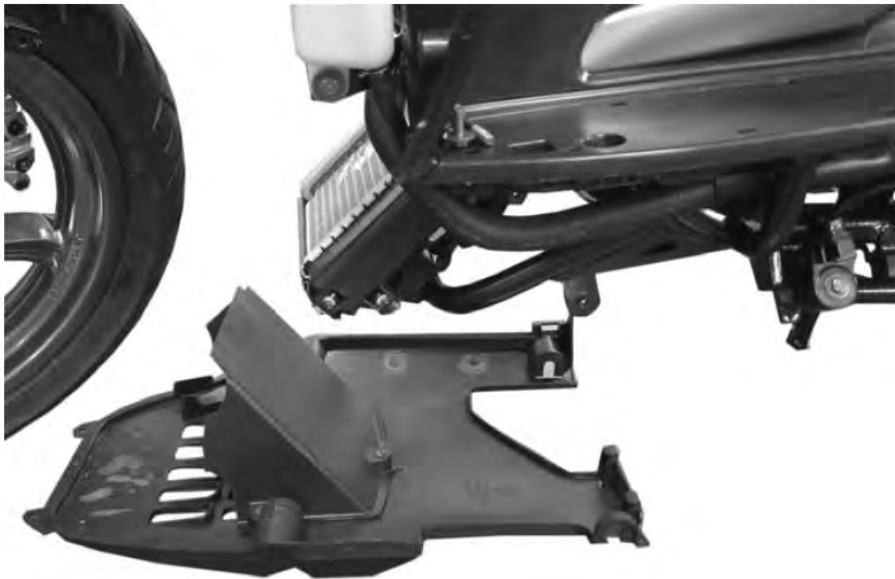

Install the under cover.

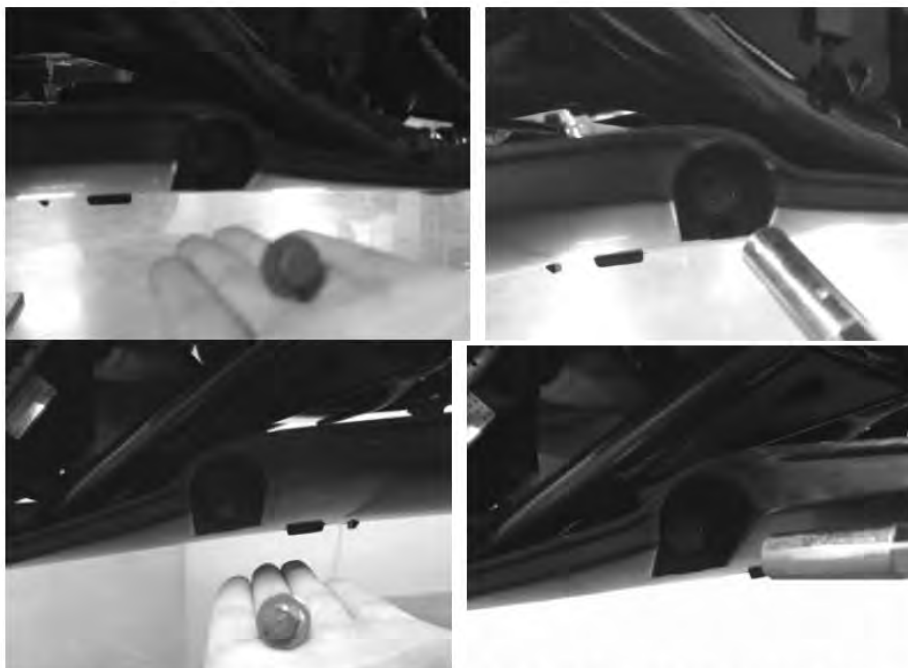

Install the two under cover bolts on the each side and tighten securely with a 10 mm socket.

2. EXHAUST MUFFLER/FRAME COVERS

Rear Meter Cover

Removal



Remove the two push pins below the handlebar. Depress the head of the fastener center piece. Pull out the fastener.



Remove the bolt attaching the rear meter cover on the left with a 10 mm socket.



Remove the bolt attaching the speedometer cover on the right with a 10 mm socket.

2. EXHAUST MUFFLER/FRAME COVERS



Remove two screws mounting the rear meter cover on both sides with a #2 Phillips.

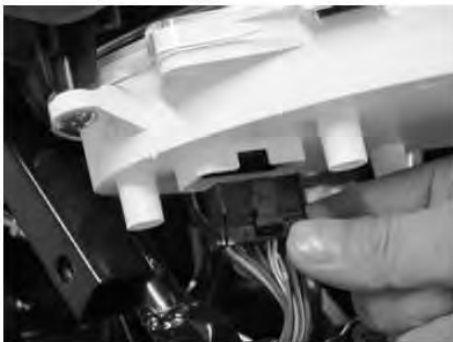

Remove the connector speedometer assembly.



Remove the speedometer assembly

2. EXHAUST MUFFLER/FRAME COVERS

Installation



Install the speedometer assembly

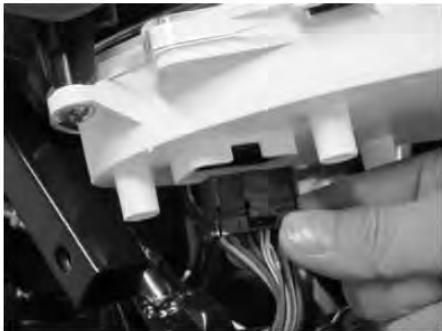

Install the connector speedometer assembly.



Install two screws mounting the speedometer cover on both sides with a #2 Phillips.

2. EXHAUST MUFFLER/FRAME COVERS



Install the bolt attaching the rear meter cover on the left with a 10 mm socket.



Install the bolt attaching the speedometer cover on the right with a 10 mm socket.



Install the two push pins below the handlebar. Depress the head of the fastener center piece. Pull out the fastener.

Note: To prevent the pawl from damage, insert the fastener all the way into the installation hole.

2. EXHAUST MUFFLER/FRAME COVERS

Floorboard

Removal



Remove the two bolts mounting the floorboard on the left side with a 10 mm socket.



Remove the two bolts mounting the floorboard on the right side with a 10 mm socket.



Remove the two bolts mounting the side board A on each side with a 10 mm socket.

2. EXHAUST MUFFLER/FRAME COVERS

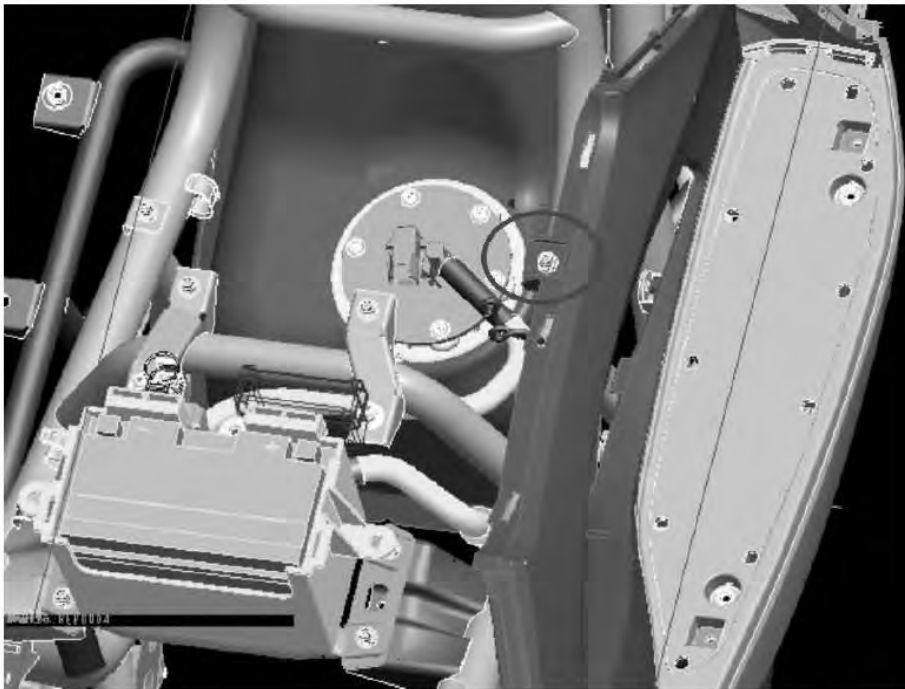

Remove the two nuts mounting the side board A on each side with a 10 mm socket.



Carefully unhook the tabs on both sides of the side board A.

2. EXHAUST MUFFLER/FRAME COVERS



Remove the floorboard on each side.

Disassembly



Remove the four screws mounting the side board A

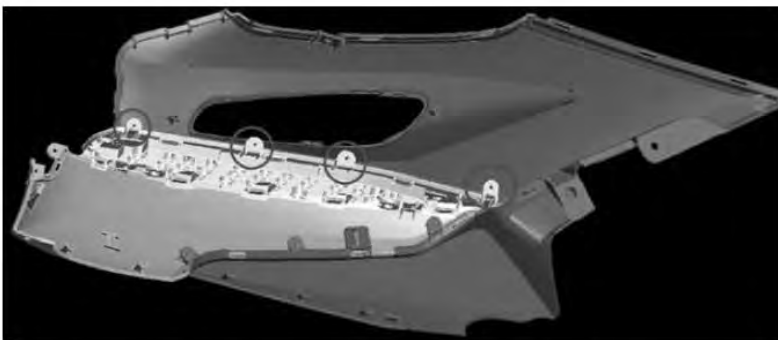

Separate the floorboard from side board A.

2. EXHAUST MUFFLER/FRAME COVERS

Disassembly



Install the four screws mounting the side board A

Installation



Install the floorboard on each side.

2. EXHAUST MUFFLER/FRAME COVERS

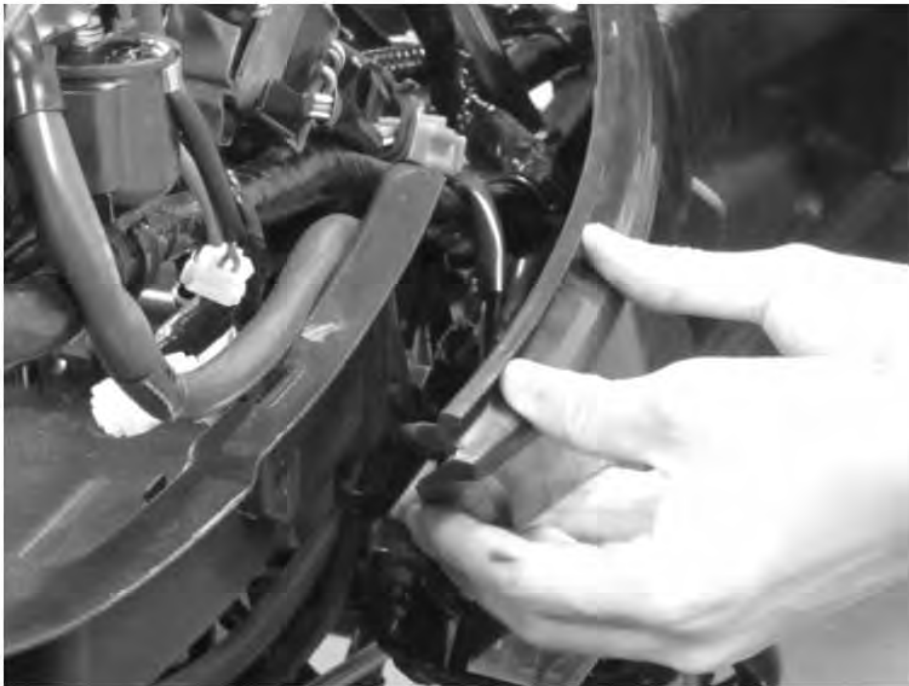

Carefully install the tabs on both sides of the side board A.

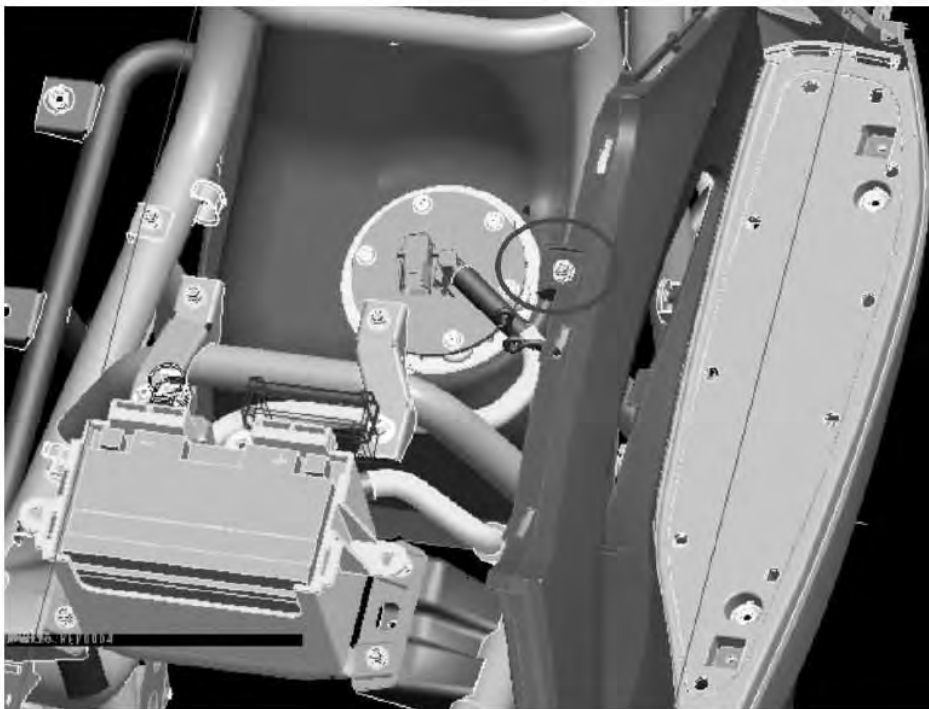

Install the two nuts mounting the side board A on each side with a 10 mm socket.

2. EXHAUST MUFFLER/FRAME COVERS

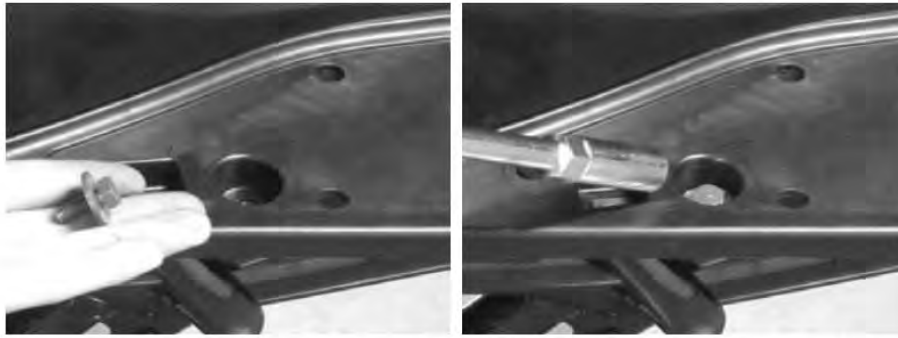

Install the four bolt mounting the floorboard on each side with a 10 mm socket.



Install the two bolt mounting the side board A on each side with a 10 mm socket.

2. EXHAUST MUFFLER/FRAME COVERS

Leg Shield

Removal

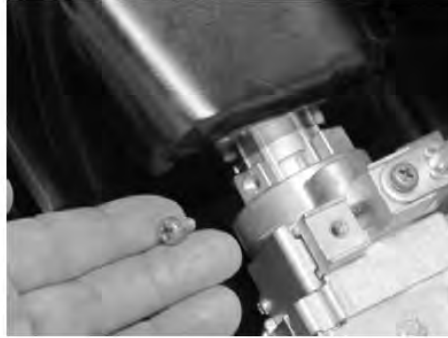
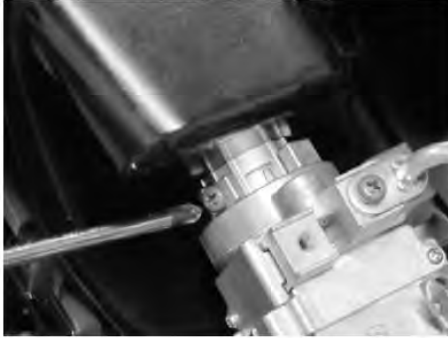

Remove the screw mounting the collar ignition switch with a #2 Phillips.



Take off the collar.



Open the fuel cap panel.

2. EXHAUST MUFFLER/FRAME COVERS



Remove the fuel cap with the key.

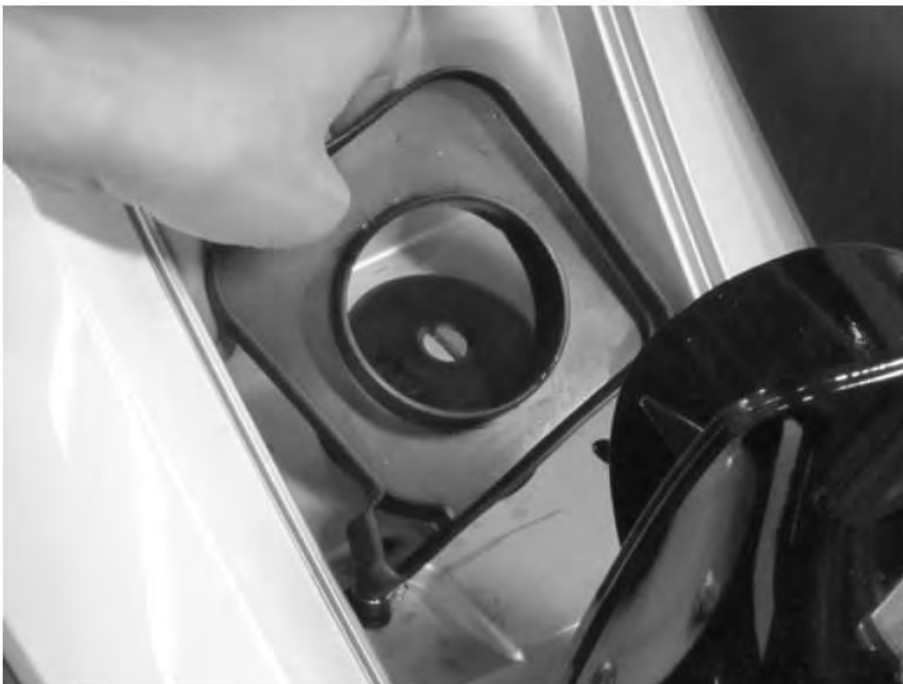

Remove the Lid fuel cap maint.

2. EXHAUST MUFFLER/FRAME COVERS

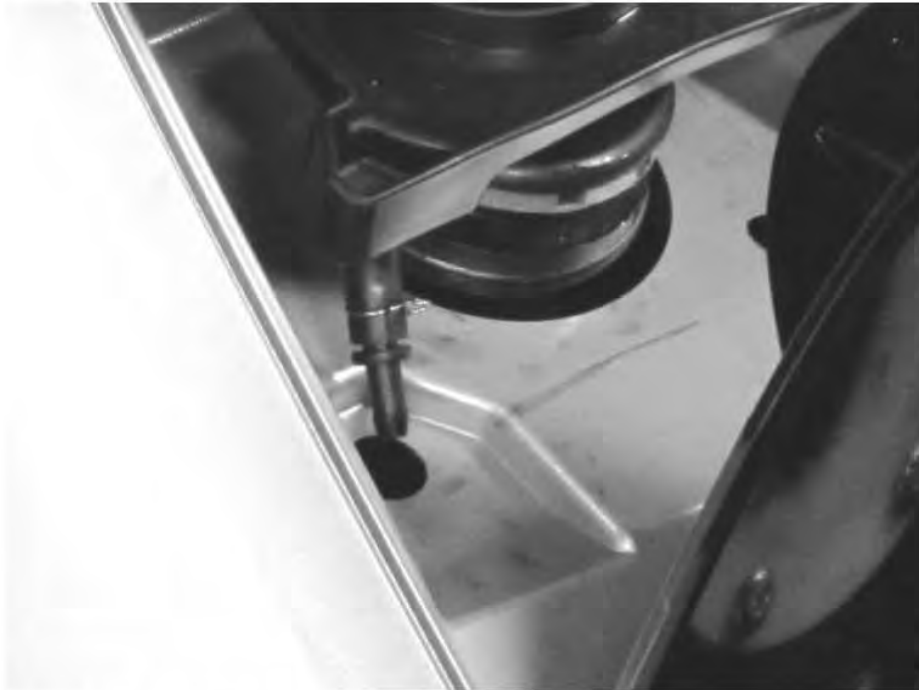

Remove the gas cap overflow pad.



Lift off the leg shield.

2. EXHAUST MUFFLER/FRAME COVERS

Installation



Install the leg shield.



Align the pin hole of the body frame.

2. EXHAUST MUFFLER/FRAME COVERS

K-XCT 125i



Install the gas cap overflow pad and the Lid fuel cap maint.

2. EXHAUST MUFFLER/FRAME COVERS

Handlebar Covers

Removal

Upper Cover

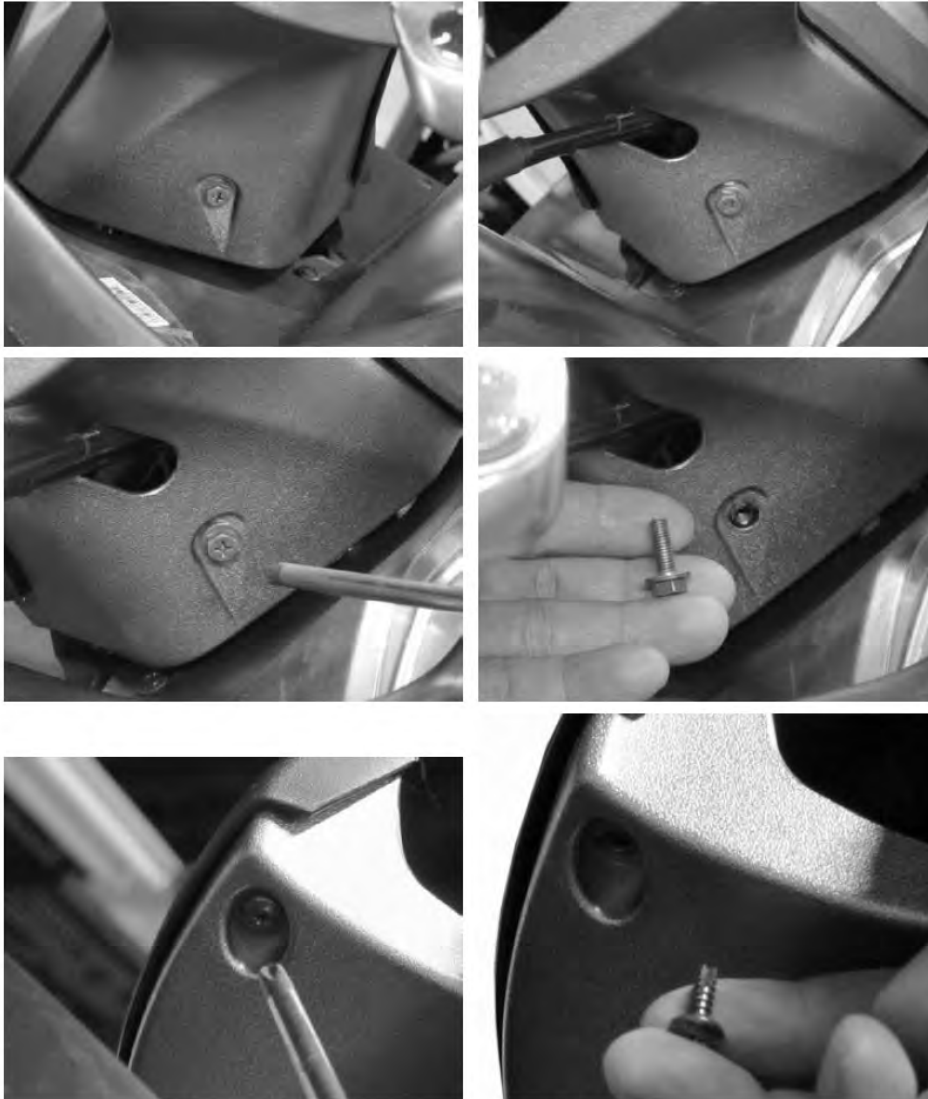

Remove the four cover screws with a #2 Phillips.

2. EXHAUST MUFFLER/FRAME COVERS



Carefully free the tabs and remove the upper handlebar cover.

Lower Cover



Route the throttle cables out of the handlebar cover.

2. EXHAUST MUFFLER/FRAME COVERS

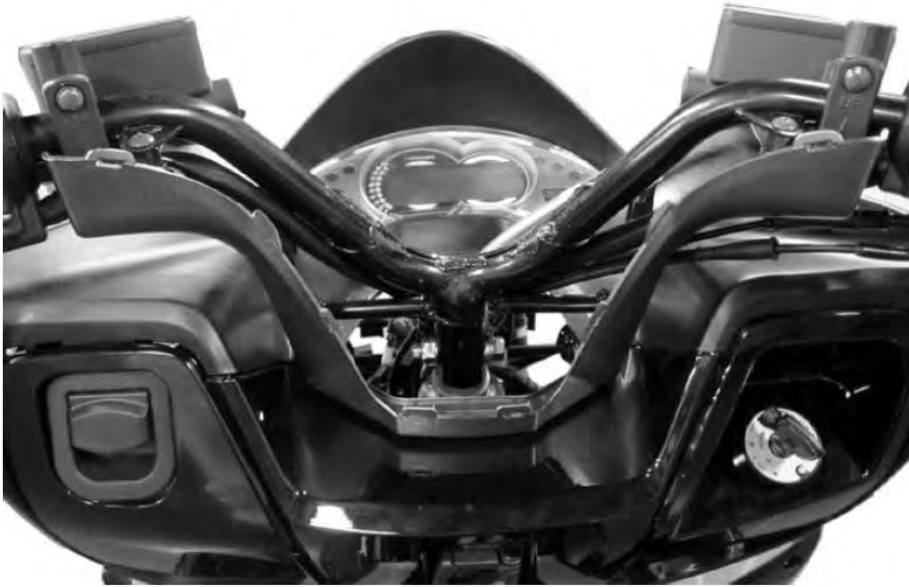

Remove the two handle lower cover screws with a #2 Phillips.

2. EXHAUST MUFFLER/FRAME COVERS



Remove the lower cover.

Installation



Place the lower cover onto the handlebar.

2. EXHAUST MUFFLER/FRAME COVERS

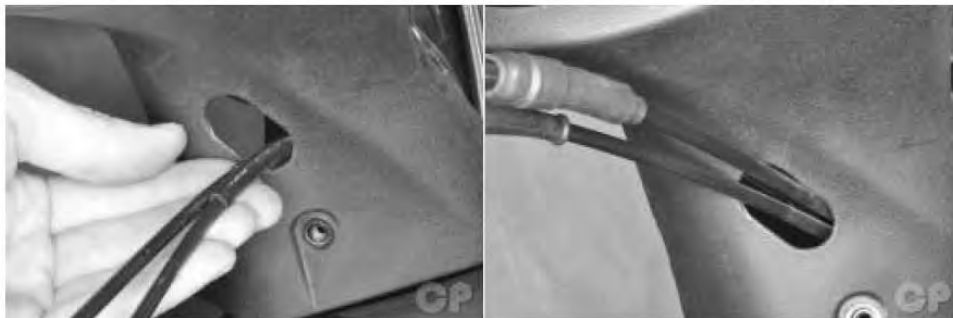

Route the throttle cables into the handlebar cover.



Carefully install the upper handlebar cover.

2. EXHAUST MUFFLER/FRAME COVERS

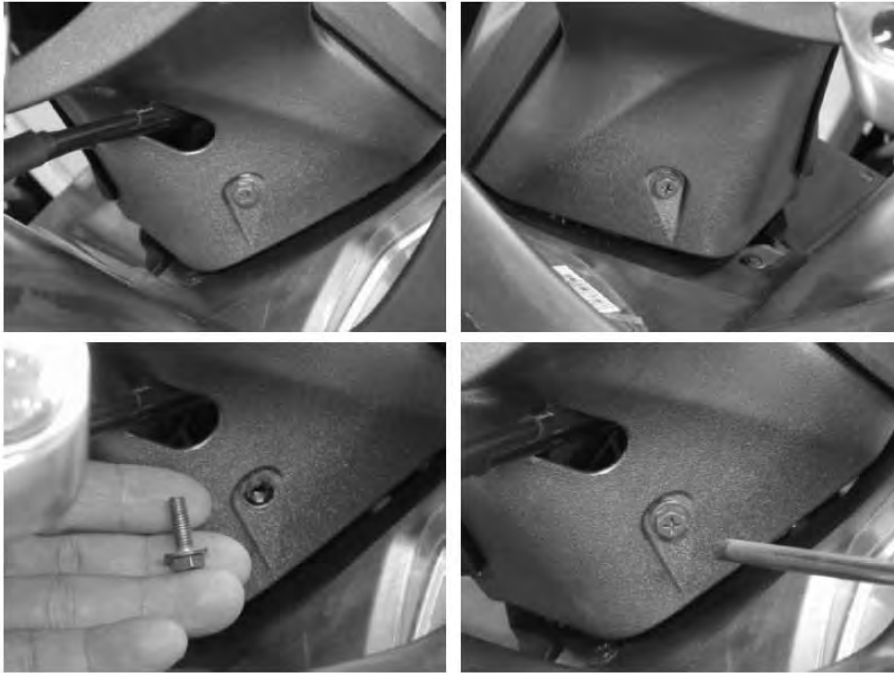

Remove the four cover screws with a #2 Phillips.

2. EXHAUST MUFFLER/FRAME COVERS

Rear Tire Fender

Removal



Remove the two fender mounting bolts with a 8 mm socket on the right side.

2. EXHAUST MUFFLER/FRAME COVERS



Remove the two airbox mounting bolts with a 8mm socket.

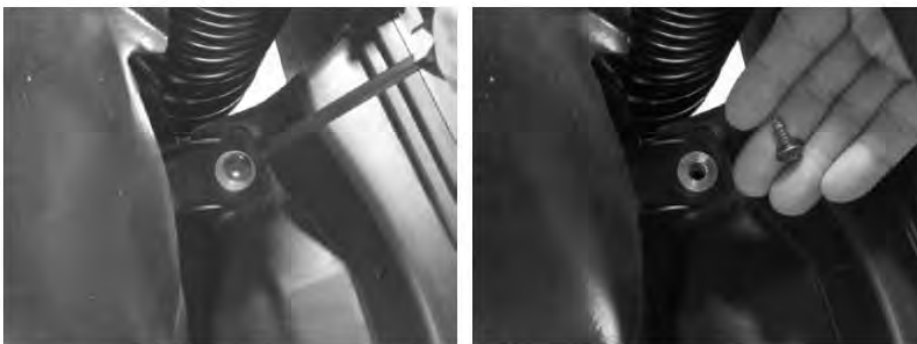

Remove the connecting tube screw with a 2# Phillips.



Remove the fender mounting bolt with a 8 mm socket on the left side.

2. EXHAUST MUFFLER/FRAME COVERS



Remove the rear fender.

Installation



Install the rear fender.

2. EXHAUST MUFFLER/FRAME COVERS



Install the fender mounting bolt with a 8 mm socket on the left side.

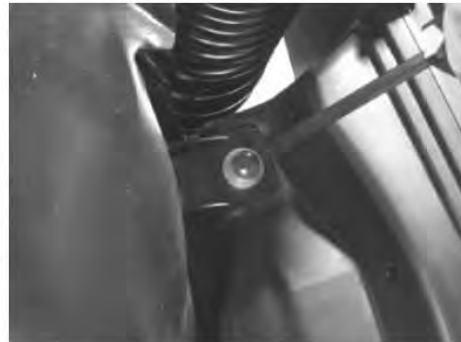

Install the connecting tube screw with a 2# Phillips.



Install the two fender mounting bolts with a 8 mm socket on the right side.

2. EXHAUST MUFFLER/FRAME COVERS



Install the two airbox mounting bolts with a 8mm socket.
Install the airbox.

2. EXHAUST MUFFLER/FRAME COVERS

Stands

Side stand

Removal



Unplug the three-pin side stand switch connector.



Remove the side stand spring with a spring puller.

2. EXHAUST MUFFLER/FRAME COVERS



Remove the side stand bolt, switch, and side stand.

Installation



Install the side stand, switch, and bolt. Make sure to fit the switch into place correctly. Tighten the bolt securely.

2. EXHAUST MUFFLER/FRAME COVERS



Install the side stand spring with a spring puller.



Plug in the side stand switch connector.

2. EXHAUST MUFFLER/FRAME COVERS

Center Stand

Removal



Remove the center stand spring with a spring puller.



Remove the two center stand nuts and bolts. Remove the center stand.

2. EXHAUST MUFFLER/FRAME COVERS

Installation



Install the nuts and bolts. Tighten them securely.



Install the center stand spring with a spring puller.

3. INSPECTION/ADJUSTMENT

3

INSPECTION/ADJUSTMENT

SERVICE INFORMATION-----	3-1
MAINTENANCE SCHEDULE-----	3-2
FUEL LINE-----	3-4
THROTTLE OPERATION-----	3-4
ENGINE OIL-----	3-5
TRANSMISSION OIL-----	3-11
AIR CLEANER-----	3-12
SPARK PLUG-----	3-13
VALVE CLEARANCE-----	3-14
IDLE SPEED-----	3-15
CYLINDER COMPRESSION-----	3-16
DRIVE BELT-----	3-16
CLUTCH SHOE WEAR-----	3-17
COOLANT-----	3-18
BRAKE FLUID-----	3-19
BRAKE PAD WEAR-----	3-19
NUTS/BOLTS/FASTENERS-----	3-20
WHEELS/TIRES-----	3-20
SUSPENSION-----	3-21
SIDE STAND-----	3-22

3. INSPECTION/ADJUSTMENT

SERVICE INFORMATION

GENERAL

 WARNING
--

- Before running the engine, make sure that the working area is well-ventilated. Never run the engine in a closed area. The exhaust contains poisonous carbon monoxide gas which may cause death to people.
- Gasoline is extremely flammable and is explosive under some conditions. The working area must be well-ventilated and do not smoke or allow flames or sparks near the working area or fuel storage area.

SPECIFICATIONS

Throttle grip free play : 2~6 mm
 Spark plug : NGK CR7E
 Spark plug gap : 0.6~0.7 mm
 Valve clearance : IN: 0.1 mm EX: 0.1 mm
 Idle speed : 1800 rpm

Cylinder compression : 15 kg/cm²

Engine oil capacity:

At disassembly : 1.2L

At change : 1.0L

Gear oil capacity :

At disassembly : 0.13L

At change : 0.12L

Coolant capacity :

Ignition timing : ECU control

TIRE

	1 Rider (75 kg)	2 Riders (150 kg)
Front	2.0 kgf/cm ²	2.00 kgf/cm ²
Rear	2.25 kgf/cm ²	2.25 kgf/cm ²

TIRE SPECIFICATION:

Front : 120/70-14

Rear : 150/70-13

3. INSPECTION/ADJUSTMENT

MAINTENANCE SCHEDULE

Perform the pre-ride inspection at each scheduled maintenance period.

This interval should be judged by odometer reading or months, whichever comes first.

I: INSPECT AND CLEAN, ADJUST, LUBRICATE OR REPLACE IF NECESSARY

C: CLEAN R: REPLACE A: ADJUST L: LUBRICATE

The following maintenance schedule specifies all maintenance required to keep your scooter in peak operating condition. Maintenance work should be performed in accordance with standards and specifications of KYMCO by properly trained and equipped technicians. Your KYMCO dealer meets all of these requirements.

- * Should be serviced by your KYMCO dealer, unless the owner has the proper tools and service data and is mechanically qualified.
- * * In the interest of safety, we recommend these items be serviced only by your KYMCO dealer.
KYMCO recommends that your KYMCO dealer should road test your scooter after each periodic maintenance is carried out.

3. INSPECTION/ADJUSTMENT

MAINTENANCE SCHEDULE

ITEM		FREQUENCY	WHICHEVER COMES FIRST		ODOMETER READING									
			→		X 1000 km	1	5	10	15	20	25	30	REFER TO PAGE	
			↓		X 1000 mi	0.6	3	6	9	12	15	18		
			MONTH		1	6	12	18	24	30	36			
*	AIR CLEANER					R	R	R	R	R	R	R	33	
	SPARK PLUGS					I	R	I	R	I	R		34	
*	THROTTLE OPERATION					I	I	I	I	I	I		33	
*	VALVE CLEARANCE					I	A	I	A	I	A		-	
*	FUEL LINE							I			I		-	
	CRANKCASE BREATHER					C	C	C	C	C	C	C	-	
*	ENGINE OIL					R	R	R	R	R	R	R	29	
*	ENGINE OIL SCREEN						C	R	C	R	C	R	-	
*	ENGINE OIL FILTER					R	R	R	R	R	R	R	-	
*	ENGINE IDLE SPEED							I		I		I	-	
*	TRANSMISSION FLUID					R	R	R	R	R	R	R	32	
*	DRIVE BELT							I	I	I	R	I	I	-

ITEM		FREQUENCY	WHICHEVER COMES FIRST		ODOMETER READING [NOTE (1)]								
			→		X 1000 km	1	5	10	15	20	25	30	REFER TO PAGE
			↓		X 1000 mi	0.6	3	6	9	12	15	18	
			NOTE		MONTH	1	6	12	18	24	30	36	
	CLUTCH SHOE WEAR							I		I		I	
	BRAKE FLUID							I	R	I	R	I	R
	BRAKE PAD WEAR							I	I	I	I	I	I
	BRAKE SYSTEM							I	I	I	I	I	I
	BRAKE LIGHT SWITCH							I	I	I	I	I	I
	STEERING BEARINGS							I	I	I	I	I	I
	HEADLIGHT AIM							I	I	I	I	I	I
	NUTS, BOLTS, FASTENERS							I	I	I	I	I	I
	WHEELS/TIRES							I	I	I	I	I	I

3. INSPECTION/ADJUSTMENT

FUEL LINE

Check the fuel lines and replace any parts which show signs of deterioration, damage or leakage.

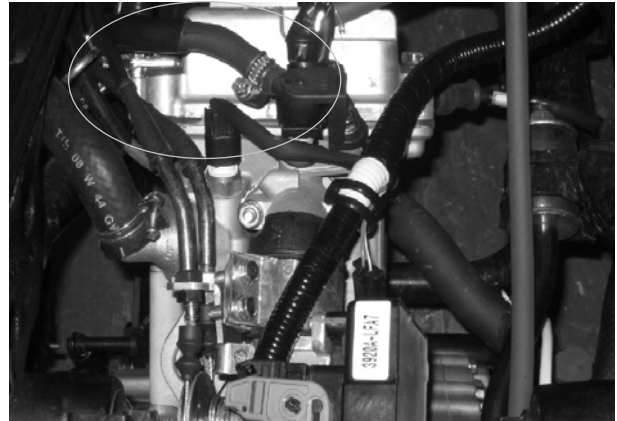

THROTTLE OPERATION

Check the throttle grip for smooth movement. Measure the throttle grip free play.

Free Play: 2~6 mm

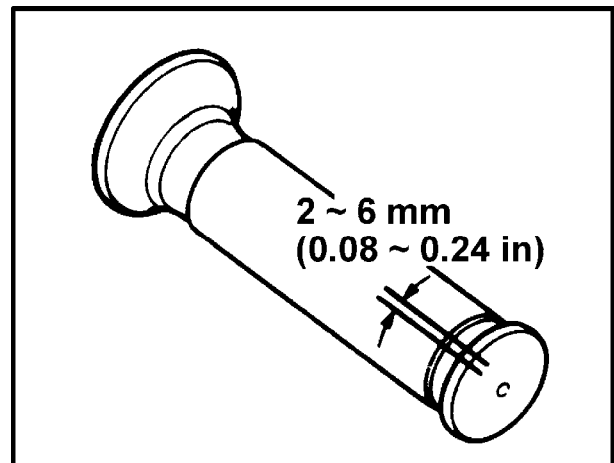

Major adjustment of the throttle grip free play is made with the adjusting nut at the throttle body side. Adjust by loosening the lock nut and turning the adjusting nut.

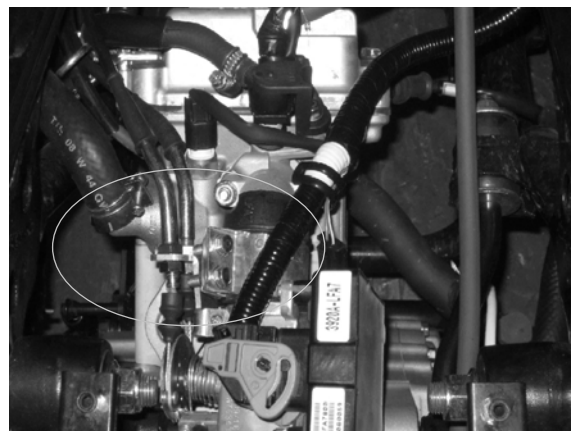

3. INSPECTION/ADJUSTMENT

Minor adjustment is made with the adjusting nut at the throttle grip side.

Slide the rubber cover (1) out and adjust by loosening the lock nut (3) and turning the adjusting nut (2).

(Chart)

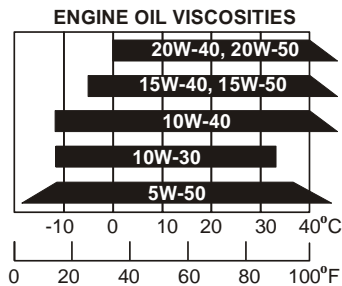

ENGINE OIL

Engine oil recommendation

Use a premium quality 4-stroke motor oil to ensure longer service life of your scooter. Use only oils which are rated, SJ under the API service classification. The recommended viscosity is SAE 15W-40. If a SAE 15W-40 motor oil is not available, select an alternative according to the chart.

Engine oil capacity:

At disassembly:
1.2 L

At change:
1.0 L

Engine oil level check

Check the engine oil level each day before riding the scooter.

The level must be maintained between the upper and lower level marks on the oil filler cap/dipstick.

1. Start the engine and let it idle for a few minutes.

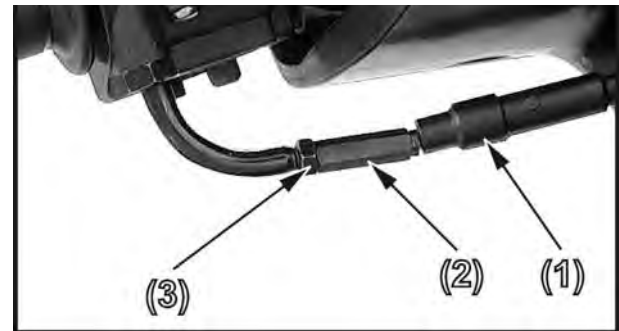

2. Stop the engine and put the scooter on its center stand on level ground.
3. After a few minutes, remove the oil filler cap/dipstick, wipe it clean, and reinsert the oil filler cap/dipstick without screwing it in. Remove the oil filler cap/dipstick. The oil level should be between the upper and lower marks on the oil filler cap/dipstick.
4. If required, add the specified oil up to the upper level mark. Do not overfill.
5. Reinstall the oil filler cap/dipstick. Check for oil leaks.

* Let the engine and exhaust system cool before working in those areas.



3. INSPECTION/ADJUSTMENT

Engine oil replacement

Engine oil quality is the chief factor affecting engine service life. Change the engine oil as specified in the maintenance schedule.

When running in very dusty conditions, oil changes should be performed more frequently than specified in the maintenance schedule.

Please dispose of used engine oil in a manner that is compatible with the environment. We suggest you take it in a sealed container to your local recycling center or service station for reclamation. Do not throw it in the trash or pour it on the ground or down a drain.

Used engine oil may cause skin cancer if repeatedly left in contact with the skin for prolonged periods. Although this is unlikely unless you handle used oil on a daily basis, it is still advisable to thoroughly wash your hands with soap and water as soon as possible after handling used oil.

Change the engine oil with the engine at normal operating temperature and the scooter on its center stand to assure complete and rapid draining.

3. INSPECTION/ADJUSTMENT

1. Remove the oil filler cap/dipstick(1) from the right crankcase cover.
2. Place a container under the left crankcase.
3. Remove the oil drain plug (2) to drain the oil.
4. Reinstall the drain plug and tighten the drain plug to specification.

Oil drain plug torque:

25 N-m (2.5 kgf-m,)

5. Fill the crankcase with the recommended grade oil and install the oil filler cap.

Oil capacity (after draining):

1.0 L

6. Start the engine and let it idle for 2–3 minutes.
7. Stop the engine and check that the oil level is at the upper level mark on the oil filler cap/dipstick with the scooter upright on firm, level ground. Make sure there are no oil leaks.

* Let the engine and exhaust system cool before working in those areas.



(1)



(2)

3. INSPECTION/ADJUSTMENT

Oil strainer screen clean

Change the engine oil with the engine at normal operating temperature and the scooter on its center stand to assure complete and rapid draining.

* Let the engine and exhaust system cool before working in those areas.

1. Remove the oil filler cap/dipstick (1) from the right crankcase cover.
2. Place a drain pan under the crankcase and remove the oil strainer screen cap (2). The spring (3) and oil strainer screen (4) will come out when the drain plug is removed.

Let the engine oil drain out.

3. Clean the oil strainer screen.
4. Check that the oil strainer screen, sealing rubber and drain plug O-ring are in good condition.
5. Install the oil strainer screen, spring and oil strainer screen cap.

Oil strainer screen cap torque:

15N-m (1.5 kgf-m)

6. Fill the crankcase with the recommended grade oil and install the oil strainer screen cap.

Oil capacity (after draining):

1.0 L

7. Start the engine and let it idle for 2–3 minutes.
8. Stop the engine and check that the oil level is at the upper level mark on the oil filler cap/dipstick with the scooter upright on firm, level ground. Make sure there are no oil leaks.



(1)

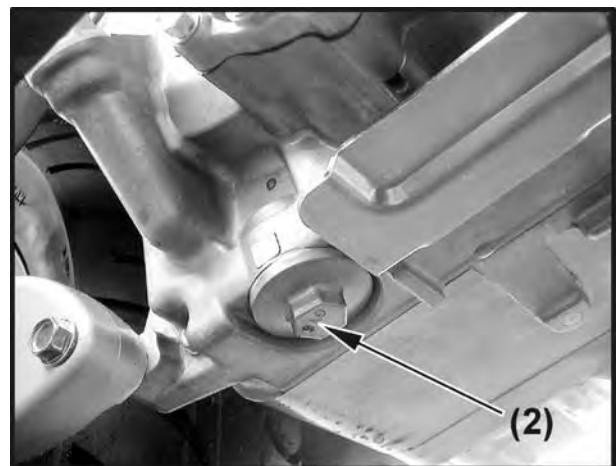

(2)

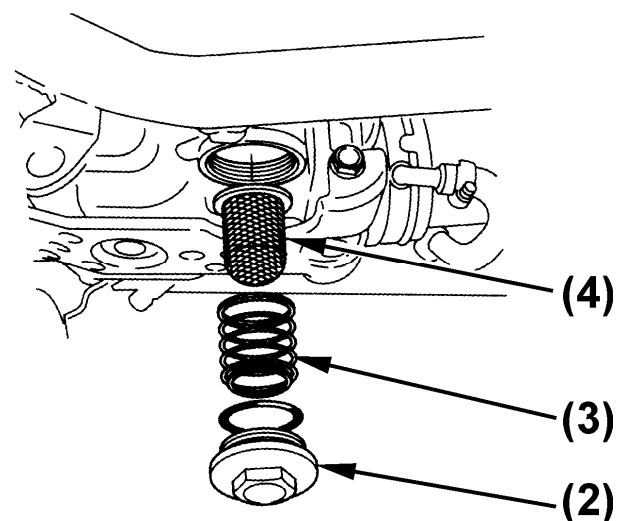

(4)

(3)

(2)

3. INSPECTION/ADJUSTMENT

Oil filter replacement

Change the engine oil with the engine at normal operating temperature and the scooter on its center stand to assure complete and rapid draining.

* Let the engine and exhaust system cool before working in those areas.

1. Remove the oil filler cap/dipstick (1) from the right crankcase cover.



(1)

2. Place a drain pan under the crankcase. Remove three bolts and then remove the oil filter cap (2) and O-ring (3). The spring (4) will come out when the filter cap is removed. Let the engine oil drain out.

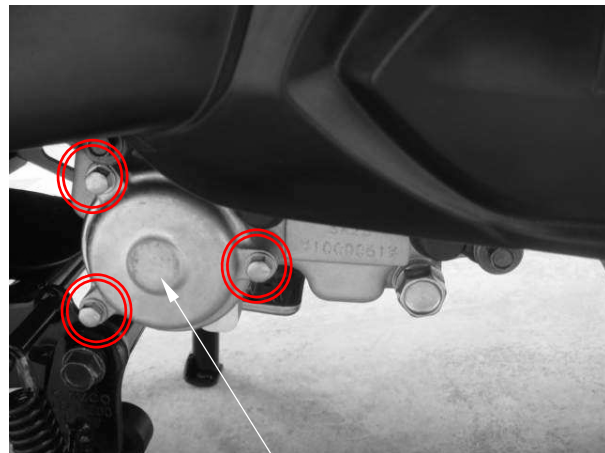

(2)

3. Remove and discard the oil filter (5).

* Do not remain the rubber seal on the oil filter in the oil filter housing.

4. Check that the O-ring is in good condition.

3. INSPECTION/ADJUSTMENT

5. Install the new oil filter.

* Make sure the rubber seal on the oil filter facing the left crankcase.

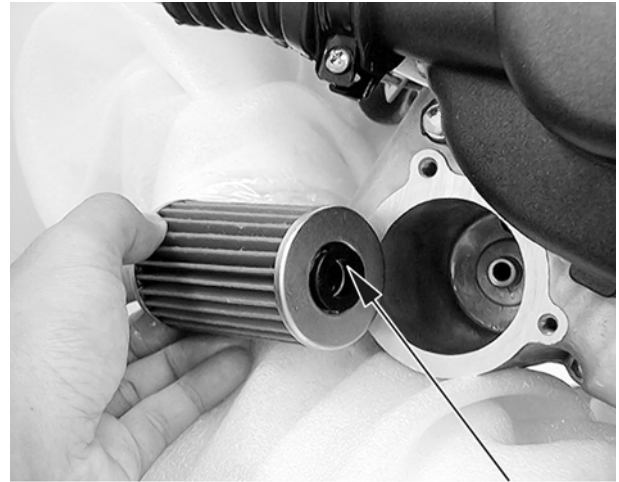

Rubber Seal

6. Install the spring, O-ring and cap.

Torque:

12 N-m (1.2 kgf-m)

7. Fill the crankcase with the recommended grade oil and install the oil filler cap.

Oil capacity (after draining):

1.0 L

8. Start the engine and let it idle for 2–3 minutes.

9. Stop the engine and check that the oil level is at the upper level mark on the oil filler cap/dipstick with the scooter upright on firm, level ground. Make sure there are no oil leaks.

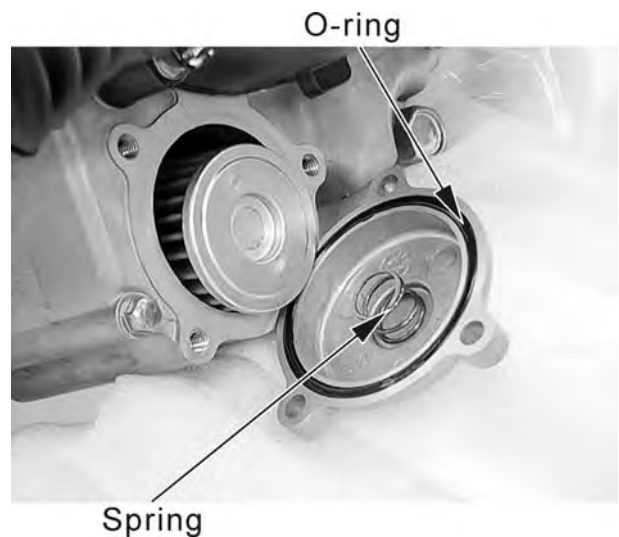

Spring

3. INSPECTION/ADJUSTMENT

TRANSMISSION OIL

Oil change

1. Place the scooter in its center stand.
2. Place a drain pan under the drain bolt (1).
3. Remove the transmission oil drain bolt.
4. Remove the transmission oil filler bolt (2), slowly turn the rear wheel and drain the oil.

After draining the oil completely, install the oil drain bolt with a new sealing washer and tighten it.



(1)

Torque: 13 N-m (1.3 kgf-m)

5. Fill the transmission case with recommended oil.

Recommended transmission oil: SAE 90

Oil capacity (at draining):

0.12 L

6. Install the transmission oil filler bolt with a new sealing washer and tighten it.

Torque: 13 N-m (1.3 kgf-m)



(2)

3. INSPECTION/ADJUSTMENT

AIR CLEANER

The air cleaner should be serviced at regular intervals. Service more frequently when riding in unusually wet or dusty areas.

Air cleaner element replacement

1. Remove the screws from the air cleaner cover , then remove air cleaner cover.
2. Remove screws from the air cleaner element , then remove and discard this air cleaner element.
4. The new air cleaner element installation is in the reverse order of removal.

Use the KYMCO genuine air cleaner element or an equivalent air cleaner element specified for your model. Using the wrong KYMCO air cleaner element or a non-KYMCO air cleaner element which is not of equivalent quality may cause premature engine wear or performance problems.

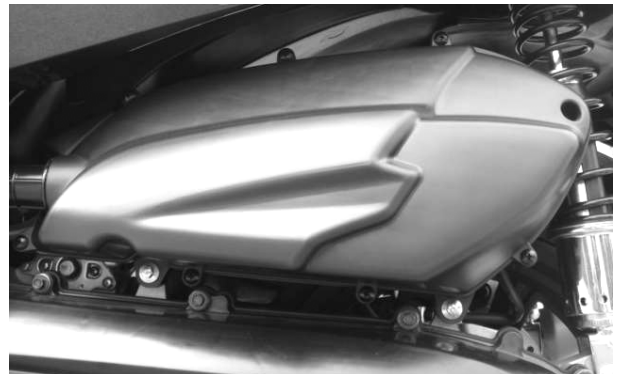

3. INSPECTION/ADJUSTMENT

SPARK PLUG

Remove the spark plug cap and spark plug
 Check the spark plug for wear and fouling deposits.
 Clean any fouling deposits with a spark plug cleaner or a wire brush.

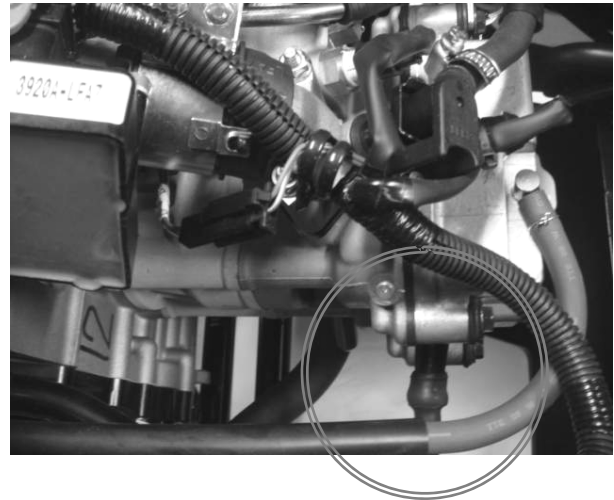

Specified Spark Plug:
 NGK CR7E

Measure the spark plug gap.
Spark Plug Gap: 0.6~0.7 mm

* When installing, first screw in the spark plug by hand and then tighten it with a spark plug wrench.

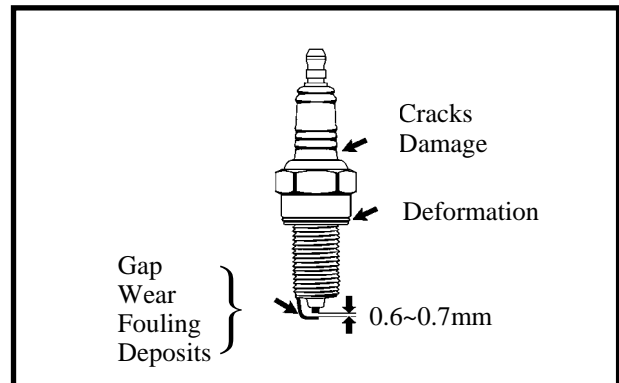

Torque: 0.9 kgf-m (9 N-m)

3. INSPECTION/ADJUSTMENT

VALVE CLEARANCE

- * • Inspect and adjust valve clearance while the engine is cold (below 35°C).

Remove the four bolts , then remove cylinder head cover.

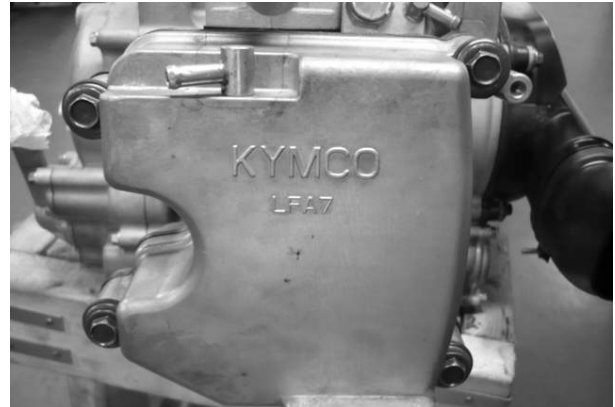

Timing hole cap

Remove the timing hole cap and O-ring
Remove the crankshaft hole cap and O-ring .



Turn the A.C. generator flywheel to the top dead center (TDC) on the compression stroke so that the “T” mark on the flywheel aligns with the index mark on the left crankcase cover.

The punch mark on the camshaft should face upward as shown.

If the punch mark on the camshaft are facing downward, turn the crankshaft one full turn (180°) and the punch mark are facing upward.

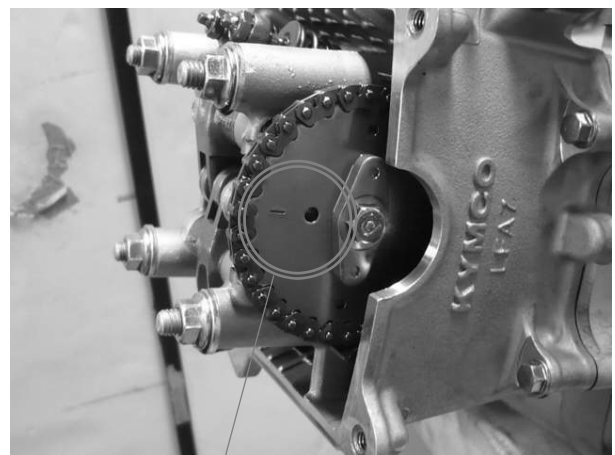

Punch Mark

3. INSPECTION/ADJUSTMENT

Adjust by loosening the valve adjusting screw lock-nut and turning the adjusting screw until there is a slight drag on the thickness gauge .

Valve Clearance: IN: 0.1 mm
EX:0.1 mm

Apply oil to the valve adjusting screw lock-nut threads and seating surface.
Hold the adjusting screw and tighten the lock nut to the specified torque.

Torque: 0.9 kgf-m (9 N-m)

Special tool:

Valve adjuster A120E00036

After tightening the lock-nut, recheck the valve clearance.

Install the removed parts in the reverse order of removal.

IDLE SPEED

*

- It is not necessary to adjust idle speed. The throttle body is factory preset originally, do not loosen or tighten the painted bolts and screws of throttle body. Loosening or tightening them can cause throttle a idle and valve with failure.

Idle Speed:

1800 rpm

3. INSPECTION/ADJUSTMENT

CYLINDER COMPRESSION

Warm up the engine before compression test.
Remove the center cover and spark plug cap.
Remove the spark plug .
Insert a compression gauge.
Open the throttle valve fully and push the starter button to test the compression.

Compression:

15 kg/cm²

If the compression is low, check for the following:

- Leaky valves
- Valve clearance too small
- Leaking cylinder head gasket
- Worn pistons
- Worn piston/cylinder

If the compression is high, it indicates that carbon deposits have accumulated on the combustion chamber and the piston head.

DRIVE BELT

Remove the left crankcase cover.
Inspect the drive belt for cracks or excessive wear.
Replace the drive belt with a new one if necessary and in accordance with the Maintenance Schedule.

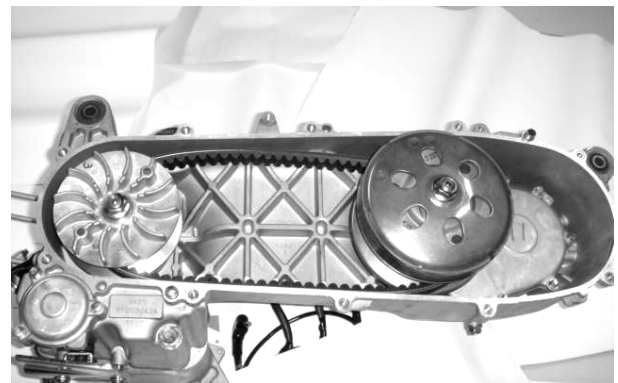

3. INSPECTION/ADJUSTMENT

CLUTCH SHOE WEAR

Start the engine and check the clutch operation by increasing the engine speed gradually.

If the scooter tends to creep, or the engine stalls, check the clutch shoes for wear and replace if necessary (refer to the **“DRIVE PULLEY, DRIVE BELT AND DRIVEN PULLEY”** section in the chapter 8).

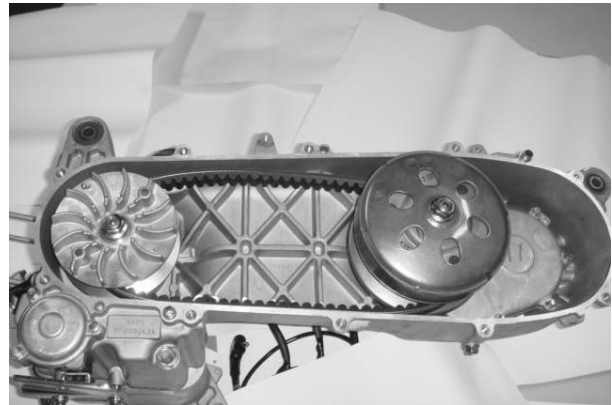

3. INSPECTION/ADJUSTMENT

Coolant level inspection

The reserve tank is under leg shield. Check the coolant level through the reserve tank lid while the engine is at the normal operating temperature, with the scooter in an upright position.

If the coolant level is below the LOWER level mark, remove the left floor mat, remove the lid screw, the reserve tank lid, and then the reserve tank cap to add coolant mixture until it reaches the upper level mark.



Reserve Tank Lid

Lid Screw



Reserve Tank Cap

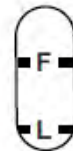

WARNING

Add coolant to the reserve tank only. Do not attempt to add coolant by removing the radiator cap. Coolant in the radiator is under pressure and is very hot and can cause serious burns.

3. INSPECTION/ADJUSTMENT

Brake fluid

Brake fluid level inspection

With the scooter in an upright position, check the front and rear fluid level.

The level should be above the lower level mark. If the level is at or below the lower level mark "L", check the brake pads for wear.

■ **NOTE:** Other checks - make sure there are no fluid leaks. Check for deterioration or cracks in the hoses and fittings.



WARNING



Worn brake pads should be replaced immediately. If the pads are not worn, have your brake system inspected for leaks. Do not ride your scooter unless the brakes are in perfect working order.

Brake fluid type: DOT 4

Brake pad

Brake pad wear inspection

Inspect the brake pad thickness to verify there is enough material for the brakes to function properly.

1. If the wear indicator grooves in the front brake pads are no longer visible , it is an indication that the brake pads are worn and require replacement.
2. If the wear indicator grooves in the rear brake pads are no longer visible , it is an indication that the brake pads are worn and require replacement.



WARNING

The brakes will wear quickly if the lever is continually applied during riding (dragging the brake). Consult your KYMCO dealer for braking system service.

3. INSPECTION/ADJUSTMENT

NUTS/BOLTS/FASTENERS

Check all important chassis nuts and bolts for looseness.

Tighten them to their specified torque values if any looseness is found.

WHEELS/TIRES

Tire pressure

Insufficient air pressure in the tires not only hastens tire wear but also seriously affects the stability of the scooter. Under inflated tires make smooth cornering difficult and overinflated tires decrease the amount of tire in contact with the ground which can lead to skids and loss of control. Be sure that the tire pressure is within the specified limits at all times. Tire pressure should only be adjusted when the tires are cold.

Cold inflation tire pressure

	1 Rider (75 kg)	2 Riders (150 kg)
Front	2.0kg/cm ²	2.0 kg/cm ²
Rear	2.25kg/cm ²	2.25 kg/cm ²

3. INSPECTION/ADJUSTMENT

SUSPENSION

Check the action of the front/rear shock absorbers by compressing them several times. Check the entire shock absorber assembly for oil leaks, looseness or damage.

Jack the rear wheel off the ground and move the rear wheel sideways with force to see if the engine hanger bushings are worn. Replace the engine hanger bushings if there is any looseness.



Rear suspension adjustment

Each shock absorber (1) has 5 adjustment positions for different load or riding conditions.

Use a pin spanner (2) to adjust the rear shocks. Always adjust the shock absorber position in sequence (1-2-3-4-5 or 5-4-3-2-1). Attempting to adjust directly from 1 to 5 or 5 to 1 may damage the shock absorber. Position 1 is for light loads and smooth road conditions. Positions 3 to 5 increase spring preload for a stiffer rear suspension, and can be used when the scooter is heavily loaded. Be certain to adjust both shock absorbers to the same position.

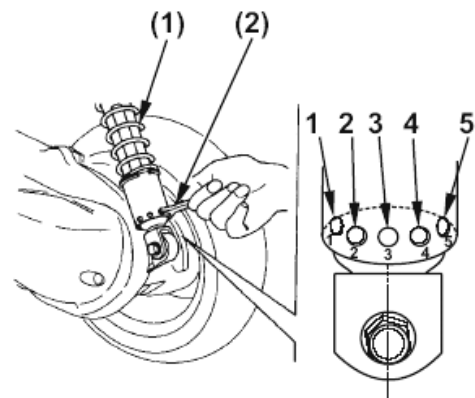

3. INSPECTION/ADJUSTMENT

Side stand

Your scooter's side stand is not only necessary when you park, but it contains an important safety feature. This feature cuts-off the ignition if you try to ride the scooter when the side stand is down. Perform the following side stand inspection.

Interlock function check:

Check the side stand ignition cut-off system:

1. Place the scooter on its center stand.
2. Put the side stand up and start the engine.
3. Lower the side stand. The engine should stop as you put the side stand down.

■ **NOTE:** If the side stand system does not operate as described, see your KYMCO dealer for service.

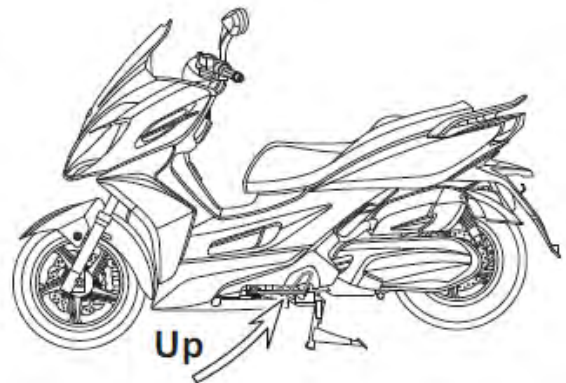

4. LUBRICATION SYSTEM

LUBRICATION SYSTEM DIAGRAM

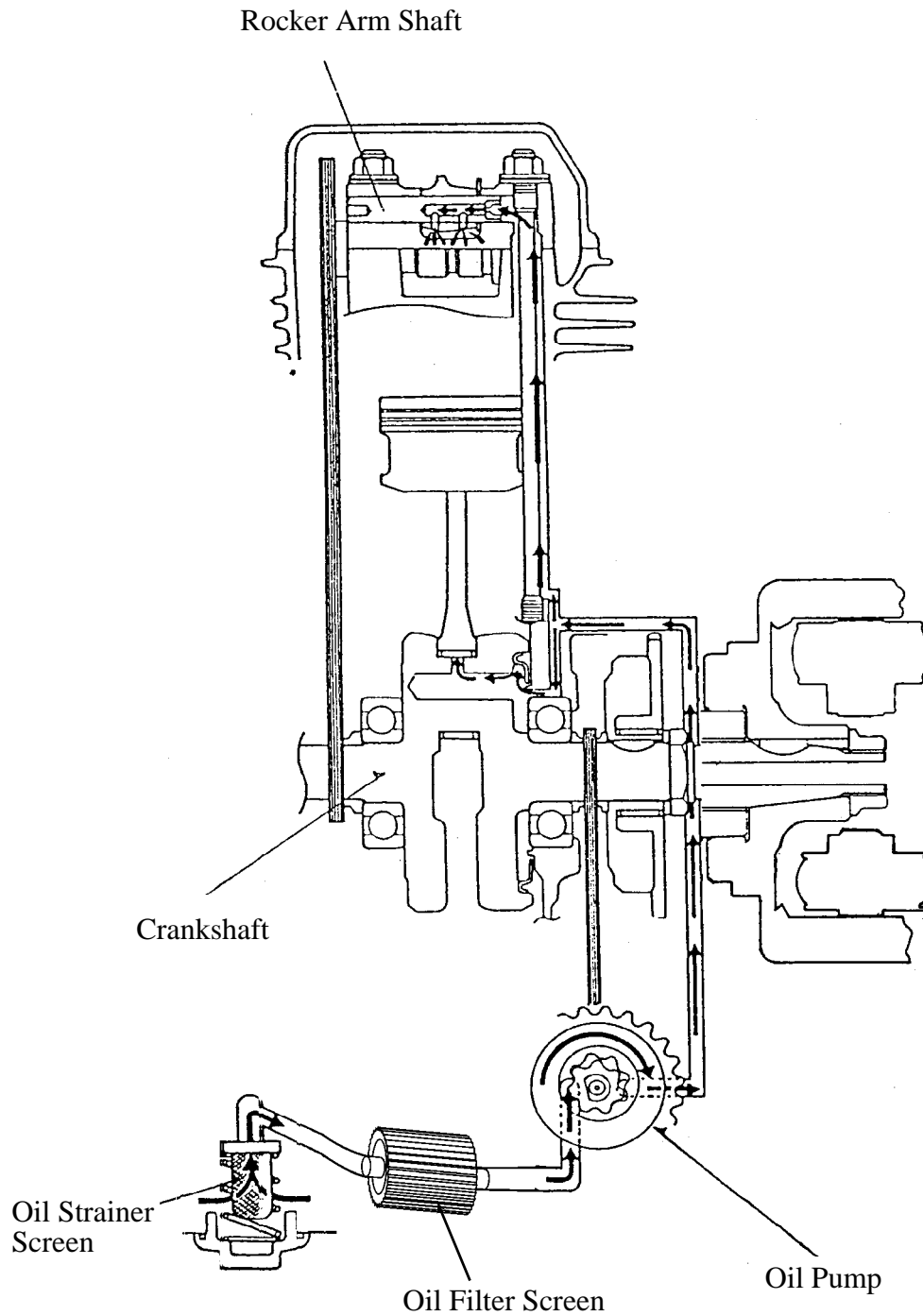

4. LUBRICATION SYSTEM

SERVICE INFORMATION

GENERAL INSTRUCTIONS

- The maintenance of lubrication system can be performed with the engine installed in the frame.
- Drain the coolant before starting any operations.
- Be careful when removing and installing the oil pump not to allow dust and foreign matters to enter the engine and oil line.
- Do not attempt to disassemble the oil pump. The oil pump must be replaced as a set when it reaches its service limit.
- After the oil pump is installed, check each part for oil leaks.

SPECIFICATIONS

Unit: mm

	Standard
Inner rotor-to-outer rotor clearance	0.15
Outer rotor-to-pump body clearance	0.15~0.2
Rotor end-to-pump body clearance	0.04~0.09

ENGINE OIL

Engine Oil Capacity	At disassembly:	1.2 liter
	At change:	1.0 liter
Recommended Oil	SAE15W40 API: SJ	

TROUBLESHOOTING

Oil level too low

- Natural oil consumption
- Oil leaks
- Worn piston rings
- Worn valve guide
- Worn valve guide seal

Poor lubrication pressure

- Oil level too low
- Clogged oil filter or oil passage
- Faulty oil pump

Oil contamination

- Oil not changed often enough
- Faulty cylinder head gasket
- Loose cylinder head bolts

4. LUBRICATION SYSTEM

OIL PUMP

REMOVAL

Remove the flywheel and driven gear (refer to the “**STARTER CLUTCH**” section in the chapter 10).

Remove the bolt and then oil separator cover.

* When removing and installing the oil pump, be careful not to allow dust or dirt to enter the engine.

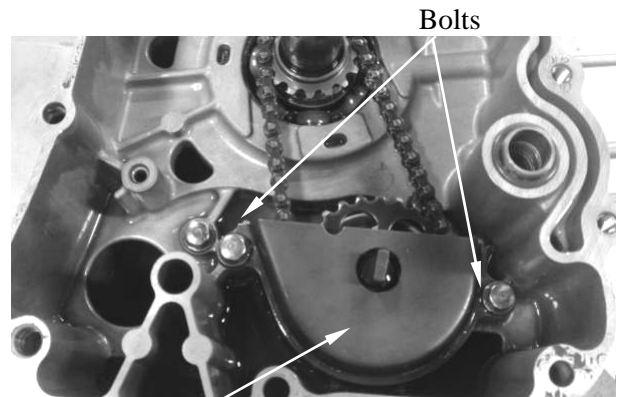

Oil Separator Cover

Pry the snap ring off and remove the oil pump driven gear, then remove the oil pump drive chain.

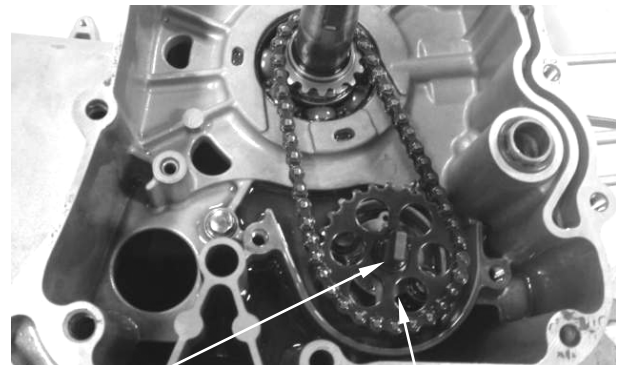

Snap Ring

Oil Pump Driven Gear

Remove the two oil separator bolts to remove the oil pump.

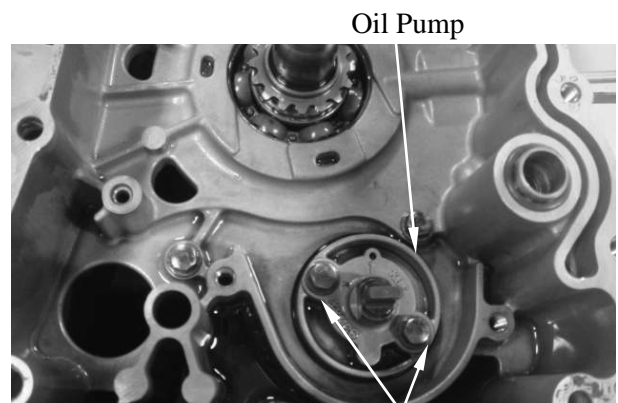

Oil Separator Bolt

4. LUBRICATION SYSTEM

INSTALLATION

Install the oil pump and oil separator and tighten the two bolts.
The arrow mark must be keep upward.

* Make sure the pump shaft rotates freely and arrow on the oil pump is upside.

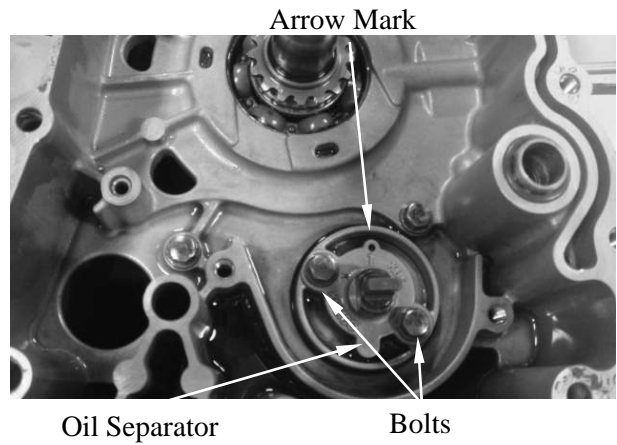

Install the pump drive chain and driven gear, then set the snap ring securely on the pump shaft.



Snap Ring

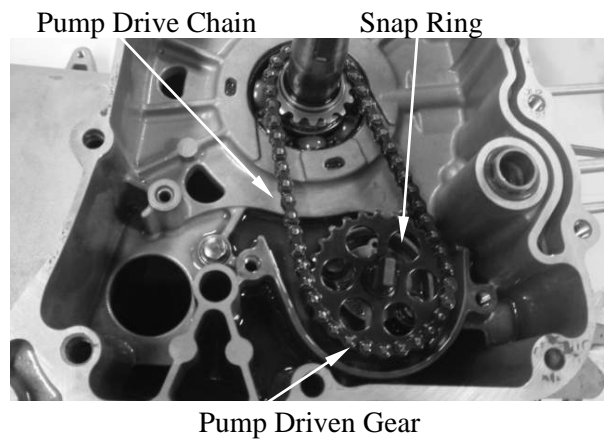

Pump Driven Gear

Install the oil separator cover properly.

* Fit the tab of the separator cover into the slit in the separator.

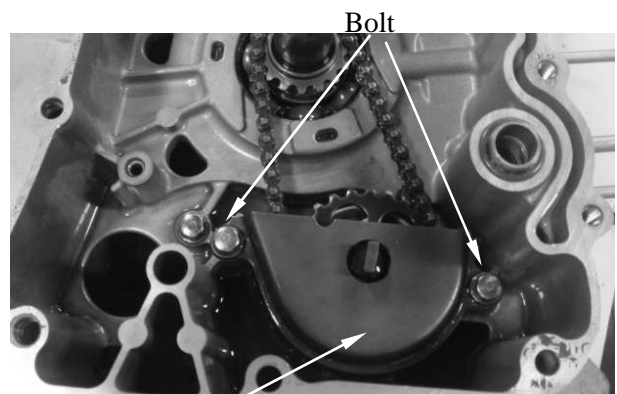

Oil Separator Cover

4. LUBRICATION SYSTEM

DISASSEMBLY

Remove the screw and disassemble the oil pump as shown.

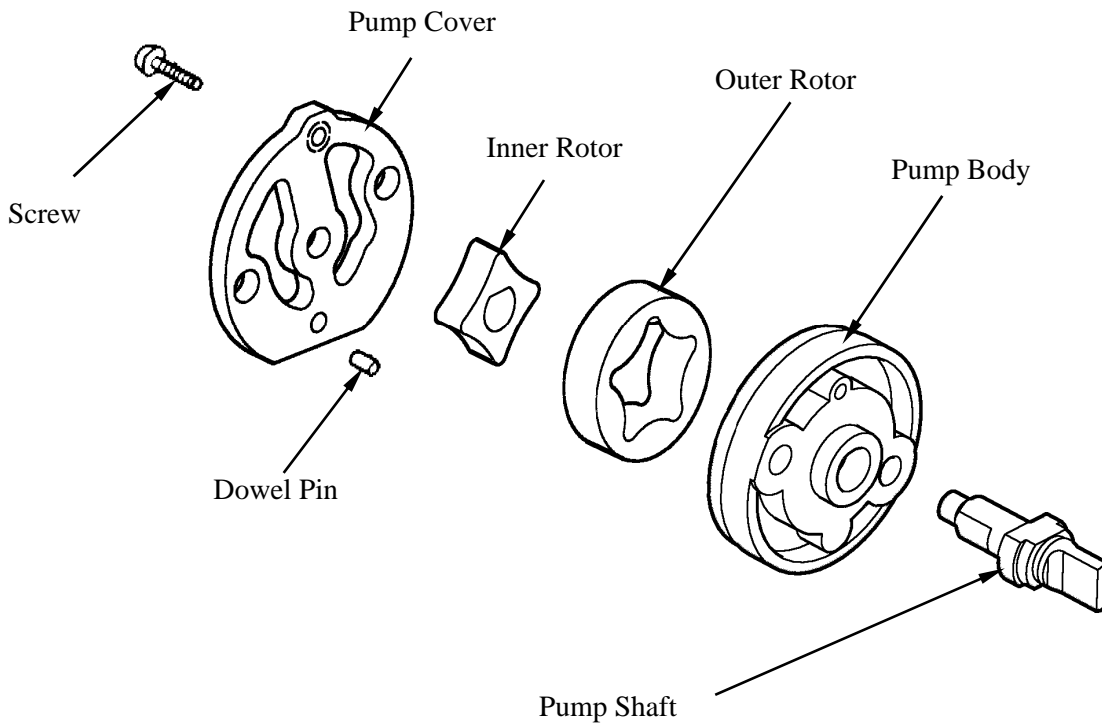

ASSEMBLY

Install the outer rotor, inner rotor and pump shaft into the pump body.

* Insert the pump shaft by aligning the flat on the shaft with the flat in the inner rotor. Install the dowel pin.

There is one punch mark on the surface of the inner rotor and outer rotor.

The mark is upside.

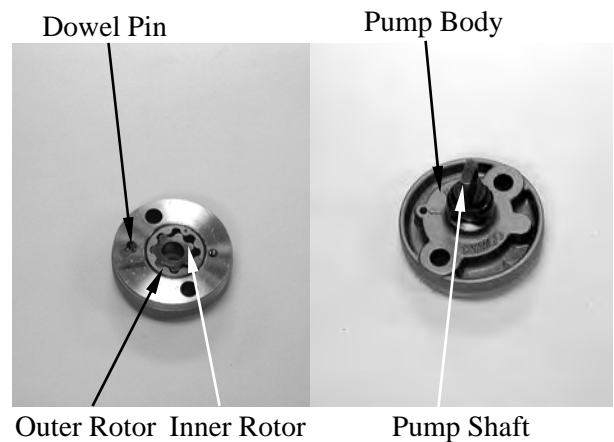

5. ENGINE REMOVAL/INSTALLATION

5

ENGINE REMOVAL/INSTALLATION

SERVICE INFORMATION-----	5-1
ENGINE REMOVAL/INSTALLATION-----	5-2
ENGINE HANGER -----	5-8

5. ENGINE REMOVAL/INSTALLATION

SERVICE INFORMATION

GENERAL INSTRUCTIONS

- A floor jack or other adjustable support is required to support and maneuver the engine. Be careful not to damage the scooter body, cables and wires during engine removal.
- Use shop towels to protect the scooter body during engine removal.
- Drain the coolant before removing the engine.
- After the engine is installed, fill the cooling system with coolant and be sure to bleed air from the water jacket. Start the engine to check for coolant leaks.
- Before removing the engine, the rear brake caliper must be removed first. Be careful not to bend or twist the brake fluid tube.

SPECIFICATIONS

Engine oil capacity: at disassembly: 1.2 L (1.27 US qt)
: at change: 1.0 L (1.06 US qt)

TORQUE VALUES

Engine hanger (Engine side)	5 kgf-m (50 N-m)
Engine hanger (Frame side)	6.5 kgf-m (65 N-m)

5. ENGINE REMOVAL/INSTALLATION

K-XCT 125i

ENGINE REMOVAL/INSTALLATION

REMOVAL

*

Remove the air cleaner
 Disconnect the ECU connector (A)
 Disconnect the O2 heater/O2 sensor connector
 Disconnect the throttle cable(B)

(A)

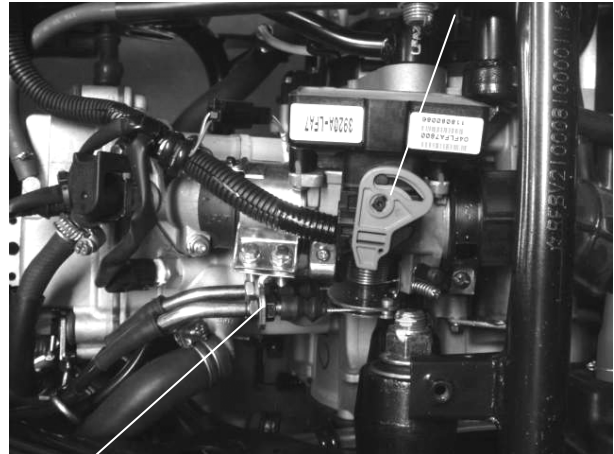

(B)

(G)

*

Remove a bolt from fuel hose guide (C).
 Disconnect the fuel hose (D) from fuel injector.
 Disconnect the WTS connector (E) from WTS.
 Disconnect the coolant temperature sensor connector (F) from coolant temperature sensor.
 Disconnect the fuel injector connector(G)
 Disconnect the output water hose(H)
 Disconnect the air bleed hose(I)

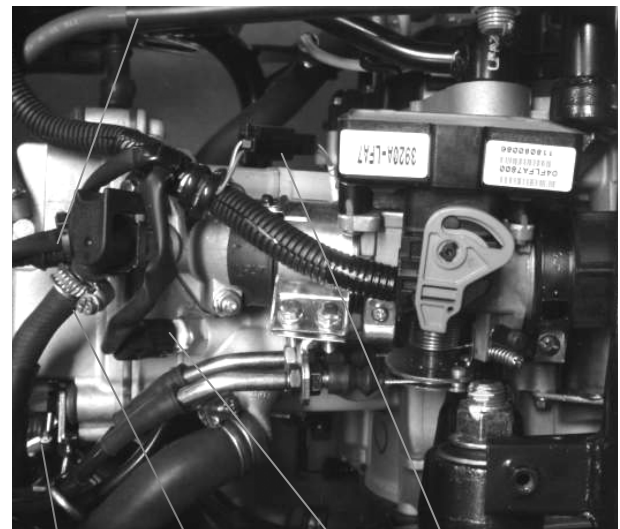

(C)

(D)

(E)

(F)

(I)

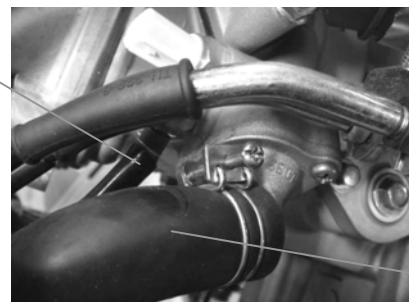

(H)

5. ENGINE REMOVAL/INSTALLATION

Loosen the rear axle nut.
Support the scooter securely on its main stand.

Remove bolts attaching to rear brake hose clamps.
Remove two bolts, then remove the rear brake caliper.



Disconnect the alternator connector.
Disconnect the ignition pulse generator connector.



Release the rubber cap and remove the terminal screw to disconnect the start motor cable from the start motor.



5. ENGINE REMOVAL/INSTALLATION

Remove the bolts and engine ground cable.

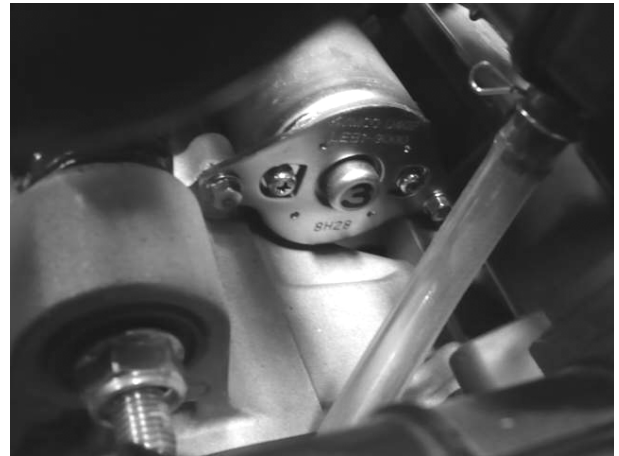

Remove the spark plug cap .

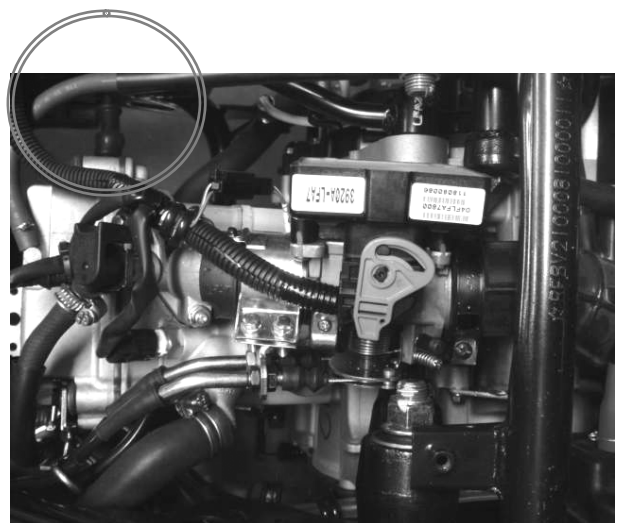

5. ENGINE REMOVAL/INSTALLATION

Disconnect the lower radiator hose from lower radiator pipe.

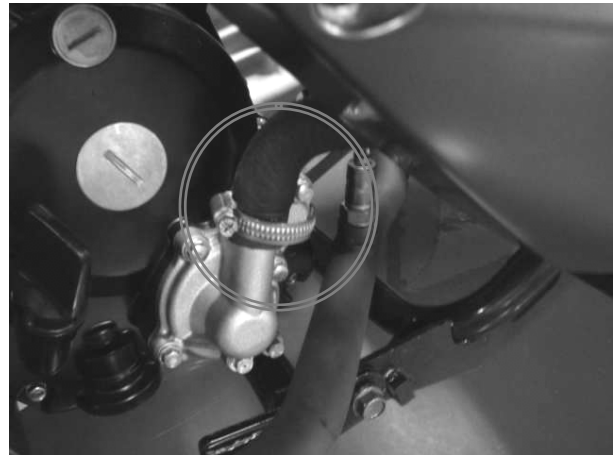

Remove the right and left rear shock absorber lower mount bolts .



5. ENGINE REMOVAL/INSTALLATION

Remove the engine mount nut
Pull out the engine mount bolt.



Remove the engine from the frame.

* At removing the engine, be careful not to catch your hand or finger between the engine hanger and crankcase.

5. ENGINE REMOVAL/INSTALLATION

INSTALLATION

Installation is in the reverse order of removal.

Tighten the engine mounting bolt/nut to the specified torque.

Torque: 5 kgf-m (50 N-m)

Tighten the right and left rear shock absorber lower mount bolts to the specified torque.

Torque: 4.0kgf-m (40N-m)

Install the rear brake caliper and tighten the mount bolts to the specified torque.

Torque: 3.2 kgf-m (32 N-m, 23 lbf-ft)

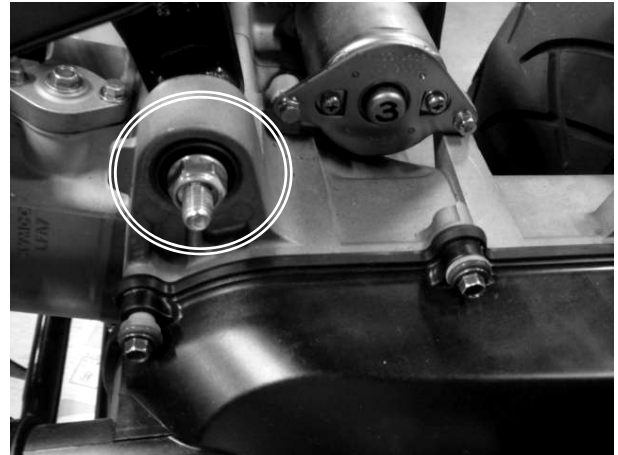

After installation, inspect and adjust the following:

- Throttle grip free play
- Fill the cooling system with coolant and start the engine to bleed air from the system.

API/ABV Reset.

5. ENGINE REMOVAL/INSTALLATION

ENGINE HANGER

REMOVAL

Remove the engine mount nut .
Pull the engine mount bolt out.

* Be careful to put the engine down.

Remove the left engine hanger mount bolt .
Remove the right engine hanger mount bolt and collar .
Remove the engine from frame.

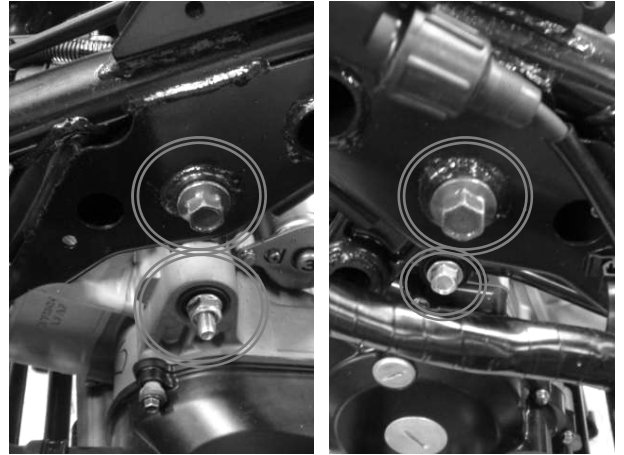

INSTALLATION

Installation is in the reverse order of removal.

Tighten the engine hanger mount bolts to the specified torque.(engine side)

Torque: 5 kgf-m (50 N-m)

Tighten the engine mount bolt/nut to the specified torque. (frame side)

Torque: 5 kgf-m (50 N-m, 36 lbf-ft)

6. CYLINDER HEAD/VALVES

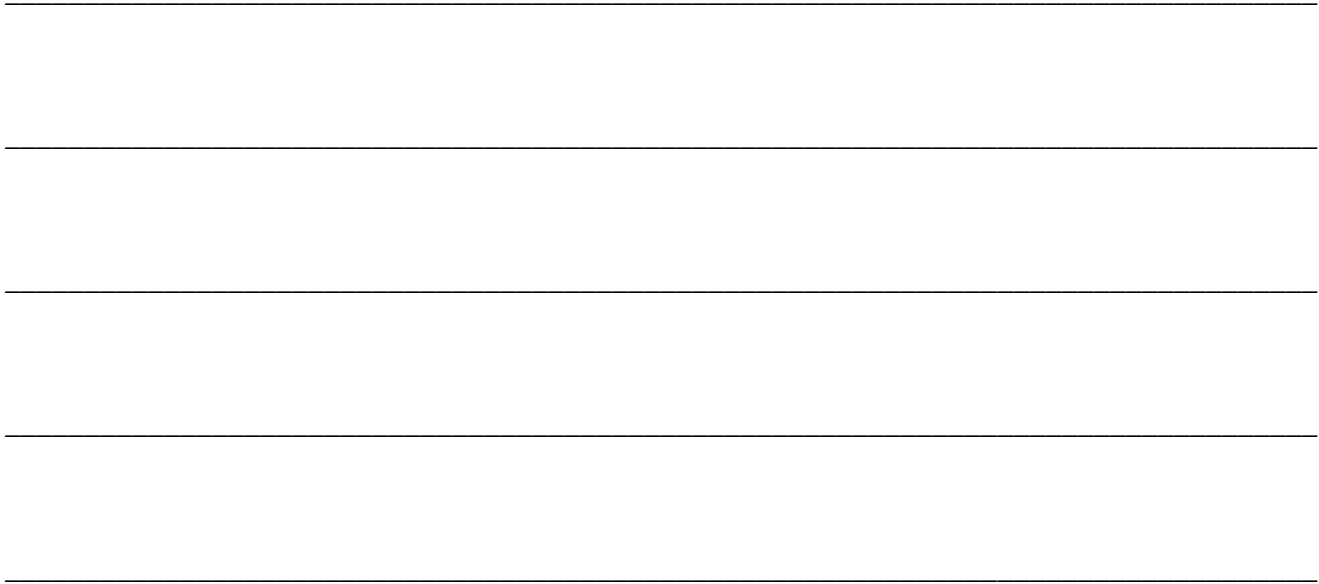

CYLINDER HEAD/VALVES



SCHEMATIC DRAWING -----	6- 1
SERVICE INFORMATION-----	6- 2
TROUBLESHOOTING-----	6- 3
CYLINDER HEAD COVER-----	6- 4
CAMSHAFT HOLDER-----	6- 5
CAMSHAFT -----	6- 8
CYLINDER HEAD-----	6- 13

6. CYLINDER HEAD/VALVES

SCHEMATIC DRAWING

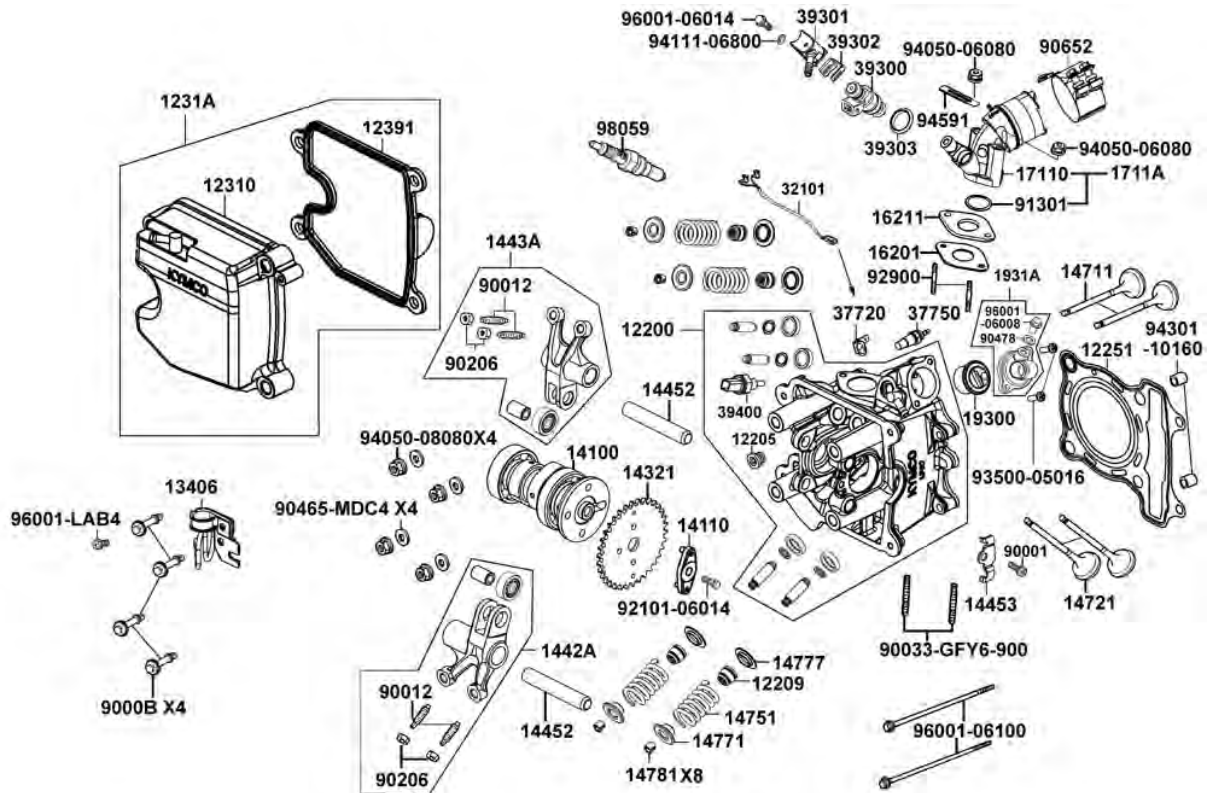

6. CYLINDER HEAD/VALVES

SERVICE INFORMATION

GENERAL INSTRUCTIONS

- The cylinder head can be serviced with the engine installed in the frame. Coolant in the radiator and water jacket must be drained first.
- When assembling, apply molybdenum disulfide grease or engine oil to the valve guide movable parts and valve arm sliding surfaces for initial lubrication.
- The valve rocker arms are lubricated by engine oil through the cylinder head engine oil passages. Clean and unclog the oil passages before assembling the cylinder head.
- After disassembly, clean the removed parts and dry them with compressed air before inspection.
- After removal, mark and arrange the removed parts in order. When assembling, install them in the reverse order of removal.

SPECIFICATIONS

Unit: mm

Item		Standard
Valve clearance (cold)	IN	0.1
	EX	0.1
Cylinder head compression pressure		15kg/cm ²
Cylinder head warpage		—
Camshaft cam height	IN	25.965
	EX	25.810
Valve rocker arm I.D.	IN	10.0~10.015
	EX	10.0~10.015
Valve rocker arm shaft O.D.	IN	9.972~9.987
	EX	9.972~9.987
Valve stem O.D.	IN	4.975~4.970
	EX	4.975~4.970
Valve guide I.D.	IN	5.0~5.012
	EX	5.0~5.012
Valve stem-to-guide clearance	IN	0.010~0.037
	EX	0.030~0.057

TORQUE VALUES

Cylinder head cover bolt	0.8~0.9 kgf-m
Tensioner mounting bolt	0.9 kgf-m
Tensioner sealing bolt	0.9 kgf-m

Cylinder head cap nut 2 kgf-m

Apply engine oil to threads

Cylinder head bolt 0.7~1.1 kgf-m

6. CYLINDER HEAD/VALVES

SPECIAL TOOLS

Valve spring compressor A120E00040

TROUBLESHOOTING

- The poor cylinder head operation can be diagnosed by a compression test or by tracing engine

Poor performance at idle speed

- Compression too low

Compression too low

- Incorrect valve clearance adjustment
- Burned or bend valves
- Incorrect valve timing
- Broken valve spring
- Poor valve and seat contact
- Leaking cylinder head gasket
- Warped or cracked cylinder head
- Poorly installed spark plug

Compression too high

- Excessive carbon build-up in combustion chamber

White smoke from exhaust muffler

- Worn valve stem or valve guide
- Damaged valve stem oil seal

Abnormal noise

- Incorrect valve clearance adjustment
- Sticking valve or broken valve spring
- Damaged or worn camshaft
- Worn cam chain tensioner
- Worn camshaft and rocker arm

6. CYLINDER HEAD/VALVES

CYLINDER HEAD COVER

REMOVAL

Remove four bolts then remove the cylinder head cover.

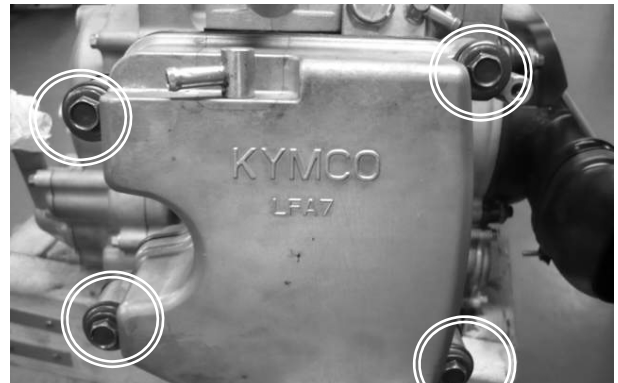

INSTALLATION

Install a new cylinder head cover O-ring and install the cylinder head cover.

* Be sure to install the O-ring into the groove properly.

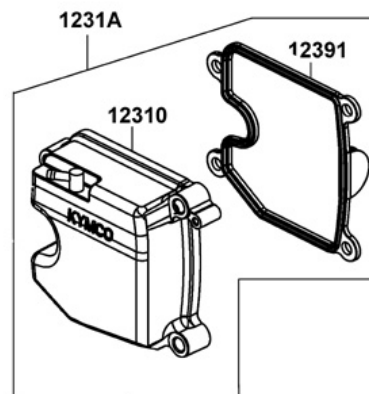

Install and tighten the cylinder head cover bolts to the specified torque in a crisscross pattern.

Torque: 0.8~0.9kgf-m

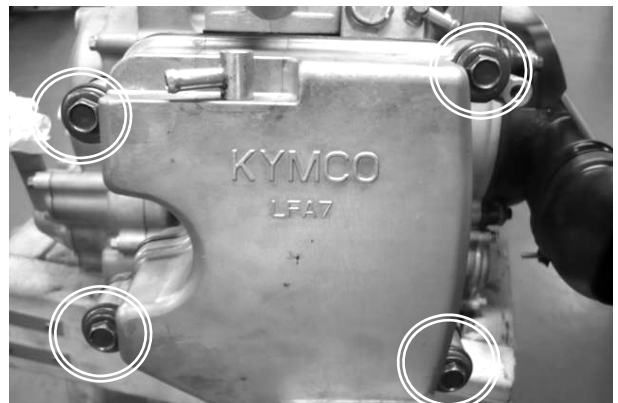

6. CYLINDER HEAD/VALVES

CAMSHAFT HOLDER

REMOVAL

Turn the A.C. generator flywheel so that the T mark on the flywheel aligns with the index mark on the crankcase.

Hold the round hole on the camshaft gear facing up and location is the top dead center on the compression stroke.

Remove two bolts attaching cam chain tensioner.

Remove four nuts of camshaft holder and remove the sprocket fixed nut then remove the sprocket.

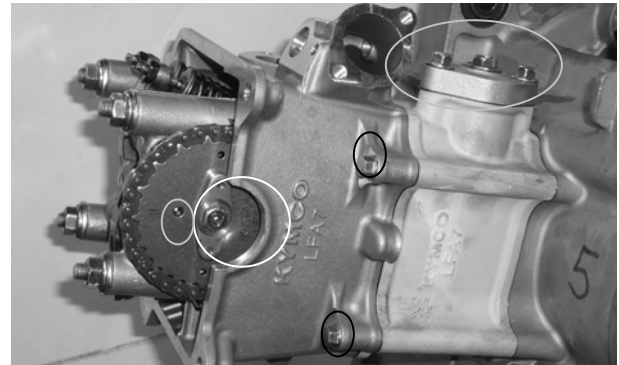

Remove the camshaft gear bolt.

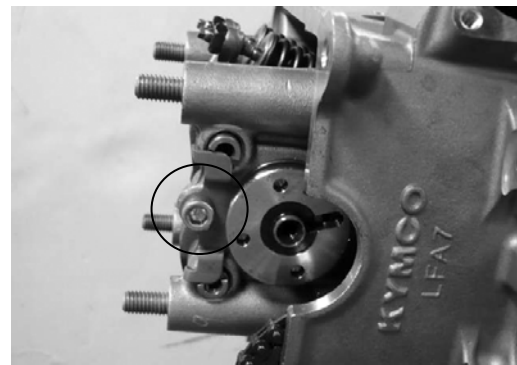

INSTALLATION

Install the camshaft gear bolt and holder washers and nuts.

Tighten four cylinder head nuts to the specified torque.

Torque:

0.7~1.1 kgf-m (Holder nuts)

1.0~1.4 kgf-m (Cam shaft set plate)

1.8~2.2 kgf-m (Cylinder head M8X1.25)

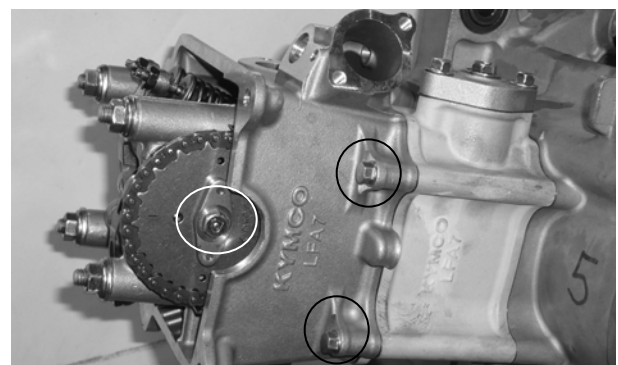

- *
 - Install the camshaft holder with the “EX” mark face exhaust valve side.
 - Apply engine oil to the threads of the cylinder head cap nuts.
 - Diagonally tighten the cylinder head nuts in 2~3 times.

6. CYLINDER HEAD/VALVES

DISASSEMBLY

Take out the valve rocker arm shafts
Remove the valve rocker arms.



Rocker Arm Shafts

INSPECTION

Inspect the camshaft holder, valve rocker arms and rocker arm shafts for wear or damage.

* If the valve rocker arm contact surface is worn, check each cam lobe for wear or damage.

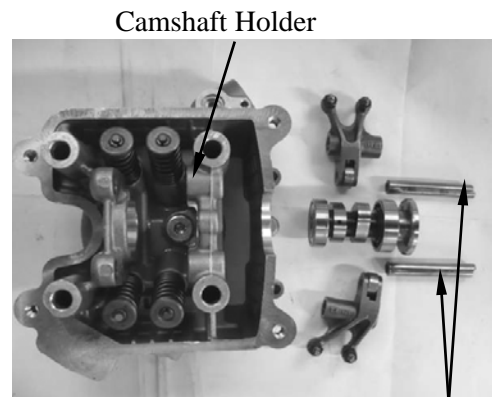

Rocker Arm Shafts

Inspect the rocker arm bore, cam lobe contact surface and adjuster surface for wear/pitting/scratches/blue discoloration.

If any defects are found, replace the rocker arm shaft with a new one, then inspect lubrication system.

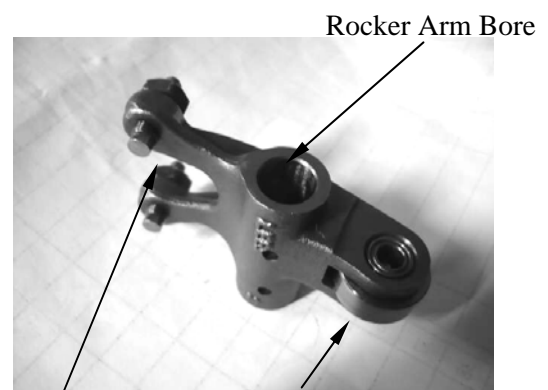

Adjuster Surface

Contact Surface

6. CYLINDER HEAD/VALVES

ASSEMBLY

Apply engine oil to the rocker arms and rocker arm shafts.

Install the rocker arms and shafts into the camshaft holder.

- Install the exhaust valve rocker arm shaft on the “EX” side of the camshaft holder
- Clean the intake valve rocker arm shaft off any grease before installation.

Rocker Arm Shafts

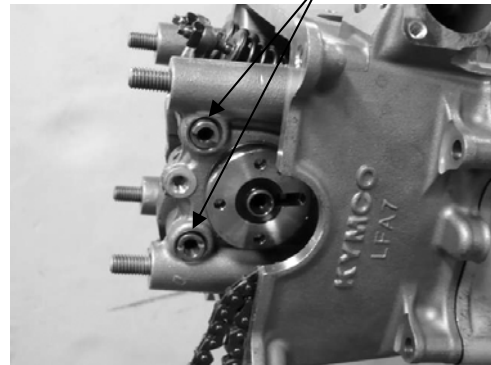

6. CYLINDER HEAD/VALVES

CAMSHAFT

REMOVAL

Turn the A.C. generator flywheel so that the “T” mark on the flywheel aligns with the index mark on the crankcase.

Hold the round hole on the camshaft gear facing up and the location is the top dead center on the compression stroke.

Remove the tensioner sealing bolt and spring. Remove the two bolts from cam chain tensioner and then remove the tensioner and gasket.

Remove the camshaft gear and bolt.

Remove the camshaft from the cylinder head

Tensioner Sealing Bolt

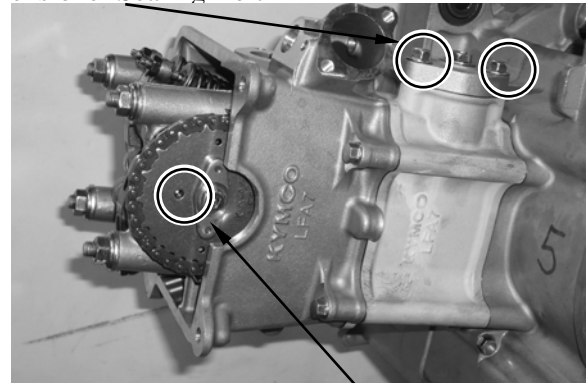

Round Hole

Camshaft

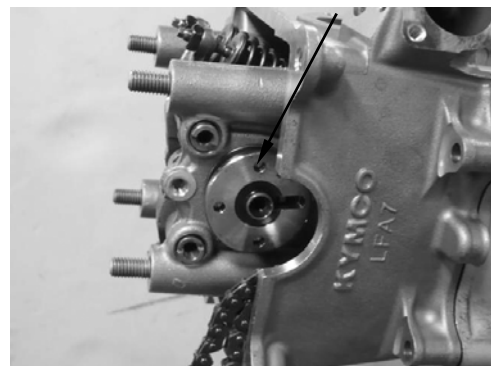

6. CYLINDER HEAD/VALVES

INSPECTION

Camshaft

Inspect camshaft lobes for pitting/scratches/blue discoloration.



If any defects are found, replace the camshaft with a new one, then inspect lubrication system.

Check each camshaft bearing for play or damage. Replace the camshaft assembly with a new one if the bearings are noisy or have excessive play.

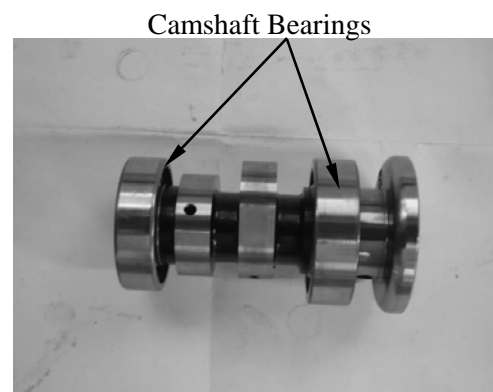

6. CYLINDER HEAD/VALVES

INSTALLATION

Turn the A.C. generator flywheel so that the “T” mark on the flywheel aligns with the index mark on the crankcase.

Keep the round hole on the camshaft gear facing up and align the punch marks on the camshaft gear with the cylinder head surface (Position the intake and exhaust cam lobes down.) and install the cam chain onto the camshaft gear.

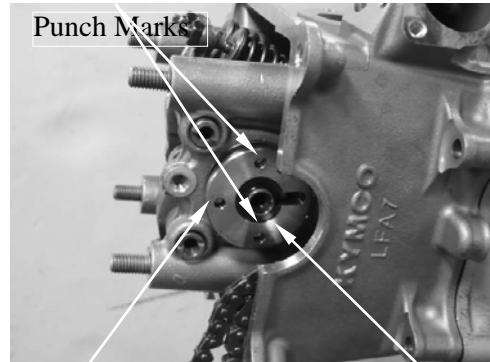

Round Hole

Cam shaft

Install the rocker arms shafts fixed bolt .

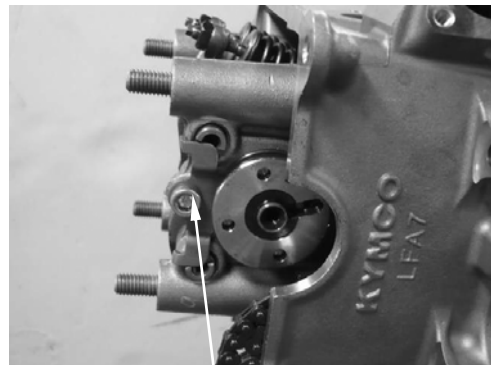

Bolt

Install the camshaft gear

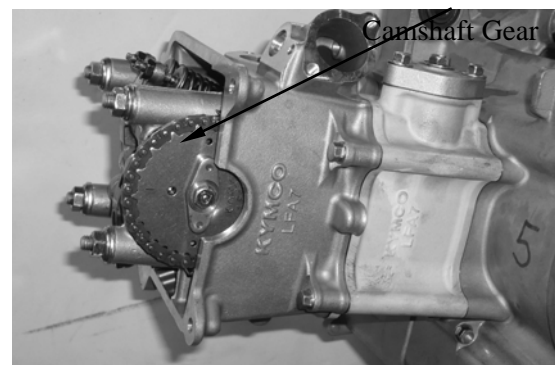

6. CYLINDER HEAD/VALVES

DISASSEMBLY

Remove the valve spring cotters, retainers, springs, spring seats, oil seals and valves using a valve spring compressor.

- *
- Be sure to compress the valve springs with a valve spring compressor.
 - Mark all disassembled parts to ensure correct reassembly.

Special tool:
Valve Spring Compressor A120E00040

Valve Spring Compressor

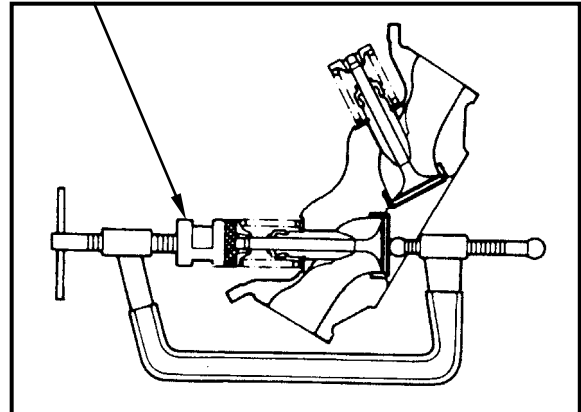

Valves

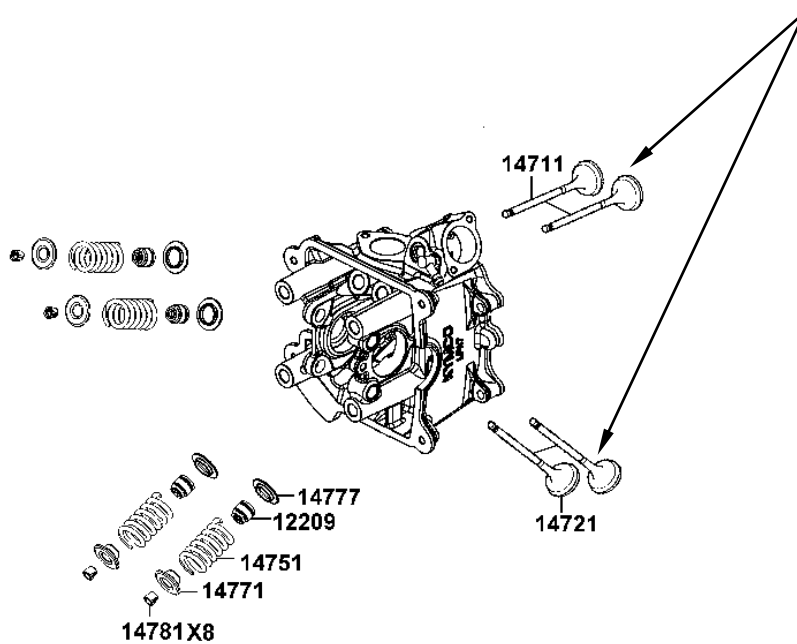

6. CYLINDER HEAD/VALVES

INSPECTION

Remove carbon deposits from the exhaust port and combustion chamber.

- * Be careful not to damage the cylinder head mating surface.

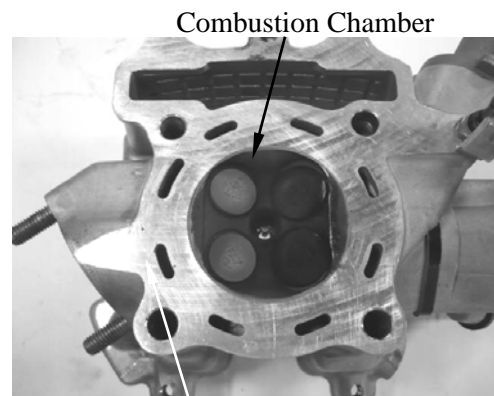

Exhaust Port

Valve /Valve guide

Inspect each valve for bending, burning, scratches or abnormal stem wear. If any defects are found, replace the valve with a new one.

- * If the stem-to-guide clearance exceeds the service limits, replace the cylinder head is necessary.

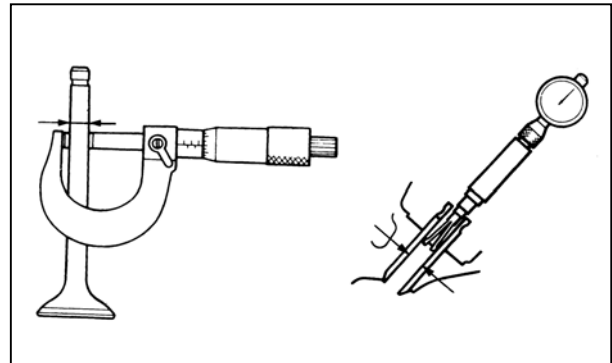

Valve spring

Measure the free length of the inner and outer valve springs.

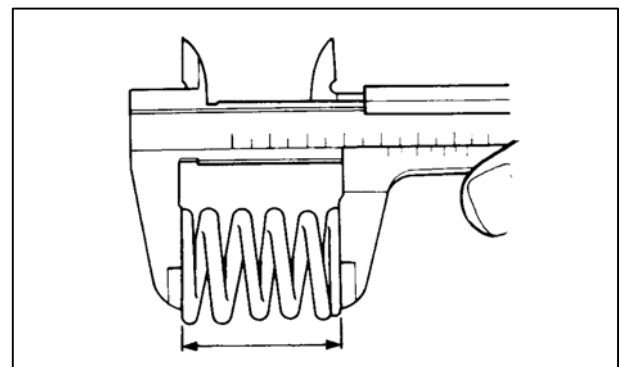

6. CYLINDER HEAD/VALVES

Cylinder head

Check the spark plug hole and valve areas for cracks.

Check the cylinder head for warpage with a straight edge and feeler gauge.

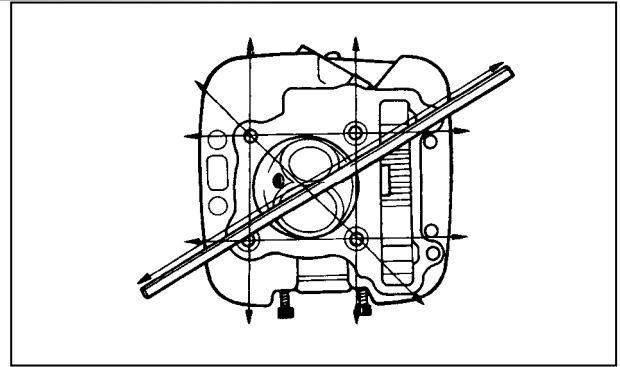

ASSEMBLY

Install the valve spring seats and oil seal.

* Be sure to install the new oil seals.

Lubricate each valve with engine oil and insert the valves into the valve guides. Install the valve springs and retainers. Compress the valve springs using the valve spring compressor, then install the valve cotters.

* When assembling, a valve spring compressor must be used.

Valve Spring Compressor

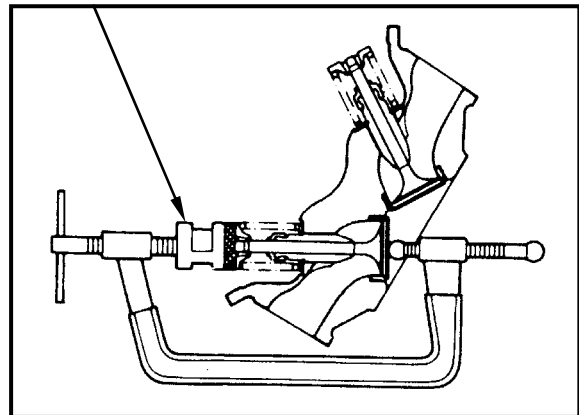

Special tool:

Valve Spring Compressor A120E00040

Tap the valve stems gently with a plastic hammer for 2~3 times to firmly seat the cotters.

* Be careful not to damage the valves.

Plastic Hammer

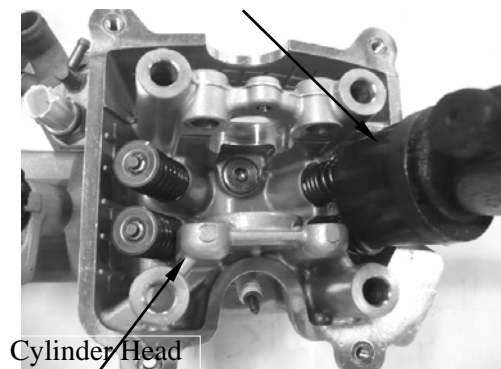

Cylinder Head

7. CYLINDER/PISTON

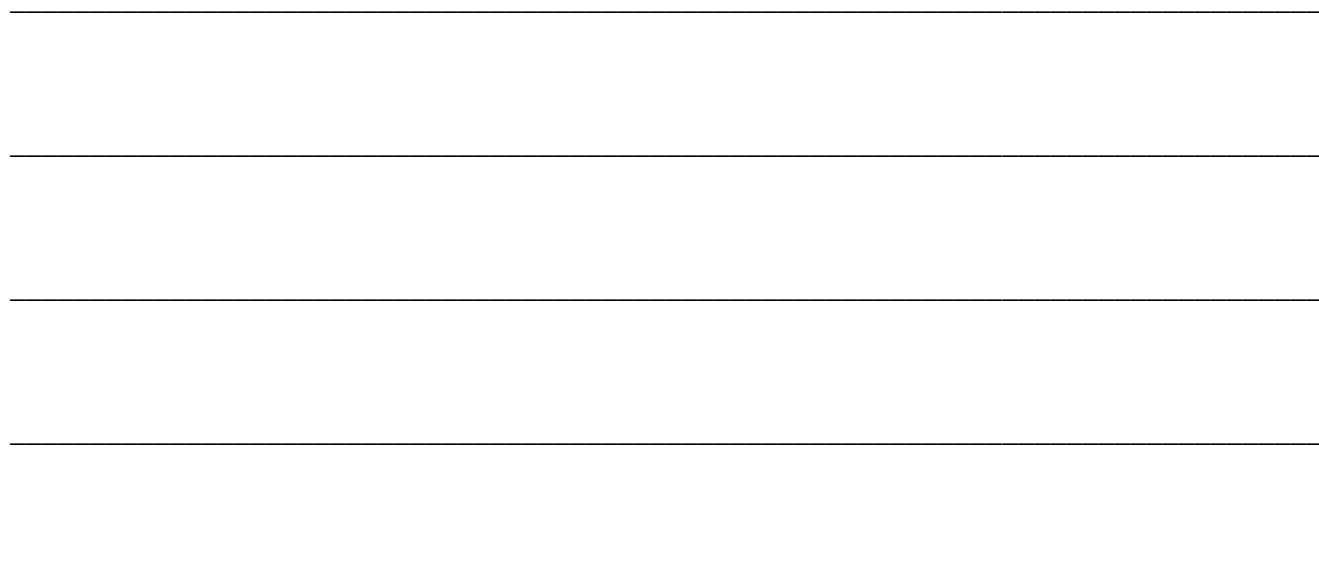

CYLINDER/PISTON

SCHEMATIC DRAWING	7-1
SERVICE INFORMATION.....	7-2
TROUBLESHOOTING.....	7-3
CYLINDER AND PISTON	7-4



7. CYLINDER/PISTON

SCHEMATIC DRAWING

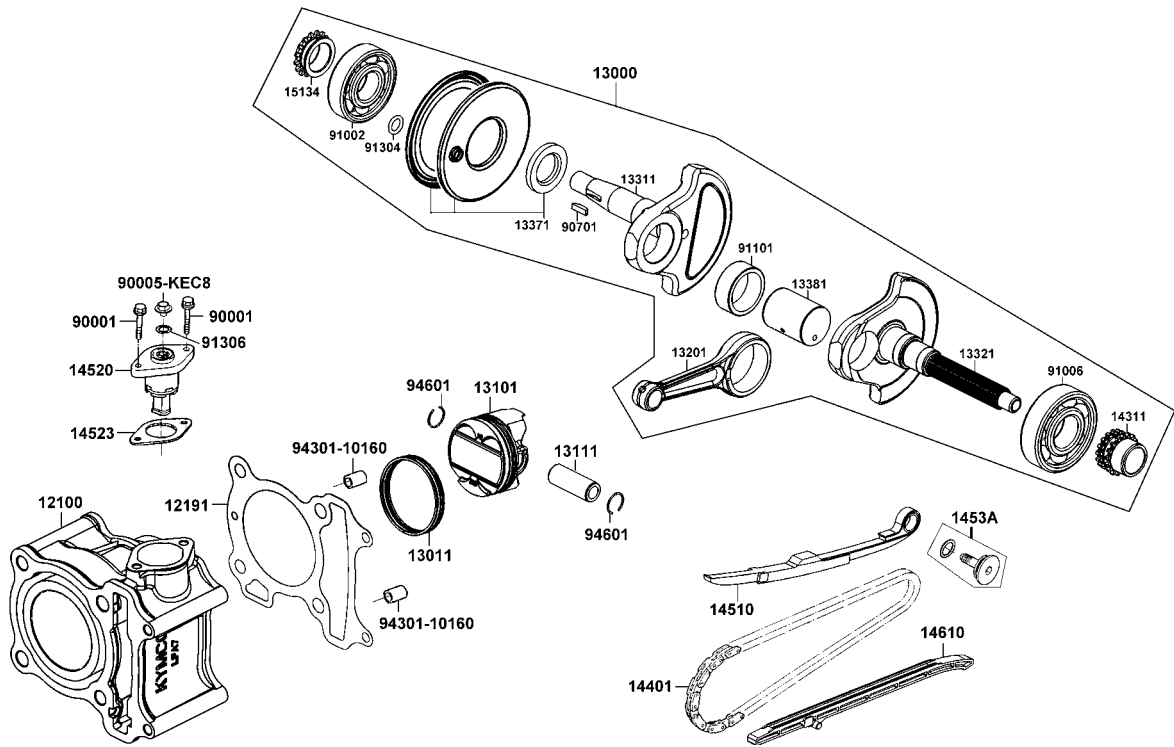

7. CYLINDER/PISTON

SERVICE INFORMATION

GENERAL INSTRUCTIONS

- When installing the cylinder, use a new cylinder gasket and make sure that the dowel pins are correctly installed.
- After disassembly, clean the removed parts and dry them with compressed air before inspection.

SPECIFICATIONS

Unit: mm

Item		Standard	
Cylinder	I.D.	52.4~52.41	
	Warpage	—	
	Cylindricity	—	
	True roundness	—	
Piston, piston ring	Ring-to-groove clearance	Top	0.015~0.055
		Second	0.015~0.055
	Ring end gap	Top	0.10~0.25
		Second	0.10~0.25
		Oil side rail	0.2~0.7
	Piston O.D.		52.37~52.39
	Piston O.D. measuring position		9 mm from bottom of skirt
	Piston-to-cylinder clearance		0.01~0.04
	Piston pin hole I.D.		15.002~15.008
Piston pin O.D		14.994~15	
Piston-to-piston pin clearance		0.002~0.014	
Connecting rod small end I.D. bore		15.016~15.034	

7. CYLINDER/PISTON

TROUBLESHOOTING

- When hard starting or poor performance at low speed occurs, check the crankcase breather for white smoke. If white smoke is found, it means that the piston rings are worn, stuck or broken.

Compression too low or uneven compression

- Worn or damaged cylinder and piston rings
- Worn, stuck or broken piston rings

Compression too high

- Excessive carbon build-up in combustion chamber or on piston head

Excessive smoke from exhaust muffler

- Worn or damaged piston rings
- Worn or damaged cylinder and piston

Abnormal noisy piston

- Worn cylinder, piston and piston rings
- Worn piston pin hole and piston pin
- Incorrectly installed piston

7. CYLINDER/PISTON

CYLINDER AND PISTON

REMOVAL

Remove the cylinder head (refer to “**CYLINDER HEAD**” section in the chapter 6).

Remove the water hose attached the cylinder.

Remove the cylinder.

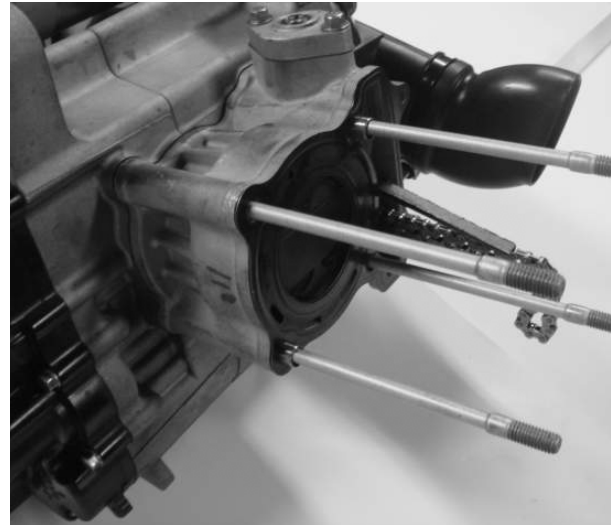

Remove the cylinder gasket (4) and dowel pins (3).
Clean any gasket material onto the cylinder surface.



Remove the piston pin clip

* Place a clean shop towel in the crankcase to keep the piston pin clip from falling into the crankcase.

Press the piston pin out of the piston and remove the piston .



7. CYLINDER/PISTON

Spread each piston ring and remove it by lifting up at a point opposite the gap

* Do not damage the piston ring by spreading the ends too far.

Clean carbon deposits from the piston ring grooves.

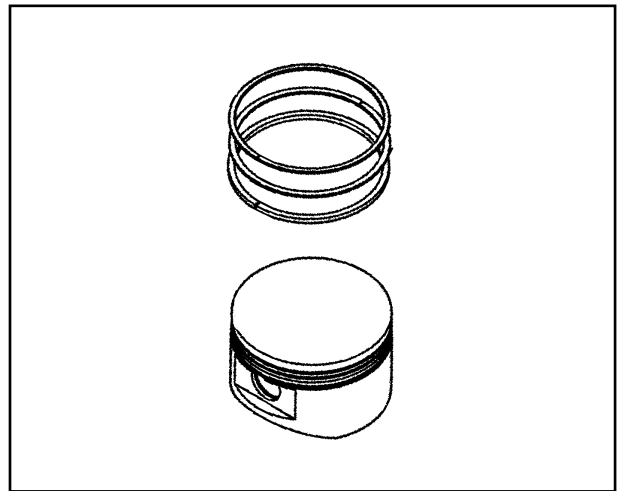

INSPECTION

Piston ring

Inspect the piston rings for movement by rotating the rings. The rings should be able to move in their grooves without catching.

Push the ring until the outer surface of the piston ring is nearly flush with the piston and measure the ring-to-groove clearance.

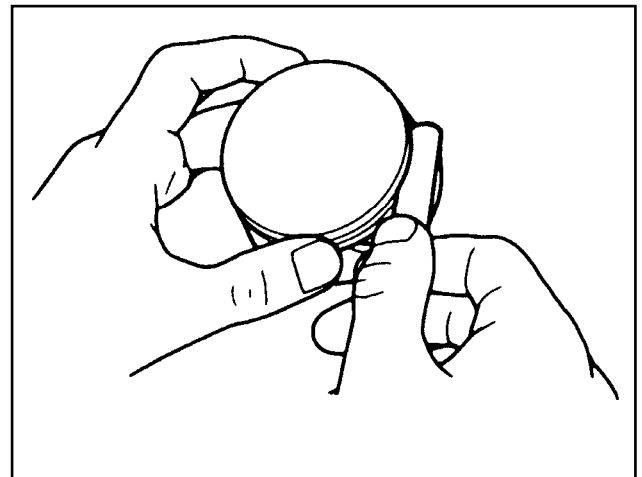

Insert each piston ring into the bottom of the cylinder squarely.

* Use the piston head to push each piston ring into the cylinder.

Measure the piston ring end gap.

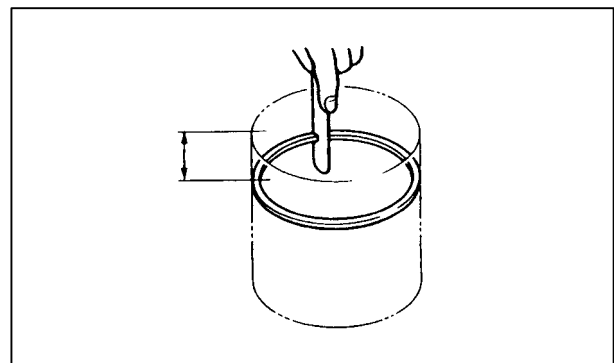

7. CYLINDER/PISTON

Piston/Piston pin

Measure the piston O.D. at the point (A) from the bottom and 90° to the piston pin hole.

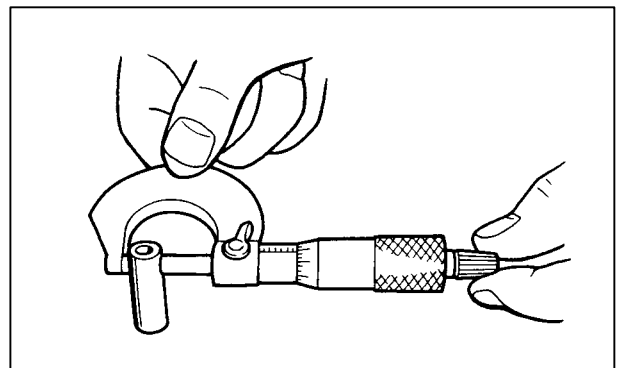
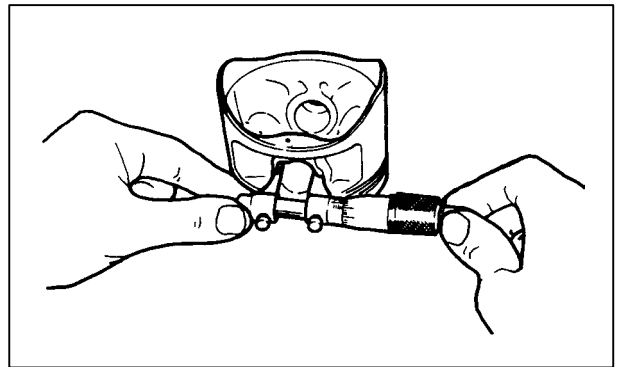
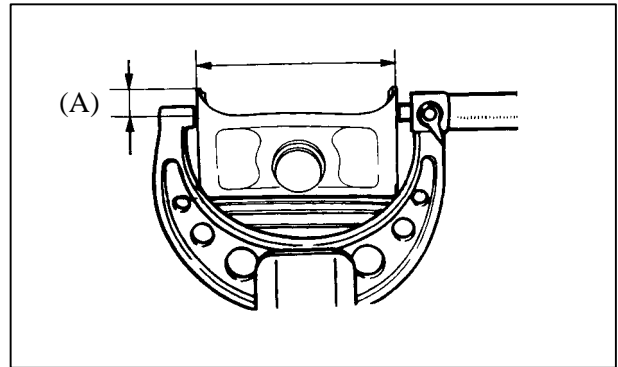

7. CYLINDER/PISTON

Cylinder

Check the cylinder for warpage with a straight edge and feeler gauge in the directions shown.



Check the cylinder wall for wear or damage. Measure and record the cylinder I.D. at three levels in an X and Y axis. Take the maximum reading to determine the cylinder wear.

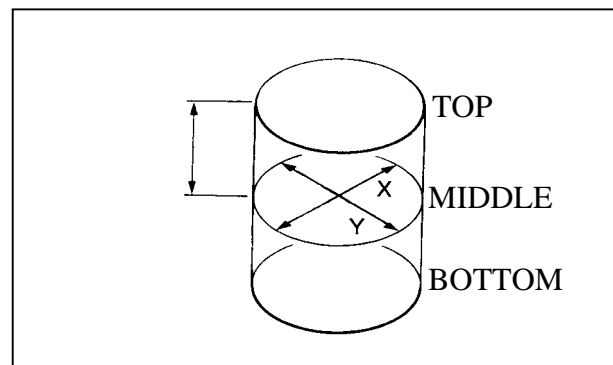

Measure the piston-to-cylinder clearance. Take a maximum reading to determine the clearance.

Measure the taper and out-of-round at three levels in an X and Y axis. Take the maximum reading to determine them.

Measure the connecting rod small end I.D.

Measure the connecting rod-to-piston pin clearance.



7. CYLINDER/PISTON

Inspect the exhaust side and intake side chain guides.

Wear/Damage → Replace.

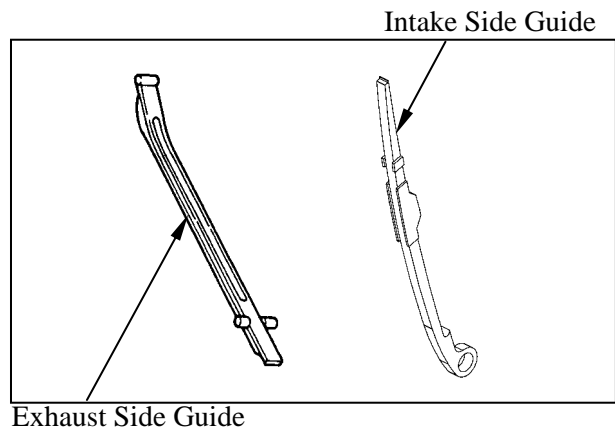

INSTALLATION

Piston ring

Carefully install the piston rings into the piston ring grooves with the markings facing up.

* Be careful not to damage the piston and rings.

- ♦ Do not confuse the top and second rings.
- ♦ To install the oil ring, install the oil ring, then install the side rails.

Stagger the piston ring end gaps 120° degrees apart from each other.

Stagger the side rail end gaps as shown.

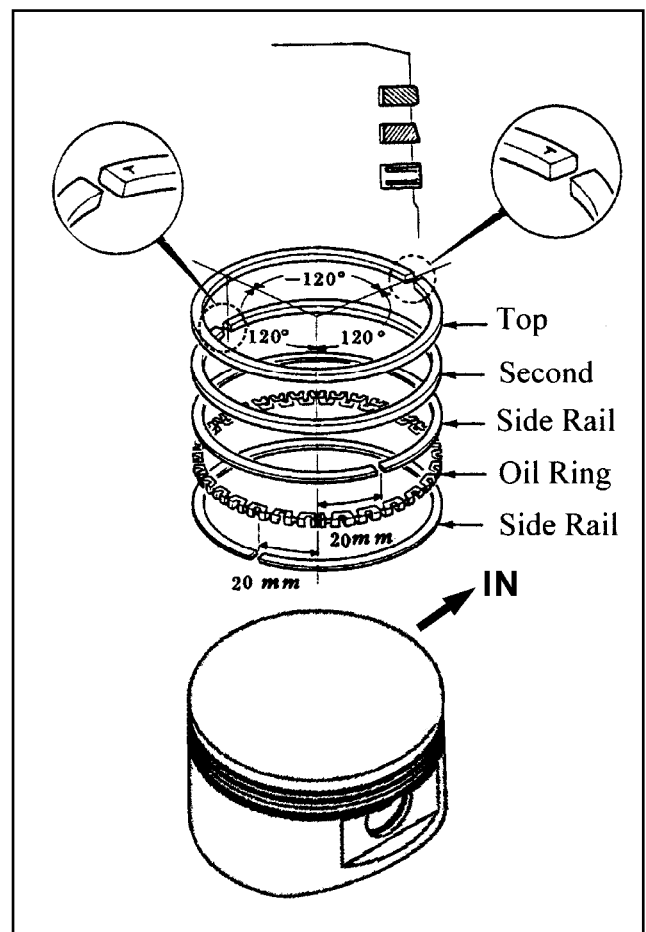

7. CYLINDER/PISTON

Cylinder/Piston

Clean any gasket material attached the cylinder mating surfaces of the crankcase and oil passage.

Apply engine oil to the piston pin.

Apply engine oil to the connecting rod small end and piston pin hole.

Install the piston with the “IN” mark face intake side and piston pin.



Place a clean shop towel over the crankcase prevent the clip from falling into the crankcase.

Install the new pin clip.

- * ♦Make sure that the piston pin clips are seated securely.
- ♦Do not align the piston pin clip end gap with the piston cut-out



Gasket

Install the dowel pins and gasket.



Dowel pins

7. CYLINDER/PISTON

Apply engine oil to the cylinder wall, piston and piston ring outer surfaces.

Pass the cam chain through the cylinder and install the cylinder over the piston.

* Be careful not to damage the piston rings and cylinder walls.

Install the cylinder head and camshaft holder has installed (refer to the “**CYLINDER HEAD**” section in the chapter 6),

Connect the water hose

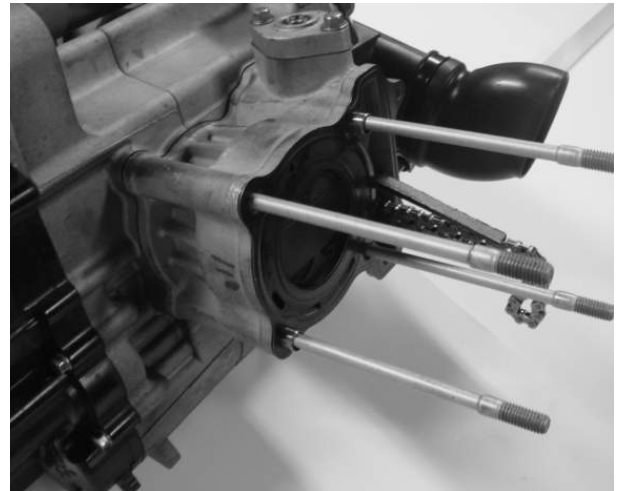

DRIVE AND DRIVEN PULLEYS

SCHEMATIC DRAWING -----	8-1
SERVICE INFORMATION-----	8-2
TROUBLESHOOTING-----	8-3
LEFT CRANKCASE COVER -----	8-4
DRIVE PULLEY, DRIVE BELT AND DRIVEN PULLEY -----	8-5



8. DRIVE AND DRIVEN PULLEYS

SCHEMATIC DRAWING

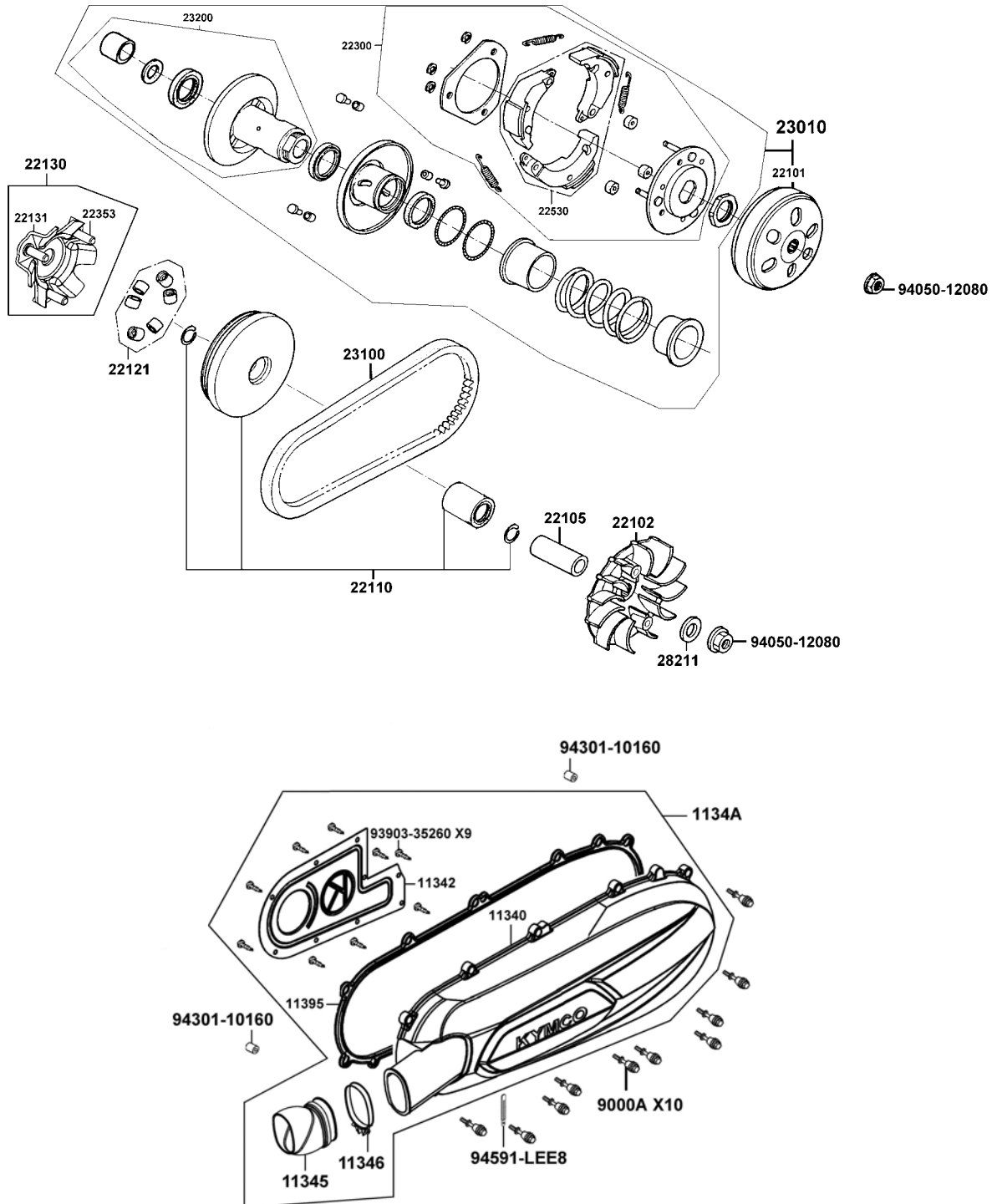

SERVICE INFORMATION

GENERAL INSTRUCTIONS

- The drive pulley, clutch and driven pulley can be serviced with the engine installed.
- Avoid getting grease and oil on the drive belt and pulley faces. Remove any oil or grease from them to minimize the slipping of drive belt and drive pulley.

SPECIFICATIONS

Unit: mm

Item	Standard
Movable drive face bushing I.D.	24.011~24.052
Drive face collar O.D.	23.960~23.974
Clutch outer I.D.	130~130.2
Driven face O.D.	33.965~33.985
Movable driven face I.D.	34~34.025
Weight roller O.D.	17.920~18.080

TORQUE VALUES

Drive face nut	5.5~6.5 kgf-m
Clutch outer nut	5.0~6.0 kgf-m
Clutch plate comp	5.0~6.0 kgf-m

SPECIAL TOOLS

Universal holder	A120E00017
Clutch spring compressor	A120E00034

TROUBLESHOOTING

Engine starts but motorcycle fail to move

- Worn drive belt
- Broken ramp plate
- Worn or damaged clutch lining
- Broken driven face spring

Engine stalls or motorcycle creeps

- Broken clutch weight spring

Lack of power

- Worn drive belt
- Weak driven face spring
- Worn weight roller
- Faulty driven face

LEFT CRANKCASE COVER

REMOVAL

Remove ten left crankcase cover bolts and then remove the left crankcase cover. Remove the gasket and dowel pins.



Dowel Pins

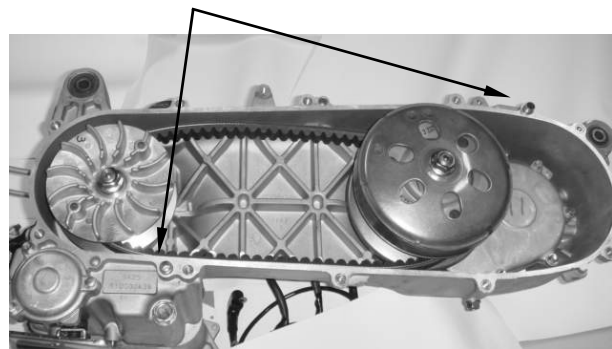

INSTALLATION

Install the dowel pins and gasket.

Install the left crankcase cover.

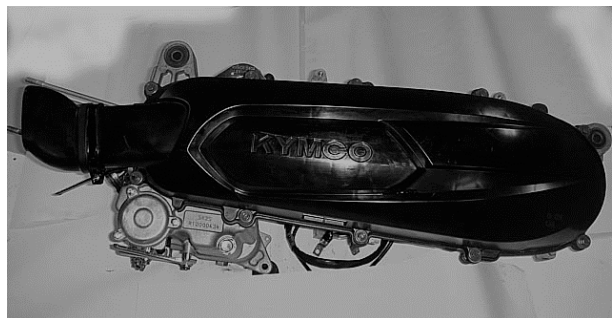

Install and tighten ten bolts diagonally to specified torque.

DRIVE PULLEY, DRIVE BELT AND DRIVEN PULLEY

REMOVAL

Remove the left crankcase cover

Use the special tool to hold the drive pulley, then remove the nut and ratchet.

Special tool:

Universal holder A120E00017

Remove the drive pulley face and washer.

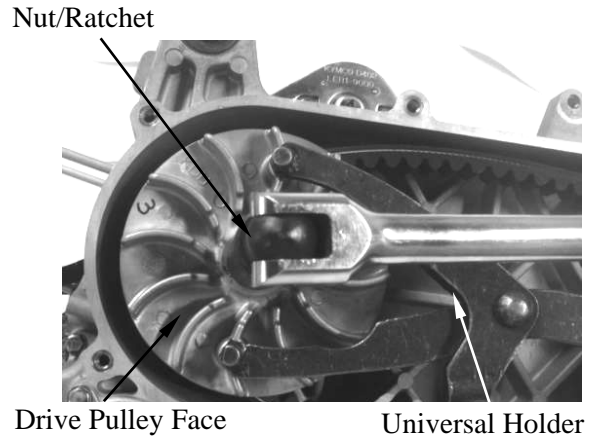

Hold the clutch outer with the universal holder and remove the clutch outer nut.

Special tool:

Universal Holder A120E00017

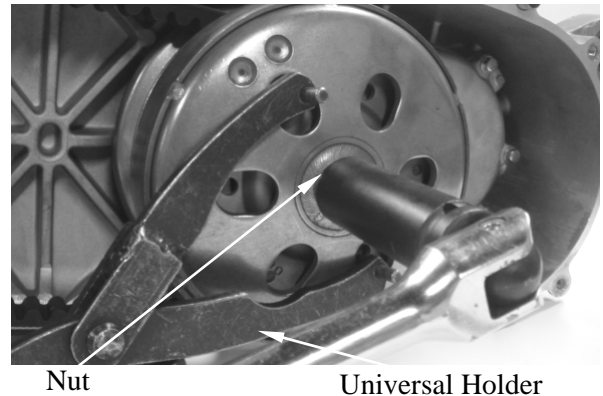

Remove the clutch outer, driven pulley assembly and drive belt together.

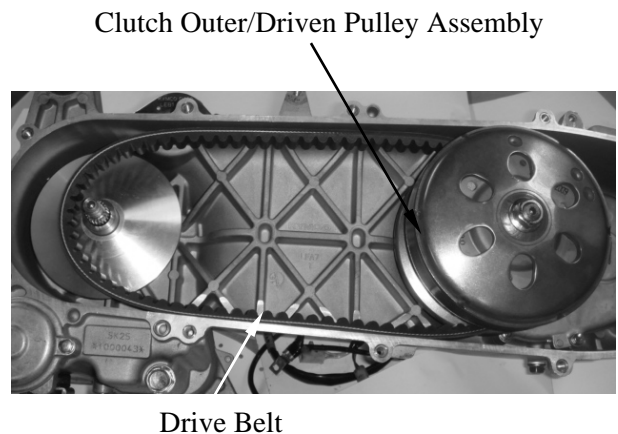

Remove the movable drive face assembly.



Movable Drive Face Assembly

Drive belt inspection

Check the drive belt for cracks, separation or abnormal or excessive wear.
Replace a new belt at every 20000KM

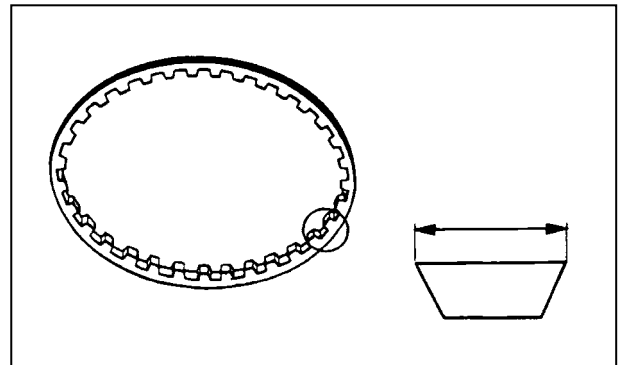

* Use specified genuine parts for replacement.

Clutch out inspection

Inspect the clutch out for wear or damage.
Measure the clutch outer I.D.

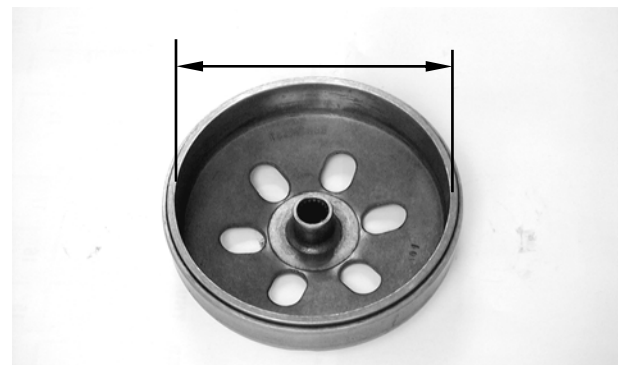

INSTALLATION

Apply lubricant to the drive face boss inner surface, then install the movable drive face assembly.

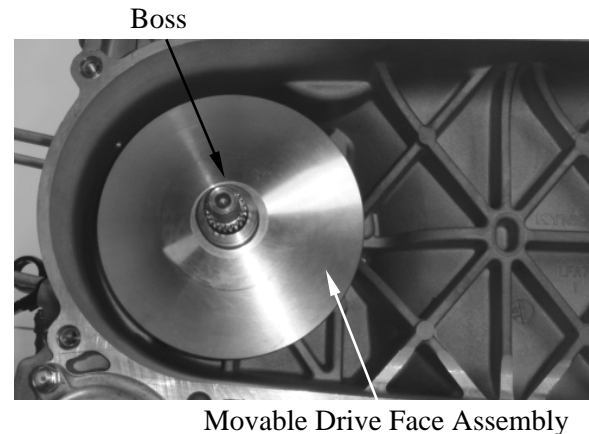

Install the clutch outer onto the driven pulley assembly.
Compress the driven pulley assembly by hand, then install the drive belt into the driven pulley assembly.

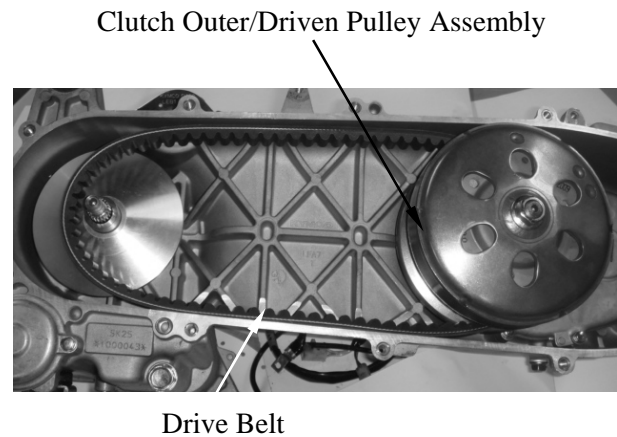

- * The drive belt should be installed so that the arrows on the drive belt periphery point in the normal turning direction if the drive belt has arrow mark.
- * The drive belt contact surface of the driven face should be thoroughly cleaned.

Install the driven pulley assembly/clutch outer and drive belt together.

Use the special tool to hold clutch outer, then tighten the nut to the specified torque.

Torque: 5.0~6.0kgf-m (50 ~60N-m)

Special tool:
Universal holder A120E00017

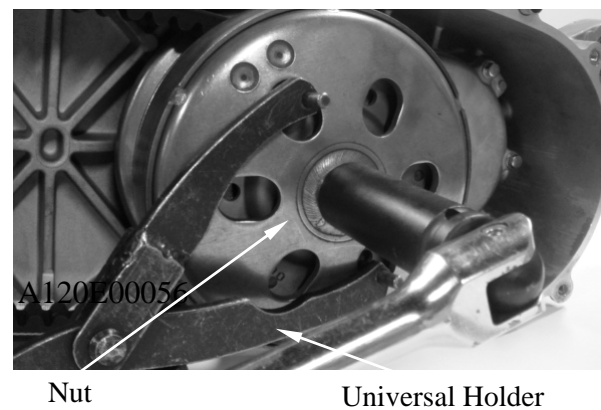

8. DRIVE AND DRIVEN PULLEYS

Install the drive pulley face and ratchet.
Use the special tool to hold drive pulley face,
then tighten the nut to the specified torque.

Torque:

5.5~6.5 kgf-m (55~65 N-m)

Special tool:

Universal holder A120E00017

Noted:

There is a washer between the drive pulley face and nut, don't forget to mount it when installation.

Nut/Ratchet

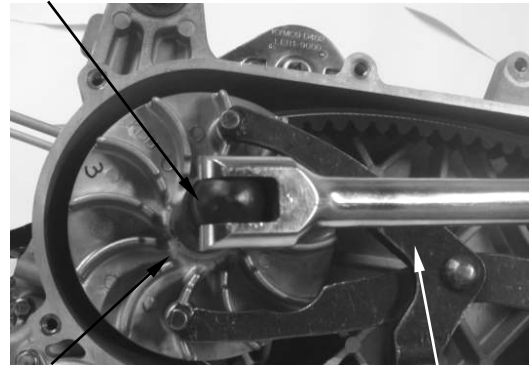

Drive Pulley Face

Universal Holder

DRIVE PULLEY DISASSEMBLY

Remove the drive face boss.

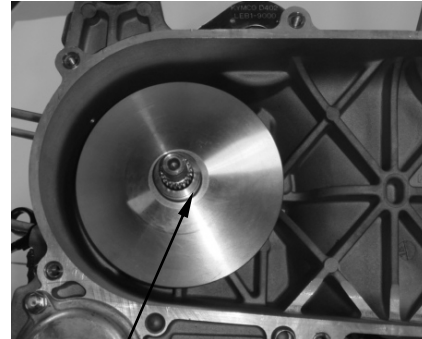

Boss

Remove the ramp plate

Ramp Plate

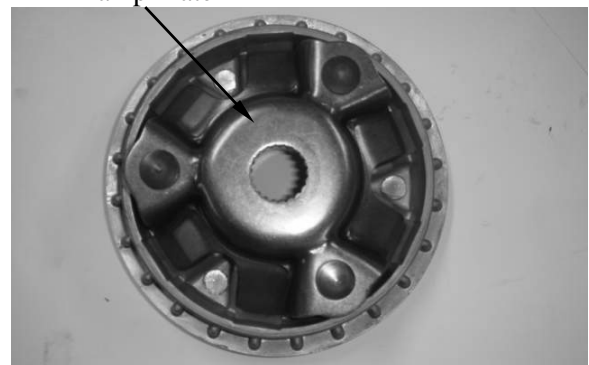

Take out six weight rollers.

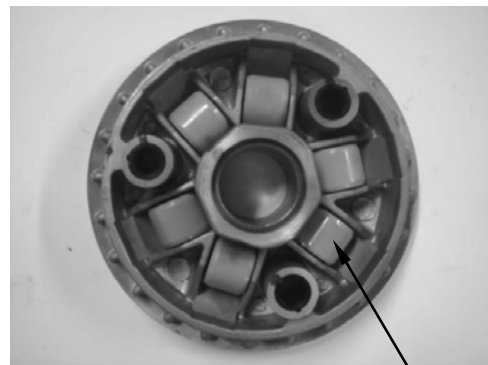

Weight Roller

DRIVE PULLEY INSPECTION

Weight rollers

Check each roller for wear or damage.
Measure outside diameter.

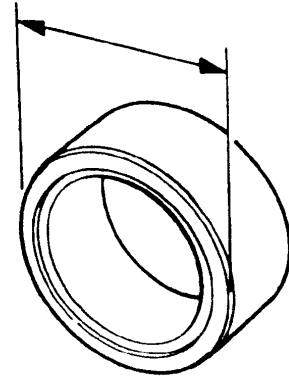

Movable drive face/Slide pieces/Drive pulley face

Check the movable drive face splines for wear, cracks or damage.

Check the ramp plate for cracks or damage.

Ramp Plate

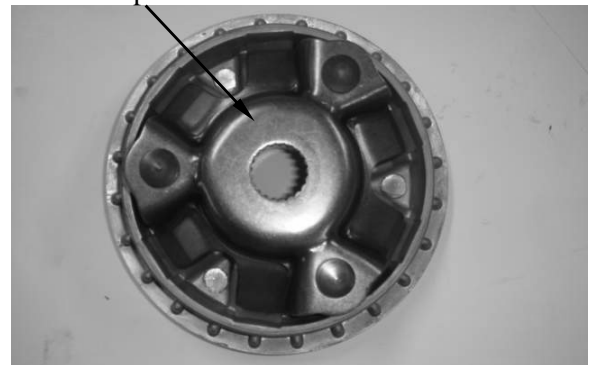

Check the movable drive face and drive pulley face cracks or damage.

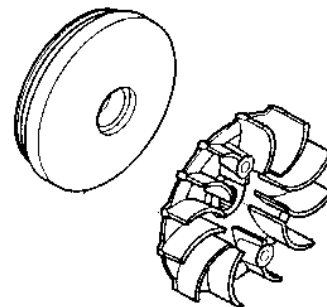

DRIVE PULLEY ASSEMBLY

Clean the movable drive face, drive pulley face, weight rollers, slide pieces, ramp plate and drive face boss.

* Remove any excess grease.

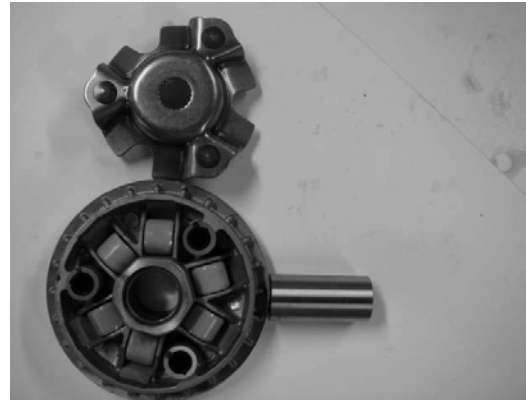

Install the weight rollers.

* The direction of all weight rollers is the same. The thin side is towards to clockwise.

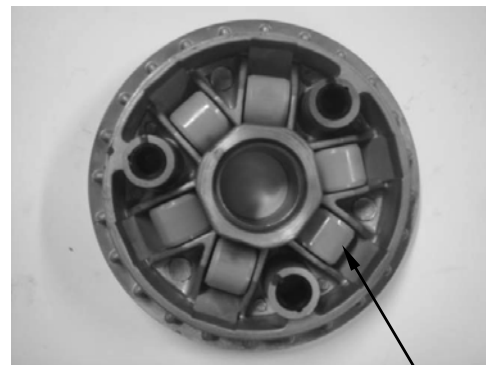

Weight Roller

Install the slide pieces and ramp plate.

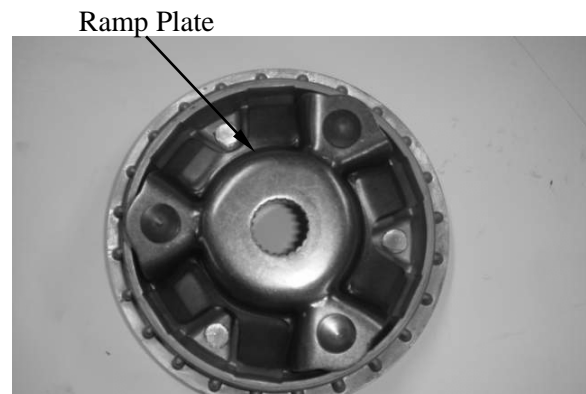

Ramp Plate

8. DRIVE AND DRIVEN PULLEYS

Install the drive face boss.

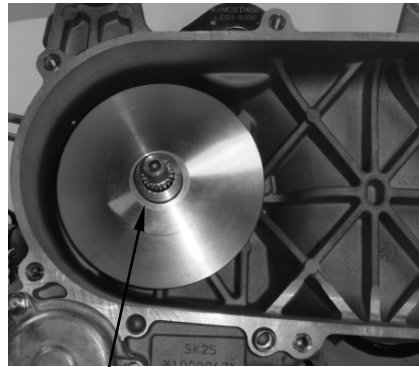

Boss

DRIVEN PULLEY DISASSEMBLY

Hold the clutch/driven pulley assembly with the clutch spring compressor.

* Be sure to use a clutch spring compressor to avoid spring damage.

Special tool:

Clutch Spring Compressor A120E00034

Set the tool in a vise and remove the clutch drive plate nut.

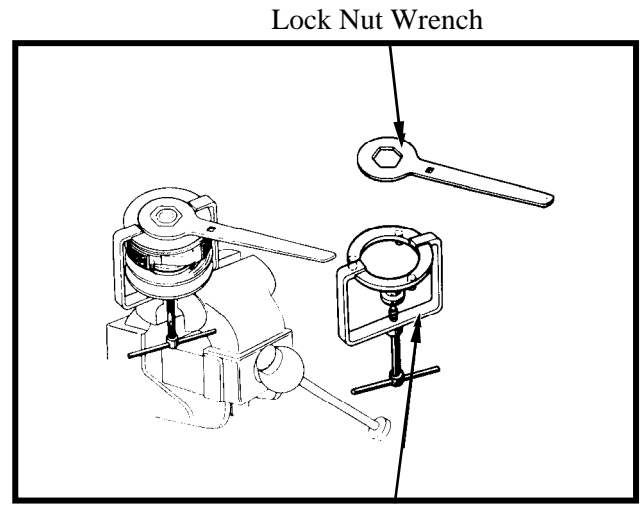

Clutch spring compressor

Remove the clutch weight.



8. DRIVE AND DRIVEN PULLEYS

Remove the spring.

Remove the spring collar on the movable driven face.

Remove the three guide pins/rollers, then remove the movable driven face.

Remove the needle bearing from driven face.

Remove the snap ring, then remove the bearing from driven face.

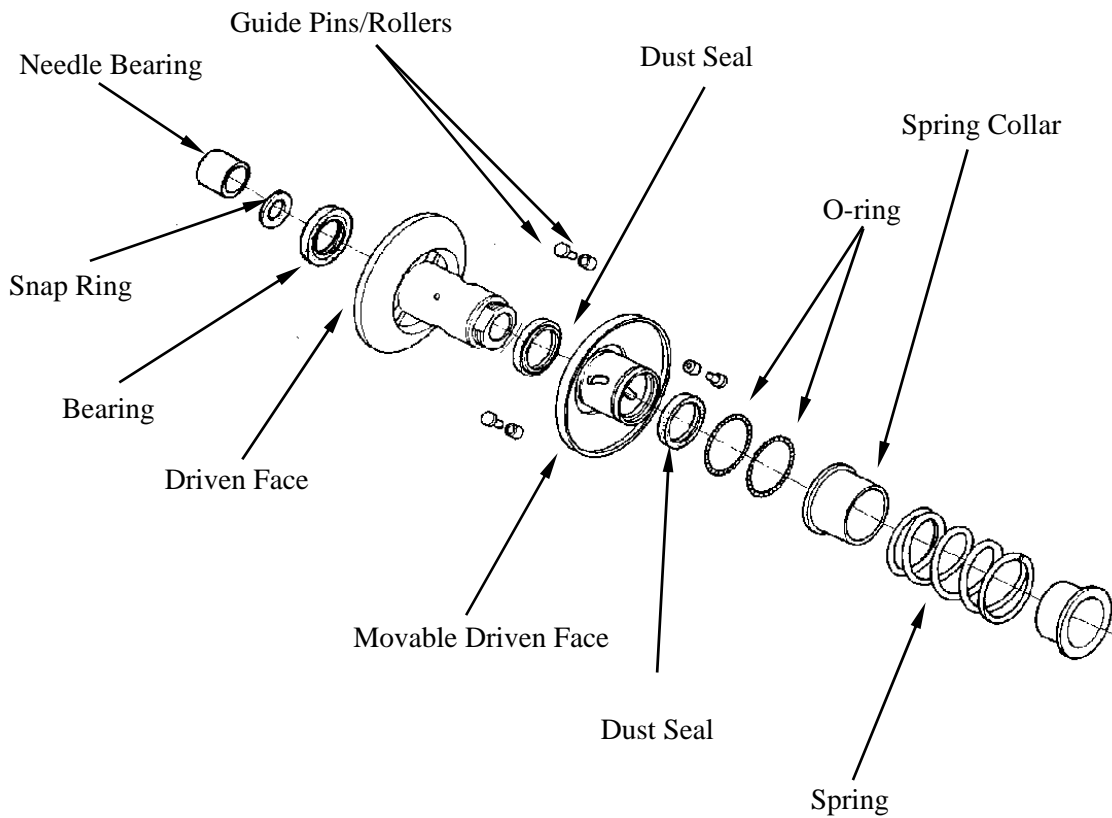

DRIVEN PULLEY INSPECTION

Check the driven pulley for smooth operation.
If any scratches or damage is found then replace as a set.

Check guide pins and rollers for wear or damage.
If any scratches or d

amage is found then replace as a set.

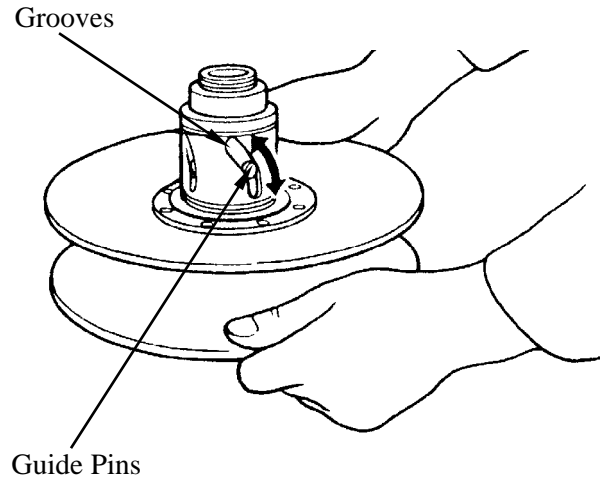

Check the spring for damage.
Measure the spring free length.

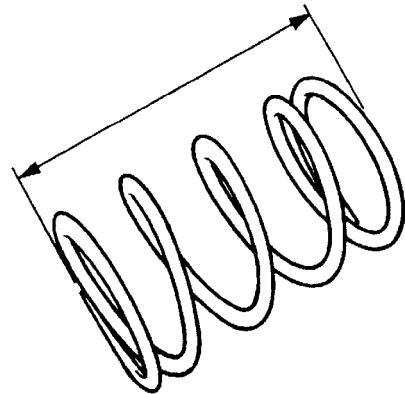

Check the clutch shoe for heat damage.

Measure the clutch shoe thickness.



DRIVEN PULLEY ASSEMBLY

Clean any oil from the drive belt sliding surfaces on the driven face.

Filling 12 g of grease to driven face inner side.

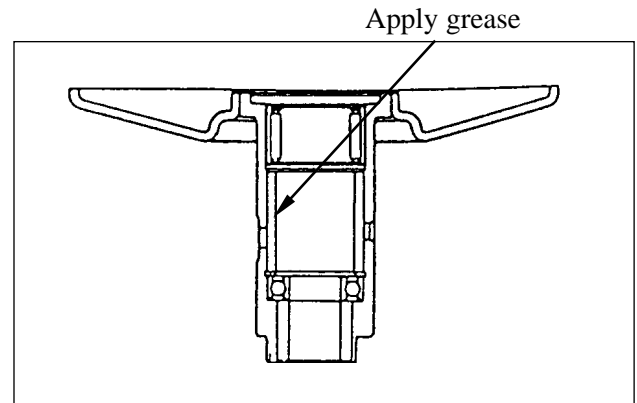

Apply grease to lips of the new dust seals and install into the movable driven face.

Coat new O-rings with grease and install them into the movable driven face grooves.

Install the movable driven face onto the driven face.

Install the guide rollers and guide roller pins.

Filling 5 g of grease to each guide groove.

Install the guide pins/rollers.

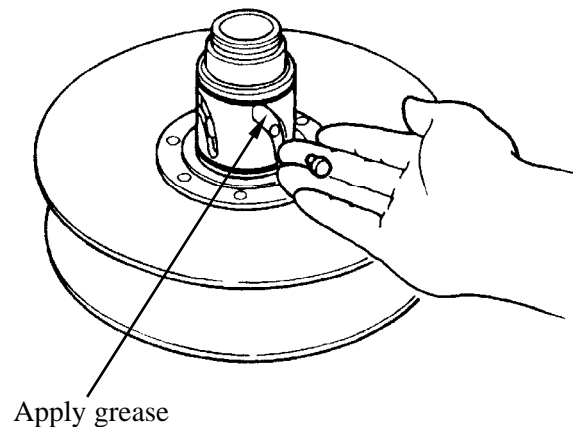

Install spring collar.

Use the special tool to install spring and clutch, then install and tighten the nut to the specified torque.

Torque: 5.5 ~6.5m (55~65N-m)

Special tool:

Clutch Spring Compressor A120E00034

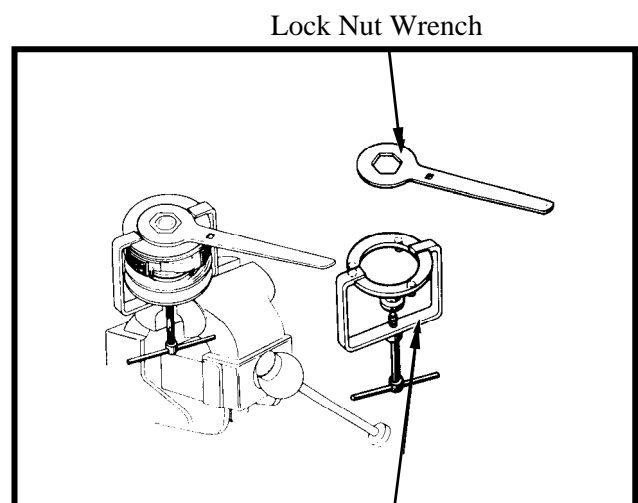

Clutch spring compressor

9. FINAL REDUCTION

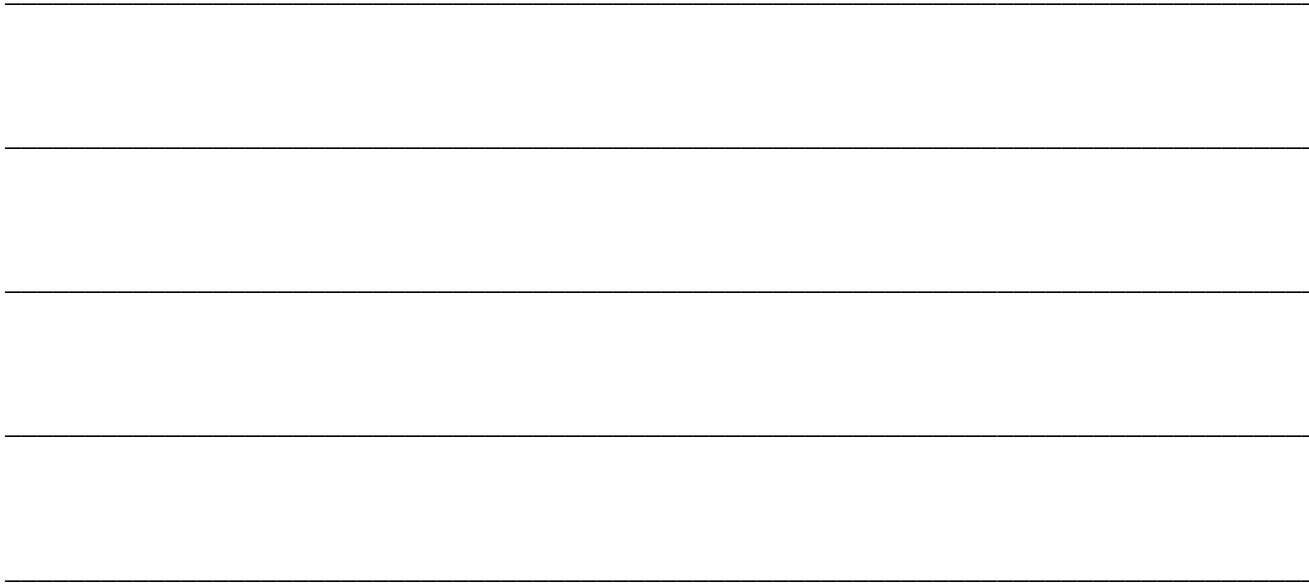

FINAL REDUCTION

SCHEMATIC DRAWING	9-1
SERVICE INFORMATION.....	9-2
TROUBLESHOOTING.....	9-2
FINAL REDUCTION	9-3
BEARING REPLACEMENT	9-7



9. FINAL REDUCTION

SCHEMATIC DRAWING

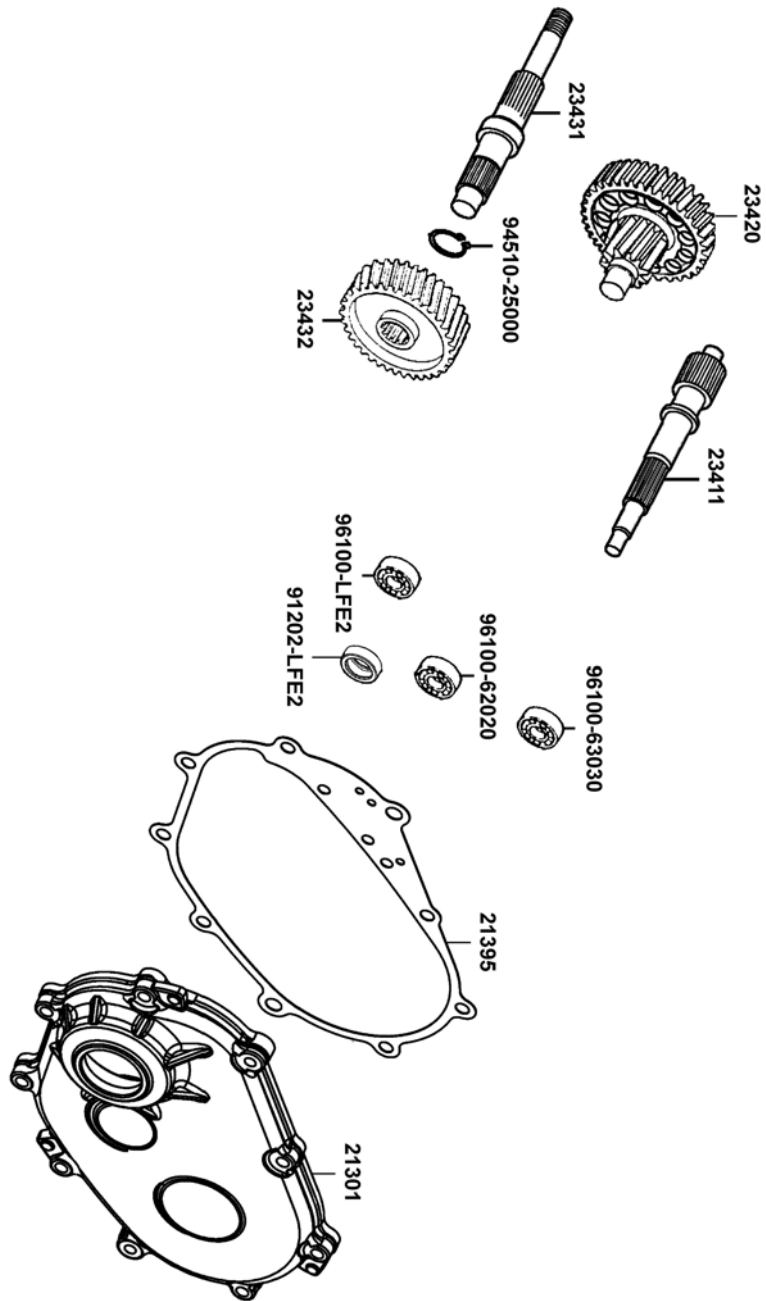

9. FINAL REDUCTION

SERVICE INFORMATION

GENERAL INSTRUCTIONS

- The servicing operations of this section can be made with the engine installed.
- When replacing the drive shaft, use a special tool to hold the bearing inner race for this operation.

SPECIFICATIONS

Specified Oil: SAE 90#

Oil Capacity:

At disassembly : 0.13L

At change : 0.12L

TORQUE VALUES

Transmission case cover bolt 1.0~1.4kgf-m

SPECIAL TOOLS

Oil seal and bearing installer A120E00014

Bearing puller A120E00037

TROUBLESHOOTING

Engine starts but motorcycle fail to move

- Damaged transmission
- Seized or burnt transmission

Abnormal noise

- Worn, seized or chipped gears
- Worn bearing

Oil leaks

- Oil level too high
- Worn or damaged oil seal

9. FINAL REDUCTION

FINAL REDUCTION

REMOVAL

Drain the transmission gear oil into a clean container (refer to the “**TRANSMISSION OIL**” section in the chapter 3).

Remove the driven pulley (refer to the “**DRIVE PULLEY, DRIVE BELT AND DRIVEN PULLEY**” section in the chapter 8).

Remove nine bolts attached the transmission case cover, then remove the transmission case cover.



Countershaft

Gasket

Final gear

Remove the dowel pins and gasket.
Remove the final gear and shaft, then remove the countershaft .

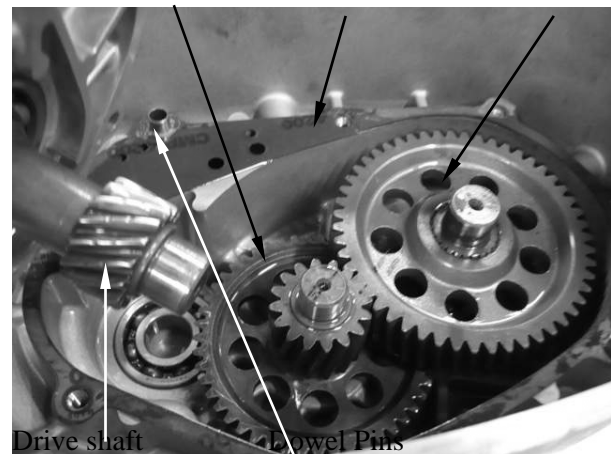

9. FINAL REDUCTION

INSPECTION

Inspect the countershaft and gear for wear or damage.



Inspect the final gear and final gear shaft for wear, damage or seizure.



Check the driveshaft for wear or damage.
Check the left crankcase bearings for excessive play and inspect the oil seal for wear or damage.

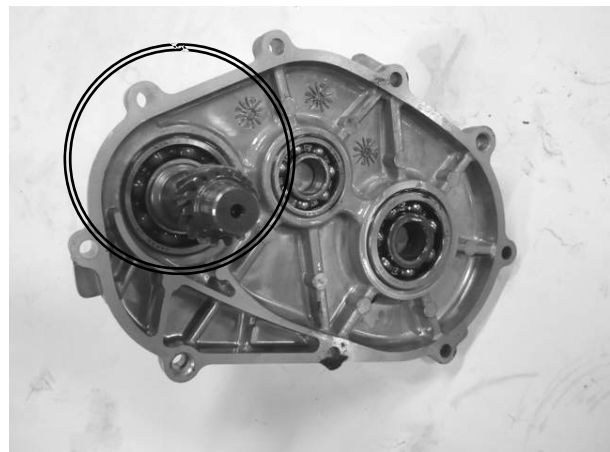

9. FINAL REDUCTION

Check the transmission case cover bearings for excessive play and inspect the final shaft bearing oil seal for wear or damage.



Drive Shaft Bearing

Countershaft Bearing

Final Shaft Bearing

Final Gear Shaft Bearing

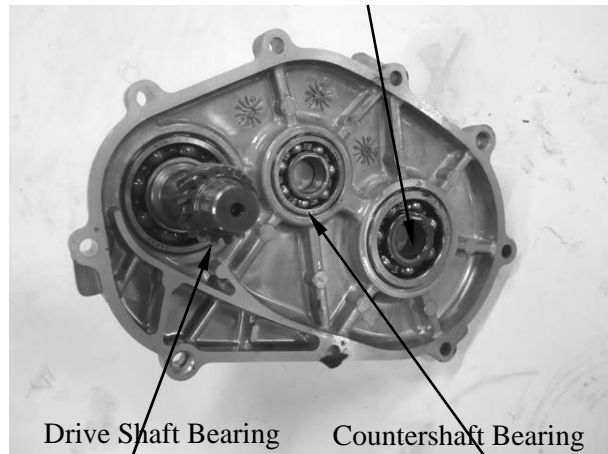

Drive Shaft Bearing

Countershaft Bearing

INSTALLATION

Install the final gear and final gear shaft.

Install the Countershaft

Install the driveshaft.

Countershaft

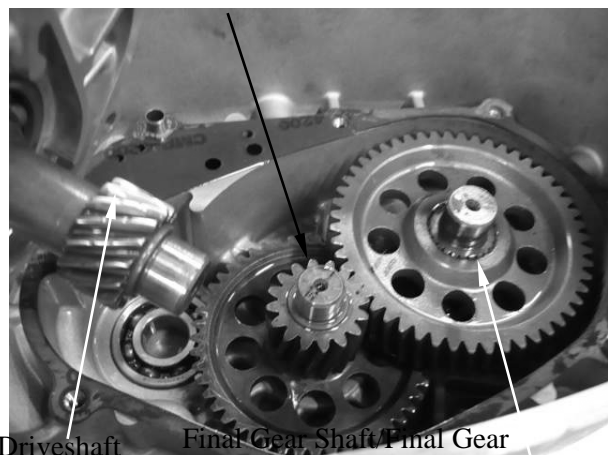

Driveshaft

Final Gear Shaft/Final Gear

9. FINAL REDUCTION

Install new gasket.
Install two dowel pins.

Dowel pins

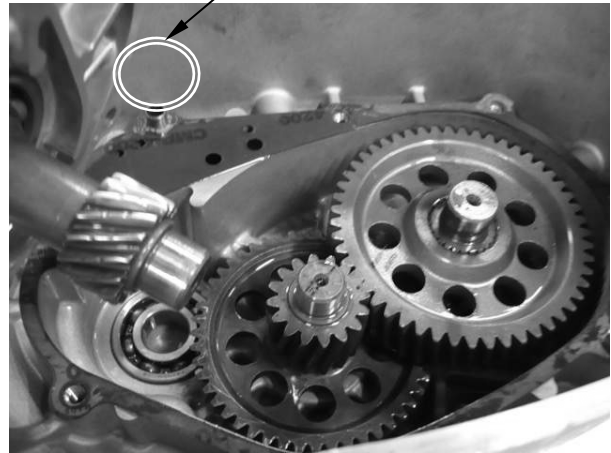

Install the transmission case cover.
Install and tighten the nine bolts to the specified torque in a crisscross pattern in 2 or 3 steps.

Torque: 1.0~1.4kgf-m

Fill the transmission case with the specified oil (refer to the “**TRANSMISSION OIL**” section in the chapter 3).



9. FINAL REDUCTION

BEARING REPLACEMENT TRANSMISSION CASE COVER

Remove the transmission case cover
Remove the transmission case cover
bearings by using the special tool.

Special tool:

Bearing puller A120E00037

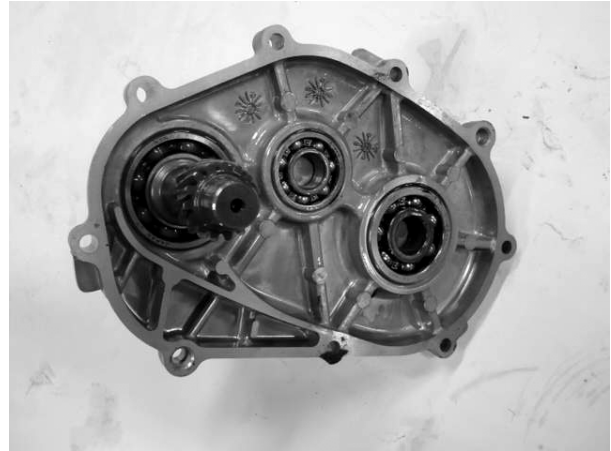

Install the new bearings or new oil seal into
the transmission case cover by using the
special tool.

Special tool:

Oil seal and bearing installer
A120E00014

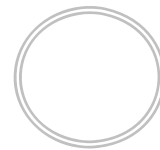

TRANSMISSION CASE

Remove the all transmission gears
Remove the transmission case bearings by
using the special tool.

Special tool:

Bearing puller A120E00037



9. FINAL REDUCTION

Install the new bearings or new oil seal into the transmission case by using the special tool.

Special tool:

Oil seal and bearing installer

A120E00014



After installation, fill the transmission case with the specified oil.

Specified gear oil :SAE90#

Oil capacity :

At disassembly: 0.12 L

At change: 0.11L

Install and tighten the oil check bolt.

Torque : 0,8~1,2kgf-m

Start the engine and check for oil leaks.



Drain Bolt



Oil Filler Bolt

10. A.C. GENERATOR/STARTER CLUTCH

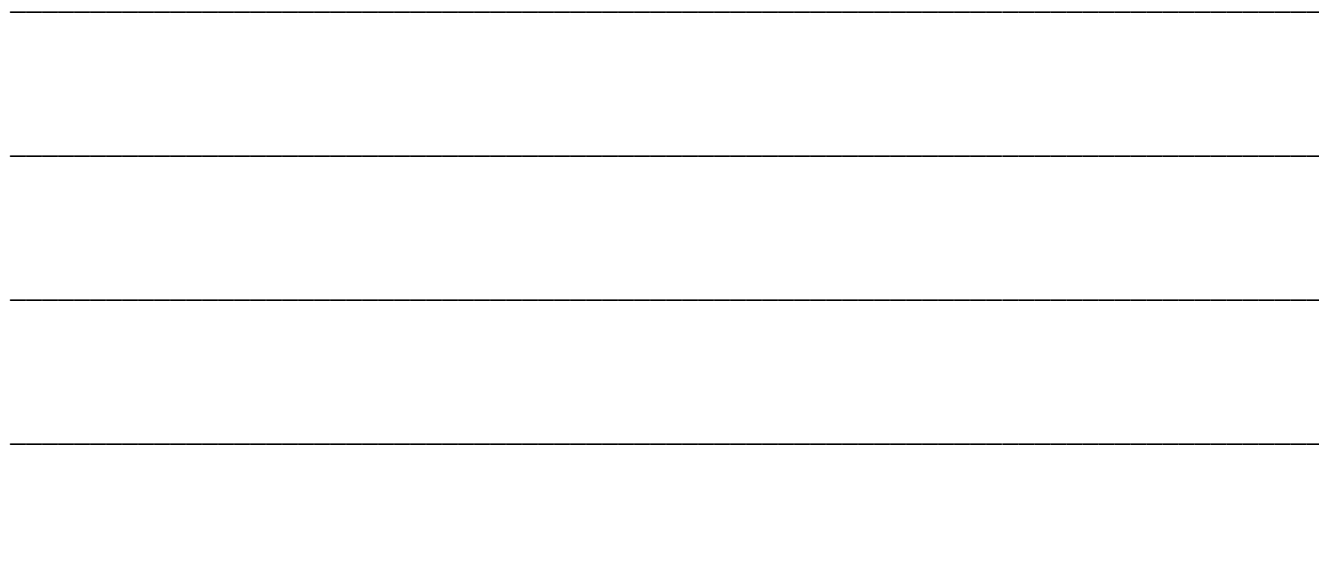

A.C. GENERATOR/STARTER CLUTCH

SCHEMATIC DRAWING -----	10-1
SERVICE INFORMATION-----	10-2
TROUBLESHOOTING-----	10-2
ALTERNATOR STATOR-----	10-3
STARTER CLUTCH-----	10-6

10. A.C. GENERATOR/STARTER CLUTCH

SCHEMATIC DRAWING

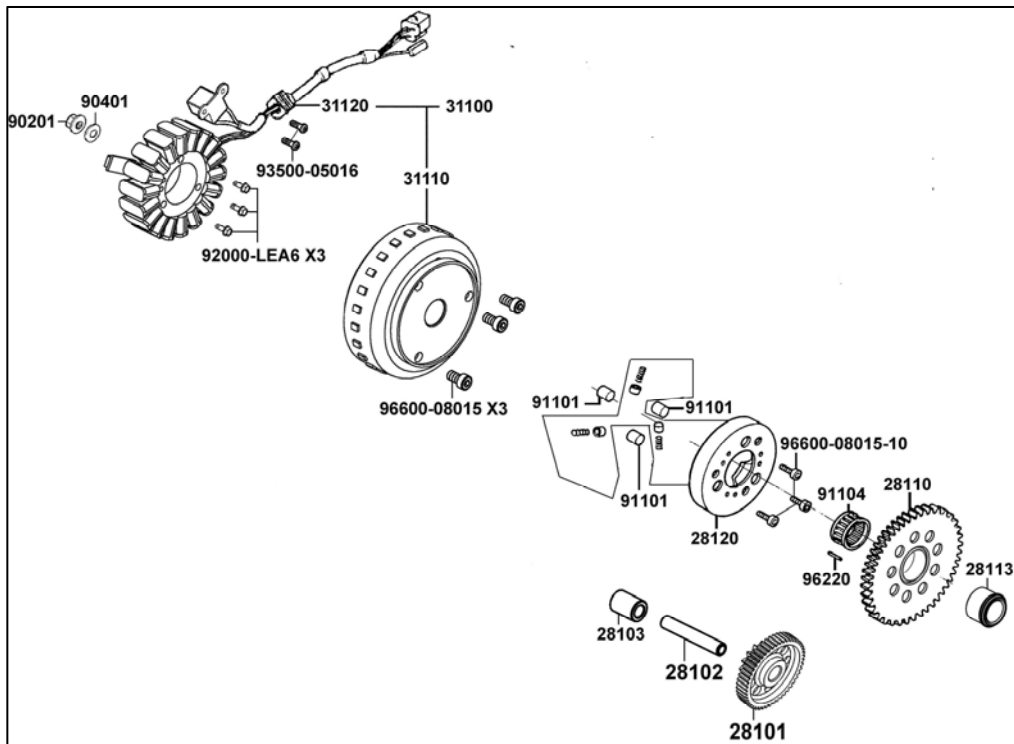
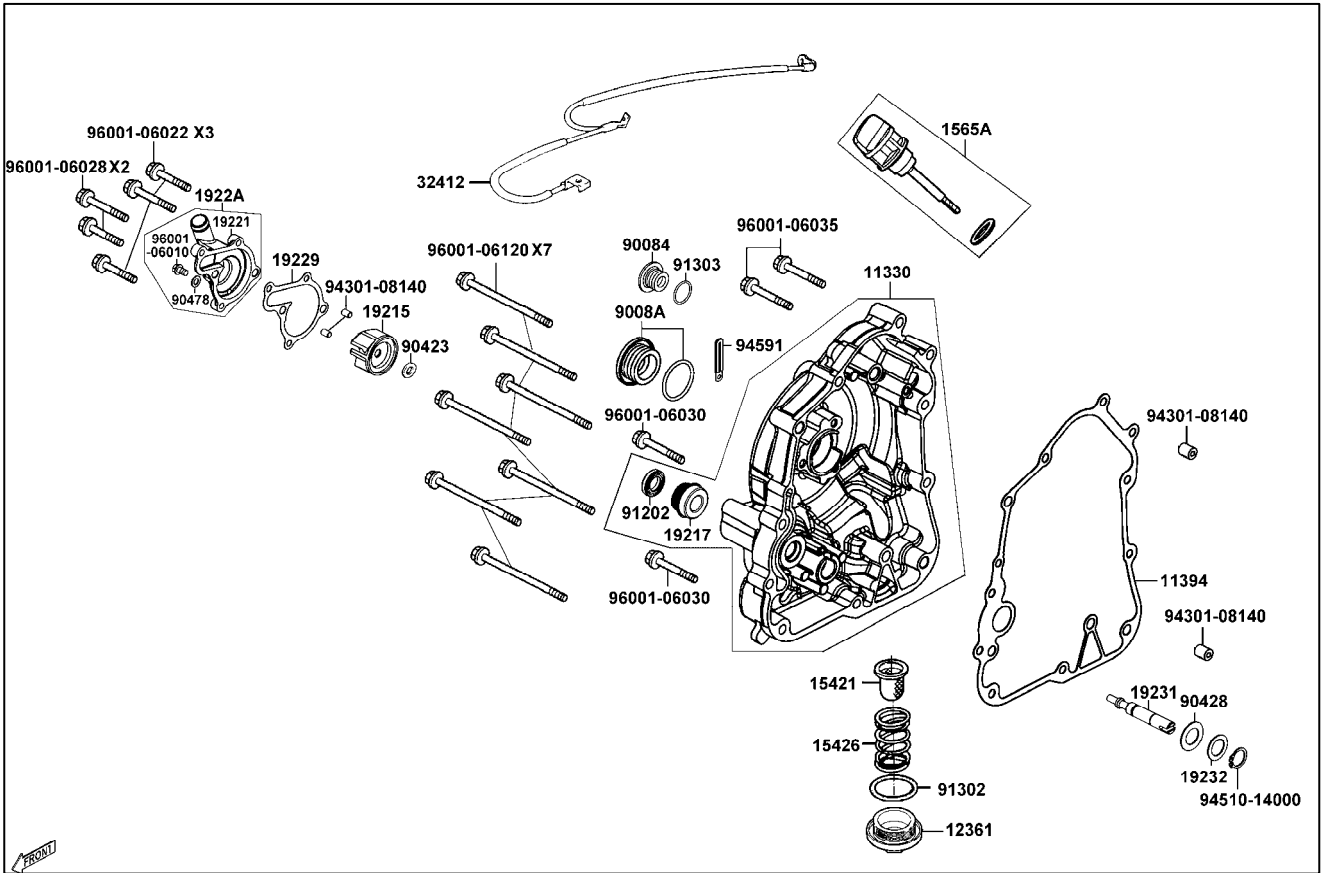

10. A.C. GENERATOR/STARTER CLUTCH

SERVICE INFORMATION

GENERAL INSTRUCTIONS

- All servicing operations and inspections in this section can be made with the engine installed.
- Drain the coolant before removing the right crankcase cover.
- Be careful not to drain the coolant when the engine temperature is high. (Perform this operation when the engine is cold.)
- Drain the coolant into a clean container.
- Drain the engine oil into a clean container before removing the right crankcase cover.
- When the right crankcase cover is installed, fill with the recommended engine oil and coolant. Then, bleed air from the water jacket.

SPECIFICATIONS

Engine oil: SAE 15W/40#
API-SJ

Oil capacity at change: 1.0 L

Coolant: distilled water + coolant concentrate

Coolant capacity: 0.87L

SPECIAL TOOLS

Flywheel puller	A120E00003
Flywheel holder	A120E00021

TORQUE VALUES

Flywheel nut : 5.0~6.0 kgf-m

TROUBLESHOOTING

Starter motor rotates but engine fail to start

- Faulty starter clutch
- Starter motor rotates reversely
- Weak battery

10. A.C. GENERATOR/STARTER CLUTCH

A.C.GENERATOR

REMOVAL

Drain the engine oil (refer to the “ENGINE OIL” section in the chapter 3).

Disconnect the generator connectors

Remove ten bolts attached the right crankcase cover and then remove the cover.

Remove two dowel pins and gasket.

Remove two pulse coil mount screws.
Remove three stator mount bolts, grommet and the stator attached the right crankcase cover.

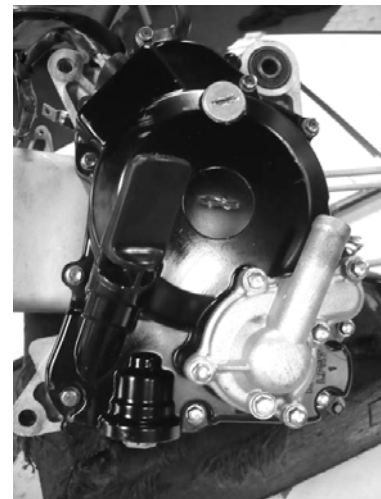

Dowel Pins

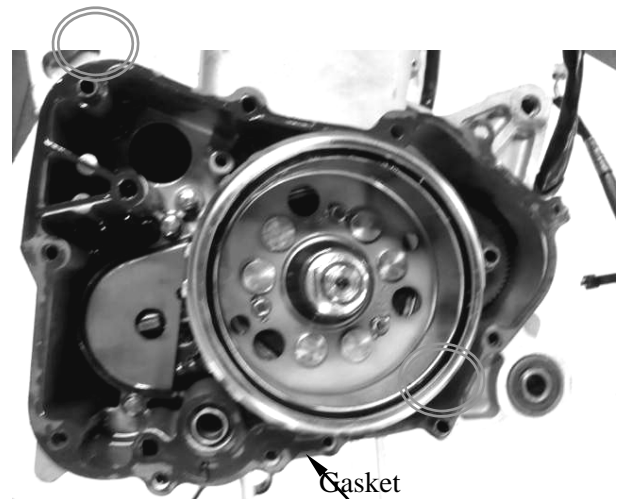

Stator

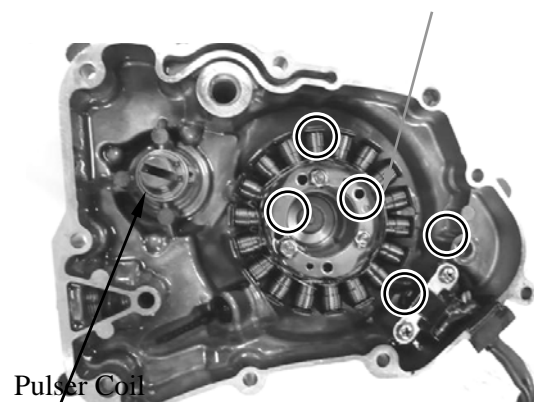

10. A.C. GENERATOR/STARTER CLUTCH

INSPECTION

Check the stator and pulse coil for damage.

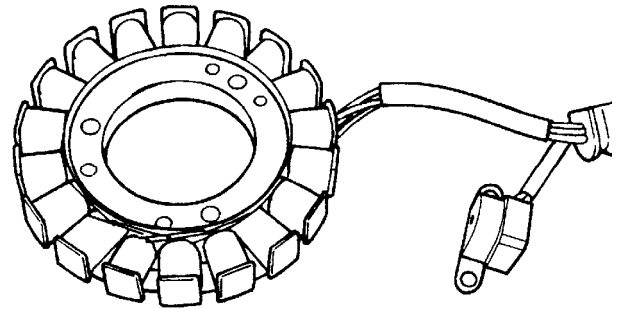

Stator

INSTALLATION

Install the stator and tighten the stator mount bolts to the specified torque.

Torque: 1 kgf-m

Apply sealant to the grommet seating surface and install it to the cover groove properly.

Install the pulse coil and tighten mount screws securely.

Clean the mating surfaces of the right crankcase and cover.

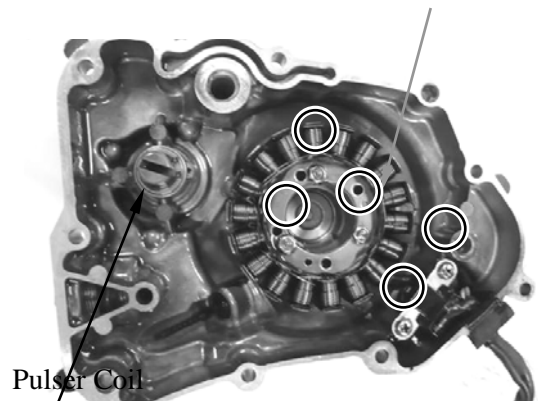

Pulse Coil

Gasket

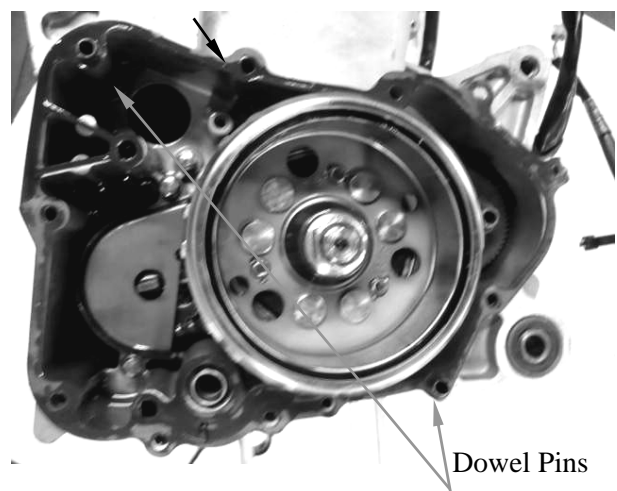

Dowel Pins

10. A.C. GENERATOR/STARTER CLUTCH

Install the dowel pins and gasket.

Install the right crankcase cover and tighten the bolts in a crisscross pattern in 2 or 3 steps.

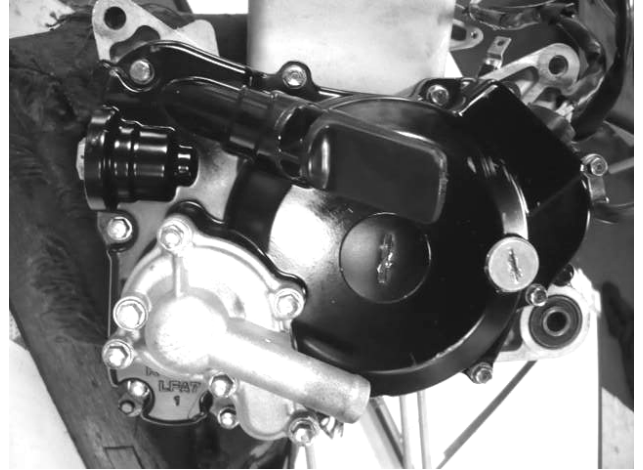

10. A.C. GENERATOR/STARTER CLUTCH

STARTER CLUTCH

REMOVAL

Remove the right crankcase cover

Hold the flywheel with a special tool and remove the flywheel nut.

Special tool:

Flywheel holder A120E00021

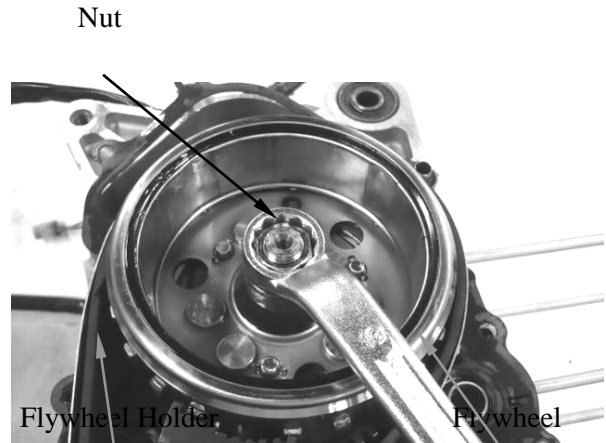

Remove the flywheel by using the special tool.

Special tool:

Flywheel puller A120E00003

Flywheel Puller

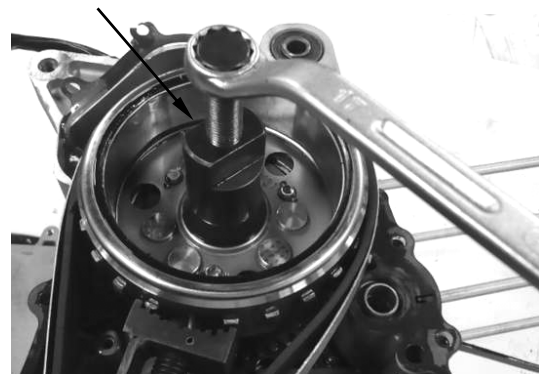

Remove the reduction gear shaft and reduction gear.

Shaft

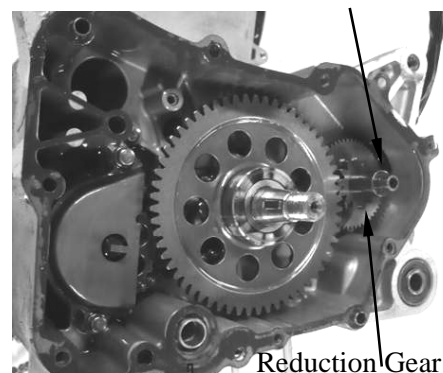

10. A.C. GENERATOR/STARTER CLUTCH

Remove the starter driven gear.

Starter Driven Gear



INSPECTION

Install the driven gear into the flywheel.

Check the operation of the sprag clutch by turning the driven gear. You should be able to turn the driven gear clockwise smoothly, but the gear should not turn counterclockwise.

Remove the starter driven gear by turning the driven gear.

Check the starter driven gear teeth for wear or damage.



Starter Idle Gear

Check the starter reduction gear teeth and shaft for wear or damage.

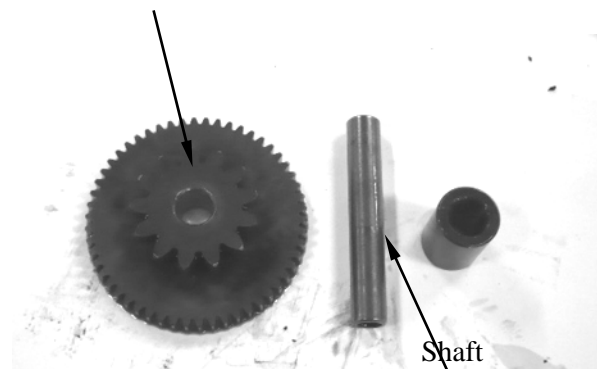

10. A.C. GENERATOR/STARTER CLUTCH

INSTALLATION

Install the starter driven gear onto the crankshaft.

Starter Driven Gear



Apply oil to the starter reduction gear shaft.
Install the starter reduction gear and shaft to the right crankcase.

Shaft

Reduction Gear



Install the flywheel onto the crankshaft by aligning the key on the crankshaft with the groove in the flywheel.

Flywheel

* Before installation, check and make sure that the inside the flywheel is not contaminated.

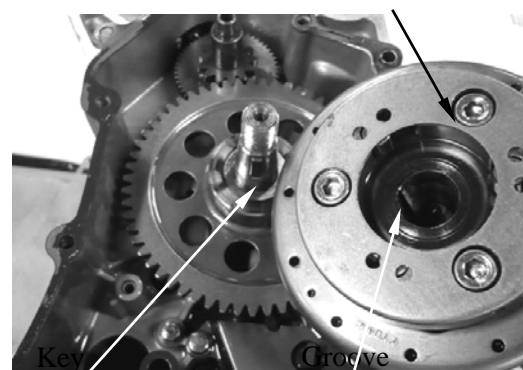

Key

Groove

10. A.C. GENERATOR/STARTER CLUTCH

Hold the flywheel with the special tool and tighten the flywheel nut.

Torque: 5.0~6.0 kgf-m

Special tool:

Flywheel holder A120E00021

Nut

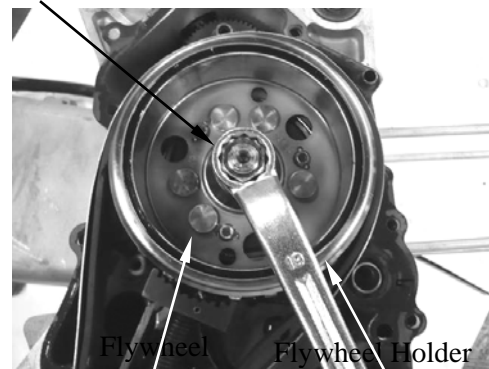

Install the dowel pins and gasket.

Install the right crankcase cover and tighten the bolts in a crisscross pattern in 2 or 3 steps.



11. CRANKCASE/CRANKSHAFT

CRANKCASE/CRANKSHAFT

SCHEMATIC DRAWING -----	11-1
SERVICE INFORMATION-----	11-2
TROUBLESHOOTING-----	11-2
CRANKCASE SEPARATION -----	11-3
CRANKCASE ASSEMBLY -----	11-4

11. CRANKCASE/CRANKSHAFT

SERVICE INFORMATION

GENERAL INSTRUCTIONS

- This section covers crankcase separation to service the crankshaft. The engine must be removed for this operation.
- When separating the crankcase, never use a driver to pry the crankcase mating surfaces apart forcibly to prevent damaging the mating surfaces.
- When installing the crankcase, do not use an iron hammer to tap it.
- The following parts must be removed before separating the crankcase.

Cylinder head

Cylinder/piston

Drive and driven pulley

A.C. generator/starter clutch

Rear wheel/rear shock absorber

Starter motor

Oil pump

SPECIFICATIONS

Unit: mm

	Item	Standard
Crankshaft	Connecting rod big end side clearance	0.15~0.35
	Connecting rod big end radial clearance	0~0.008

TORQUE VALUES

Crankcase bolt	1.0 kgf-m
Cam chain tensioner slipper bolt	1.0 kgf-m

TROUBLESHOOTING

Excessive engine noise

- Excessive bearing play
- Excessive crankpin bearing play
- Worn piston pin and piston pin hole

11. CRANKCASE/CRANKSHAFT

CRANKCASE SEPARATION

Remove the two right crankcase attaching bolts.

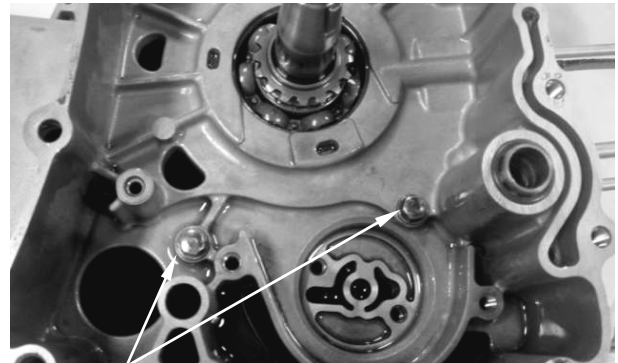

Bolt

Remove the left crankcase bolts.

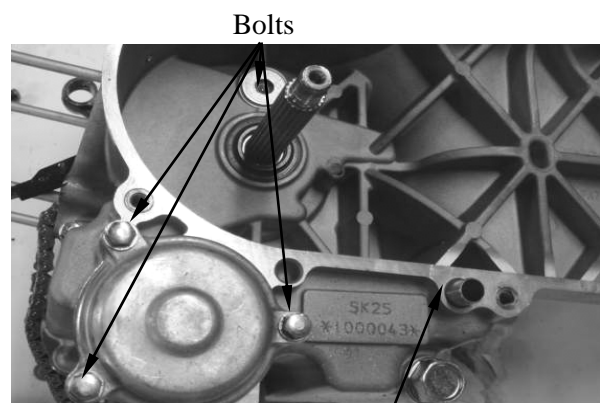

Bolts

Left Crankcase

Place the crankcase with the left crankcase down and remove the right crankcase from the left crankcase.

* Never use a driver to pry the crankcase mating surfaces apart.

Remove the gasket and dowel pins.

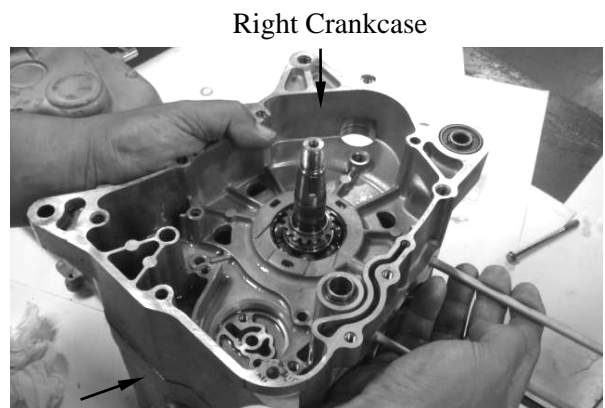

Right Crankcase

Left Crankcase

Remove the crankshaft from the left crankcase.

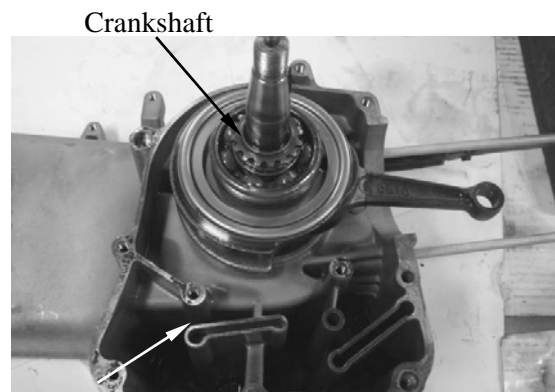

Crankshaft

Left Crankcase

11. CRANKCASE/CRANKSHAFT

Remove the oil seal from the left crankcase.

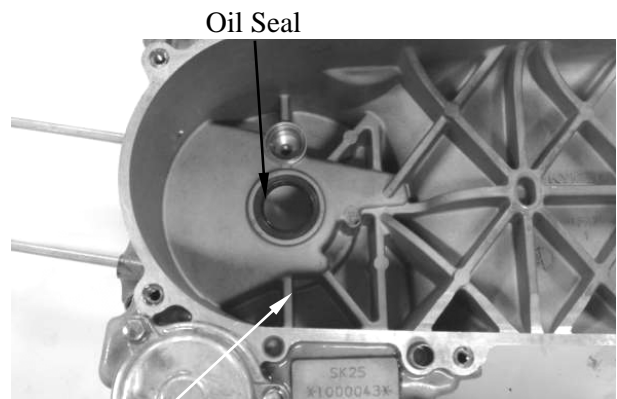

Left Crankcase

CRANKCASE ASSEMBLY

Clean off all gasket material from the crankcase mating surfaces.

* Avoid damaging the crankcase mating surfaces.



Install a new oil seal into the left crankcase.



Left Crankcase

11. CRANKCASE/CRANKSHAFT

Place the left crankcase down and install the crankshaft into the left crankcase.

- *
 - Avoid damaging the oil seal.
 - Apply grease to the lip of the oil seal.

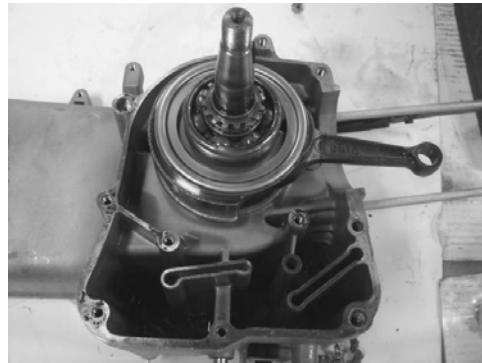

Change a new gasket.

Place into the crankshaft and onto the left crankcase.

- *
 Install the right crankcase squarely and do not tap it with an iron or plastic hammer.

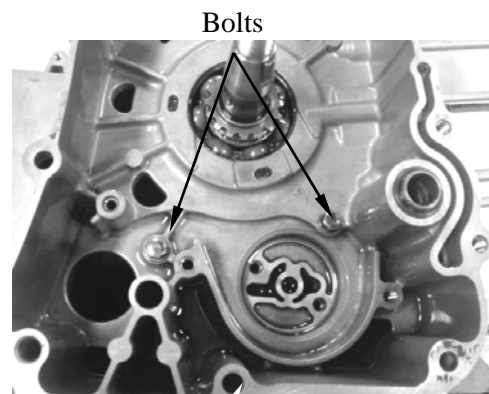

Install and tighten the right and left crankcase attaching bolts.

Torque: 1 kgf-m

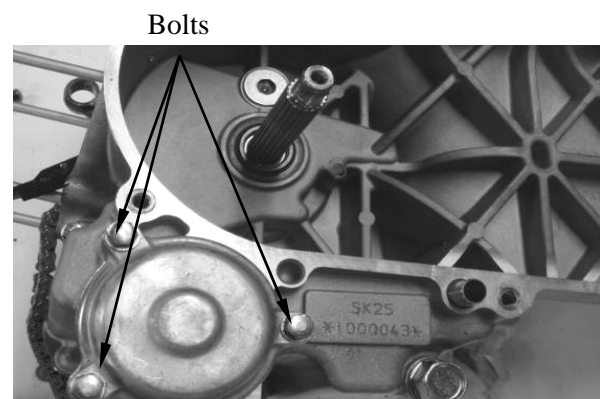

11. CRANKCASE/CRANKSHAFT

Install the cam chain.
Install the cam chain tensioner slipper.
Install and tighten the cam chain tensioner slipper bolt.

Torque: 1.0kgf-m

Cam Chain Tensioner Slipper

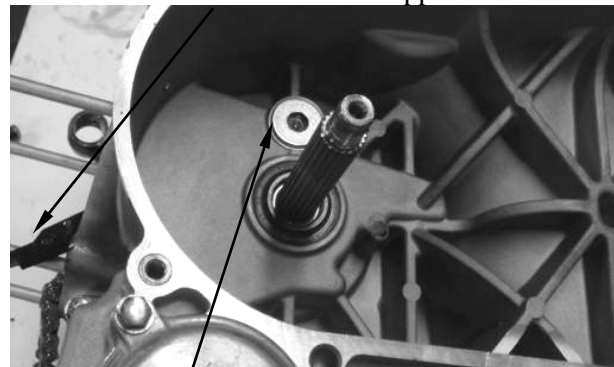

Bolt

12. COOLING SYSTEM

COOLING SYSTEM

SERVICE INFORMATION-----	12- 1
TROUBLESHOOTING-----	12- 1
COOLING SYSTEM TESTING-----	12- 3
COOLANT REPLACEMENT -----	12- 4
RADIATOR -----	12- 7
FAN MOTOR -----	12- 9
FAN MOTOR SWITCH -----	12-10
WATER PUMP -----	12-11
WATER TEMPERATURE SENSOR -----	12-16
THERMOSTAT-----	12-18

12. COOLING SYSTEM

SERVICE INFORMATION

GENERAL INSTRUCTIONS

- The water pump must be serviced after removing the engine. Other cooling system service can be done with the engine installed in the frame.
- The engine must be cool before servicing the cooling system.
When the coolant temperature is over 100°C, never remove the radiator cap to release the pressure because the boiling coolant may cause danger.
- Avoid spilling coolant on painted surfaces because the coolant will corrode the painted surfaces. Wash off any spilled coolant with fresh water as soon as possible.
- After servicing the system, check for leaks with a cooling system tester.

SPECIAL TOOL

Mechanical seal driver

TORQUE VALUES

Water pump impeller	1.2 kgf-m (12 N-m, 9 lbf-ft)	Left hand threads
Water pump cover bolt	1.0 kgf-m (10 N-m, 7 lbf-ft)	

TROUBLESHOOTING

Engine temperature too high

- Faulty temperature gauge or thermosensor
- Faulty radiator cap
- Faulty thermostat
- Insufficient coolant
- Passages blocked in hoses or water jacket
- Clogged radiator fins
- Passages blocked in radiator
- Faulty water pump

Temperature gauge pointer does not register the correct coolant temperature

- Faulty temperature gauge or thermosensor
- Faulty thermostat

Coolant leaks

- Faulty pump mechanical (water) seal
- Deteriorated O-rings
- Damaged or deteriorated water hoses

12. COOLING SYSTEM

SPECIFICATIONS

Coolant capacity	
Radiator	766 cc
Hose with cool coolant	169 cc
Hose with hot coolant	194 cc
Reserve tank	590 cc
Total capacity	1719 cc

COOLANT GRAVITY

Temp. °C \ Coolant concentration	0	5	10	15	20	25	30	35	40	45	50
5%	1.009	1.009	1.008	1.008	1.007	1.006	1.005	1.003	1.001	0.999	0.997
10%	1.018	1.107	1.017	1.016	1.015	1.014	0.013	1.011	1.009	1.007	1.005
15%	1.028	1.027	1.026	1.025	1.024	1.022	1.020	1.018	1.016	1.014	1.012
20%	1.036	1.035	1.034	1.033	1.031	1.029	1.027	1.025	1.023	1.021	1.019
25%	1.045	1.044	1.043	1.042	1.040	1.038	1.036	1.034	1.031	1.028	1.025
30%	1.053	1.051	1.051	1.049	1.047	1.045	1.043	1.041	1.038	1.035	1.032
35%	1.063	1.062	1.060	1.058	1.056	1.054	1.052	1.049	1.046	1.043	1.040
40%	1.072	1.070	1.068	1.066	1.064	1.062	1.059	1.056	1.053	1.050	1.047
45%	1.080	1.078	1.076	1.074	1.072	1.069	1.056	1.063	1.062	1.057	1.054
50%	1.086	1.084	1.082	1.080	1.077	1.074	1.071	1.068	1.065	1.062	1.059
55%	1.095	1.093	1.091	1.088	1.085	1.082	1.079	1.076	1.073	1.070	1.067
60%	1.100	1.098	1.095	1.092	1.089	1.086	1.083	1.080	1.077	1.074	1.071

COOLANT MIXTURE (WITH ANTI-RUST AND ANTI-FREEZING EFFECTS)

Freezing Point	Mixing Rate	KYMCO SIGMA Coolant Concentrate	Distilled Water
-9°C	20%		
-15°C	30%		
-25°C	40%		
-37°C	50%		
-44.5°C	55%		

Cautions for Using Coolant:

- Use coolant of specified mixing rate.
- Do not mix coolant concentrate of different brands.
- Do not drink the coolant which is poisonous.
- The freezing point of coolant mixture shall be 5°C lower than the freezing point of the riding area.

12. COOLING SYSTEM

COOLING SYSTEM TESTING RADIATOR CAP INSPECTION

* Removing the radiator cap while the engine is hot can cause the coolant to spray out, seriously scalding you.

Always let the engine and radiator cool down before removing the radiator cap.



(1)

Remove the radiator cap (1).

Pressure test should be served on the radiator cap.
Replace the radiator cap if it does not hold pressure, or if relief pressure is too high or too low.
It must hold the specified pressure for at least six seconds.

* Before installing the cap in the tester, wet the sealing surface.

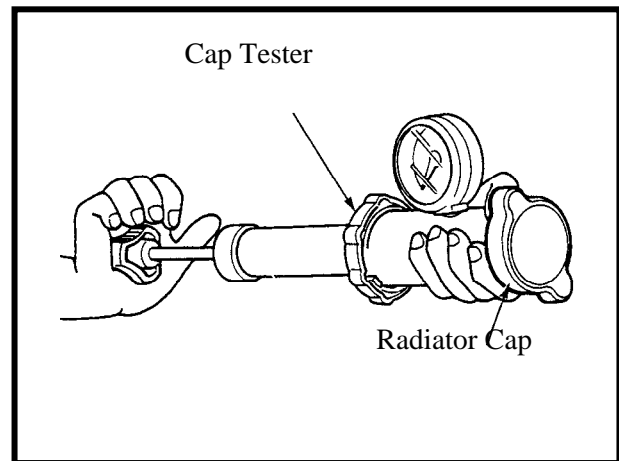

Radiator Cap Relief Pressure:
90 kPa (0.9 kg/cm², 12.8 psi)

Pressurize the radiator, engine and hoses, and check for leaks.

* Excessive pressure can damage the cooling system components.
Do not exceed 105 kPa (1.05 kg/cm², 14.9 psi).

Repair or replace components if the system will not hold the specified pressure for at least six seconds.

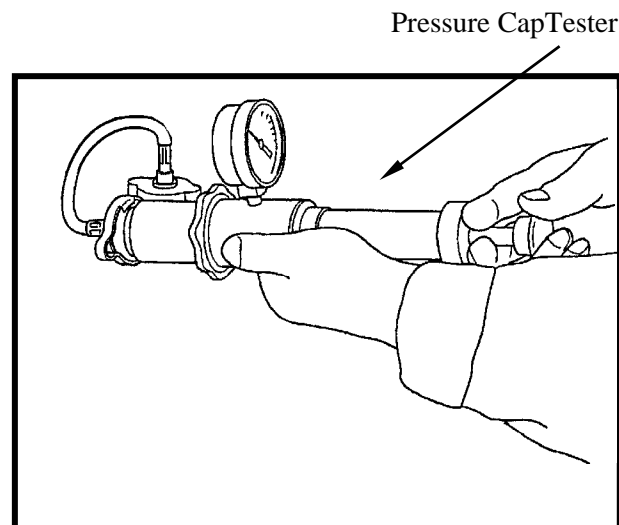

12. COOLING SYSTEM

COOLANT REPLACEMENT

PREPARATION

- The effectiveness of coolant decreases with the accumulation of rust or if there is a change in the mixing proportion during usage. Therefore, for best performance change the coolant regularly as specified in the maintenance schedule.
- Mix only distilled, low mineral water with the antifreeze.

Recommended mixture:

1:1 (Distilled water and antifreeze)

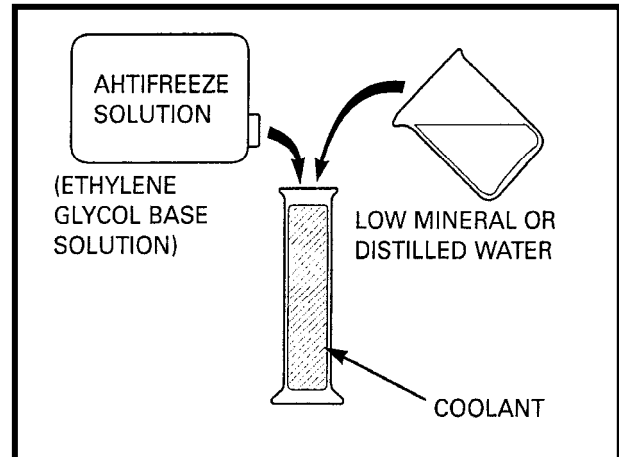

REPLACEMENT/AIR BLEEDING

Remove the front cover (refer to the “**FRAME COVERS REMOVAL/INSTALLATION**” section in the chapter 2).

* When filling the system or reserve tank with coolant (checking the coolant level), place the scooter in a vertical position on a flat, level surface.



(1)

Remove the radiator cap (1).

Remove the drain bolt (2) and drain the coolant from the system.

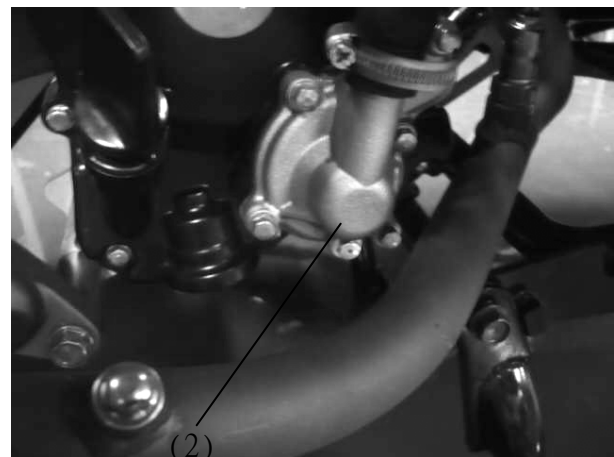

(2)

12. COOLING SYSTEM

Coolant level inspection

The reserve tank is under leg shield. Check the coolant level through the reserve tank lid while the engine is at the normal operating temperature, with the scooter in an upright position.

If the coolant level is below the LOWER level mark, remove the left floor mat, remove the lid screw, the reserve tank lid, and then the reserve tank cap to add coolant mixture until it reaches the upper level mark.



Reserve Tank Lid

Lid Screw



Reserve Tank Cap

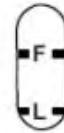

WARNING

Add coolant to the reserve tank only. Do not attempt to add coolant by removing the radiator cap. Coolant in the radiator is under pressure and is very hot and can cause serious burns.

12. COOLING SYSTEM

Fill the system with the recommended coolant through the filler opening up to the filler neck (1).

Bleed air from the system as follow:

1. Start the engine and let it idle for 2–3 minutes.
2. Snap the throttle three to four times to bleed air from the system.
3. Stop the engine and add coolant to the proper level if necessary. Reinstall the radiator cap.
4. Check the level of coolant in the reserve tank and fill to the upper level if it is low.



(1)

12. COOLING SYSTEM

RADIATOR

REMOVAL

Drain the coolant.

Disconnect the siphon hose (1) and air bleed hose (2).

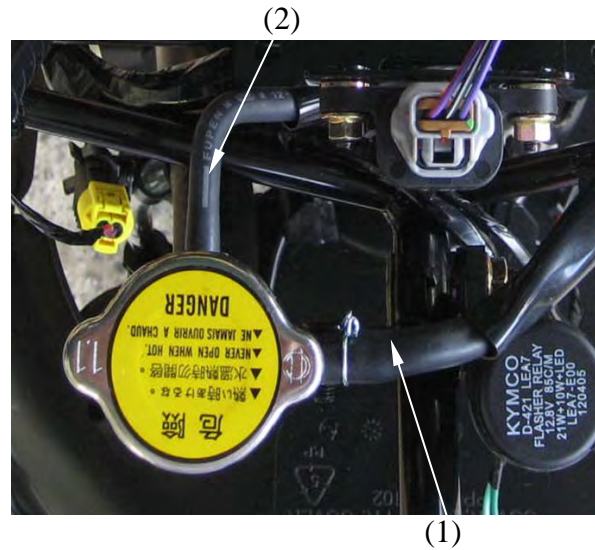

Loosen the hose bands, then disconnect the input radiator hose and output radiator hose from the radiator.



Disconnect the thermal switch connectors .

.

Fan motor connector

. Disconnect the fan motor connector.

.



12. COOLING SYSTEM

Remove bolts and then remove the radiator from frame.

INSTALLATION

Installation is in the reverse order of removal.

Refill the coolant



12. COOLING SYSTEM

FAN MOTOR

REMOVAL

Remove the radiator
Remove the three mounting bolts (1) and
then remove the fan motor (2)

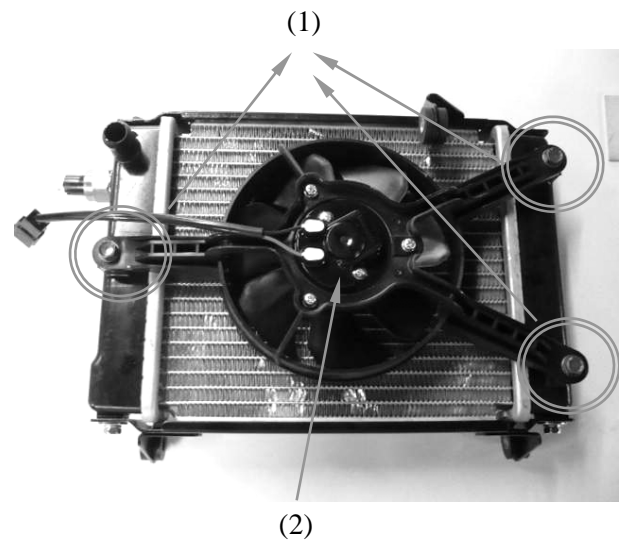

INSPECTION

Check the fan motor to operate using an
available battery.

INSTALLATION

Installation is in the reverse order of
removal.

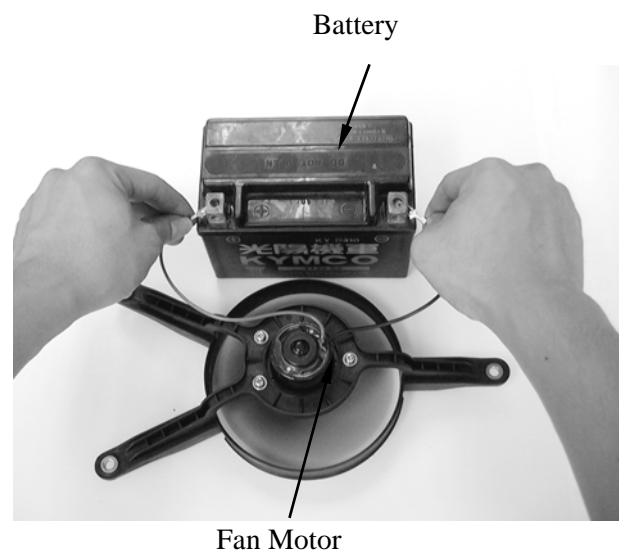

12. COOLING SYSTEM

FAN MOTOR SWITCH

REMOVAL

Disconnect the fan motor switch connectors

Remove the thermostat(1).

INSPECTION

Place the thermal switch in the stove with water as shown and raise the water temperature gradually to check for the temperature at which the starts to operate. If the thermal switch operating temperature is not within the specified range, replace the thermal switch with a new one.

OFF→ON	Over 88–92°C
ON→OFF	Lower 88–92°C

- *
 - Handle the cooling fan motor switch carefully as it is vulnerable to impact.

INSTALLATION

Change a new O-ring.

Tighten the cooling fan motor switch to specified torque.

Torque: 1.8 kgf-m (18 N-m, 13 lbf-ft)

- *
 - Replace the O-ring a new one.
 - Do not use grease to the O-ring.

(1)

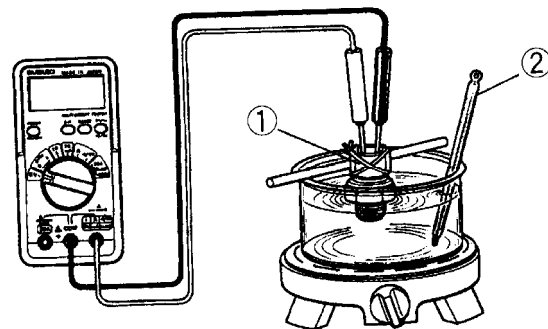
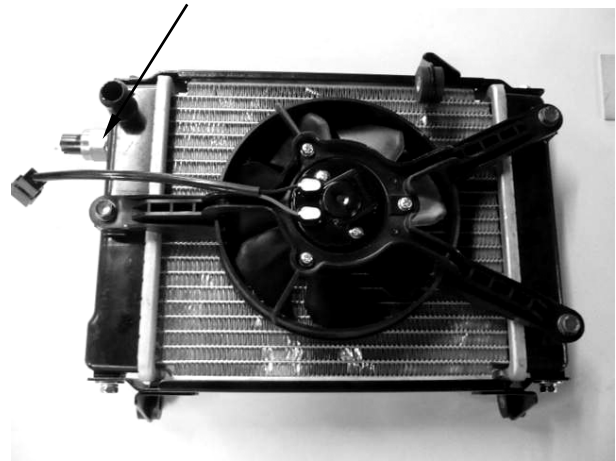

12. COOLING SYSTEM

WATER PUMP

MECHANICAL SEAL (WATER SEAL) INSPECTION

Inspect the telltale hole for signs of mechanical seal coolant leakage. If the mechanical seal is leaking, remove the right crankcase cover and replace the mechanical seal.

Right Crankcase Cover

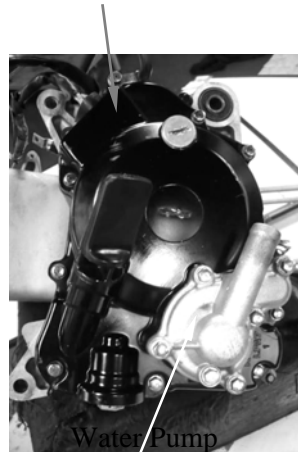

WATER PUMP/IMPELLER REMOVAL

Drain the coolant .

Remove the coolant inlet hose and outlet hose.

Outlet Hose

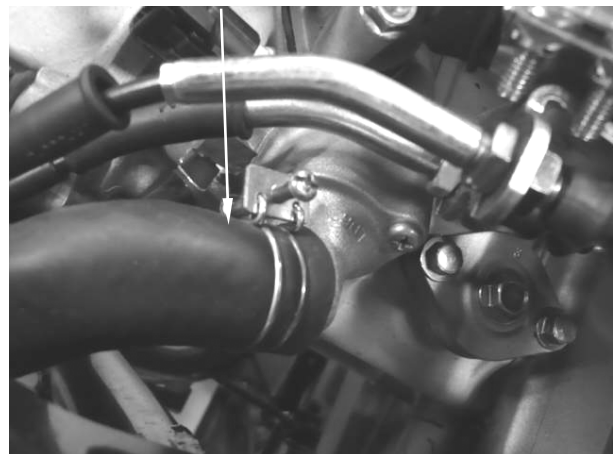

12. COOLING SYSTEM

Remove four bolts and the water pump cover, gasket and two dowel pins.

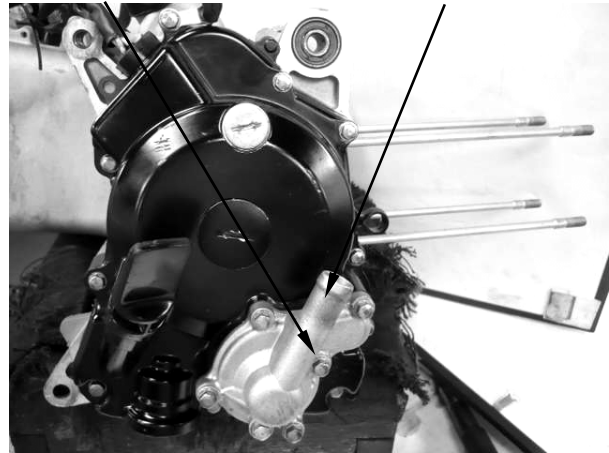
Bolts**Water Pump Cover**

Remove the water pump impeller.

* The impeller has left hand threads.

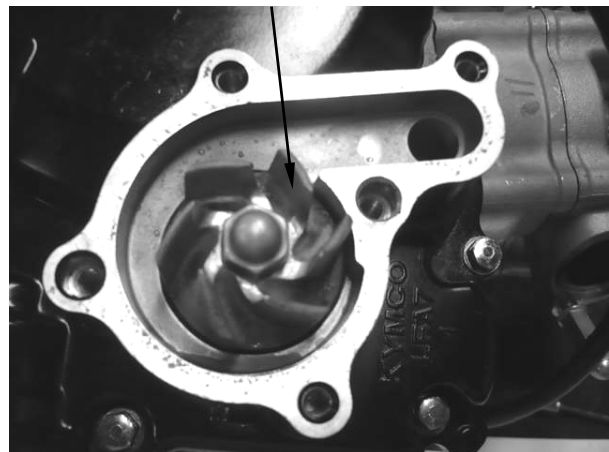
Impeller (Left Hand Threads)

Inspect the mechanical (water) seal and seal washer for wear or damage.

* The mechanical seal and seal washer must be replaced as a set.

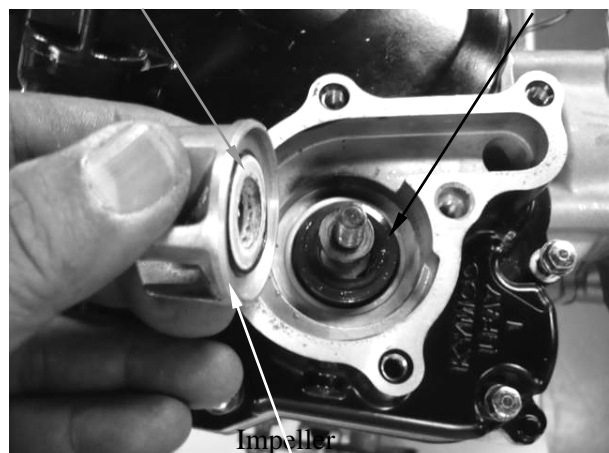
Seal Washer (Porcelain)**Mechanical Seal**

12. COOLING SYSTEM

WATER PUMP SHAFT REMOVAL

Disconnect the water hose from the right crankcase cover.
Remove five bolts attaching the water pump assembly.
Remove the water pump assembly, gasket and dowel pins.



Remove the water pump shaft clip and water pump shaft

Water Pump Shaft



12. COOLING SYSTEM

Install the dowel pins and a new gasket and then install the water pump assembly to the right crankcase cover.
Tighten five bolts to secure the water pump assembly.

* When installing the water pump assembly, aligning the groove on the water pump shaft with the tab on the oil pump shaft.

Water Pump Assembly



WATER PUMP/IMPELLER INSTALLATION

When the mechanical seal is replaced, a new seal washer must be installed to the impeller.

Seal Washer (Porcelain)

Mechanical Seal

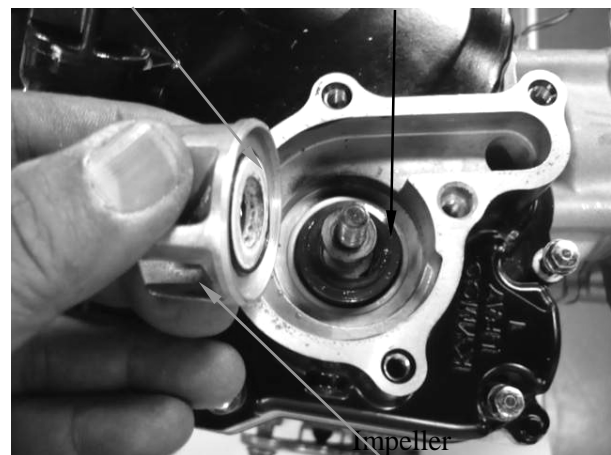

12. COOLING SYSTEM

Install the impeller onto the water pump shaft.

Torque: 1.2 kgf-m (12 N-m, 9 lbf-ft)

* The impeller is with left hand threads.

Impeller (Left Hand Threads)

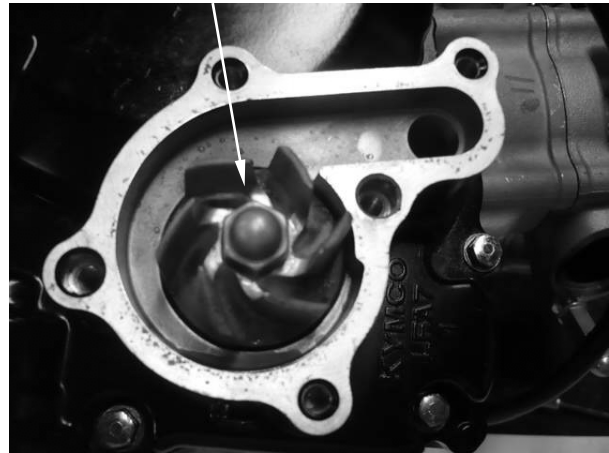

Install two dowel pins and a new gasket.

Dowel Pins

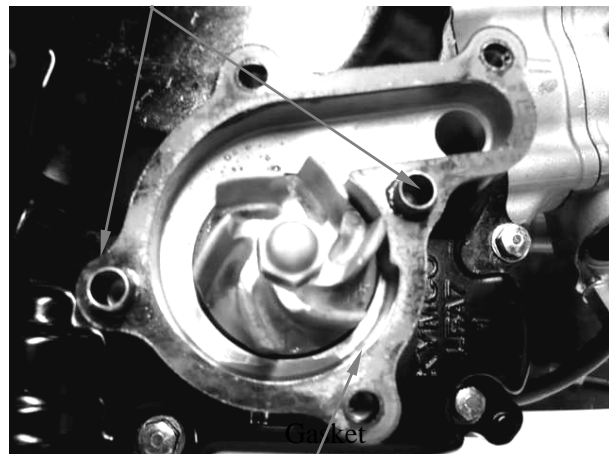

Install the water pump cover and tighten the 4 bolts.

Torque: 1 kgf-m (10 N-m, 7 lbf-ft)

Water Pump Cover

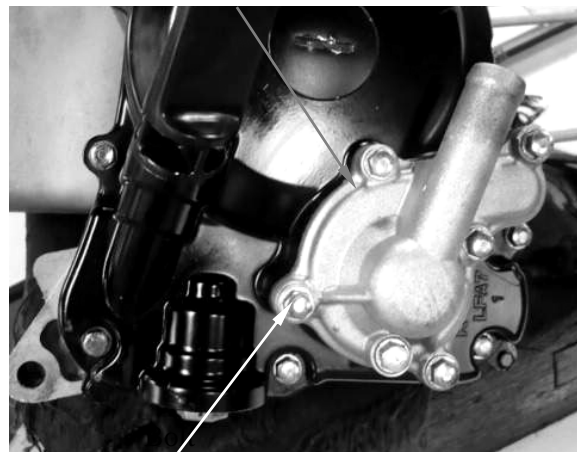

12. COOLING SYSTEM

WATER TEMPERATURE SENSOR

REMOVAL

Remove the luggage box

Drain the coolant

Disconnect the water temperature sensor connectors (1).

Remove the water temperature sensor (2) from thermostat.

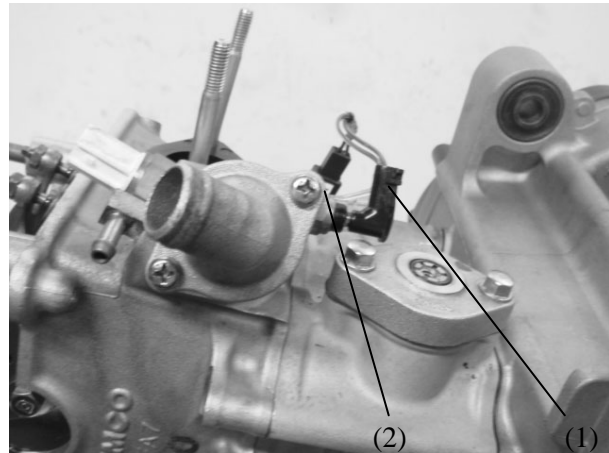

INSPECTION

Connect the water temperature sensor to the ohmmeter and dip it in water contained in a pan which is placed on an electric heater.

Gradually raise oil temperature while reading the thermometer in the pan and the ohmmeter connected. If the resistance measured is out of specification, replace the temperature gauge with a new one.

Temperature	Standard resistance
50°C	133.9 – 178.9 Ω
100°C	26 – 29.3 Ω

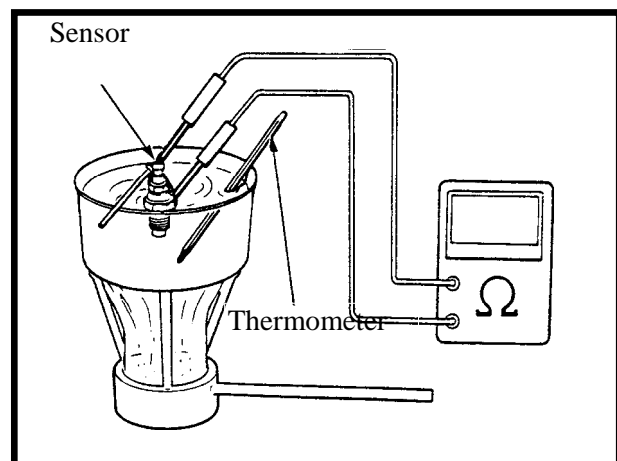

- ***
- Handle the water temperature sensor carefully as it is vulnerable to impact.
 - Do not allow the water temperature sensor and the thermometer to come in contact with the bottom of the pan.

12. COOLING SYSTEM

INSTALLATION

Tighten the water temperature sensor.

Torque: 0.8 kgf-m (8 N-m, 5.8 lbf-ft)

Connect the sensor connectors.

After the water temperature sensor has been installed, fill coolant and perform air bleeding .

12. COOLING SYSTEM

THERMOSTAT

THERMOSTAT REMOVAL

REMOVAL

Drain the coolant

Remove the luggage box

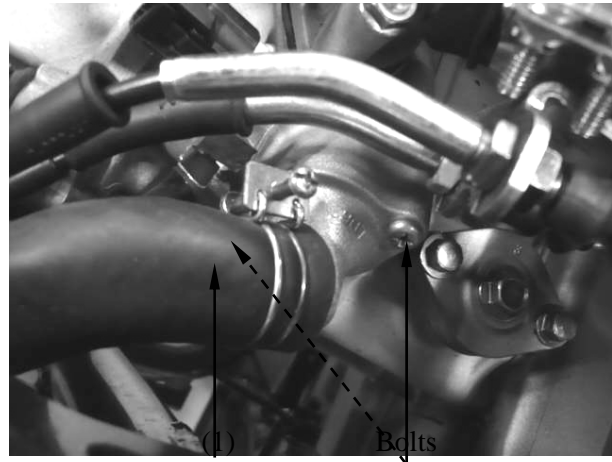

Disconnect the water hose (1) from the thermostat housing.

Remove the mounting bolt (2) and the thermostat housing attaching the cylinder head.

INSTALLATION

The installation sequence is the reverse of removal.

After the water thermostat has been installed, fill coolant and perform air bleeding .

12. COOLING SYSTEM

DISASSEMBLY

Remove two screws and separate the thermostat housing halves.

Screws

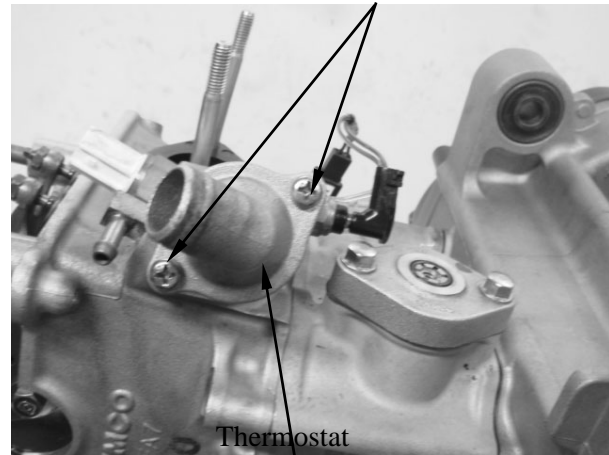

Remove the thermostat from the thermostat housing.

Thermostat

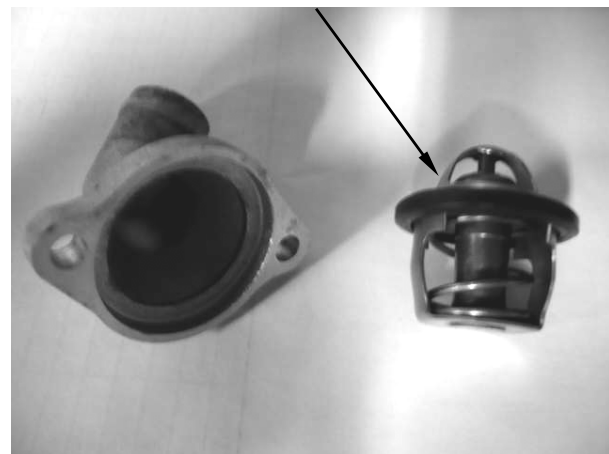

12. COOLING SYSTEM

INSPECTION

Suspend the thermostat in a pan of water over a burner and gradually raise the water temperature to check its operation.

Technical Data

Begins to open	71 ± 1.5°C
Full-open	80°C
Valve lift	3.5 mm (0.14 in) minimum

- * Do not let the thermostat touch the pan as it will give a false reading.
- Replace the thermostat if the valve stays open at room temperature.
 - Test the thermostat after it is opened for about 5 minutes and holds the temperature at 70°C.

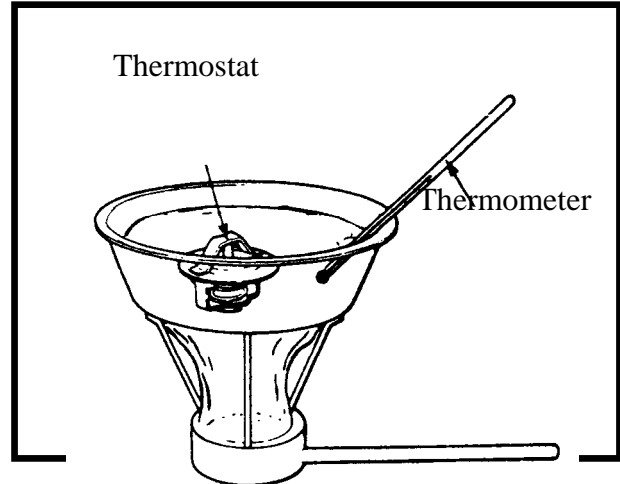

ASSEMBLY

Thermostat assembly is in the reverse order of disassembly.

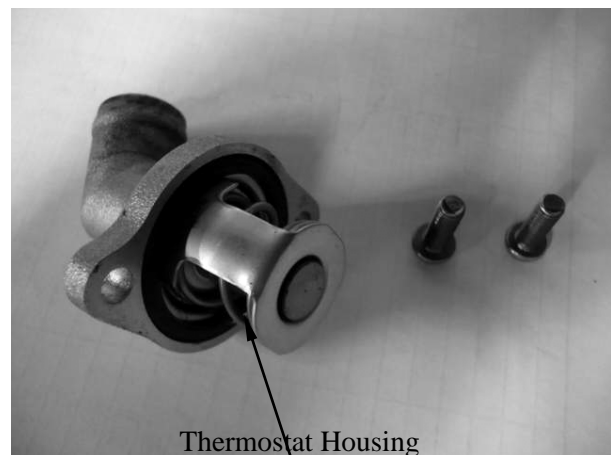

13. Fi DIAGNOSTIC TOOL OPERATION

Fi Diagnostic Tool Operation Instructions Part No. 3620A-LEB2-E00



13

KEY FUNCTION

- | | |
|--------------------------------------|---------------|
| ① Model No. | ⑧ DATAAnalyze |
| ② Down Button | ⑨ DTC Inspect |
| ③ DTC indicator(Failure codes) | ⑩ ECU Version |
| ④ Enter or Exit | |
| ⑤ Power indicator | |
| ⑥ UP Button | |
| ⑦ Adjust(TPI and ABV reset function) | |

13. Fi DIAGNOSTIC TOOL OPERATION

Fi diagnostic tool Outlook.....	13-0	Adjust.....	13-8
DTC Inspection Precedure	13-2	Diagnostic Standard Specifications	13-9
DTC Clear Procedure	13-5		
Data Analysis.....	13-6		

13. Fi DIAGNOSTIC TOOL OPERATION

DTC INSPECTION PROCEDURE

Connect Fi diagnostic tool with the connector of harness wire located beside the Battery.

Diagnostic Tool Connector



Press the "Enter" button

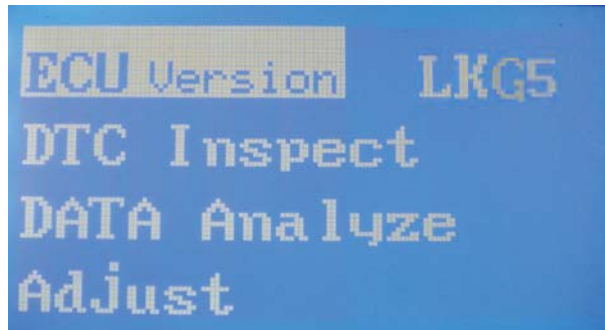

Check the software version

Press the "Enter" button and then turn to the first page.

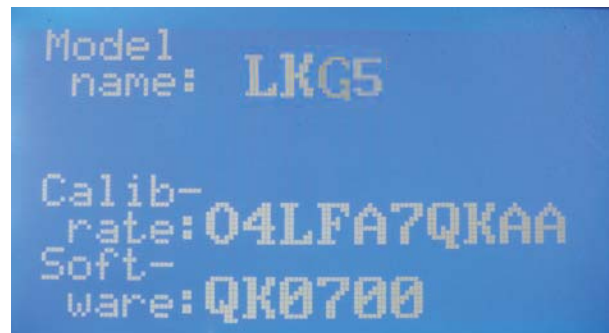

Press the "Down" button to enter the DTC Inspect.

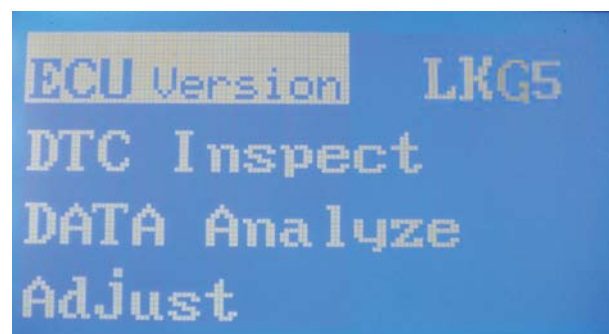

13. Fi DIAGNOSTIC TOOL OPERATION

Press the "Enter" button to check the DTC number

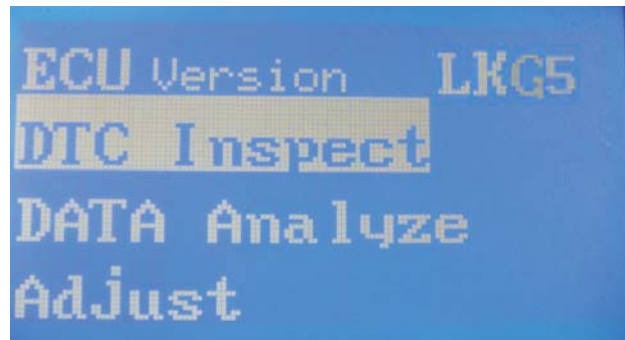

Press the "Enter" button

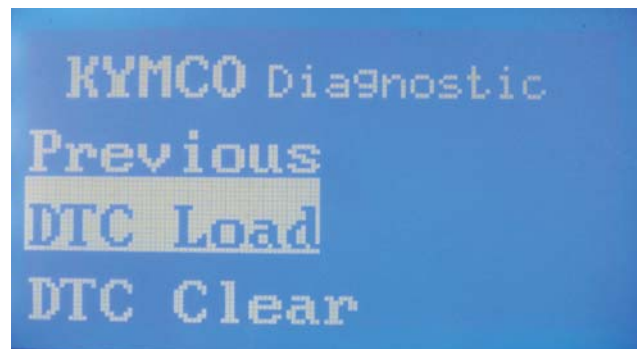

Press the "Enter" button

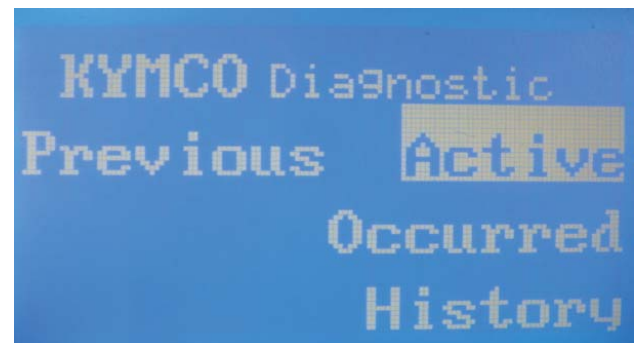

Display what's DTC number on this DTC-List.
Refer to DTC summary list.

Press the "Enter" button and then turn to the
previous page

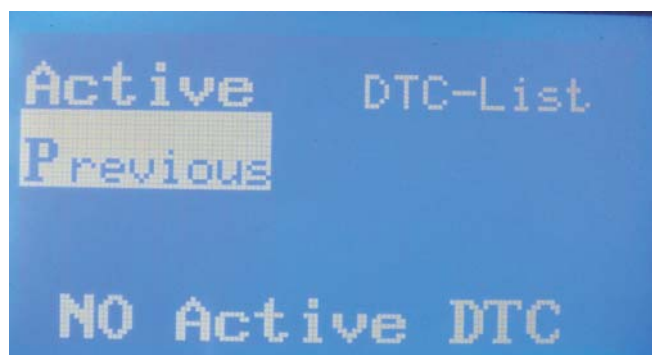

13. Fi DIAGNOSTIC TOOL OPERATION

Press the "UP" button

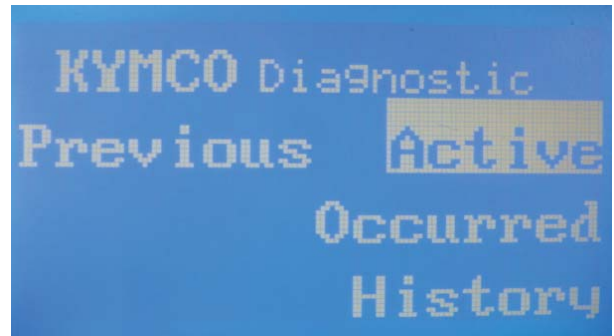

Press the "Enter" button and then turn to the previous page.

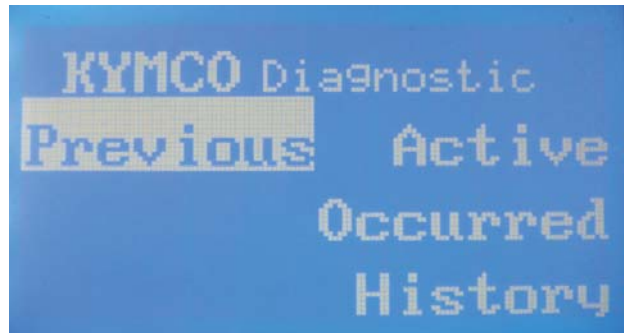

Press the "UP" button

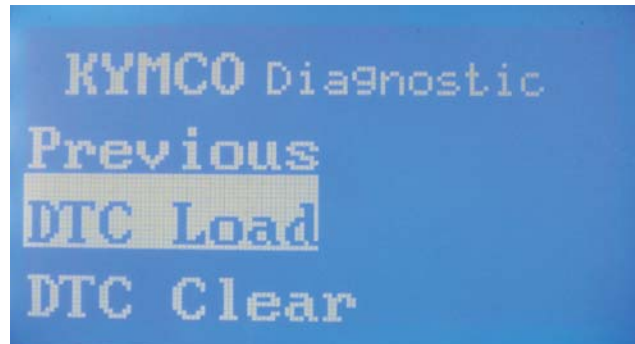

Press the "Enter" button and then turn to the first page.

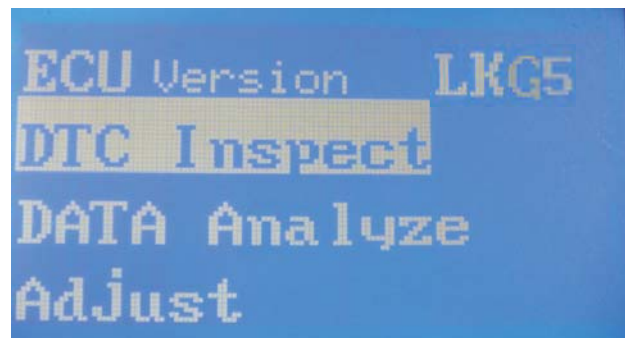

13. Fi DIAGNOSTIC TOOL OPERATION

DTC CLEAR PROCEDURE

Choose "Load DTC"

Press the "Down" button

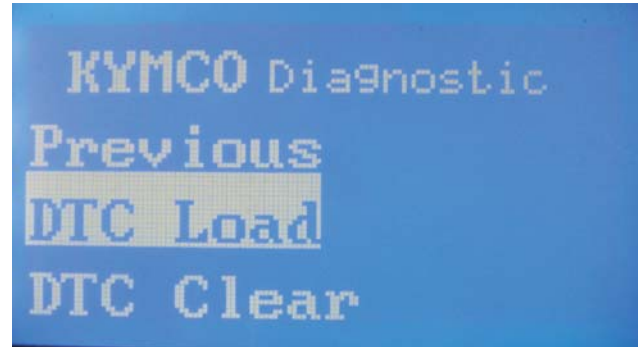

Press the "Enter" button

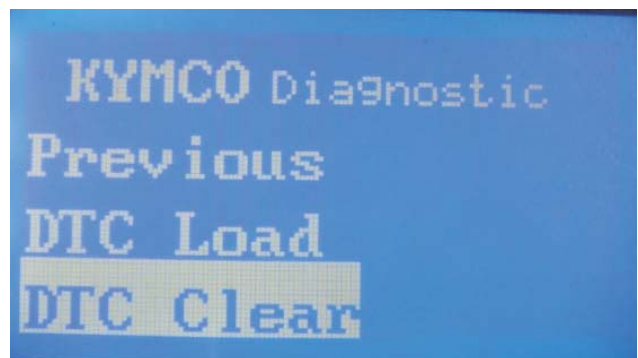

The DTC indicator is lighting at that time.



Clearing DTC completed until the DTC indicator is off.

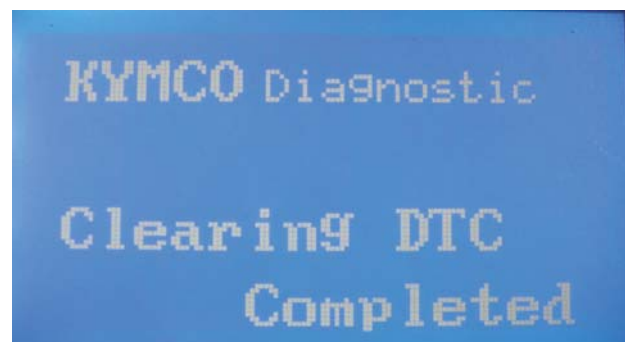

13. Fi DIAGNOSTIC TOOL OPERATION

DATA ANALYSIS

Choose "Data Analyze"

Press the "Enter" button to enter page 01.

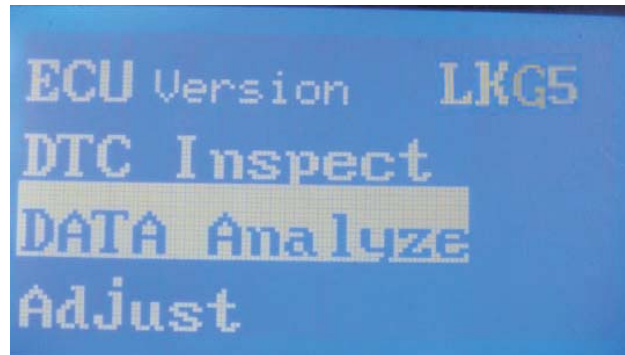

The figure includes engine speed, idle speed setpoint and battery voltage.

Refer to standard specifications .

Press the "Down" button to enter page 02.

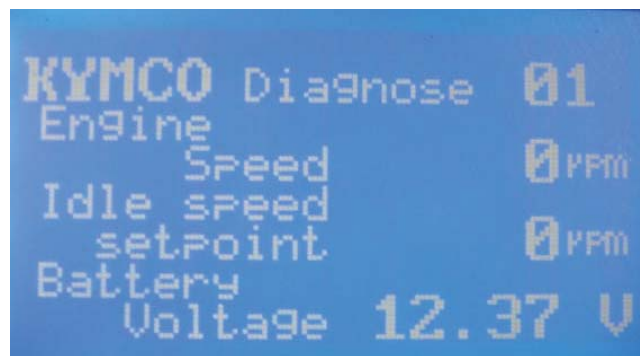

The figure includes TPS position, TPI idle adapted voltage and TPI WOT adapted (Throttle grip fully opened).

Refer to standard specifications .

Press the "Down" button to enter page 03.

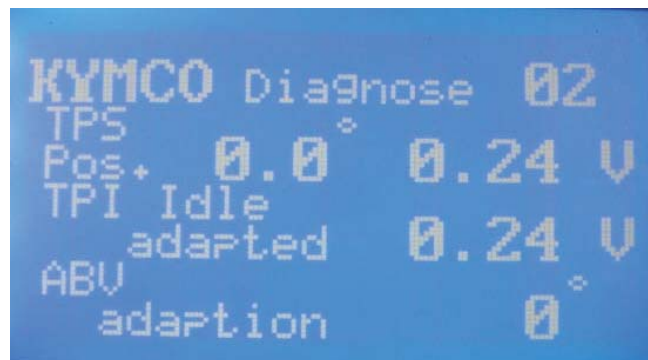

The figure includes engine working temperature, atmosphere pressure and Manifold pressure.

Refer to standard specifications on page 18-9.

Press the "Down" button to enter page 04.

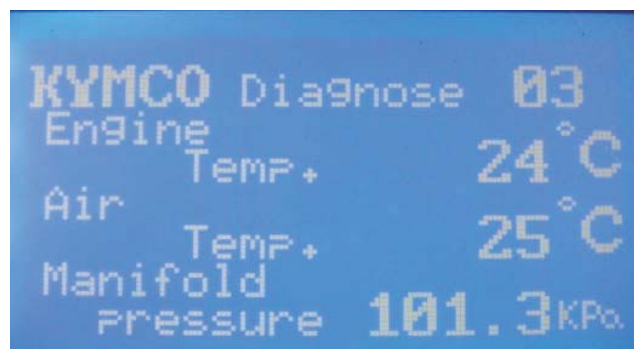

13. Fi DIAGNOSTIC TOOL OPERATION

The figure includes fuel injector interval, ignition advance angle and ABV angle.

Refer to standard specifications .

Press the " Down " button to enter page 05.

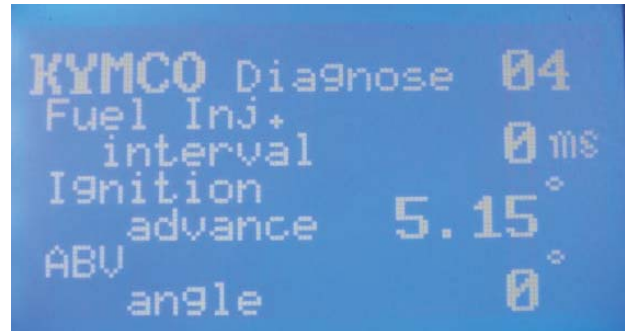

The figure includes O2 sensor voltage, O2 heater working condition and O2 correction.

Refer to standard specifications .

Press the " Down " button to enter page 06.

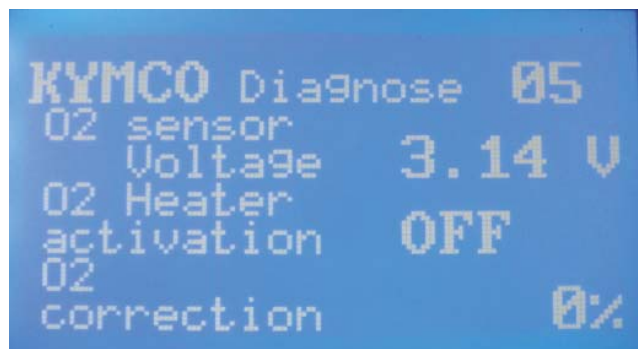

The figure includes rollover voltage .

Refer to standard specifications .

Press the " Down " button to enter page 07.



The figure includes ECU counter hours.

Press the " UP " button to the first page.

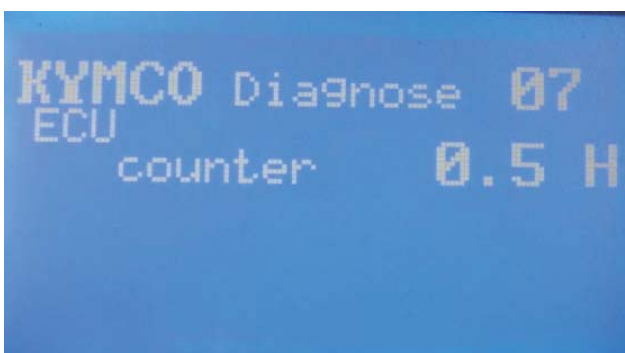

13. Fi DIAGNOSTIC TOOL OPERATION

ADJUST

Need to make TPI/ABV reset to operate after changing new ECU and clean THROTTLE BODY and changing the engine department product, let ECU set up and set up initially

Choose "Adjust"

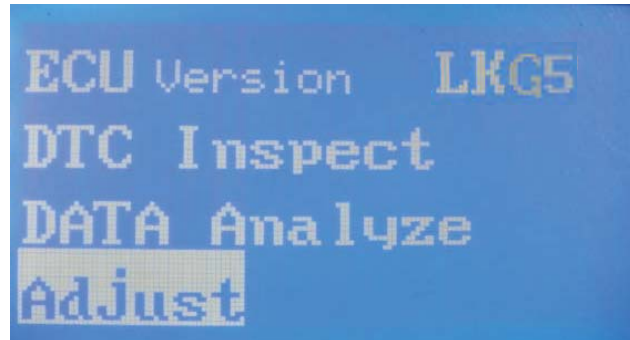

Press the "Enter" button to TPI/ABV Reset

Press the "Enter" button

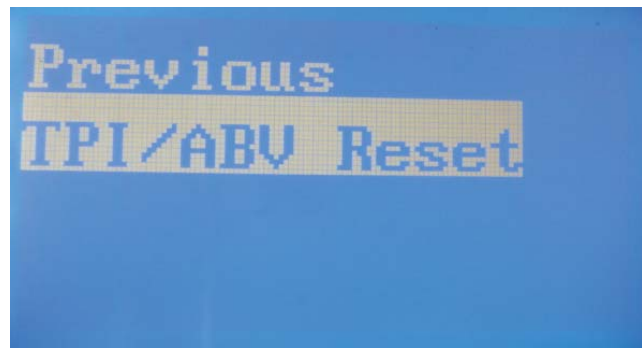

Please key switch off then key switch on
Completed the TPI/ABV reset operate.

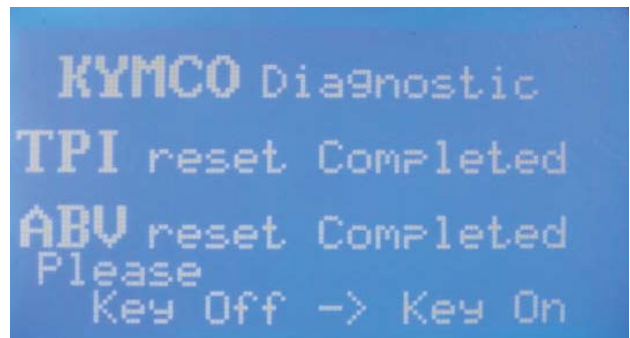

13. Fi DIAGNOSTIC TOOL OPERATION



LKG5

SF : Customer : Eng. No:
 Production Service Mileage :
 Date : Date :

Reason of repair: <input type="checkbox"/> maintenance <input type="checkbox"/> breakdown				
Item		Date	Reference	Memo
ECU Version	ECU No		---	
	Hardware Ver		---	
	Software Ver		QK0A00	
	Calibration Ver		---	
	Model Name		KYMCO-LKG5	
DTC	Active			
	Occurred			
	History			
(Cool Engine) Engines Stop	DTC Number			
	Throttle Position(%)		0%	Full Throttle: >90%
	Throttle Position Voltage (V)		0.23±0.05 V	Full Throttle Voltage: >3.27V
	Throttle Idle Learning (V)		0.23±0.05 V	
	Engine Temp.(°C)		environ.temp ± 2 °C	
	Atom. Pressure(Kpa)		101.3 ± 3 kPa	
	Battery Voltage(V)		>12 V	
	Roll Sensor State		0.4 ~ 1.44V(stand)	3.7 ~ 4.4V (Fall down)
	CO Set		0	Original Setting: 0
(Hot Engine) Before Repair	Engine speed (rpm)		1850 ± 100 rpm	
	Intake Pressure(Kpa)		48~60 kpa	
	Engine Temp.(°C)		environ.temp ± 2 °C	
	Fuel Inject Interval(ms)		1.6 ~ 2.7 ms	
	Ignition Timing (°)		5 ~ 17 BTDC	
	Charging Interval(ms) during ignitin		1.9 ~ 2.6 ms	
	O2 Sensor Voltage(V)		0~1 V	
	O2 Sensor Heater Performance		ON	
	O2 correction rate		± 20%	
	ABV Opening Angle		< 80°	Air screw can be adjusted 1/4-1/2 turn if over 80°
			< 140°	Clean the throttle body if over 140°
	IDLE CO(%)		0.4~1.2%	When engine working temperature is 80-90°C
	(Hot Engine) After Repair	Engine speed (rpm)		1850 ± 100 rpm
Intake Pressure(Kpa)			48~60 kpa	
Engine Temp.(°C)			environ.temp ± 2 °C	
Fuel Inject Interval(ms)			1.6 ~ 2.7 ms	
Ignition Timing (°)			5 ~ 17 BTDC	
Charging Interval(ms) during ignitin			1.9 ~ 2.6 ms	
O2 Sensor Voltage(V)			0~1 V	
O2 Sensor Heater Performance			ON	
O2 correction rate			± 20%	
ABV Opening Angle			< 80°	Air screw can be adjusted 1/4-1/2 tun if over 80°
			< 140°	Clean the throttle body if over 140°
IDLE CO(%)			0.4~1.2%	When engine working temperature is 80-90°C
Repair description			Repair Process	

Report ID=

14. K-XCT 125 i FUEL SYSTEM (Auto Control Fuel Injection System)

FUEL SYSTEM (Auto Control Fuel Injection System)

SYSTEM DIAGRAM	14-1
SYSTEM LOCATION.....	14-2
SERVICE INFORMATION	14-3
TROUBLESHOOTING.....	14-4
CHECK ENGINE LAMP (CELP)	14-5
HOW TO SHOW THE FAILURE CODE	14-6
CELP FAILURE CODES CHART	14-7
MAINTAINING BY CHECKING COMPONENT	14-11
MAINTAINING SPECIAL NOTICE	14-16
MAINTAINING RESET	14-17
DIAGNOSTIC RECORD SHEET	14-18

14. K-XCT 125 i FUEL SYSTEM (Auto Control Fuel Injection System)

SYSTEM DIAGRAM

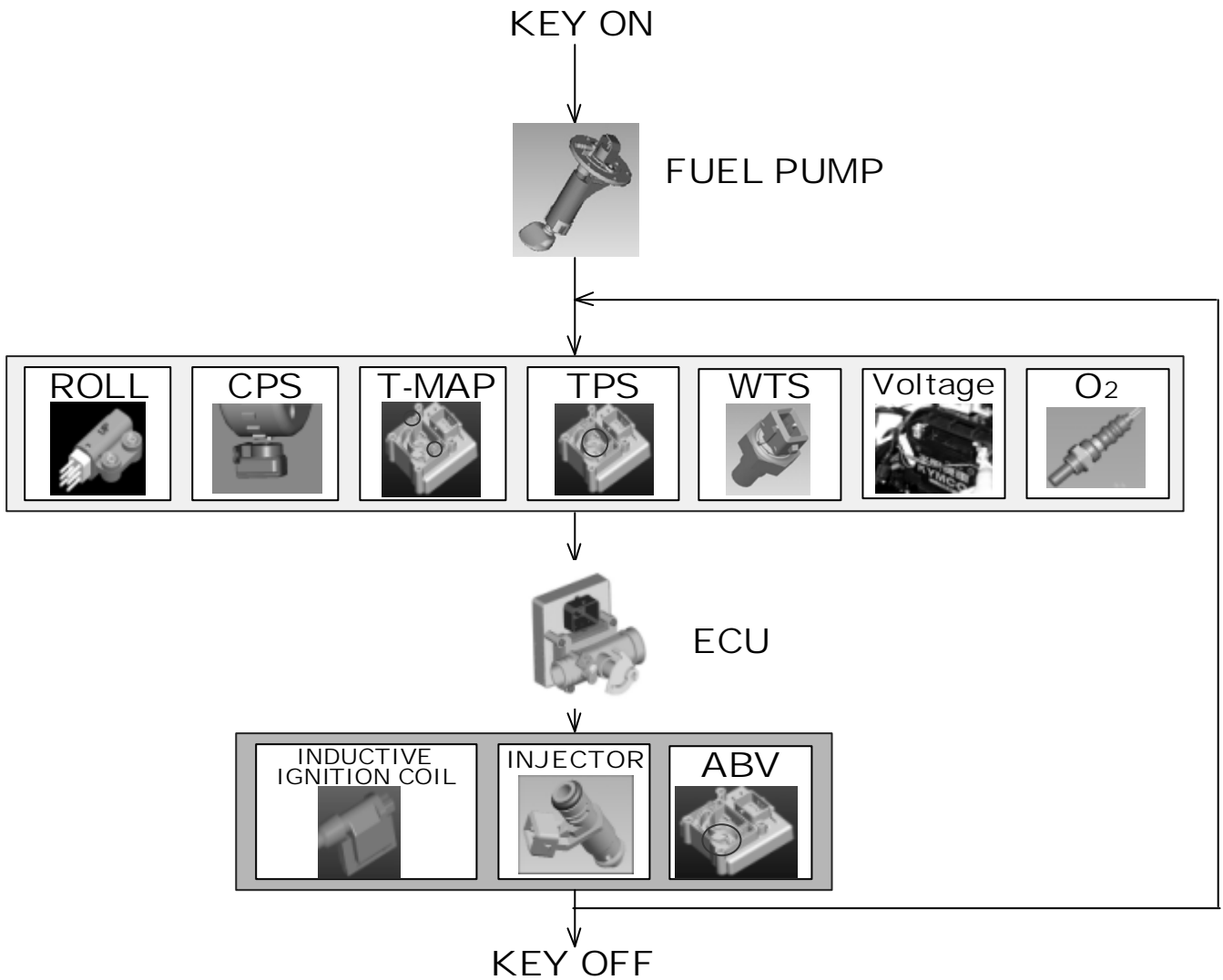

14. K-XCT 125 i FUEL SYSTEM (Auto Control Fuel Injection System)

SYSTEM LOCATION

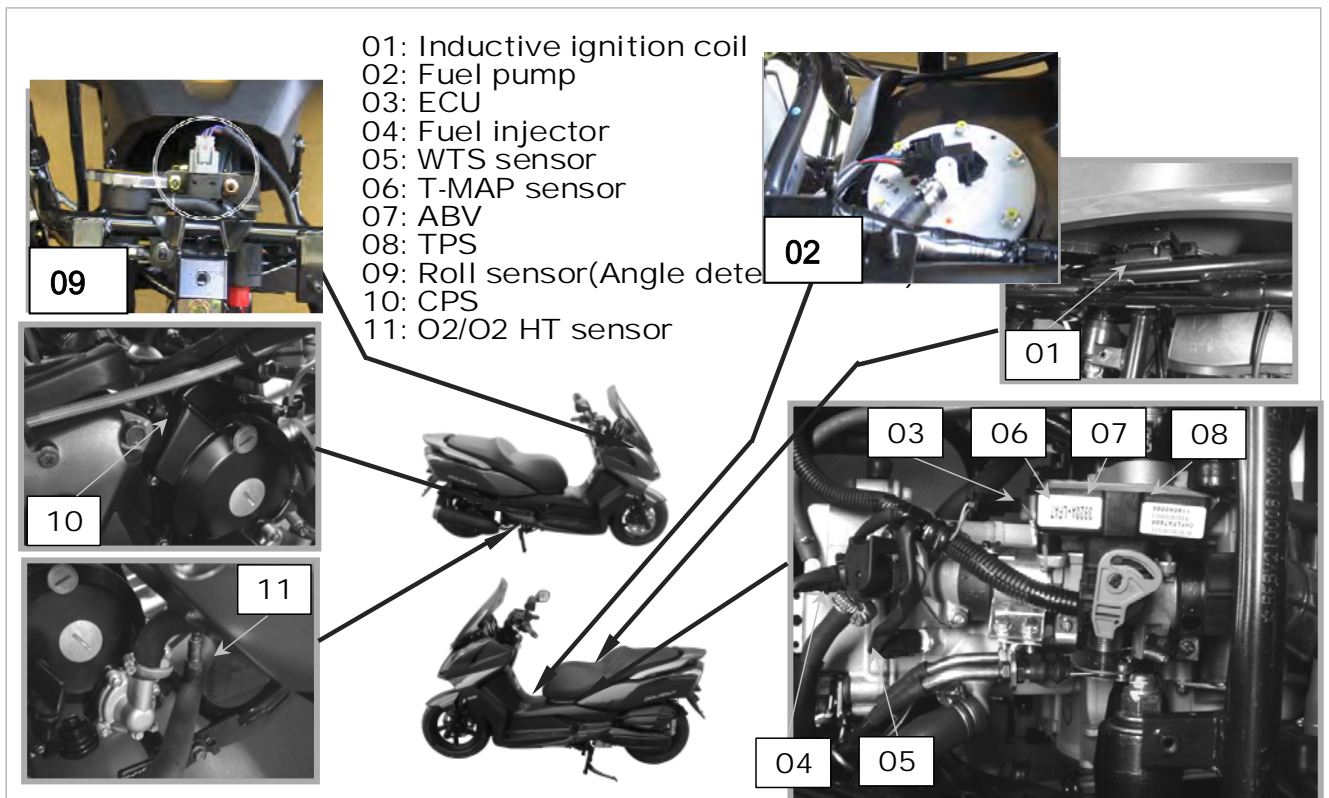

14. K-XCT 125 i FUEL SYSTEM (Auto Control Fuel Injection System)

SERVICE INFORMATION

GENERAL INSTRUCTIONS

* Gasoline is very dangerous. When working with gasoline, keep sparks and flames away from the working area.
Gasoline is extremely flammable and is explosive under certain conditions. Be sure to work in a well-ventilated area.

- Disconnect the cables of the battery when the engine is running, which could lead to ECU damage.
- Connect the harness positive (+) cable to the battery negative (-) terminal or connect the harness negative (-) to the battery positive (+) terminal, which could lead to ECU damage.
- Always keep fuel over 750 cc in fuel tank.

SPECIFICATIONS

Item		Standard	
Charging voltage of battery		13.5~14.5V	
Voltage from the ECU to sensor		5±0.1V	
Fuel injector resistance (20°C/68°F)		10.6~15.9Ω	
Water temperature sensor resistance		2.075±10 KΩ (20~30°C)	
Throttle position sensor voltage		Idle (0°)=0.23±0.05V Throttle fully (90° /3.27V over)	
Fuel pump resistance (20°C/68°F)		F: about 1100Ω E: about 100Ω	
O2 sensor	O2 sensor heater resistance	6.7~9.5Ω	
	Voltage	Air/Fuel<14.7 (Rich)	>0.7V
		Air/Fuel>14.7 (Lean)	<0.18V

Item	Standard
Crank position sensor (Pulser) resistance (20°C/68°F)	95~144Ω
Inductive ignition coil resistance (20°C/68°F)	0.55~0.75Ω
Roll sensor voltage (diagnostics)	Normal: 0.3~1.4V Over 65° fall down: 3.5~4.7V
Idle speed	1800±100 rpm

14. K-XCT 125 i FUEL SYSTEM (Auto Control Fuel Injection System)

TROUBLESHOOTING

Engine won't start

- Battery voltage too low
- Fuel level too low
- Pinched or clogged fuel hose
- Faulty fuel pump operating system
- Clogged fuel filter (fuel pump)
- Clogged fuel injector
- Faulty spark plug or wrong type
- Cut by ECU due to angle detect sensor or incorrect function

Backfiring or misfiring during acceleration

- Ignition system malfunction

Poor performance (drive ability) and poor fuel economy

- Pinched or clogged fuel hose
- Faulty fuel injector

Engine stall, hard to start, rough idling

- Intake air leak
- Fuel contaminated/deteriorated
- Pinched or clogged fuel hose
- Idle speed misadjusted



14. K-XCT 125 i FUEL SYSTEM (Auto Control Fuel Injection System)

CHECK ENGINE LAMP (CELP)

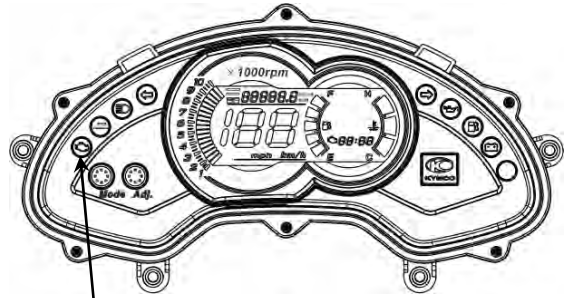
- When turning on the switch, the lamp will be lighted for 2 seconds then off. Let user to know the lamp is available and connect to ECU.
- But after then or during riding, if the CELP start to blink or keep lighting, it means something wrong with this vehicle, you better do the further check to find out the failure code to know which part get trouble
- There are 3 kinds of priority grade let user to know what kind of trouble was happened.
- Priority grade 1: CELP blinks continuously. This is the most emergent situation like engine over heat. User better slow down the riding and go to dealer for checking.
- Priority grade 2: CELP lights all the time. It means components get trouble or circuit something wrong. Do the further check to find out the failure code to know which part get trouble.
- Priority grade 3: CELP just blinks once suddenly and then disappear. It sometimes just warning like the RPM was too high in a short term.

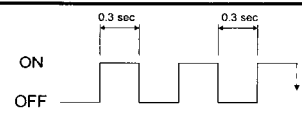

CELP (Check Engine Lamp)

PRIORITY	LAMP ACTION
1	<p>ON</p> <p>OFF</p> 
2	<p>ON</p> <p>OFF</p> 
3	<p>ON</p> <p>OFF</p> 

14. K-XCT 125 i FUEL SYSTEM (Auto Control Fuel Injection System)

How To Show Failure Code

- You can read the failure code by as below :
- Turn switch on. The CELP will be lighted for 2 seconds then off. The CELP start to blink to show the failure codes (The number of blinks from 1 to 25).
- If vehicle got more than one failure code, the CELP will be shown from lower number failure code and then show the other higher number one after four seconds. All the failure codes would be shown repeatedly.

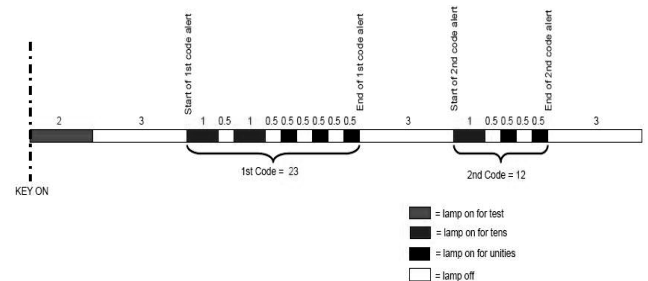

How To Reset Failure Code

- After repairing the trouble, you should clear the failure code or it will still exist in the ECU memory. When you maintain this vehicle next time, it will show again and you get confuse.
- Turn switch on. The CELP will be lighted for two seconds then off.
- The CELP begins to blink to show the failure codes.
- The self-diagnosis memory data will be erased when all the failure codes has showed for **4** cycles.

14. K-XCT 125 i FUEL SYSTEM (Auto Control Fuel Injection System)

CELP Failure Code Chart(1)

Blink	Failure Codes	Fault description	Priority	Fault management
1	P0217	Engine temperature overheat	1	1.Slow down the vehicle and go to workshop for checking immediately. 2.Confirm if the engine temperature sensor or electric circuit is abnormality.
2	P0335	Crankshaft position sensor or circuit malfunction	2	1.Check if the connector of crankshaft position sensor is loosen. 2.Check if the Rotor is align with Crankshaft position sensor during the crankshaft running.
3	P1120	Throttle position sensor setting value problem	2	1.Make sure if the connector of Throttle position sensor is connected correctly. 2.Check if the Throttle position sensor is adjusted.
4	P1121	Throttle position sensor output range problem	2	1.Make sure if the connector of Throttle position sensor is connected correctly. 2.Check if the Throttle position sensor is adjusted.

14. K-XCT 125i FUEL SYSTEM (Auto Control Fuel Injection System)

CELP Failure Code Chart(2)

Blink	Failure Codes	Fault description	Priority	Fault management
5	P1122	Throttle position sensor movement speed problem	2	<ol style="list-style-type: none"> 1.Make sure if the connector of Throttle position sensor is connected correctly. 2.Check if theThrottle position sensor is adjusted.
6	P0560	Battery voltage malfunction	1	<ol style="list-style-type: none"> 1. Check if the battery voltage is lower or higher. 2.Check if the charge system is malfunction.
7	P0110	Inlet air temperature sensor or electric circuit malfunction	2	<ol style="list-style-type: none"> 1. Check if the connector of Inlet air temperature sensor loosen. 2.Check if the resistance of sensor is normal .
8	P0410	Idle air valve or electric circuit malfunction	2	<ol style="list-style-type: none"> 1. Check if the connector of Idle air valve loosen. 2.Check if the resistance of valve is normal.
9	P0505	Idle speed volume control range	2	<ol style="list-style-type: none"> 1.Check if the opening angle is over 180 for Idle air valve. 2.Check if the opening angle is malfunction.
10	P0251	Injector or electric circuit	2	<ol style="list-style-type: none"> 1.Check if the connector of Injector is loosen. 2.Check if the ECU send signal to Injector. 3.Check if the power source and resistance of Injector are malfunction.

14. K-XCT 125 i FUEL SYSTEM (Auto Control Fuel Injection System)

CELP Failure Code Chart(3)

Blink	Failure Codes	Fault description	Priority	Fault management
11	P0350	Ignition coil or electric circuit malfunction	2	1. Check if the connector of ignition coil is loosen. 2. Check if the ECU send signal to Ignition coil. 3. Check if the power source and resistance is malfunction.
12	P0230	Fuel pump relay or electric circuit malfunction	2	1. Check if the connector of relay is loosen. 2. Check if the ECU send signal to relay. 3. Check the fuel pump relay resistance
13	P0219	Engine speed is over than top speed	2	Check if the belt of CVT is broken.
14	P1560	Sensor don't receive power source from ECU	2	1. Check if ECU output DC5V to sensor. 2. Check if the power source of all sensor is DC5V. 3. Replace a new ECU if the CELP still blinks even the output power source of ECU is normal.
15	P0700	Engine starting speed exceed CVT speed limited	2	1. Check if the throttle wire locked. 2. Check if the position of throttle screw is correct. 3. Check if the belt of CVT is broken.
16	P0115	Engine temperature sensor or electric circuit malfunction	2	1. Check if the connector of sensor is loosen. 2. Check if ECU pin is broken. 3. Check if the resistance of sensor is malfunction.
17	P1561	Temperature gauge electric circuit malfunction	2	Don't use it at present.

14. K-XCT 125 i FUEL SYSTEM (Auto Control Fuel Injection System)

CELP Failure Code Chart(4)

Blink	Failure Codes	Fault description	Priority	Fault management
18	P0650	CELP electric circuit malfunction	3	<ol style="list-style-type: none"> 1. Check if the lamp of CELP is broken. 2. Check if wires of CELP is broken.
21	P0105	Atmospheric Pressure Sensor or electric Circuit Malfunction	2	<ol style="list-style-type: none"> 1. Check if the connector of sensor is loosen. 2. Check if ECU pin is broken. 3. Check if voltage of sensor is fit in specification.
22	P1110	Roll sensor or electric circuit malfunction	2	<ol style="list-style-type: none"> 1. Check if the sensor installation direction is correct. 2. Check if voltage of sensor is fit in specification. 3. Check if ECU pin is broken.
23	P0136	O2 sensor malfunction	1	<ol style="list-style-type: none"> 1. Check if the connector of sensor is loosen. 2. Check if ECU pin is broken.
24	P0141	O2 sensor heater malfunction	1	<ol style="list-style-type: none"> 1. Check if the connector of sensor is loosen. 2. Check if ECU pin is broken. 3. Check if the resistance of sensor is malfunction.
25	P0171	O2 sensor electric circuit malfunction	1	<ol style="list-style-type: none"> 1. Check if the connector of sensor is loosen. 2. Check if O2 sensor is blocked. 3. Don't follow a routine maintenance.

14. K-XCT 125 i FUEL SYSTEM (Auto Control Fuel Injection System)

Maintaining By Checking Component

ECU(Engine Control Unit)

Outlook checking

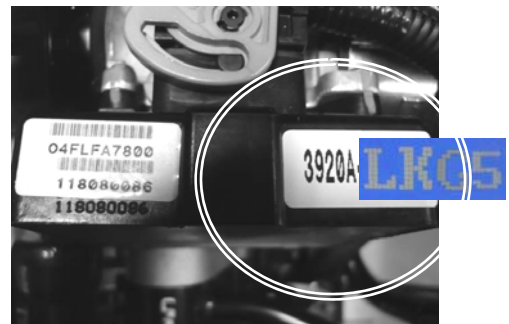
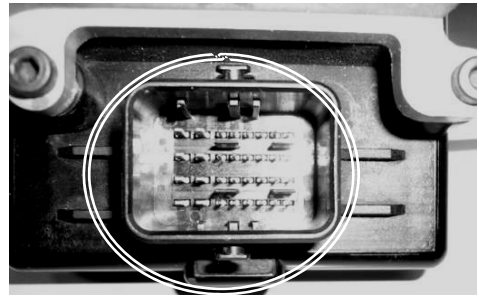

Voltage inspection

Connect the meter (+) probe to the F4(R/W) wire and the meter (-) probe to the H4(G/B) wire to measure the voltage.



MAP content (edition issue no.)



14. K-XCT 125 i FUEL SYSTEM (Auto Control Fuel Injection System)

FUEL PUMP

Connect the meter (+) probe to the red/black wire and the meter (-) probe to the green wire to measure the voltage from the ECU input to fuel pump unit.

Standard : 8~16 V (Battery volt)

Measure the resistance of the fuel pump to see if it is short circuit or not.

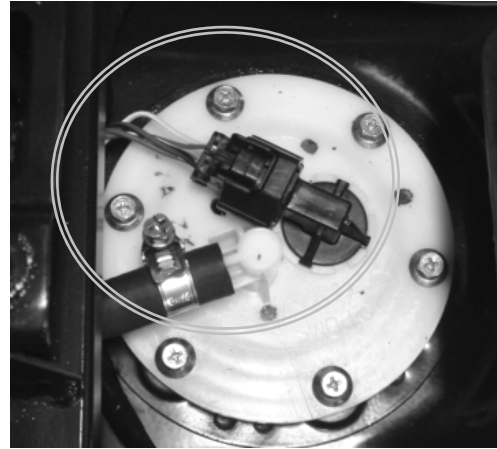

14. K-XCT 125i FUEL SYSTEM (Auto Control Fuel Injection System)

T-MAP(Manifold Air Temperature Pressure) Sensor

Connect the PDA or KYMCO Fi diagnostic tool.
Into the Data Analyze item .

Check if the manifold pressure data is malfunction.

(Key switch ON but engine is not start)

If data was incorrect.

It is possible T-map sensor is not normal.

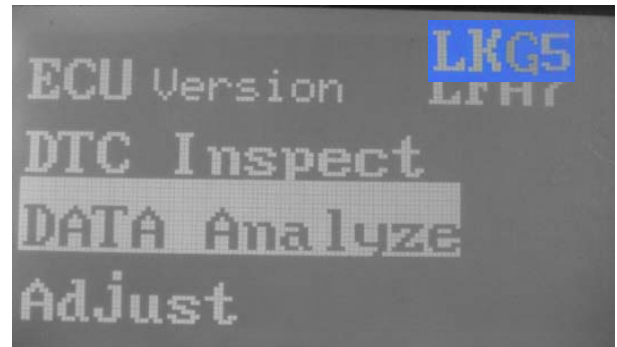

Standard : 101.3 ±3 kpa(see level)

The ambient pressure drop about 12Kpa at the altitude every raised.

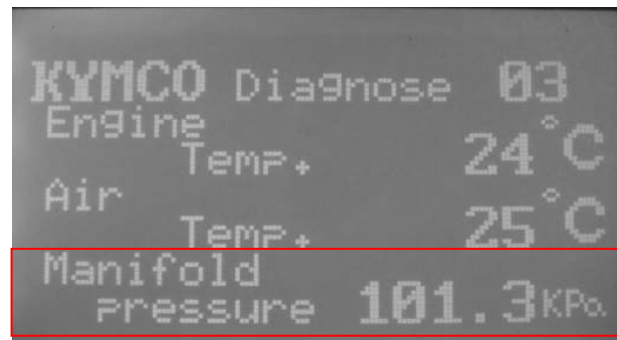

TPS(Throttle Position Sensor)

Connect the PDA or KYMCO Fi diagnostic tool.
Into the Data Analyze item .

Check if the TPS position data is malfunction.

(Key switch ON but engine is not start)

If data was incorrect.(Idle and throttle fully)

It is possible TPS is not normal.

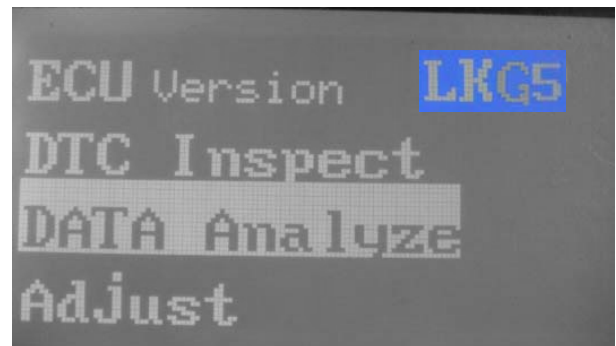

Standard :Idle ~0 ° voltage~0.23V ±0.05

Throttle fully~90°over

voltage~3.27V over

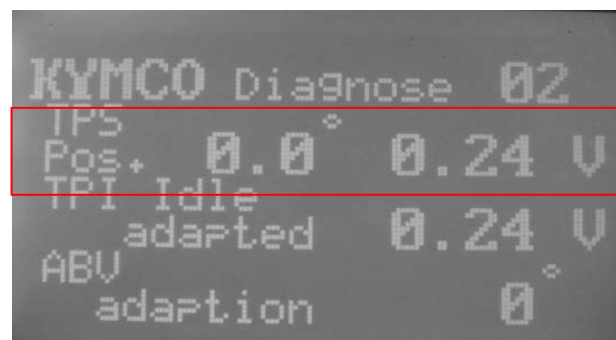

14. K-XCT 125 i FUEL SYSTEM (Auto Control Fuel Injection System)

WTS (Water Temperature Sensor)

Connect the meter (+) probe to the V/G wire and the meter (-) probe to the G/L wire to measure the voltage

Standard : 5 ± 0.25 V

Measure the resistance of the WTS

Standard (20°C/68°F) : $2.075 \pm 10\%$ k Ω



INJECTOR

Measure the resistance of the Injector

Standard (20°C/68°F) : 10.6~15.9 Ω



14. K-XCT 125 i FUEL SYSTEM (Auto Control Fuel Injection System)

O2 SENSOR

Measure the resistance of the O2 sensor heater.
(2 white wire pin)

Standard (20°C/68°F): 6.7 ~9.5Ω



Connect the PDA or KYMCO Fi diagnostic tool.
Into the Data Analyze item .

Check Page 05

(Key switch ON then start engine until O2
heater activation is ON)

If data was incorrect.

It is possible O2 sensor is not normal

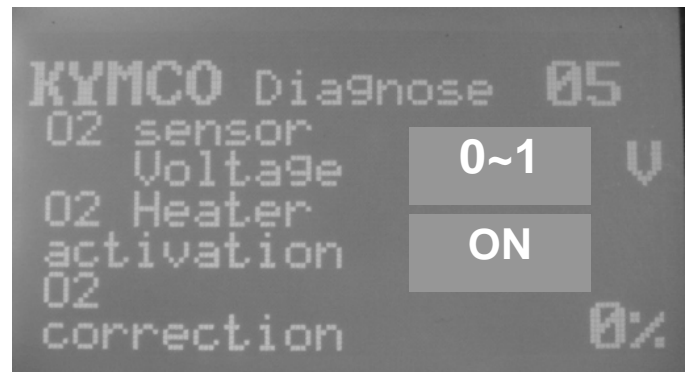

14. K-XCT 125 i FUEL SYSTEM (Auto Control Fuel Injection System)

ROLL SENSOR

The engine should be stall when the vehicle incline over 65° for safety. When you place the vehicle back to normal situation, you have to key-off and key-on the switch, then it can be restarted.

Standard: Normal: 0.4~1.4V

OVER 65°: 3.7~4.4 V

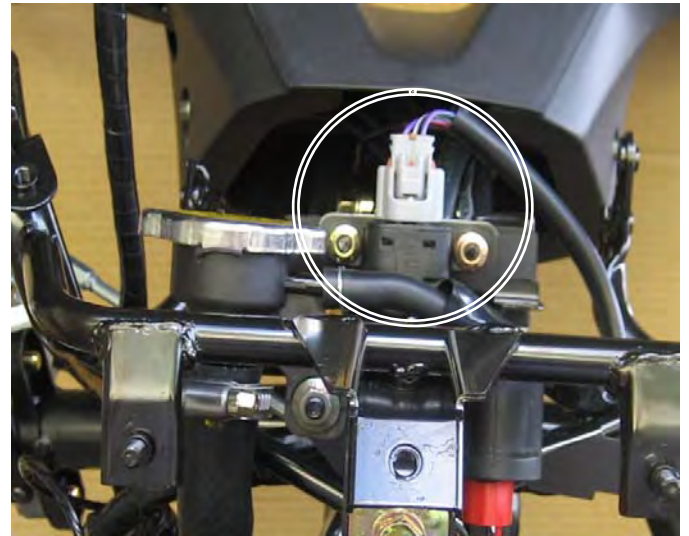

Maintaining Special Notice

Never adjust those two TP screws, those were adjusted to be the best condition by KYMCO, if change this condition it may cause instable riding.

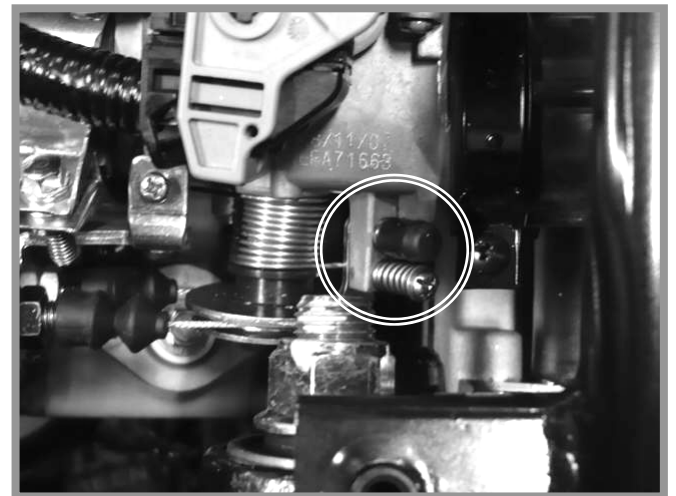

TP screws

14. K-XCT 125i FUEL SYSTEM (Auto Control Fuel Injection System)

Connect the PDA or KYMCO Fi diagnostic tool.
Into the Data Analyze item .

Check if the ignition advance data is malfunction.

(Key switch is ON then start engine until 80 ° C)

If data was over **20 °**

you can adjustment the air bypass adjustment screw 1~1.5 circle.(counterclockwise)

Don't adjust the air bypass adjustment screw over 1.5 circle.

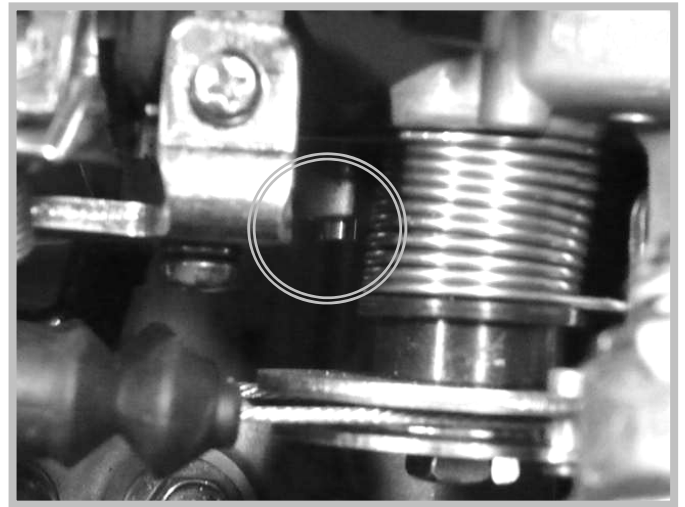
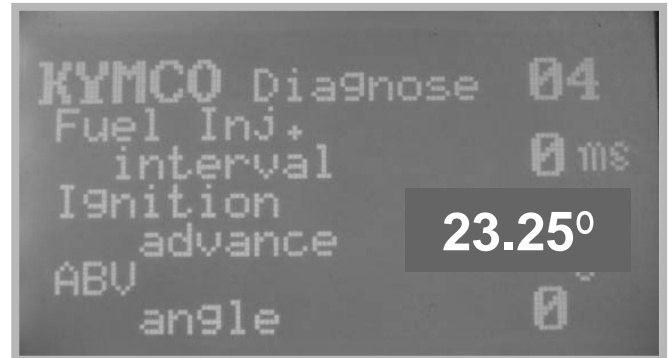

14. K-XCT 125 i FUEL SYSTEM (Auto Control Fuel Injection System)

KYMCO Diagnostic Report
LKG5
SF :
Customer :
Eng. No:
Production
Service
Mileage :
Date :
Date :

Reason of repair: maintenance breakdown

Item		Date	Reference	Memo
ECU Version	ECU No		---	
	Hardware Ver		---	
	Software Ver		QK0A00	
	Calibration Ver		---	
	Model Name		KYMCO-LKG5	
DTC	Active			
	Occurred			
	History			
Engine) Engine Stop (Cool)	DTC Number			
	Throttle Position(%)		0%	Full Throttle: >90%
	Throttle Position Voltage (V)		0.23±0.05 V	Full Throttle Voltage: >3.27V
	Throttle Idle Learning (V)		0.23±0.05 V	
	Engine Temp.(°C)		environ.temp ± 2 °C	
	Atom. Pressure(Kpa)		101.3 ± 3 kPa	
	Battery Voltage(V)		>12 V	
	Roll Sensor State		0.4 ~ 1.44V(stand)	3.7 ~ 4.4V (Fall down)
CO Set		0	Original Setting: 0	
Hot Engine) Before Repair	Engine speed (rpm)		1850 ± 100 rpm	
	Intake Pressure(Kpa)		48~60 kpa	
	Engine Temp.(°C)		environ.temp ± 2 °C	
	Fuel Inject Interval(ms)		1.6 ~ 2.7 ms	
	Ignition Timing (°)		5 ~ 17 BTDC	
	Charging Interval(ms) during ignitin		1.9 ~ 2.6 ms	
	O2 Sensor Voltage(V)		0~1 V	
	O2 Sensor Heater Performance		ON	
	O2 correction rate		± 20%	
	ABV Opening Angle		< 80°	Air screw can be adjusted 1/4-1/2 turn if over 80°
			< 140°	Clean the throttle body if over 140°
IDLE CO(%)		0.4~1.2%	When engine working temperature is 80-90°C	
Hot Engine) After Repair	Engine speed (rpm)		1850 ± 100 rpm	
	Intake Pressure(Kpa)		48~60 kpa	
	Engine Temp.(°C)		environ.temp ± 2 °C	
	Fuel Inject Interval(ms)		1.6 ~ 2.7 ms	
	Ignition Timing (°)		5 ~ 17 BTDC	
	Charging Interval(ms) during ignitin		1.9 ~ 2.6 ms	
	O2 Sensor Voltage(V)		0~1 V	
	O2 Sensor Heater Performance		ON	
	O2 correction rate		± 20%	
	ABV Opening Angle		< 80°	Air screw can be adjusted 1/4-1/2 turn if over 80°
			< 140°	Clean the throttle body if over 140°
IDLE CO(%)		0.4~1.2%	When engine working temperature is 80-90°C	
Repair description		Repair Process		

Report ID=

**HANDLEBAR/FRONT WHEEL/FRONT BRAKE/
FRONT SHOCK ABSORBER/STEERING STEM**

SERVICE INFORMATION-----	15- 2
TROUBLESHOOTING-----	15- 3
Steering Stem Removal -----	15- 4
Steering Stem Installation-----	15-11
Handlebar -----	15-17
Front Fork Removal and Installation -----	15-28
Fork Disassembly -----	15-34
Fork Assembly -----	15-46
Front Wheel-----	15-54
Rear Wheel-----	15-60
Wheel Inspection-----	15-70
Wheel Bearing Replacement -----	15-71

SERVICE INFORMATION

GENERAL INSTRUCTIONS

- Remove the motorcycle frame covers before removing the front wheel, steering handlebar, front shock absorber and front fork. Jack the motorcycle front wheel off the ground and be careful to prevent the motorcycle from falling down.
- During servicing, keep oil or grease off the brake pads and brake disk.

SPECIFICATIONS

Unit: mm

Item	Standard
Brake disk thickness	3.9~4.1 (0.156~0.164)
Brake disk runout	—
Brake master cylinder I.D.	12.7~12.74 (0.508~0.5096)
Brake master cylinder piston O.D.	12.65~12.68 (0.506~0.5072)
Brake caliper piston O.D.	26.93~26.96 (1.077~1.0784)
Brake caliper cylinder I.D.	27~27.05 (1.08~1.082)

TORQUE VALUES

Handlebar lock nut	45 N•m (4.5 kgf•m,)
Steering stem lock nut	63 N•m (6.3 kgf•m,)
Steering stem pinch bolt	27 N•m (2.7 kgf•m)
Front axle	20 N•m (2.0 kgf•m,)
Master cylinder reservoir cover screw	1.6N•m (0.16 kgf•m)
Master cylinder holder bolt	12 N•m (1.2 kgf•m)
Brake lever pivot bolt	2 N•m (0.2 kgf•m)
Brake lever pivot nut	10 N•m (1 kgf•m,)
Brake light switch screw	1 N•m (0.1 kgf•m,)
Brake caliper mounting bolt	35 N•m (3.5 kgf•m,)
	ALOC bolt: replace with a new one.
Brake caliper bleed screw	5.5N•m (0.55 kgf•m)
Brake hose oil bolt	35 N•m (3.5 kgf•m)

TROUBLESHOOTING

Hard steering (heavy)

- Excessively tightened steering stem top cone race
- Broken steering balls
- Insufficient tire pressure

Steers to one side or does not track straight

- Uneven front shock absorbers
- Bent front fork
- Bent front axle or uneven tire

Poor brake performance

- Worn brake pads
- Contaminated brake pad surface
- Deformed brake disk
- Air in brake system
- Deteriorated brake fluid
- Worn brake master cylinder piston oil seal
- Clogged brake fluid line
- Unevenly worn brake caliper

Front wheel wobbling

- Bent rim
- Loose front axle
- Bent spoke plate
- Faulty tire
- Improperly tightened axle nut

Soft front shock absorber

- Weak shock springs
- Insufficient damper oil

Front shock absorber noise

- Slider bending
- Loose fork fasteners
- Lack of lubrication

Steering Stem Removal

SAFETY FIRST: Protective gloves and eyewear are recommended at this point.

Support the vehicle with a suitable stand or jack so that the front wheel is off the ground. Grip the bottom of the fork legs and turn the front end side-to-side. If the movement is rough the bearings should be greased or replaced. If the movement is too tight or loose the steering stem adjusting nut may need to be adjusted.

The KYMCO K-XCT 300i uses ball bearings in the steering. Always replace the races at the same time as the bearings.

15.HANDLEBAR/FRONT WHEEL/FRONT BRAKE/ FRONT SHOCK ABSORBER/STEERING STEM



A special lock nut wrench is needed to loosen the steering stem lock nut.

Special Tool - Lock Nut Wrench: A120F00002



15. HANDLEBAR/FRONT WHEEL/FRONT BRAKE/ FRONT SHOCK ABSORBER/STEERING STEM



Slide the special tool over the steering stem and loosen the lock nut.
Remove the steering stem lock nut.

Slide off the lock washer.



Support the steering stem and loosen the steering stem adjusting nut
with a pin spanner.

15. HANDLEBAR/FRONT WHEEL/FRONT BRAKE/ FRONT SHOCK ABSORBER/STEERING STEM



Remove the steering stem adjusting nut.

Remove the dust cover and grease seal.



Lower the steering stem out of the frame.

15. HANDLEBAR/FRONT WHEEL/FRONT BRAKE/ FRONT SHOCK ABSORBER/STEERING STEM



Remove the upper bearing inner race.
Lift out the upper ball bearings.



Slide the lower ball bearings up and off of the steering stem.

Inspect the bearings and races for wear and damage. Replace them as needed.

15. HANDLEBAR/FRONT WHEEL/FRONT BRAKE/ FRONT SHOCK ABSORBER/STEERING STEM



Use a chisel to remove the bottom bearing inner race and dust seal. Do not damage the steering stem.



Use the special tools or a drift and hammer to drive out the bearing races in the steering head.

15.HANDLEBAR/FRONT WHEEL/FRONT BRAKE/ FRONT SHOCK ABSORBER/STEERING STEM



Have the drift set against the lip of the race, and work around the race evenly to drive it out. Repeat the process with the remaining bearing race.

Steering Stem Installation

SAFETY FIRST: Protective gloves and eyewear are recommended at this point.



Coat the new dust seal in grease and slide it down the steering stem. Drive the new lower bearing inner race onto the steering stem with a pipe with the same outside diameter as the bearing race.



Drive the new bearing races into the steering head with a suitable driver with the same outside diameter as the bearing race.

15. HANDLEBAR/FRONT WHEEL/FRONT BRAKE/ FRONT SHOCK ABSORBER/STEERING STEM



Lubricate the upper bearing with grease and set it into place.



Lubricate the new lower bearing with grease and place it on the steering stem.

15.HANDLEBAR/FRONT WHEEL/FRONT BRAKE/ FRONT SHOCK ABSORBER/STEERING STEM



Set the upper bearing inner race into the upper bearing.



Guide the steering stem into the steering head of the frame.

15.HANDLEBAR/FRONT WHEEL/FRONT BRAKE/ FRONT SHOCK ABSORBER/STEERING STEM



Lubricate the grease seal with grease. Set the grease seal and dust cover into place over the steering stem.



Thread on the steering stem adjusting nut.

15. HANDLEBAR/FRONT WHEEL/FRONT BRAKE/ FRONT SHOCK ABSORBER/STEERING STEM



Tighten the steering stem adjusting nut. Turn the steering stem lock-to-lock several times to seat the bearings.

Loosen the adjusting nut 1/4 to 1/2 half turn. Adjust the nut so the steering moves correctly. The adjusting nut should be tight enough so that the steering doesn't flop back and forth and vertical movement is eliminated. However, it should not be so tight as to cause binding or require excessive force to turn.



Slide the lock washer onto the steering stem as shown.

15.HANDLEBAR/FRONT WHEEL/FRONT BRAKE/ FRONT SHOCK ABSORBER/STEERING STEM



Thread the steering stem lock nut onto the steering stem.



Torque the steering stem lock nut to specification with the lock nut wrench special tool.

Item	Qty	Thread size (mm)	Torque	
			kgf-m	lb-ft
Steering Stem lock nut	1	BC1	6.0-8.0	43.40-57.86

Special Tool - Lock Nut Wrench: A120F00002

15. HANDLEBAR/FRONT WHEEL/FRONT BRAKE/ FRONT SHOCK ABSORBER/STEERING STEM

Handlebar

SAFETY FIRST: Protective gloves and eyewear are recommended at this point.

Removal

Bar Ends



Remove the bar ends with a 6 mm Allen.

To remove the brake master cylinders see the [Brake Master Cylinder](#) topic.

Switch Housings and Throttle



Remove the two right switch housing mounting screws with a #2 Phillips screwdriver. Disconnect the switch.

15. HANDLEBAR/FRONT WHEEL/FRONT BRAKE/ FRONT SHOCK ABSORBER/STEERING STEM



Separate the switch housing from the handlebar.



Disconnect the throttle cables and free the right switch housing from the handlebar.



Slide off the throttle grip.

15. HANDLEBAR/FRONT WHEEL/FRONT BRAKE/ FRONT SHOCK ABSORBER/STEERING STEM



Remove the two left switch housing mounting screws with a #2 Phillips screwdriver.



Disconnect the switch. Separate the left switch housing from the handlebar.

15. HANDLEBAR/FRONT WHEEL/FRONT BRAKE/ FRONT SHOCK ABSORBER/STEERING STEM

Handlebar



Route the cables and lines from the handlebar cable guide.



Hold the handlebar lock bolt with a 14 mm wrench and loosen the nut with a 17 mm socket.

15.]

Remove the handlebar.



Remove the handlebar lock nut and bolt.



Remove the handlebar.

15. HANDLEBAR/FRONT WHEEL/FRONT BRAKE/ FRONT SHOCK ABSORBER/STEERING STEM

Grips



If you plan to replace the grips you can slice them lengthwise with a razor blade and peel them off. To remove the grips without cutting them use a screwdriver to open a gap between the grip and the handlebar.

Spray in contact cleaner to break up the grip cement. Use compressed air to expand the grip so it can be easily slid off the end of the handlebar. Note the relationship between the angle of the grip and the throttle tube so that the new grip can be installed with the correct angle.

NOTE: Always wear safety glasses when using compressed air and never point it directly at yourself or anyone else.

Before installing the grips to either the throttle tube or the handlebar, wipe down the area with a brake or parts cleaner that will dry without leaving a residue. When you are sure the area is dry apply grip cement to the bar or tube. Install the left grip at an angle of your preference. Install the throttle grip onto the tube with the same angle as the original grip.

15.HANDLEBAR/FRONT WHEEL/FRONT BRAKE/ FRONT SHOCK ABSORBER/STEERING STEM

Installation

Handlebar



Install the handlebar onto the steering stem and align the holes.



Install the handlebar lock bolt and thread on the nut.

15. HANDLEBAR/FRONT WHEEL/FRONT BRAKE/ FRONT SHOCK ABSORBER/STEERING STEM



Hold the handlebar lock bolt with a 14 mm wrench and tighten the nut to specification with a 17 mm socket.

Item	torque	
	N-m	lb-ft
Handlebar Lock Nut	45	32



Route the cables and lines through the handlebar cable guide.

Switch Housings and Throttle



Align the left switch housing and install on the handlebar.



Insert the two housing screws and tighten them securely with a #2 Phillips screwdriver. Connect the switch.

15. HANDLEBAR/FRONT WHEEL/FRONT BRAKE/ FRONT SHOCK ABSORBER/STEERING STEM



Slide the throttle grip onto the right side of the handlebar.



Install the right switch and throttle housing. The post on the housing should fit into the hole in the bar.



Lubricate the end of the throttle in grease. Fit the ends of the throttle cables into the throttle tube.

15.HANDLEBAR/FRONT WHEEL/FRONT BRAKE/ FRONT SHOCK ABSORBER/STEERING STEM



Insert the two housing screws and tighten them securely with a #2 Phillips screwdriver. Tighten the front bolt before the rear.

Bar Ends



Install the bar ends with a 6 mm Allen.

Front Fork Removal and Installation

SAFETY FIRST: Protective gloves and eyewear are recommended at this point.

Removal



Remove the front wheel speed sensor mounting bolt with an 8 mm socket.

**15.HANDLEBAR/FRONT WHEEL/FRONT BRAKE/
FRONT SHOCK ABSORBER/STEERING STEM**



Remove the front wheel speed sensor from the bottom of the right fork leg.



15. HANDLEBAR/FRONT WHEEL/FRONT BRAKE/ FRONT SHOCK ABSORBER/STEERING STEM



Remove the speed sensor wire and front brake hose guide mounting bolt with an 8 mm socket. Free the guide from the fork clamp.



Loosen the fork clamp pinch bolts with a 12 mm socket. The top bolts must be removed.

15.HANDLEBAR/FRONT WHEEL/FRONT BRAKE/ FRONT SHOCK ABSORBER/STEERING STEM



Slide the forks legs down and out of the fork clamp using a twisting motion.

Installation



Slide the fork legs up into fork clamp using a twisting motion.

15. HANDLEBAR/FRONT WHEEL/FRONT BRAKE/ FRONT SHOCK ABSORBER/STEERING STEM



Install the fork legs so that the upper fork clamp bolt hole lines up with the groove on the inner fork tube. Insert the fork clamp upper bolt.



Tighten the fork clamp bolts securely and evenly with a 12 mm socket.



Install the speed sensor wire and front brake hose guide to the fork clamp. Insert the guide mounting bolt and tighten it to specification with an 8 mm socket.

15.HANDLEBAR/FRONT WHEEL/FRONT BRAKE/ FRONT SHOCK ABSORBER/STEERING STEM

Item	Qty	Thread size (mm)	Torque	
			kgf-m	lb-ft
Speed sensor cable	1	6	1.0-1.4	7.23-10.13



Fit the front wheel speed sensor into place on the right fork leg.
Insert the bolt and tighten it to specification with an 8 mm socket.

Fork Disassembly

SAFETY FIRST: Protective gloves and eyewear are recommended at this point.

Remove the front forks. See the Front Fork Removal and Installation topic for more information.



Clean the outside of the forks before disassembly and inspect them for any cracks, dents or other damage.



Slide off the fork protectors.

**15.HANDLEBAR/FRONT WHEEL/FRONT BRAKE/
FRONT SHOCK ABSORBER/STEERING STEM**



Remove the rubber fork cap.



Place the fork leg in a soft jawed vice.

15. HANDLEBAR/FRONT WHEEL/FRONT BRAKE/ FRONT SHOCK ABSORBER/STEERING STEM



Push down on the top plug and remove the snap ring.



Remove the top plug.

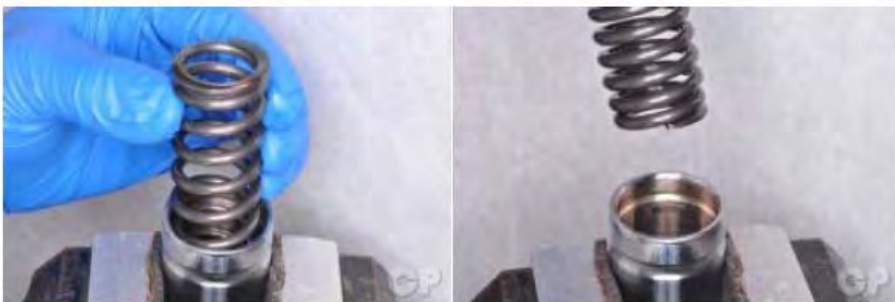

Lift out the fork spring.

15. HANDLEBAR/FRONT WHEEL/FRONT BRAKE/ FRONT SHOCK ABSORBER/STEERING STEM



Dump the fork oil into a suitable container. Pump the fork through its stroke several times to free as much oil as possible. Hold the fork inverted for several minutes to let the oil drain completely.



Use a flat blade screwdriver to pop the dust seal out of the fork slider. Take care to avoid scratching the fork tube.

15. HANDLEBAR/FRONT WHEEL/FRONT BRAKE/ FRONT SHOCK ABSORBER/STEERING STEM



Use a small flat blade screwdriver to pry out the fork oil seal stopper ring. Take care to avoid scratching the fork tube.



Slide off the stopper ring.

15. HANDLEBAR/FRONT WHEEL/FRONT BRAKE/ FRONT SHOCK ABSORBER/STEERING STEM



Place the axle holder of the outer fork tube in a soft jawed.



Insert an 8 mm Allen socket into the damper rod. Hold the damper rod and loosen the fork bottom bolt with an 8 mm Allen wrench.

15. HANDLEBAR/FRONT WHEEL/FRONT BRAKE/ FRONT SHOCK ABSORBER/STEERING STEM



Remove the fork bottom bolt from the bottom of the fork slider. Discard the sealing washer.



Separate the inner and outer fork tubes by pulling them apart using a slide hammer motion.



Remove the oil lock piece. The oil lock piece may come out with the damper rod in the inner fork tube or it may be left in the slider.

15.HANDLEBAR/FRONT WHEEL/FRONT BRAKE/ FRONT SHOCK ABSORBER/STEERING STEM



Remove the damper rod and rebound spring.



Inspect the oil seal and the bushing in the fork slider.

15. HANDLEBAR/FRONT WHEEL/FRONT BRAKE/ FRONT SHOCK ABSORBER/STEERING STEM



Place a rag across the top of the fork slider and pry out the oil seal as shown.



Remove the oil seal and spacer from the fork slider.

Inspection



Inspect the top plug O-ring O-ring and replace it if needed.



Inspect the slider bushing and replace it as needed.

15. HANDLEBAR/FRONT WHEEL/FRONT BRAKE/ FRONT SHOCK ABSORBER/STEERING STEM



Inspect the fork springs for signs of fatigue. Replace the fork springs if they vary dramatically in length.



Inspect the damper rod and seal. Replace the components as needed.

15.HANDLEBAR/FRONT WHEEL/FRONT BRAKE/ FRONT SHOCK ABSORBER/STEERING STEM

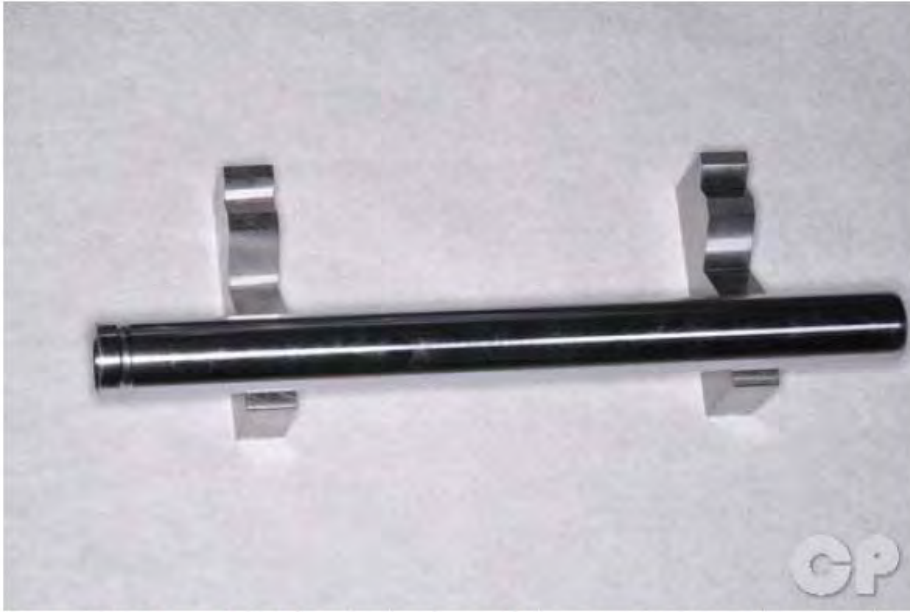

Inspect the inner fork tube for bends and damage. Replace it as needed.

For assembly see the Fork Assembly topic.

Fork Assembly

SAFETY FIRST: Protective gloves and eyewear are recommended at this point.

Clean all of the fork components with aerosol brake cleaner and a lint free cloth. Coat the bushing and seals with fork oil before installation.



Drive the fork slider bushing into the slider with a suitable driver with the same outside diameter as the bushing.



Insert the damper rod with rebound spring into the inner fork tube. Place the fork oil lock piece on the end of the damper rod.

Slide the dust seal, oil seal stopper ring and oil seal onto the bottom of the inner fork tube.

**15.HANDLEBAR/FRONT WHEEL/FRONT BRAKE/
FRONT SHOCK ABSORBER/STEERING STEM**

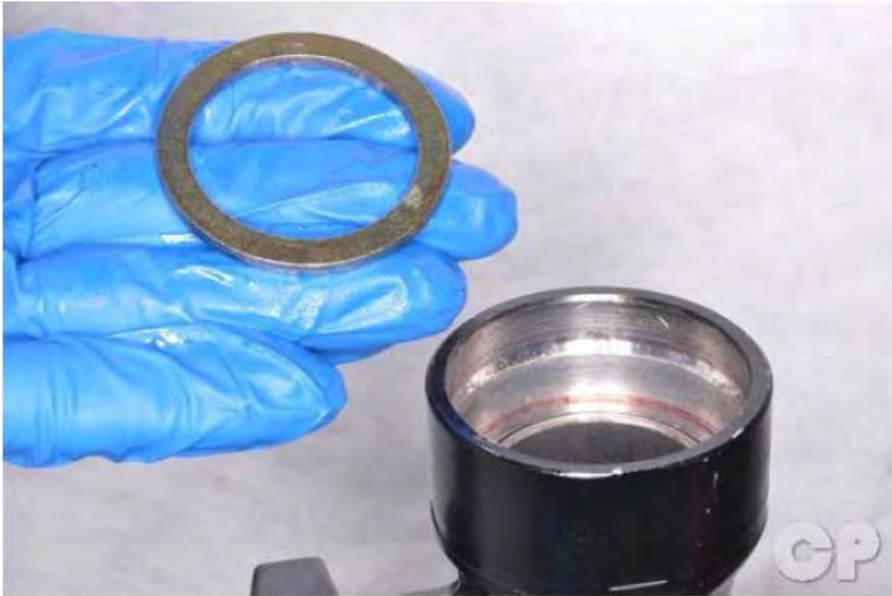

Place the spacer into the fork slider.



Insert the inner fork tube into the inner fork tube.

15. HANDLEBAR/FRONT WHEEL/FRONT BRAKE/ FRONT SHOCK ABSORBER/STEERING STEM



Place a new sealing washer on the fork bottom bolt. Insert the fork bottom bolt into the bottom the fork slider and thread it into the damper rod.



Place the axle holder of the outer fork tube in a soft jawed.

15. HANDLEBAR/FRONT WHEEL/FRONT BRAKE/ FRONT SHOCK ABSORBER/STEERING STEM



Insert an 8 mm Allen socket into the damper rod. Hold the damper rod and tighten the fork bottom bolt securely with an 8 mm Allen wrench.



Drive in the fork oil seal with the fork seal driver.

**15.HANDLEBAR/FRONT WHEEL/FRONT BRAKE/
FRONT SHOCK ABSORBER/STEERING STEM**



Insert the stopper ring into its groove.

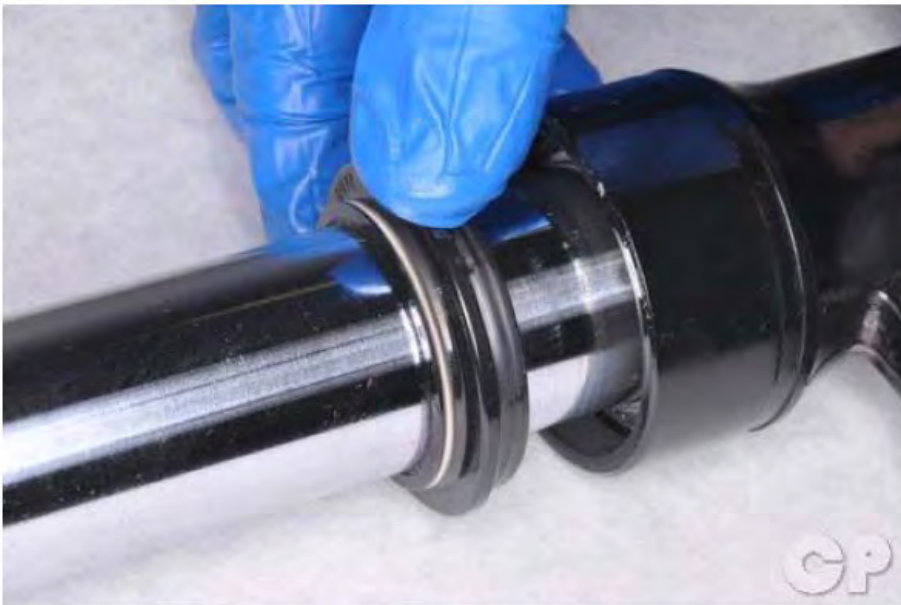

Install the dust seal securely into the outer fork tube.

15. HANDLEBAR/FRONT WHEEL/FRONT BRAKE/ FRONT SHOCK ABSORBER/STEERING STEM

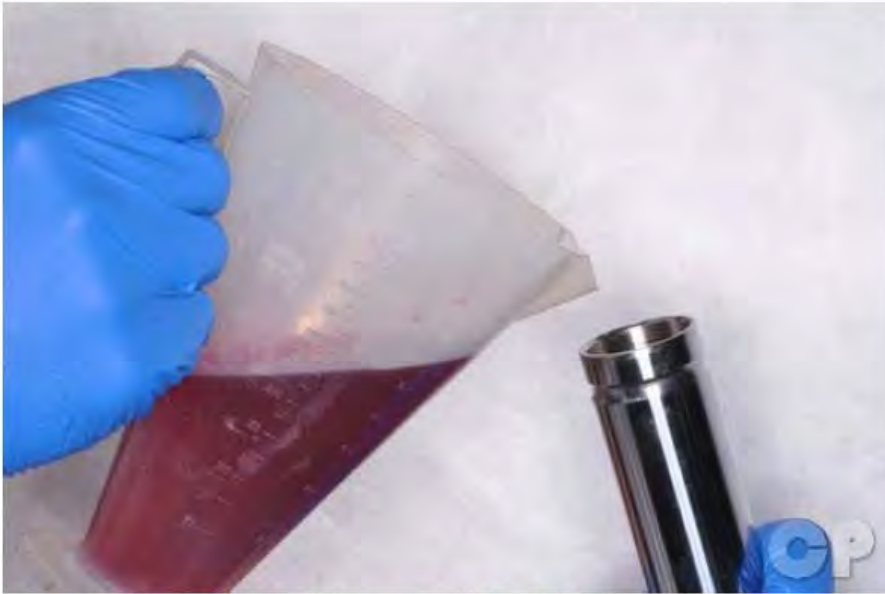

Compress the fork tube all the way. Fill the fork tube with the specified quantity of fork oil 185 cc or 6.26 US oz. Use fork oil type SS#8 (10W).

Pump the fork slowly through its stroke several times to release any trapped air.

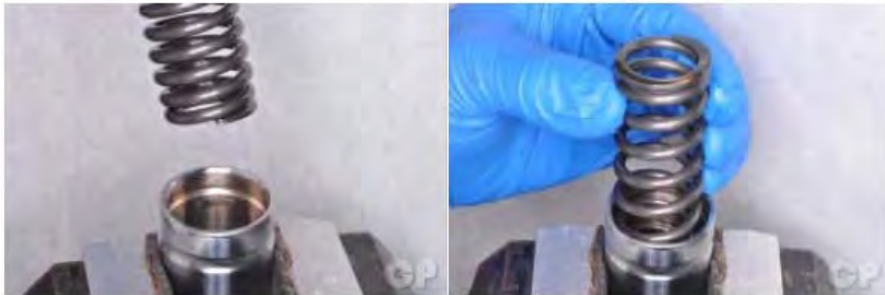

Fully extend the fork and insert the fork spring with its tightly coiled end facing down towards the axle.

15. HANDLEBAR/FRONT WHEEL/FRONT BRAKE/ FRONT SHOCK ABSORBER/STEERING STEM



Lubricate the top plug O-ring with fresh fork oil and insert the plug into the top of the inner fork tube as shown.



Push the top plug down against the spring and install the stopper ring into its groove. Release the pressure on the top plug and make sure the plug seats against the ring.



Install the rubber fork cap.



Fit the fork protectors into place so that they face forward.

Install the front fork. See the Front Fork Removal and Installation topic for more information.

Front Wheel

SAFETY FIRST: Protective gloves and eyewear are recommended at this point.

Removal



Loosen the front axle pinch bolt with a 6 mm Allen.



Loosen the front axle with an 8 mm socket.

15. HANDLEBAR/FRONT WHEEL/FRONT BRAKE/ FRONT SHOCK ABSORBER/STEERING STEM



Lift the front end of the vehicle with a suitable stand or jack so that the front wheel comes off of the ground.



Support the front wheel and slide the front axle out from the left side.

15. HANDLEBAR/FRONT WHEEL/FRONT BRAKE/ FRONT SHOCK ABSORBER/STEERING STEM



Guide the front wheel out from the fork legs and the brake disc out from between the pads. Do not squeeze the brake lever while the disc is not present between the pads.



Remove the collars from each side of the wheel. Inspect the bearing seals and the O-rings seals on the collars. Replace the seals if they are in poor condition.

Inspect the wheel bearings by turning them in the hub. If the bearings have play in them or are rough replace all the bearings for that wheel. See the Bearing Replacement topic for more information.

To remove the wheel speed sensor rotor loosen the three bolts with an

Installation



Apply grease to the lips of the dust seals and collar O-rings. Insert the collars into the hub as shown.



Make sure the tire direction of rotation marker is correct. Slide the front wheel into the fork. Fit the brake disc between the brake pads in the front caliper.



Apply a light coat of grease to the front axle. Insert the axle from the left side.

15.HANDLEBAR/FRONT WHEEL/FRONT BRAKE/ FRONT SHOCK ABSORBER/STEERING STEM

Set the front wheel on the ground. Pump the front suspension up and down several times to seat the front axle



Torque the axle to specification with an 8 mm Allen.

Item	Qty	size (mm)	Torque	
			Kgf-m	lb-ft
Front axle	1	14	1.5-2.5	10.84-18.08



Tighten the front axle pinch bolt securely with a 6 mm Allen.

Pump the front brake lever to establish pressure and to seat the pads against the disc. If the Brakes do not pump up correctly check the brake fluid.

Rear Wheel

SAFETY FIRST: Protective gloves and eyewear are recommended at this point.

- When performing the services stated in this section, the engine and exhaust muffler must be cold to avoid scalding.
- During servicing, keep oil or grease off the brake pads and brake disk.

Removal



Remove the right side rear shock mounting bolt with a 14 mm socket.

15. HANDLEBAR/FRONT WHEEL/FRONT BRAKE/ FRONT SHOCK ABSORBER/STEERING STEM



Move the rear shock out of the way.



Hold the rear brake to keep the rear wheel from turning.
Remove the rear axle nut with a 24 mm socket.



Remove the two rear fork bolts with a 14 mm socket.

15. HANDLEBAR/FRONT WHEEL/FRONT BRAKE/ FRONT SHOCK ABSORBER/STEERING STEM



Slide the rear fork out and remove it from the right side of the vehicle.



Remove the rear axle collar from the right side of the rear axle.

15.HANDLEBAR/FRONT WHEEL/FRONT BRAKE/ FRONT SHOCK ABSORBER/STEERING STEM



To remove the rear wheel support the right rear shock absorber so that it is out of the way or remove it.



Remove the upper shock absorber mounting bolt with a 12 mm socket. Free the right shock absorber from the frame.



Slide the rear wheel to the right and off of the rear axle. Inspect the wheel bearings by turning them with a finger. If the bearings have play in them or are rough replace all the bearings for that wheel.

15.HANDLEBAR/FRONT WHEEL/FRONT BRAKE/ FRONT SHOCK ABSORBER/STEERING STEM

Installation



Line up the splines on the rear wheel with those of the rear axle. Slide the rear wheel on to the axle so that the brake disc sits on the right side.



Install the right shock absorber if it was removed. Install the upper mounting bolt and tighten it to specification with a 12 mm socket.

Item	Torque	
	kgf-m	lb-ft
Shock absorber mounting bolt	4	28.93

**15.HANDLEBAR/FRONT WHEEL/FRONT BRAKE/
FRONT SHOCK ABSORBER/STEERING STEM**



Slide on the rear axle collar.



Fit the rear fork into place.

15. HANDLEBAR/FRONT WHEEL/FRONT BRAKE/ FRONT SHOCK ABSORBER/STEERING STEM



Install the two rear fork mounting bolts and tighten them securely with a 14 mm socket.



15.HANDLEBAR/FRONT WHEEL/FRONT BRAKE/ FRONT SHOCK ABSORBER/STEERING STEM



Install the rear axle nut and tighten it to specification with a 24 mm socket.

Item	Qty	Thread size (mm)	Torque		Remarks
			kgf-m	lb-ft	
Rear axle nut	1	16	11-13	79.56-94.03	U-nut



Fit the shock absorber into place. Make sure the preload arrow indicator faces out from the lower mount.

15.HANDLEBAR/FRONT WHEEL/FRONT BRAKE/ FRONT SHOCK ABSORBER/STEERING STEM



Install the upper shock absorber mounting bolt and torque it to specification with a 12 mm socket.

Item	Torque	
	kgf-m	lb-ft
Shock absorber mounting bolt	4	28.93



15.HANDLEBAR/FRONT WHEEL/FRONT BRAKE/ FRONT SHOCK ABSORBER/STEERING STEM



Install the lower shock absorber mounting bolt and torque it to specification with a 12 mm socket.

Item	Torque	
	kgf-m	lb-ft
Shock absorber mounting bolt	4	28.93

Wheel Inspection

SAFETY FIRST: Protective gloves and eyewear are recommended at this point.

Turn the inner race of each bearing with your finger to see if they turn smoothly and quietly. Also check if the outer race fits tightly in the hub. Replace the bearings if the races do not turn smoothly, quietly, or if they fit loosely in the hub.



Place the wheel on a truing stand and use a dial indicator to check if the rim is out of true. The specifications for the front and rear wheels are the same. Check for lateral wobble. The service limit is 2.0 mm (0.08 in) or less.

Wheel Bearing Replacement

SAFETY FIRST: Protective gloves and eyewear are recommended at this point.

Replace bearings as a set, and do not reuse old bearings.
Place the new bearings in the freezer about an hour before you plan to install them.
Do not let the wheel rest on its brake disc.

Front Wheel



Remove the dust seal from the right side of the front wheel using a seal pick or large flat blade screwdriver. Discard the dust seal, it should be replaced by a new item.



Inspect the wheel bearings by turning them in the hub. If the bearings have excessive play in them or are rough replace all the bearings for that wheel.

15.HANDLEBAR/FRONT WHEEL/FRONT BRAKE/ FRONT SHOCK ABSORBER/STEERING STEM



Remove one of the bearings with a bearing puller.

Special Tools- Bearing Puller: A120E00037



Remove the distance collar.



Repeat the procedure and remove the other bearing and seal. The seal should be replaced with a new item.

15.HANDLEBAR/FRONT WHEEL/FRONT BRAKE/ FRONT SHOCK ABSORBER/STEERING STEM



Heat the bearing area of the wheel with a heat gun, take the bearing out of the freezer and install it. You can use a bearing installer tool or a socket with the same outside diameter as the bearing. Make sure the bearing is fully seated and the marked side is facing out.

Special Tools-Bearing Installer: A120E00014



Insert the distance collar into the hub.

15.HANDLEBAR/FRONT WHEEL/FRONT BRAKE/ FRONT SHOCK ABSORBER/STEERING STEM



Drive in the other bearing. The bearing should fit against the distance collar. Do not continue to force the bearing in or the distance collar will begin to push the right bearing back out.



Apply grease to the lips of the dust seals. Drive in new dust seals.

16. REAR BRAKE/REAR FORK/REAR WHEEL/REAR SHOCK ABSORBER



K-XCT 125i

REAR BRAKE/REAR FORK/REAR WHEEL/ REAR SHOCK ABSORBER

SERVICE INFORMATION-----	16-1
TROUBLESHOOTING-----	16-1
Shock Absorbers -----	16-2
Rear Fork-----	16-10
Front Wheel-----	16-15
Rear Wheel -----	16-22
Wheel Inspection-----	16-32
Wheel Bearing Replacement -----	16-33

16. REAR BRAKE/REAR FORK/REAR WHEEL/REAR SHOCK ABSORBER



K-XCT 125i

SERVICE INFORMATION

GENERAL INSTRUCTIONS

- When performing the services stated in this section, the engine and exhaust muffler must be cold to avoid scalding.
- During servicing, keep oil or grease off the brake pads and brake disk.

SPECIFICATIONS

Item	Standard (mm)
Rear brake disk thickness	4.9~5.1
Rear brake caliper piston O.D.	25.33~25.36
Rear brake caliper cylinder I.D.	25.4~25.45
Rear brake master cylinder I.D.	12.7~12.74
Rear brake master cylinder piston O.D.	12.65~12.68

TORQUE VALUES

Exhaust muffler lock bolt	35 N-m/3.5 kgf-m
Exhaust muffler pipe nut	20 N-m/2 kgf-m
Rear axle nut	120 N-m/12 kgf-m
Rear shock absorber lower mount bolt	40N-m/4 kgf-m
Rear shock absorber upper mount bolt	40N-m/4 kgf-m
Rear brake caliper holder bolt	27 N-m/2.7 kgf-m

TROUBLESHOOTING

Rear wheel wobbling

- Bent rim
- Faulty tire
- Axle not tightened properly

Soft rear shock absorber

- Weak shock absorber spring
- Damper oil leaks

Rear wheel noise

- Worn rear wheel axle bearings
- Worn rear fork bearings
- Deformed rear fork

Poor brake performance

- Air in brake system
- Deteriorated brake fluid
- Contaminated brake pad surface
- Worn brake pads
- Clogged brake fluid line
- Deformed brake disk
- Unequal worn brake caliper

16. REAR BRAKE/REAR FORK/REAR WHEEL/REAR SHOCK ABSORBER

Shock Absorbers

SAFETY FIRST: Protective gloves and eyewear are recommended at this point.

Pre-Load Setting



Each shock absorber on the scooter has 5 spring preload adjustment positions for different load or riding conditions.

Position 1 is for light loads and smooth road conditions. Position 3 to 5 increase spring preload for stiffer rear suspension and can be used when the scooters heavily loaded. Be certain to adjust both shock absorbers to the same spring preload positions.

Use a pin spanner to adjust the rear shock spring preload. The shock absorbers are adjustable for pre-load. There are 5 settings. Position 1 is the softest and 5 is the stiffest.

Caution: Always adjust the shock absorber pre-load position in sequence (1-2-3-4-5 or 5-4-3-2-1). Attempting to adjust directly from 1 to 5 or 5 to 1 may damage the shock absorber.

(Pre-Load Standard Setting: Position 3)

16. REAR BRAKE/REAR FORK/REAR WHEEL/REAR SHOCK ABSORBER

Removal

Place the vehicle on its center stand.

Remove the body cover to access the upper shock absorber mounts. See the Body Cover topic for more information.



Remove the two rear shock mounting bolt with a 12 mm socket.

16. REAR BRAKE/REAR FORK/REAR WHEEL/REAR SHOCK ABSORBER



Remove the right side rear shock mounting bolt with a 14 mm socket.



Free the lower mount of the rear shock.

16. REAR BRAKE/REAR FORK/REAR WHEEL/REAR SHOCK ABSORBER



Remove the upper shock absorber mounting bolt with a 12 mm socket.
Free the shock absorber from the frame.

16. REAR BRAKE/REAR FORK/REAR WHEEL/REAR SHOCK ABSORBER



Remove the left shock absorber in the same manner as the right.

Inspect the shock absorbers for wear and damage. Replace the shock absorbers as needed.

Check over the shock absorber for damage and oil leaks. Replace the shock absorber if needed. Do not attempt to disassemble the shock absorber.

16. REAR BRAKE/REAR FORK/REAR WHEEL/REAR SHOCK ABSORBER

Installation



Fit the shock absorber into place. Make sure the preload arrow indicator faces out from the lower mount.



Install the upper shock absorber mounting bolt and torque it to specification with a 12 mm socket.

16. REAR BRAKE/REAR FORK/REAR WHEEL/REAR SHOCK ABSORBER

Item	Torque	
	kgf-m	lb-ft
Shock absorber mounting bolt	4	28.93



Install the lower shock absorber mounting bolt and torque it to specification with a 12 mm socket.

Item	Torque	
	kgf-m	lb-ft
Shock absorber mounting bolt	4	28.93

16. REAR BRAKE/REAR FORK/REAR WHEEL/REAR SHOCK ABSORBER



Install the other shock absorber in the same manner.

16. REAR BRAKE/REAR FORK/REAR WHEEL/REAR SHOCK ABSORBER

Rear Fork

SAFETY FIRST: Protective gloves and eyewear are recommended at this point.

Removal

Place the vehicle on its center stand.



Remove the right side rear shock mounting bolt with a 14 mm socket.

16. REAR BRAKE/REAR FORK/REAR WHEEL/REAR SHOCK ABSORBER



Hold the rear brake to keep the rear wheel from turning. Remove the rear axle nut with a 24 mm socket.



Remove the two rear fork bolts with a 14 mm socket.



Slide the rear fork out and remove it from the right side of the vehicle.

Inspect the rear fork for damage and replace it as needed.

16. REAR BRAKE/REAR FORK/REAR WHEEL/REAR SHOCK ABSORBER

Installation



Fit the rear fork into place.



Install the two rear fork mounting bolts and tighten them securely with a 14 mm socket.

16. REAR BRAKE/REAR FORK/REAR WHEEL/REAR SHOCK ABSORBER



Install the rear axle nut and tighten it to specification with a 24 mm socket.

Item	Qty	Thread size (mm)	Torque		Remarks
			kgf-m	lb-ft	
Rear axle nut	1	16	11-13	79.56-94.03	U-nut

16. REAR BRAKE/REAR FORK/REAR WHEEL/REAR SHOCK ABSORBER



Install the lower shock absorber mounting bolt and torque it to specification with a 12 mm socket.

Item	Torque	
	kgf-m	lb-ft
Shock absorber mounting bolt	4	28.93

16. REAR BRAKE/REAR FORK/REAR WHEEL/REAR SHOCK ABSORBER

Front Wheel

SAFETY FIRST: Protective gloves and eyewear are recommended at this point.

Removal



Loosen the front axle pinch bolt with a 6 mm Allen.



Loosen the front axle with an 8 mm socket.

16. REAR BRAKE/REAR FORK/REAR WHEEL/REAR SHOCK ABSORBER



Lift the front end of the vehicle with a suitable stand or jack so that the front wheel comes off of the ground.



Support the front wheel and slide the front axle out from the left side.

16. REAR BRAKE/REAR FORK/REAR WHEEL/REAR SHOCK ABSORBER



Guide the front wheel out from the fork legs and the brake disc out from between the pads. Do not squeeze the brake lever while the disc is not present between the pads.



Remove the collars from each side of the wheel. Inspect the bearing seals and the O-rings seals on the collars. Replace the seals if they are in poor condition.

Inspect the wheel bearings by turning them in the hub. If the bearings have play in them or are rough replace all the bearings for that wheel. See the Bearing Replacement topic for more information.

To remove the wheel speed sensor rotor loosen the three bolts with an

16. REAR BRAKE/REAR FORK/REAR WHEEL/REAR SHOCK ABSORBER

Installation



Apply grease to the lips of the dust seals and collar O-rings. Insert the collars into the hub as shown.



Make sure the tire direction of rotation marker is correct. Slide the front wheel into the fork. Fit the brake disc between the brake pads in the front caliper.



Apply a light coat of grease to the front axle. Insert the axle from the left side.

16. REAR BRAKE/REAR FORK/REAR WHEEL/REAR SHOCK ABSORBER

Set the front wheel on the ground. Pump the front suspension up and down several times to seat the front axle



Torque the axle to specification with an 8 mm Allen.

Item	Qty	size (mm)	Torque	
			Kgf-m	lb-ft
Front axle	1	14	1.5-2.5	10.84-18.08

16. REAR BRAKE/REAR FORK/REAR WHEEL/REAR SHOCK ABSORBER



Tighten the front axle pinch bolt securely with a 6 mm Allen.

Pump the front brake lever to establish pressure and to seat the pads against the disc. If the Brakes do not pump up correctly check the brake fluid.

16. REAR BRAKE/REAR FORK/REAR WHEEL/REAR SHOCK ABSORBER

Rear Wheel

SAFETY FIRST: Protective gloves and eyewear are recommended at this point.

- When performing the services stated in this section, the engine and exhaust muffler must be cold to avoid scalding.
- During servicing, keep oil or grease off the brake pads and brake disk.

Removal

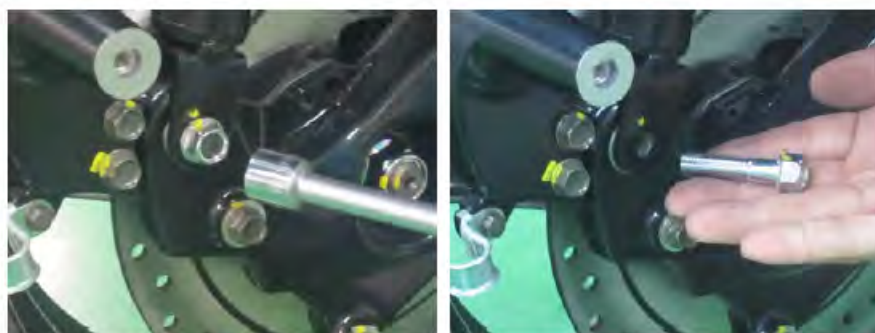

Remove the right side rear shock mounting bolt with a 14 mm socket.

16. REAR BRAKE/REAR FORK/REAR WHEEL/REAR SHOCK ABSORBER



Move the rear shock out of the way.



Hold the rear brake to keep the rear wheel from turning.
Remove the rear axle nut with a 24 mm socket.



Remove the two rear fork bolts with a 14 mm socket.

16. REAR BRAKE/REAR FORK/REAR WHEEL/REAR SHOCK ABSORBER



Slide the rear fork out and remove it from the right side of the vehicle.



Remove the rear axle collar from the right side of the rear axle.

16. REAR BRAKE/REAR FORK/REAR WHEEL/REAR SHOCK ABSORBER



To remove the rear wheel support the right rear shock absorber so that it is out of the way or remove it.



Remove the upper shock absorber mounting bolt with a 12 mm socket. Free the right shock absorber from the frame.



Slide the rear wheel to the right and off of the rear axle. Inspect the wheel bearings by turning them with a finger. If the bearings have play in them or are rough replace all the bearings for that wheel.

16. REAR BRAKE/REAR FORK/REAR WHEEL/REAR SHOCK ABSORBER

Installation



Line up the splines on the rear wheel with those of the rear axle. Slide the rear wheel on to the axle so that the brake disc sits on the right side.



Install the right shock absorber if it was removed. Install the upper mounting bolt and tighten it to specification with a 12 mm socket.

Item	Torque	
	kgf-m	lb-ft
Shock absorber mounting bolt	4	28.93

16. REAR BRAKE/REAR FORK/REAR WHEEL/REAR SHOCK ABSORBER



Slide on the rear axle collar.



Fit the rear fork into place.

16. REAR BRAKE/REAR FORK/REAR WHEEL/REAR SHOCK ABSORBER



Install the two rear fork mounting bolts and tighten them securely with a 14 mm socket.



16. REAR BRAKE/REAR FORK/REAR WHEEL/REAR SHOCK ABSORBER



Install the rear axle nut and tighten it to specification with a 24 mm socket.

Item	Qty	Thread size (mm)	Torque		Remarks
			kgf-m	lb-ft	
Rear axle nut	1	16	11-13	79.56-94.03	U-nut



Fit the shock absorber into place. Make sure the preload arrow indicator faces out from the lower mount.

16. REAR BRAKE/REAR FORK/REAR WHEEL/REAR SHOCK ABSORBER



Install the upper shock absorber mounting bolt and torque it to specification with a 12 mm socket.

Item	Torque	
	kgf-m	lb-ft
Shock absorber mounting bolt	4	28.93



16. REAR BRAKE/REAR FORK/REAR WHEEL/REAR SHOCK ABSORBER



Install the lower shock absorber mounting bolt and torque it to specification with a 12 mm socket.

Item	Torque	
	kgf-m	lb-ft
Shock absorber mounting bolt	4	28.93

16. REAR BRAKE/REAR FORK/REAR WHEEL/REAR SHOCK ABSORBER

Wheel Inspection

SAFETY FIRST: Protective gloves and eyewear are recommended at this point.

Turn the inner race of each bearing with your finger to see if they turn smoothly and quietly. Also check if the outer race fits tightly in the hub. Replace the bearings if the races do not turn smoothly, quietly, or if they fit loosely in the hub.



Place the wheel on a truing stand and use a dial indicator to check if the rim is out of true. The specifications for the front and rear wheels are the same. Check for lateral wobble. The service limit is 2.0 mm (0.08 in) or less.

16. REAR BRAKE/REAR FORK/REAR WHEEL/REAR SHOCK ABSORBER

Wheel Bearing Replacement

SAFETY FIRST: Protective gloves and eyewear are recommended at this point.

Replace bearings as a set, and do not reuse old bearings.

Place the new bearings in the freezer about an hour before you plan to install them.

Do not let the wheel rest on its brake disc.

Front Wheel



Remove the dust seal from the right side of the front wheel using a seal pick or large flat blade screwdriver. Discard the dust seal, it should be replaced by a new item.



Inspect the wheel bearings by turning them in the hub. If the bearings have excessive play in them or are rough replace all the bearings for that wheel.

16. REAR BRAKE/REAR FORK/REAR WHEEL/REAR SHOCK ABSORBER



Remove one of the bearings with a bearing puller.

Special Tools- Bearing Puller: A120E00037



Remove the distance collar.



Repeat the procedure and remove the other bearing and seal. The seal should be replaced with a new item.

16. REAR BRAKE/REAR FORK/REAR WHEEL/REAR SHOCK ABSORBER



Heat the bearing area of the wheel with a heat gun, take the bearing out of the freezer and install it. You can use a bearing installer tool or a socket with the same outside diameter as the bearing. Make sure the bearing is fully seated and the marked side is facing out.

Special Tools-Bearing Installer: A120E00014



Insert the distance collar into the hub.

16. REAR BRAKE/REAR FORK/REAR WHEEL/REAR SHOCK ABSORBER



Drive in the other bearing. The bearing should fit against the distance collar. Do not continue to force the bearing in or the distance collar will begin to push the right bearing back out.



Apply grease to the lips of the dust seals. Drive in new dust seals.

17. BATTERY/CHARGING SYSTEM

17

BATTERY/CHARGING SYSTEM

CHARGING SYSTEM LAYOUT	17-1
CHARGING CIRCUIT	17-1
SERVICE INFORMATION.....	17-2
TROUBLESHOOTING.....	17-3
BATTERY	17-4
CHARGING VOLTAGE INSPECTION	17-6
REGULATOR/RECTIFIER	17-7

17. BATTERY/CHARGING SYSTEM

CHARGING SYSTEM LAYOUT



REGULATOR/RECTIFIER

BATTERY

ACG

CHARGING CIRCUIT

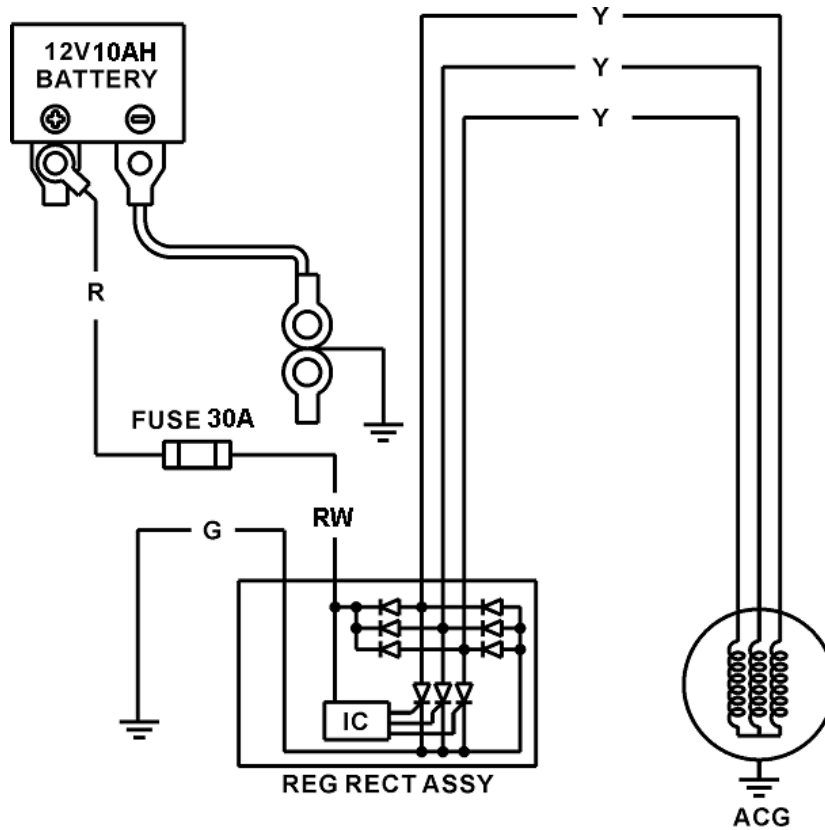

17. BATTERY/CHARGING SYSTEM

SERVICE INFORMATION

GENERAL INSTRUCTIONS

* The battery electrolyte (sulfuric acid) is poisonous and may seriously damage the skin and eyes. Avoid contact with skin, eyes, or clothing. In case of contact, flush with water and get prompt medical attention

- The battery can be charged and discharged repeatedly. If a discharged battery is not used for a long time, its service life will be shortened. Generally, the capacity of a battery will decrease after it is used for 2~3 years. A capacity-decreased battery will resume its voltage after it is recharged but its voltage decreases suddenly and then increases when a load is added.
- When a battery is overcharged, some symptoms can be found. If there is a short circuit inside the battery, no voltage is produced on the battery terminals. If the rectifier can not be operated, the voltage will become too high and shorten the battery service life.
- If a battery is not used for a long time, it will discharge by itself and should be recharged every 3 months.
- A new battery filled with electrolyte will generate voltage within a certain time and it should be recharged when the capacity is insufficient. Recharging a new battery will prolong its service life.
- Inspect the charging system according to the sequence specified in the Troubleshooting.
- It is not necessary to check the MF battery electrolyte or fill with distilled water.
- Check the load of the whole charging system.
- Do not quick charge the battery. Quick charging should only be done in an emergency.
- Remove the battery from the motorcycle for charging.
- When replacing the battery, do not use a traditional battery.
- When charging, check the voltage with an electric tester.

Caution:

To avoid damage from the scooter's electronic fuel injection system, do not remove or install a battery wire when the ignition switch is at the "ON" position.

SPECIFICATIONS

Item		Standard	
Battery	Capacity	12V9AH	
	Voltage (20°C)	Fully charged	13.2V
		Insufficient charged	12.3V below
	Charging current	Normal	1.2AX5~9H
Quick		5.0AX1H	

17. BATTERY/CHARGING SYSTEM

TROUBLESHOOTING

No power

- Dead battery
- Disconnected battery cable
- Fuse burned out
- Faulty ignition switch

Low power

- Weak battery
- Loose battery connection
- Charging system failure
- Faulty regulator/rectifier

Intermittent power

- Loose battery cable connection
- Loose charging system connection
- Loose connection or short circuit in ignition system

Charging system failure

- Loose, broken or shorted wire or connector
- Faulty regulator/rectifier
- Faulty A.C. generator

17. BATTERY/CHARGING SYSTEM

BATTERY

REMOVAL/INSTALLATION

The battery is in the battery box behind seat.

Remove the seat.



Remove the screw and then remove the battery cover

Pull battery out to expose the terminal leads

Disconnect the negative (-) terminal lead from the battery first, then disconnect the positive (+) terminal lead.

Remove the battery from the battery box.

Battery installation:

Install in the reverse order of the removal.

* When install the battery, first connect the positive (+) cable and then negative (-) cable to avoid short circuit.



VOLTAGE INSPECTION

Remove the battery cover .

Measure the battery voltage using a commercially available digital multimeter.

Voltage (20°C/68°C):

Fully charged: 13 – 13.2 V

Insufficient charged: below 12.3 V

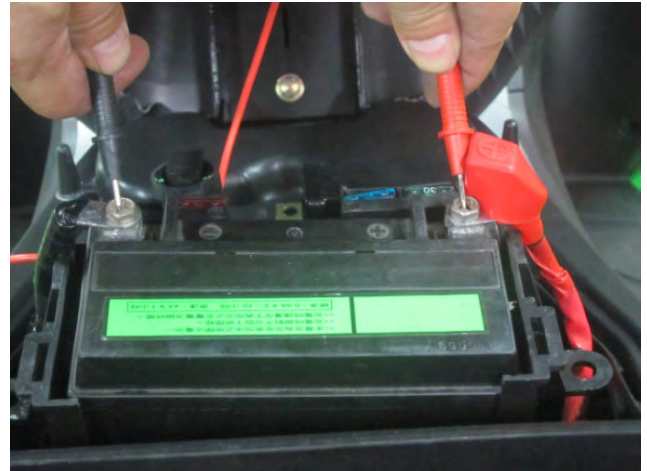

BATTERY CHARGING

Remove the battery

Connect the charger positive (+) cable to the battery positive (+) terminal.

Connect the charger negative (-) cable to the battery negative (-) terminal.

* Turn the power ON/OFF at the battery charger, not at the battery terminals.

Charging current time:

Standard: 1.2A/5 – 10h

Quick: 5A/1h

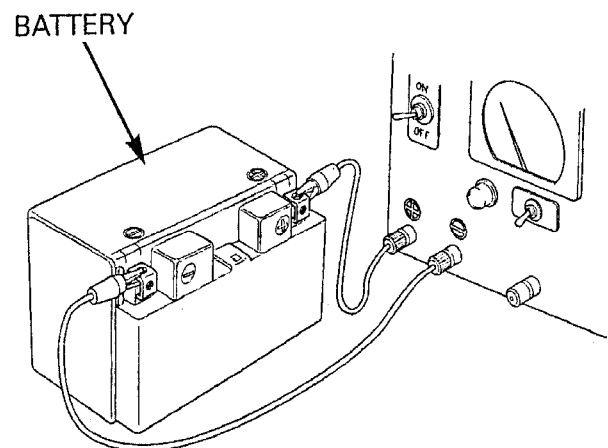

Quick charging should only be done in an emergency; slow charging is preferred. For battery charging, do not exceed the charging current and time specified on the battery. Using excessive current or extending the charging time may damage the battery.

17. BATTERY/CHARGING SYSTEM

CHARGING VOLTAGE INSPECTION

Be sure that the battery is in good condition before performing this test.

* Do not disconnect the battery or any cable in the charging system without first switching off the ignition switch. Failure to follow this precaution can damage the tester or electrical components.

Connect the multimeter between the positive and negative terminals of the battery.

To prevent short, make absolutely certain which are the positive and negative terminals or cable.

With the headlight on and turned to the high beam position, restart the engine.

Measure the voltage on the multimeter when the engine runs at 5000 min (rpm).

Standard:

Measure charging voltage

14.5±0.5 V

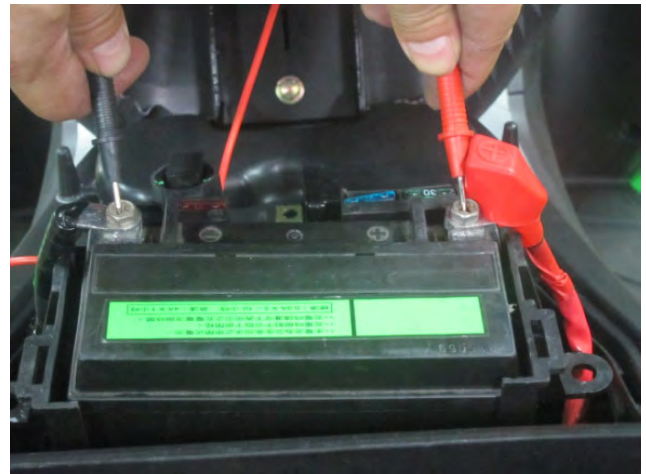

17. BATTERY/CHARGING SYSTEM

REGULATOR/RECTIFIER

WIRE HARNESS INSPECTION

Remove the luggage box (refer to the “**FRAME COVERS REMOVAL/INSTALLATION**” section in the chapter 2).

Disconnect the regulator/rectifier connectors.
Check the connector for loose contacts of corroded terminals.

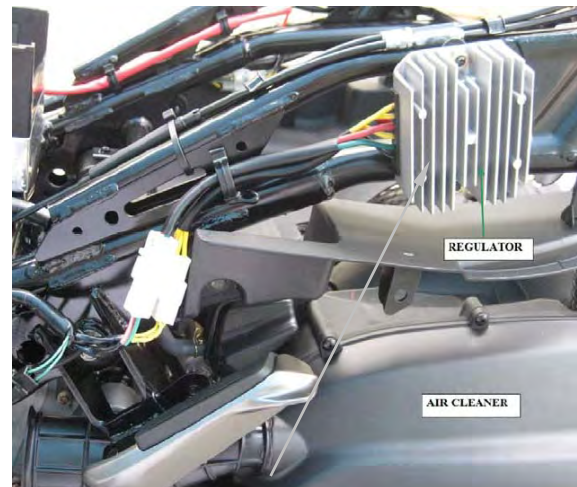

Regulator/Rectifier

Measure the voltage between the Red/White wire terminal and ground.
There should be same with battery voltage at all times.

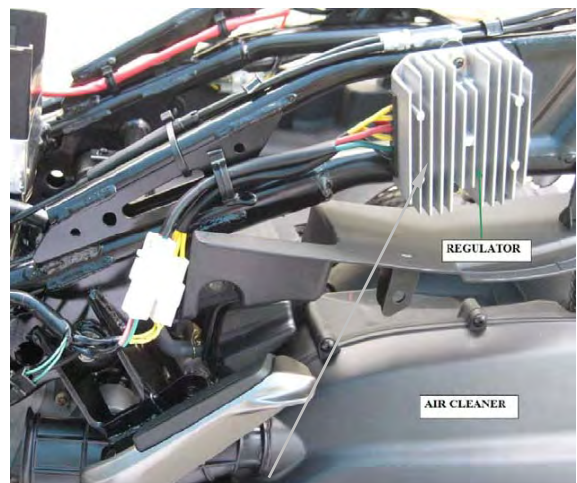

Regulator/Rectifier

17. BATTERY/CHARGING SYSTEM

Check the continuity between the Green wire terminal and ground.

There should be continuity at all times.



Measure the resistance between each Yellow wire terminals.

Disconnect the regulator/rectifier connector.

Check for continuity between each Yellow wire terminal regulator/rectifier side and ground.

There should be no continuity.

18. IGNITION SYSTEM

18

IGNITION SYSTEM

IGNITION SYSTEM LAYOUT	18-1
SERVICE INFORMATION.....	18-2
TROUBLESHOOTING.....	18-3
IGNITION COIL INSPECTION	18-4

18. IGNITION SYSTEM

IGNITION SYSTEM LAYOUT

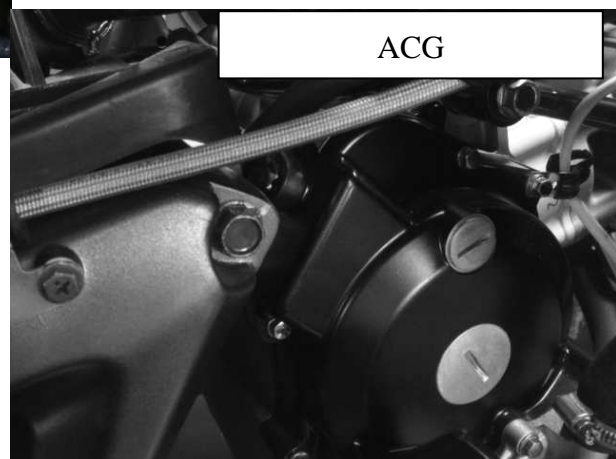
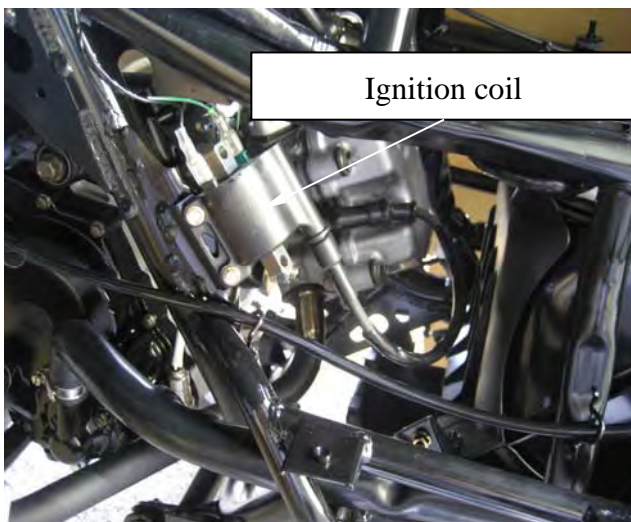
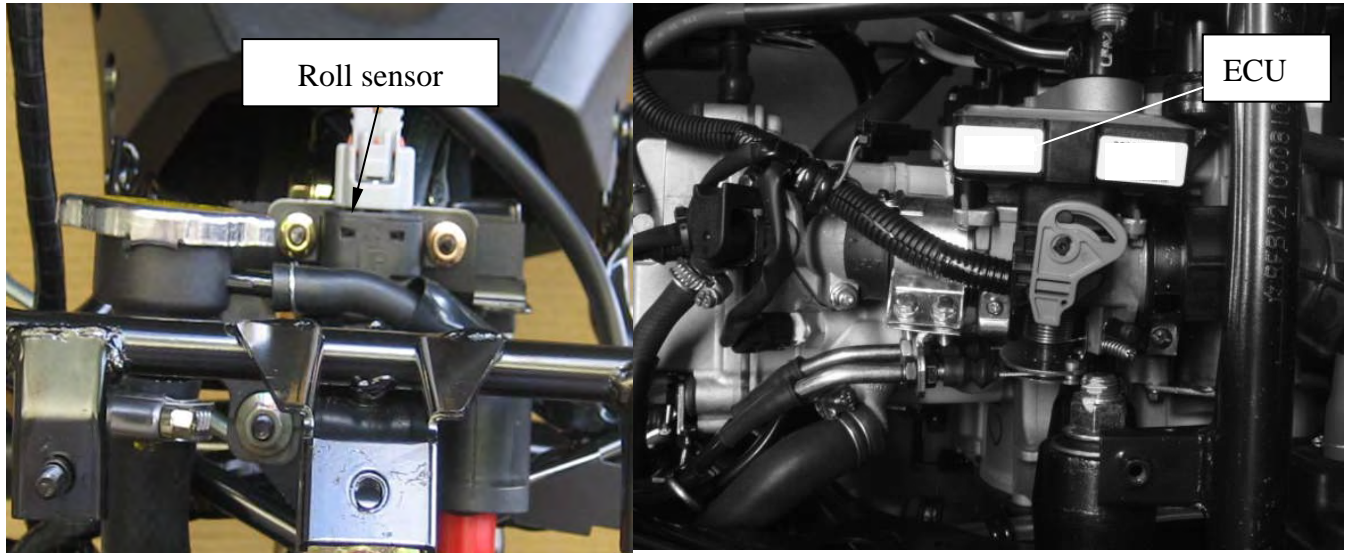

18. IGNITION SYSTEM

SERVICE INFORMATION

GENERAL INSTRUCTIONS

Some electrical components may be damaged if terminals or connectors are connected or disconnected while the ignition switch is “ON” and current is present.

- When servicing the ignition system, always follow the steps in the troubleshooting..
- The ignition control module or ECU may be damaged if dropped. Also, if the connector is disconnected when current is flowing, the excessive voltage may damage the ignition control module or ECU. Always turn off the ignition switch before servicing.
- A faulty ignition system is often related to poor connections. Check those connections before proceeding.
- Make sure the battery is adequately charged. Using the starter motor with a weak battery results in a slower engine cranking speed as well as no spark at the spark plug.
- Use a spark plug of the correct heat range. Using spark plug with an incorrect heat range can damage the engine.

SPECIFICATIONS

Item	Standard
Spark plug	NGK CR7E
Spark plug gap	0.6~0.7mm
Ignition timing	TPS
Ignition system	ECU

18. IGNITION SYSTEM

TROUBLESHOOTING

LOW PEAK VOLTAGE

- Cranking speed is too low (battery is undercharged).
- Poorly connected connectors or an open circuit in the ignition system.
- Faulty ignition-coil.
- Faulty ignition control module.

NO PEAK VOLTAGE

- Short circuit in engine stop switch or ignition switch wire.
- Faulty engine stop switch or ignition switch.
- Loose or poorly connected ignition control module connectors.
- Open circuit or poor connection in ground wire of the ignition control module.
- Faulty ignition pulse generator.
- Faulty ignition control module.

PEAK VOLTAGE IS NORMAL, BUT NO SPARK JUMPS AT THE PLUG

- Faulty spark plug or leaking ignition coil secondary current.
- Faulty ignition coil.

18. IGNITION SYSTEM

IGNITION COIL INSPECTION

IGNITION COIL PRIMARY PEAK VOLTAGE

Remove the body cover (refer to the **“FRAME COVERS REMOVAL/INSTALLATION”** section in the chapter 2).

Check cylinder compression and check that the spark plug (1) is installed correctly in the cylinder.

Disconnect the spark plug cap (2) from the spark plug.

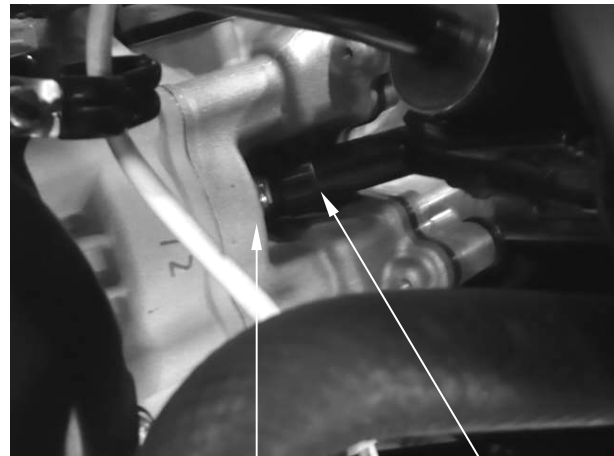

(1)

(2)

Turn the ignition switch to “ON” and engine stop switch ON and side stand is up.
 Connect the multimeter (+) probe to the black wire and the multimeter (-) to the body ground.
 Check for initial voltage at this time.
 The battery voltage should be measured.
 If the initial voltage cannot be measured, check the power output circuit.

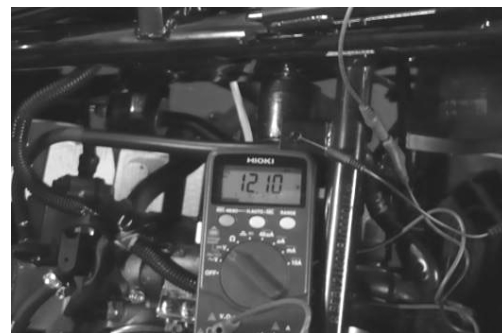

:

18. IGNITION SYSTEM

IGNITION PULSE GENERATOR INSPECTION

Remove the luggage box (refer to the “**FRAME COVERS REMOVAL/INSTALLATION**” section in the chapter 2).

Disconnect the ignition pulse generator connector.

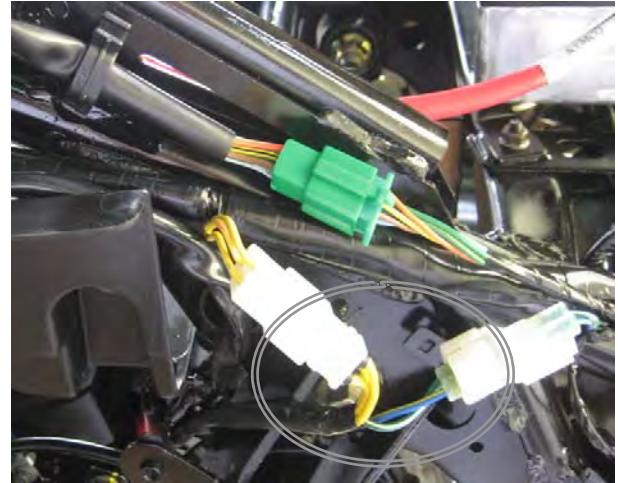

Measure the pulse generator resistance between the Green/White wire and Blue/Yellow wire.

Standard:

96~144Ω (20°C/68°F)



18. IGNITION SYSTEM

IGNITION COIL REMOVAL/INSTALLATION

Remove the luggage box (refer to the “**FRAME COVERS REMOVAL/INSTALLATION**” section in the chapter 2).

Disconnect the spark plug cap attaching the spark plug (1).

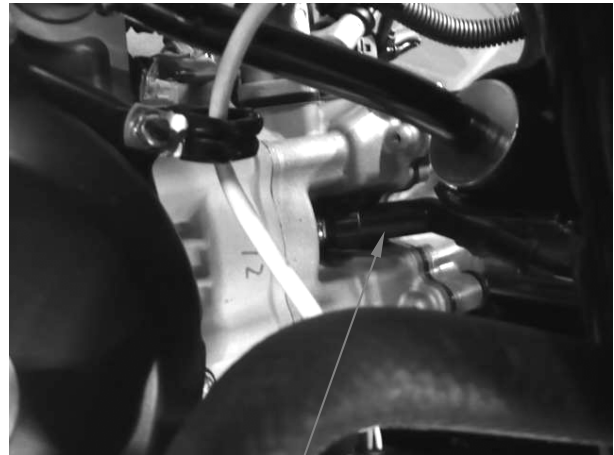

(1)

Disconnect the ignition coil connector.
Remove two bolts attaching the ignition coil .

Installation is in the reverse order of removal.



19. STARTING SYSTEM



STARTING SYSTEM

19

STARTING SYSTEM LAYOUT -----	19-1
SERVICE INFORMATION-----	19-2
TROUBLESHOOTING-----	19-2
STARTER MOTOR -----	19-3
STARTER RELAY INSPECTION-----	19-5

19. STARTING SYSTEM

STARTING SYSTEM LAYOUT

Start relay

Battery



Start motor



19. STARTING SYSTEM

SERVICE INFORMATION

GENERAL INSTRUCTIONS

- The removal of starter motor can be accomplished with the engine installed.
- After the starter clutch is installed, be sure to add the engine oil and coolant and then bleed air from the cooling system.

TORQUE VALUES

Starter motor mounting bolt 1 kgf-m (10 N-m,)

TROUBLESHOOTING

Starter motor can not working

- Fuse burned out
- Weak battery
- Faulty ignition switch
- Faulty starter clutch
- Faulty front or rear stop switch
- Faulty starter relay
- Poorly connected, broken or shorted wire
- Faulty starter motor

Lack of power

- Weak battery
- Loose wire or connection
- Foreign matter stuck in starter motor or gear

Starter motor rotates but engine does not start

- Faulty starter pinion
- Starter motor rotates reversely
- Weak battery

19. STARTING SYSTEM

STARTER MOTOR

INSPECTION

Disconnect the starter motor cable from the start relay.

Connect the start motor cable directly to the battery positive terminal.
If the starter motor fail to work, the starter motor is faulty.



REMOVAL

Turn the ignition switch turned to “OFF” position.
Release the rubber cap (1) and remove the terminal screw (2) to disconnect the start motor cable from the start motor.

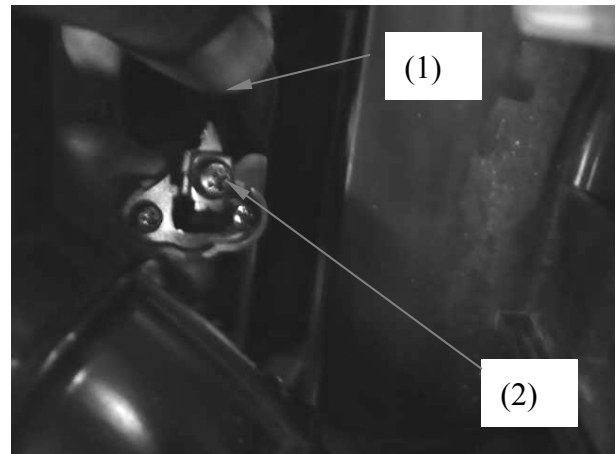

Remove two mounting bolts (3) , then remove the start motor.

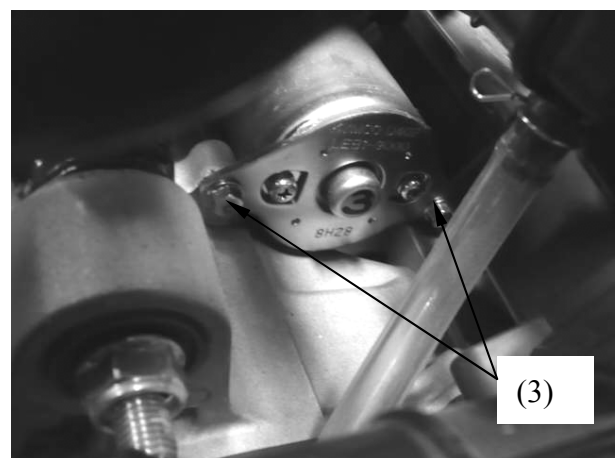

19. STARTING SYSTEM

INSTALLATION

Coat a new O-ring (1) with engine oil and install it into the start motor groove.

Install the starter motor into the crankcase.

Install the two mounting bolts and engine ground cable, then tighten the bolts securely.

Connect the start motor cable to motor terminal with the terminal screw and tighten it securely.

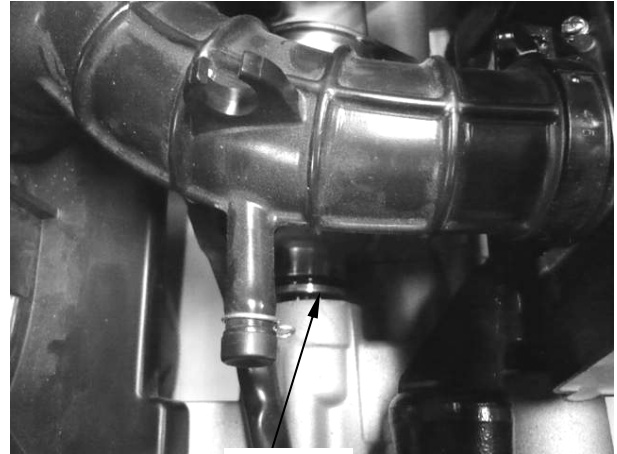

(1)

19. STARTING SYSTEM

START RELAY INSPECTION

Release the rubber cap (1) and remove the nut (2), then disconnect the start motor cable. Turn the ignition switch to “ON” position.

Squeeze and hold the brake lever fully then push the starter switch.

The coil is normal if the start relay switch clicks.

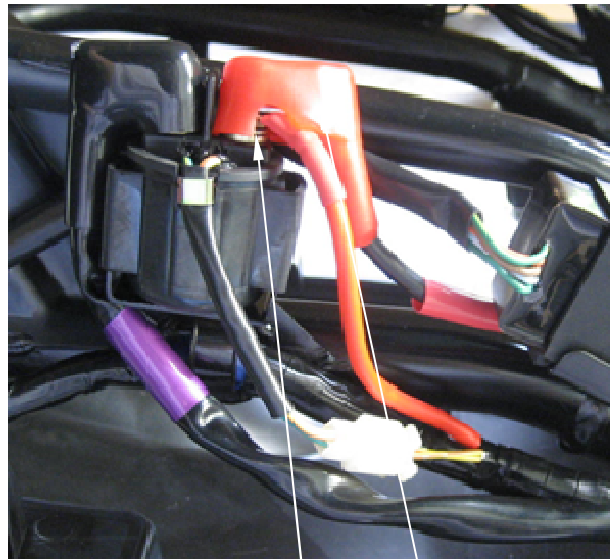

(2) (1)

Release the rubber caps and remove the nuts, then disconnect the start motor cable, battery positive cable and harness wire.

Disconnect the start relay connector and then remove start relay.

(3)

Connect a fully charged 12 V battery positive wire to the relay switch Yellow/Red wire terminal and negative wire to the Green/Yellow wire terminal.

There should be continuity between the cable terminals while the battery is connected, and no continuity when the battery is disconnected.

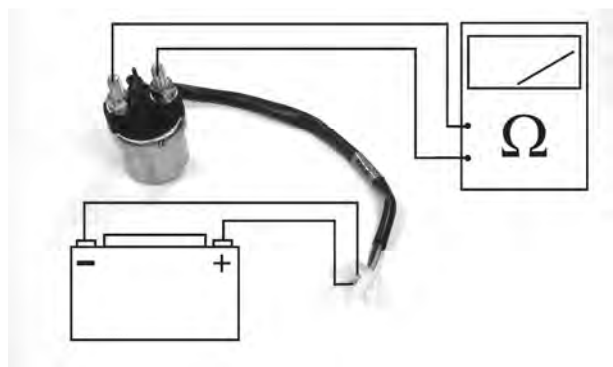

20. LIGHTS/METERS/SWITCHES

LIGHTS/METERS/SWITCHES

SERVICE INFORMATION-----	20- 1
HEADLIGHT -----	20- 2
AIM -----	20- 4
FRONT TURN SIGNALS-----	20- 4
TAILLIGHTS -----	20- 6
REAR TURN SIGNALS-----	20- 7
LICENSE TAG LIGHT -----	20- 8
IGNITION SWITCH -----	20- 9
TILT SWITCH -----	20-13
HANDLEBAR SWITCH -----	20-15
LUGGAGE BOX SWITCH -----	20-19
BRAKE LIGHT SWITCH-----	20-22

20. LIGHTS/METERS/SWITCHES

SERVICE INFORMATION

GENERAL

* A halogen head light bulb becomes very hot while the head light is turned on, and remains for a while after it is turned off. Be sure to let it cool down before servicing.

- Note the following when replacing the halogen headlight bulb
 - Wear clean gloves while replacing the bulb. Do not put finger prints on the headlight bulb, as they may create hot spots on the bulb and cause it to fail.
 - If you touch the bulb with your bare hands, clean it with a cloth moistened with alcohol to prevent its early failure.
 - Be sure to install the dust cover after replacing the bulb.
- Check the battery condition before performing any inspection that requires proper battery voltage.
- A continuity test can be made with the light switches installed on the scooter.
- Route the wires and cables properly after servicing each component.

20. LIGHTS/METERS/SWITCHES

Headlight

Bulb Replacement

Make sure the machine has been off for several minutes before removing the headlight bulb.

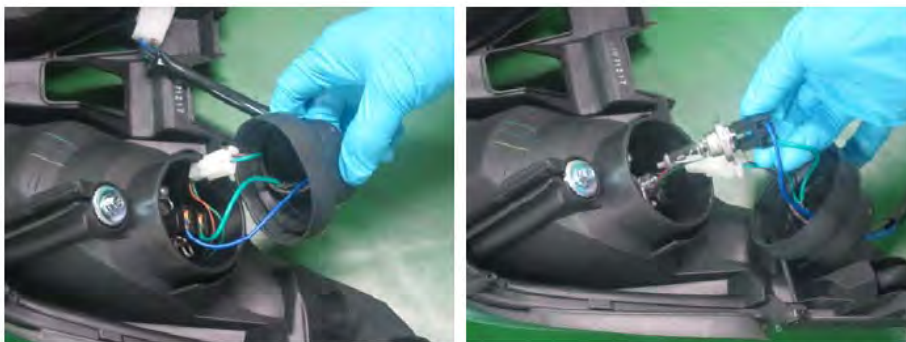

Slide back the rubber headlight covers and then remove the headlight bulbs to free it from the lamp.

Unplug the bulb from its connector. Do not touch the bulb with your bare hands if you plan to reuse it.

20. LIGHTS/METERS/SWITCHES

Do not touch your new bulb with your bare hand. The oils on your hand can cause an early failure of the headlight bulb. If you do touch the bulb with your bare hand wipe off the bulb with a clean shop towel and alcohol.



Fit the bulb into the lamp and then remove the headlight bulbs to free it from the lamp.



Fit the rubber cover into place. Make sure the rubber covers are secured in place.

20. LIGHTS/METERS/SWITCHES

Aim



Turn the screws to adjust the head light aim as needed.

Front Turn Signals



Turn the turn signal bulb socket counterclockwise and free it from the lamp.

20. LIGHTS/METERS/SWITCHES



Push in on the bulb and rotate it clockwise to remove it from the socket. Insert the new bulb. Push down on the bulb and rotate it counterclockwise to lock it into place.

Insert the turn signal bulb and socket into place. Turn the socket clockwise to lock it into place.

20. LIGHTS/METERS/SWITCHES

Taillights

LED Replacement



Remove the five taillight mounting the tail light housing.



Remove two screws mounting the clips.

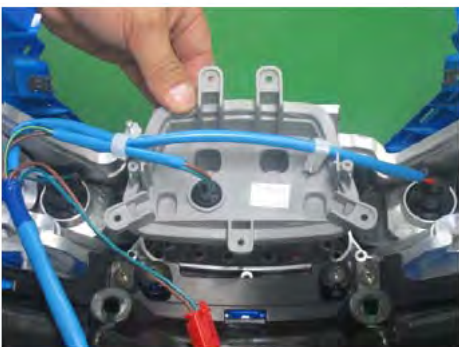

Remove the LED taillight assy.
Replace the LED as needed.
Install the taillight socket into the LED.

20. LIGHTS/METERS/SWITCHES

Rear Turn Signals



Turn the socket counterclockwise and remove it from the lamp.



Push in the bulb and turn it counterclockwise. Remove the bulb. Insert the new bulb and turn it clockwise to lock it in place.

20. LIGHTS/METERS/SWITCHES

License Tag Light

Remove the license tag light from the mud flap.



Pull the rubber tag light socket out of its housing. Pull the bulb straight out and insert a new one.

20. LIGHTS/METERS/SWITCHES

Switches

SAFETY FIRST: Protective gloves and eyewear are recommended at this point.

You will need a digital multimeter to inspect the switches.

Ignition Switch

Remove the front cover.



Unplug the white six-pin ignition switch connector.



Use a digital multimeter to check for continuity to inspect the ignition switches. Continuity should exist between the wires as indicated.

20. LIGHTS/METERS/SWITCHES

COMB SW

	BAT2	IG	E	BAT1	HA
LOCK		○—○			
OFF		○—○		○—○	
ON	○—			○—○	
COLOR	B	B/W	G	R	B/L

Removal

Remove the front cover.

Remove the dash.



20. LIGHTS/METERS/SWITCHES



Remove the seat latch cable cover.



Loosen the seat latch cable screw with a #2 Phillips screwdriver.

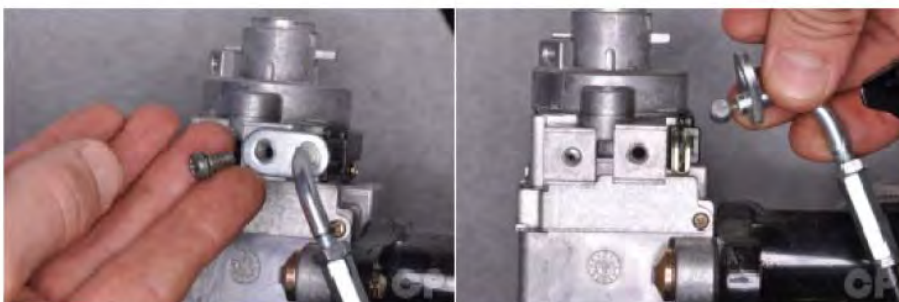

Remove the seat latch cable screw and free the seat latch cable from the ignition switch.

20. LIGHTS/METERS/SWITCHES

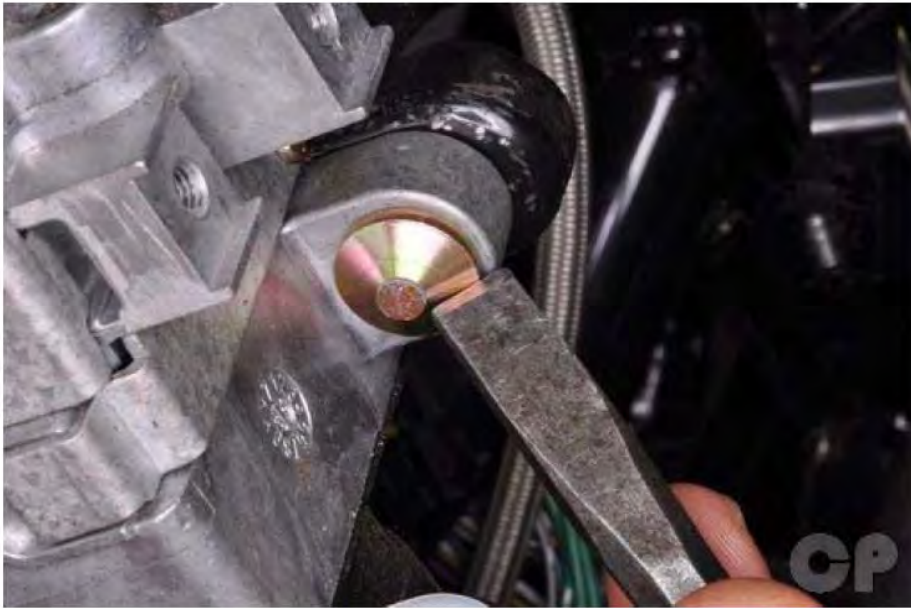

To remove the anti-tamper bolts use a punch and a hammer to strike the bolts so that they rotate loose. Turn the bolts clockwise to loosen them.

Installation

Install new anti-tamper bolts and tighten them securely.

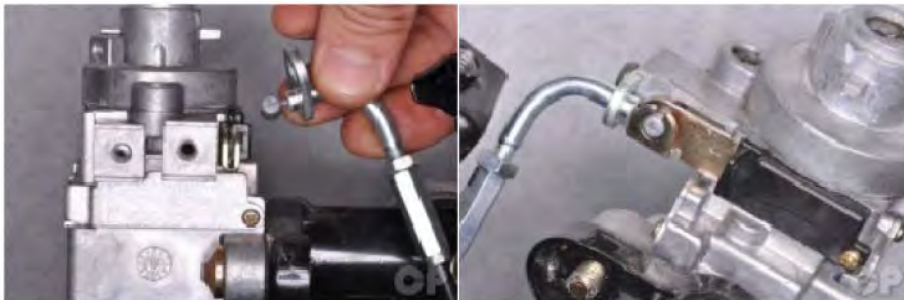

Fit the end of the seat latch cable into the ignition switch.



Install the seat latch cable screw and tighten it securely with a #2 Phillips screwdriver.

20. LIGHTS/METERS/SWITCHES



Install the seat latch cable cover.

Tilt Switch

Remove the front cover.

Support the scooter level surface.

Put the side stand up and engine stop switch on "RUN". Turn the ignition switch to "OFF".

Note: Do not disconnect the tilt switch connector during inspection.
The capacity of battery must be fully charged.



The tilt switch is next to the radiator cap.

20. LIGHTS/METERS/SWITCHES



Remove the two tilt switch bolts with a 10 mm socket.

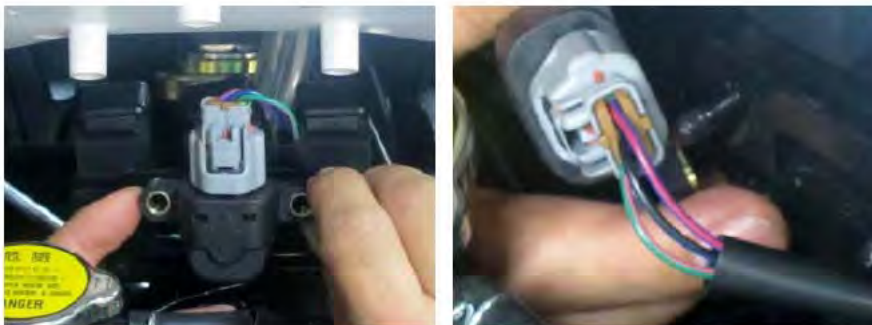

Place the tilt switch vertical as shown and the ignition switch "ON". Measure the voltage as below.

Terminal	Standard
Violet/Red (+) ~ Green/Pink (-)	5 V (ECU voltage)
Black/Blue (+) ~ Green/Pink (-)	0.4 - 1.4 V less



Incline the tilt switch 65 ± 10 degrees to the left or right at the ignition switch "ON". Measure the voltage as below.

Terminal	Standard
Violet/Red (+) ~ Green/Pink (-)	5 V (ECU voltage)
Black/Blue (+) ~ Green/Pink (-)	3.7 - 4.4 V

Note: Repeat this test, first turn the ignition switch to "OFF", then turn the ignition switch to "ON".

20. LIGHTS/METERS/SWITCHES



Disconnect the connector to remove the tilt switch.

Note: Install the tilt switch with its “up” mark facing up and tighten the two screws securely.

Handlebar Switches

Remove the front cover.

To remove the handle bar switches see the Handlebar topic.



Unplug the black connector for the left handlebar switches.

20. LIGHTS/METERS/SWITCHES



Unplug the green connector for the right handlebar switches.

Right Handlebar Switches



Use a digital multimeter to check for continuity to inspect the handlebar switches. Continuity should exist between the wires as indicated.

LIGHTING SW

	BAT3	PO	TL	HL
.				
(N)				
P	○	○	○	
(N)	○	○	○	○
H	○	—	○	○
COLOR	BR/L	BR/W	BR	W/L

20. LIGHTS/METERS/SWITCHES

**Starter
Switch**

	E	ST
FREE		
PUSH	○—○	
COLOR	G	Y/R

**Engine
Stop
Switch**

	IG	BAT3
OFF		
RUN	○—○	
COLOR	B/W	B/G

HAZARD SW

	(N)	WR	HA
△		○—○	
N	○—○—○		
○	○—○		

20. LIGHTS/METERS/SWITCHES

Left Handlebar Switches



Use a digital multimeter to check for continuity to inspect the handlebar switches. Continuity should exist between the wires as indicated.

Passing Switch

	BAT4	HI
FREE		
PUSH	○—○	
COLOR	BR/L	L

Horn Switch

	BAT4	HO
FREE		
PUSH	○—○	
COLOR	BR/L	LG

Turn Signal Switch

	WR	R	L
R	○—○		
N			
L	○—○		
COLOR	GR	SB	0

Dimmer Switch

	HL	HI	LO
LO	○—○		
(N)	○—○—○		
HI	○—○		
COLOR	W/L	L	W

20. LIGHTS/METERS/SWITCHES

Luggage Box Switch

Remove the luggage box.



Unplug the two-pin luggage box light LED switch connector with red/white and green wires.

Use a digital multimeter to check for continuity. Test the switch side of the connector for continuity as the switch is manipulated. There should be continuity when the switch is pushed and none when it is released.



The switch is located both the side seat latch.

20. LIGHTS/METERS/SWITCHES



Luggage box light LED switch

Side Stand Switch

Remove the luggage box.

Place the vehicle on the center stand.

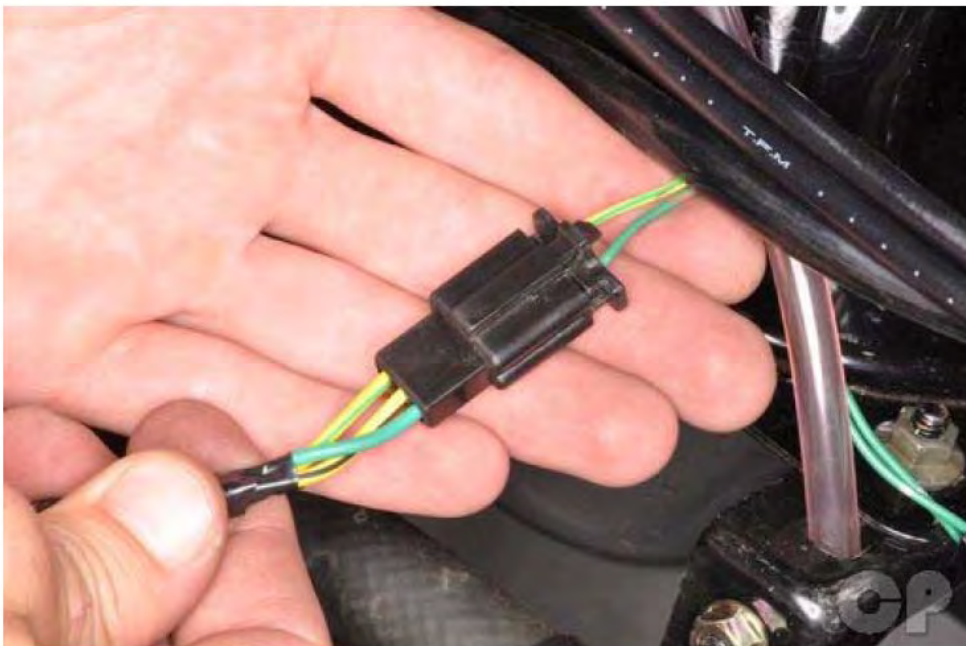

Unplug the three-pin side stand switch connector.

20. LIGHTS/METERS/SWITCHES

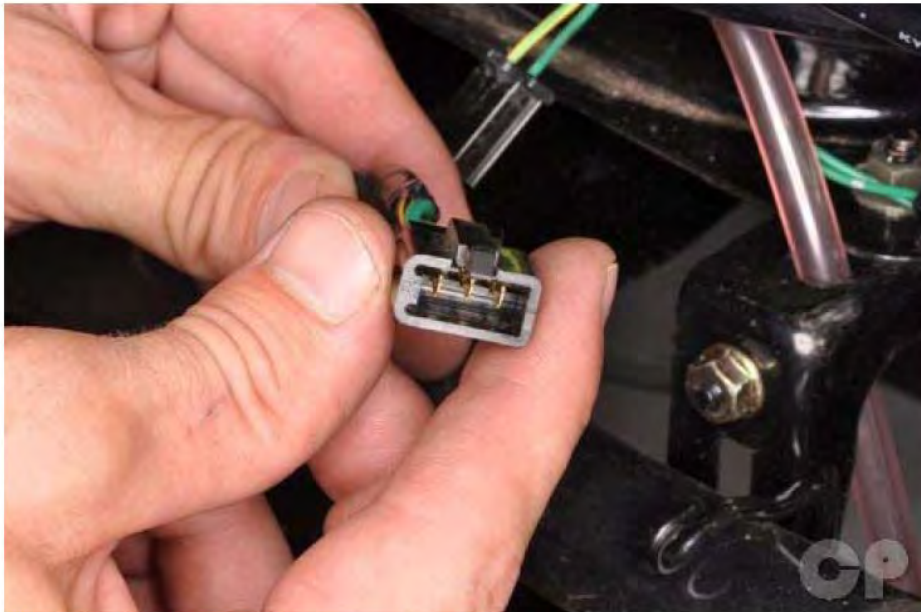

Use a digital multimeter to check for continuity.



With the side stand retracted there should be continuity between the yellow/green wire and the green wire terminals.

20. LIGHTS/METERS/SWITCHES



With the side stand extended there should be continuity between the yellow/black wire and the green wire terminals.

Brake Light Switches

Test the front and rear brake light switches in the same manner. Use a digital multimeter to check for continuity.

Remove the upper handlebar cover.



Unplug the brake light switch connectors.

20. LIGHTS/METERS/SWITCHES



Check for continuity between the brake light switch connectors. There should be continuity when the lever is pulled and none when released.