

PREFACE

This Service Manual describes the technical features and servicing procedures for the KYMCO **Quannon 125**.

Section 1 contains the precautions for all operations stated in this manual. Read them carefully before starting any operation.

Section 2 is the inspection/ adjustment procedures, safety rules and service information for each part, starting from periodic maintenance.

Sections 3 and 4 state the servicing procedures and cautions for the removal and installation of lubrication and fuel systems.

Sections 5 through 18 give instructions for disassembly, assembly and inspection of engine, chassis frame and electrical equipment.

Most sections start with an assembly or system illustration and troubleshooting for the section. The subsequent pages give detailed procedures for the section.

The information and contents included in this manual may be different from the motorcycle in case specifications are changed.

TABLE OF CONTENTS

ENGINE	GENERAL INFORMATION	1
	INSPECTION/ADJUSTMENT	2
	LUBRICATION SYSTEM	3
	FUEL SYSTEM	4
	ENGINE REMOVAL/INSTALLATION	5
	CYLINDER HEAD/VALVES	6
	CYLINDER/PISTON	7
	STARTER MOTOR/GENERATOR/ LEFT CRANKCASE COVER/STARTER CLUTCH/CAMSHAFT	8
	CLUTCH/GEAR SHIFT MECHANISM	9
	CRANKCASE/CRANKSHAFT/TRANS- MISSION SYSTEM/STARTER SPINDLE	10
CHASSIS	FRONT WHEEL/SUSPENSION/ STEERING	11
	REAR WHEEL/BRAKE/SUSPENSION	12
	HYDRAULIC BRAKE	13
	REAR CARRIER/REAR FENDER/ EXHAUST MUFFLER	14
ELECTRICAL EQUIPMENT	IGNITION SYSTEM	15
	CHARGING SYSTEM	16
	STARTING SYSTEM	17
	LIGHTS/INSTRUMENTS/SWITCHES/ HORN	18

KWANG YANG MOTOR CO., LTD.

Quality Technology Division

Education Section

1. GENERAL INFORMATION



GENERAL INFORMATION

SERIAL NUMBER	1-1
SPECIFICATION	1-2
SERVICE PRECAUTIONS	1-3
TORQUE VALUES	1-7
SPECIAL TOOLS	1-8
LUBRICATION POINTS	1-9
CABLE & HARNESS ROUTING	1-10

1. GENERAL INFORMATION

SERIAL NUMBER

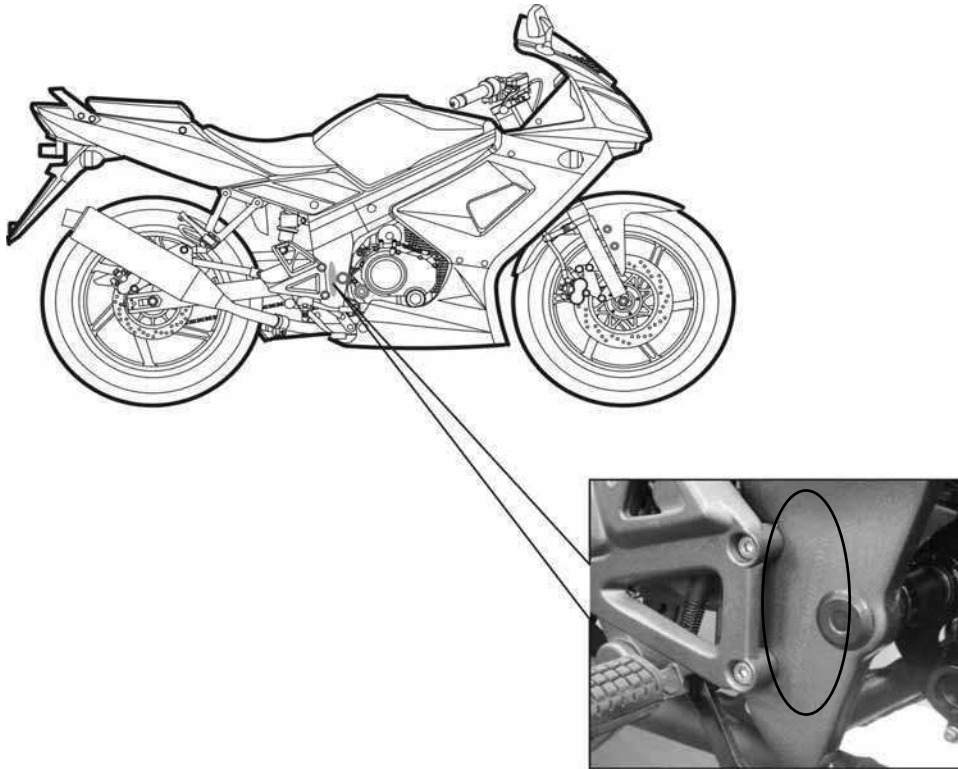

Location of Frame Serial Number

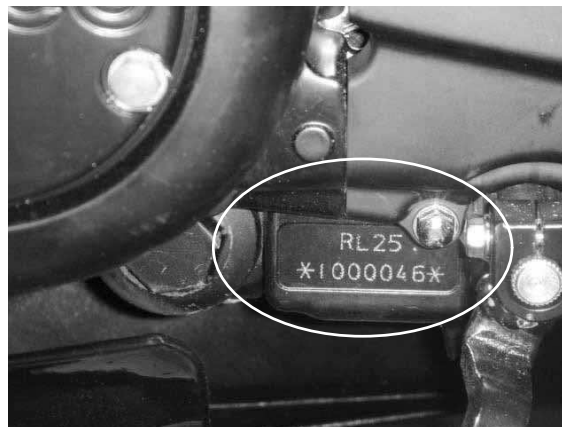

Location of Engine Serial Number

1. GENERAL INFORMATION

QUANNON 125

SPECIFICATIONS

Name & Model No.		RL25BA		
Motorcycle Name & Type		QUANNON 125		
Overall length		2057mm		
Overall width		725mm		
Overall height		1174mm		
Wheel base		1355mm		
Engine type		SOHC 4V		
Displacement		124.1cc		
Fuel Used		92# nonleaded gasoline		
1 person (55kg) weight (kg)	Front wheel	96		
	Rear wheel	126		
	Total	222		
2 person (110kg) weight(kg)	Front wheel	98		
	Rear wheel	194		
	Total	292		
Tires spec.	Front wheel	110/80-17		
	Rear wheel	140/70-17		
Ground clearance		170mm		
Performance	Braking distance (m)	7.8m		
	Min. turning radius (R/L)	2550/2525mm		
Engine	Starting system		Starting motor	
	Type		Gasoline, 4-stroke	
	Cylinder arrangement		Single cylinder	
	Combustion chamber type		Semi-sphere	
	Valve arrangement		O.H.C. 4V	
	Bore x stroke (mm)		ϕ 56.5x 49.5	
	Compression ratio		11:1	
	Compression pressure (kg/cm ²)		13 \pm 2	
	Max. output (ps/rpm)		13.0/9500	
	Max. torque (N.m/rpm)		1.0/8500	
	Port timing	Intake	BTDC	0°
			ABDC	23°
		Exhaust	BBDC	-6°
			ATDC	43.5°
	Valve clearance	Intake	0.06 mm	
		Exhaust	0.06 mm	
	Idle speed (rpm)		1600 \pm 100rpm	
	Lubrication System	Lubrication type		Forced pressure & Wet sump
		Oil pump type		Inner/outer rotor type
		Oil filter type		Wire gauze filter
Oil capacity		1.1 liters		
Cooling Type		Oil cooling		

Fuel System	Air cleaner type & No		Paper element	
	Fuel capacity		13.5 liters	
	Carburetor	Type	CVK	
		Piston dia.	ϕ 26.5	
Venturi dia.		ϕ 25		
	Throttle type		Vacuum	
Electrical Equipment	Ignition System	Type	CDI	
		Ignition timing	30° \pm 2/4000rpm	
		Contact breaker	---	
		Spark plug	NGK CR8E	
		Spark plug gap	0.7mm	
	Battery	Capacity	12V7AH	
Power Drive System	Clutch	Type	Wet-multi-disc clutch	
		Transmission Gear	Type	Permanent gear meshing
	Operation		Foot operated	
	Type		International type	
	Reduction Gear	Reduction Ratio	1st	2.85
2nd			2.06	
3rd			1.44	
4th			1.13	
5th			0.92	
Moving Device	Tire pressure (kgf/cm ²)	Front	1.75	
		Rear	2.0	
	Turning angle	Left	32°	
Right		32°		
Brake system type		Front	Disk (276mm)	
		Rear	Disk (220mm)	
Damping Device	Suspension type	Front	Telescope	
		Rear	Single swing	
	Shock absorber type	Front	Telescope	
		Rear	Single swing	
Frame type		Double cradle		

1. GENERAL INFORMATION

SERVICE PRECAUTIONS

- Make sure to install new gaskets, O-rings, circlips, cotter pins, etc. when reassembling.

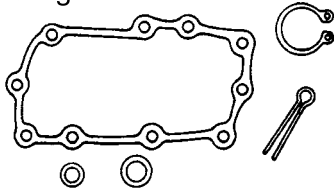

- When tightening bolts or nuts, begin with larger-diameter to smaller ones at several times, and tighten to the specified torque diagonally.

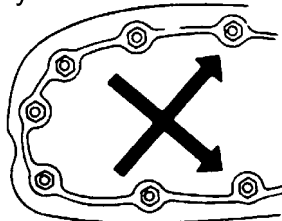

- Use genuine parts and lubricants.

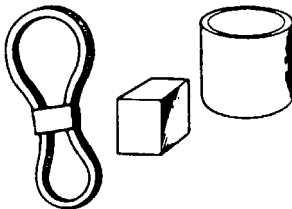

- When servicing the motorcycle, be sure to use special tools for removal and installation.



- After disassembly, clean removed parts. Lubricate sliding surfaces with engine oil before reassembly.

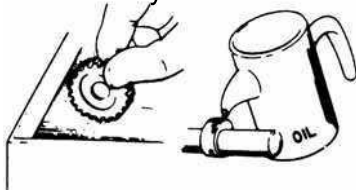

- Apply or add designated greases and lubricants to the specified lubrication points.

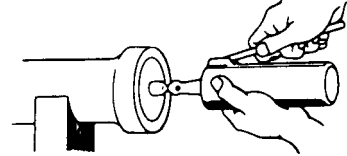

- After reassembly, check all parts for proper tightening and operation.

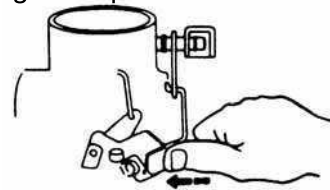

- When two persons work together, pay attention to the mutual working safety.



- Disconnect the battery negative (-) terminal before operation.
- When using a spanner or other tools, make sure not to damage the motorcycle surface.

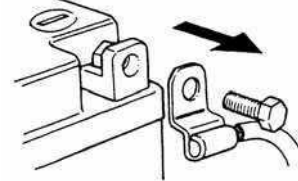

- After operation, check all connecting points, fasteners, and lines for proper connection and installation.
- When connecting the battery, the positive (+) terminal must be connected first.
- After connection, apply grease to the battery terminals.
- Terminal caps shall be installed securely.

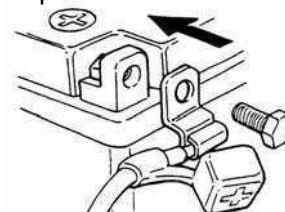

1. GENERAL INFORMATION

- If the fuse is burned out, find the cause and repair it. Replace it with a new one according to the specified capacity.

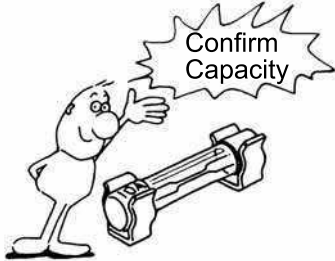

- After operation, terminal caps shall be installed securely.

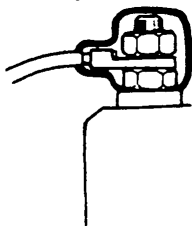

- When taking out the connector, the lock on the connector shall be released before operation.

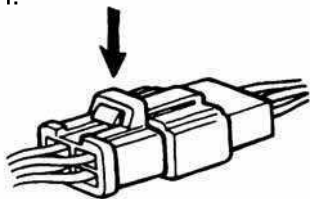

- Hold the connector body when connecting or disconnecting it.
- Do not pull the connector wire.



- Check if any connector terminal is bending, protruding or loose.

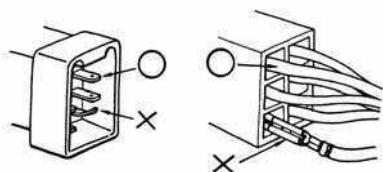

- The connector shall be inserted completely.
- If the double connector has a lock, lock it at the correct position.
- Check if there is any loose wire.

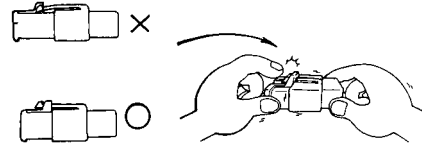

- Before connecting a terminal, check for damaged terminal cover or loose negative terminal.

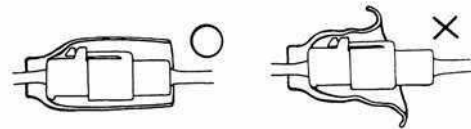

- Check the double connector cover for proper coverage and installation.

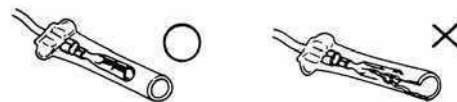

- Insert the terminal completely.
- Check the terminal cover for proper coverage.
- Do not make the terminal cover opening face up.



- Secure wire harnesses to the frame with their respective wire bands at the designated locations. Tighten the bands so that only the insulated surfaces contact the wire harnesses.

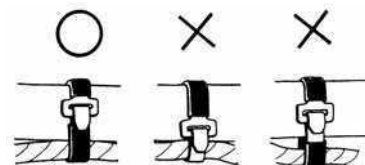

1. GENERAL INFORMATION

- After clamping, check each wire to make sure it is secure.

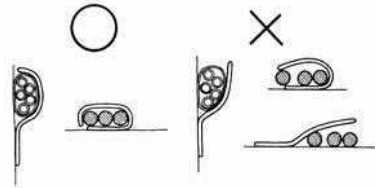

- Do not squeeze wires against the weld or its clamp.



- After clamping, check each harness to make sure that it is not interfering with any moving or sliding parts.

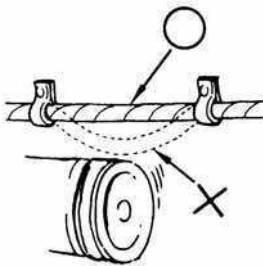

- When fixing the wire harnesses, do not make it contact the parts which will generate high heat.

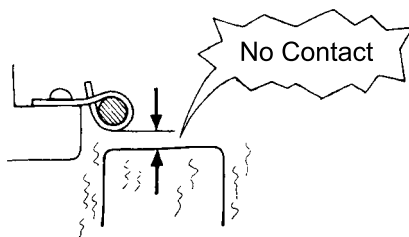

- Route wire harnesses to avoid sharp edges or corners. Avoid the projected ends of bolts and screws.
- Route wire harnesses passing through the side of bolts and screws. Avoid the projected ends of bolts and screws.

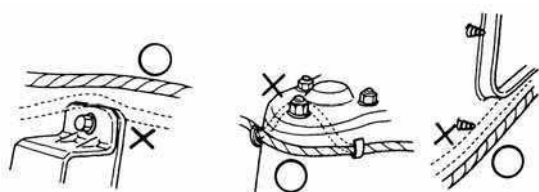

- Route harnesses so they are neither pulled tight nor have excessive slack.

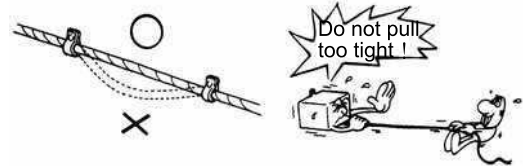

- Protect wires and harnesses with electrical tape or tube if they contact a sharp edge or corner.

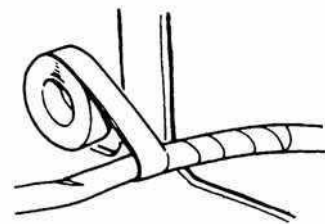

- When rubber protecting cover is used to protect the wire harnesses, it shall be installed securely.

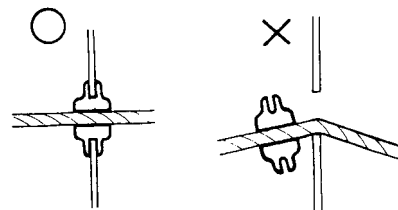

- Do not break the sheath of wire.
- If a wire or harness is with a broken sheath, repair by wrapping it with protective tape or replace it.

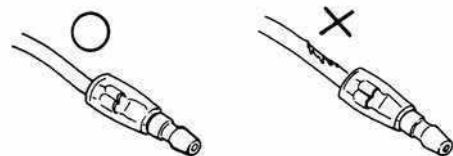

- When installing other parts, do not press or squeeze the wires.



1. GENERAL INFORMATION

- After routing, check that the wire harnesses are not twisted or kinked.

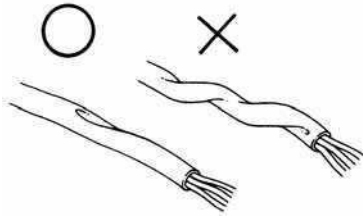

- Wire harnesses routed along with handlebar should not be pulled tight, have excessive slack or interfere with adjacent or surrounding parts in all steering positions.

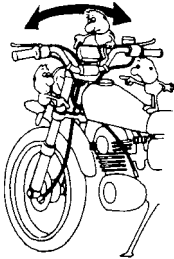

- When a testing device is used, make sure to understand the operating methods thoroughly and operate according to the operating instructions.

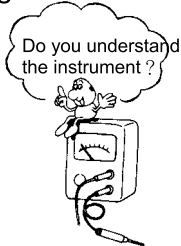

- Be careful not to drop any parts.

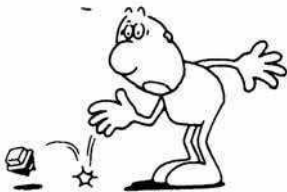

- When rust is found on a terminal, remove the rust with sand paper or equivalent before connecting.



- Symbols:

The following symbols represent the servicing methods and cautions included in this service manual.



: Apply engine oil to the specified points. (Use designated engine oil for lubrication.)



: Apply grease for lubrication.

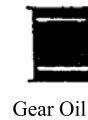

: Transmission Gear Oil (90#)



: Use special tool.



: Caution



: Warning

1. GENERAL INFORMATION

TORQUE VALUES

STANDARD TORQUE VALUES

Item	Torque (kg-m)	Item	Torque (kg-m)
5mm bolt, nut	0.45~0.6	5mm screw	0.35~0.5
6mm bolt, nut	0.8~1.2	6mm screw, SH bolt	0.7~1.1
8mm bolt, nut	1.8~2.0	6mm flange bolt, nut	1.0~1.4
10mm bolt, nut	3.0~4.0	8mm flange bolt, nut	2.0~3.0
12mm bolt, nut	5.0~6.0	10mm flange bolt, nut	3.5~4.5

Torque specifications listed below are for important fasteners.

ENGINE

Item	Q'ty	Thread dia.(mm)	Torque (kg-m)	Remarks
Cylinder head bolt A	2	8	2.8~3.2	
Cylinder head bolt B	2	8	2.8~3.2	
Oil filter lock nut	1	36	1.5~3.0	
Exhaust muffler joint lock nut	2	6	0.8~1.2	
Valve adjusting lock nut	4	5	1.4~1.8	
Oil removal bolt	1	12	2.0~3.0	
Cylinder head bolt	4	8	2.3~2.8	
Flywheel lock bolt	1	14	4.0~5.0	
Cylinder head cover bolt	4	6	0.8~1.2	
Oil pump bolt	2	6	0.7~1.1	
Oil filter lock nut	1	16	4.0~5.0	
Rocker arm lock bolt	3	8	1.5~2.0	
Cylinder head lock bolt	1	8x79	1.5~2.0	
Cylinder side bolt	2	6x22	0.8~1.2	
Crankcase assembly bolt	10	6	0.8~1.5	
Crankshaft damper bolt	1	6x25	0.8~1.2	
Right crankcase cover bolt	8	6	0.8~1.2	
Left crankcase cover bolt	4	6	0.8~1.2	
A.C. generator coil lock bolt	4	5	0.4~1.7	
Starter gear set plate bolt	2	6	1.0~1.6	
Carburetor lock bolt	2	6	0.8~1.2	

1. GENERAL INFORMATION

FRAME

Item	Q'ty	Thread dia.(mm)	Torque (kg-m)	Remarks
Steering stem lock nut	1	22	6.0~8.0	
Front axle nut	1	14	5.5~7.0	
Rear axle nut	1	16	6.0~8.0	
Rear shock absorber upper mount bolt	2	10	3.0~4.0	
Rear shock absorber lower mount bolt	2	10	3.0~4.0	
Rear fork pivot nut	1	12	5.5~7.0	
Handlebar lock bolt	4	6	0.8~1.2	
Rear driven gear bolt	4	8	1.8~2.0	
Rear brake panel bolt	1	8	2.4~3.0	

SPECIAL TOOLS

Tool Name	Tool No.	Remarks	Ref. Page
Flywheel puller	E005		Ph 8-3
Bearing puller 18mm	E008		Ph10
Lock nut wrench	E010		
Valve adjuster	E012		Ph 2-5
Oil seal & bearing installer	E014		
Bearing puller 15mm	E018		Ph10
Bearing puller 12mm	E020		Ph10
Flywheel holder	E021		Ph 8-3
Crankshaft bearing puller	E030		Ph10
Bearing puller 10mm	E031		Ph10
Valve spring compressor	E040		Ph 6-9
Race cone install	F005		
Steering stem wrench	F006		
Steering stem lock nut wrench	F007		

1. GENERAL INFORMATION

LUBRICATION POINTS

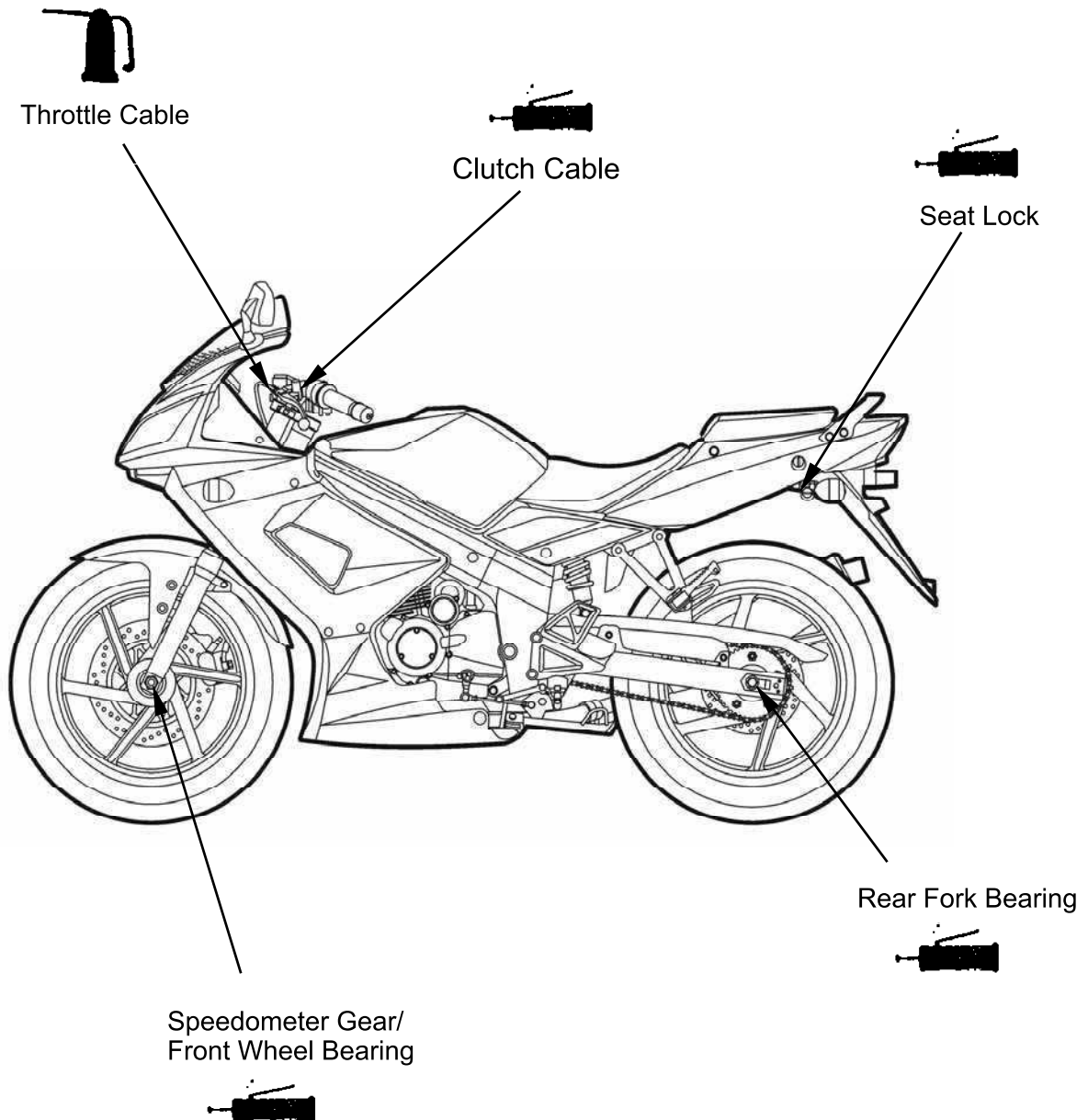

1. GENERAL INFORMATION

CABLE & HARNESS ROUTING

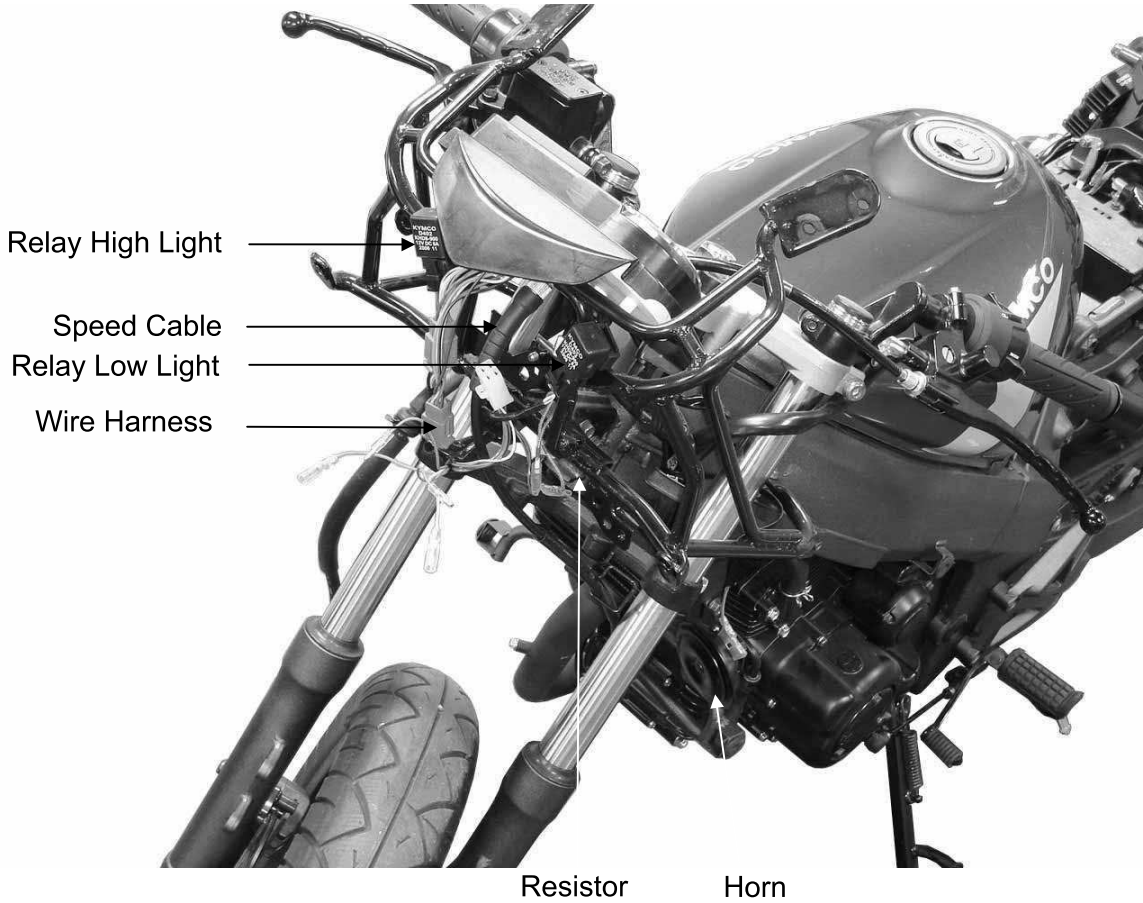

1. GENERAL INFORMATION

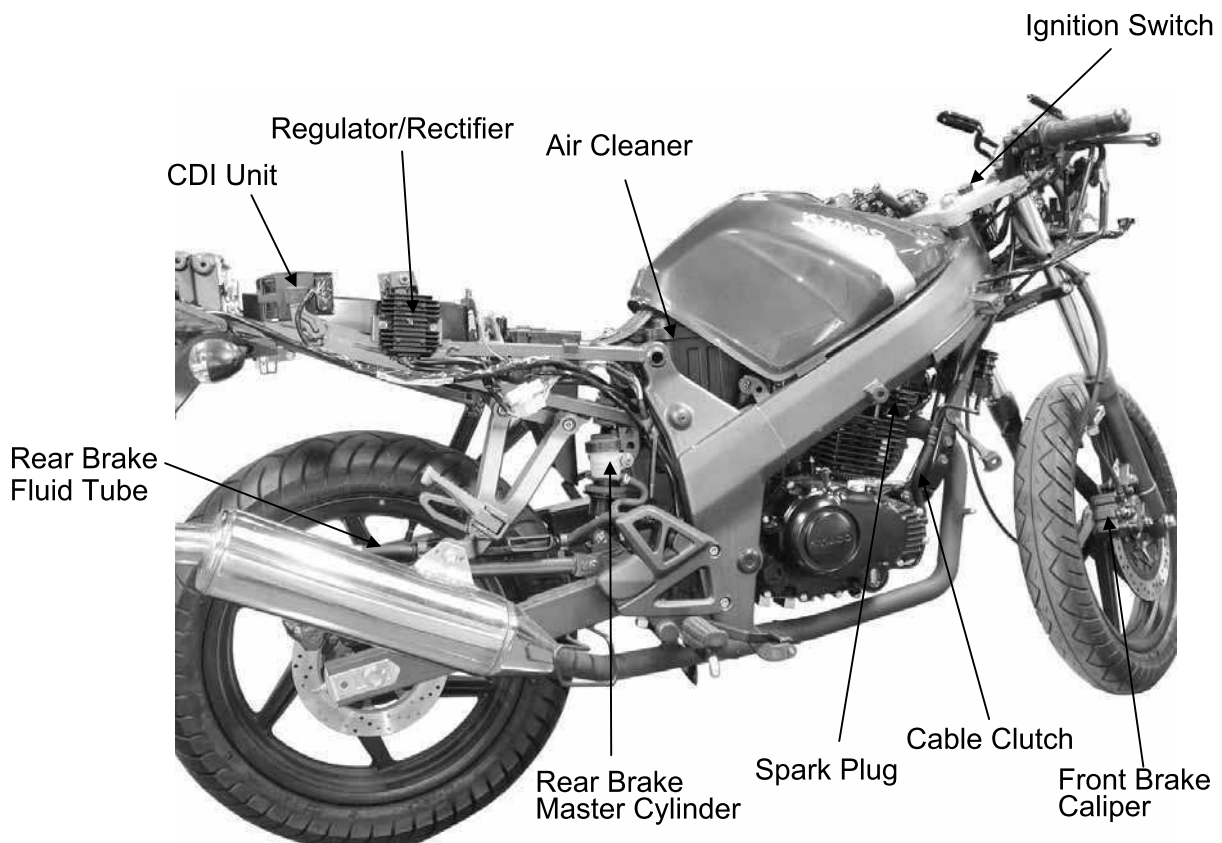
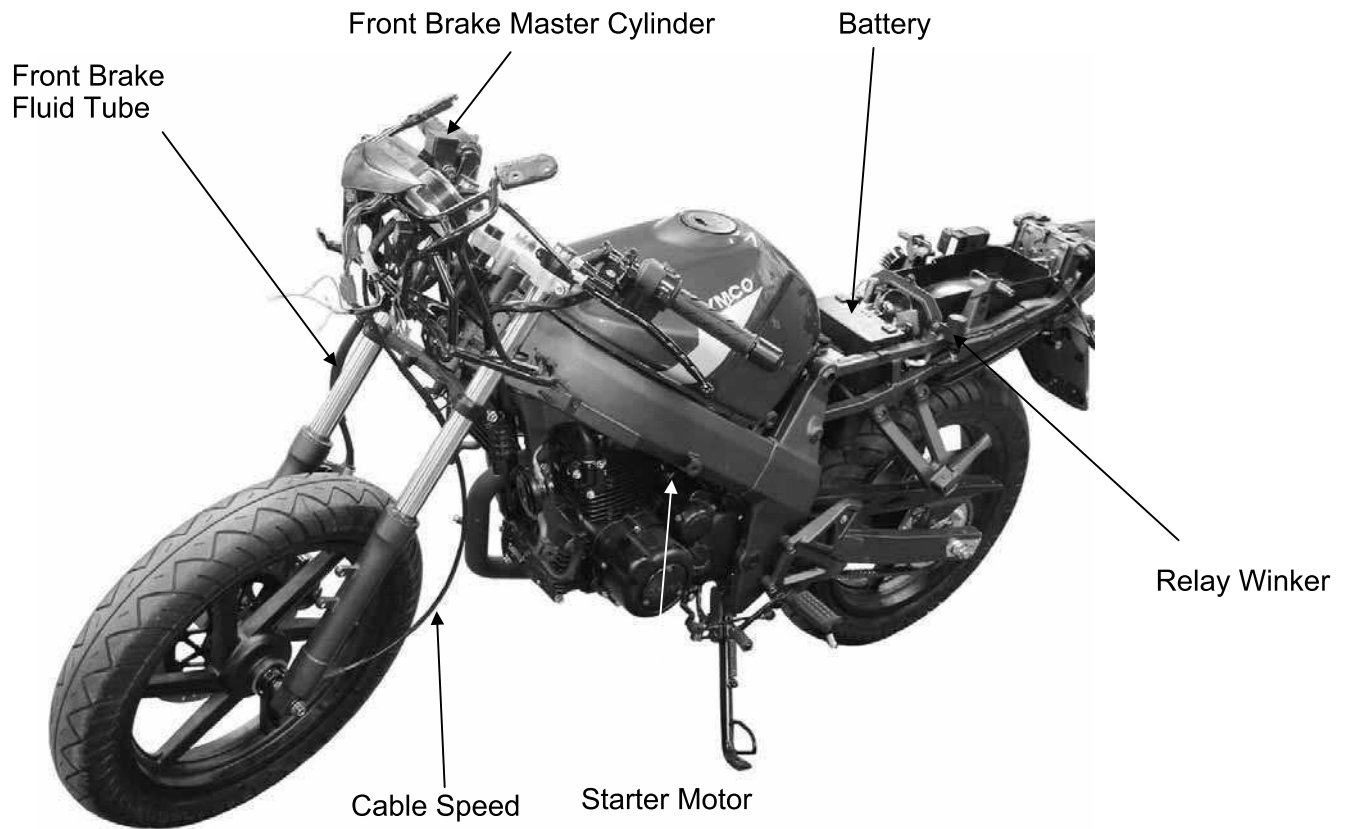

1. GENERAL INFORMATION

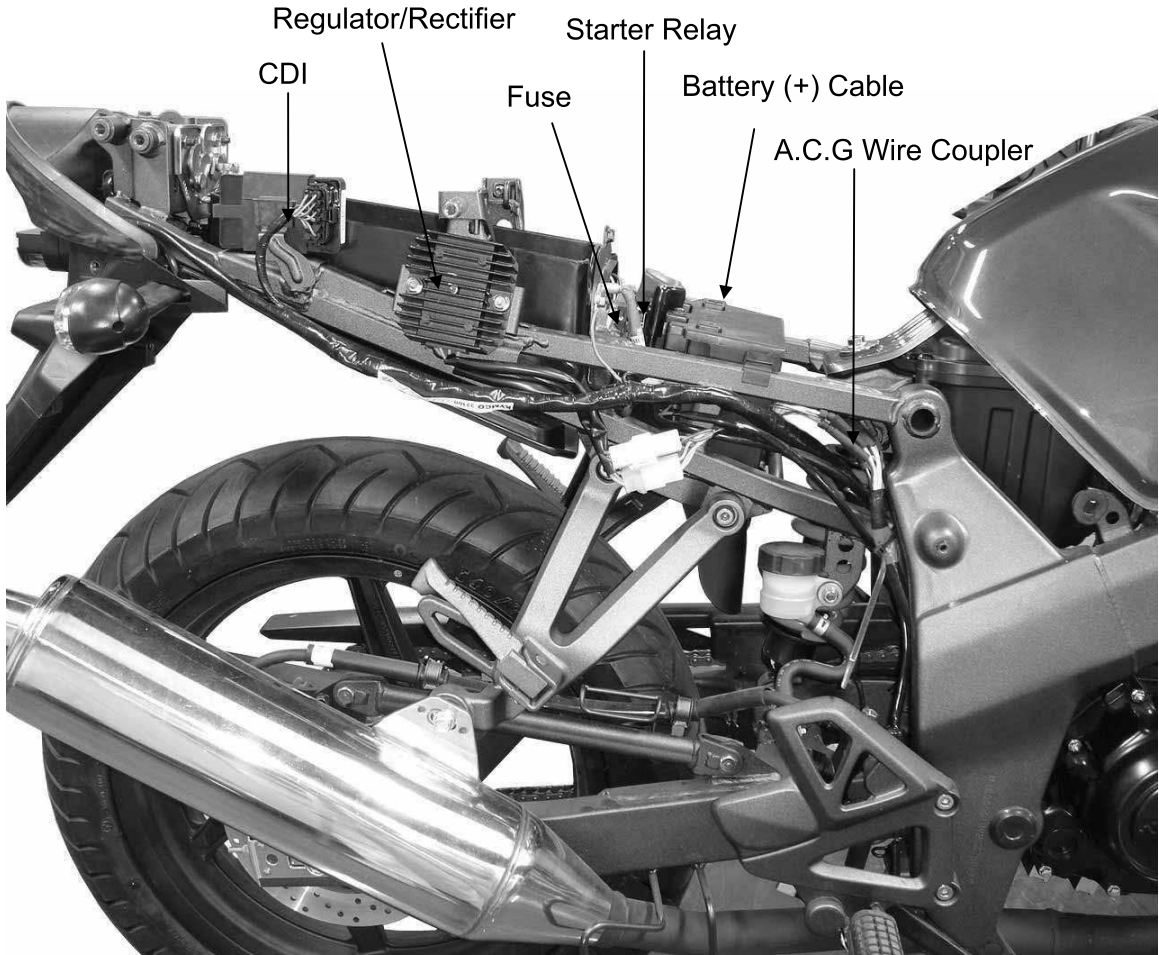

1. GENERAL INFORMATION

TROUBLESHOOTING

ENGINE WILL NOT START OR IS HARD TO START

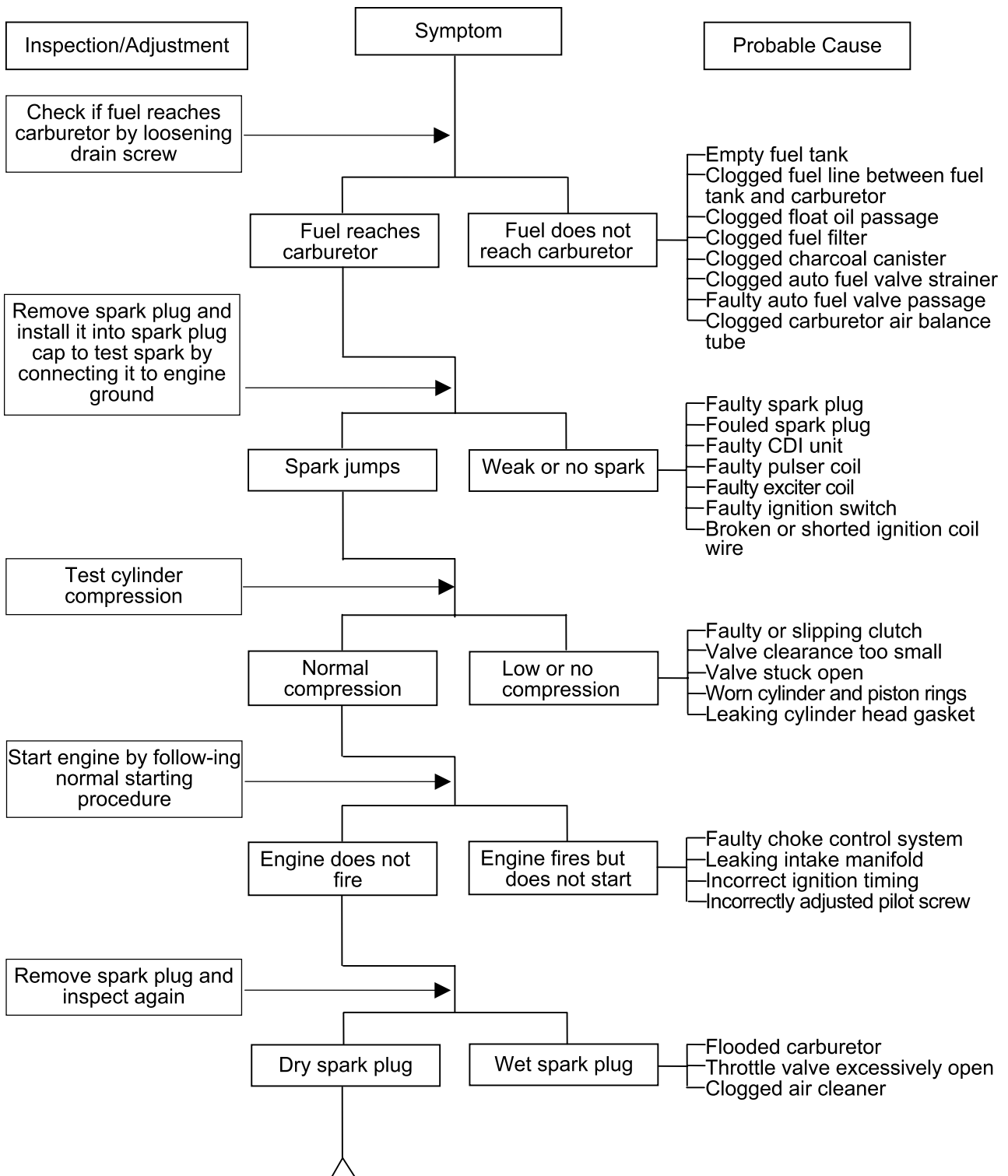

1. GENERAL INFORMATION

POOR PERFORMANCE (ESPECIALLY AT IDLE AND LOW SPEEDS)

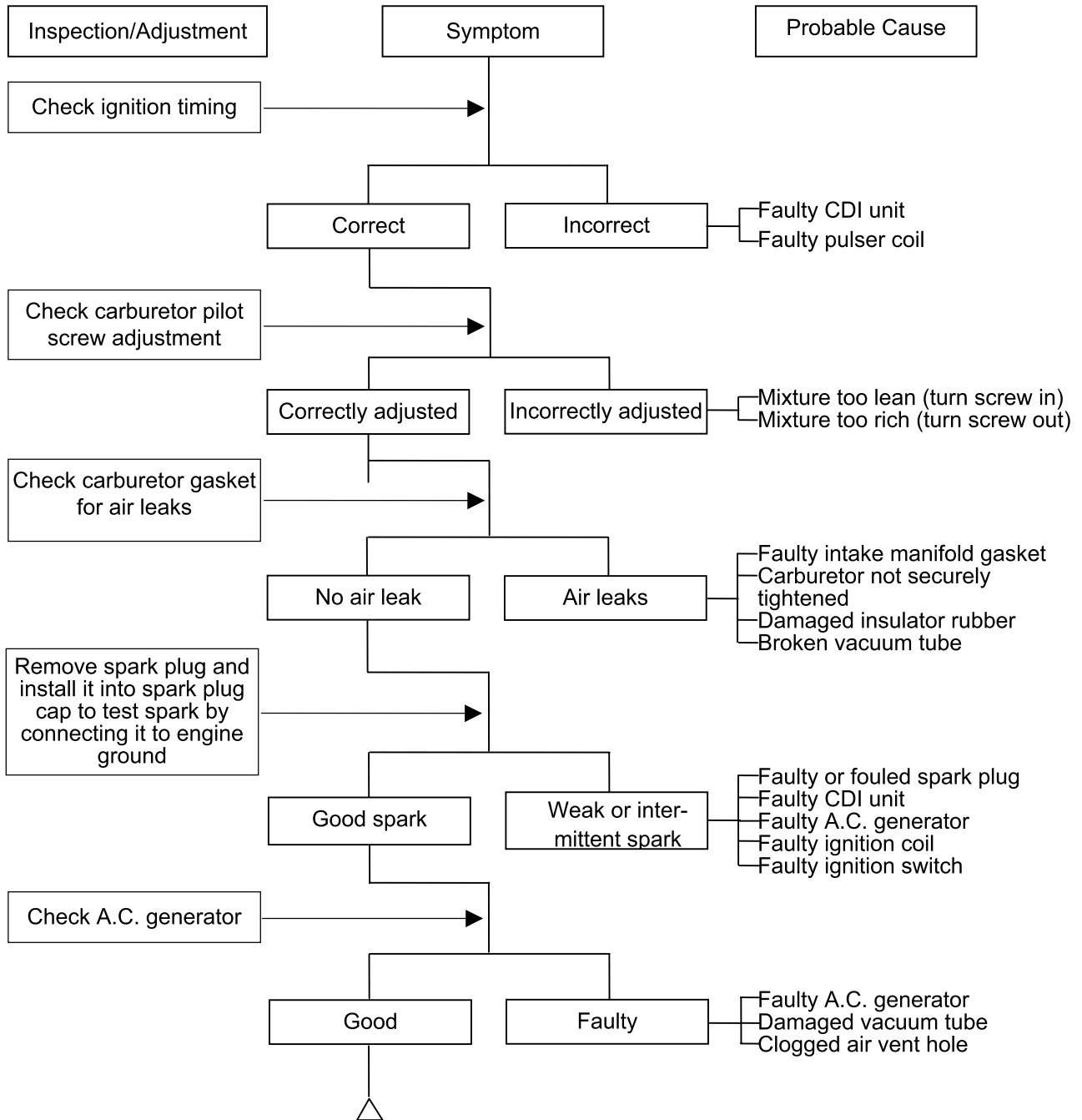

1. GENERAL INFORMATION

POOR PERFORMANCE (ENGINE LACKS POWER)

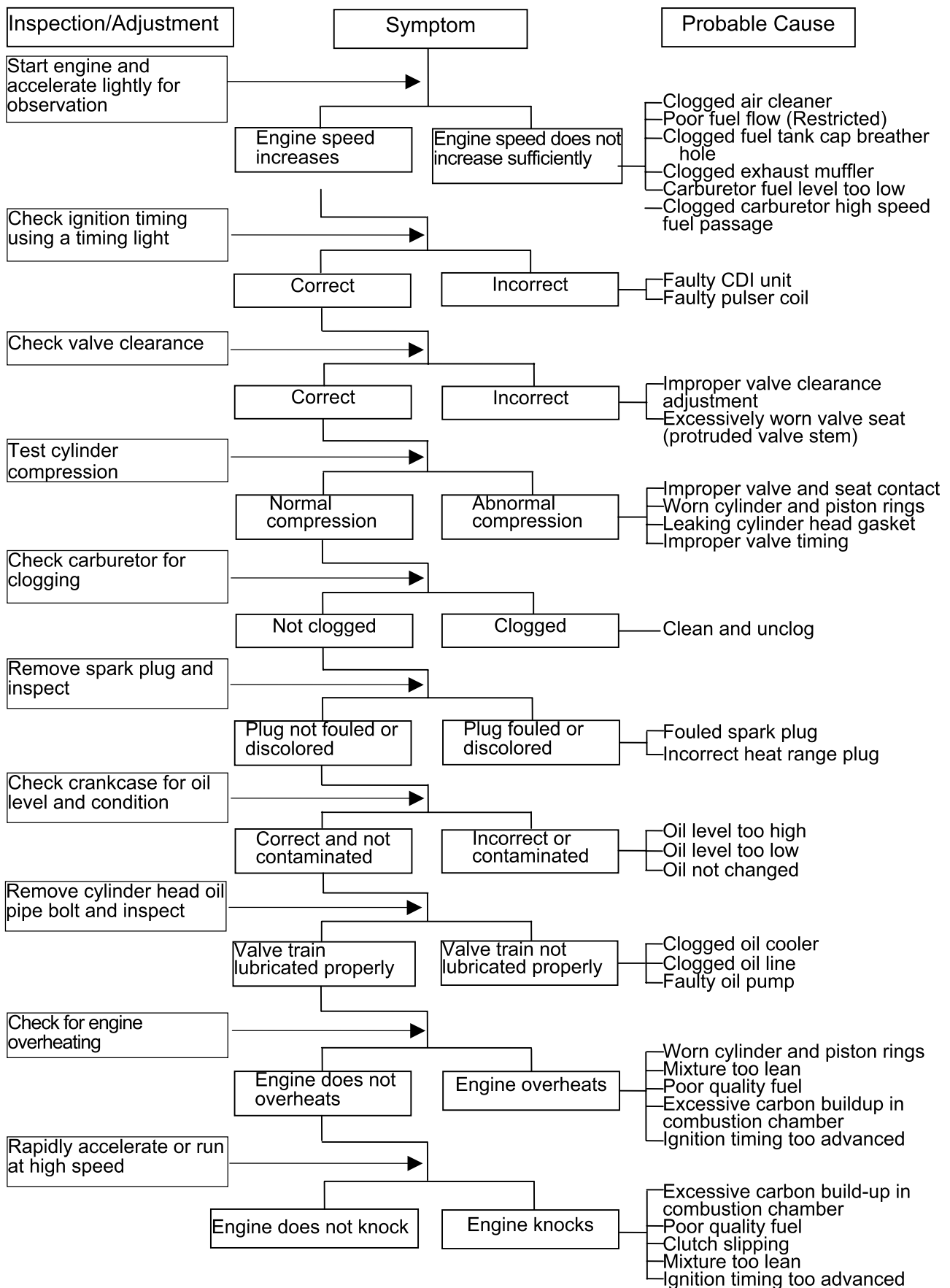

1. GENERAL INFORMATION

POOR PERFORMANCE (AT HIGH SPEED)

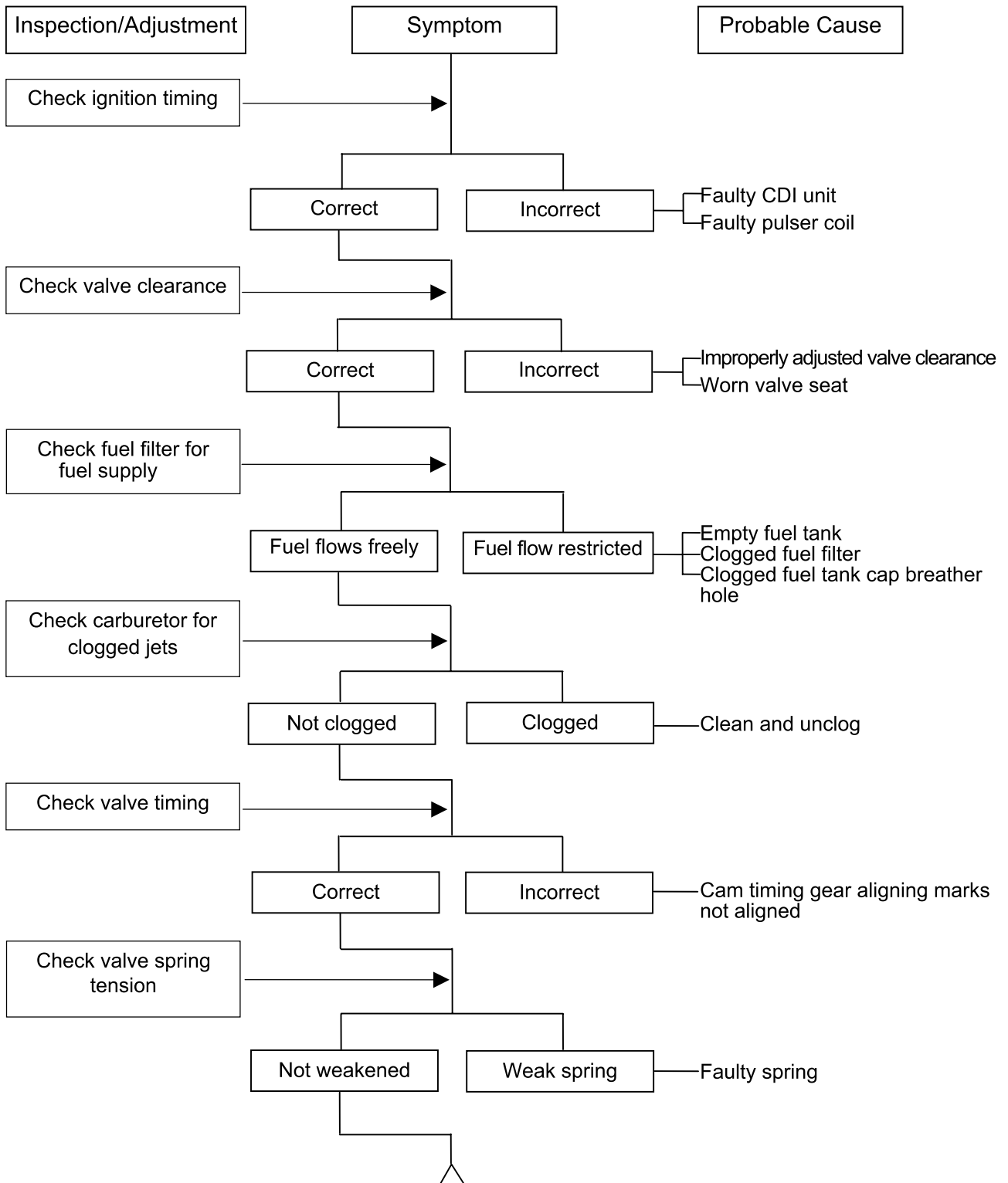

1. GENERAL INFORMATION

POOR CHARGING (BATTERY OVER DISCHARGING OR OVERCHARGING)

Undercharging

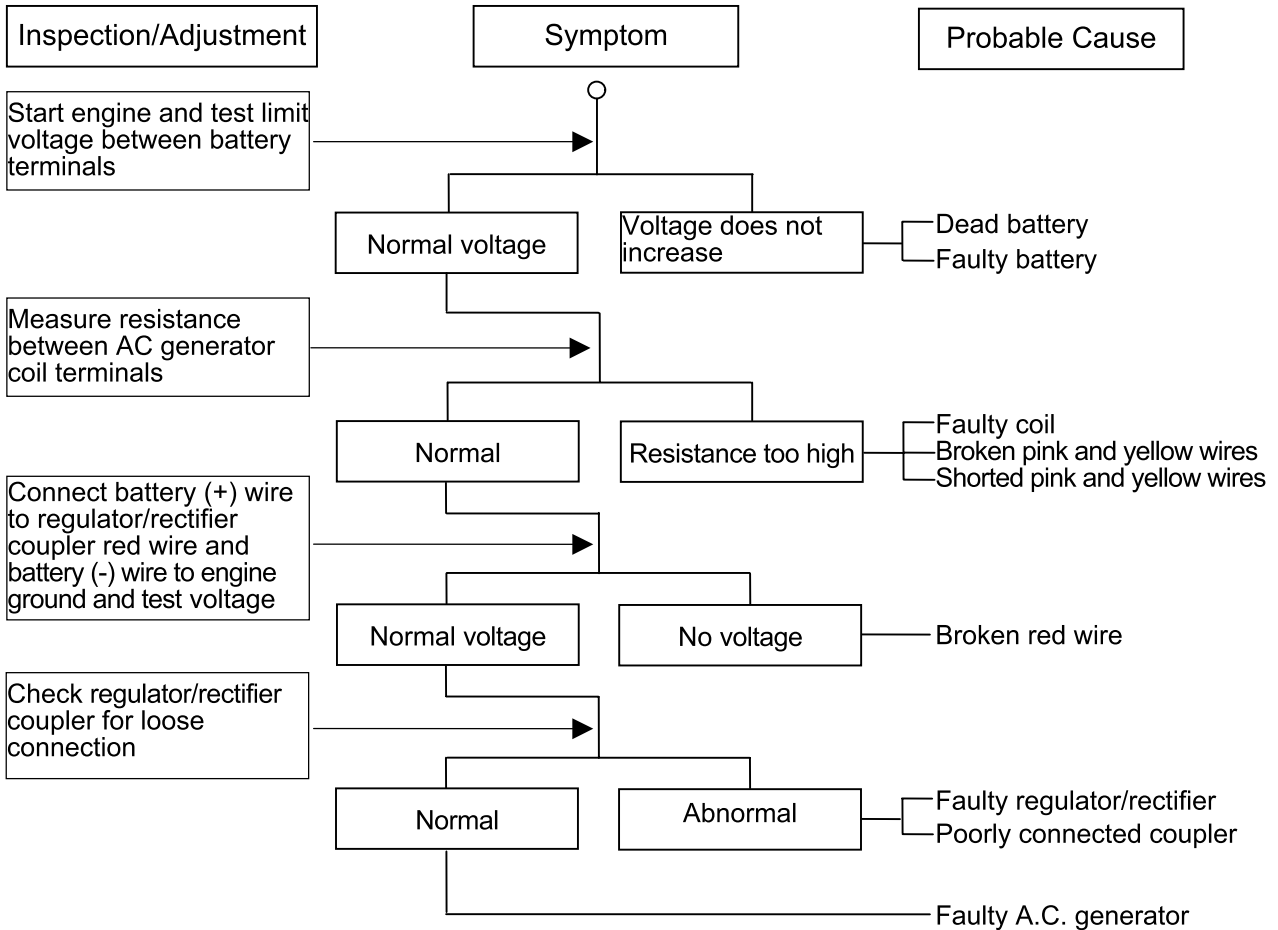

Overcharging

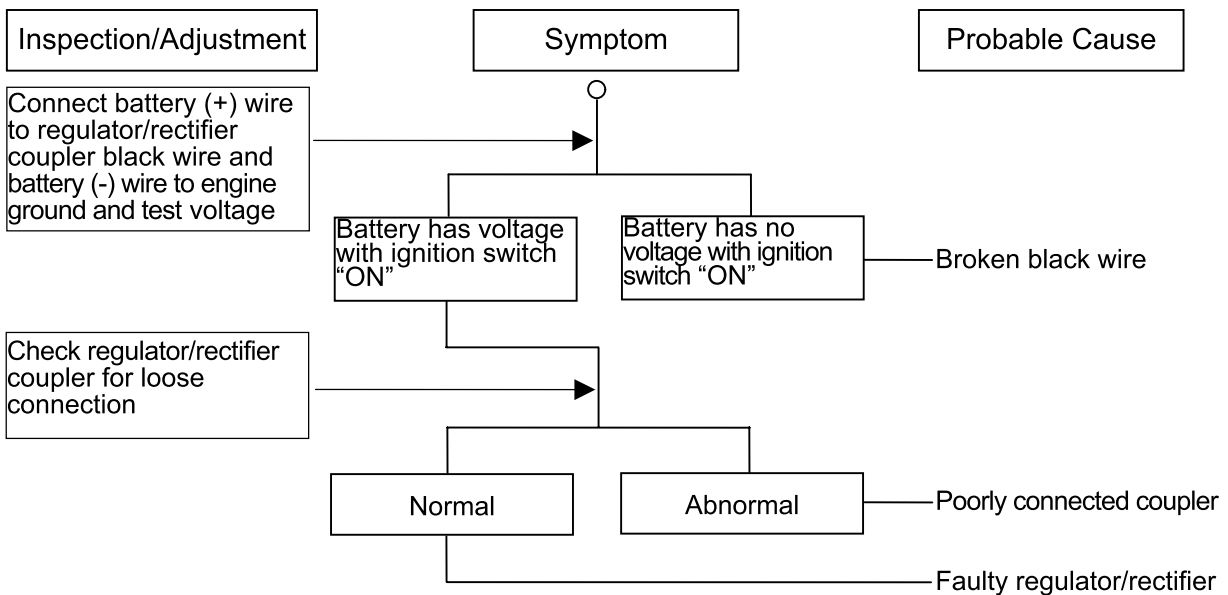

1. GENERAL INFORMATION

NO SPARK AT SPARK PLUG

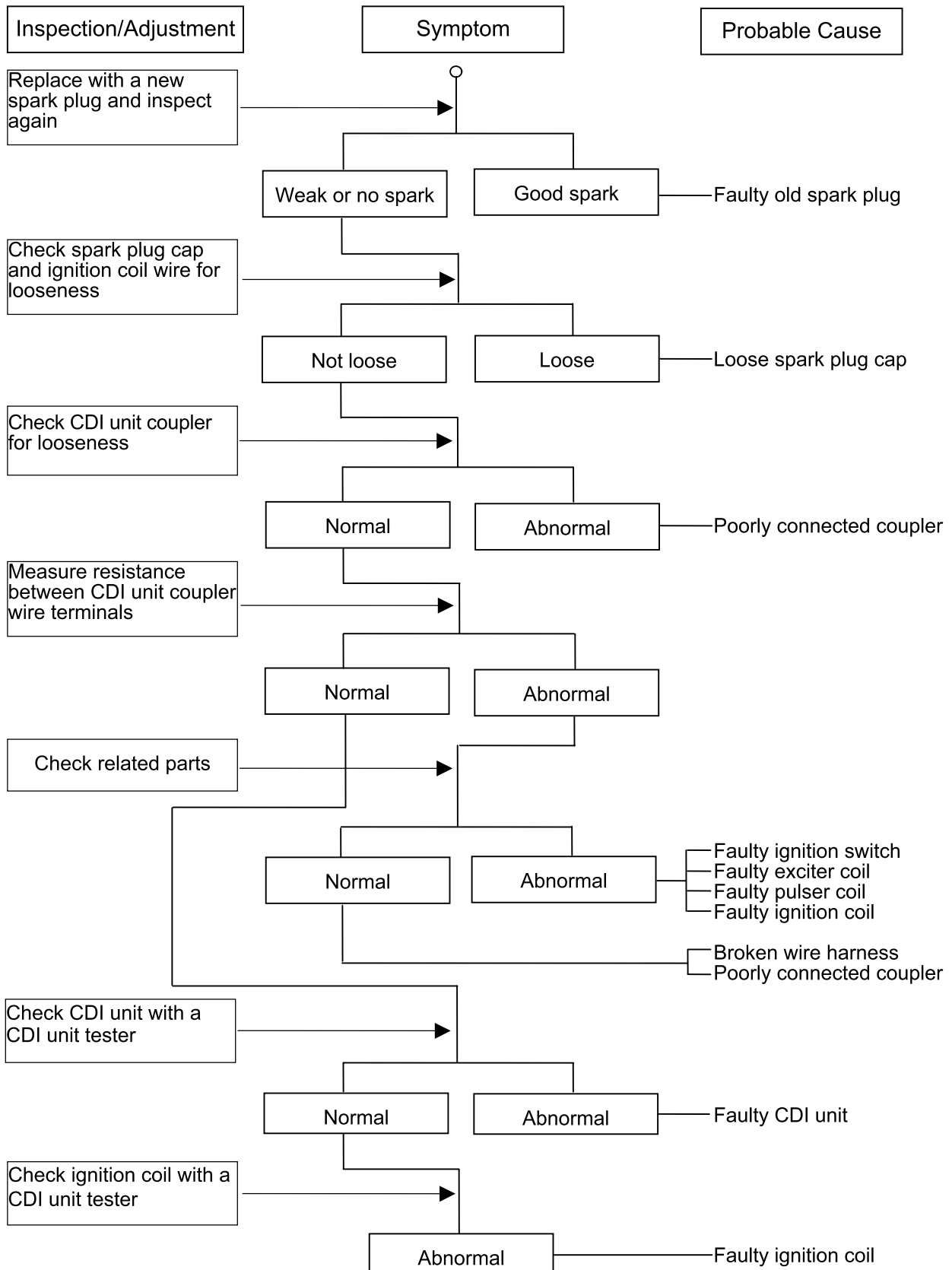

2. INSPECTION/ADJUSTMENT

2

INSPECTION/ADJUSTMENT

SERVICE INFORMATION-----	2- 1
MAINTENANCE SCHEDULE-----	2- 2
FUEL TUBE/FILTER-----	2- 3
THROTTLE OPERATION-----	2- 3
AIR CLEANER-----	2- 4
SPARK PLUG-----	2- 4
VALVE CLEARANCE-----	2- 5
CARBURETOR IDLE SPEED-----	2- 5
IGNITION TIMING-----	2- 6
CYLINDER COMPRESSION-----	2- 6
ENGINE OIL-----	2- 7
DRIVE CHAIN-----	2- 7
BRAKE SHOE/BRAKE PEADAL-----	2- 8
CLUTCH-----	2- 8
BRAKE FLUID-----	2- 8
SUSPENSION-----	2- 9
NUTS/BOLTS/FASTENERS-----	2- 9
WHEELS/TIRES-----	2- 9
STEERING HANDLEBAR-----	2- 10

2. INSPECTION/ADJUSTMENT

MAINTENANCE SCHEDULE

Perform the periodic maintenance at each scheduled maintenance period.

I: Inspect, and Clean, Adjust, Lubricate, Refill, Repair or Replace if necessary.

A: Adjust C: Clean R: Replace T: Tighten

Item	Frequency	Whichever comes first ⇨ ↓	Regular Service Mileage (km)											
			1000	2000	3000	4000	5000	6000	7000	8000	9000	10000	11000	12000
Engine oil			R 300km	R		R		R		R		R		R
Engine oil filter screen				C		C		C		C		C		C
Fuel filter screen								R						R
Valve clearance						A				A				A
Carburetor						I				I				I
Air Cleaner		Note 2,3	C	C		C		R		C		C		R
Spark plug			Clean at every 6000km and replace if necessary											
Brake system			A	A		A		A		A		A		A
Drive chain				A		A		A		A		A		A
Suspension			I							I				
Nuts, bolts, fasteners			T	T		T		T		T		T		T
Tire			I	I		I		I		I		I		I

- In the interest of safety, we recommend these items should be serviced only by an authorized KYMCO motorcycle dealer.

Note: 1. For higher odometer readings, repeat at the frequency interval established here.

2. Service more frequently when riding in dusty or rainy areas.

3. Service more frequently when riding for long distance, in rain or at full throttle.

2. INSPECTION/ADJUSTMENT

FUEL TUBE/FILTER

Check the fuel tube and replace any parts which show signs of deterioration, damage or leakage.

* Do not smoke or allow flames or sparks in your working area.

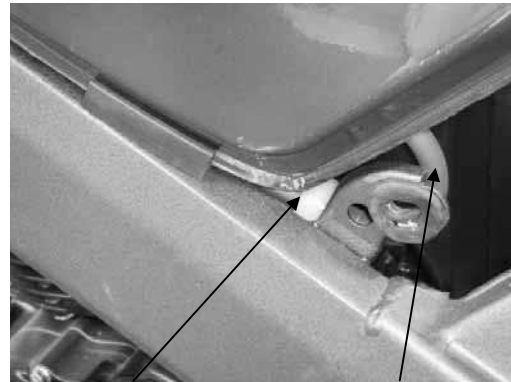

Fuel Filter

Fuel Tube

THROTTLE OPERATION

Check for smooth throttle grip movement in all steering positions.
Measure the throttle grip free play.

Free Play: 2~6mm



Adjust the throttle grip free play by turning the adjusting nut on the throttle cable. Slide the dust boot out and adjust by loosening the lock nut and turning the adjusting nut.



Dust Boot

Adjusting Nut

Lock Nut

Check if the punch mark on the carburetor accelerating pump is aligned.
Align the punch mark by turning the adjusting nut at the accelerating pump cable.

2. INSPECTION/ADJUSTMENT

AIR CLEANER

AIR CLEANER REPLACEMENT

Remove the fuel tank. Remove the six screws attaching the air cleaner cover. Remove the air cleaner cover. Remove the air cleaner of element. Check the element and replace it with a new one if it is excessively dirty or damaged.

Element



CHANGE INTERVAL

More frequent replacement is required when riding in unusually dusty or rainy areas.

- * The air cleaner element has a viscous type paper element. Do not clean it with compressed air.
- Be sure to install the air cleaner element and cover securely.



SPARK PLUG

Remove the spark plug. Check the spark plug for wear, damage and fouling deposits. Clean any fouling deposits with a spark plug cleaner or a wire brush.

Specified Spark Plug: CR8E

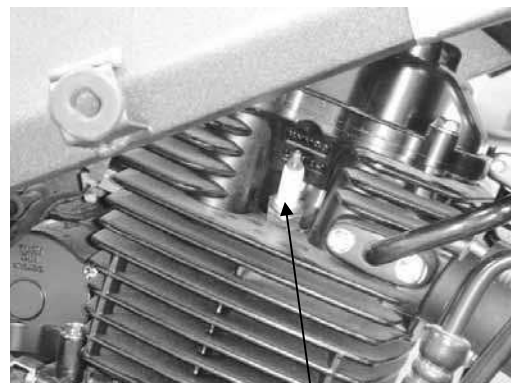

Spark Plug

Gap, Wear, and Fouling Deposits

Measure the spark plug gap.

Spark Plug Gap: 0.6~0.7mm

- * When installing, first screw in the spark plug by hand and then tighten it with a spark plug wrench.

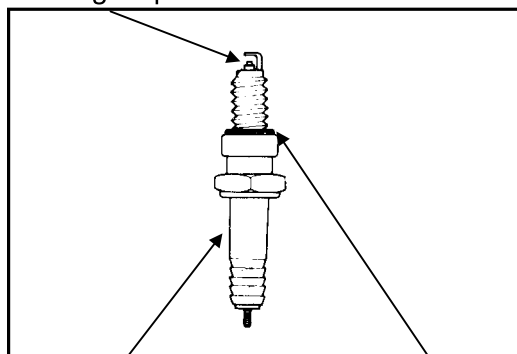

Cracks
Damage

Washer
Deformatio

2. INSPECTION/ADJUSTMENT

VALVE CLEARANCE

- * Inspect and adjust valve clearance while the engine is cold (below 35°C).

Remove the fuel tank.
Remove four bolts on the cylinder head cover.
Remove the cylinder head cover protector.
Remove the cylinder head cover.

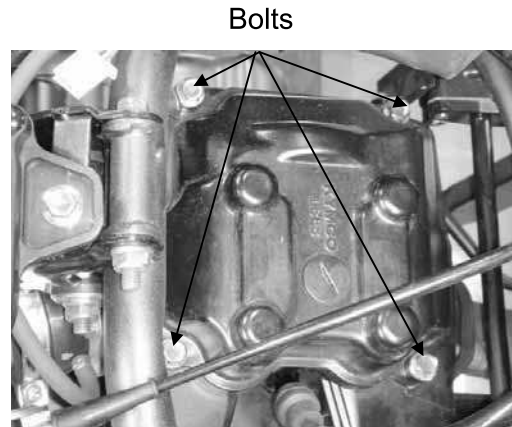

Rotate the generator flywheel to locate the camshaft on the top dead center (TDC) and align the "T" mark on the flywheel with the mark on the left crankcase cover.

- * After adjustment, rotate the crankshaft several turns to make sure that the valve clearance is correct.



Inspect and adjust the valve clearance.

Valve Clearance: IN : 0.06mm
EX: 0.06mm

Loosen the lock nut and adjust by turning the adjusting bolt.

Special Tool

Tappet Adjust E012

- * Check the valve clearance again after the lock nut is tightened.

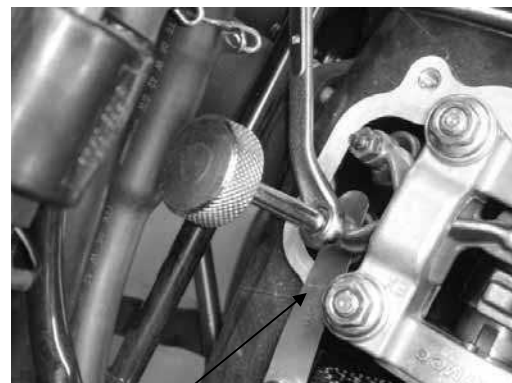

CARBURETOR IDLE SPEED

- * The engine must be warm for accurate idle speed inspection and adjustment.

Turn the throttle stop screw to obtain the specified idle speed.

Idle Speed: 1600±100rpm

When the engine misses or run erratic, adjust the pilot screw.

- * When adjusting the carburetor, make sure to use the E/M tester.

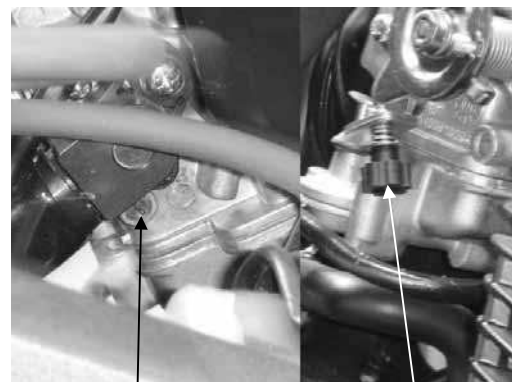

2. INSPECTION/ADJUSTMENT

IGNITION TIMING

- *
 - The CDI unit is not adjustable.
 - If the ignition timing is incorrect, check the ignition system.

Remove the ignition timing eyes hole cap on the left crankcase cover.

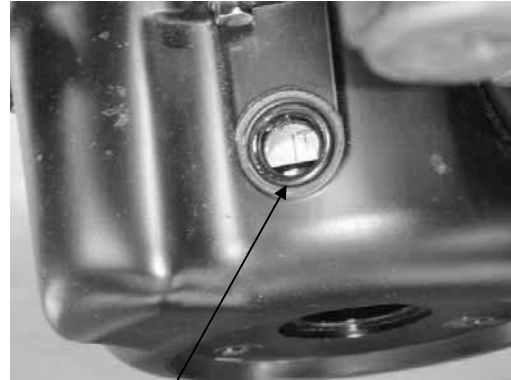

Eyes Hole

Check the ignition timing with a timing light. When the engine is running at idle speed, the ignition timing is correct if the index mark on the left crankcase cover aligns with the "F" mark on the flywheel.

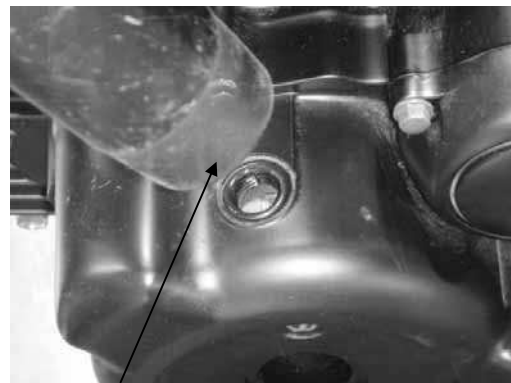

Timing Light

"F" Mark

CYLINDER COMPRESSION

Warm up the engine before compression test.

Stop the engine, then remove the spark plug and insert a compression gauge. Open the throttle valve fully and crank the engine with the starter motor or kick lever. Measure the compression.

Compression: 13kg/cm



Compression Gauge

If the compression is low, check for the following:

- Leaky valves
- Valve clearance too small
- Leaking cylinder head gasket
- Worn piston rings
- Worn piston/cylinder

If the compression is high, it indicates that carbon deposits have accumulated on the combustion chamber and the piston head.



2. INSPECTION/ADJUSTMENT

ENGINE OIL

- * When checking the oil level, place the motorcycle on its main stand on level ground for oil level check.

After the engine is stopped for 10 minutes, check if the oil level is between the upper and lower limits through the watch window. If the oil level is low, add the recommended oil to the proper level.

Recommended Oil: SAE15W40#

After oil change, be sure to tighten the drain bolt securely.

Check the drain bolt washer for damage.

Oil Capacity: At disassembly : 1.1 liter
At change : 1.0 liter

Engine Oil Filter Screen Cleaning

Remove the oil filter screen cap.

Remove the oil filter screen and spring and then clean with compressed air.

- * Be careful not to install the oil filter screen in the reverse direction to avoid engine damage.

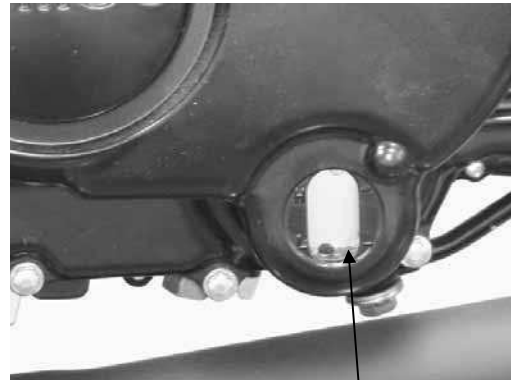

Watch Window

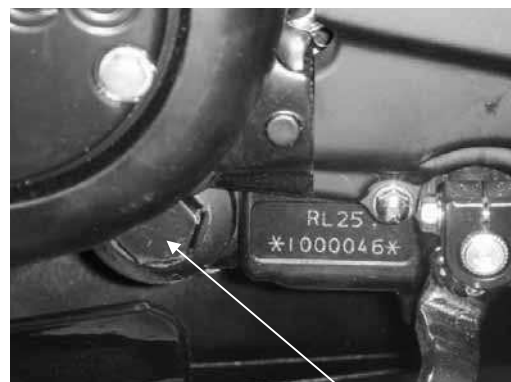

Oil Filter Screen Cap

Rear Axle Nut

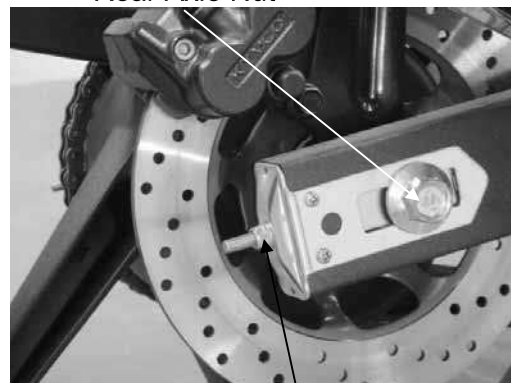

Adjusting Nut

DRIVE CHAIN

Check the drive chain slack.

Specified Slack: 1~2cm

Drive Chain Adjustment:

1. Loosen the rear axle nut.
2. Adjust the right and left adjusting nuts to align the right punch mark with the left punch mark.
3. The rear wheel turn to see if the drive chain slack is within the specified range.
4. Tighten the rear axle nut.

- * After drive chain adjustment, check the rear brake pedal free play and adjust if necessary.

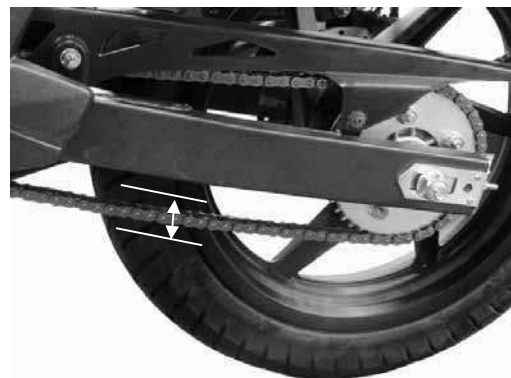

2. INSPECTION/ADJUSTMENT

BRAKE SHOE

Inspect the front brake linings for wear.



BRAKE LEVER/PEDAL

Measure the rear brake pedal free play.

Free Play: 10~20mm

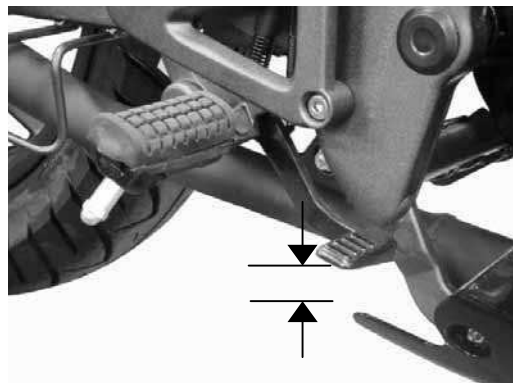

Adjusting Nut Lock Nut

CLUTCH

Measure the clutch lever free play.

Free Play: 10~20mm

When minor adjustment is required, adjust by turning the adjusting nut on the clutch lever side.

When major adjustment is required, adjust by turning the adjusting nut on the clutch cable from the right crankcase cover.

Adjust by loosening the lock nut and turning the adjusting nut. After adjustment, tighten the lock nut.

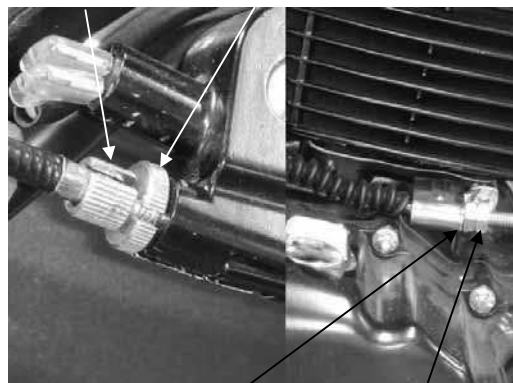

Adjusting Nut Lock Nut

BRAKE FLUID

Turn the steering handlebar upright and check if the brake fluid level is between the upper and lower limits.

Specified Brake Fluid: DOT-3 or DOT-4

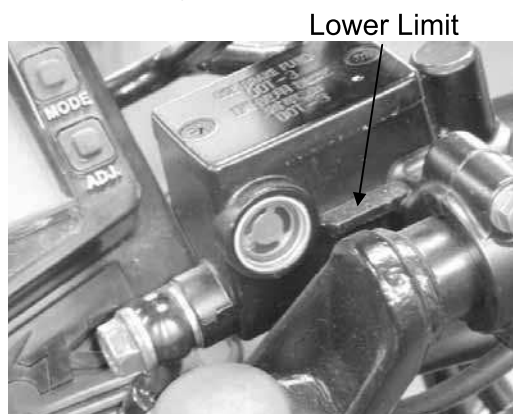

Lower Limit

2. INSPECTION/ADJUSTMENT

SUSPENSION

FRONT

Fully apply the front brake lever and check the action of the front shock absorbers by compressing them several times.
Check the entire shock absorber assembly for oil leaks, looseness or damage.

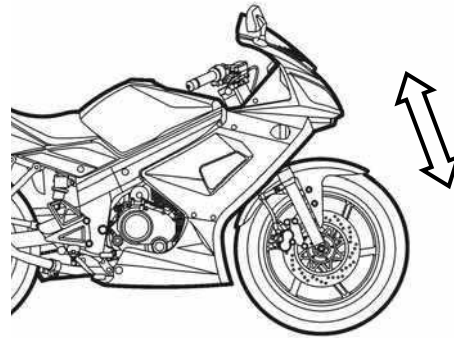

REAR

Check the action of the rear shock absorber by compressing it several times.
Check the entire shock absorber assembly for oil leaks, looseness or damage.
Jack the rear wheel off the ground and move the rear wheel sideways with force to see if the engine hanger bushings are worn.

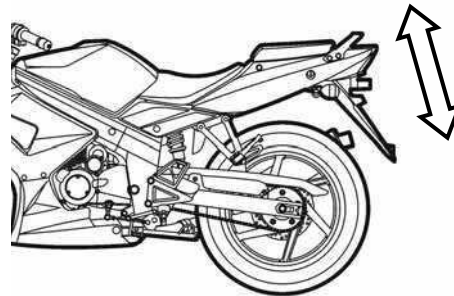

NUTS/BOLTS/FASTENERS

Check all important chassis nuts and bolts for looseness.
Tighten them to their specified torque values if any looseness is found.

WHEELS/TIRES

Check the tires for cuts, imbedded objects or other damages.
Check the tire pressure.

* Tire pressure should be checked when tires are cold.

TIRE PRESSURE

	1 Rider	2 Riders
Front	1.75kg/cm ²	1.75kg/cm ²
Rear	2.00kg/cm ²	2.25kg/cm ²

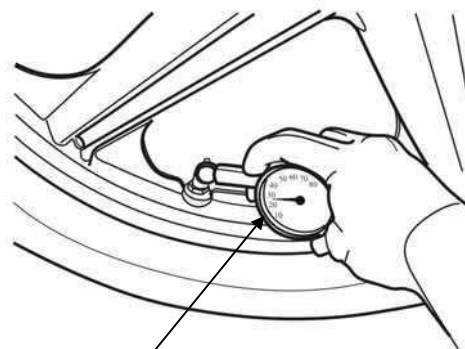

Tire Pressure Gauge

TIRE SIZE

Front	110/80-17
Rear	140/70-17

2. INSPECTION/ADJUSTMENT

Check the front and rear axle nuts for looseness.

If the axle nuts are loose, tighten them to the specified torques.

Torques: Front : 5.5~7.0kg-m

Rear : 6.0~8.0kg-m

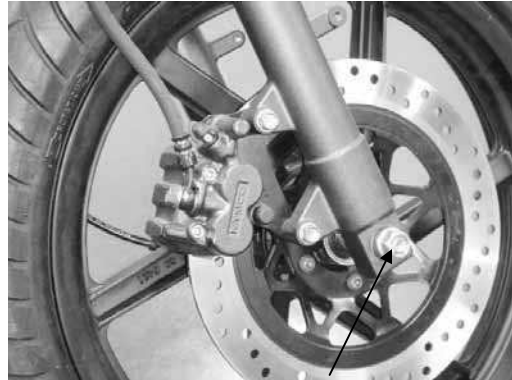

Front Axle Nut

STEERING HANDLEBAR

Check that the control cables do not interfere with handlebar rotation.

Raise the front wheel off the ground and check that the steering handlebar rotates freely.

If the handlebar moves unevenly, binds, or has vertical movement, adjust the steering head bearing.

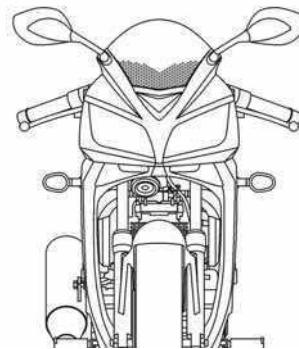

3. LUBRICATION SYSTEM

3

SERVICE INFORMATION-----	3- 2
TROUBLESHOOTING -----	3- 2
ENGINE OIL/OIL FILTER SCREEN -----	3- 3
OIL PUMP/OIL FILTER ROTOR-----	3- 4

3. LUBRICATION SYSTEM

LUBRICATION SYSTEM

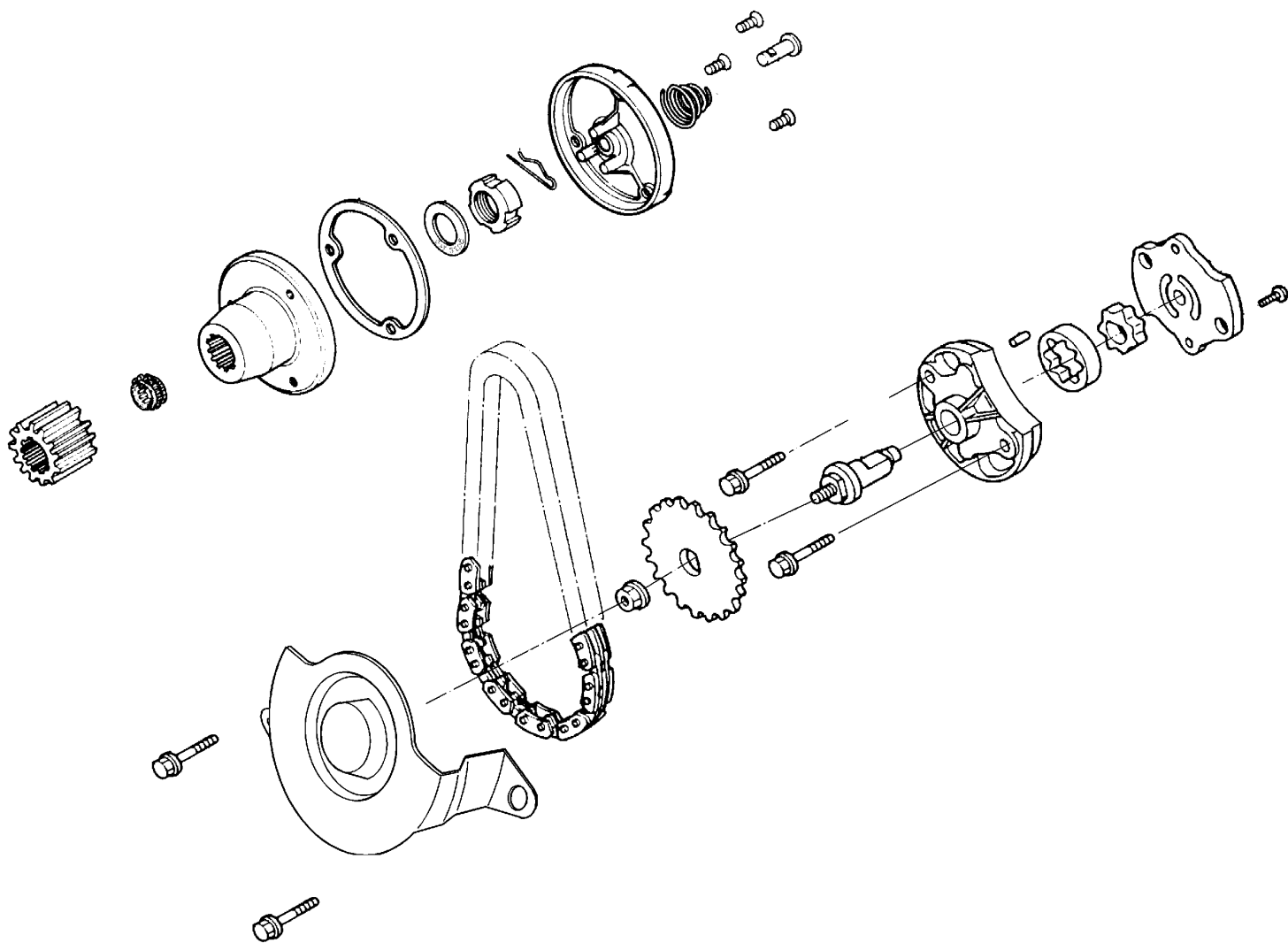

3. LUBRICATION SYSTEM

SERVICE INFORMATION

GENERAL INSTRUCTIONS

- The service and maintenance of this section can be performed with the engine installed in the frame.
- Use care when removing and installing the oil pump not to allow dust and foreign matters to enter the engine and oil line.
- The oil pump must be replaced as a set when it reaches its service life.
- After the oil pump is installed, check each part for oil leaks and improper lubrication.
- When removing and installing the oil cooler, be careful not to bend or deform the oil pipe.

SPECIFICATIONS

Item		Standard (mm)	Service Limit (mm)
Oil pump	Inner rotor-to-outer rotor clearance	—	0.20
	Outer rotor-to-pump body clearance	—	0.20
	Rotor end-to-pump body clearance	0.015~0.10	0.15

TROUBLESHOOTING

Oil level too low

- Natural oil consumption
- Oil leaks
- Worn or poorly installed piston rings
- Worn valve guide or seal
- Clogged or leaky oil pipe

Engine burns

- Low or no lubrication pressure
- Clogged oil passages
- Not use the specified oil

3. LUBRICATION SYSTEM

ENGINE OIL/OIL FILTER

OIL LEVEL

- * Place the motorcycle upright on level ground for engine oil level check.
- * Run the engine for 2~3 minutes and check the oil level after the engine is stopped for 2~3 minutes.

Check the oil level through the watch window. If the level is near the lower limit, fill to the upper limit with the specified engine oil.

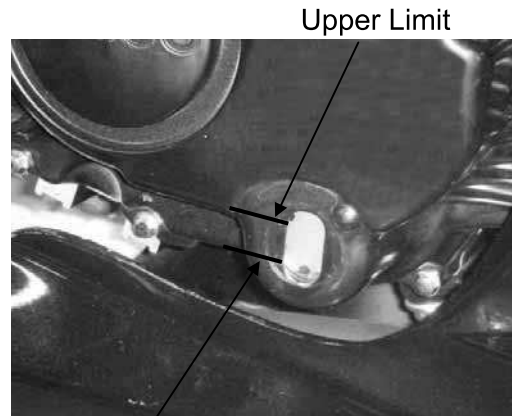

Lower Limit

OIL CHANGE

- * The engine oil will drain more easily while the engine is warm.

Remove the drain bolt to drain the engine oil thoroughly.

Check the drain bolt washer for damage or deformation and replace with a new one if necessary.

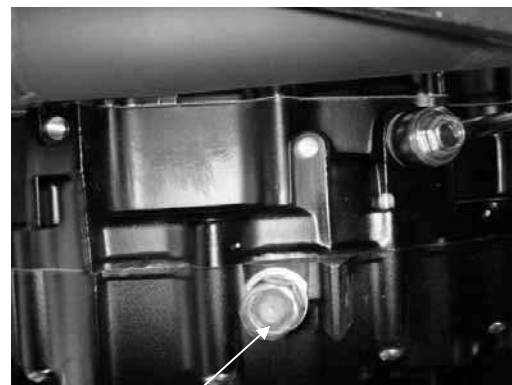

Drain Bolt

Remove the oil filter screen cap and then remove the oil filter screen and spring. Clean the oil filter screen with compressed air.

Check the filter screen cap O-ring for damage or deformation and replace if necessary.

Install the oil filter screen, spring and filter screen cap.

Torque: 1.5kg-m

- * Do not install the oil filter screen upside down.

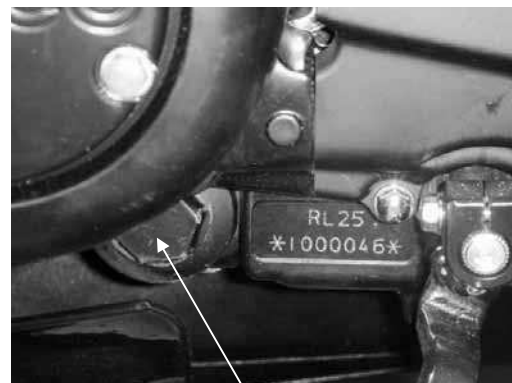

Oil Filter Screen Cap

Oil Capacity: At disassembly : 1.1 liter

At change : 1.0 liter

Check for oil leaks and then start the engine and let it idle for few minutes.

Stop the engine and recheck the oil level.

3. LUBRICATION SYSTEM

OIL PUMP/OIL FILTER ROTOR

REMOVAL

1. Disconnect the clutch cable.
2. Remove the right crankcase cover 13 bolts and right crankcase cover.
3. Check the cover gasket, oil seal and O-ring for oil leaks or damage. Replace with new ones if necessary.

* When installing, make sure to use a new right crankcase cover gasket.

Remove the three screws attaching the oil filter rotor cover to remove the cover.
Remove the oil filter rotor lock nut with a square socket and then remove the washer and oil filter rotor.
Remove the oil pump cap two bolts.

* During installation, install the washer with the mark "OUTSIDE" facing up.

Remove the 6mm nut on top of the oil pump driven gear.

Remove the oil pump driven gear and chain.
Remove the oil pump mounting two bolts.
Remove the oil pump body.

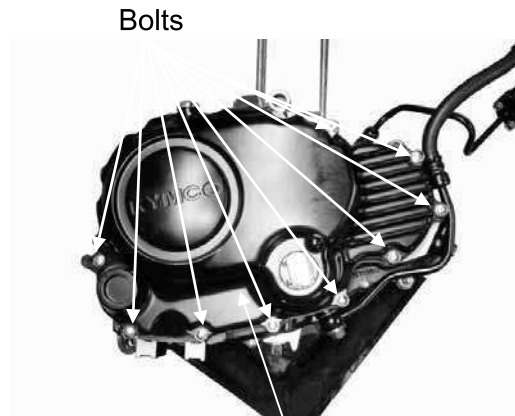

Bolts

Right Crankcase Cover

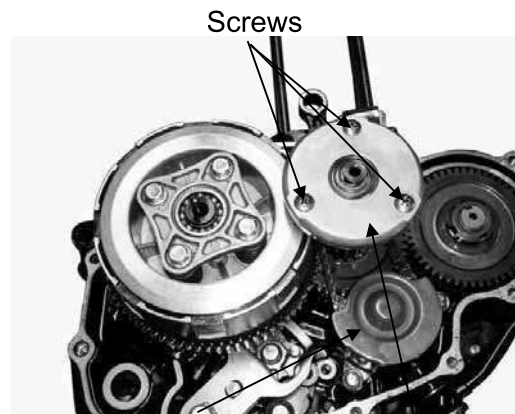

Screws

Oil Pump

Oil Filter Rotor



Oil Pump Driven Gear

Oil Pump Body

Drive Gear



Bolts

3. LUBRICATION SYSTEM

DISASSEMBLY

Remove the pump cover attaching screw.

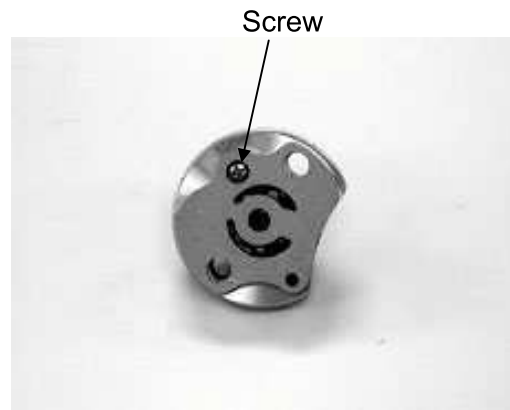

INSPECTION

Measure the pump body-to-outer rotor clearance.

Service Limit: 0.20mm

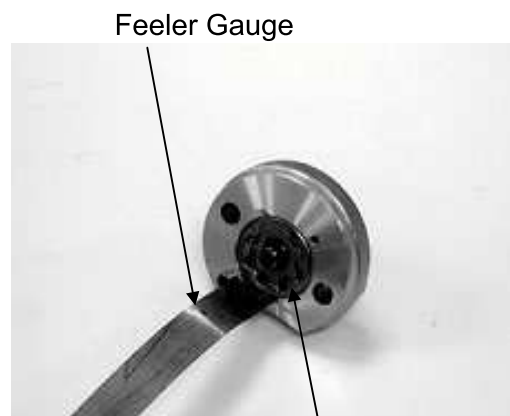

Measure the inner rotor-to-outer rotor clearance.

Service Limit: 0.20mm

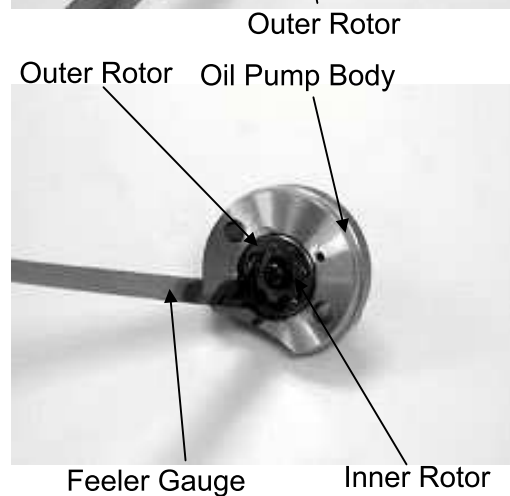

Measure the rotor end-to-pump body clearance.

Service Limit: 0.15mm

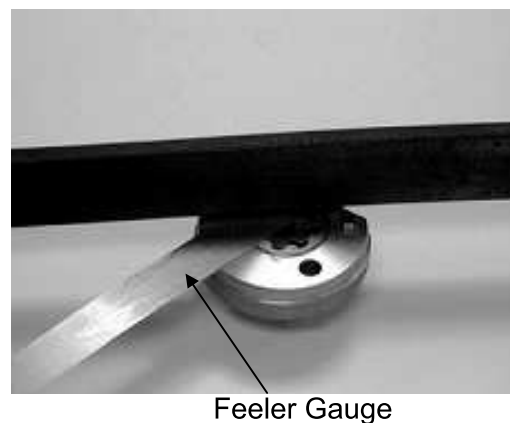

3. LUBRICATION SYSTEM

ASSEMBLY

Install the outer rotor and inner rotor into the pump body. Insert the pump shaft.

* Insert the pump shaft by aligning the flat on the shaft with the flat in the inner rotor.

Install the pump cover.
Tighten the screw.
After installation, make sure that the pump shaft rotates freely.

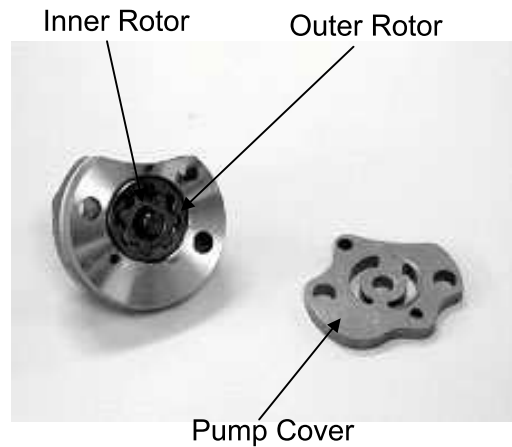

INSTALLATION

Install the pump body and tighten the two mounting bolts.
Install the oil pump driven gear and chain.

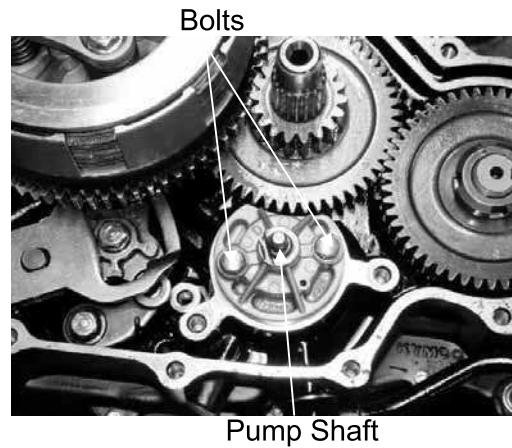

Tighten the 6mm nut on top of the oil pump driven gear.

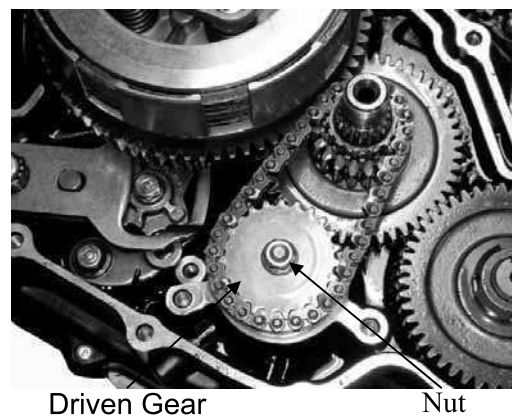

Install the oil pump gear cover and tighten the two bolts.
Install the oil filter rotor lock nut.

Torque: 4.0~5.0kg-m

* During installation, install the washer with the mark "OUTSIDE" facing up.

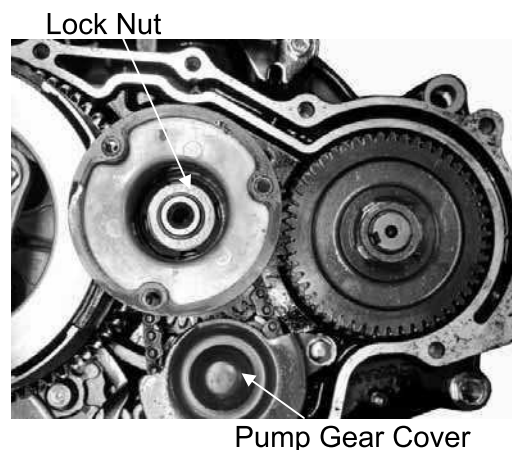

4. FUEL SYSTEM

4

FUEL SYSTEM

SERVICE INFORMATION-----	4-2
TROUBLESHOOTING -----	4-3
THROTTLE CABLE DISASSEMBLY -----	4-4
CARBURETOR REMOVAL -----	4-4
FLOAT/FLOAT VALVE/JETS/ACCELERATING PUMP -----	4-5
FLOAT LEVEL INSPECTION -----	4-7
CARBURETOR INSTALLATION -----	4-8
THROTTLE VALVE ASSEMBLY -----	4-9
AIR CUT-OFF VALVE(A.C.V.) -----	4-9
FUEL TANK -----	4-10
AIR CLEANER REMOVAL -----	4-10

4. FUEL SYSTEM

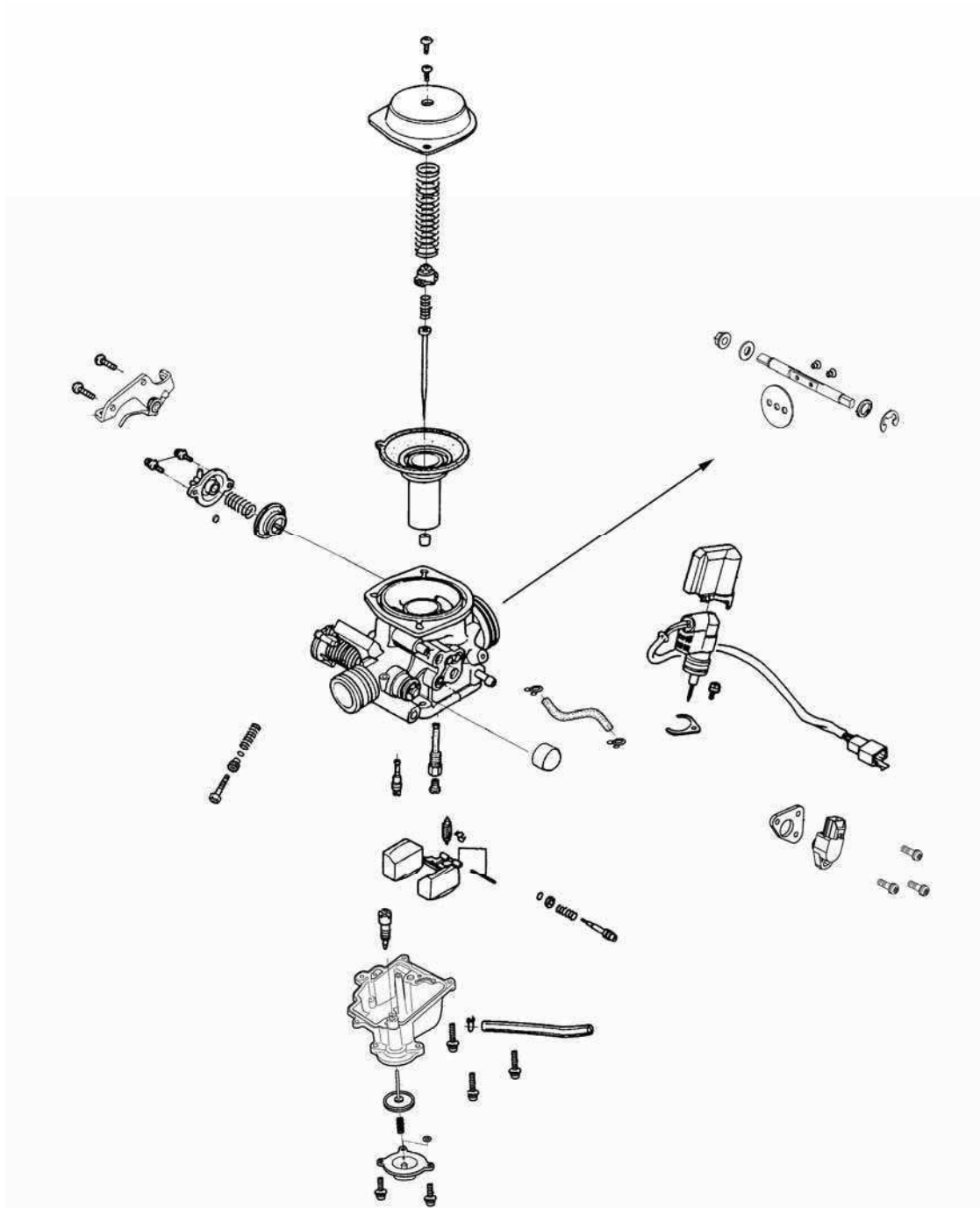

4. FUEL SYSTEM

SERVICE INFORMATION

GENERAL INSTRUCTIONS



Gasoline is very dangerous. When working with gasoline, keep sparks and flames away from the working area.
Gasoline is extremely flammable and is explosive under certain conditions. Be sure to work in a well-ventilated area.

- Do not bend or twist control cables. Damaged control cables will not operate smoothly.
- When disassembling fuel system parts, note the locations of O-rings. Replace them with new ones during reassembly.
- Before float chamber disassembly, loosen the drain screw to drain the residual gasoline into a clean container.
- After the carburetor is removed, plug the intake manifold side with a clean shop towel to prevent foreign matters from entering.
- The carburetor air jets and fuel jets must be cleaned with compressed air.
- When the motorcycle is not used for over one month, drain the residual gasoline from the float chamber to avoid erratic idling and clogged slow jet due to deteriorated fuel.

SPECIFICATIONS

Item	Standard
Type	CVK
Venturi dia.	φ25
Float level	17 mm
Main jet	108#
Slow jet	35#
Idle speed	1600±100rpm
Throttle grip free play	2~6mm
Pilot screw opening	2±½

4. FUEL SYSTEM

TROUBLESHOOTING

Engine cranks but won't start

- No fuel in tank
- No fuel to carburetor
- Cylinder flooded with fuel
- No spark at plug
- Clogged air cleaner
- Intake air leak
- Improper throttle operation

Engine idles roughly, stalls or runs poorly

- Excessively used choke
- Ignition malfunction
- Faulty carburetor
- Poor quality fuel
- Lean or rich mixture
- Clogged air cleaner
- Incorrect idle speed
- Faulty charcoal canister

Misfiring during acceleration

- Faulty ignition system
- Faulty carburetor
- Faulty accelerating pump
- Faulty charcoal canister

Backfiring at deceleration

- Float level too low
- Incorrectly adjusted carburetor
- Faulty A.C.V.
- Faulty exhaust muffler
- Faulty A.I.C.V.

Engine lacks power

- Clogged air cleaner
- Faulty carburetor
- Faulty ignition system

Lean mixture

- Clogged carburetor fuel jets
- Float level too low
- Intake air leak
- Faulty charcoal canister
- Restricted fuel line

Rich mixture

- Float level too low
- Clogged air jets
- Clogged air cleaner
- Restricted A.C.V. tube
- Worn throttle needle

4. FUEL SYSTEM

THROTTLE CABLE DISAASEMBLY

Remove the fuel tank.
Loosen the air cleaner connecting tube band screws then remove the air cleaner.

Air Cleaner



Intake Manifold Band

Loosen the throttle cable adjusting nut and lock nut, then disconnect the throttle cable from the carburetor.

Throttle Cable

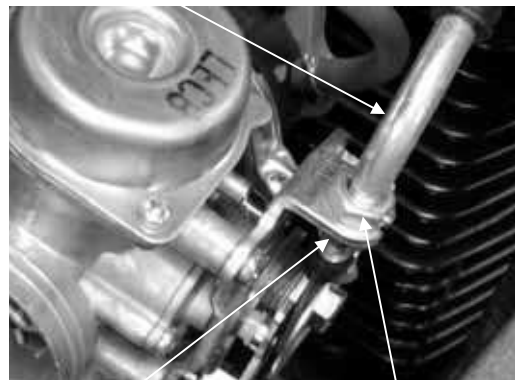

Lock Nut

Adjusting Nut

Loosen the drain screw and drain the fuel from the float chamber.
Disconnect the fuel tube and vacuum tube at the carburetor.
Loosen the carburetor intake manifold band and remove the carburetor.
Disconnect the auto bystarter wire coupler and P.T.S wire coupler.

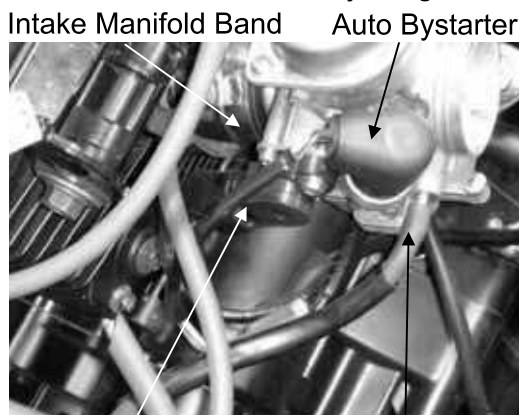

Intake Manifold Band

Auto Bystarter

P.T.S

Fuel Tube

CARBURETOR REMOVAL

Loosen the drain screw to drain the gasoline from the float chamber.

- *
 - Keep sparks and flames away from the work area.
 - Drain gasoline into a clean container.

Disconnect the fuel inlet tube and auto bystarter wire coupler and P.T.S wire coupler.



4. FUEL SYSTEM

Loosen the air cleaner connector band screw.
Remove the two carburetor lock nuts.
Remove the carburetor



Pull out the throttle valve.
Pry off the needle retainer and remove the jet needle.
Check the throttle valve and jet needle for wear or damage.



CARBURETOR DISASSEMBLY FLOAT/FLOAT VALVE/JETS/ ACCELERATING PUMP

Float/Float Valve Disassembly

Remove the float chamber attaching three screws and remove the float chamber.

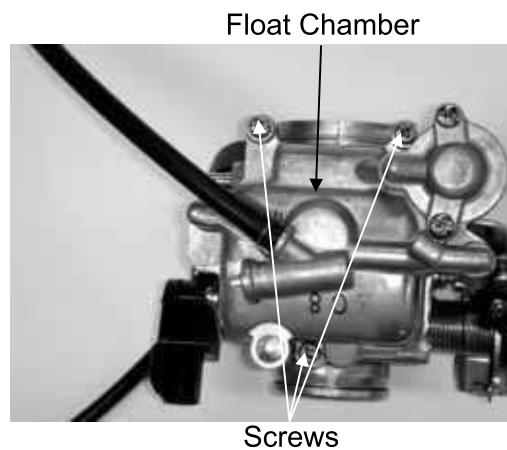

Float/Float Valve Inspection

Remove the float pin, float and float valve.
Inspect the float valve seat for wear or damage.
Inspect the float for damage or fuel level inside the float chamber.

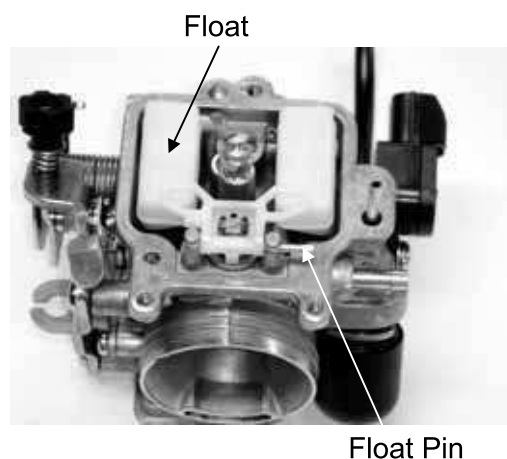

4. FUEL SYSTEM

Main Jet/Jets/Pilot Screw/Throttle Stop Screw Removal

Remove the main jet, needle jet holder, and needle jet.

Remove the slow jet.

Remove the pilot screw and throttle stop screw.

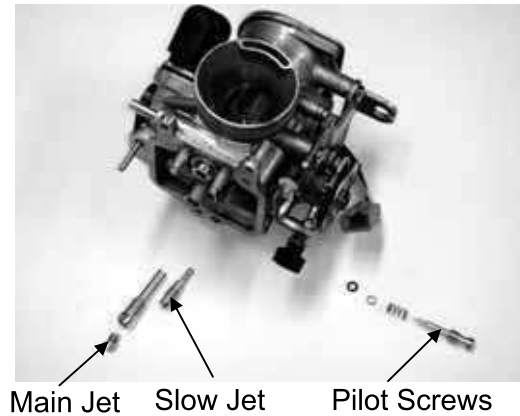

CAUTIONS !

- * • Be careful not to damage the jets and jet holder when removing them.
- Before removing, turn the throttle stop screw and pilot screw in and carefully count the number of turns until they seat lightly and then make a note of this.
- Do not force the screw against its seat to avoid seat damage.
- Be sure to install the O-ring in the reverse order of removal.

Accelerating Pump Removal

Remove the two accelerating pump cover screws and accelerating pump cover. Remove the spring and accelerating pump diaphragm.

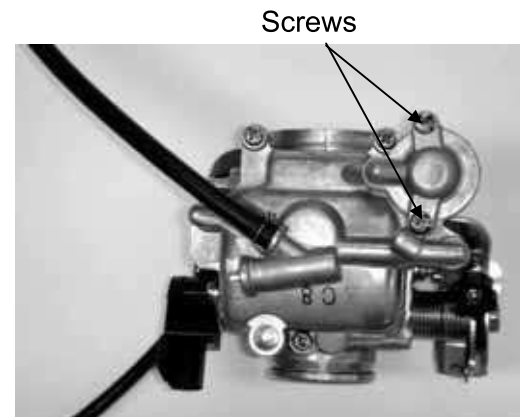

Inspection

Inspect the accelerating pump diaphragm for cracks, damage or deterioration. Replace with a new one if necessary.

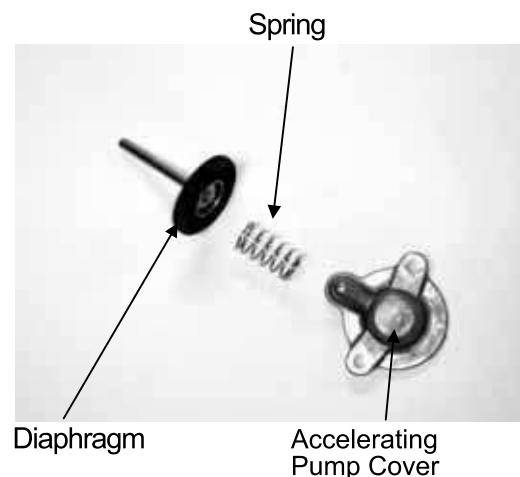

4. FUEL SYSTEM

Carburetor Cleaning

Blow compressed air through all passages of the carburetor body.



Slow Jet/Main Jet Installation

Install the slow jet.

Install the needle jet, needle jet holder and main jet.

Install the throttle stop screw and pilot screw.

- *
- When installing the pilot screw, return it to the original position as noted during removal
 - After the carburetor is installed, be sure to perform the Exhaust Emission Test.

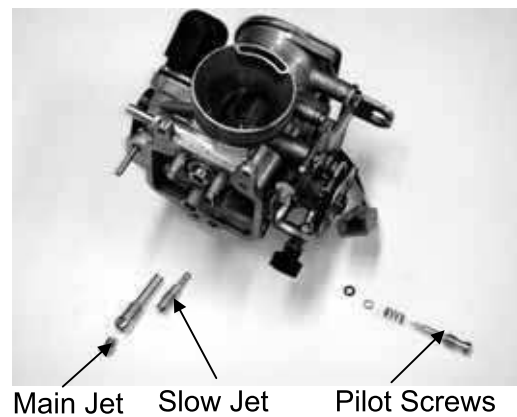

Main Jet Slow Jet Pilot Screws

Install the float valve, float and float pin.

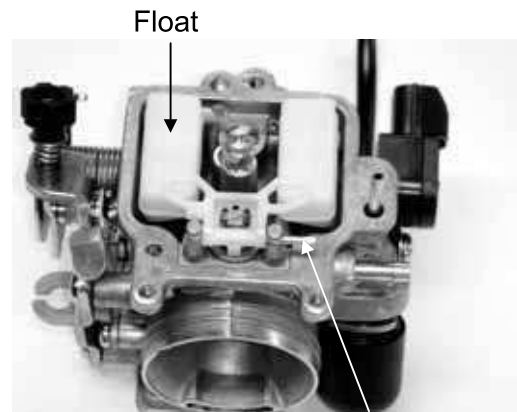

Float
Float Pin

FLOAT LEVEL INSPECTION

Turn the carburetor upside down so that the float will go down to make the float valve contact the float valve seat.

Then slowly tilt the carburetor and measure the float level with the float level gauge while the float pin just contacts with float valve.

Float Level: 17mm

When adjusting, carefully bend the float pin. Check the float for proper operation and then install the float chamber.

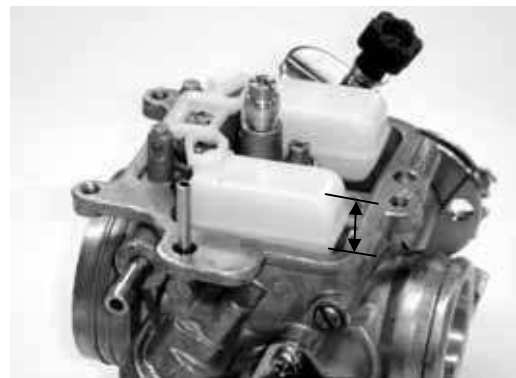

4. FUEL SYSTEM

Accelerating Pump Installation

First install the accelerating pump diaphragm.
Install the spring.
Install the accelerating pump cover and tighten the two screws.

* When installing the diaphragm, be sure to position it correctly.

Accelerating Pump Cover

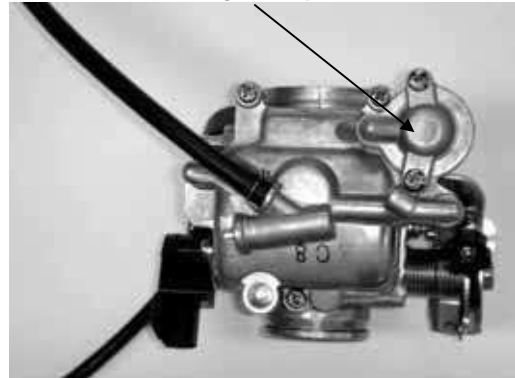

CARBURETOR INSTALLATION

Install the carburetor onto the intake manifold and tighten the two lock nuts.

Torque: 0.8~1.2kg-m

Install the air cleaner connector and tighten the band screw.

THROTTLE VALVE ASSEMBLY

Install the jet needle into the throttle valve and secure with the needle retainer.

Throttle Valve

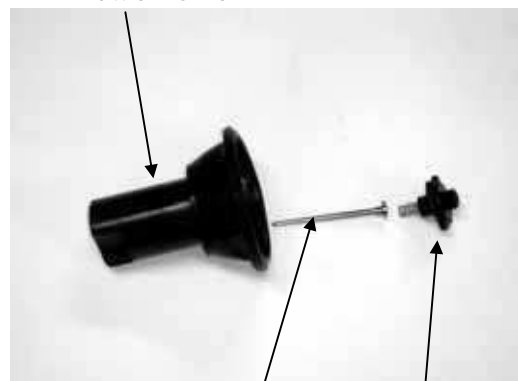

Jet Needle

Needle Retainer

Assemble the rubber cover, carburetor cap and throttle valve spring.
Connect the throttle cable to the throttle valve.

Carburetor Cap



4. FUEL SYSTEM

AIR CUT-OFF VALVE (A.C.V.)

REMOVAL

Remove the throttle stay plate set.
Disconnect the tubes that go to the air cut-off valve.
Remove the two attaching screws.
Remove the air cut-off valve.

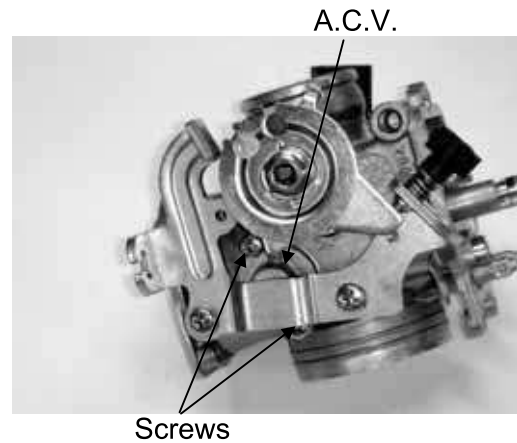

DISASSEMBLY

Remove the two attaching screws to remove the air cut-off valve cover.
Remove the spring and diaphragm.

INSPECTION

Inspect the check valve for proper operation.
Inspect the air cut-off valve diaphragm and O-ring for deterioration or damage.
Replace with new ones if necessary.
Clean each air passage with compressed air.

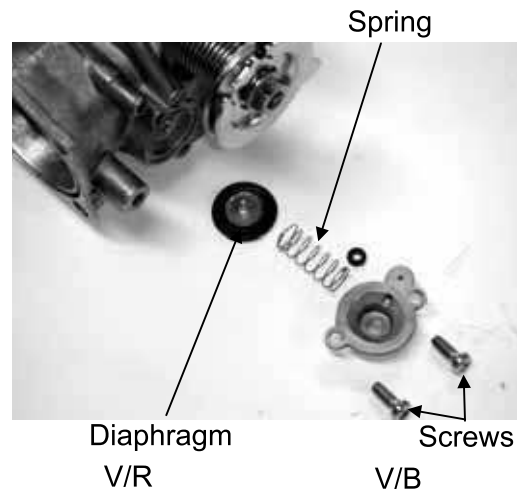

THROTTLE POSITION SENSOR INSPECTION

Measure the resistance on the T.P.S. of terminals.

Wire Color	Full Open	Full Close
V/R-V/G	4.8~6.2k Ω	4.8~6.2k Ω
V/B-V/G	4.16~6.24k Ω	1.47~2.21k Ω
V/R-V/B	2.3~3.5k Ω	5.1~7.5k Ω

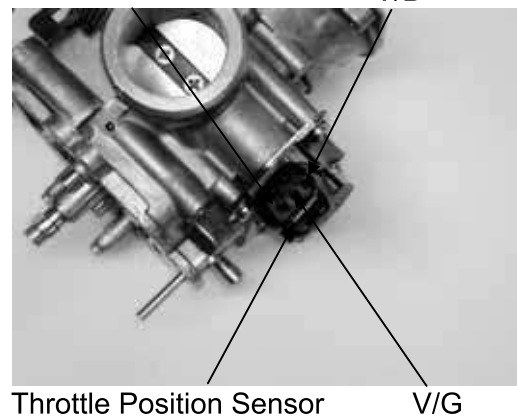

AUTO BYSTARTER INSPECTION

Measure the resistance between the auto bystarter wire terminals.

Resistance: 14-20 Ω (10 minutes minimum after stopping the engine)

If the reading is not within the limit, replace the auto bystarter with a new one.



4. FUEL SYSTEM

FUEL TANK

FUEL TANK REMOVAL

Warning

- Keep sparks and flames away from the work area.
- Wipe off any spilled gasoline.

Remove the right and left side covers and the right and left decorative covers under the fuel tank.

Remove the rear seat.

Remove the rear seat lock bolt and remove the front seat.

Remove the auto fuel valve.

Disconnect the fuel tube and remove the bolt on the end of the fuel tank.

Disconnect the fuel unit wire connector and fuel gauge wire.

Remove the fuel tank.

FUEL TANK INSTALLATION

Install the fuel tank in the reverse order of removal.

Check that there is no fuel leakage.

Check the wire connectors for proper connection.

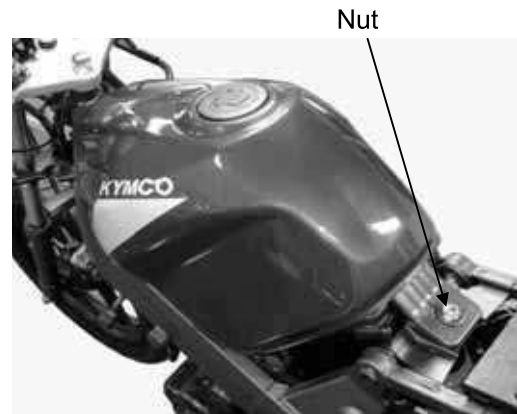

AIR CLEANER REMOVAL

Remove the right side cover.

Remove the two bolts attaching the emission control system.

Remove the rear carrier. (Refer to 4-10.)

Remove the seat. (Refer to 4-10.)

Remove the two air cleaner case attaching bolts.

Remove the air cleaner and carburetor connecting tube band.

Remove the air cleaner from the right side.

5. ENGINE REMOVAL/INSTALLATION

5

ENGINE REMOVAL/INSTALLATION

SERVICE INFORMATION-----	5-1
ENGINE REMOVAL-----	5-2
ENGINE INSTALLATION-----	5-3

5. ENGINE REMOVAL/INSTALLATION

SERVICE INFORMATION

GENERAL INSTRUCTIONS

- A engine stand or floor jack is required to support and maneuver the engine.
- The following parts can be serviced with the engine installed in the frame:
 - Cylinder head/valves (Section 6)
 - Cylinder/piston (Section 7)
 - Starter motor/generator/left crankcase cover/starter clutch/camshaft (Section 8)
 - Clutch/gear shift mechanism (Section 9)
- When removing and installing the engine, do not use a hammer or screw driver to strike or pry the engine.
- Do not damage the crankcase mating surfaces and clean off all gasket materials from the mating surfaces.
- After crankcase assembly, check that the transmission system operates smoothly.
- After engine installation, start the engine and check that the lubrication system is normal.

Engine oil capacity:

At disassembly : 1.1 liter

At change : 1.0 liter

TORQUE VALUES

Engine bracket bolt	2.0~2.5 kg-m
Drive gear lock bolt	0.8~1.2 kg-m
Exhaust muffler hanger lock bolt	2.4~3.0 kg-m
Rear fork pivot nut	5.5~7.0 kg-m
Exhaust muffler joint lock nut	0.8~1.2 kg-m

5. ENGINE REMOVAL/INSTALLATION

ENGINE REMOVAL

Remove the carburetor. (Refer to 4-4.)
 Disconnect the clutch cable.
 Remove the crankcase breather.
 Remove the two exhaust muffler joint lock nuts.
 Remove the exhaust muffler hanger lock bolt and exhaust muffler.

- *
 • Drain the engine oil before engine removal.
 • The exhaust muffler temperature is extremely high. Remove it when the engine is cold.

Remove the spark plug cap.

Remove the starter motor wire.
 Remove the two bolts attaching the left rear crankcase cover and remove the rear crankcase cover.

Remove the two bolts attaching the drive gear set plate and the set plate.
 Remove the drive gear and chain.

Disconnect the A.C. generator wire connector.

Intake Manifold Exhaust Muffler Joint



Clutch Cable Spark Plug Cap

Bolts



Rear Crankcase Cover

Generator Wire Connector Drive Chain

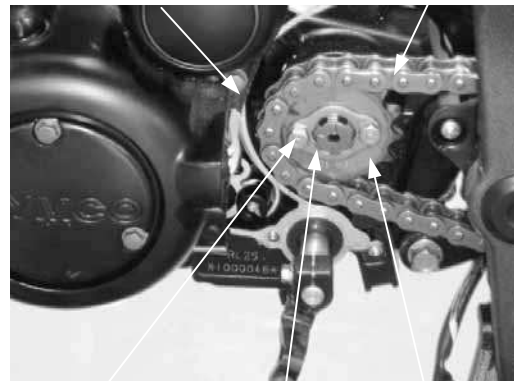

Bolt Set Plate Drive Gear



A.C.G Wire Connector

5. ENGINE REMOVAL/INSTALLATION

Remove the two nuts on the cooling oil container and move the cooling oil container. Remove the AICV tube.

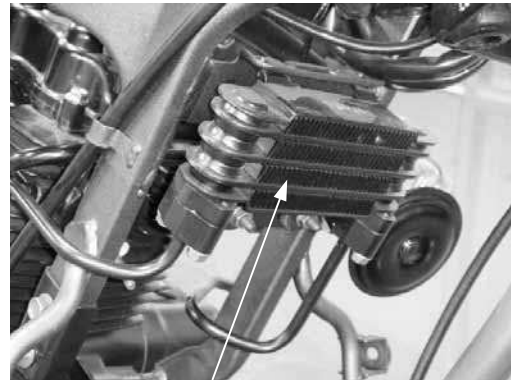

Cooling Oil Container

Remove the three bolts attaching the engine front bracket and the bracket. Remove the two engine hanger bolts and the hanger. Remove the two bolts attaching the engine rear bracket. Remove the engine from left to right.

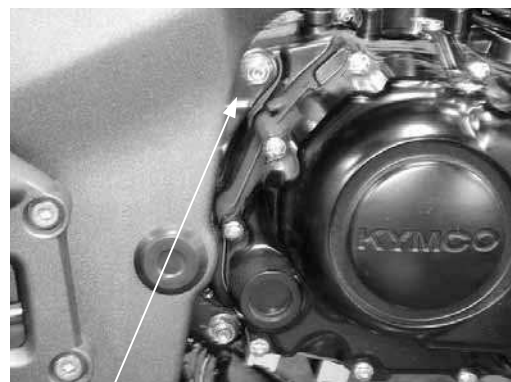

Rear Bracket

ENGINE INSTALLATION

Install the engine in the reverse order of removal. Install the engine to its original position with a jack or other adjustable support.

Upper Hanger



Front Bracket



*

- When installing the engine, do not damage the bolt thread and route the wires and cables properly.
- Install the gear shift lever by align the punch mark on the lever with that on the spindle.
- Fill the crankcase to the proper level with recommended engine oil.
- After installation, perform the following inspections and adjustments:
 1. Throttle operation
 2. Clutch lever free play adjustment
 3. Drive chain adjustment

6. CYLINDER HEAD/VALVES

6

CYLINDER HEAD/VALVES

SCHEMATIC DRAWING-----	6-1
SERVICE INFORMATION-----	6-2
TROUBLESHOOTING -----	6-3
CYLINDER HEAD COVER REMOVAL -----	6-4
CAMSHAFT REMOVAL-----	6-4
CAMSHAFT INSPECTION -----	6-5
CYLINDER HEAD REMOVAL-----	6-6
CYLINDER HEAD DISASSEMBLY -----	6-7
CAMSHAFT INSTALLATION-----	6-10
CYLINDER HEAD COVER INSTALLATION -----	6-11

6. CYLINDER HEAD/VALVES

SERVICE INFORMATION

GENERAL INSTRUCTIONS

- The cylinder head can be serviced with the engine installed in the frame.
- When assembling, apply molybdenum disulfide grease or engine oil to the valve guide movable parts and valve arm sliding surfaces for initial lubrication.
- The valve rocker arms are lubricated by engine oil through the cylinder head engine oil passages. Clean and unclog the oil passages before assembling the cylinder head.
- After disassembly, clean the removed parts and dry them with compressed air before inspection.
- After removal, mark and arrange the removed parts in order. When assembling, install them in the reverse order of removal.

SPECIFICATIONS		Standard (mm)	Service Limit (mm)
Item		125 cc	125 cc
Valve clearance (cold)	IN	0.06	—
	EX	0.06	—
Cylinder head compression pressure		11~13 kg/cm ²	>8 kg/cm ²
Cylinder head warpage		—	>0.05
Camshaft cam height	IN	30.800~30.920	<30.75
	EX	30.411~30.531	<30.26
Valve rocker arm I.D.	IN	12.00~12.015	>12.10
	EX	12.00~12.015	>12.10
Valve rocker arm shaft O.D.	IN	12.00~11.980	<11.90
	EX	12.00~11.980	<11.90
Valve seat angle	IN	89° ~ 90°	>90°
	EX	89° ~ 90°	>90°
Valve stem O.D.	IN	5.00~5.012	<4.925
	EX	5.00	<4.925
Valve guide I.D.	IN	5.00~5.012	>5.03
	EX	5.00~5.012	>5.03
Valve stem-to-guide Clearance	IN	0.010~0.037	>0.08
	EX	0.030~0.057	>0.10

6. CYLINDER HEAD/VALVES

TORQUE VALUES

Cylinder head nut	2.3~2.8 kg-m
Cylinder head side bolt	0.8~1.2 kg-m
Valve clearance adjusting nut	0.9 kg-m
Cylinder head cover bolt	0.8~1.2 kg-m

SPECIAL TOOLS

Valve spring compressor	E040
-------------------------	------

TROUBLESHOOTING

- The poor cylinder head operation can be diagnosed by a compression test or by tracing engine top-end noises.

Poor performance at idle speed

- Compression too low

Compression too low

- Incorrect valve clearance adjustment
- Burned or bent valves
- Incorrect valve timing
- Broken valve spring
- Poor valve and seat contact
- Leaking cylinder head gasket
- Warped or cracked cylinder head
- Poorly installed spark plug

Compression too high

- Excessive carbon build-up in combustion chamber

White smoke from exhaust muffler

- Worn valve stem or valve guide
- Damaged valve stem oil seal

Abnormal noise

- Incorrect valve clearance adjustment
- Sticking valve or broken valve spring
- Damaged or worn camshaft
- Worn cam chain tensioner
- Worn camshaft and rocker arm

6. CYLINDER HEAD/VALVES

CYLINDER HEAD COVER REMOVAL

Remove the cylinder head cover bolts and then remove the cylinder head cover.

Cylinder Head Cover

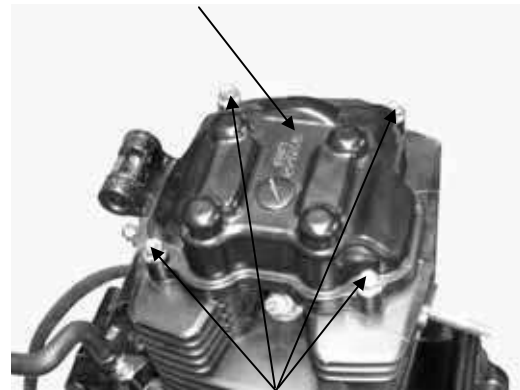

Bolts

CAMSHAFT REMOVAL

Turn the A.C. generator flywheel so that the "T" mark on the flywheel aligns with the index mark on the crankcase.

Hold the round hole on the camshaft gear facing up and the location is the top dead center on the compression stroke.

Nuts

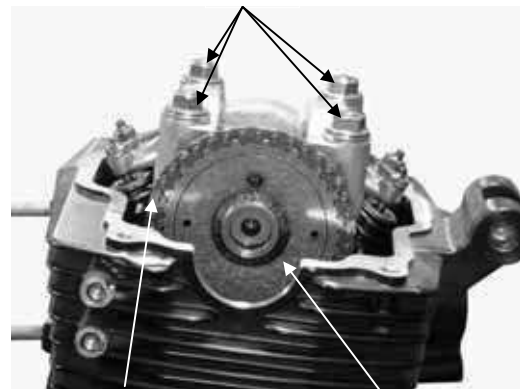

Cam Chain

Camshaft Gear

Remove the bolts attaching cam chain tensioner to remove the tensioner.

Then remove the four cylinder head nuts and washers.

- * Diagonally loosen the cylinder head cap nuts in 2 or 3 times.



Cam Chain Tensioner

Camshaft Holder

Remove the camshaft holder and dowel pins.



6. CYLINDER HEAD/VALVES

Remove the camshaft gear from the cam chain to remove the camshaft.

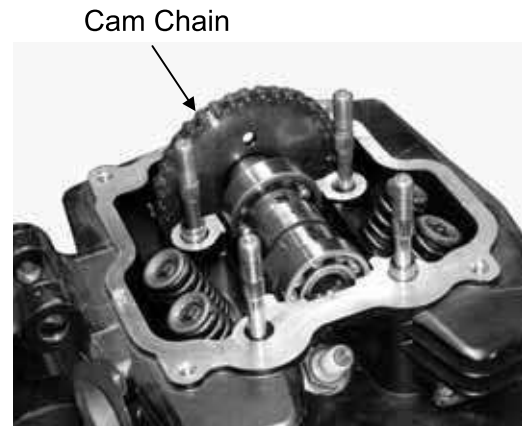

CAMSHAFT INSPECTION

Check each cam lobe for wear or damage. Measure the cam lobe height.

Service Limits:

IN: 30.75mm replace if below

EX:30.26mm replace if below

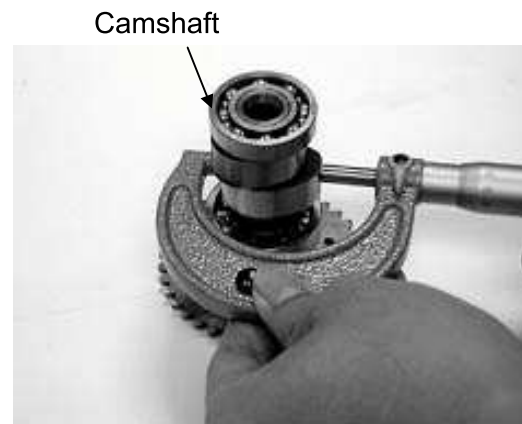

Check each camshaft bearing for play or damage. Replace the camshaft assembly with a new one if the bearings are noisy or have excessive play.



CAMSHAFT HOLDER DISASSEMBLY

Take out the valve rocker arm shafts using a 6mm bolt.

Remove the valve rocker arms.

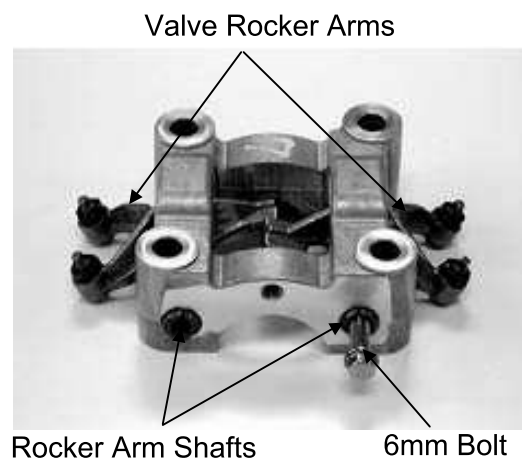

6. CYLINDER HEAD/VALVES

CAMSHAFT HOLDER INSPECTION

Inspect the camshaft holder, valve rocker arms and rocker arm shafts for wear or damage.

* If the valve rocker arm contact surface is worn, check each cam lobe for wear or damage.

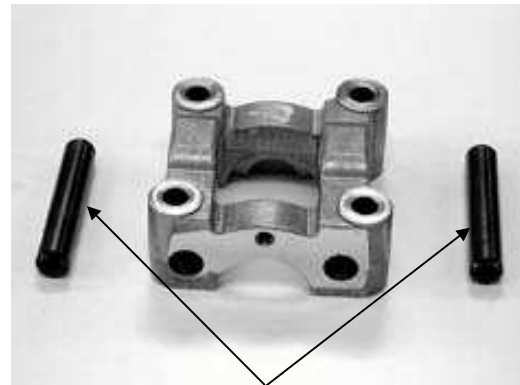

Rocker Arm Shafts

Measure the I.D. of each valve rocker arm.

Service Limits:

IN 12.10mm replace if over

EX 12.10mm replace if over

Measure each rocker arm shaft O.D.

Service Limits:

IN 11.90mm replace if below

EX 11.90mm replace if below

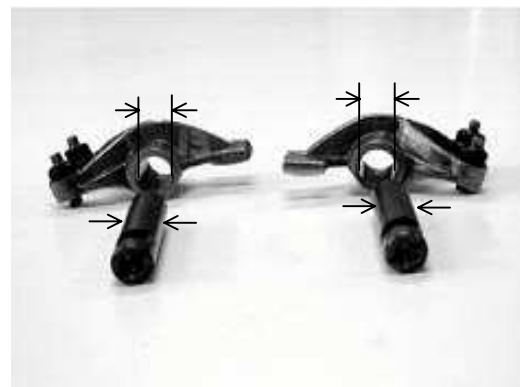

Cam Chain Tensioner Slipper

CYLINDER HEAD REMOVAL

Remove the camshaft. (⇒6-4)
 Remove the carburetor and intake manifold.
 Remove two bolts on the cylinder head.
 Remove the cylinder head.

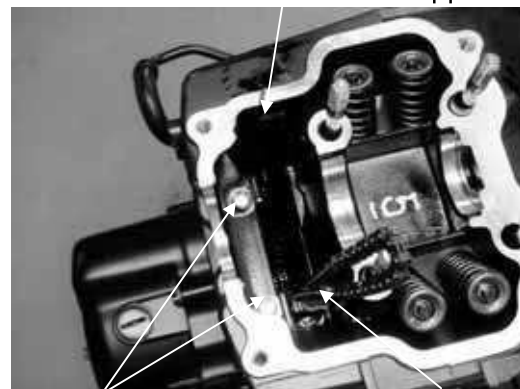

Bolts
 Cam Chain
 Cylinder Head Gasket

Remove the dowel pins and cylinder head gasket.
 Remove the cam chain guide.
 Remove all gasket material from the cylinder head mating surface.

* Be careful not to drop any gasket material into the engine.



Cylinder
 Cam Chain Guide

6. CYLINDER HEAD/VALVES

CYLINDER HEAD DISASSEMBLY

Remove the valve spring cotters, retainers, springs, spring seats and valve stem seals using a valve spring compressor.

- * Be sure to compress the valve springs with a valve spring compressor.
- * Mark all disassembled parts to ensure correct reassembly.

Remove carbon deposits from the exhaust port and combustion chamber.

- * Be careful not to damage the cylinder head mating surface.



Valve Spring Compressor



6. CYLINDER HEAD/VALVES

INSPECTION

CYLINDER HEAD

Check the spark plug hole and valve areas for cracks.

Check the cylinder head for warpage with a straight edge and feeler gauge.

Service Limit: 0.05mm repair or replace if over

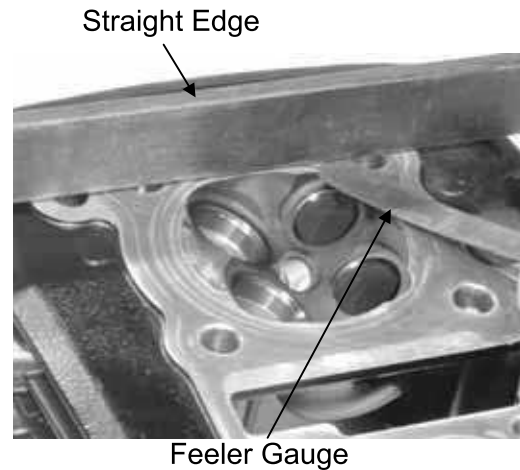

VALVE SPRING FREE LENGTH

Measure the free length of the inner and outer valve springs.

Service Limits:

(IN, EX) : 29.1mm replace if below



VALVE /VALVE GUIDE

Inspect each valve for bending, burning, scratches or abnormal stem wear.

Check valve movement in the guide.

Measure each valve stem O.D.

Service Limits:

IN 4.925mm replace if below

EX 4.925mm replace if below

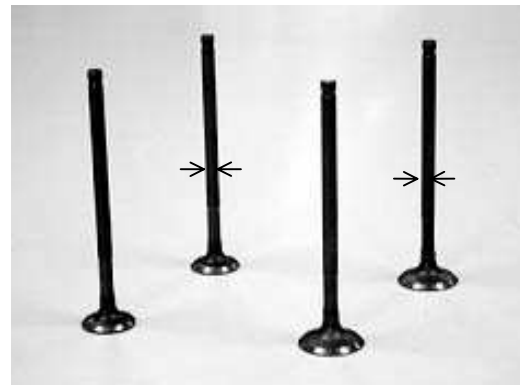

Measure each valve guide I.D.

Service Limits:

IN 5.03mm replace if over

EX 5.03mm replace if over

Subtract each valve stem O.D. from the corresponding guide I.D. to obtain the stem-to-guide clearance.

Service Limits:

IN 0.08mm replace if over

EX 0.10mm replace if over

* If the stem-to-guide clearance exceeds the service limits, replace the guides as necessary. Reface the valve seats whenever the valve guides are replaced.

6. CYLINDER HEAD/VALVES

CYLINDER HEAD ASSEMBLY

Install the valve spring seats and valve stem seals.

- * Be sure to install new valve stem seals.

Apply engine oil to the inside of the valve stem seals and insert the valves into the valve guides.

Install the valve springs and retainers. Compress the valve springs using the valve spring compressor, then install the valve cotters.

- * • When assembling, a valve spring compressor must be used.
- Install the cotters with the pointed ends facing down from the upper side of the cylinder head.

Special Tool

Valve Spring Compressor E040

Tap the valve stems gently with a plastic hammer to firmly seat the cotters.

- * Be careful not to damage the valves.

CYLINDER HEAD INSTALLATION

Install the cam chain guide.
Install the dowel pins and a new cylinder head gasket.



Valve Spring Compressor
Plastic Hammer

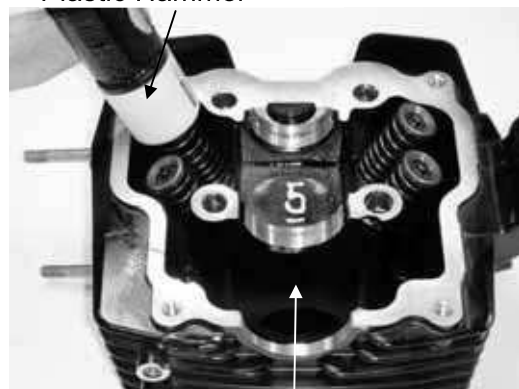

Cylinder Head
Dowel Pins

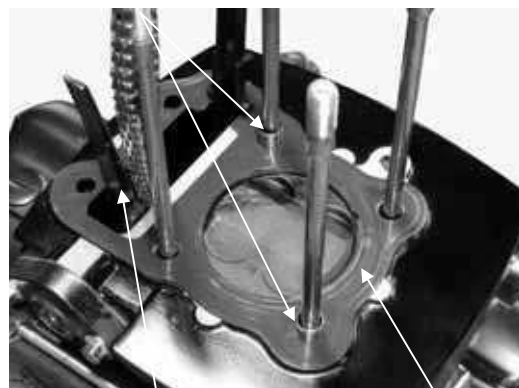

Cam Chain Guide Gasket

6. CYLINDER HEAD/VALVES

Install the cylinder head and take out the cam chain

Torque: Cylinder side bolt 0.8~1.2kg-m

Assemble the camshaft holder.
First install the intake and exhaust valve rocker arms; then install the rocker arm shafts.

- *
- Install the exhaust valve rocker arm shaft on the "EX" side of the camshaft holder and the exhaust rocker arm shaft is shorter.
 - Clean the intake valve rocker arm shaft off any grease before installation.
 - Align the cutout on the exhaust valve rocker arm shaft with the bolt of the camshaft holder.

CAMSHAFT INSTALLATION

Turn the A.C. generator flywheel so that the "T" mark on the flywheel aligns with the index mark on the crankcase.

Keep the round hole on the camshaft gear facing up and align the punch marks on the camshaft gear with the cylinder head surface (Position the intake and exhaust cam lobes down.) and install the cam chain over the camshaft gear.

Install the dowel pins.

Cylinder side bolt

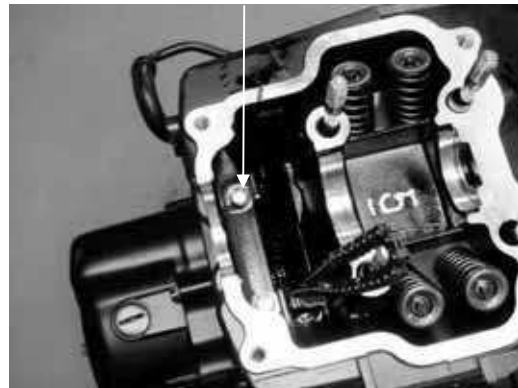

Valve Rocker Arms

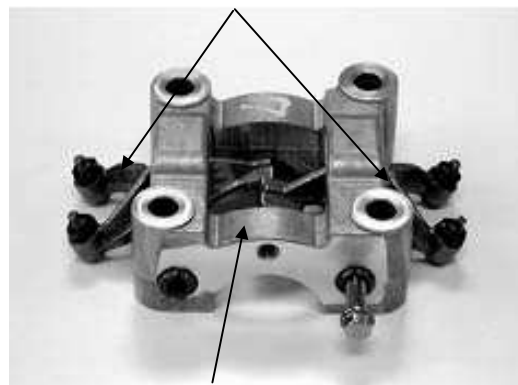

Camshaft Holder

Cam Chain Dowel Pins

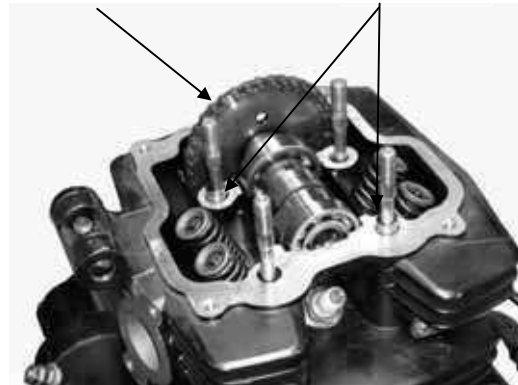

6. CYLINDER HEAD/VALVES

Install the camshaft holder, washers and nuts on the cylinder head.

Tighten the four cylinder head nuts and the two bolts between the cylinder head and cylinder.

Torque: Cylinder head nut 2.3~2.8kg-m

- * • Apply engine oil to the threads of the cylinder head cap nuts.
• Diagonally tighten the cylinder head cap nuts in 2~3 times.
• First tighten the cylinder head cap nuts and then tighten the bolts between the cylinder and cylinder head to avoid cracks.

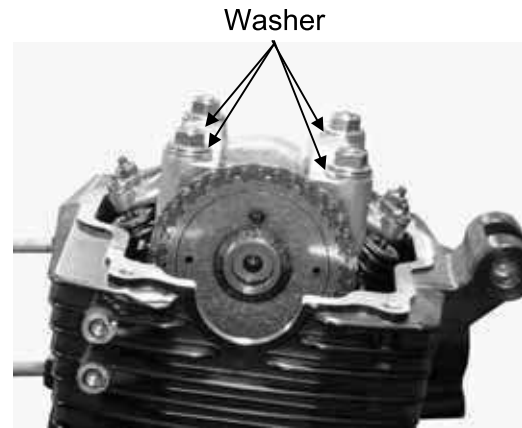

Install a new cam chain tensioner gasket. Tighten the cam chain tensioner screw.

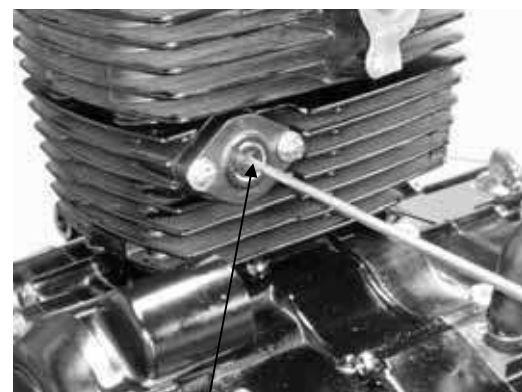

Cam Chain Tensioner
Cam Chain Tensioner Sealing Bolt

Install the cam chain tensioner and tighten the two bolts.

Install the tensioner spring and tighten the sealing bolt.

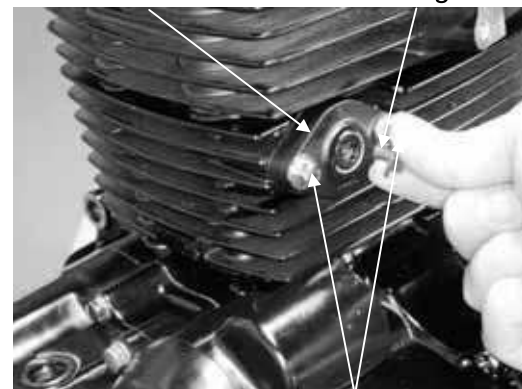

Bolt

CYLINDER HEAD COVER INSTALLATION

Adjust the valve clearance. (⇒3-6)

Install a new cylinder head cover O-ring and install the cylinder head cover.

- * Be sure to install the O-ring into the groove properly.

Install and tighten the cylinder head cover bolts.

Torque: 0.8~1.2kg-m



7. CYLINDER/PISTON

CYLINDER/PISTON

7

SCHEMATIC DRAWING-----	7-1
SERVICE INFORMATION-----	7-2
TROUBLESHOOTING -----	7-2
CYLINDER REMOVAL -----	7-3
PISTON REMOVAL -----	7-3
PISTON INSTALLATION -----	7-7
CYLINDER INSTALLATION -----	7-7

7. CYLINDER/PISTON

SCHEMATIC DRAWING

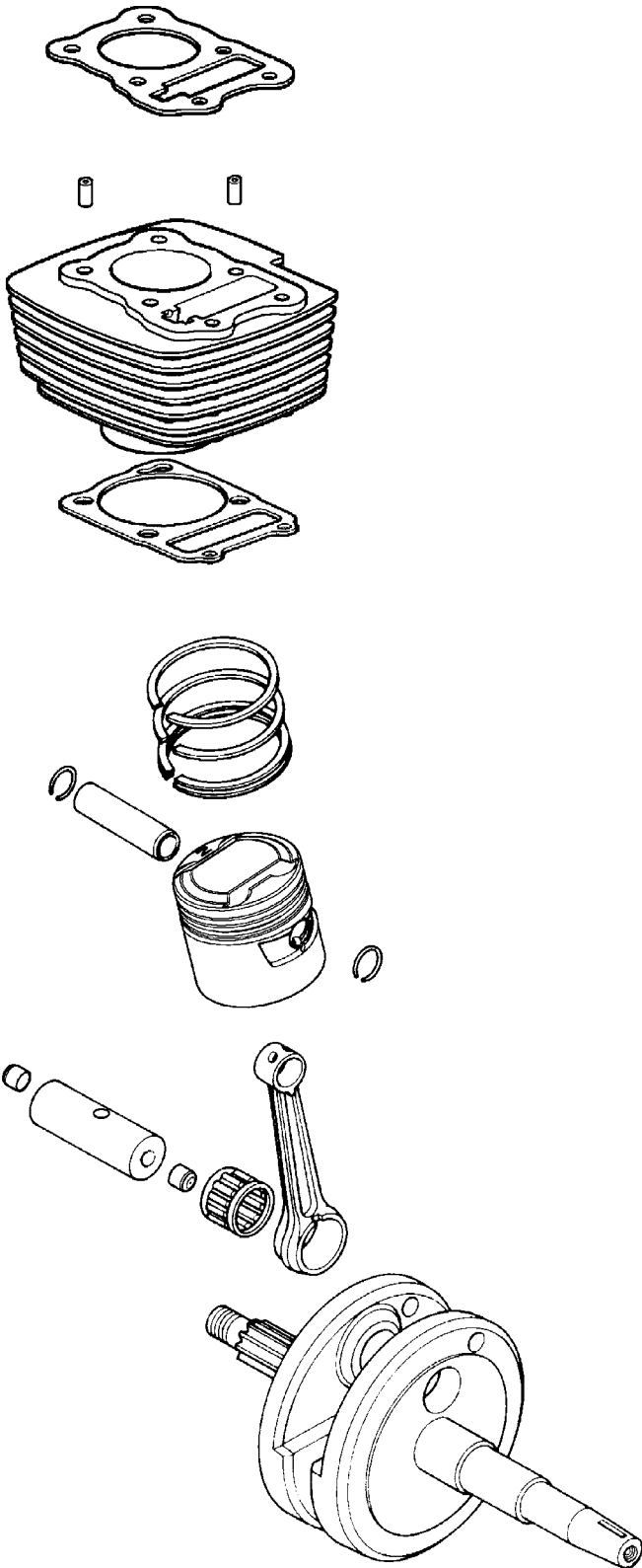

7. CYLINDER/PISTON

SERVICE INFORMATION

GENERAL INSTRUCTIONS

- The cylinder and piston can be serviced with the engine installed in the frame.
- When installing the cylinder, use a new cylinder gasket and make sure that the dowel pins are correctly installed.
- After disassembly, clean the removed parts and dry them with compressed air before inspection.

SPECIFICATIONS

Item		Standard (mm)	Service Limit (mm)	
Cylinder	I.D.	52.400~52.410	< 52.50	
	Warpage	—	< 0.05	
	Cylindricity	—	< 0.05	
	True roundness	—	< 0.05	
Piston, piston ring	Ring-to-groove clearance	top	0.015~0.050	< 0.09
		Second	0.015~0.050	< 0.09
	Ring end gap	top	0.15~0.30	< 0.50
		Second	0.15~0.30	< 0.50
		Oil side rail	0.2~0.9	—
	Piston O.D.	52.370~52.390	> 52.30	
	Piston O.D. measuring position	10mm from bottom of skirt		
	Piston-to-cylinder clearance	0.010~0.040	< 0.01	
Piston pin hole I.D.	15.000~15.008	< 15.06		
Piston pin O.D.	14.994~15.000	> 14.96		
Piston-to-piston pin clearance	0.002~0.014	< 0.02		
Connecting rod small end I.D. bore	15.016~15.034	< 15.06		

TROUBLESHOOTING

- When hard starting or poor performance at low speed occurs, check the crankcase breather for white smoke. If white smoke is found, it means that the piston rings are worn, stuck or broken.

Compression too low or uneven compression

- Worn or damaged cylinder and piston rings
- Worn, stuck or broken piston rings

Compression too high

- Excessive carbon build-up in combustion chamber or on piston head

Excessive smoke from exhaust muffler

- Worn or damaged piston rings
- Worn or damaged cylinder and piston

Abnormal noisy piston

- Worn cylinder, piston and piston rings
- Worn piston pin hole and piston pin
- Incorrectly installed piston

7. CYLINDER/PISTON

CYLINDER REMOVAL

Remove the cylinder head. (⇒6-7)

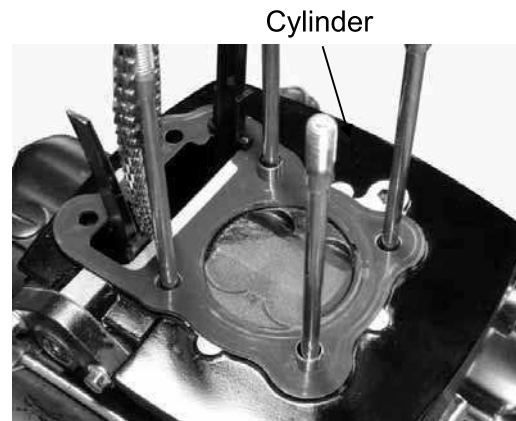

Remove the cam chain guide.
Remove the cylinder.



Remove the cylinder gasket and dowel pins.
Clean any gasket material from the cylinder surface.

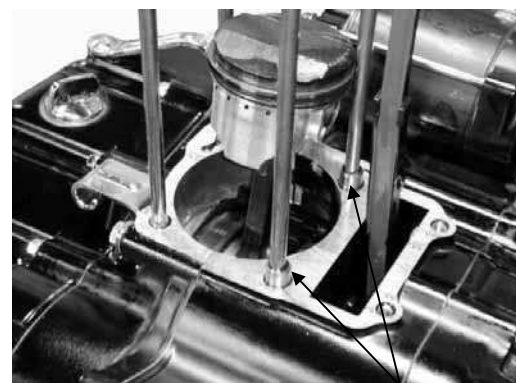

PISTON REMOVAL

Remove the piston pin clip.
Press the piston pin out of the piston.

* Place a clean shop towel in the crankcase to keep the piston pin clip from falling into the crankcase.

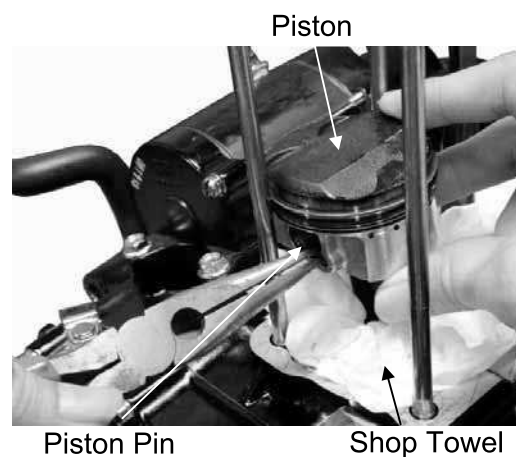

7. CYLINDER/PISTON

Inspect the piston, piston pin and piston rings.
Remove the piston rings.

- * • Take care not to damage or break the piston rings during removal.

Clean carbon deposits from the piston ring grooves.



Install the piston rings onto the piston and measure the piston ring-to-groove clearance.

Service Limits:

Top: 0.09mm replace if over
2nd: 0.09mm replace if over



Remove the piston rings and insert each piston ring into the cylinder bottom.

- * • Use the piston head to push each piston ring into the cylinder.

Measure the piston ring end gap.

Service Limit: 0.5mm replace if over



Measure the piston pin hole I.D.

Service Limit: 15.06mm replace if below

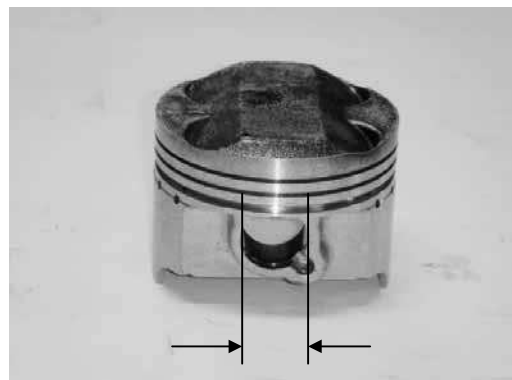

7. CYLINDER/PISTON

Measure the piston pin O.D.

Service Limit: 14.96mm replace if below

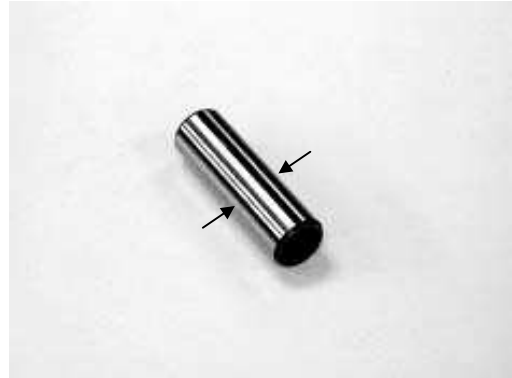

Measure the piston O.D.

- * • Take measurement at 9mm from the bottom and 90° to the piston pin hole.

Service Limit: 52.30mm replace if below

Measure the piston-to-piston pin clearance.

Service Limit: 0.02mm replace if over

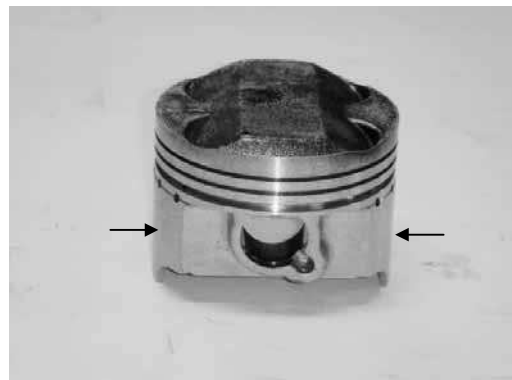

CYLINDER INSPECTION

Inspect the cylinder bore for wear or damage. Measure the cylinder I.D. at three levels of top, middle and bottom at 90° to the piston pin (in both X and Y directions).

Service Limit:
52.50mm repair or replace if below

Measure the cylinder-to-piston clearance.

Service Limit:
0.1mm repair or replace if over

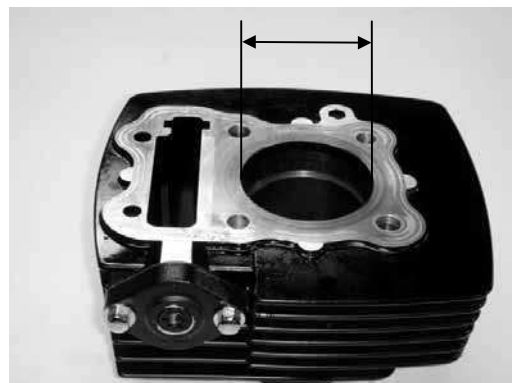

The true roundness is the difference between the values measured in X and Y directions. The cylindricity (difference between the values measured at the three levels) is subject to the maximum value calculated.

Service Limits:

True Roundness:
0.05mm repair or replace if over

Cylindricity: 0.05mm repair or replace if over

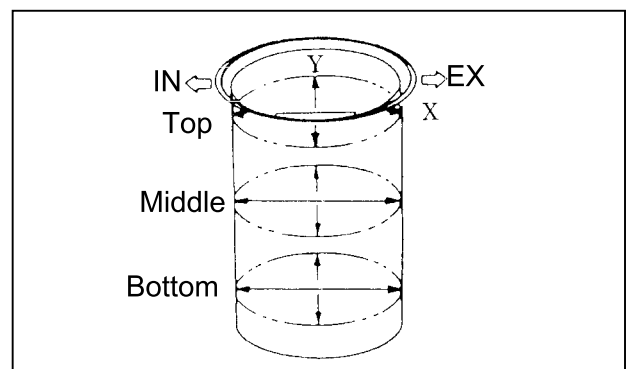

7. CYLINDER/PISTON

Inspect the top of the cylinder for warpage.
Service Limit: 0.05mm repair or replace if over



Measure the connecting rod small end I.D.
Service Limit: 15.06mm replace if below



PISTON RING INSTALLATION

Install the piston rings onto the piston.
 Apply engine oil to each piston ring.

- *
- Be careful not to damage the piston and piston rings during assembly.
 - All rings should be installed with the markings facing up.
 - After installing the rings, they should rotate freely without sticking.
 - Stagger the ring end gaps as the figure shown.

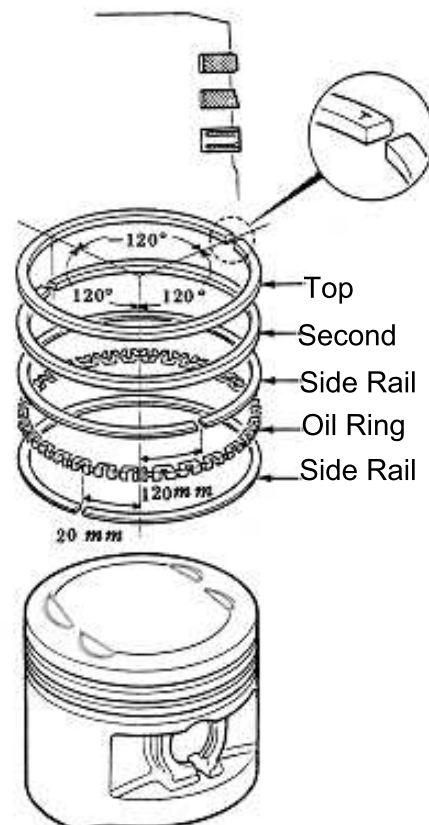

7. CYLINDER/PISTON

PISTON INSTALLATION

Remove any gasket material from the crankcase surface.

- * Be careful not to drop foreign matters into the crankcase.



Install the piston, piston pin and a new piston pin clip.

- * Position the piston "IN" mark on the intake valve side.
- Place a clean shop towel in the crankcase to keep the piston pin clip from falling into the crankcase.

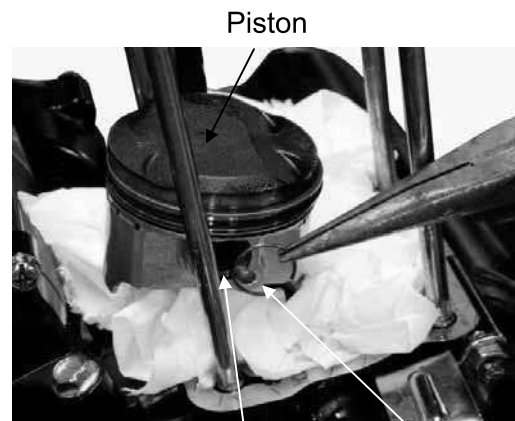

Piston Pin Piston Pin Clip

CYLINDER INSTALLATION

Install the dowel pins and a new cylinder gasket on the crankcase.



Dowel Pin

Coat the cylinder bore, piston and piston rings with clean engine oil. Carefully lower the cylinder over the piston by compressing the piston rings.

- * Be careful not to damage or break the piston rings.
- The piston ring end gaps should not be parallel with or at 90° to the piston pin.



Cylinder

7. CYLINDER/PISTON

Loosely install the cylinder base bolt.

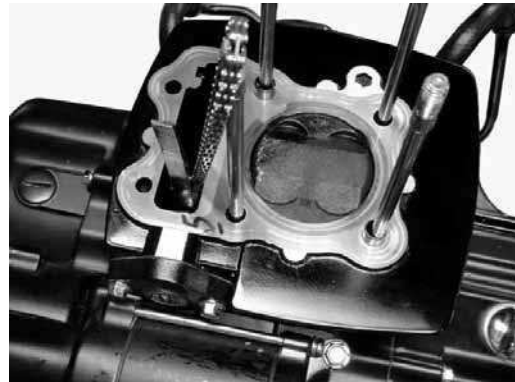

Install the cam chain guide.

- * • Insert the tab on the cam chain guide into the cylinder groove.

Cam Chain Guide

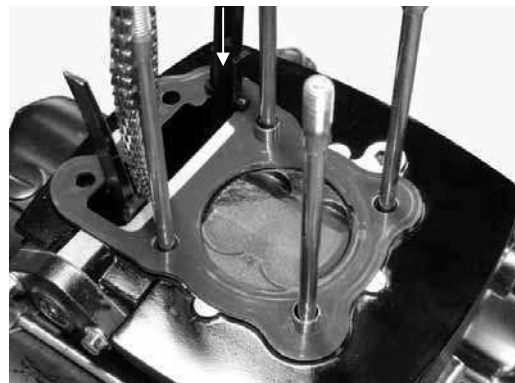

Install the cylinder head. (⇒6-13)
Tighten the cylinder base bolt.

**8. STARTER MOTOR/GENERATOR/LEFT CRANK-
CASE COVER/STARTER CLUTCH**

**STARTER MOTOR/GENERATOR/LEFT CRANKCASE COVER/STARTER
CLUTCH/CAMSHAFT**

SERVICE INFORMATION-----	8-2
TROUBLESHOOTING -----	8-2
STARTER MOTOR REMOVAL -----	8-3
LEFT CRANKCASE COVER/AC GENRATOR REMOVAL-----	8-3
STARTER CLUTCH REMOVAL -----	8-4
CAM CHAIN REMOVAL -----	8-5
STARTER GEAR INSTALLATION -----	8-5
AC GENERATOR INSTALLATION -----	8-5
LEFT CRANKCASE COVER INSTALLATION-----	8-6
STARTER MOTOR INSTALLATION -----	8-6



8. STARTER MOTOR/GENERATOR/LEFT CRANK- CASE COVER/STARTER CLUTCH

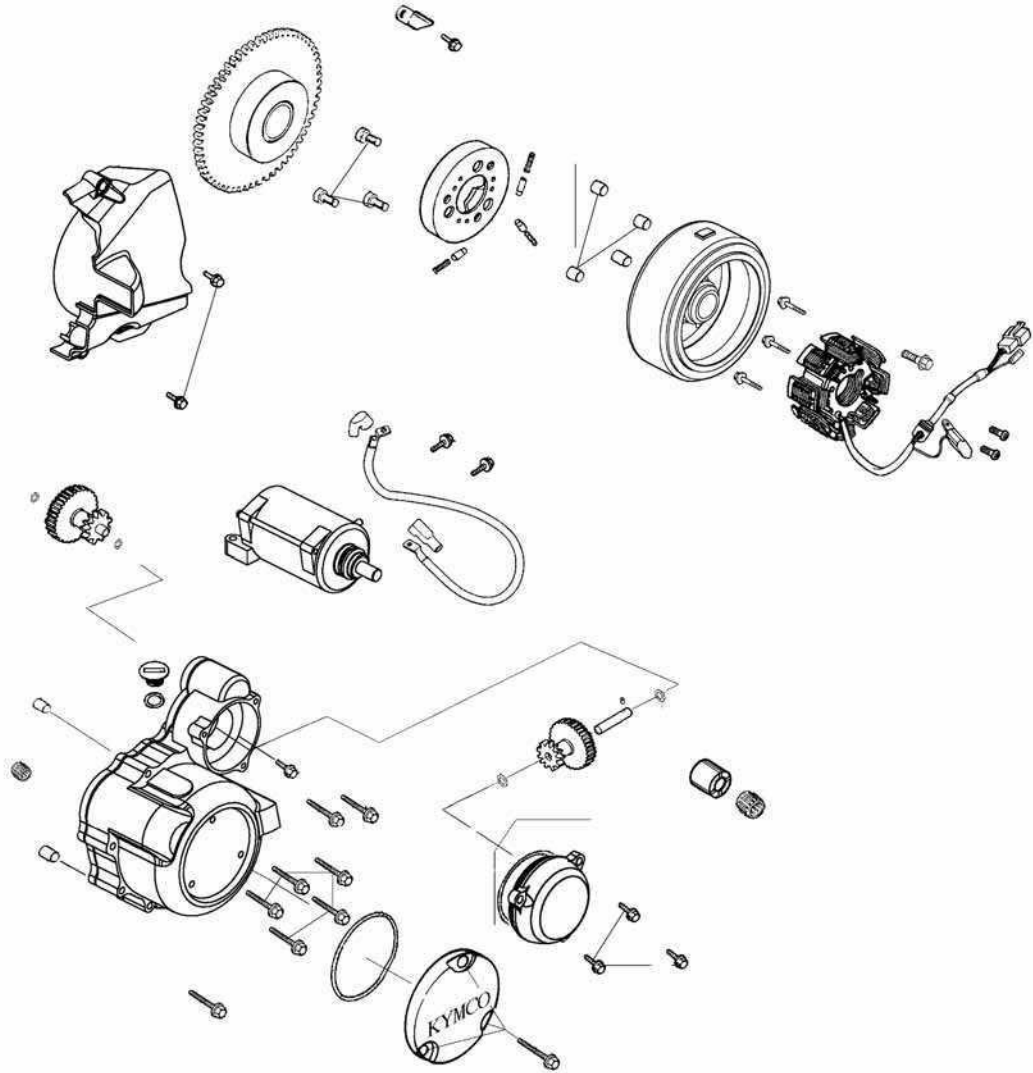

8. STARTER MOTOR/GENERATOR/LEFT CRANK- CASE COVER/STARTER CLUTCH

SERVICE INFORMATION

GENERAL INSTRUCTIONS

- The starter motor, generator, left crankcase and starter clutch can be serviced in the frame.
- Do not install the starter clutch forcedly.
- Install the generator by aligning the groove in the flywheel with the key on the crankshaft.
- Install the starter motor reduction gear shaft by aligning the shaft pin with the shaft seat groove.

SPECIFICATIONS

Item	Standard (mm)	Service Limit (mm)
Reduction gear shaft O.D.	9.972~9.987	< 9.932
Reduction gear shaft hole I.D.	10.031~10.056	> 10.096
Camshaft O.D.	13.966~13.984	< 13.926
Cam gear shaft hole I.D.	14.06~14.078	> 14.118
Roller O.D.	9.99~10.005	< 9.95
Starter gear shaft I.D.	22.01~22.022	> 22.062
Starter gear shaft O.D.	42.574~42.6	< 42.534

TORQUE VALUES

Flywheel lock bolt 4.0~5.2 kg-m

SPECIAL TOOLS

Flywheel holder E021
Flywheel puller E005

TROUBLESHOOTING

Hard starting and poor performance at high speed

- Improperly tightened flywheel lock bolt

Starter clutch slips

- Worn starter clutch roller
- Faulty starter clutch roller or spring
- Worn starter gear shaft O.D.

Starting noise

- Worn reduction gear
- Worn starter gear
- Worn starter clutch roller
- Faulty reduction gear shaft bearing

8. STARTER MOTOR/GENERATOR/LEFT CRANK-CASE COVER/STARTER CLUTCH

STARTER MOTOR REMOVAL

Remove the starter motor mounting two bolts and the motor.
Inspect the starter motor O-ring for damage or deterioration.
Inspect the starter motor pinion for wear or damage.



Mounting Bolts

Remove the three bolts attaching the starter motor reduction gear cover.
Remove the reduction gear cover.
Remove the reduction gear, shaft and washers.
Inspect the reduction gear for wear or damage.
Inspect the reduction gear cover O-ring for damage or deterioration.

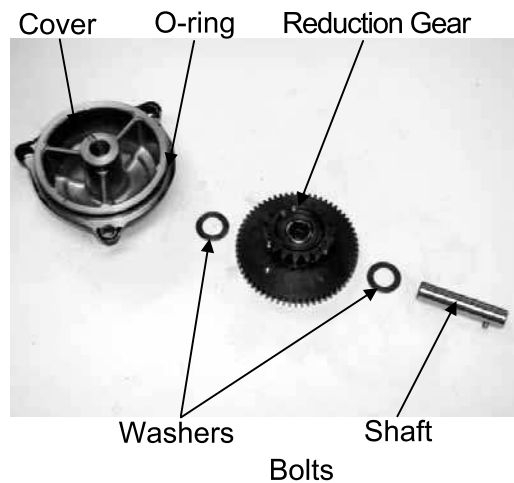

LEFT CRANKCASE COVER/ AC GENERATOR REMOVAL

Disconnect the neutral light switch wire.
Remove the left crankcase cover eight bolts.
Remove the left crankcase cover and two dowel pins.
Clean off all gasket material from the left crankcase cover.
Remove the reduction pinion.



Neutral Light Wire
Flywheel Puller

Hold the flywheel with a flywheel holder.
Remove the flywheel lock bolt.
Remove the flywheel using a flywheel puller.

Special Tool

Flywheel holder	E021
Flywheel puller	E005



Flywheel Holder

Flywheel

8. STARTER MOTOR/GENERATOR/LEFT CRANK- CASE COVER/STARTER CLUTCH

STARTER CLUTCH REMOVAL

Remove the reduction pinion.
Remove the starter gear.



Starter Gear

INSPECTION

Measure the starter gear shaft I.D.
Service Limit: 22.062mm replace if over

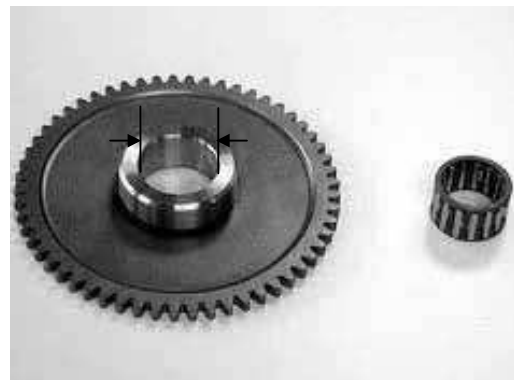

Starter Gear

Measure the starter gear shaft O.D.
Service Limit: 42.534mm replace if below

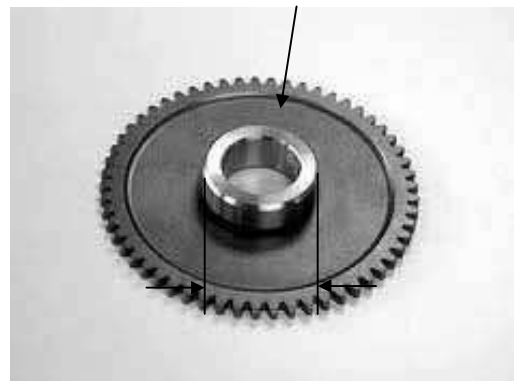

Measure the starter clutch roller O.D.
Service Limit: 9.95mm replace if below

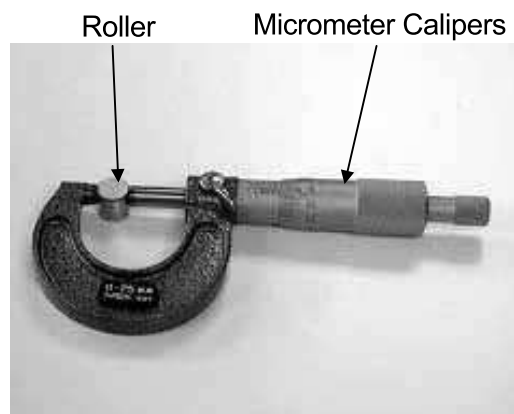

8. STARTER MOTOR/GENERATOR/LEFT CRANK-CASE COVER/STARTER CLUTCH

CAM CHAIN REMOVAL

Remove the starter gear.
Remove the cam chain.

Cam Chain



Cam chain guide bolt

Remove the cam chain guide bolt.



STARTER GEAR INSTALLATION

Install the cam chain guide and cam chain.
Install the starter gear.



Starter Gear

Lock Bolt

AC GENERATOR INSTALLATION

Install the generator flywheel. Hold the flywheel with a flywheel holder and tighten the flywheel lock bolt.

- * • Install the flywheel by aligning the groove in the flywheel with the key on the crankshaft.
• When installing, be careful not to damage the starter clutch rollers.

Torque: 4.0~5.2kg-m

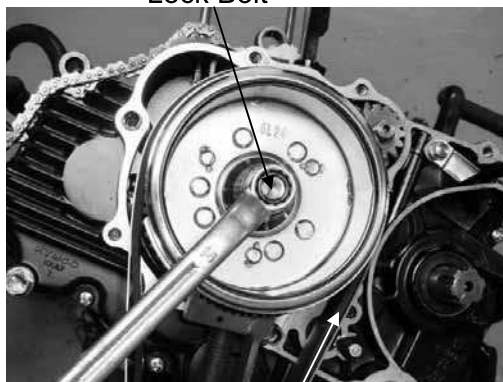

Flywheel Holder

8. STARTER MOTOR/GENERATOR/LEFT CRANK-CASE COVER/STARTER CLUTCH

LEFT CRANKCASE COVER INSTALLATION

Install the left crankcase cover and tighten the eight bolts. (Refer to 8-3.)

Torque: 0.8~1.2kg-m

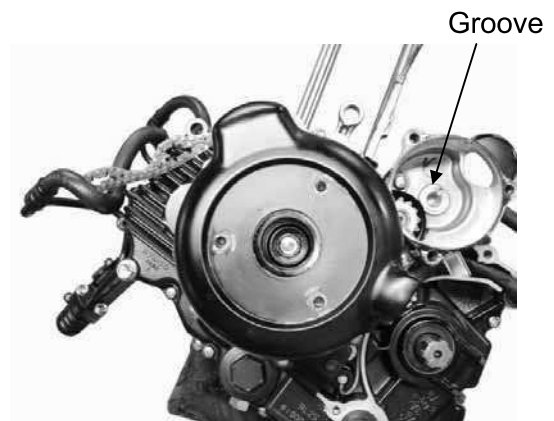

Install the reduction gear, shaft and washers. Then install the reduction gear cover and tighten the three bolts.

Torque: 0.8~1.2kg-m

*

- Install the reduction gear shaft by aligning the shaft pin with the shaft seat groove.
- Apply engine oil to the reduction gear cover O-ring before installation.

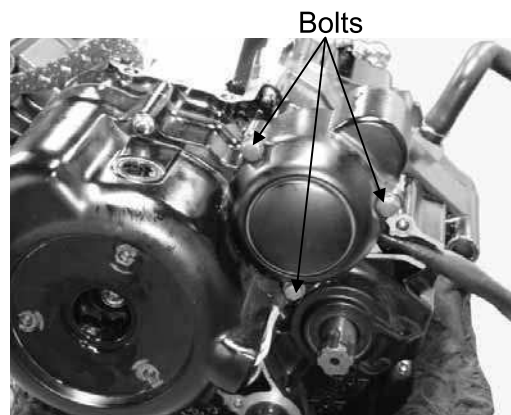

STARTER MOTOR INSTALLATION

Apply engine oil to the starter motor O-ring and then install it.

Install the starter motor.

Tighten the two mounting bolts.

Torque: 0.8~1.2kg-m

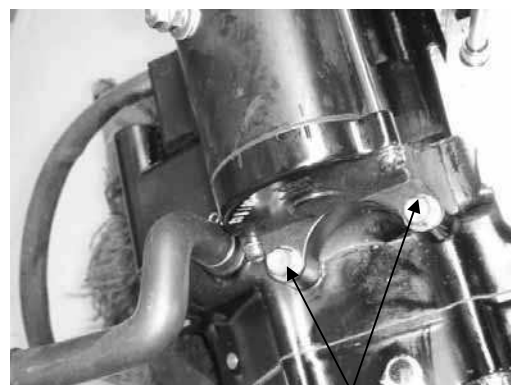

Mounting Bolts

9. CLUTCH/GEAR SHIFT MECHANISM

9

CLUTCH/GEAR SHIFT MECHANISM

SERVICE INFORMATION-----	9-2
TROUBLESHOOTING -----	9-2
RIGHT CRANKCASE COVER REMOVAL-----	9-3
CLUTCH REMOVAL-----	9-3
RIGHT CRANKCASE COVER INSTALLATION -----	9-9

9. CLUTCH/GEAR SHIFT MECHANISM

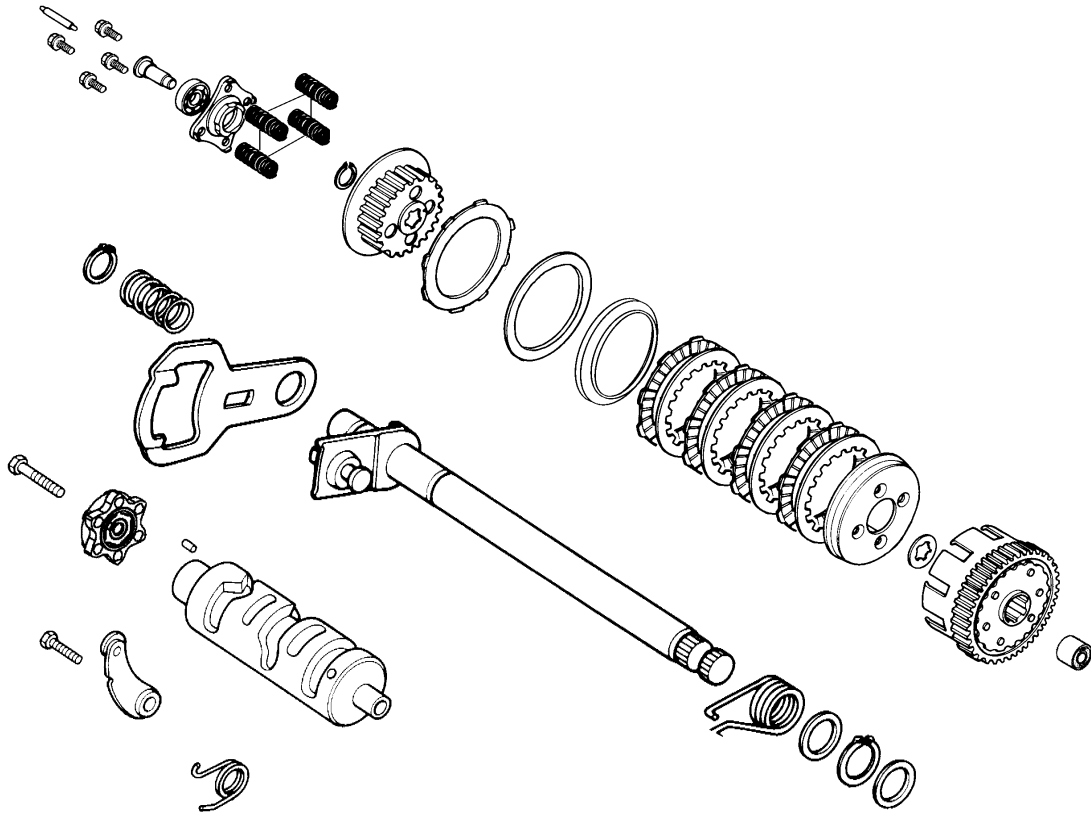

9. CLUTCH/GEAR SHIFT MECHANISM

SERVICE INFORMATION

GENERAL INSTRUCTIONS

- The clutch and gear shift mechanism can be serviced in the frame.
- Install the clutch plates in the chamfer direction.
- Install the thrust washer with the chamfer facing up and the flat facing down.

SPECIFICATIONS

Item	Standard (mm)	Service Limit (mm)
Clutch spring free length	35.5	< 34.2
Clutch friction disk thickness	2.8~2.9	< 2.5
Clutch plate bending	0~0.1	> 0.2
Clutch outer I.D.	111~111.5	> 112.5
Clutch outer guide I.D.	30.0~30.021	> 30.40

TORQUE VALUES

Clutch center lock bolt 0.8~1.2 kg-m

TROUBLESHOOTING

Clutch slips during acceleration

- No free play
- Worn friction disk
- Weak spring

Clutch won't operate

- Excessive free play
- Bent clutch plate

Improper shifting

- Excessive clutch lever free play
- Bent gear shift spindle
- Worn or deformed gear shift plate
- Damaged transmission drum grooves
- Faulty gear shift cam stopper

Clutch won't operate; motorcycle moves moves slowly

- Excessive free play
- Bent clutch plate

Too much pressure on clutch lever

- Kinked, twisted or damaged clutch cable
- Damaged clutch lifter

Clutch does not operate smoothly

- Improper clutch outer groove machining

Gear tripping

- Faulty gear shift cam stopper
- Bent gear shift spindle
- Worn gear teeth

9. CLUTCH/GEAR SHIFT MECHANISM

RIGHT CRANKCASE COVER REMOVAL

Drain the engine oil.
Disconnect the clutch cable.
Remove the right crankcase cover attaching 13 bolts and right crankcase cover.
Remove the clutch lever and bearing.

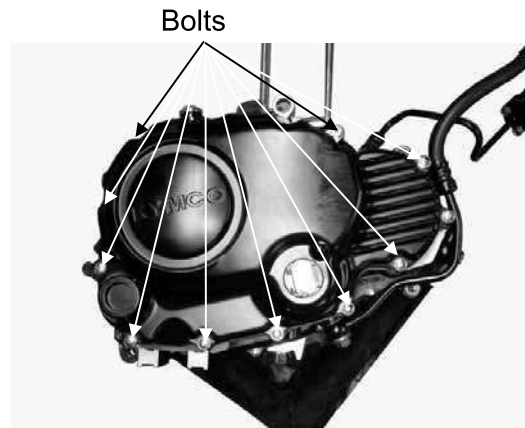

Remove the oil filter rotor cover. (Refer to 3-3.)
Remove the square nut.
Remove the square nut (left hand threads) on the balance shaft driven gear.
Remove the oil filter rotor.

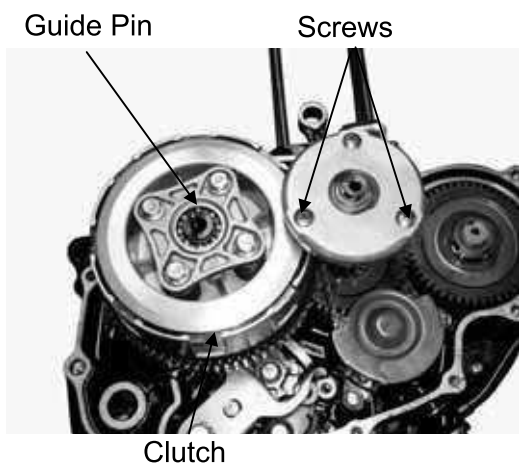

Remove the oil pump gear cover.
Remove the 6mm nut on top of the oil pump driven gear.
Remove the oil pump driven gear and chain.
Remove the oil pump drive gear and clutch outer drive gear from the crankshaft.

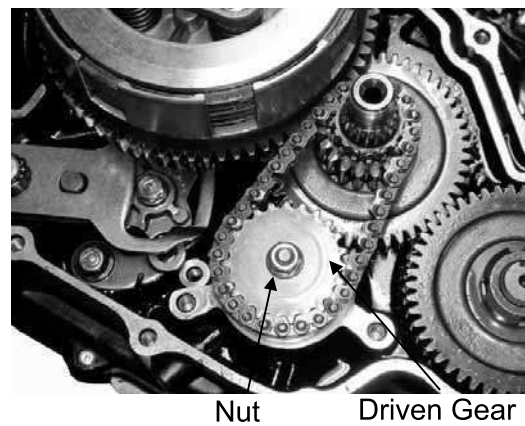

CLUTCH REMOVAL

Remove the four clutch lifter bolts.
Remove the clutch lifter and four tension springs.

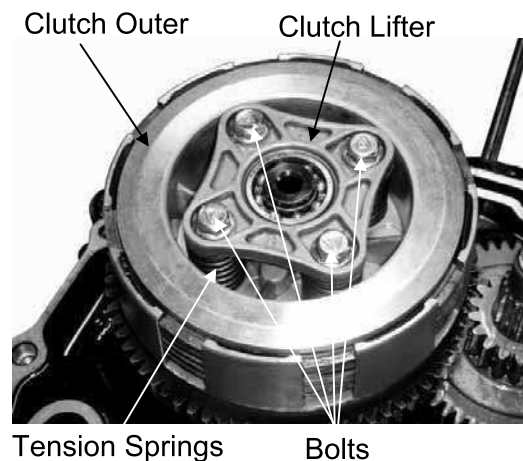

9. CLUTCH/GEAR SHIFT MECHANISM

Remove the 20mm circlip using a pair of pliers and then remove the clutch center, clutch friction disks and plates.

- *
 - When removing the circlip, do not expand it excessively to avoid deformation.
 - Install the circlip with the chamfered side facing down.

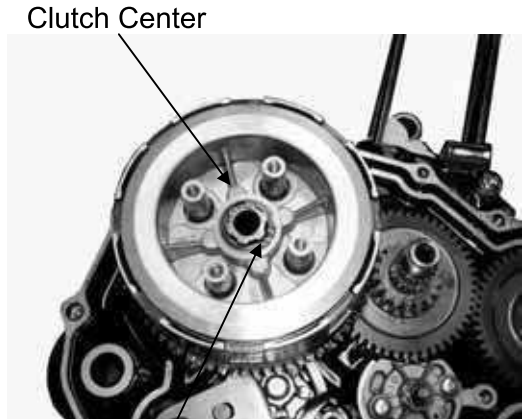

Remove the balance shaft drive gear and woodruff key from the crankshaft. Remove the special flange gasket on the balance shaft driven gear, driven gear and woodruff key from the balance shaft. Remove the oil pump shaft.

- *
 Be careful not to drop or lose the woodruff keys.

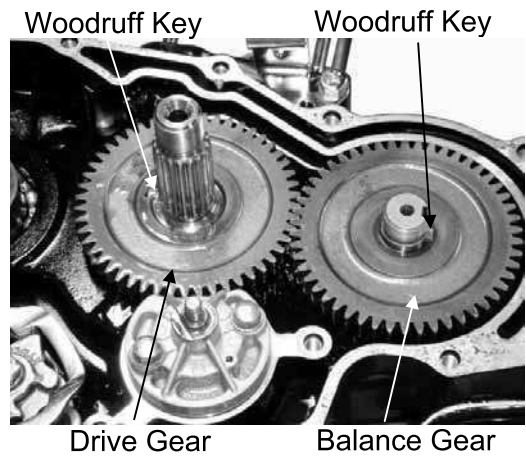

Remove the thrust washer, clutch outer and outer guide.

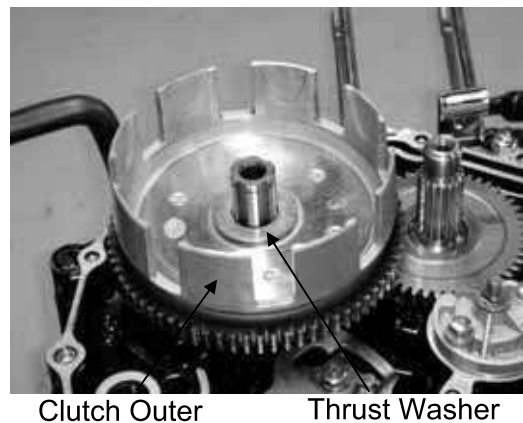

INSPECTION

CLUTCH TENSION SPRING

Measure each clutch tension spring free length.

Service Limit: 34.20mm

Replace the spring with a new one if it is shorter than the service limit.



9. CLUTCH/GEAR SHIFT MECHANISM

CLUTCH FRICTION DISK

Measure each clutch friction disk thickness.

Service Limit: 2.5mm replace if below



Clutch Friction Disk Vernier Caliper

CLUTCH PLATE

Measure each clutch plate bending using a feeler gauge.

Service Limit: 0.20mm replace if over

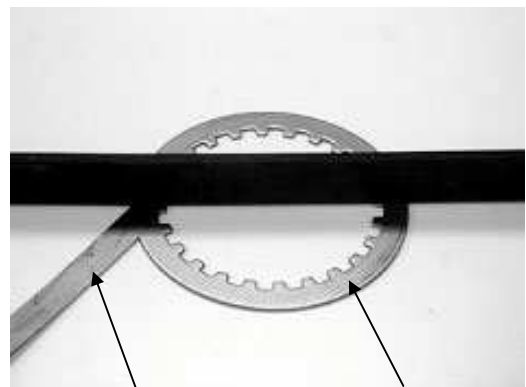

Feeler Gauge Clutch Plate

CLUTCH OUTER/OUTER GUIDE

Inspect the clutch outer groove for scratches caused by the friction disks.

Measure the clutch outer I.D.

Service Limit: 112.5mm replace if over

Measure the clutch outer guide I.D.

Service Limit: 30.40mm replace if over

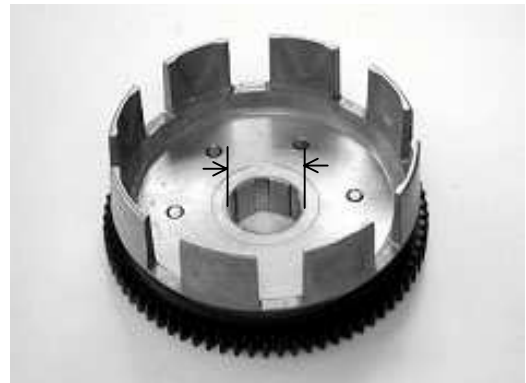

GEAR SHIFT MECHANISM

Remove the gear shift pedal.

Remove the gear shift spindle and washer.



Gear Shift Spindle Stopper

9. CLUTCH/GEAR SHIFT MECHANISM

Remove the stopper and spring.
Remove the gear shift cam bolt.
Remove the gear shift cam and set pin.

Inspection

Inspect the gear shift cam stopper for wear or looseness and replace if necessary.

Check the gear shift plate for wear or deformation and replace if necessary.

Inspect the corners of the gear shift cam for wear or damage. Replace the cam if the corners are rounded.

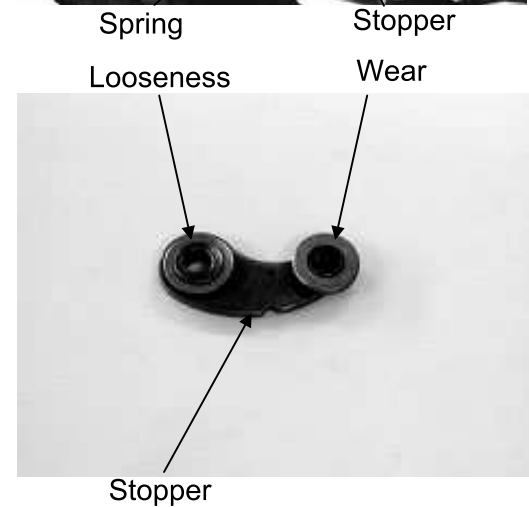

9. CLUTCH/GEAR SHIFT MECHANISM

Installation

Install the gear shift cam stopper and spring.
Tighten the 6mm lock bolt.

Torque: 0.8~1.2kg-m

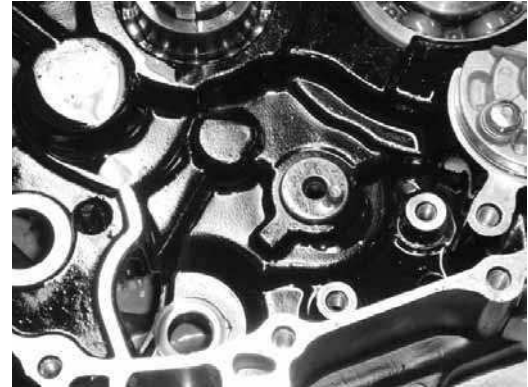

Gear Shift Cam

Install the set pin into the transmission drum hole.

Install the gear shift cam, aligning the pin hole in the gear shift cam with the set pin.
Then, tighten the bolt.

Torque: 0.8~1.2kg-m

- *
 - After the gear shift cam is installed, put the stopper in the gear shift cam groove and tighten the stopper bolt.
 - Rotate the transmission drum to make sure that the stopper operates properly.



Gear Shift Cam Stopper

Install the gear shift spindle and washer.
During installation, make sure that the return spring aligns with the crankcase tab.



Gear Shift Spindle

Install the oil pump body and insert the pump shaft.

Install the balance shaft drive gear and woodruff key onto the crankshaft.

Install the balance shaft driven gear and woodruff key onto the balance shaft.

- *

Be sure to align the punch marks on the drive and driven gears before installing the woodruff key onto the balance shaft.



Pump Shaft

9. CLUTCH/GEAR SHIFT MECHANISM

Install the clutch outer drive gear onto the crankshaft.
Install the oil pump drive gear onto the crankshaft.
Install oil pump driven gear and chain.



Oil Pump

Install the clutch outer and thrust washer.

- * Install the thrust washer with the chamfered side facing up.

Install the oil pump chain and driven gear and secure it with the 6mm nut.
Install the clutch assembly.
Stagger the clutch friction disks and clutch plates and then put them on the clutch center.
Then install the clutch center together with the well-arranged friction disks and plates into the clutch outer.

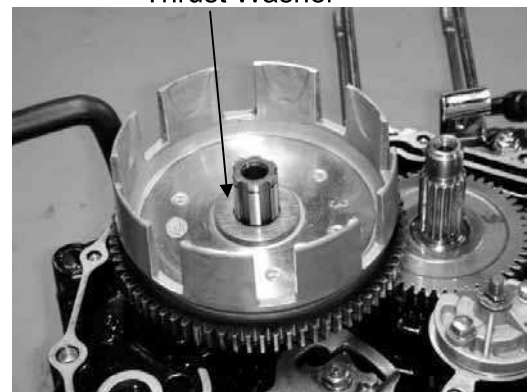

Thrust Washer

Install the circlip.

- * Install the circlip with the chamfered side facing down.



20mm Circlip

Install the tension springs and clutch lifter.
Install the washers to the bolts and tighten the four bolts.

Torque: 0.8~1.2kg-m

Install the clutch lifter guide pin.

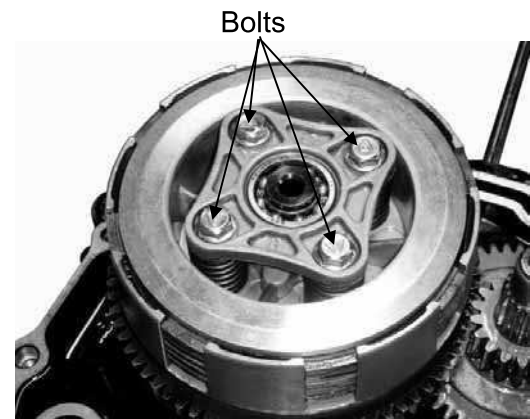

Bolts

9. CLUTCH/GEAR SHIFT MECHANISM

Install the oil filter rotor.
Install the washer and tighten the square nut.

Torque: 4.0~5.0kg-m

* Install the washer with the mark
"OUTSIDE" facing up.

Install the special flange gasket onto the
balance shaft driven gear with the flange
facing down and then loosely install the
square nut (left hand threads).
Tighten the square nut using the square
socket.

Install the oil filter rotor cover.
Check the gasket for wear or damage and
replace if necessary.
Install and tighten the three oil filter rotor
cover screws.

Torque: 0.3~0.4kg-m

Install the oil pump gear cover and tighten
the two bolts.

RIGHT CRANKCASE COVER INSTALLATION

First install the dowel pins and then install
the gasket.
Install the right crankcase cover and tighten
the cover bolts.

Torque: 0.8~1.2kg-m

* Tighten the right crankcase cover bolts
diagonally.

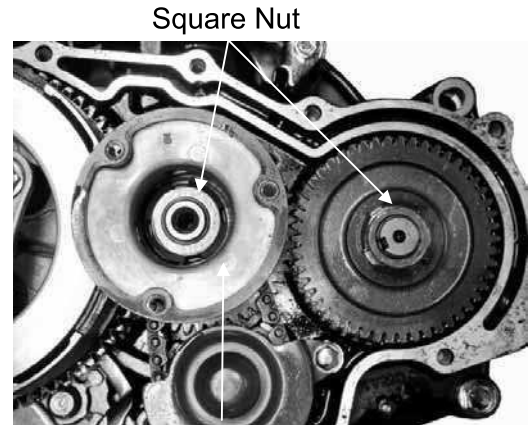

Oil Filter Rotor

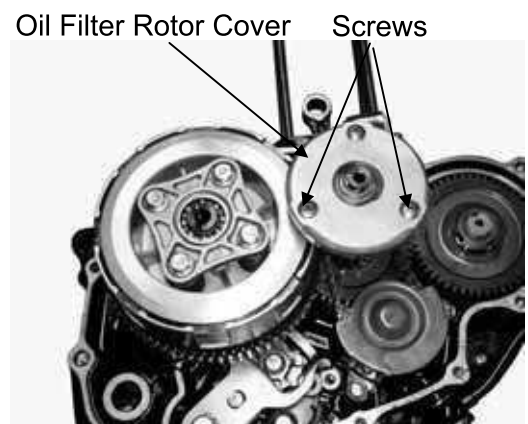

Right Crankcase Cover

9. CLUTCH/GEAR SHIFT MECHANISM

**CRANKCASE/CRANKSHAFT/TRANS-MISSION
SYSTEM/STARTER SPINDLE**

SERVICE INFORMATION-----	10-2
TROUBLESHOOTING -----	10-3
CRANKCASE REMOVAL -----	10-4
TRANSMISSION SYSTEM REMOVAL -----	10-4
STARTER SPINDLE-----	10-8
CRANKSHAFT -----	10-10
CRANKCASE INSTALLATION-----	10-12

10. CRANKCASE/CRANKSHAFT/TRANSMISSION SYSTEM/STARTER SPINDLE

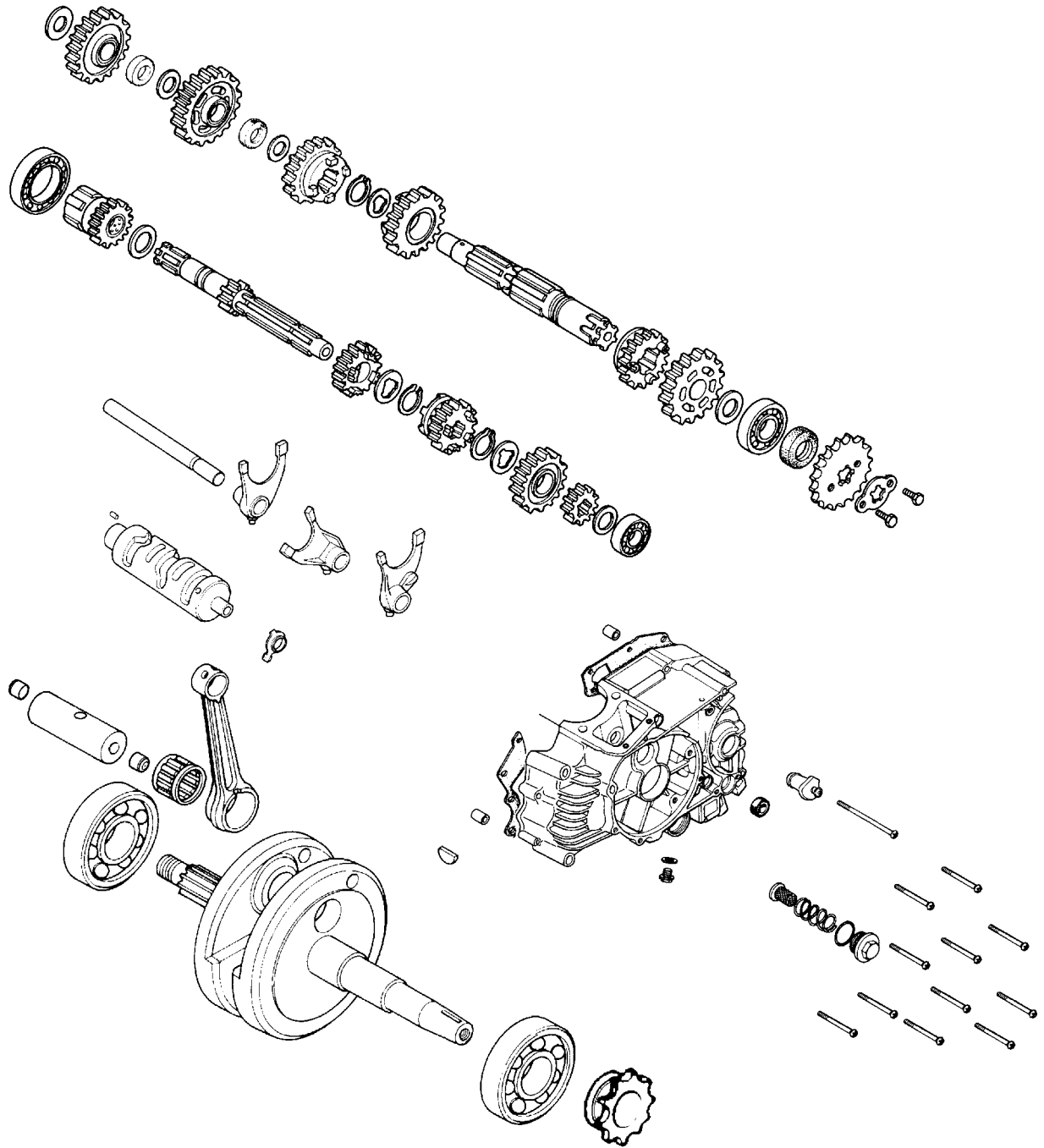

SERVICE INFORMATION

GENERAL INSTRUCTIONS

- During crankcase separation, do not separate the crankcase halves with an iron hammer to avoid crankcase deformation or damage.
- After separation, be careful not to damage the right and left crankcase mating surfaces to avoid oil leakage.
- Replace the gasket with a new one during reassembly of the crankcase halves.
- After transmission system disassembly, make sure that the gear shifting operation is normal before reassembly of the remaining parts.
- Apply engine oil to the transmission system and crankshaft before reassembly.

SPECIFICATIONS

Item		Standard (mm)	Service Limit (mm)	
Balance shaft	Left	16.964 ~ 16.984	< 16.924	
	Right	16.964 ~ 16.984	< 16.924	
Transmission fork	Claw thickness	4.93 ~ 5.0	< 4.43	
	Shaft hole I.D.	12 ~ 12.018	> 12.058	
Transmission fork shaft O.D.		11.976 ~ 11.994	< 11.936	
Transmission drum O.D.	Left	12.966 ~ 12.984	< 12.926	
	Right	20.959 ~ 20.98	< 20.919	
Transmission gear	Gear I.D.	Main shaft starter gear	20.055 ~ 20.095	> 20.135
		Main shaft 4th gear	20 ~ 20.021	> 20.061
		Main shaft 5th gear	20.02 ~ 20.041	> 20.061
		Countershaft starter idle	19.52 ~ 19.541	> 19.581
		Countershaft 1st gear	20.02 ~ 20.041	> 20.081
		Countershaft 2nd gear	22.020 ~ 22.041	> 22.081
		Countershaft 3rd gear	20 ~ 20.021	> 20.061
	Main Shaft O.D.	Left crankcase side	14.978 ~ 14.989	< 14.938
		Starter gear	19.959 ~ 19.98	< 19.919
		4th/5th gear	19.959 ~ 19.98	< 19.919
	Countershaft O.D.	Right crankcase	14.966 ~ 14.984	< 14.926
		Left crankcase	21.959 ~ 21.98	< 21.919
		1st gear	16.466 ~ 16.484	< 16.426
		2nd gear	21.959 ~ 21.98	< 21.919
3rd gear		19.959 ~ 19.98	< 19.919	
Crankshaft	Connecting rod big end side clearance	0.05 ~ 0.3	> 0.8	
	Connecting rod big end radial	0 ~ 0.008	> 0.05	
	Runout	0.03	> 0.1	

SPECIAL TOOLS

Bearing remover
Bearing remover block
Universal bearing puller
Bearing outer driver, 32x35mm
Bearing outer driver, 37x40mm
Bearing outer driver, 42x47mm
Bearing outer driver, 52x55mm
Pilot, 15mm
Pilot, 17mm
Pilot, 20mm
Pilot, 22mm
Inner bearing driver handle
Bearing outer driver, I.D. 30mm

TROUBLESHOOTING

Excessive engine noise

- Worn main shaft journal bearing
- Worn crankshaft pin bearing
- Worn transmission bearings

Transmission gear tripping

- Worn gear teeth
- Bent transmission fork
- Bent transmission fork shaft
- Damaged gear shift cam stopper

Hard shifting

- Improperly adjusted clutch
- Bent or damaged transmission fork
- Bent transmission fork shaft
- Bent gear shift spindle
- Damaged transmission drum grooves

CRANKCASE REMOVAL

The following parts must be removed before removing the crankcase:

- Cylinder head (Refer to Section 6.)
- Cylinder/piston (Refer to Section 7.)
- Starter motor/generator/left crankcase cover/starter clutch/camshaft (Refer to Section 8.)
- Clutch/gear shift mechanism (Refer to Section 9.)

Turn the engine so that the left crankcase is facing up.

Remove the eleven crankcase attaching screws. Separate the left and right crankcase halves.

* Never pry the crankcase apart with a driver to avoid damaging the mating surfaces.

Slightly tap the crankcase to separate the crankcase halves using a plastic hammer.

Remove the gasket and dowel pins.

* Be careful not to lose the gear shift spindle washer.

TRANSMISSION SYSTEM REMOVAL

Remove the transmission fork shaft and transmission forks.

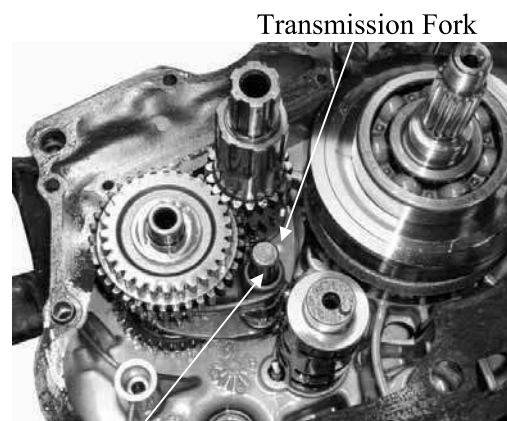
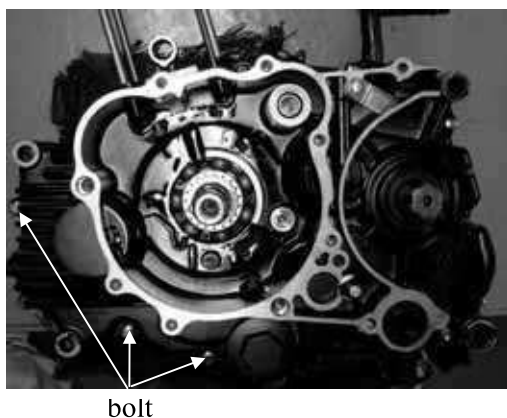
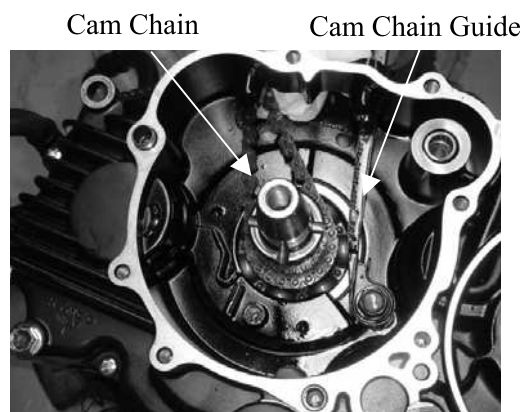

Remove the transmission drum.



Transmission Drum

INSPECTION

TRANSMISSION FORK/DRUM INSPECTION

Inspect each transmission fork for bending or damage.

Measure each transmission fork claw thickness.

Service Limit: 4.43mm replace if below

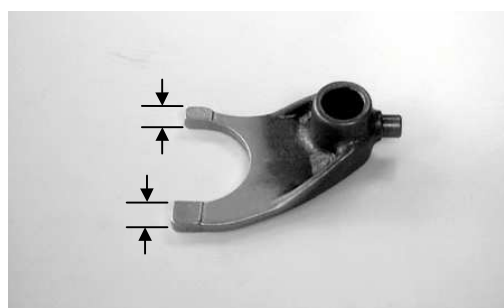

Measure each transmission fork shaft hole I.D.

Service Limit: 12.058mm replace if over

Check the transmission fork shaft for bending or damage.

Measure the transmission fork shaft O.D.

Service Limit: 11.936mm replace if below

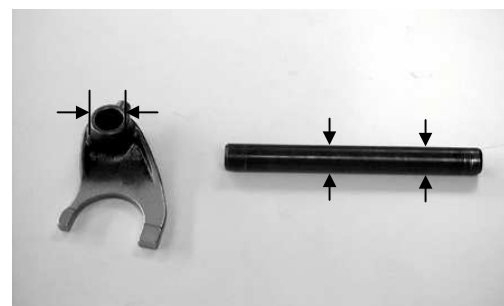

Inspect the transmission drum for scratches or poor lubrication.

Check the transmission drum grooves for damage.

Check the bearing for excessive free play.

Measure the transmission drum O.D.

Service Limits:

Left : 12.926mm replace if below

Right : 20.919mm replace if below

Check the transmission drum and transmission fork shaft holes in the left and right crankcase halves for wear or damage.

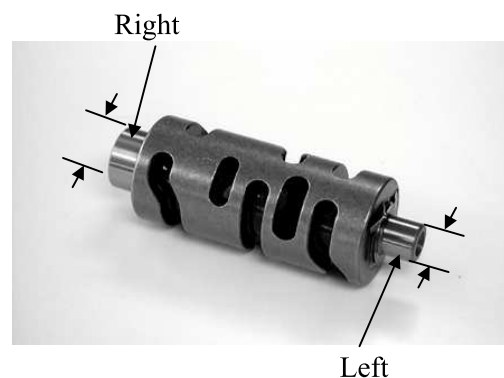

BALANCE SHAFT REMOVAL.

Remove the balance shaft assembly.

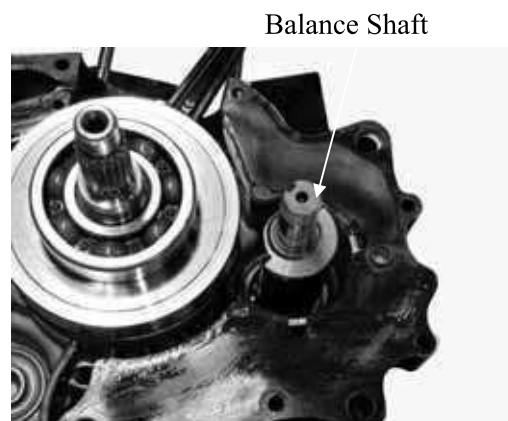

INSPECTION

Inspect the balance shaft for deformation and damaged grooves.

Measure the balance shaft O.D..

Service Limits:

Left : 16.924mm

Right : 16.924mm

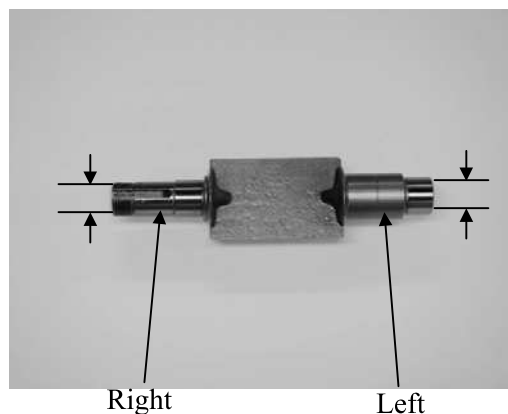

BALANCE SHAFT BEARING REPLACEMENT

Remove the balance shaft bearing from the right crankcase halves using the following tools.

Drive in new bearings using a bearing driver.

- * Apply engine oil to the bearing before installation.
- * Drive in bearings squarely.

Special Tool



TRANSMISSION GEARS/ CRANKSHAFT REMOVAL

Remove the transmission main shaft and countershaft from the right crankcase.

- * When removing, the transmission gears must be removed as a set.

Remove the crankshaft.

Disassemble the main shaft and countershaft.

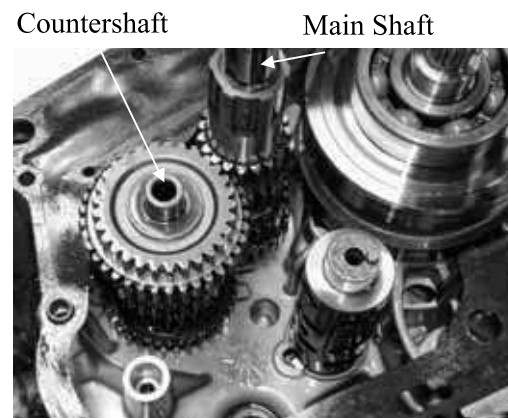

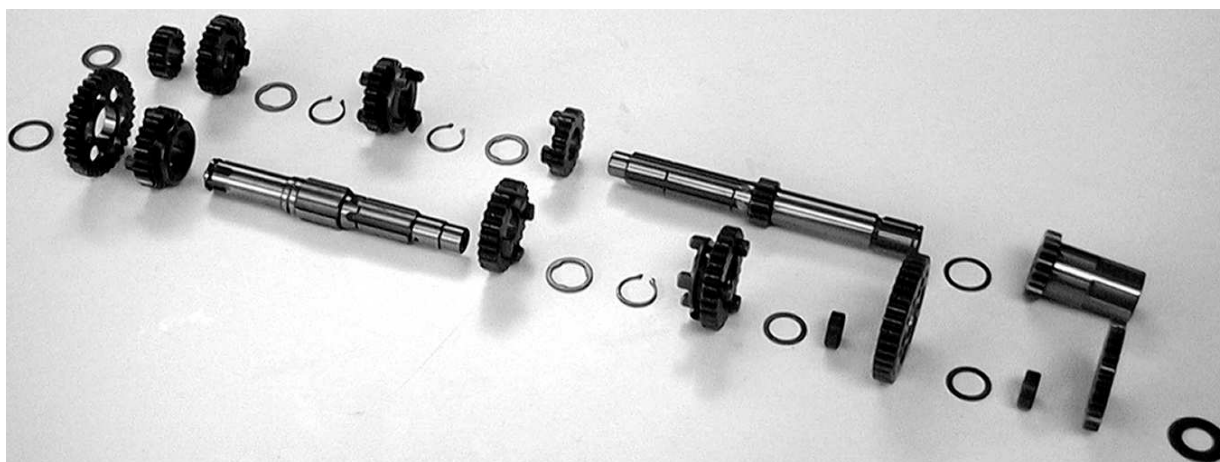

GEAR/SHAFT COLLAR INSPECTION

Check each gear and gear teeth for wear, damage, or poor lubrication.

Measure each gear I.D.

Service Limits:

- Main shaft 4th/5th gear:
20.061mm replace if over
- Countershaft 3rd gear:
20.061mm replace if over
- Countershaft 2nd gear:
22.081mm replace if over



Measure each shaft collar I.D.

Service Limits:

- Countershaft starter idle gear:
16.6mm replace if over
- Countershaft 1st gear:
16.6mm replace if over

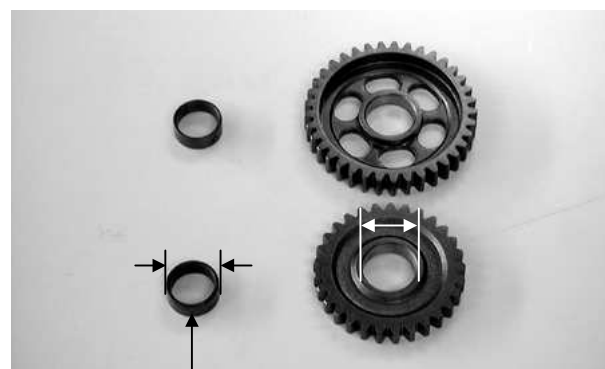

Shaft Collar

Measure each shaft collar O.D.

Service Limits:

- Countershaft starter idle gear:
19.73mm replace if below
- Countershaft 1st gear:
19.23mm replace if below

10. CRANKCASE/CRANKSHAFT/TRANSMISSION SYSTEM/STARTER SPINDLE

Inspect the main shaft and countershaft for wear or damage.

Measure the main shaft and countershaft O.D.

Service Limits:

Main Shaft:

Starter gear : 19.919mm replace if below

4th/5th gear: 19.919mm replace if below

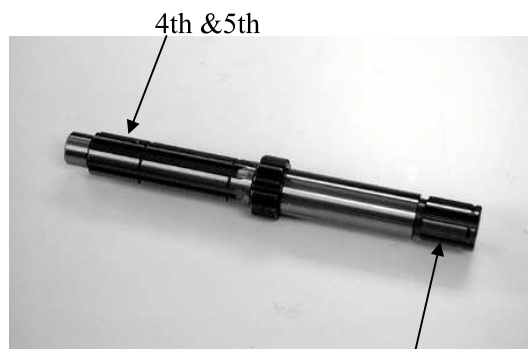

Main shaft

Countershaft:

Starter idle gear: 14.926mm replace if below

1st gear: 16.426mm replace if below

2nd gear: 21.919mm replace if below

3rd gear: 19.919mm replace if below

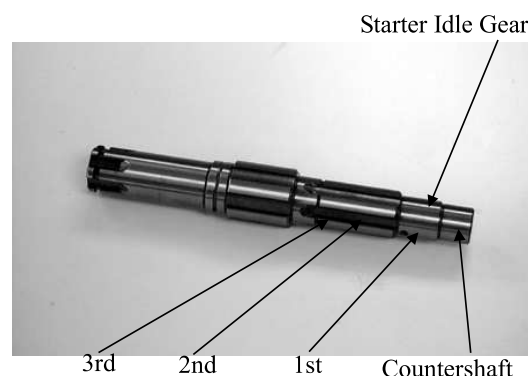

STARTER SPINDLE

Disassemble the starter spindle.



Inspect the starter ratchet and starter pinion for wear or damage and replace with new ones if necessary.

Inspect the starter spindle return spring for deformation or damage and replace with a new one if necessary.

Measure the starter ratchet I.D.

Service Limit: 20.10mm replace if over

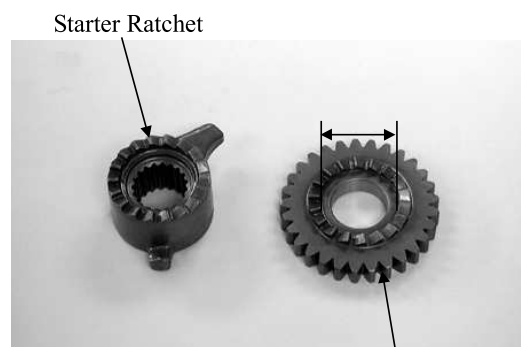

Starter Pinion

STARTER SPINDLE INSPECTION

Inspect the starter spindle for wear or damage.
Measure the starter spindle O.D.

Service Limits:

A2 : 15.95mm replace if below

B : 19.95mm replace if below

A1 : 11.95mm replace if below

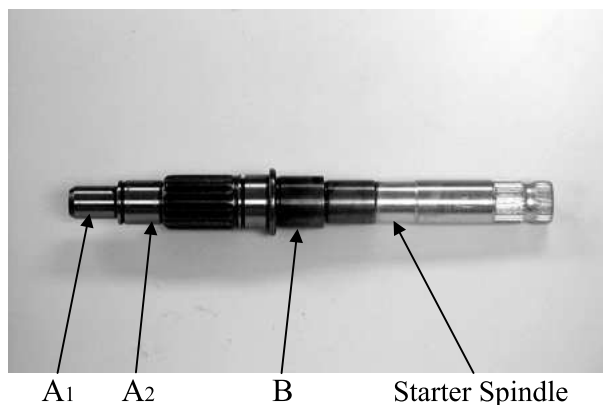

BEARING INSPECTION

Check the main shaft, countershaft and balance shaft bearings for smooth turning. Replace the bearings with new ones if they do not turn smoothly, quietly, or if they fit loosely in the case. If the countershaft needle bearing in the right crankcase is noisy or has excessive free play, replace it with the crankcase as a set.

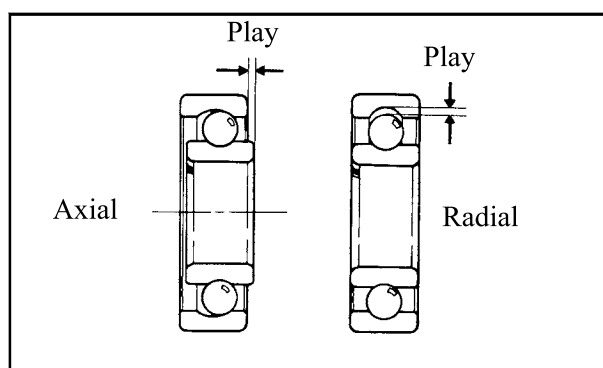

BEARING REPLACEMENT

Remove the main shaft and countershaft bearings from the left and right crankcase halves using the following tools.

Special Tool

- Bearing Remover
- Bearing Remover Block

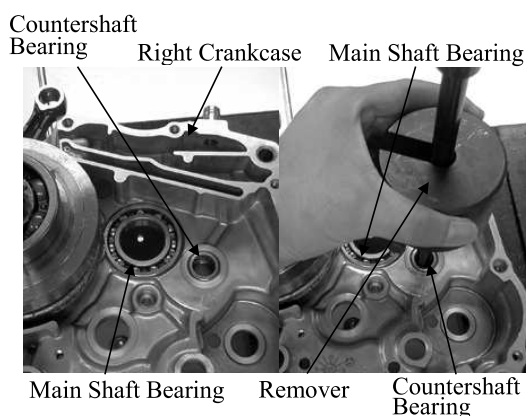

Drive in new bearings using a bearing driver.

- * Apply engine oil to the bearings before installation.
- * Drive in bearings squarely.

Special Tool

- Bearing Driver



CRANKSHAFT

INSPECTION

Measure the connecting rod big end side clearance.

Service Limit: 0.80mm replace if over

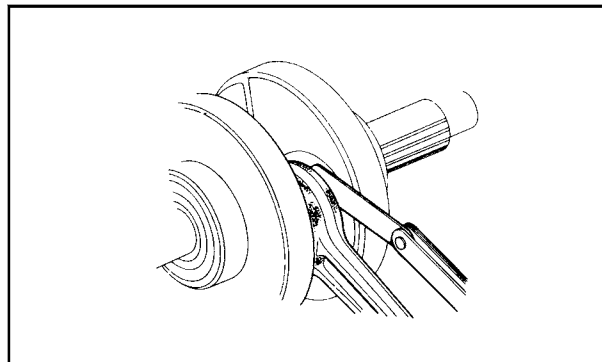

Measure the crankshaft runout.

Service Limit: 0.1mm replace if over

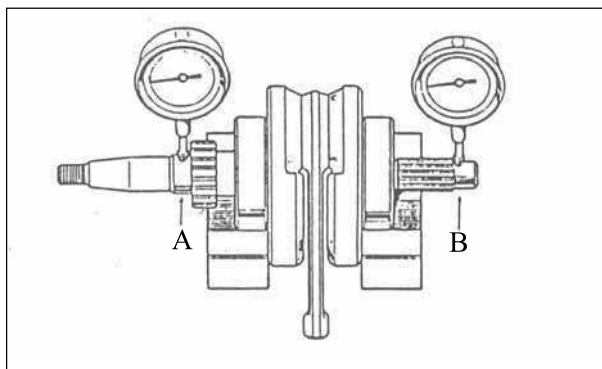

Check the crankshaft bearings for noise or excessive free play.
Replace if necessary.

* Drive out the crankshaft bearings using the universal bearing puller.

Special Tool

Universal Bearing Puller E030

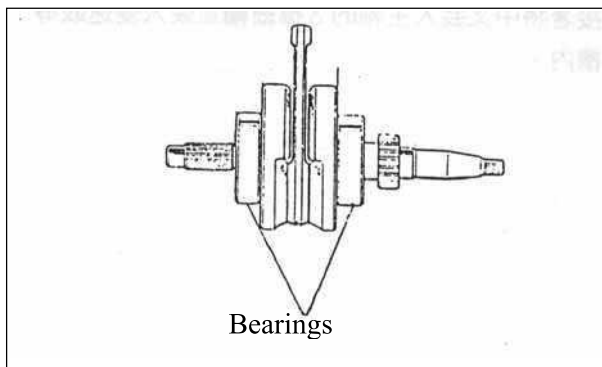

INSTALLATION

Install the starter spindle onto the right crankcase.

- * When installing the starter spindle, be sure to insert the return spring end into the crankcase hole.

Install the washer.

First assemble the main shaft and countershaft and then install them into the right crankcase.

- * When assembling the main shaft and countershaft, be sure to install all of the washers.

Install the balance shaft.

Install the transmission drum

Install the right transmission fork to the countershaft 4th gear. Raise the gear and install the transmission fork guide pin into the transmission drum groove.

- * The transmission fork can be installed more easily by turning the neutral light copper piece on the transmission drum toward the cylinder.

Then, install the middle transmission fork to the main shaft 3rd gear and install the fork guide pin into the transmission drum groove.

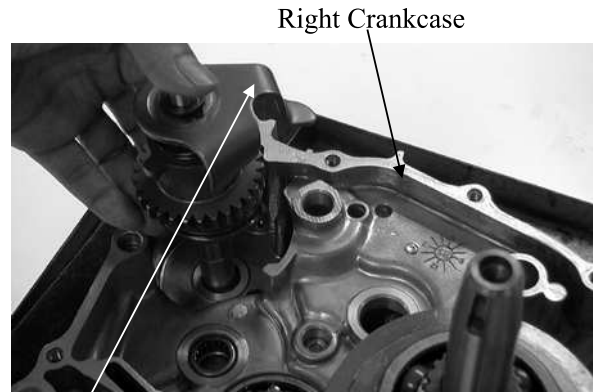

Starter Pawl

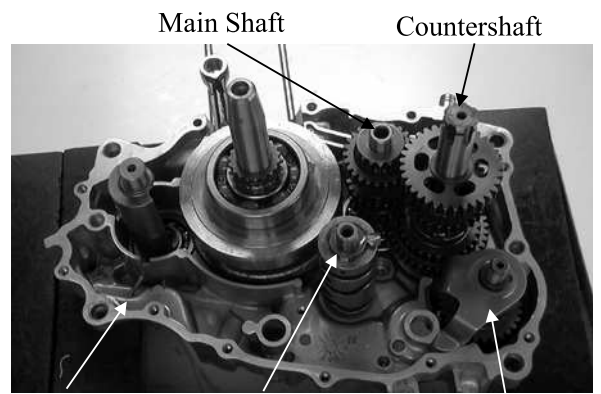

Right Crankcase Transmission Drum Starter Spindle



Transmission Drum Right Transmission Fork



Middle Transmission Fork Right Transmission Fork

10. CRANKCASE/CRANKSHAFT/TRANSMISSION SYSTEM/STARTER SPINDLE

Install the left transmission fork to the countershaft 5th gear and install the fork guide pin into the transmission drum groove. Install the transmission fork shaft.

- * After installation, make sure that the main shaft and countershaft are parallel.

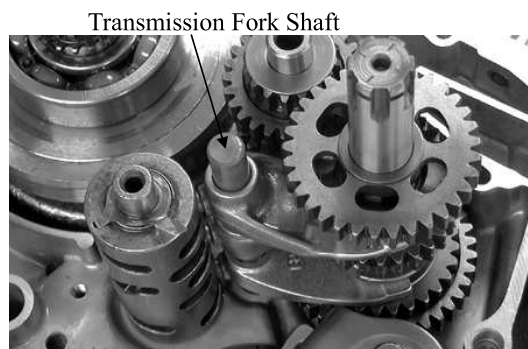

Install the crankshaft.

- * Install the crankshaft squarely and do not strike it in forcedly.

Install the dowel pins and gasket.



Gasket

Crankshaft

CRANKCASE INSTALLATION

- *
 - Install the left crankcase by aligning the starter spindle with the left crankcase hole.
 - When installing the left crankcase, make sure that the dowel pins and gasket do not tilt to avoid oil leakage.

Tighten the eleven crankcase attaching screws.

Torque: 0.8~1.2kg-m

- * Tighten the crankcase attaching screws diagonally and evenly.

Install the following parts:

- Starter motor/generator/left crankcase cover/starter clutch/camshaft (Refer to Section 8.)
- Clutch/gear shift mechanism (Refer to Section 9.)
- Cylinder/piston (Refer to Section 7.)
- Cylinder head (Refer to Section 6.)



FRONT WHEEL/SUSPENSION/STEERING

SERVICE INFORMATION----- 11- 2
TROUBLESHOOTING----- 11- 3
HANDLEBAR ----- 11- 4
FRONT WHEEL ----- 11- 7
FRONT FORK ----- 11-11
STEERING STEM----- 11-15

11. FRONT WHEEL/SUSPENSION/ STEERING

SERVICE INFORMATION

SPECIFICATIONS

Item	Standard (mm)	Service Limit (mm)
Front axle shaft runout	—	0.2
Front wheel rim runout	Axial	0.5
	Radial	0.5
Front fork spring free length	456.8	< 450.8
Front fork tube runout	—	0.2
Front fork oil capacity	202 cc	—

TORQUE VALUES

Steering stem nut	6.0~8.0 kg-m	Front axle nut	5.0~6.0 kg-m
Upper fork bridge bolt	0.9~1.3 kg-m	Front fork upper mount bolt	3.0~4.0 kg-m
Master cylinder holder bolt	1.0 kg-m	Front fork lower mount bolt	3.0~4.0 kg-m
Front brake disk nut	1.5 kg-m		

SPECIAL TOOLS

Steering stem driver
Steering stem wrench
Ball race remover
Bearing remover
Bearing remover head, 12m
Bearing remover head, 17m
Bearing driver handle
Attachment, 32x35mm
Attachment, 32x35mm
Attachment, 37x40mm
Fork seal driver
Pilot, 17mm

TROUBLESHOOTING

Hard steering

- Insufficient tire pressure
- Excessively tightened steering stem nut
- Damaged steering stem bearings
- Damaged steering bearing races

Steers to one side or does not track straight

- Uneven front shock absorbers
- Bent front fork
- Bent front axle or uneven tire

Front wheel wobbling

- Improperly tightened axle nut
- Bent rim
- Worn front wheel bearing
- Faulty tire

Soft suspension

- Weak fork springs
- Insufficient front fork oil

Hard suspension

- Incorrect front fork oil level
- Bent front fork tube
- Clogged front fork oil passages

Front suspension noise

- Slider bending
- Loose front fork fasteners
- Insufficient front fork oil
- Worn front fork bearing
- Insufficient speedometer gear grease

11. FRONT WHEEL/SUSPENSION/ STEERING

HANDLEBAR

REMOVAL

Remove the two throttle cover screws and the throttle cover.

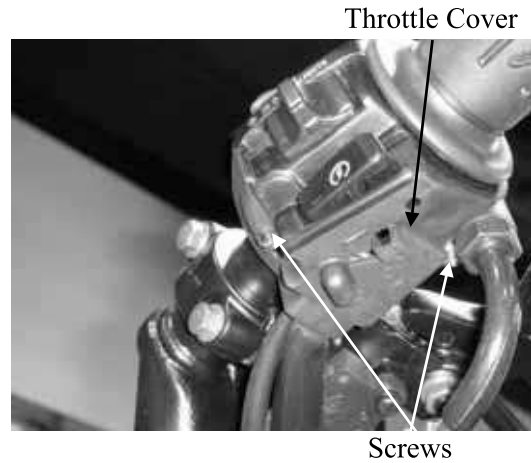

Disconnect the throttle cable from the throttle grip and then remove the throttle pipe from the handlebar.

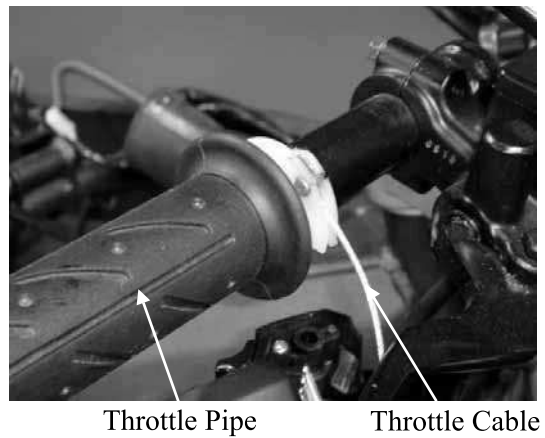

Remove the two master cylinder holder bolts and the master cylinder.

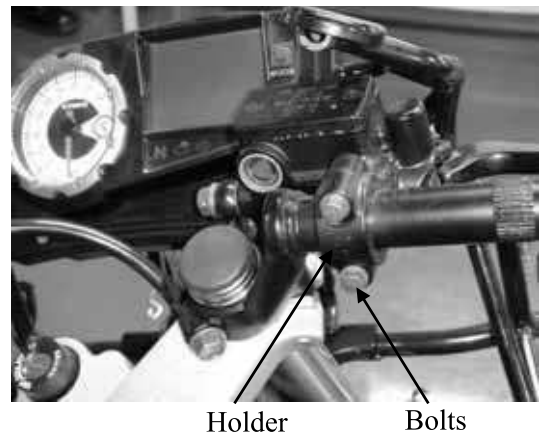

Remove the two left handlebar switch housing screws, then separate and remove the housing.
Remove the two clutch lever holder bolts and the clutch lever holder.

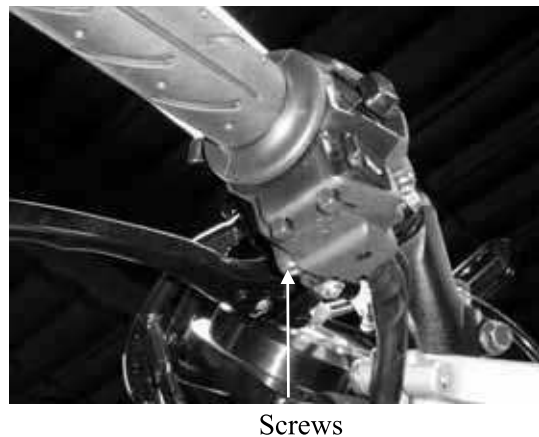

11. FRONT WHEEL/SUSPENSION/ STEERING

Remove the two handlebar bolts to remove the handlebar.

INSTALLATION

Install the handlebar in the reverse order of removal.

Torque: 0.8~1.2kg-m



Bolts

When installing the right and left handlebar switch housings, align the pin on the housing with the hole in the handlebar. Tighten the two switch housing screws.

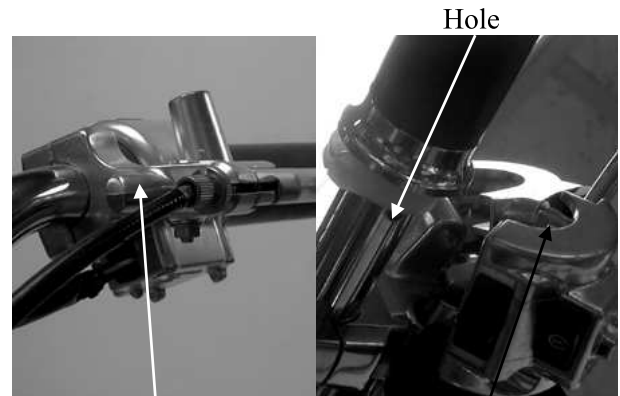

Clutch Lever Holder

Hole

Pin

When installing the master cylinder and clutch lever holders, align the tab on the holder with the hole in the handlebar with the holder "UP" mark facing up. First tighten the upper bolt and then the lower bolt.

Torque: 1.0~1.4kg-m

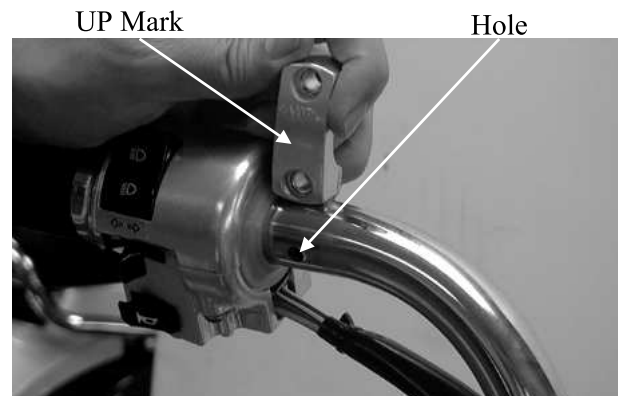

UP Mark

Hole

11. FRONT WHEEL/SUSPENSION/ STEERING

THROTTLE PIPE INSTALLATION

Clean the handlebar surface and install the throttle pipe. Check the throttle grip for proper operation.



Throttle Pipe

Connect the throttle cable to the throttle grip. Apply grease to the throttle cable. Install the throttle cover by aligning the pin on the cover with the hole in the handlebar and then tighten the two screws.

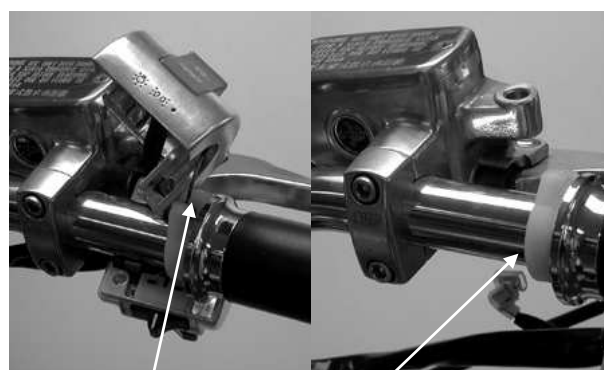

Throttle Cable

Hole

11. FRONT WHEEL/SUSPENSION/ STEERING

FRONT WHEEL

REMOVAL

Place a jack or other adjustable support under the engine to raise the front wheel off the ground.
Remove the speedometer cable set screw and disconnect the speedometer cable.
Remove the front axle nut and pull out the axle.
Remove the front wheel.

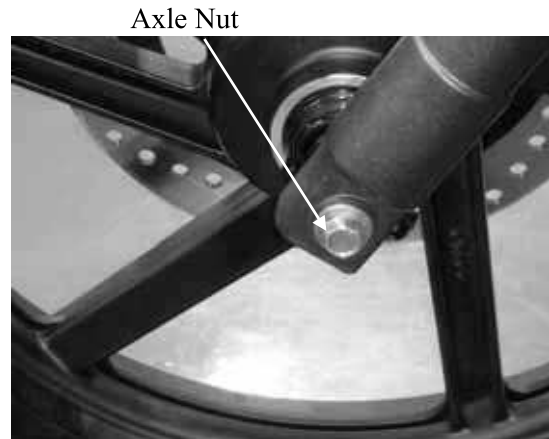

INSPECTION

Set the axle in V blocks and measure the runout using a dial gauge.
Service Limit: 0.2mm replace if over

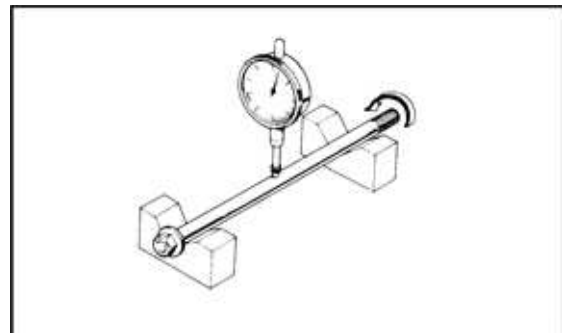

WHEEL RIM INSPECTION

Place the front wheel in a turning stand.
Spin the wheel by hand and measure the rim runout using a dial gauge.

Service Limits:

Axial: 2.0mm adjust if over

Radial: 2.0mm adjust if over

Check the wheel spoke wires for looseness.
If the wheel rim is made of aluminum alloy, replace with a new one if necessary.

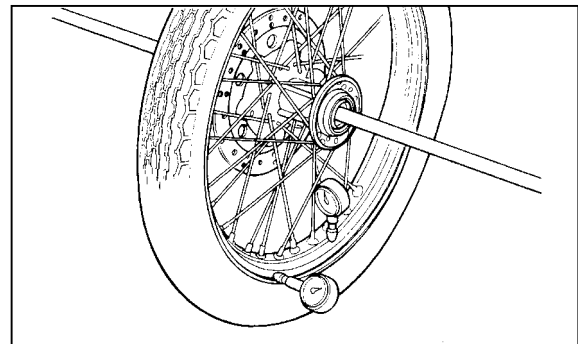

Check the wheel bearing play by placing the wheel in a turning stand and spinning the wheel by hand.
Replace the bearings if they are noisy or have excessive play.

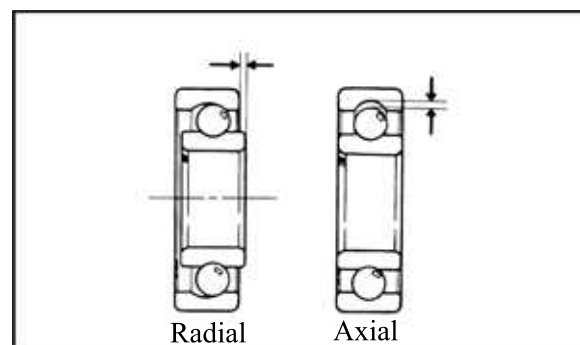

11. FRONT WHEEL/SUSPENSION/ STEERING

ASSEMBLY

Pack all bearing cavities with grease. First drive in the right bearing and then install the distance collar. Finally, drive in the left bearing.

Bearing Driver Handle



Install the brake disk and tighten the five nuts.
Apply grease to the dust seal and install the dust seal.



Dust Seal
Grooves

Brake Disk
Flange Tab

Install the speedometer gearbox by aligning the tabs with the grooves.

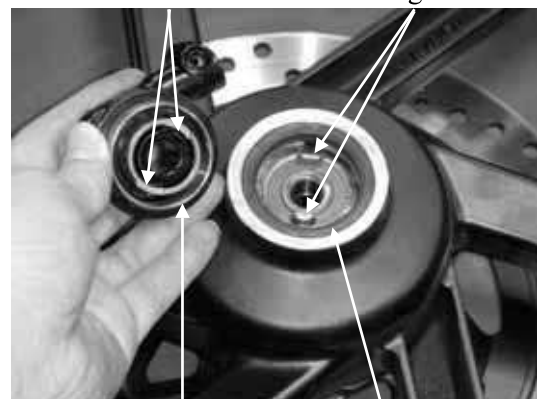

Speedometer Gearbox

Dust Seal

Apply grease to the speedometer gearbox and dust seal, then install them to the wheel from the left side.

11. FRONT WHEEL/SUSPENSION/ STEERING

Install the axle collar to the right side of the wheel.



INSTALLATION

Install the front wheel onto the front fork, aligning the tab on the front fork with the groove in the speedometer gearbox.

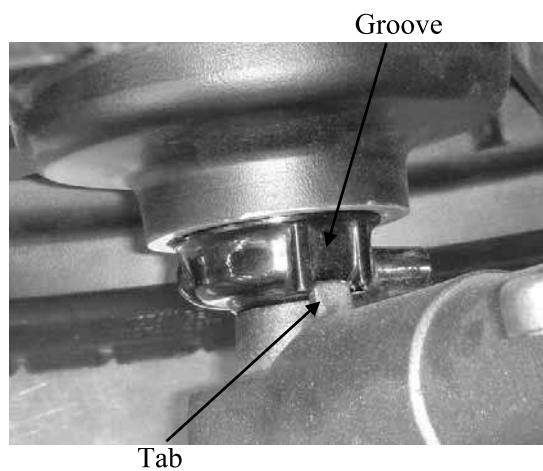

Insert the axle shaft and tighten the axle nut.

Torque: 5.5~7.0kg-m

Connect the speedometer cable and secure it with the screw.

* Install the speedometer cable by aligning the groove with the tab.

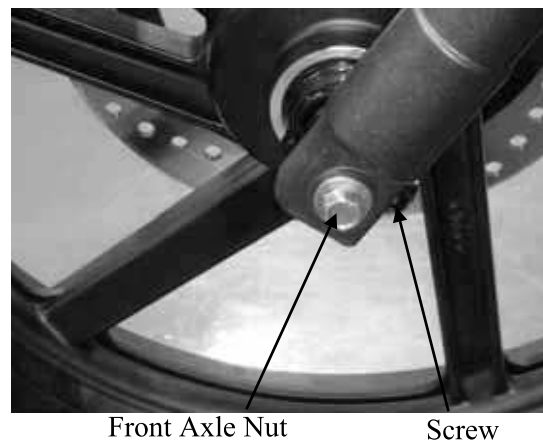

FRONT FORK

REMOVAL

Remove the front wheel. (Refer to 11-7.)
Remove the six front fender bolts and the front fender.
Remove the front brake caliper.
Loosen the upper and lower fork bridge bolts.

Remove the right and left front forks.

Upper Fork Bridge Bolts

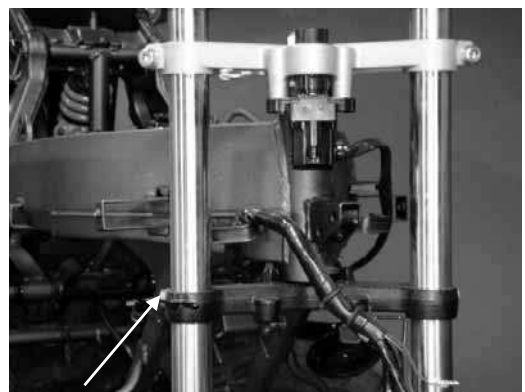

Lower Fork Bridge Bolt

DISASSEMBLY

Place shop towels under the front fork tube.
Use a vise to hold the front fork tube and remove the bolt.

* When removing the front fork bolt, be careful that the spring in the tube may spring out.

Remove the front fork spring from the front fork tube and compress the spring several times to squeeze out the engine oil.



Front Fork Bolt

Use a vise to hold the front fork bottom tube and place shop towels under the bottom tube.
Remove the socket head bolt.

*

- When using the vise, do not tighten the front fork bottom tube excessively.
- If it is difficult to remove the socket head bolt, temporarily install the front fork spring and front fork bolt.

Remove the front fork piston and return spring. Remove the front fork bottom tube and the oil stopper.



6mm Socket Spanner

11. FRONT WHEEL/SUSPENSION/ STEERING

Remove the dust seal and snap ring. Take out the oil seal and circlip.

*

- Do not damage the bottom tube when taking out the oil seal and circlip.
- Be sure to replace the removed oil seal and circlip with new ones during assembly.

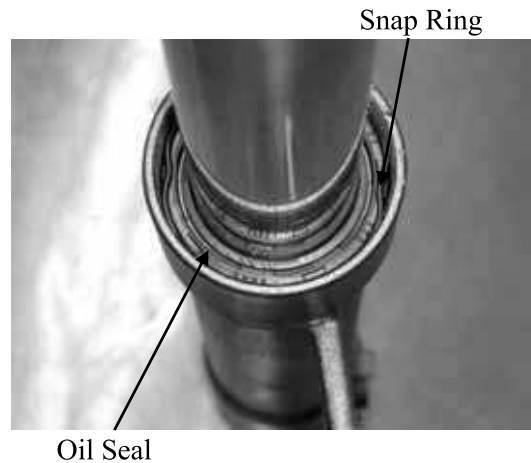

INSPECTION

Measure the front fork spring free length.

Service Limit: 434.8mm replace if below

Replace the spring with a new one if it exceeds the service limit.



Set the front fork tube in V blocks and measure the tube runout.

Service Limit: 0.2mm replace if over

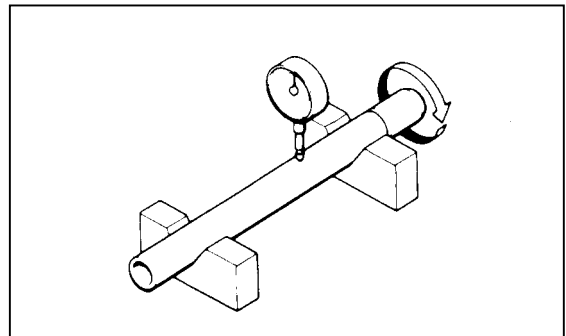

Check the front fork tube, bottom tube and piston for abnormal wear or damage and replace if necessary.

Check the front fork piston ring for wear.

Check the return spring for weakness or damage.

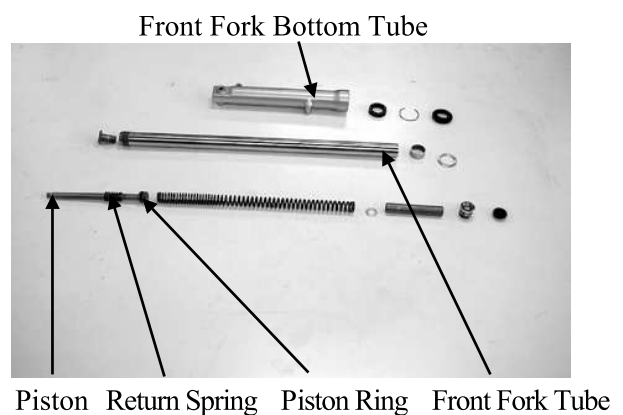

11. FRONT WHEEL/SUSPENSION/ STEERING

ASSEMBLY

Before assembly, clean the removed parts with high flash or non-flammable solvent.

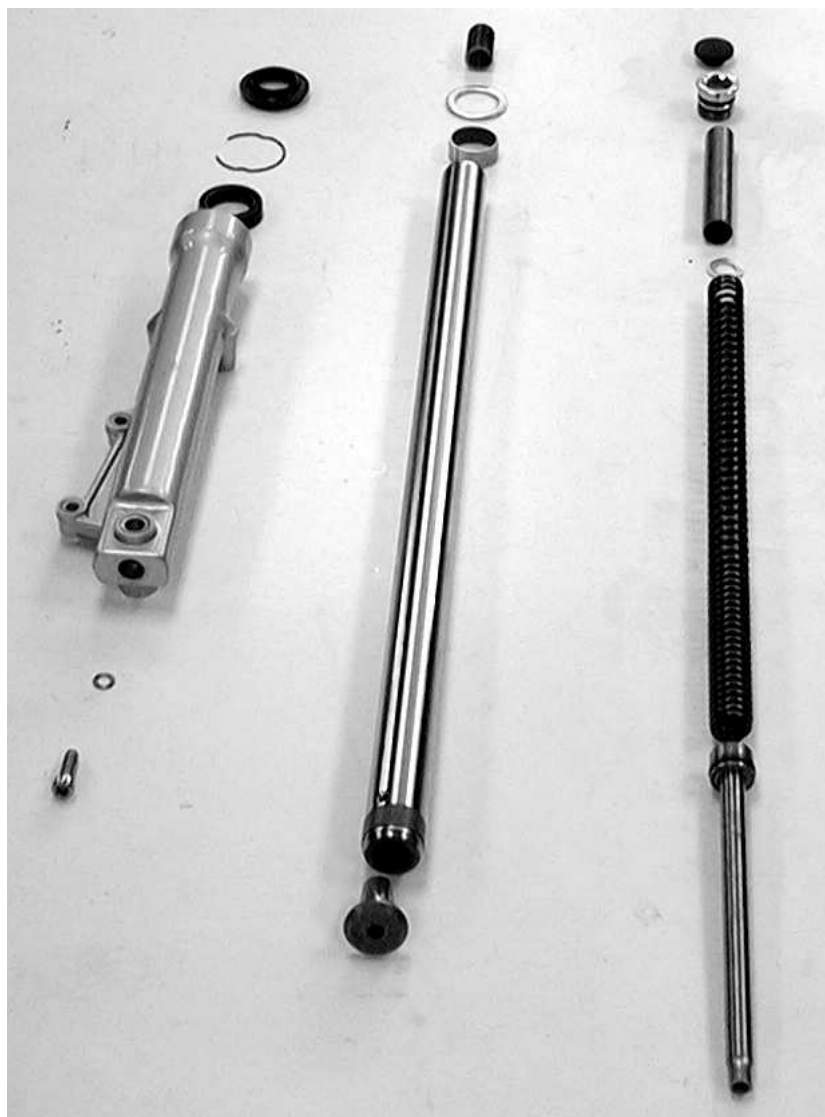

Install the return spring and piston into the front fork tube and then install oil stopper to the piston end.
Install the front fork tube into the bottom tube.



Piston

Front Fork Tube

11. FRONT WHEEL/SUSPENSION/ STEERING

Place shop towels under the bottom tube and set it in a vise. Apply locking agent to the socket head bolt and then install it into the piston. Tighten the socket head bolt using the socket spanner.

* When tightening the socket head bolt, temporarily install the front fork spring and front fork tube.

Torque: 1.5~2.5kg-m

6mm Socket Spanner



Apply engine oil to a new oil seal and install the oil seal using the fork seal driver. Then, install the snap ring and dust seal.



Fully compress the front fork and fill SAE8# engine oil into the front fork tube.

* Do not fill too much engine oil.

Specified Capacity: 202cc

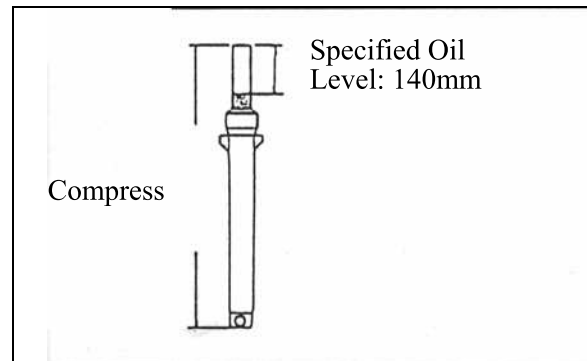

Install the front fork spring into the front fork tube with the closely wound coils facing down.

Install and tighten the front fork bolt.

Torque: 1.5~3.0kg-m

Install the front fork bolt rubber cover.

Front Fork Bolt



11. FRONT WHEEL/SUSPENSION/ STEERING

INSTALLATION

Install the front fork tubes into the upper and lower fork bridges.
Install and tighten the attaching bolts.

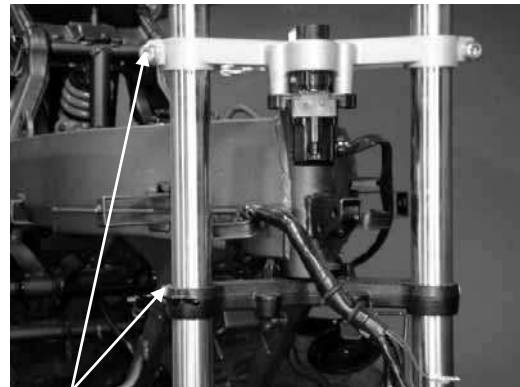

Bolts

Front Fender Installation

Install the front fender between the front fork tubes, then install and tighten the six bolts.

Torque: 0.8~1.2kg-m



Front Fender

STEERING STEM

REMOVAL

Remove the handlebar. (Refer to 11-4.)
Remove the front fork. (Refer to 11-11.)
Remove the steering stem nut using the lock nut wrench.

Lock Nut Wrench, 30x32mm



Adjusting nut

Remove the bearing adjusting nut, top cone race, steering stem and steel balls.

* Place the steel balls in a parts tray so that they are not lost.



11. FRONT WHEEL/SUSPENSION/ STEERING

Remove the top and bottom ball races.

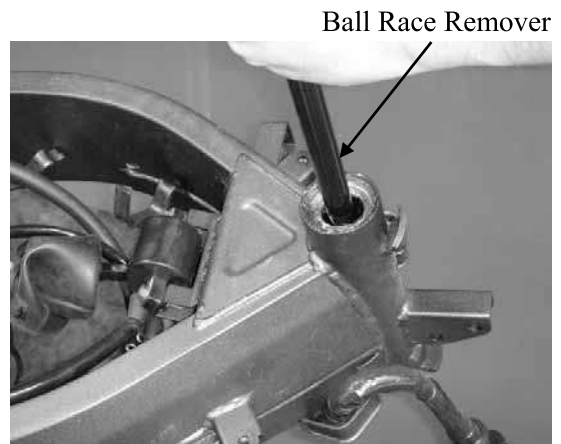

BALL RACE INSTALLATION

Drive the top and bottom ball races into the steering head using a bearing driver.



BOTTOM CONE RACE REPLACEMENT

Drive out the bottom cone race.
Install a new washer and dust seal onto the steering stem and then drive in a new bottom cone race onto the steering stem.



STEERING STEM INSTALLATION

Apply grease to the top and bottom ball races and steel balls.
Install 21 steel balls each on the top and bottom ball races.
Install the steering stem into the steering pipe and then install the top cone race and the bearing adjusting nut.



11. FRONT WHEEL/SUSPENSION/ STEERING

Tighten the bearing adjusting nut until it seats against the top cone race, then turn it back 1/8 turn.

*

Check that the steering stem rotates freely and that there is no vertical play.

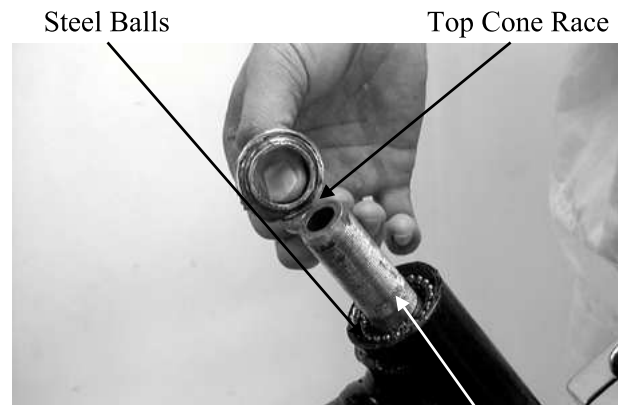

Steering Stem

Steering Stem Wrench

Install the front fork. (Refer to 11-15.)
Install the top fork bridge, washer and steering stem nut.
Tighten the steering stem nut.

Torque: 6.0~9.0kg-m

Properly adjust the installed front fork. (Refer to 11-15.)

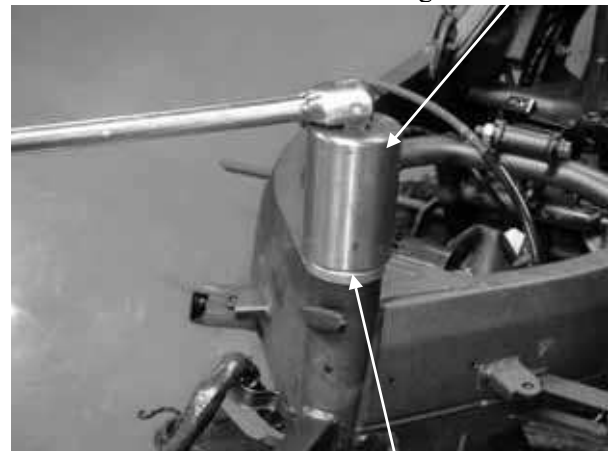

Steering Stem

12. REAR BRAKE/REAR FORK/REAR WHEEL/REAR SHOCK ABSORBER

REAR BRAKE/REAR FORK/REAR WHEEL/ REAR SHOCK ABSORBER

SCHEMATIC DRAWING-----	12-1
SERVICE INFORMATION-----	12-2
TROUBLESHOOTING -----	12-2
REAR BRAKE -----	12-3
REAR FORK -----	12-4
REAR WHEEL-----	12-5
REAR SHOCK ABSORBER -----	12-6

12. REAR BRAKE/REAR FORK/REAR WHEEL/REAR SHOCK ABSORBER



QUANNON 125

SCHEMATIC DRAWING

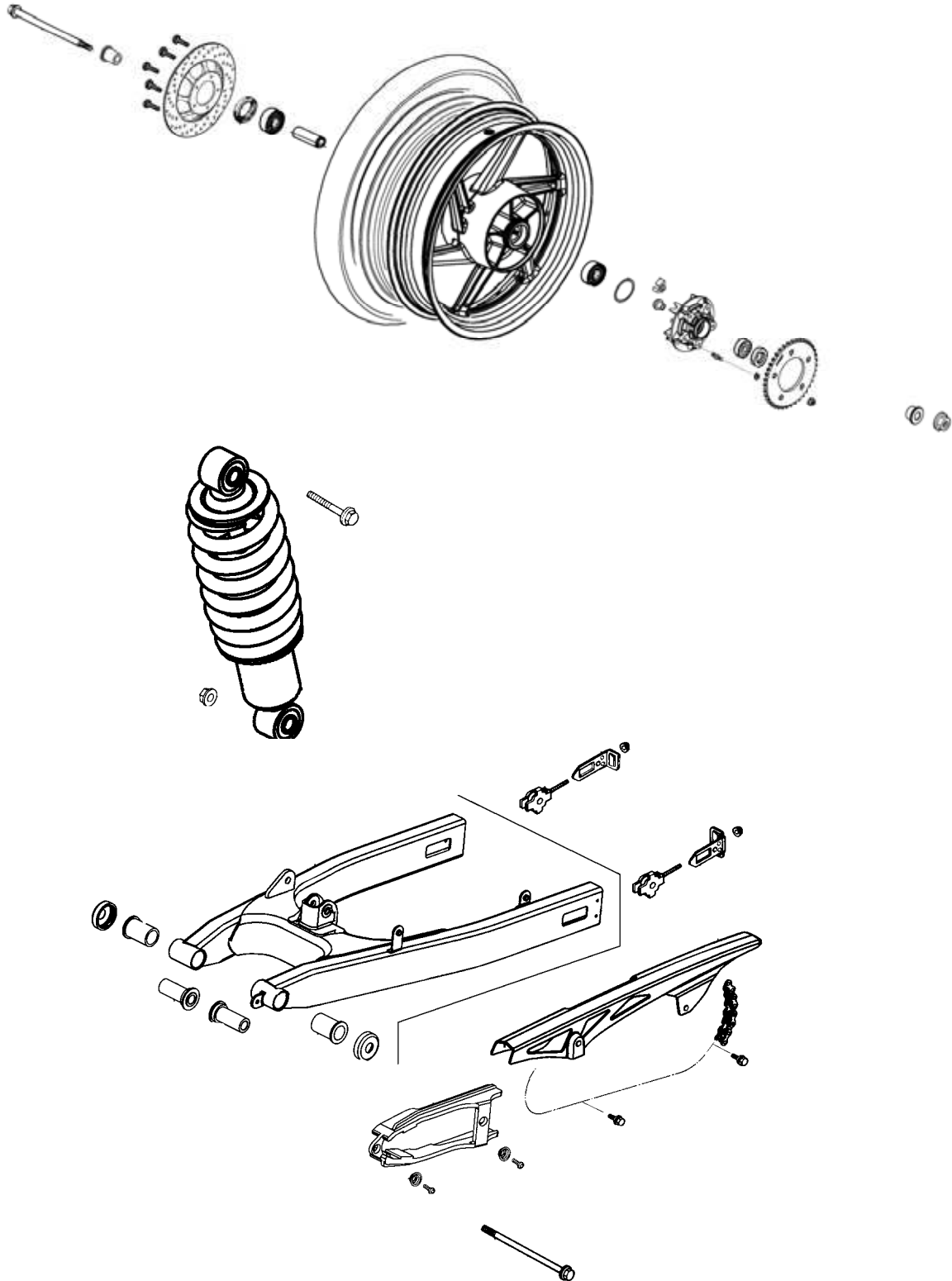

12. REAR BRAKE/REAR FORK/REAR WHEEL/REAR SHOCK ABSORBER

SERVICE INFORMATION

GENERAL INSTRUCTIONS

- When performing the services stated in this section, the engine and exhaust muffler must be cold to avoid scalding.
- During servicing, keep oil or grease off the brake pads and brake disk.

SPECIFICATIONS

Item	Standard (mm)	Service Limit (mm)
Rear wheel rim runout	—	2.0
Rear brake disk thickness	4.0	< 3.0
Rear brake disk runout	—	0.30

TORQUE VALUES

Rear fork pivot nut	5.5~7.0 kg-m
Rear axle nut	8.0~10.0 kg-m
Rear shock absorber lower mount bolt	3.0~4.0 kg-m
Rear shock absorber upper mount bolt	3.0~4.0 kg-m
Rear brake caliper holder bolt	2.4~3.0 kg-m

TROUBLESHOOTING

Rear wheel wobbling

- Bent rim
- Faulty tire
- Axle not tightened properly

Soft rear shock absorber

- Weak shock absorber spring
- Damper oil leaks

Rear wheel noise

- Worn rear wheel axle bearings
- Worn rear fork bearings
- Deformed rear fork

Poor brake performance

- Air in brake system
- Deteriorated brake fluid
- Contaminated brake pad surface
- Worn brake pads
- Clogged brake fluid line
- Deformed brake disk
- Unevenly worn brake caliper

12. REAR BRAKE/REAR FORK/REAR WHEEL/REAR SHOCK ABSORBER

REAR BRAKE

REAR BRAKE CALIPER REMOVAL

First remove the exhaust muffler.
Remove the rear brake fluid tube bolt and disconnect the brake fluid tube.
Remove the two bolts attaching the rear brake caliper.
Remove the rear brake caliper.

* When removing the brake fluid tube, use shop towels to cover plastic parts and coated surfaces to avoid damage.

Fluid Tube Bolt

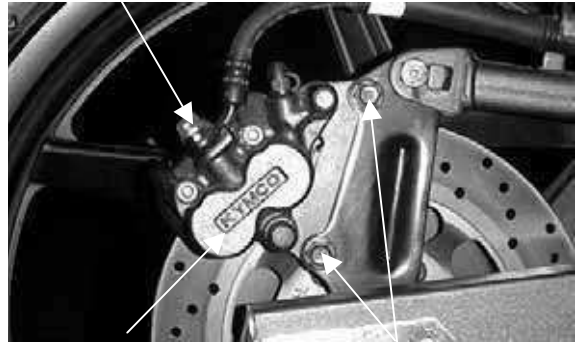

Brake Caliper

Bolts

INSPECTION

Inspect the brake pads and brake disk.

Measure the brake disk thickness.

Service Limit: 3.0mm replace if below

Brake Disk

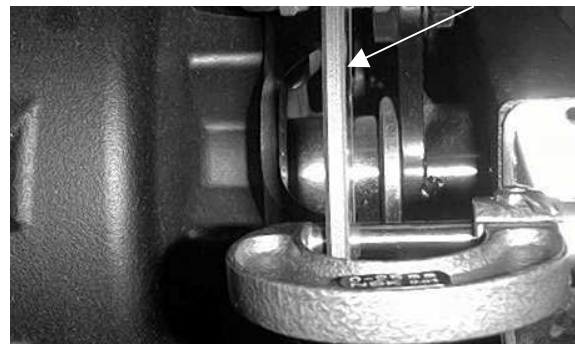

Visually check the brake pad thickness and it should not exceed the wear indicator mark.

DISASSEMBLY

Remove the two brake pads dowel pins and three bolts from the brake caliper.

Remove the brake pads.

Brake Pads

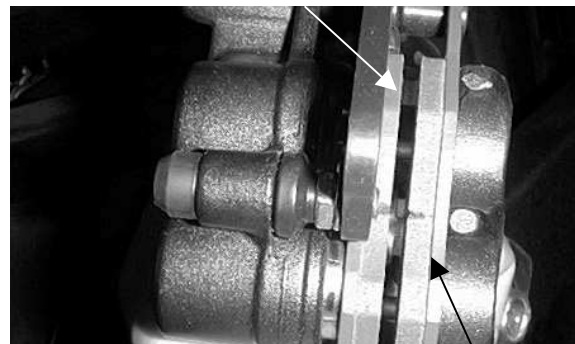

Wear Indicator Mark

ASSEMBLY

Install the two spring plate into the groove of the caliper.

* Make sure the spring plate next to the brake pad dowel pin orientation.

Install the two brake pads and brake pad dowel pin.

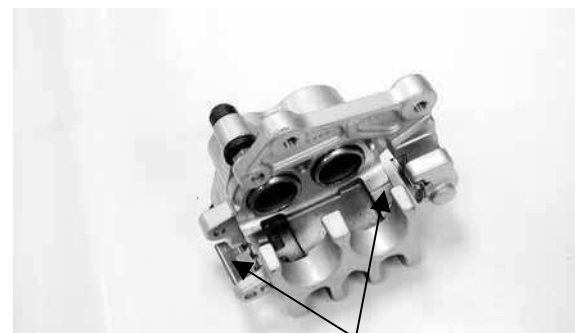

Spring Plate

12. REAR BRAKE/REAR FORK/REAR WHEEL/REAR SHOCK ABSORBER

INSTALLATION

Install the brake caliper to the rear fork and tighten the two bolts.

Torque: 2.4~3.0 kg-m

Connect the brake fluid tube to the brake caliper and install fluid tube bolt, copper washers and tighten the fluid tube bolt.

Torque: 3.0~4.0 kg-m

Fill the brake reservoir with the specified brake fluid and bleed air from the brake system. (⇒14-10)

* When installing the brake fluid tube, be sure to install the two copper sealing washers.

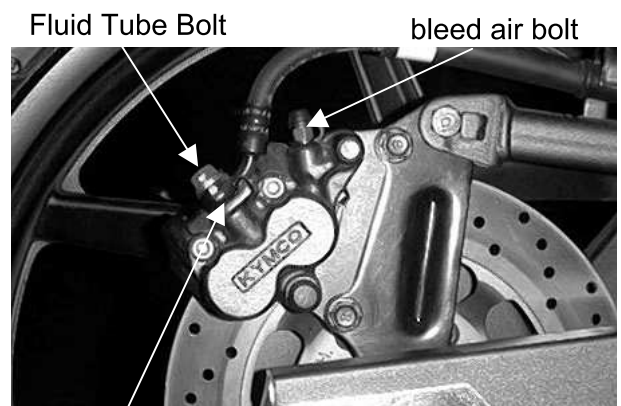
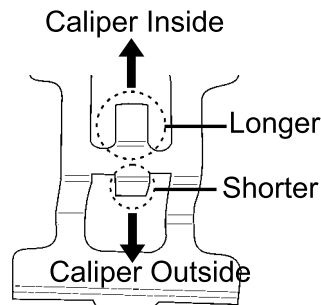

REAR FORK

REMOVAL

Remove the rear wheel.

Remove the rear shock absorbers.

Remove the cover the rear fork pivot nut to remove the pivot and rear fork.

Remove the drive chain slider and check for wear or damage.

When replacing the rear fork pivot bushings, press the new bushings into the rear fork completely.



INSTALLATION

Install the rear fork in the reverse order of removal.

Tighten the rear fork pivot nut.

Torque: 5.5~7.0 kg-m

After the rear fork is installed, install the following parts:

Rear shock absorbers

Rear wheel

Drive chain cover

Rear brake adjustment

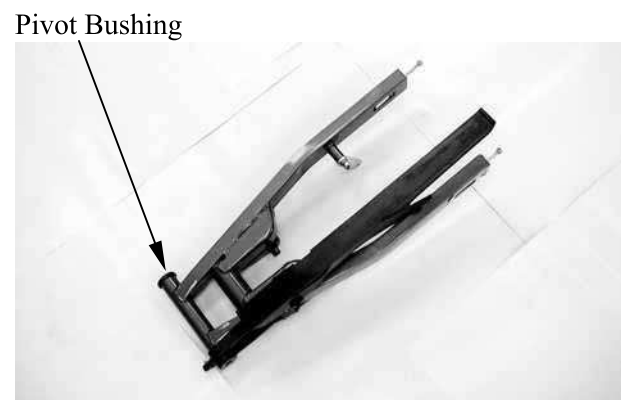

12. REAR BRAKE/REAR FORK/REAR WHEEL/REAR SHOCK ABSORBER

REAR WHEEL REMOVAL

Remove the exhaust muffler.
Remove the rear brake caliper.
Remove the rear axle collar.
Remove the chain drive.
Remove the rear wheel.

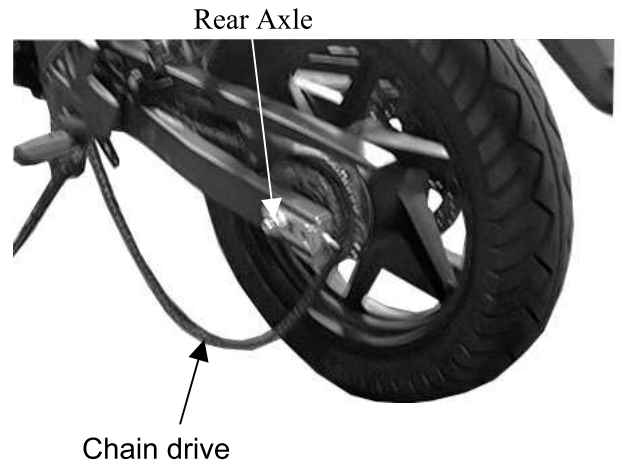

INSPECTION

Check the drive chain gear teeth for wear or damage.
Replace the drive chain gear if necessary.

* If the drive chain gear teeth are worn or damaged, also check the drive chain and replace if necessary.

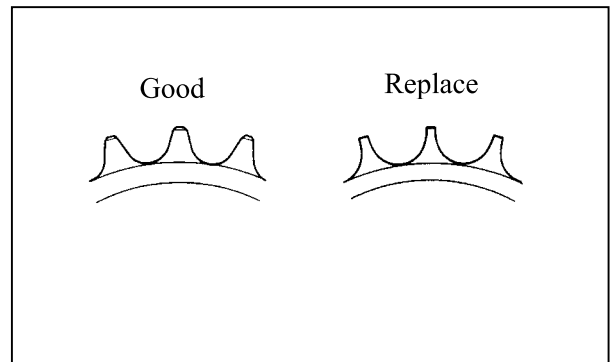

DISASSEMBLY

Remove the side collar and dust seal from the left side of the rear wheel.
Remove the four drive chain gear lock nuts.
Remove the drive chain gear.
Check the damping bushings for damage.

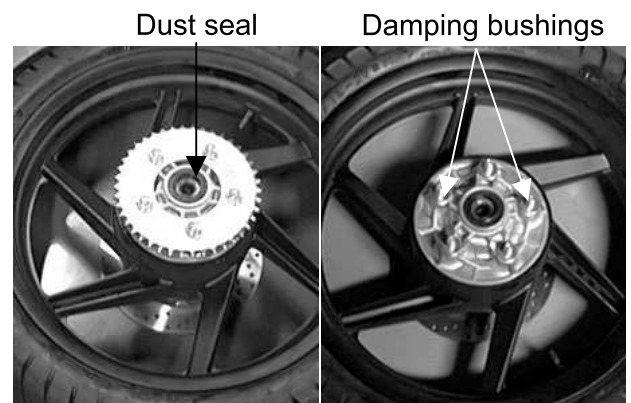

Remove the wheel bearing.
Take out the rear axle collar.



12. REAR BRAKE/REAR FORK/REAR WHEEL/REAR SHOCK ABSORBER

ASSEMBLY

Pack all bearing cavities with grease.
Drive in the left bearing.
Install the distance collar.
Drive in the right bearing.

- *

<ul style="list-style-type: none">• Drive in the bearings squarely.• Install the bearings with the sealed end facing out.
--

Install the drive chain gear.
Apply grease to the dust seal and install it to the bearing.
Install the side collar.

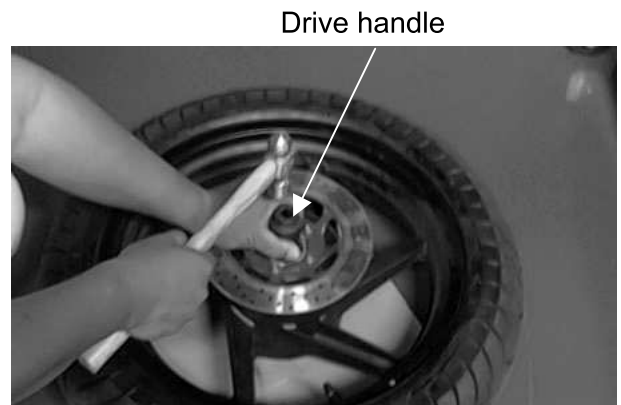

INSTALLATION

The installation sequence is the reverse of removal.

REAR SHOCK ABSORBER REMOVAL

Remove the seat assy and body cover.
Remove the rear shock absorber upper and lower mount bolts.
Remove the rear shock absorbers.

INSTALLATION

Depress the motorcycle to install the rear shock absorbers.
Tighten the shock absorber upper and lower mount nuts and bolts.

Torque: 3.0~4.0 kg-m

Upper Mount Nut



Lower Mount Nut

13. HYDRAULIC BRAKE

HYDRAULIC BRAKE

SERVICE INFORMATION-----	13- 2
TROUBLESHOOTING-----	13- 2
BRAKE FLUID CHANGE/AIR BLEED-----	13- 3
BRAKE PAD/DISK -----	13- 4
BRAKE MASTER CYLINDER -----	13- 5

13. HYDRAULIC BRAKE

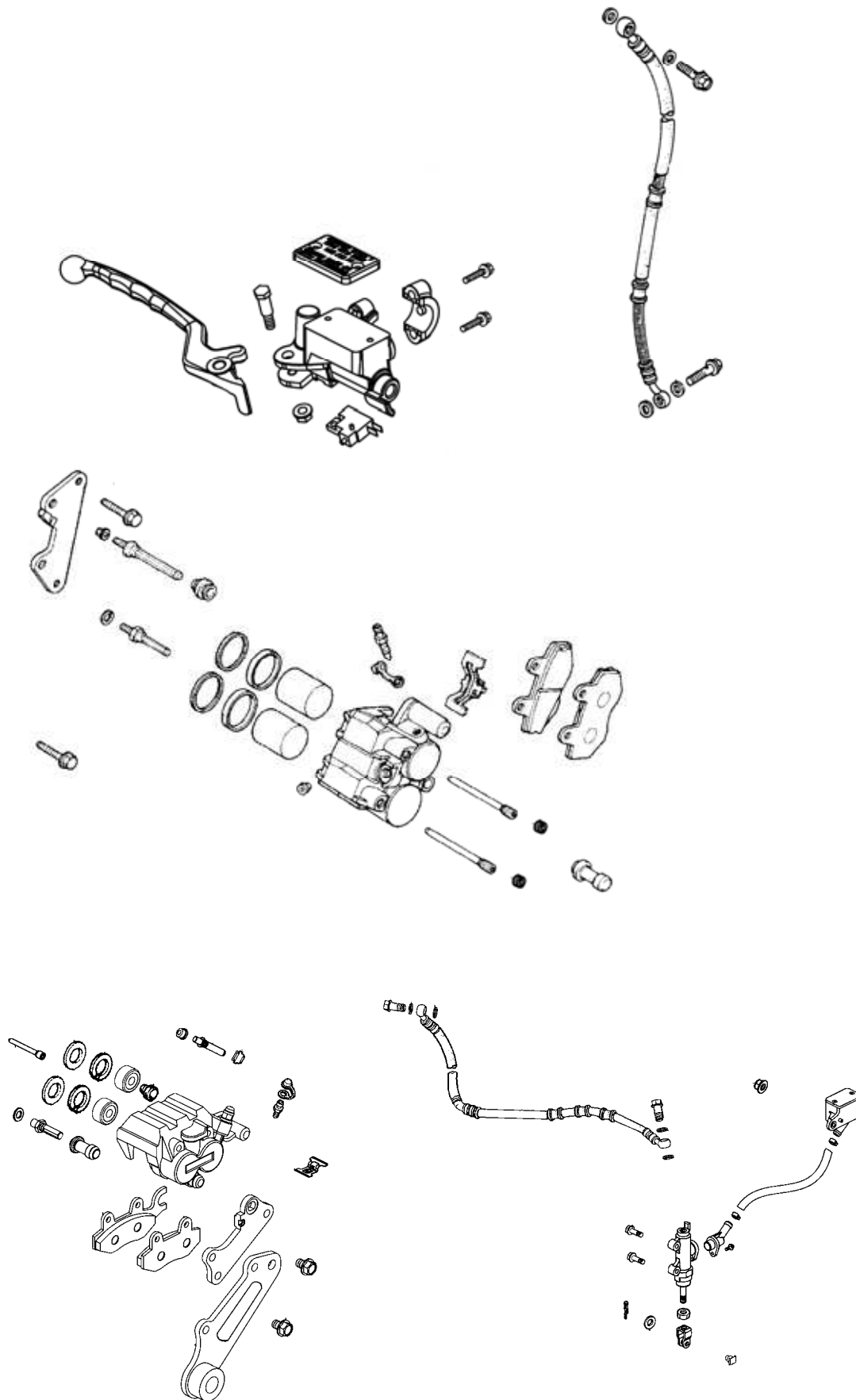

13. HYDRAULIC BRAKE

SERVICE INFORMATION

GENERAL INSTRUCTIONS

- Drain the brake fluid from the hydraulic brake system before disassembly.
- Do not allow any foreign matters entering the brake reservoir when filling the brake reservoir with brake fluid.
- Be careful not to splash brake fluid on any coated surfaces and instrument covers to avoid damage.
- Inspect the brake operation before riding.
- Brake fluid will damage painted, coated surfaces and plastic parts. When working with brake fluid, use shop towels to cover and protect painted, rubber and plastic parts. Wipe off any splash of brake fluid with a clean towel. Do not wipe the motorcycle with a towel contaminated by brake fluid.
- Make sure to use recommended brake fluid. Use of other unspecified brake fluids may cause brake failure.

SPECIFICATIONS

Item	Standard (mm)	Service Limit (mm)
Brake disk thickness	4	3.0
Brake disk runout	0.15	—

TORQUE VALUES

Caliper holder bolt	2.4~3.0 kg-m
Pad pin bolt	1.5~2.0 kg-m
Brake fluid tube bolt	3.0~4.0 kg-m
Caliper bleed valve	0.4~0.7 kg-m
Master cylinder holder bolt	0.8~1.2 kg-m

TROUBLESHOOTING

Loose brake lever

- Air in hydraulic brake system
- Brake fluid level too low
- Hydraulic brake system leakage

Tight brake lever

- Seized piston
- Clogged hydraulic brake system
- Smooth or worn brake pad

Hard braking

- Seized hydraulic brake system
- Seized piston

Poor brake performance

- Contaminated brake pad surface
- Brake disk or wheel not aligned

Brake noise

- Contaminated brake pad surface
- Excessive brake disk runout
- Incorrectly installed caliper
- Brake disk or wheel not aligned

13. HYDRAULIC BRAKE

BRAKE FLUID CHANGE/AIR BLEED

Place the motorcycle on its main stand on level ground and set the handlebar upright. Remove the two screws attaching the brake fluid reservoir cap.

- * Use shop towels to cover plastic parts and coated surfaces to avoid damage caused by splash of brake fluid.

Screws



Connect a transparent hose to the brake caliper bleed valve and then loosen the bleed valve nut.

Use a syringe to draw the brake fluid out through the hose.

Bleed Valve



BRAKE FLUID REFILLING

Connect a transparent hose and syringe to the brake caliper bleed valve and then loosen the bleed valve nut.

Fill the brake reservoir with brake fluid and use the syringe to draw brake fluid into it until there is no air bubbles in the hose.

Then, tighten the bleed valve nut.

- *
- When drawing brake fluid with the syringe, the brake fluid level should be kept over 1/2 of the brake reservoir height.
 - Use only the recommended brake fluid.

Brake Reservoir

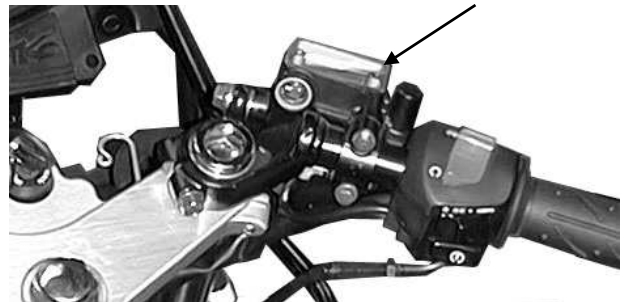

Recommended Brake Fluid: DOT-3

BRAKE SYSTEM BLEEDING

Connect a transparent hose to the bleed valve and fully apply the brake lever after continuously pull it several times. Then, loosen the bleed valve nut to bleed air from the brake system. Repeat these steps until the brake system is free of air.

- *
- When bleeding air from the brake system, the brake fluid level should be kept over 1/2 of the brake reservoir height.



Brake lever

13. HYDRAULIC BRAKE

BRAKE PAD/DISK

BRAKE PAD REPLACEMENT

Remove the two bolts attaching the brake caliper holder.

* The brake pads can be replaced without removing the brake fluid tube.

Remove the brake caliper.

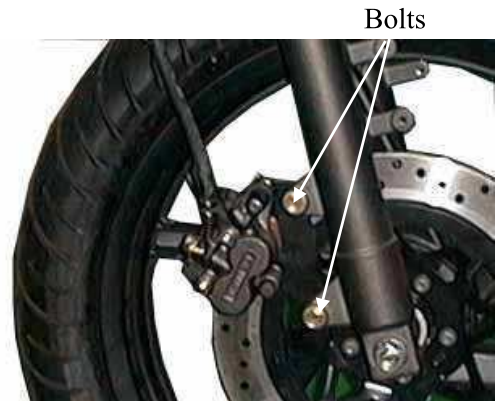

Remove the brake pad pin bolt caps and then remove the pad pin bolts and brake pads.



Brake Caliper

Remove the pad springs.



Pad Spring

ASSEMBLY

Assemble the brake pads in the reverse order of removal.

Tighten the pad pin bolts.

Torque: 1.5~2.0 kg-m

Tighten the pad pin bolt caps.

* Do not tighten the pad pin bolt caps excessively.

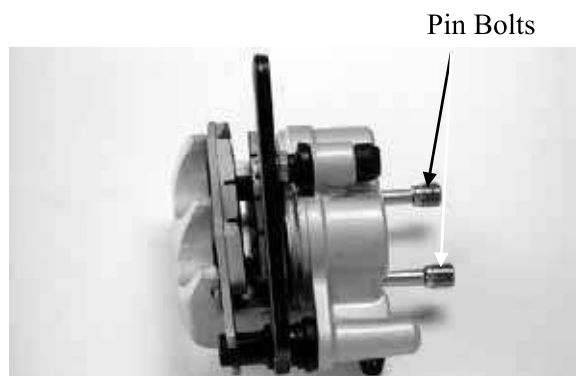

Pin Bolts

13. HYDRAULIC BRAKE

BRAKE DISK

Measure the brake disk thickness.

Service Limit: 3.0 mm

Measure the brake disk runout.

Service Limit: 0.3 mm



BRAKE MASTER CYLINDER

REMOVAL

Drain the brake fluid from the hydraulic brake system.

- * Do not splash brake fluid onto any rubber, plastic and coated parts. When working with brake fluid, use shop towels to cover these parts.

Remove the two master cylinder holder bolts and remove the master cylinder.

- * When removing the brake fluid tube bolt, be sure to place towels under the tube and plug the tube end to avoid brake fluid leakage and contamination.

- * Please check if has enough brake fluid in the rear brake reservoir.

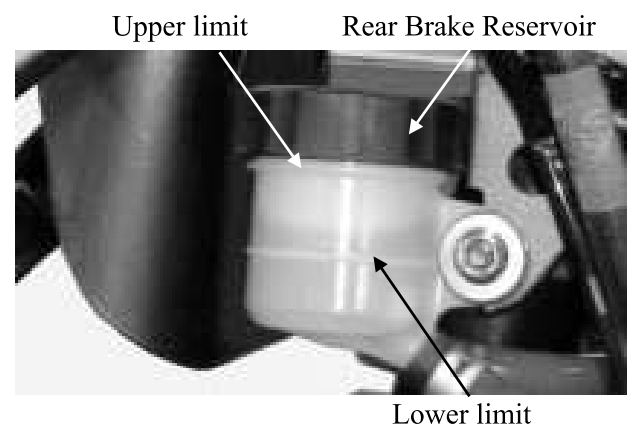
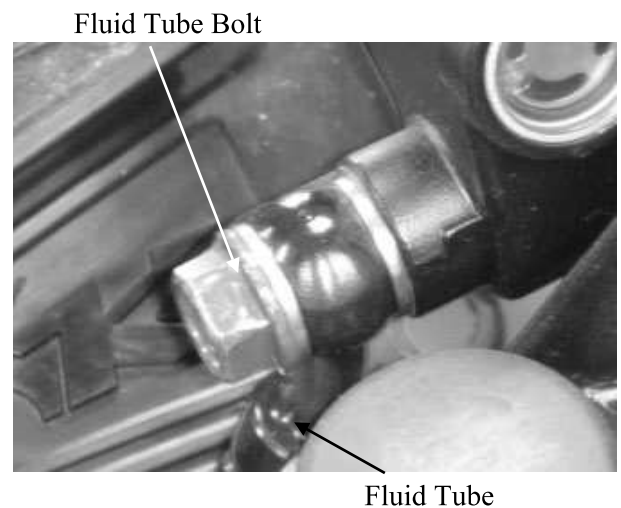

REAR CARRIER / EXHAUST MUFFLER

SERVICE INFORMATION----- 14- 2
REAR GRIP ----- 14- 3
EXHAUST MUFFLER ----- 14- 3

SERVICE INFORMATION**GENERAL INSTRUCTIONS**

- The exhaust muffler must be removed when it is cold to avoid burns.
- When installing the exhaust muffler, first tighten the exhaust muffler joint lock nuts and then tighten the exhaust muffler hanger lock bolt.

TORQUE VALUES

Rear carrier lock bolt	3.0 ~ 4.0 kg-m
Exhaust muffler joint lock nut	0.8 ~ 1.2 kg-m
Exhaust muffler hanger lock bolt	2.4 ~ 3.0 kg-m

REAR GRIP

REMOVAL

Remove the two lock bolts on each side of the rear grip. Remove the rear grip.

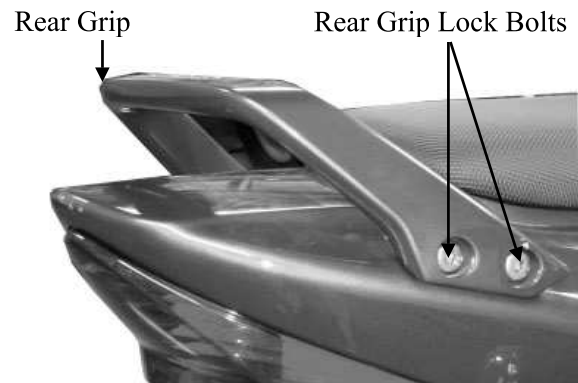

EXHAUST MUFFLER

REMOVAL

* The exhaust muffler must be removed when it is cold to avoid burns.

Remove the two exhaust muffler joint lock nuts.
 Remove the hanger head bolt attaching the rear foot step.
 Remove the exhaust muffler hanger lock bolt.
 Remove the exhaust muffler.

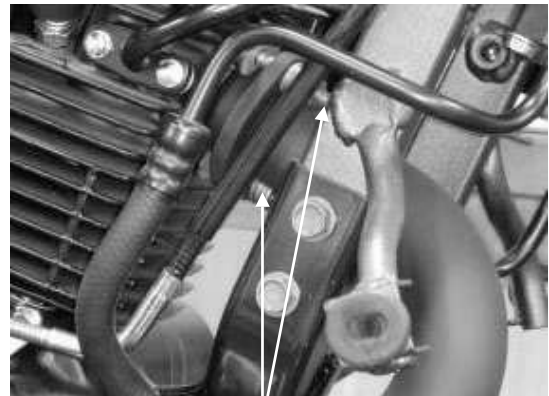

Exhaust Muffler Joint Lock Nuts

INSPECTION

Inspect the exhaust muffler joint and gasket for damage, deformation or leakage.
 Replace if necessary.

INSTALLATION

Install the exhaust muffler joint and gasket and then install the exhaust muffler.
 First tighten the two exhaust muffler joint lock nuts and then tighten the exhaust muffler hanger lock bolt.

Hanger Lock Bolt



Torques:

Exhaust muffler joint lock nut: 0.8~1.2 kg-m
 Exhaust muffler hanger lock bolt: 2.4~3.0 kg-m

15. BATTERY/CHARGING SYSTEM

15

BATTERY/CHARGING SYSTEM

CHARGING SYSTEM LAYOUT	15-1
SERVICE INFORMATION.....	15-2
TROUBLESHOOTING	15-3
BATTERY.....	15-4
CHARGING SYSTEM	15-5
A.C. GENERATOR INSPECTION.....	15-5
REGULATOR/RECTIFIER INSPECTION	15-6
VOLTAGE REGULATION TEST	15-6

15. BATTERY/CHARGING SYSTEM

CHARGING SYSTEM LAYOUT

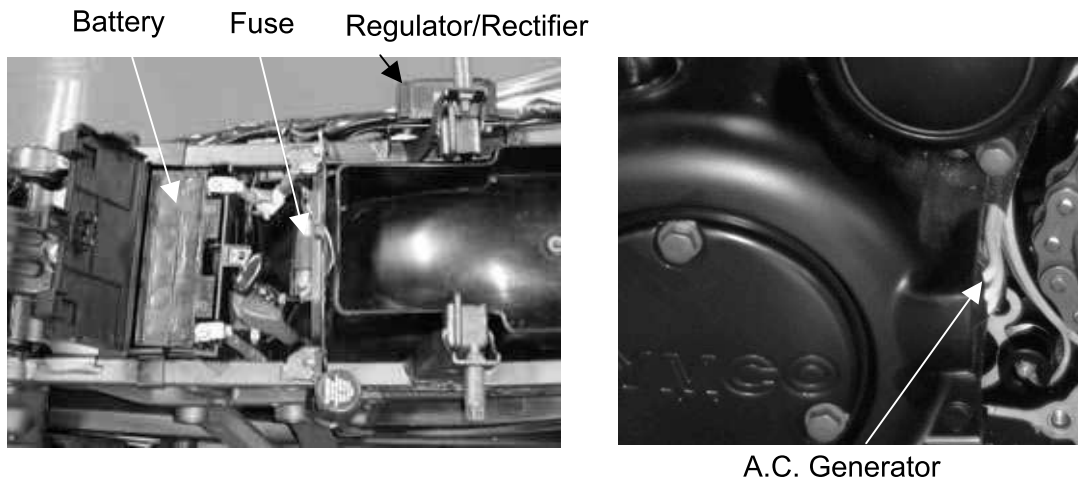

CHARGING CIRCUIT

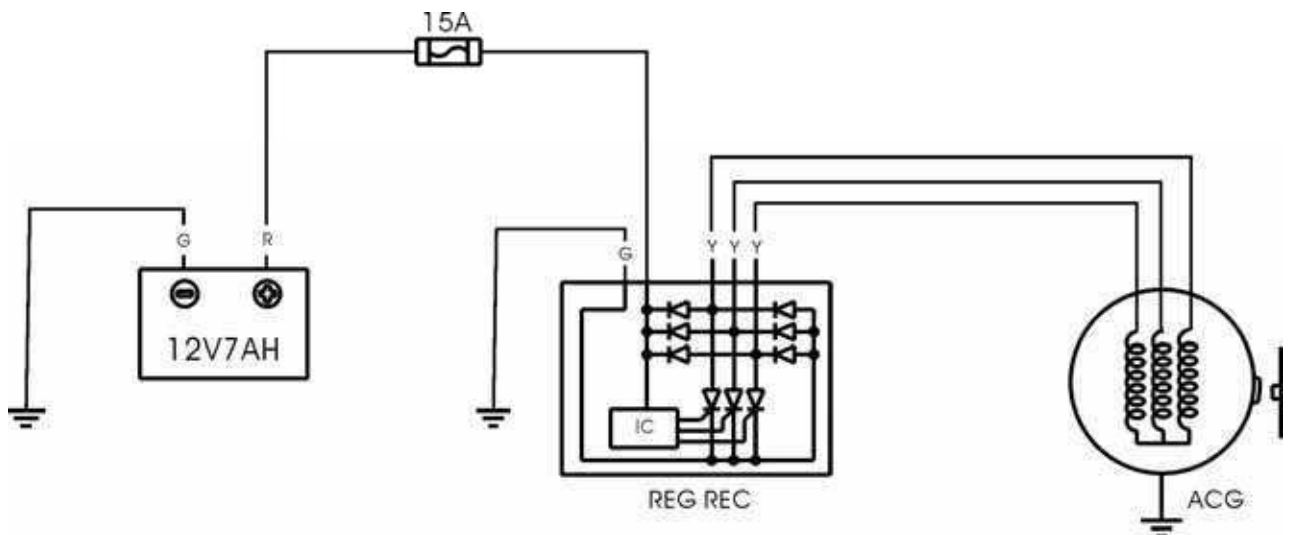

15. BATTERY/CHARGING SYSTEM

SERVICE INFORMATION

GENERAL INSTRUCTIONS

* The battery electrolyte (sulfuric acid) is poisonous and may seriously damage the skin and eyes. Avoid contact with skin, eyes, or clothing. In case of contact, flush with water and get prompt medical attention

- The battery can be charged and discharged repeatedly. If a discharged battery is not used for a long time, its service life will be shortened. Generally, the capacity of a battery will decrease after it is used for 2~3 years. A capacity-decreased battery will resume its voltage after it is recharged but its voltage decreases suddenly and then increases when a load is added.
- When a battery is overcharged, some symptoms can be found. If there is a short circuit inside the battery, no voltage is produced on the battery terminals. If the rectifier won't operate, the voltage will become too high and shorten the battery service life.
- If a battery is not used for a long time, it will discharge by itself and should be recharged every 3 months.
- A new battery filled with electrolyte will generate voltage within a certain time and it should be recharged when the capacity is insufficient. Recharging a new battery will prolong its service life.
- Inspect the charging system according to the sequence specified in the Troubleshooting.
- Do not disconnect and soon reconnect the power of any electrical equipment because the electronic parts in the regulator/rectifier will be damaged. Turn off the ignition switch before operation.
- It is not necessary to check the MF battery electrolyte or fill with distilled water.
- Check the load of the whole charging system.
- Do not quick charge the battery. Quick charging should only be done in an emergency.
- Remove the battery from the motorcycle for charging.
- When replacing the battery, do not use a traditional battery.
- When charging, check the voltage with an electric tester.

SPECIFICATIONS

Item		MF Type	
Battery	Capacity		12V7AH
	Voltage (20°C)	Fully charged	13.2V
		Undercharged	12.3V
	Charging current		STD: 0.7 A
	Charging time		STD: 5-10hr
A.C. Generator	Charging coil resistance (20°C)	Yellow~Yellow	1.6~2.5Ω
	Charging performance		10.5A min/5000rpm
Regulator/Rectifier	Limit voltage		14.5±0.5V

TESTING INSTRUMENTS

Ammeter

Electric tester.

Tachometer

15. BATTERY/CHARGING SYSTEM

TROUBLESHOOTING

No power

- Dead battery
- Disconnected battery cable
- Fuse burned out
- Faulty ignition switch

Low power

- Weak battery
- Loose battery connection
- Charging system failure
- Faulty regulator/rectifier

Intermittent power

- Loose battery cable connection
- Loose charging system connection
- Loose connection or short circuit in ignition system

Charging system failure

- Loose, broken or shorted wire or connector
- Faulty regulator/rectifier
- Faulty A.C. generator

15. BATTERY/CHARGING SYSTEM

QUANNON 125

BATTERY

Remove the seat.
 Remove the battery cover screw and open the battery cover.
 Remove the battery.
 First disconnect the battery negative (-) cable and then the positive (+) cable.

- * When disconnecting the battery positive (+) cable, do not touch the frame with tool; otherwise it will cause short circuit and sparks to fire the fuel.

The installation sequence is the reverse of removal.

- * First connect the positive (+) cable and then negative (-) cable to avoid short circuit.

BATTERY VOLTAGE INSPECTION (OPEN CIRCUIT VOLTAGE)

Disconnect the battery cables.
 Measure the voltage between the battery terminals.

Fully charged : 13.2V
 Undercharged : 12.3V max.

- * Battery charging inspection must be performed with a voltmeter.

CHARGING

Connect the charger positive (+) cable to the battery positive (+) terminal.
 Connect the charger negative (-) cable to the battery negative (-) terminal.

- *
 - Keep flames and sparks away from a charging battery.
 - Turn power ON/OFF at the charger, not at the battery terminals to prevent sparks near the battery.
 - Charge the battery according to the current specified on the battery.
 - During quick charging, the battery temperature should not exceed 45°C.

- *
 - Quick charging should only be done in an emergency.
 - Measure the voltage 60 minutes after the battery is charged.

Charging current: 0.7A

Charging time : 5~10 hours

After charging: Open circuit voltage: 12.8V min.

Battery Cover

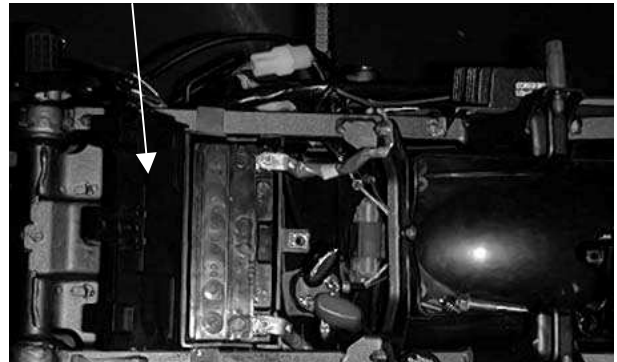

15. BATTERY/CHARGING SYSTEM

CHARGING SYSTEM

CURRENT TEST

- * Use a fully charged battery (12.8V min.) to check the charging system.

Warm up the engine before taking readings. Connect an electric tester across the battery terminals.

Disconnect the red wire from the fuse terminal and connect an ammeter between the red wire lead and the fuse terminal. Attach a tachometer to the engine.

Start the engine and gradually increase the engine speed to measure the limit voltage and current.

Limit Voltage/Current: 14~15V/0.5A max. (5000rpm max.)

If the limit voltage is not within the specified range, check the regulator/rectifier.

A.C. Generator Connector

PERFORMANCE TEST

Engine Speed	2000rpm	5000rpm
Charging Current	7.5A min.	10.5A min.

- * When measuring the charging current, disconnect the black wire from the regulator/rectifier wire coupler.

If the readings do not meet the specified values, check the regulator/rectifier.

A.C. GENERATOR INSPECTION

- * This test can be made without removing the stator from the engine. Disconnect the yellow wire from the auto bystarter.

Remove the met-in box.

Disconnect the A.C. generator connector. Check the continuity between the yellow wires and ground.

There should be continuity between the yellow wires and no continuity between each yellow wire and ground.

Resistance:

Yellow~Yellow	1.6~2.5Ω
---------------	----------

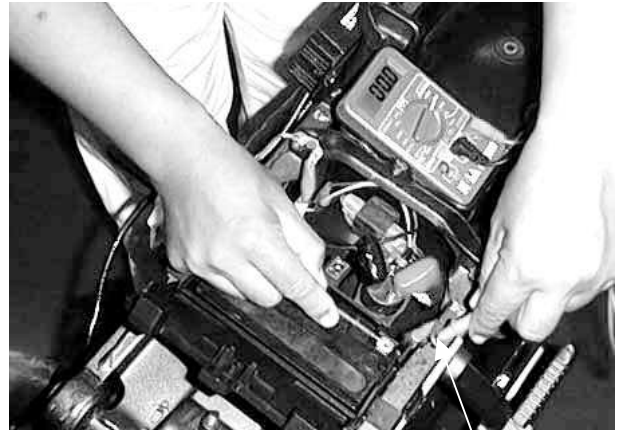

Red Wire



A.C. generator connector

15. BATTERY/CHARGING SYSTEM

A.C. GENERATOR REMOVAL

A.C. generator removal (⇒10-3)
 A.C. generator installation (⇒10-6)

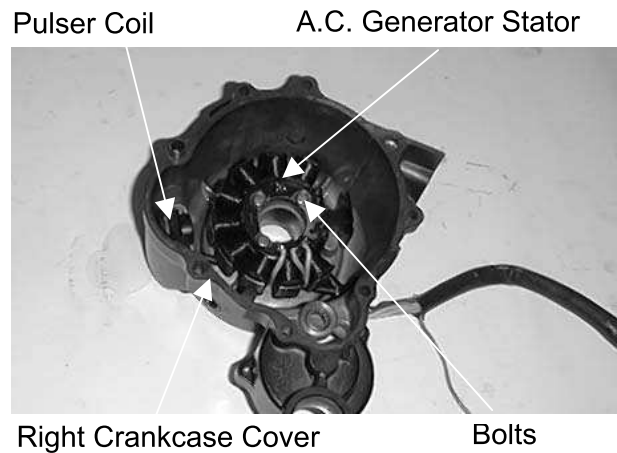

REGULATOR/RECTIFIER

INSPECTION

Remove the right body cover.
 Remove the regulator/rectifier wire coupler.
 Check the continuity between the wire terminals.

Normal Direction: Continuity

	(+) Probe	(-) Probe
I	Yellow	Green
II	Red	Yellow

Reverse Direction: No Continuity

	(+) Probe	(-) Probe
I	Green	Yellow
II	Yellow	Red

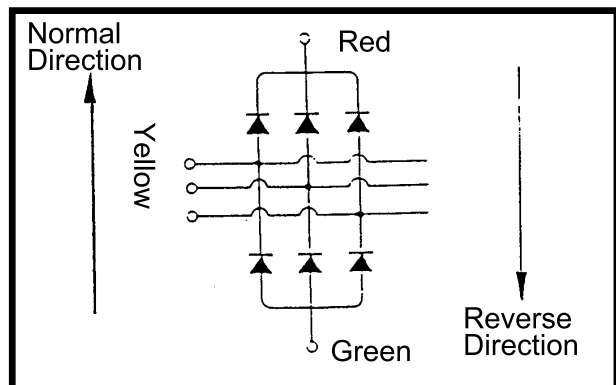
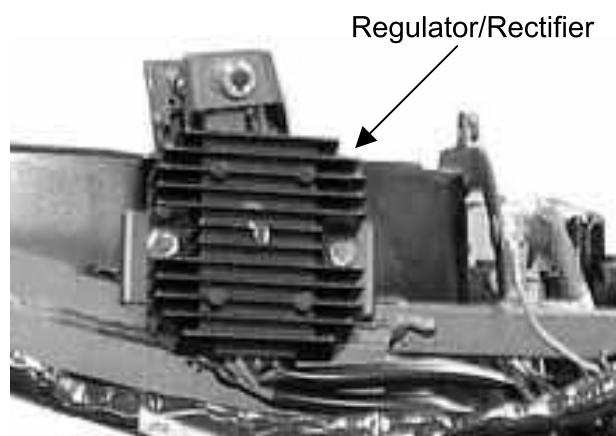

VOLTAGE REGULATION TEST

Connect a voltmeter across the battery terminals.
 Start the engine and gradually increase the engine speed.
 The battery terminal voltage should be within 14.0~15.0V.

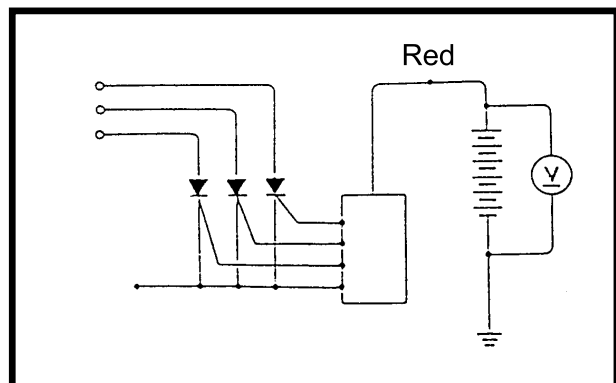

16. IGNITION SYSTEM

IGNITION CIRCUIT

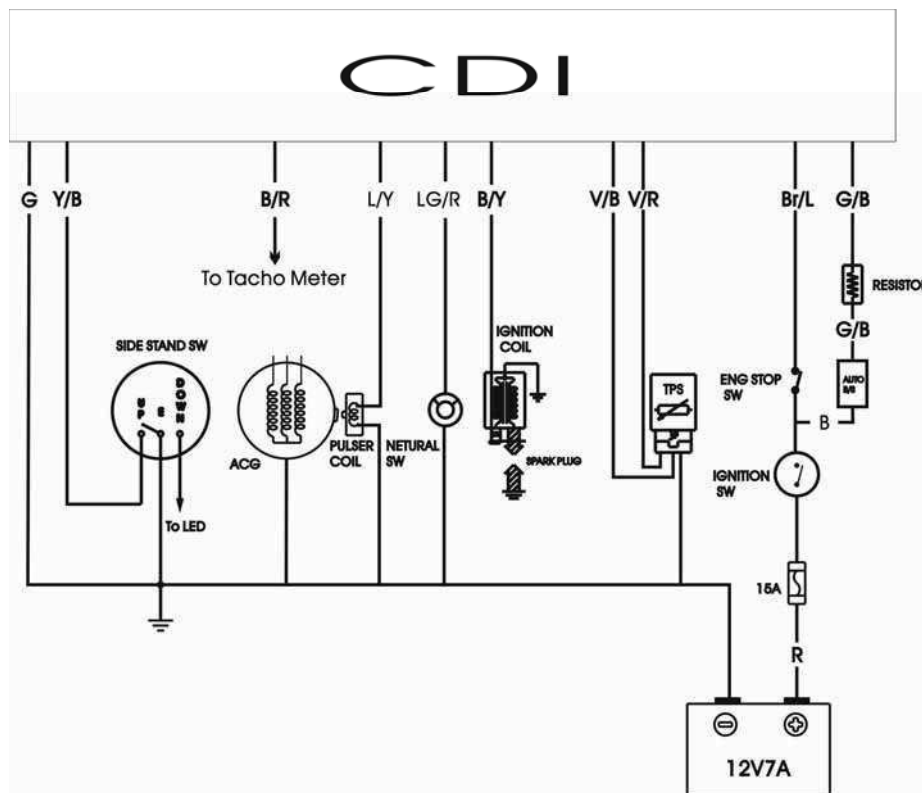

SERVICE INFORMATION

GENERAL INSTRUCTIONS

- Check the ignition system according to the sequence specified in the Troubleshooting. (⇒1-28)
- The ignition system adopts ignition unit and the ignition timing cannot be adjusted.
- If the timing is incorrect, inspect the ignition unit and A.C. generator and replace any faulty parts. Inspect the ignition unit with a ignition unit tester
- Loose connector and poor wire connection are the main causes of faulty ignition system. Check each connector before operation.
- Use of spark plug with improper heat range is the main cause of poor engine performance.
- The inspections in this section are focused on maximum voltage. The inspection of ignition coil resistance is also described in this section.
- Inspect the ignition switch according to the continuity table specified in page 19-3.
- Inspect the spark plug referring to Section 3.
- Remove the A.C. generator and pulser coil referring to Section 10.

16. IGNITION SYSTEM

SPECIFICATIONS

Item		Standard	
Spark plug	Standard type	NGK CR8E	
Spark plug gap		0.6mm ~ 0.7mm	
Ignition timing	"F" mark Full advance	Repeatedly	
Ignition coil resistance (20°C)	Primary coil	0.2~0.3Ω	
	Secondary coil	without plug cap	3.2 ~ 4.8KΩ
		with plug cap	7.6 ~ 8.6KΩ
Pulser coil resistance (20°C)		100 ~ 120Ω	

TESTING INSTRUMENT

Electric tester:

TROUBLESHOOTING

No spark at plug

- Faulty spark plug
- Poorly connected, broken or shorted wire
- Faulty ignition switch
- Faulty ignition coil
- Faulty ignition unit
- Faulty A.C. generator

Engine starts but turns poorly

- Ignition primary circuit
 - Faulty ignition coil
 - Poorly connected wire or connector
 - Poorly contacted ignition switch
- Ignition secondary circuit
 - Faulty ignition coil
 - Faulty spark plug
 - Faulty high-tension wire
 - Poorly insulated plug cap
- Improper ignition timing
 - Faulty A.C. generator
 - Stator not installed properly
 - Faulty ignition unit

16. IGNITION SYSTEM

SPARK PLUG

For spark plug inspection and adjustment, refer to page 2-4.

IGNITION COIL INSPECTION

Remove the fuel tank.
Remove the ignition coil

Ignition Coil



IGNITION COIL CONTINUITY TEST

Inspect the continuity of the ignition coil, primary coil and secondary coil.

* This is a general test. Accurate ignition coil test must be performed with a ignition unit tester.

Primary Coil

Ignition Coil

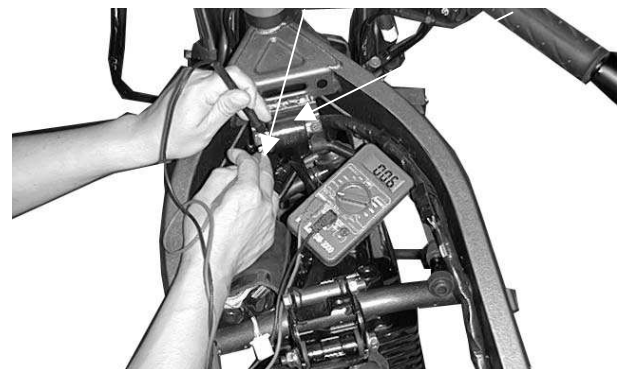

Measure the ignition coil resistances at 20°C.

Primary coil	0.2~0.3Ω
Secondary coil without plug cap	3.2 ~ 4.8KΩ
Secondary coil with plug cap	7.6 ~ 8.6KΩ

Secondary Coil



16. IGNITION SYSTEM

A .C. GENERATOR INSPECTION

PULSER COIL INSPECTION

* This test is performed with the stator installed in the engine.

Remove the R body cover.
Disconnect the A.C. generator connector.

Disconnect the pulser coil wire coupler.
Measure the pulser coil resistance between the blue/white and green/white wire terminals.

Blue/Yellow ~ Green/White	100 ~ 120Ω
---------------------------	------------

* Measure the resistance in the XΩ range.

Pulser Coil Wire Coupler



17. STARTING SYSTEM

STARTING CIRCUIT

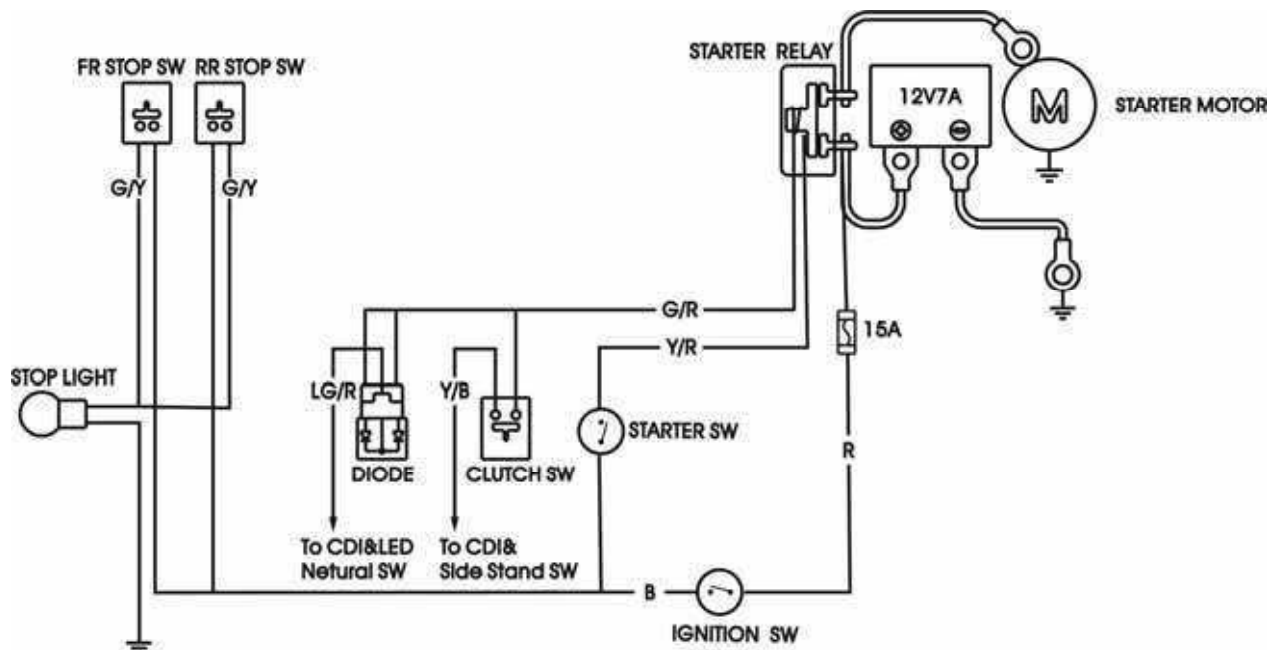

SERVICE INFORMATION

GENERAL INSTRUCTIONS

- The removal of starter motor can be accomplished with the engine installed.
- For the starter clutch removal, refer to page 10-3.
- After the starter clutch is installed, be sure to add the engine oil and coolant and then bleed air from the cooling system.

TORQUE VALUES

Starter motor mounting bolt 0.35 ~ 0.5 kg-m

TROUBLESHOOTING

Starter motor won't turn

- Fuse burned out
- Weak battery
- Faulty ignition switch
- Faulty starter clutch
- Faulty front or rear stop switch
- Faulty starter relay
- Poorly connected, broken or shorted wire
- Faulty starter motor

Lack of power

- Weak battery
- Loose wire or connection
- Foreign matter stuck in starter motor or gear

Starter motor rotates but engine does not start

- Faulty starter pinion
- Starter motor rotates reversely
- Weak battery

17. STARTING SYSTEM

STARTER MOTOR

REMOVAL

- *
 - Before removing the starter motor, turn the ignition switch OFF and remove the battery ground. Then, turn on the ignition switch and push the starter button to see if the starter motor operates properly.

Remove the front seat.
 Remove the nut goes to the starter relay and relax cable band to disconnect the starter motor cable.
 Remove the two starter motor mounting bolts and the motor.

INSTALLATION

Connect the starter motor cable.
 Check the O-ring for wear or damage and replace if necessary.
 Apply grease to the O-ring and install it to the starter motor.
 Tighten the two mounting bolts.

TORQUE

Starter motor mounting bolt 0.35 ~ 0.5 kg-m

STARTER RELAY INSPECTION

Disconnect the starter relay wire connector.
 Check for continuity between the yellow/red wire terminal and ground.
 There should be continuity when the starter button is depressed.
 If there is no continuity, check the starter button for continuity and inspect the wire.

Connect the electric tester to the starter relay larger terminals that connect to the battery positive cable and the starter motor cable.
 Connect a fully charged battery across the starter relay yellow/red and green/yellow wire terminals.
 Check for continuity between the starter relay large terminals. The relay is normal if there is continuity.

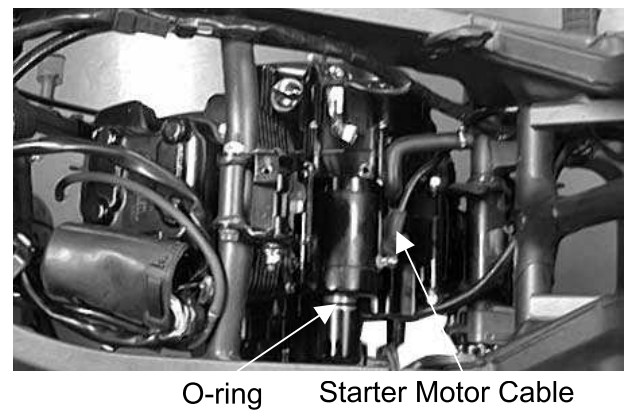
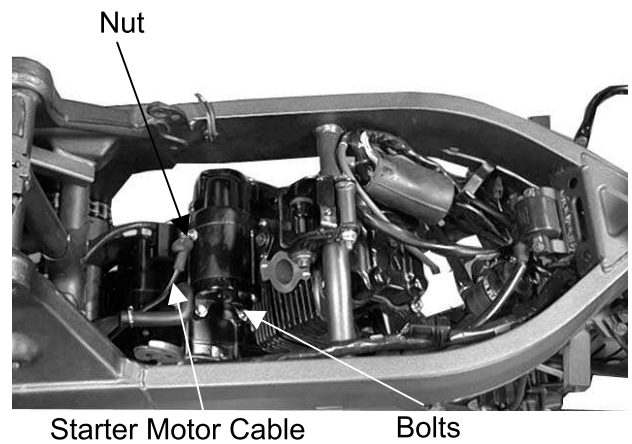

O-ring Starter Motor Cable

Yellow/Red Wire

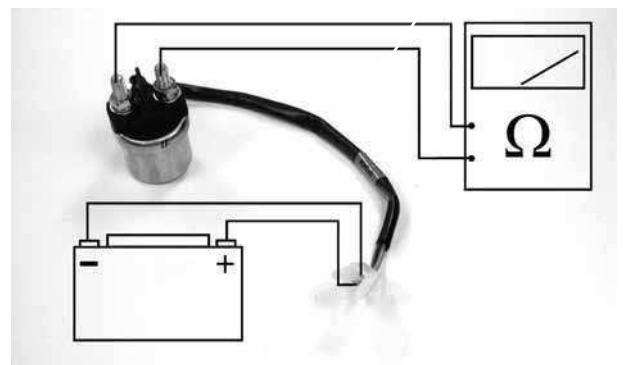
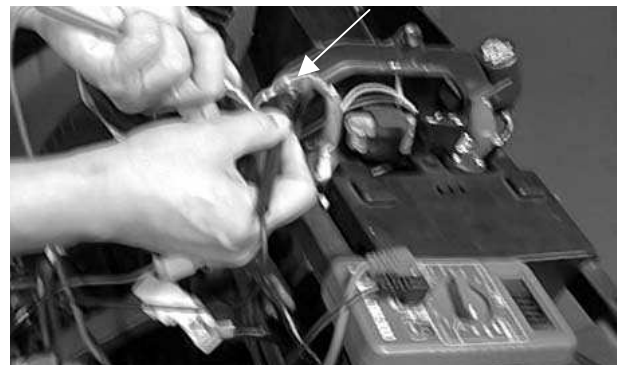

LIGHTS/INSTRUMENTS/SWITCHES/HORN

SERVICE INFORMATION-----	18- 1
TROUBLESHOOTING-----	18- 1
HEADLIGHT -----	18- 2
TURN SIGNAL LIGHT -----	18- 3
IGNITION SWITCH -----	18- 3
STARTER BUTTON/HORN BUTTON/FUEL GAUGE -----	18- 3
HANDLEBAR SWITCHES-----	18- 4
FUEL UNIT -----	18- 6

SERVICE INFORMATION

GENERAL INSTRUCTIONS

- All plastic plugs have locking tabs that must be released before disconnecting.
- An electric tester must be used for checking the continuity between two points. The electric tester also contains a voltmeter which can be used to measure voltage.
- Different bulbs have different specifications. When replacing, use a new bulb of the same specifications to avoid damage of the electrical equipment.
- The continuity check of switches can be made without removing the switches from the motorcycle.

SPECIFICATIONS

Headlight	12V 55/55W
Stoplight/Taillight	12V 21/5W
Turn signal light	12V 5Wx4
Fuse	15A

TROUBLESHOOTING

Light does not come on when ignition switch is "ON"

- Burned bulb
- Faulty ignition or light switch
- Fuse burned out
- Dead battery or loose battery wire

Light comes on but dims

- Weak battery
- Wire or switch resistance too high
- Aged bulb or faulty lighting circuit

Headlight beam does not change when dimmer switch is operated

- Faulty or burned bulb
- Faulty dimmer switch
- Loose wire connection

HEADLIGHT

REMOVAL

Remove the headlight unit and disconnect the headlight wire coupler.

Remove the headlight bulb and bulb socket. Check the bulb for damage and replace with a new one if necessary.

Bulb Specification: 12V 55W



Bulb

INSTALLATION

Install the headlight in the reverse order of removal.

SPEEDOMETER

REMOVAL

Disconnect the speedometer cable. Remove the two bolts attaching the speedometer seat. Remove the speedometer.

INSTALLATION

The installation sequence is the reverse of removal.

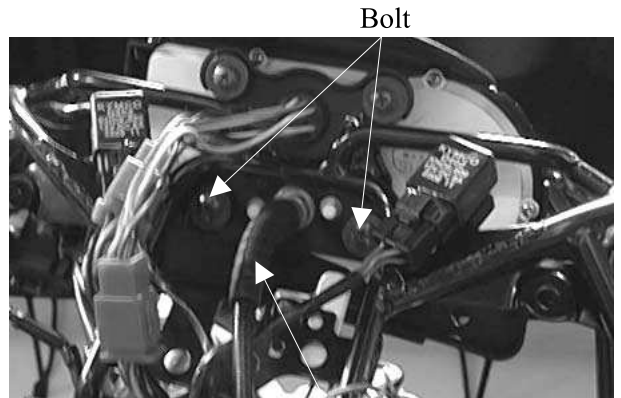

Bolt

Speedometer Cable

TURN SIGNAL LIGHT

Remove the turn signal light shell screw and the bulb.

Check the bulb for damage and replace with a new one if necessary.

The installation sequence is the reverse of removal.

Bulb Specification: 12V 5W



Screw

Light Shell

STOP LIGHT/TAIL LIGHT

Remove the two taillight shell screws and the shell.

Remove the bulb and check the bulb for damage. Replace with a new one if necessary.

Bulb Specification: 12V 21/5W



Reflector

IGNITION SWITCH

INSPECTION

Check for continuity between the wires indicated below.

Color Position	Black	Red	Black/ White	Green
OFF			○—○	
ON	○—○			



STARTER BUTTON

Remove the decorative covers under the fuel tank.

Disconnect the right switch wire coupler. Check for continuity between the black and yellow/red wires.

Color Position	Black	Yellow/Red
FREE		
PUSH	○—○	○—○

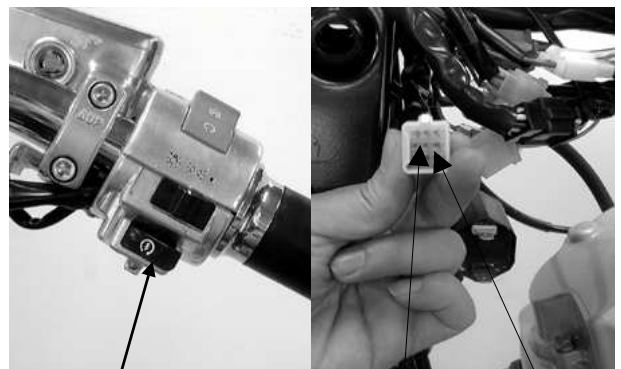

Starter Button

Yellow/Red Black

HORN BUTTON

Remove the decorative covers under the fuel tank.

Disconnect the left switch wire coupler. Check for continuity between the black and light green wires.

Color Position	Black	Light Green
FREE		
PUSH	○—○	○—○

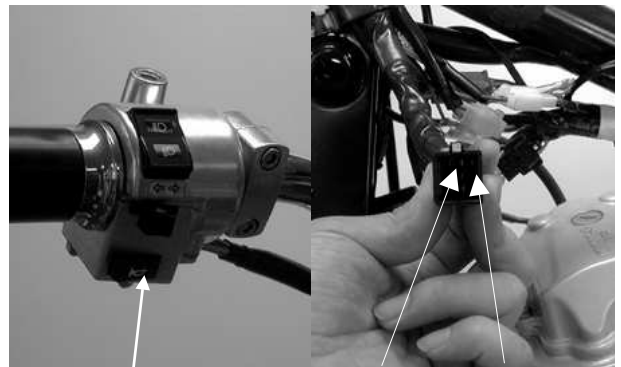

Horn Button

Black Light Green

HORN

Remove the steering head decorative cover. Disconnect the horn wire coupler.

The horn is normal if it sounds when a 12V battery is connected across the horn wire terminals. Replace the horn if it does not sound.



HANDLEBAR SWITCHES

FRONT STOP SWITCH

Disconnect the front stop switch wire coupler.
 Check for continuity between the front stop switch wires.
 Brake lever applied: There is continuity.
 Brake lever released: There is no continuity.



Front Stop Switch

Rear Stop Switch Wire

REAR STOP SWITCH

Remove the right side cover.
 Disconnect the rear stop switch wire coupler.
 Check for continuity between the rear stop switch wires.
 Brake pedal depressed: There is continuity.
 Brake pedal released: There is no continuity.



TURN SIGNAL SWITCH

Disconnect the turn signal switch wire coupler.
 Check for continuity between the turn signal switch wires.

Color \ Position	Orange	Gray	Light Blue
R		○ — ○	○
L	○ — ○	○	

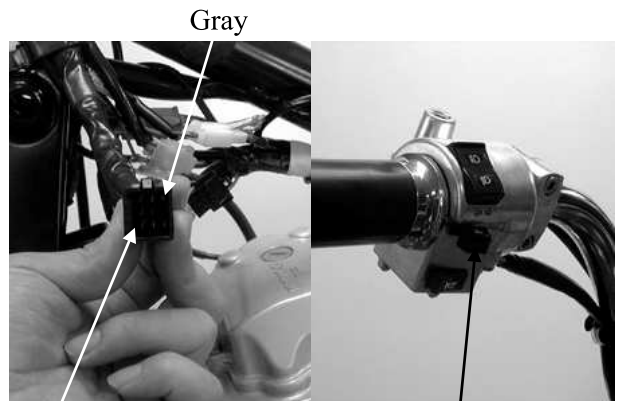

Light Blue Orange

Turn Signal Switch

18. LIGHTS/INSTRUMENTS/SWITCHES/HORN QUANNON 125

HEADLIGHT SWITCH

Disconnect the headlight switch wire coupler. Check for continuity between the headlight switch wires.

Position \ Color	Black	Brown	Blue/White
OFF			
P	○ — ○	○	
H	○	○	○

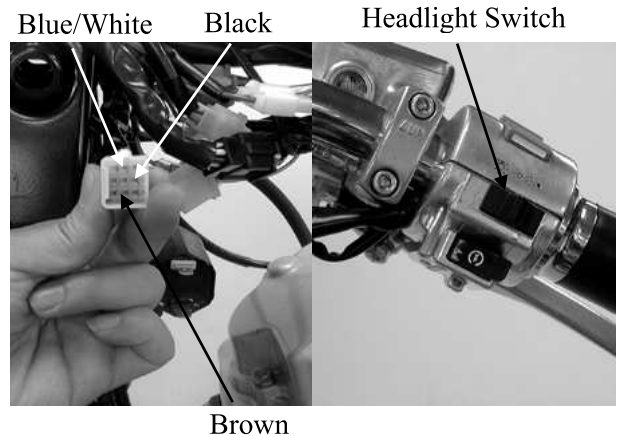

ENGINE STOP SWITCH

Disconnect the engine stop switch wire coupler. Check for continuity between the engine stop switch wires.

Position \ Color	Brown/Blue	Black
RUN	○ — ○	○
OFF		

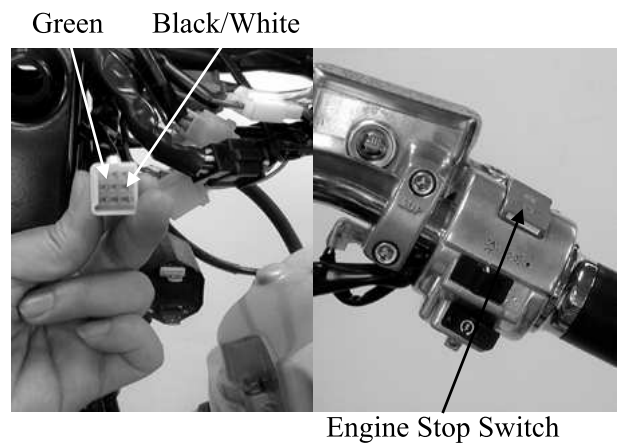

DIMMER SWITCH

Disconnect the dimmer switch wire coupler. Check for continuity between the dimmer switch wires.

Position \ Color	Blue/White	Blue	White	Black
HI	○ — ○	○		
LO	○		○	
PASSING		○		○

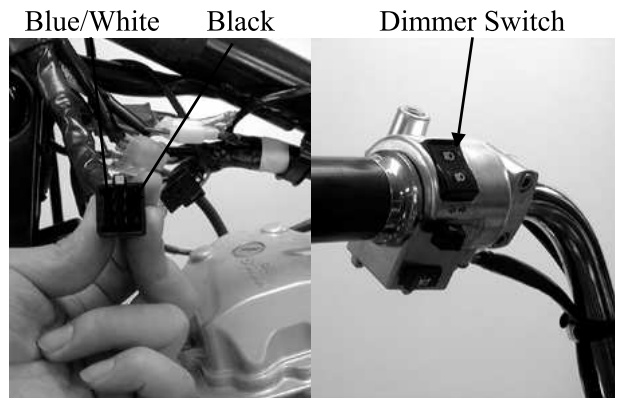

SIDE STAND SWITCH

Position \ Color	Yellow/Green	Green	Yellow/Black
DOWN		○ — ○	○
UP	○ — ○	○	

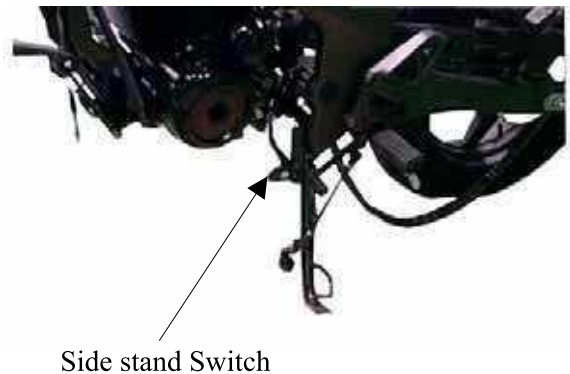

18. LIGHTS/INSTRUMENTS/SWITCHES/HORN QUANNON 125

FUEL UNIT

* Keep flames and sparks away from the working area.

REMOVAL

Remove the front seat and fuel tank.
Remove the four fuel unit attaching nuts.
Remove the fuel unit.

* Be careful not to bend or damage the fuel unit float arm.



Nut

Fuel Unit

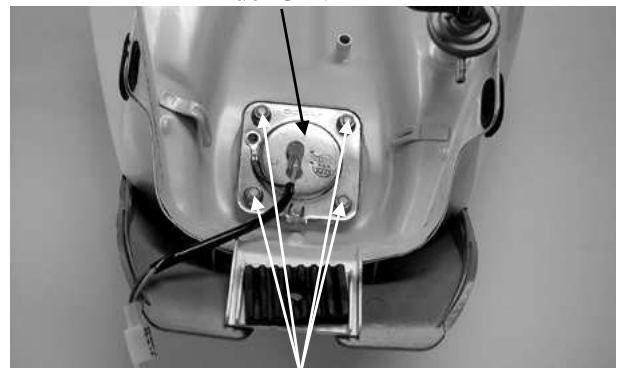

Nuts

INSPECTION

Check the fuel unit O-ring for wear, damage or deformation. Replace if necessary.
Measure the resistances between the fuel unit wire terminals with the float at the upper (Full) and lower (Empty) positions.

Resistances: Upper (Full): 9~25Ω
Lower (Empty): 70~100Ω

INSTALLATION

Install the fuel unit in the reverse of removal.

* Check for fuel leakage after installation.

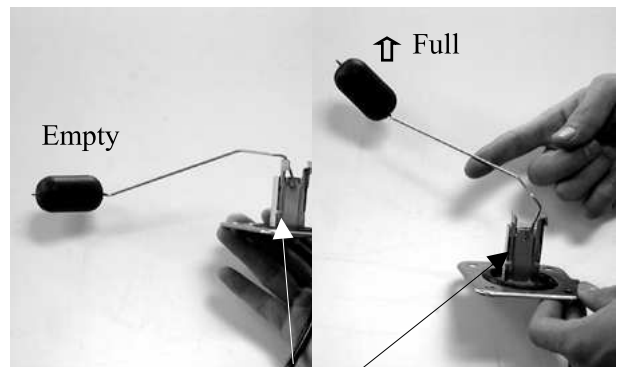

Fuel Gauge