

PREFACE

This Service Manual describes the technical features and servicing procedures for the KYMCO *Zing* 125/150.

Section 1 contains the precautions for all operations stated in this manual. Read them carefully before starting any operation.

Section 2 is the inspection/ adjustment procedures, safety rules and service information for each part, starting from periodic maintenance.

Sections 3 and 4 state the servicing procedures and cautions for the removal and installation of lubrication and fuel systems.

Sections 5 through 19 give instructions for disassembly, assembly and inspection of engine, chassis frame and electrical equipment.

Most sections start with an assembly or system illustration and troubleshooting for the section. The subsequent pages give detailed procedures for the section.

The information and contents included in this manual may be different from the motorcycle in case specifications are changed.

TABLE OF CONTENTS

ENGINE	GENERAL INFORMATION	1
	INSPECTION/ADJUSTMENT	2
	LUBRICATION SYSTEM	3
	FUEL SYSTEM	4
	ENGINE REMOVAL/INSTALLATION	5
	CYLINDER HEAD/VALVES	6
	CYLINDER/PISTON	7
	STARTER MOTOR/GENERATOR/ LEFT CRANKCASE COVER/STARTER CLUTCH/CAMSHAFT	8
	CLUTCH/GEAR SHIFT MECHANISM	9
	CRANKCASE/CRANKSHAFT/TRANS- MISSION SYSTEM/STARTER SPINDLE	10
CHASSIS	FRONT WHEEL/SUSPENSION/ STEERING	11
	REAR WHEEL/BRAKE/SUSPENSION	12
	HYDRAULIC BRAKE	13
	REAR CARRIER/REAR FENDER/ EXHAUST MUFFLER	14
ELECTRICAL EQUIPMENT	IGNITION SYSTEM	15
	CHARGING SYSTEM	16
	STARTING SYSTEM	17
	LIGHTS/INSTRUMENTS/SWITCHES/ HORN	18
EMISSION CONTROL	EVAPORATIVE EMISSION CONTROL SYSTEM	19
	EXHAUST EMISSION CONTROL SYSTEM	

KWANG YANG MOTOR CO., LTD.
OVERSEAS SALES DEPARTMENT
OVERSEAS SERVICE SECTION

1. GENERAL INFORMATION

ENGINE SERIAL NUMBER.....1- 0	LUBRICATION POINTS 1-13
SPECIFICATIONS.....1- 2	CABLE & HARNESS ROUTING..... 1-14
SERVICE PRECAUTIONS1- 3	WIRING DIAGRAM..... 1-16
TORQUE VALUES.....1-11	TROUBLESHOOTING 1-17
SPECIAL TOOLS1-12	

ENGINE SERIAL NUMBER



ZING 150

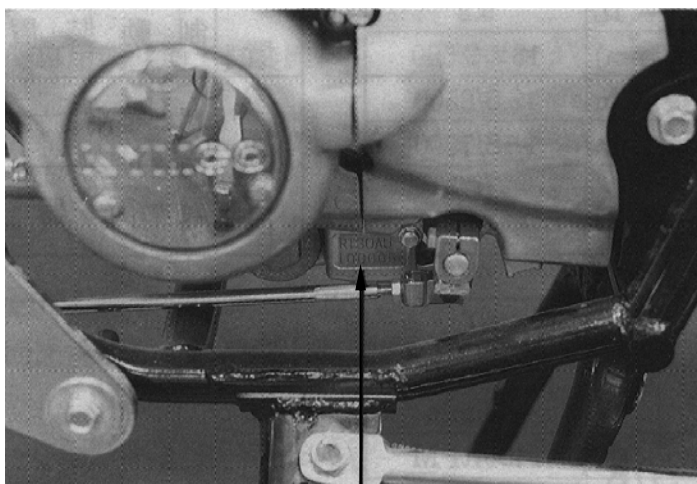

Location of Engine Serial Number

1. GENERAL INFORMATION

SPECIFICATIONS

Motorcycle name & Model No.		RT30AU		
Motorcycle name		Zing 150		
Overall length (mm)		2183		
Overall width (mm)		810		
Overall height (mm)		1162		
Wheel base (mm)		1460		
Engine type		4 ∞		
Displacement (cc)		149.4		
Fuel type		92# nonleaded gasoline		
Dry weight (kg)	Front wheel	55.5		
	Rear wheel	74		
	Total	129.5		
Gross weight(kg)	Front wheel	62.5		
	Rear wheel	79.5		
	Total	142		
Tires	Front wheel	3.00-18		
	Rear wheel	130/90-15		
Ground clearance (mm)		140		
Performance	Braking distance (m)	7.9		
	Min. turning radius (m)	2.35		
Engine	Starting system		Starting motor & kick starter	
	Type		OHV	
	Cylinder arrangement		Single cylinder	
	Combustion chamber type		Semi-sphere	
	Valve arrangement		Single cam, OHV	
	Bore x stroke (mm)		62 x 49.5	
	Compression ratio		9.7	
	Compression pressure (kg/cm ²)		16	
	Max. output (Kw/rpm)		8.8/8000	
	Max. torque (Nm/rpm)		1.1/6000	
	Port timing	Intake (1mm)	Open	0°
			Close	30°
		Exhaust (1mm)	Open	0°
			Close	30°
	Valve clearance (cold)	Intake	0.05mm	
		Exhaust	0.05mm	
	Idle speed (rpm)		1600rpm	
	Lubrication System	Lubrication type		Forced pressure & wet sump
		Oil pump type		Gear type
		Oil filter type		Wire gauze filter
Oil capacity		1.1 liter		
Cooling Type		Air & oil cooling		

Fuel System	Air cleaner type		Sponge type		
	Fuel capacity		14.0 liter		
	Carburetor	Type	CVK		
		Piston dia. (mm)			
Venturi dia.(mm)		φ25 equivalent			
Throttle type		Piston type			
Electrical Equipment	Ignition System	Type	CDI		
		Ignition timing	15°/1600rpm		
		Spark plug	DR8EA		
		Spark plug gap	0.6~0.7mm		
Battery	Capacity	12V7AH			
Power Drive System	Clutch	Type	Wet multi-disc clutch		
		Type	Permanent gear meshing		
	Transmission Gear	Operating method		Foot operated	
		Type		International type	
		Reduction ratio	1st gear	2.846	
			2nd gear	2.063	
			3rd gear	1.27	
			4th gear	1.130	
5th gear	0.923				
Moving Device	Front	Caster angle	36°		
	Axle	Wheel base	1460		
	Tire pressure (kg/cm ²)(2 riders)	Front	1.75		
		Rear	2.25		
	Turning angle	Left	45°		
		Right	45°		
Brake system type	Front	Disk brake			
	Rear	Drum brake			
Damping Device	Shock absorber type	Front	Oil damper spring		
		Rear	Oil damper spring		
Frame type		Double cradle			

1. GENERAL INFORMATION

SPECIFICATIONS

Motorcycle name & Model No.		RF25AA		
Motorcycle name		Zing 125		
Overall length (mm)		2183		
Overall width (mm)		810		
Overall height (mm)		1162		
Wheel base (mm)		1460		
Engine type		4∞		
Displacement (cc)		124.0		
Fuel type		92# unleaded gasoline		
Dry weight (kg)	Front wheel	55.5		
	Rear wheel	74		
	Total	129.5		
Gross weight(kg)	Front wheel	62.5		
	Rear wheel	79.5		
	Total	142		
Tires	Front wheel	3.00-18		
	Rear wheel	130/90-15		
Ground clearance (mm)		140		
Performance	Braking distance (m)	7.9		
	Min. turning radius (m)	2.35		
Engine	Starting system		Starting motor & kick starter	
	Type		OHV	
	Cylinder arrangement		Single cylinder	
	Combustion chamber type		Semi-sphere	
	Valve arrangement		Single cam, OHV	
	Bore x stroke (mm)		56.5 x 49.5	
	Compression ratio		9.0	
	Compression pressure (kg/cm ²)		12	
	Max. output (Kw/rpm)		7.8/9000	
	Max. torque (Nm/rpm)		9.3/6500	
	Port timing	Intake (1mm)	Open	0°
			Close	30°
		Exhaust (1mm)	Open	0°
			Close	30°
	Valve clearance (cold)	Intake	0.05mm	
		Exhaust	0.05mm	
	Idle speed (rpm)		1600rpm	
	Lubrication System	Lubrication type		Forced pressure & wet sump
		Oil pump type		Gear type
		Oil filter type		Wire gauze filter
		Oil capacity		1.1 liter
	Cooling Type		Air & oil cooling	

Fuel System	Air cleaner type		Sponge type	
	Fuel capacity		14.0 liter	
	Carburetor	Type	CVK	
		Piston dia. (mm)		
Venturi dia.(mm)		φ25 equivalent		
	Throttle type		Piston type	
Electrical Equipment	Ignition System	Type	CDI	
		Ignition timing	15°/1600rpm	
		Spark plug	DR8EA	
		Spark plug gap	0.6~0.7mm	
Battery	Capacity		12V7AH	
Power Drive System	Clutch	Type	Wet multi-disc clutch	
	Transmission Gear	Type	Permanent gear meshing	
		Operating method		Foot operated
		Type		International type
		Reduction ratio	1st gear	2.846
			2nd gear	2.063
	3rd gear		1.27	
4th gear	1.130			
5th gear	0.923			
Moving Device	Front Axle	Caster angle	36°	
		Wheel base	1460	
	Tire pressure (kg/cm ²)(2 riders)	Front	1.75	
		Rear	2.25	
	Turning angle	Left	45°	
		Right	45°	
Brake system type	Front	Disk brake		
	Rear	Drum brake		
Damping Device	Shock absorber type	Front	Oil damper spring	
		Rear	Oil damper spring	
Frame type		Double cradle		

1. GENERAL INFORMATION

SERVICE PRECAUTIONS

- Make sure to install new gaskets, O-rings, circlips, cotter pins, etc. when reassembling.

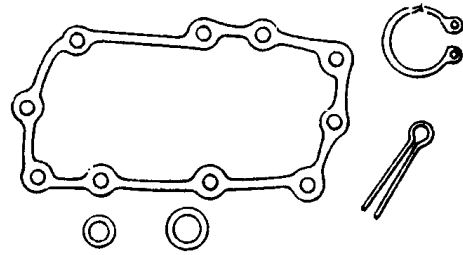

- When tightening bolts or nuts, begin with larger-diameter to smaller ones at several times, and tighten to the specified torque diagonally.

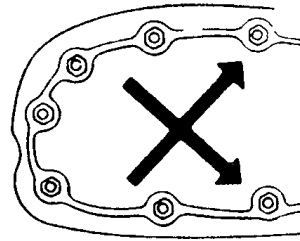

- Use genuine parts and lubricants.

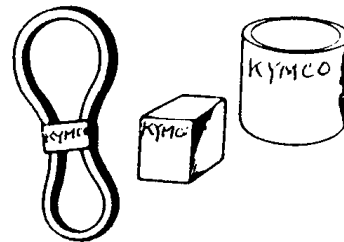

- When servicing the motorcycle, be sure to use special tools for removal and installation.

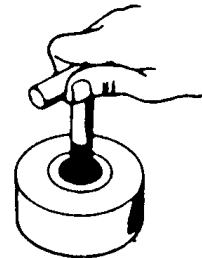

- After disassembly, clean removed parts. Lubricate sliding surfaces with engine oil before reassembly.

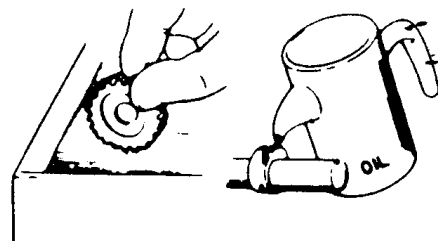

1. GENERAL INFORMATION

- Apply or add designated greases and lubricants to the specified lubrication points.

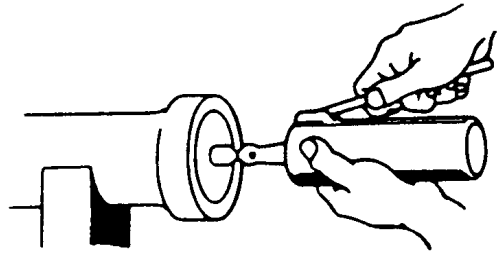

- After reassembly, check all parts for proper tightening and operation.

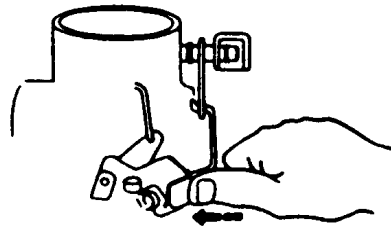

- When two persons work together, pay attention to the mutual working safety.

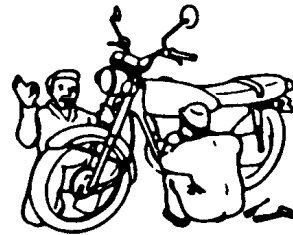

- Disconnect the battery negative (-) terminal before operation.
- When using a spanner or other tools, make sure not to damage the motorcycle surface.

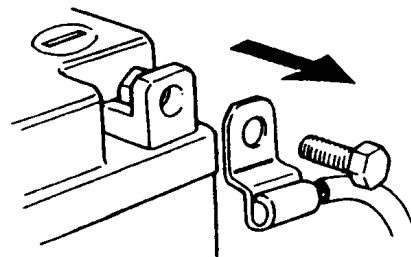

- After operation, check all connecting points, fasteners, and lines for proper connection and installation.
- When connecting the battery, the positive (+) terminal must be connected first.
- After connection, apply grease to the battery terminals.
- Terminal caps shall be installed securely.

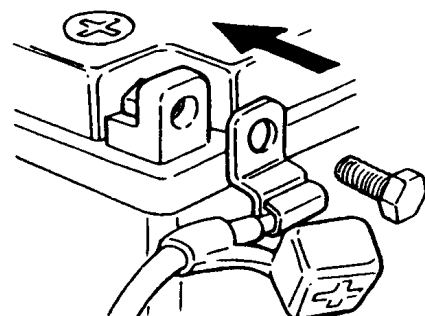

1. GENERAL INFORMATION

- If the fuse is burned out, find the cause and repair it. Replace it with a new one according to the specified capacity.

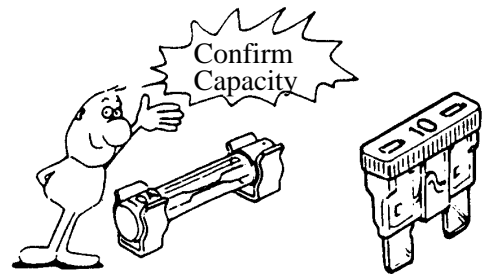

- After operation, terminal caps shall be installed securely.

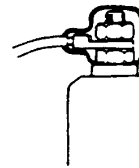

- When taking out the connector, the lock on the connector shall be released before operation.

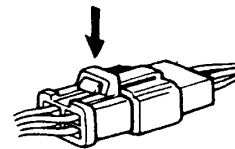

- Hold the connector body when connecting or disconnecting it.
- Do not pull the connector wire.



- Check if any connector terminal is bending, protruding or loose.

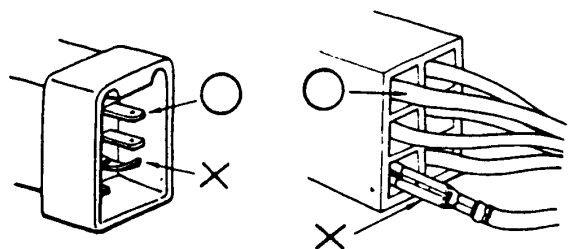

1. GENERAL INFORMATION

- The connector shall be inserted completely.
- If the double connector has a lock, lock it at the correct position.
- Check if there is any loose wire.

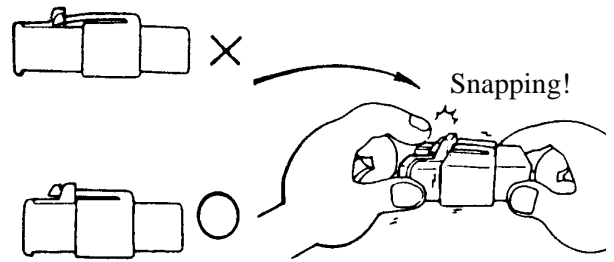

- Before connecting a terminal, check for damaged terminal cover or loose negative terminal.

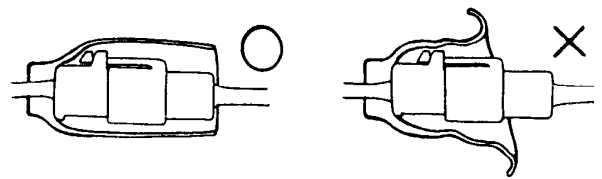

- Check the double connector cover for proper coverage and installation.

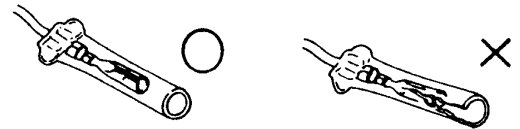

- Insert the terminal completely.
- Check the terminal cover for proper coverage.
- Do not make the terminal cover opening face up.

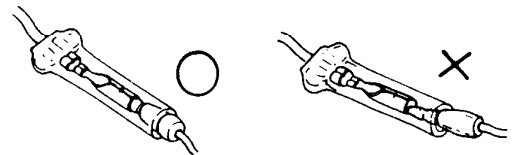

- Secure wire harnesses to the frame with their respective wire bands at the designated locations. Tighten the bands so that only the insulated surfaces contact the wire harnesses.

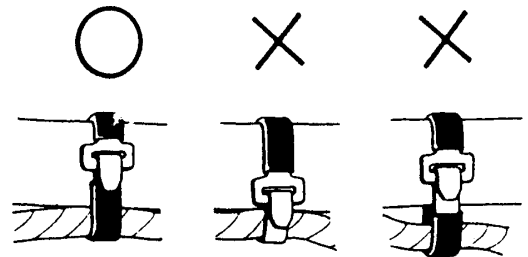

1. GENERAL INFORMATION

- After clamping, check each wire to make sure it is secure.

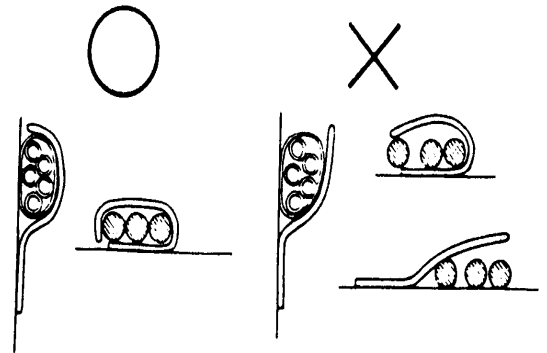

- Do not squeeze wires against the weld or its clamp.



- After clamping, check each harness to make sure that it is not interfering with any moving or sliding parts.

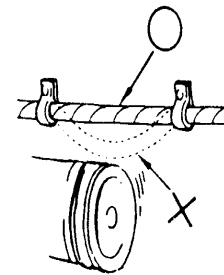

- When fixing the wire harnesses, do not make it contact the parts which will generate high heat.

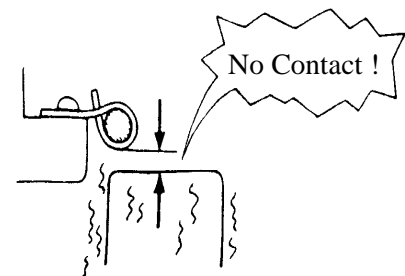

- Route wire harnesses to avoid sharp edges or corners. Avoid the projected ends of bolts and screws.
- Route wire harnesses passing through the side of bolts and screws. Avoid the projected ends of bolts and screws.

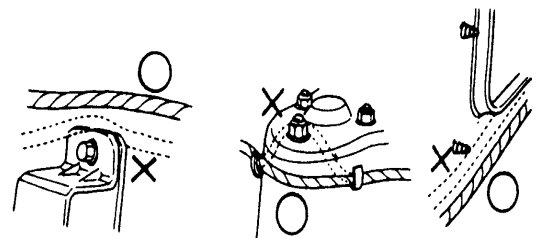

1. GENERAL INFORMATION

- Route harnesses so they are neither pulled tight nor have excessive slack.

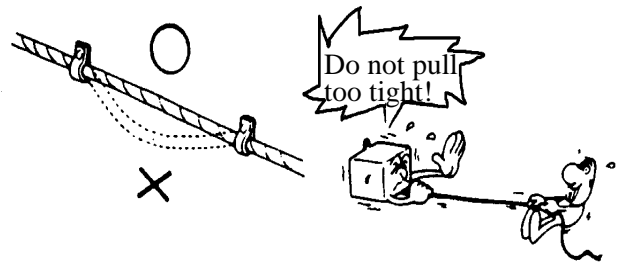

- Protect wires and harnesses with electrical tape or tube if they contact a sharp edge or corner.

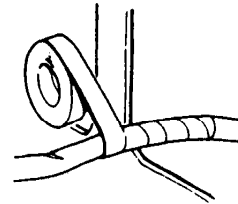

- When rubber protecting cover is used to protect the wire harnesses, it shall be installed securely.

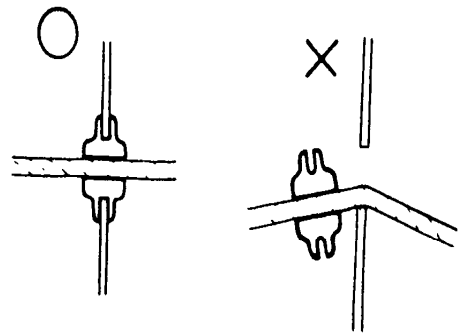

- Do not break the sheath of wire.
- If a wire or harness is with a broken sheath, repair by wrapping it with protective tape or replace it.

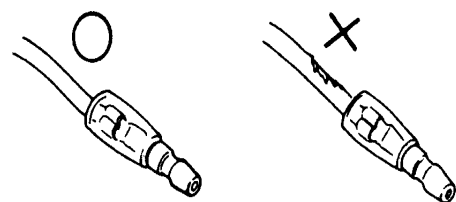

- When installing other parts, do not press or squeeze the wires.

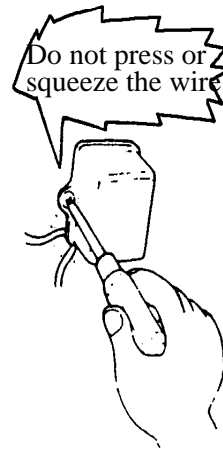

1. GENERAL INFORMATION

- After routing, check that the wire harnesses are not twisted or kinked.

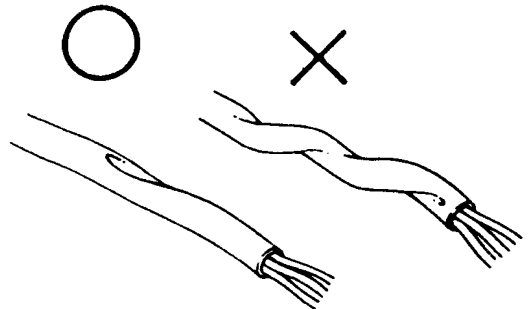

- Wire harnesses routed along with handlebar should not be pulled tight, have excessive slack or interfere with adjacent or surrounding parts in all steering positions.

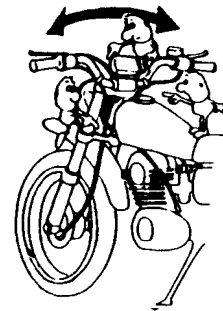

- When a testing device is used, make sure to understand the operating methods thoroughly and operate according to the operating instructions.

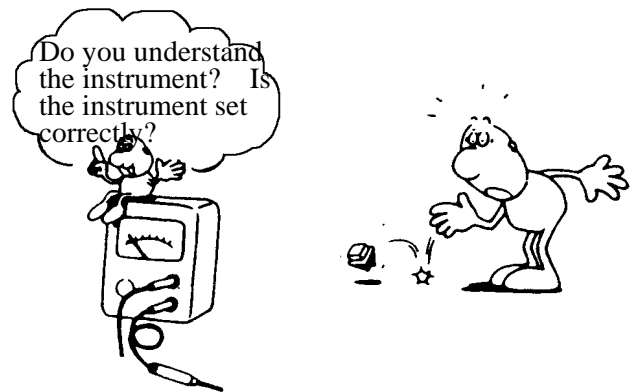

- Be careful not to drop any parts.

- When rust is found on a terminal, remove the rust with sand paper or equivalent before connecting.



- Do not bend or twist control cables. Damaged control cables will not operate smoothly and may stick or bind.

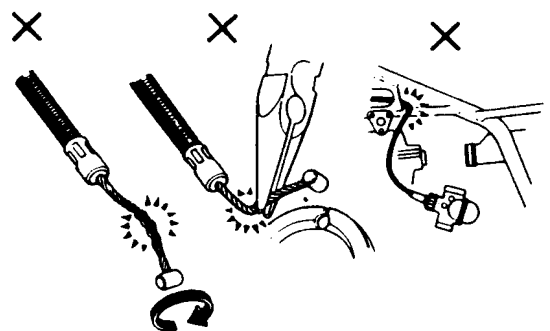

1. GENERAL INFORMATION

■ Symbols:

The following symbols represent the servicing methods and cautions included in this service manual.



Engine Oil

: Apply engine oil to the specified points. (Use designated engine oil for lubrication.)



Grease

: Apply grease for lubrication.



: Use special tool.



: Caution



: Warning

1. GENERAL INFORMATION

TORQUE VALUES

STANDARD TORQUE VALUES

Item	Torque (kg-m)	Item	Torque (kg-m)
5mm bolt, nut	0.45~0.6	5mm screw	0.35~0.5
6mm bolt, nut	0.8~1.2	6mm nut, SH bolt	0.7~1.1
8mm bolt, nut	1.8~2.0	6mm flange bolt, nut	1.0~1.4
10mm bolt, nut	3.0~4.0	8mm flange bolt, nut	2.0~3.0
12mm bolt, nut	5.0~6.0	10mm flange bolt, nut	3.5~4.5

Torque specifications listed below are for important fasteners.

ENGINE

Item	Q'ty	Thread dia.(mm)	Torque (kg-m)	Remarks
Cylinder head bolt A	2	8	2.8~3.2	Double end bolt
Cylinder head bolt B	2	8	2.8~3.2	Double end bolt
Oil filter screen cap	1	30	1.5~3.0	
Exhaust muffler joint lock nut	2	6	0.8~1.2	Double end bolt
Valve adjusting lock nut	2	5	1.4~1.8	
Oil bolt	1	12	2.0~3.0	
Cylinder bolt	2	6	0.8~1.2	
A.C. generator bolt	1	14	4.0~5.2	
Cylinder head cover bolt	4	6	0.8~1.2	
Oil pump bolt	2	6	0.7~1.1	
Oil filter lock nut	1	16	1.5~3.0	
Rocker arm lock bolt	3	8	1.5~2.0	
Cylinder head lock bolt	1	8x79	1.5~2.0	
Cylinder bolt	2	6x22	0.8~1.2	
Crankcase assembly bolt	10	6	0.8~1.5	
Crankshaft damper bolt	1	6x25	0.8~1.2	
Right crankcase cover bolt	8	6	0.8~1.2	
Left crankcase cover bolt	4	6	0.8~1.2	
A.C. generator coil lock bolt	4	5	0.4~1.7	
Starter gear set plate bolt	1	6	1.0~1.6	
Carburetor lock bolt	2	6	0.8~1.2	

FRAME

Item	Q'ty	Thread dia.(mm)	Torque (kg-m)	Remarks
Steering stem lock nut	1	22	6.0~9.0	
Front axle nut	1	14	5.5~7.0	
Rear axle nut	1	16	6.0~8.0	
Rear shock absorber upper mount bolt	2	10	3.0~4.0	
Rear shock absorber lower mount bolt	2	10	3.0~4.0	
Rear fork pivot nut	1	12	5.5~7.0	
Handlebar lock bolt	4	6	6.0~9.0	
Rear driven gear bolt	4	8	1.8~2.0	
Rear brake panel bolt	1	8	1.8~2.5	

1. GENERAL INFORMATION

SPECIAL TOOLS

Tool Name	Tool No.	Remarks	Ref. Page	
Valve adjuster	780614			
Valve guide driver				
Valve guide reamer				
Valve spring compressor attachment				
IN valve seat cutter				
EX valve seat cutter				
IN valve seat cutter				
EX valve seat cutter				
Valve seat cutter clip, 5.5mm				
Clutch holder				
Generator stator puller				
Valve remover				
Valve guide remover				
T socket wrench, 16mm				
Flywheel puller				
Universal holder				5008405
Rear shock absorber compressor				5008411
Steering stem wrench	5008422			
Ball race remover				
Steering stem bottom ball race driver	5008001-01~07			
Bearing remover head, 12mm	5008416-03			
Bearing remover, 15mm	5008416-05			

1. GENERAL INFORMATION

LUBRICATION POINTS

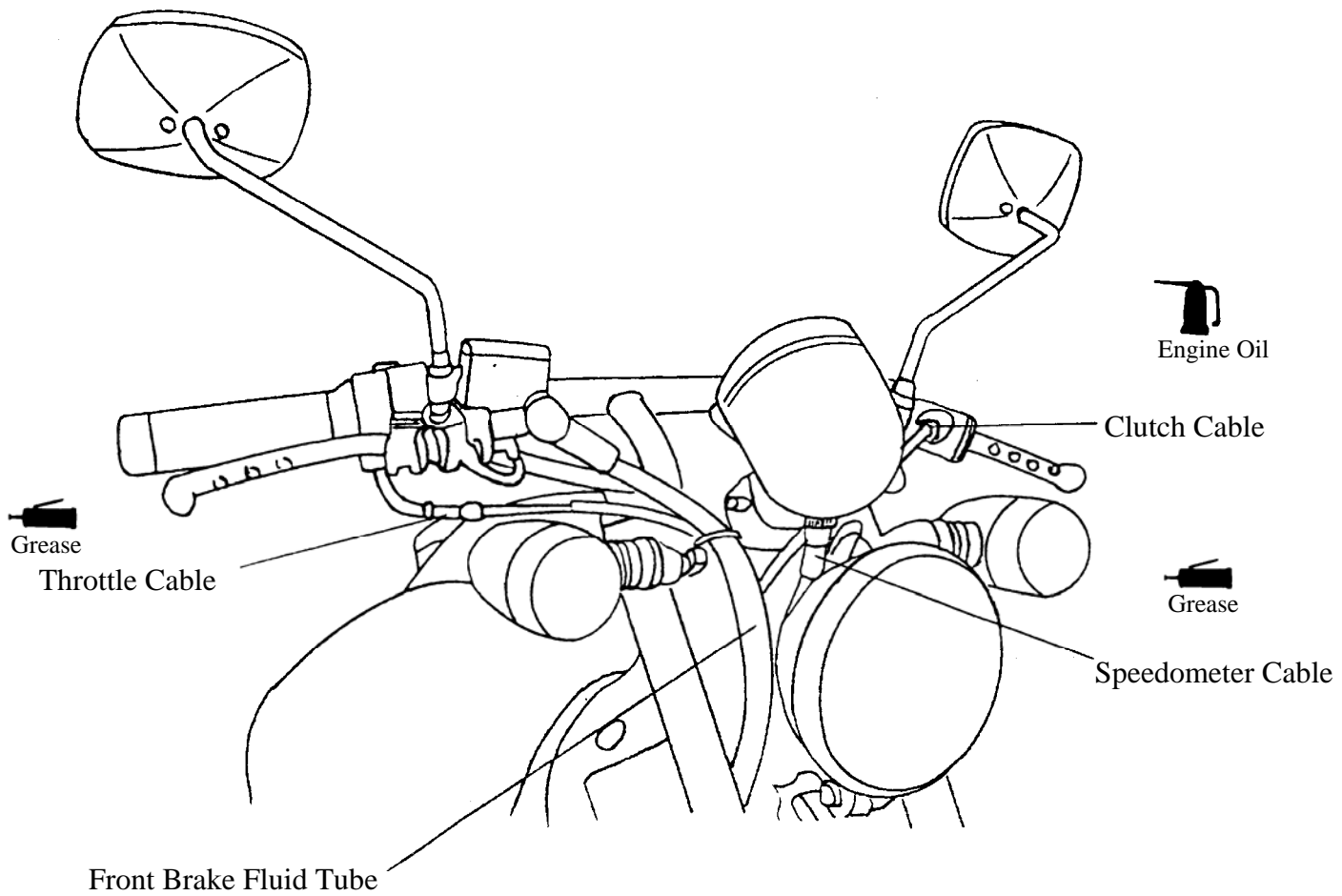

1. GENERAL INFORMATION

CABLE & HARNESS ROUTING

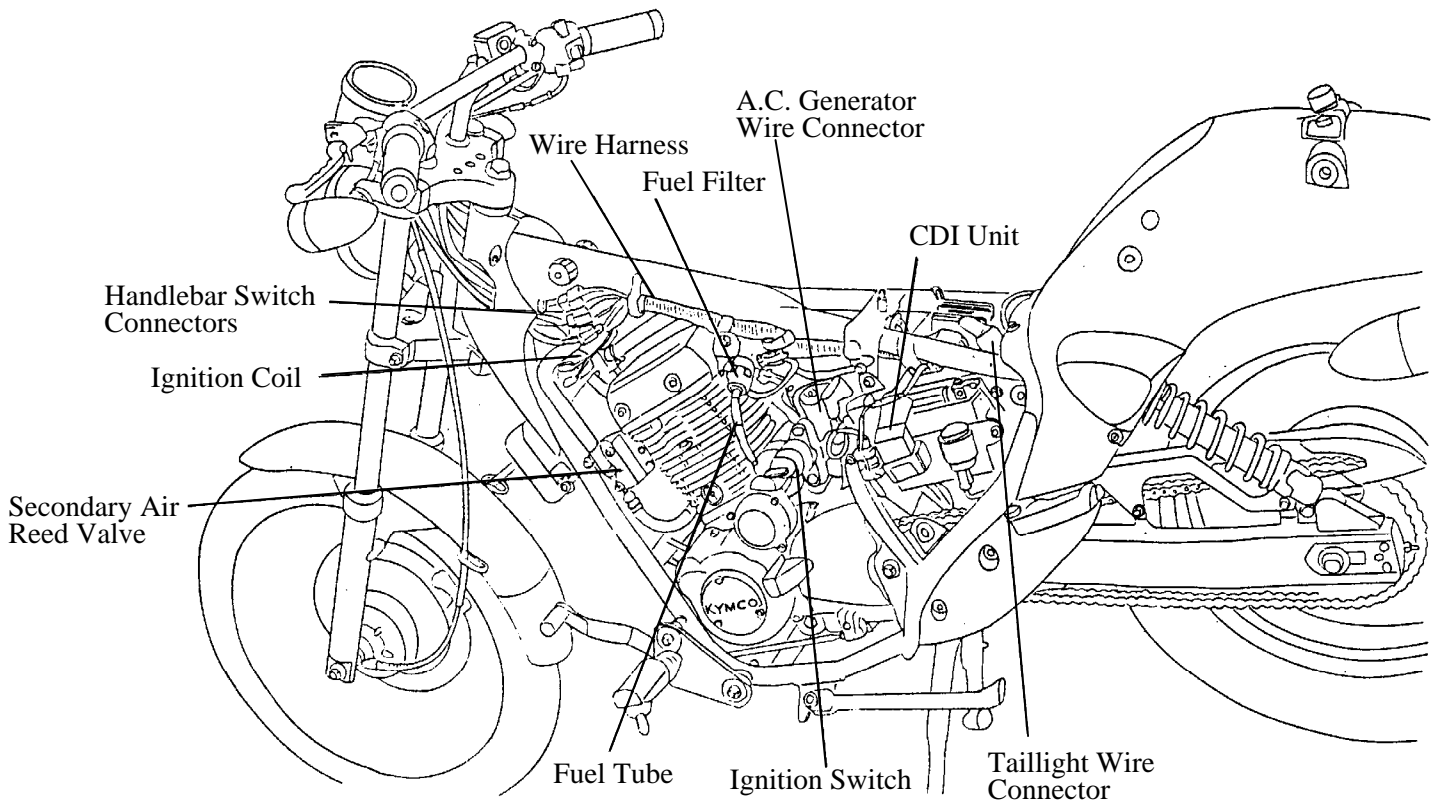

1. GENERAL INFORMATION

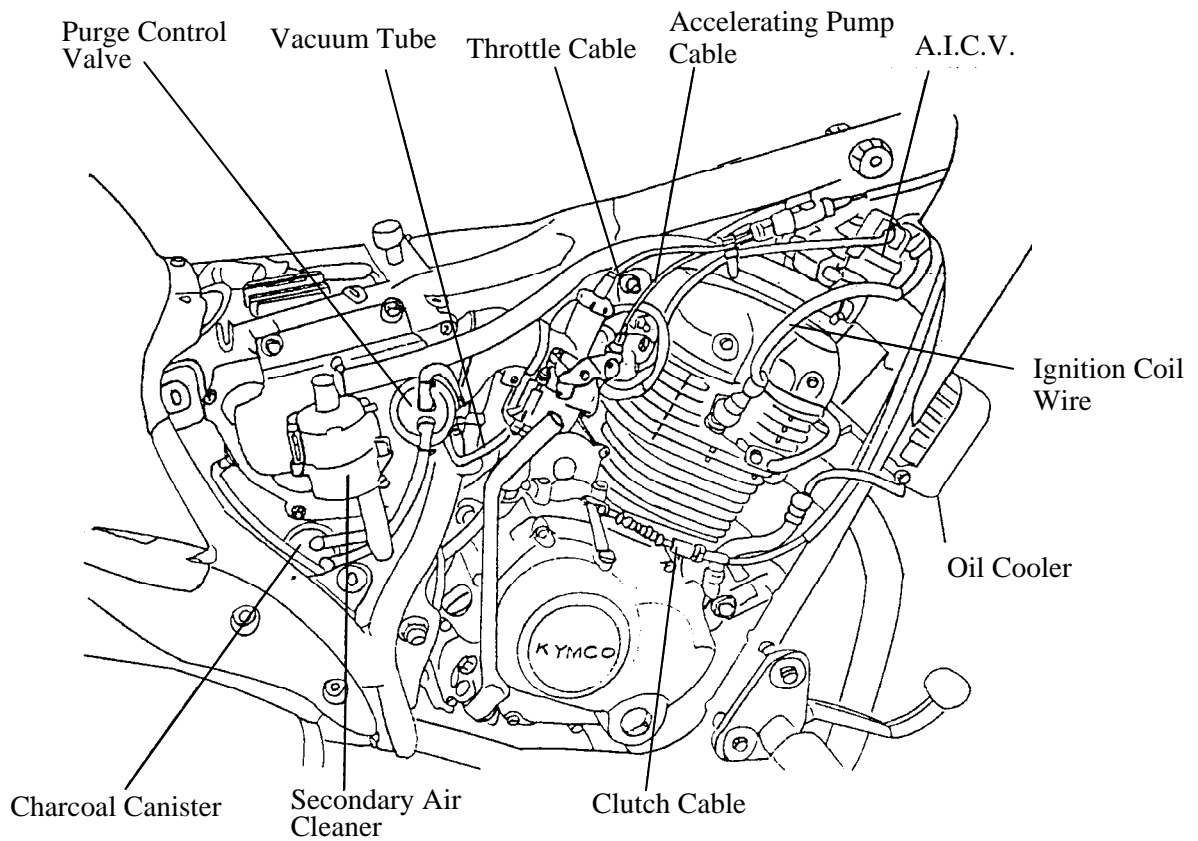
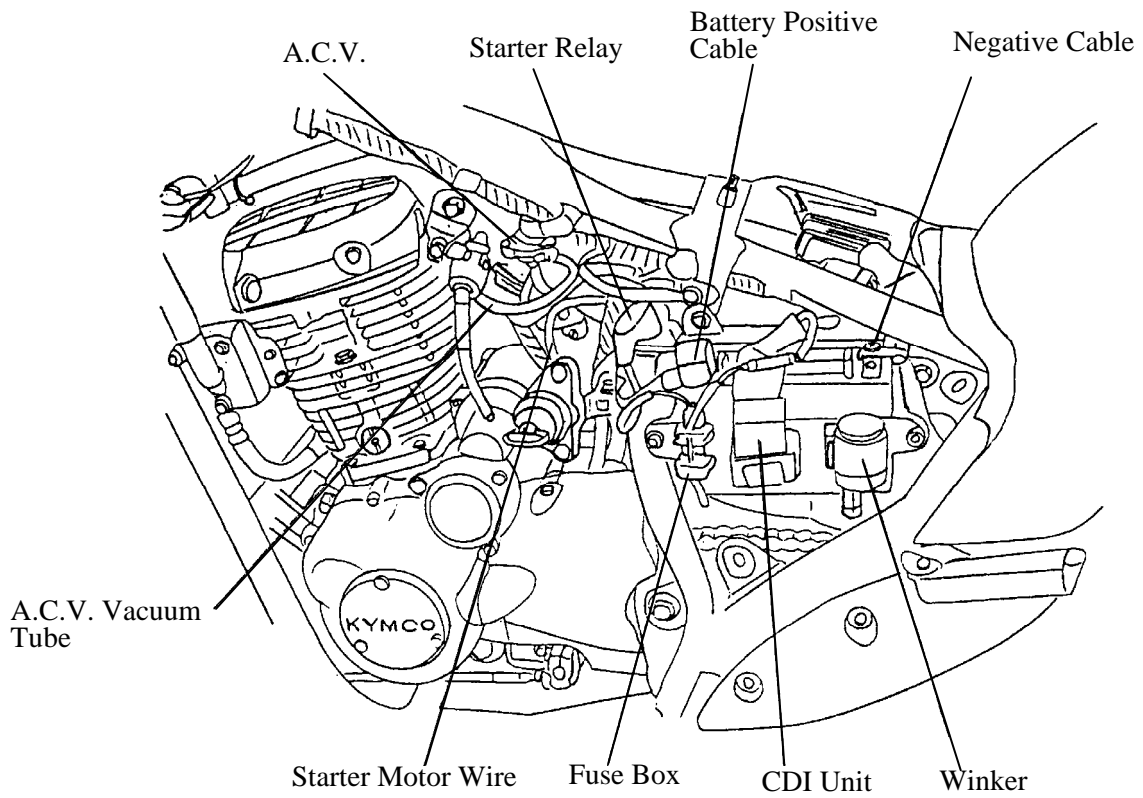

1. GENERAL INFORMATION

WIRING DIAGRAM

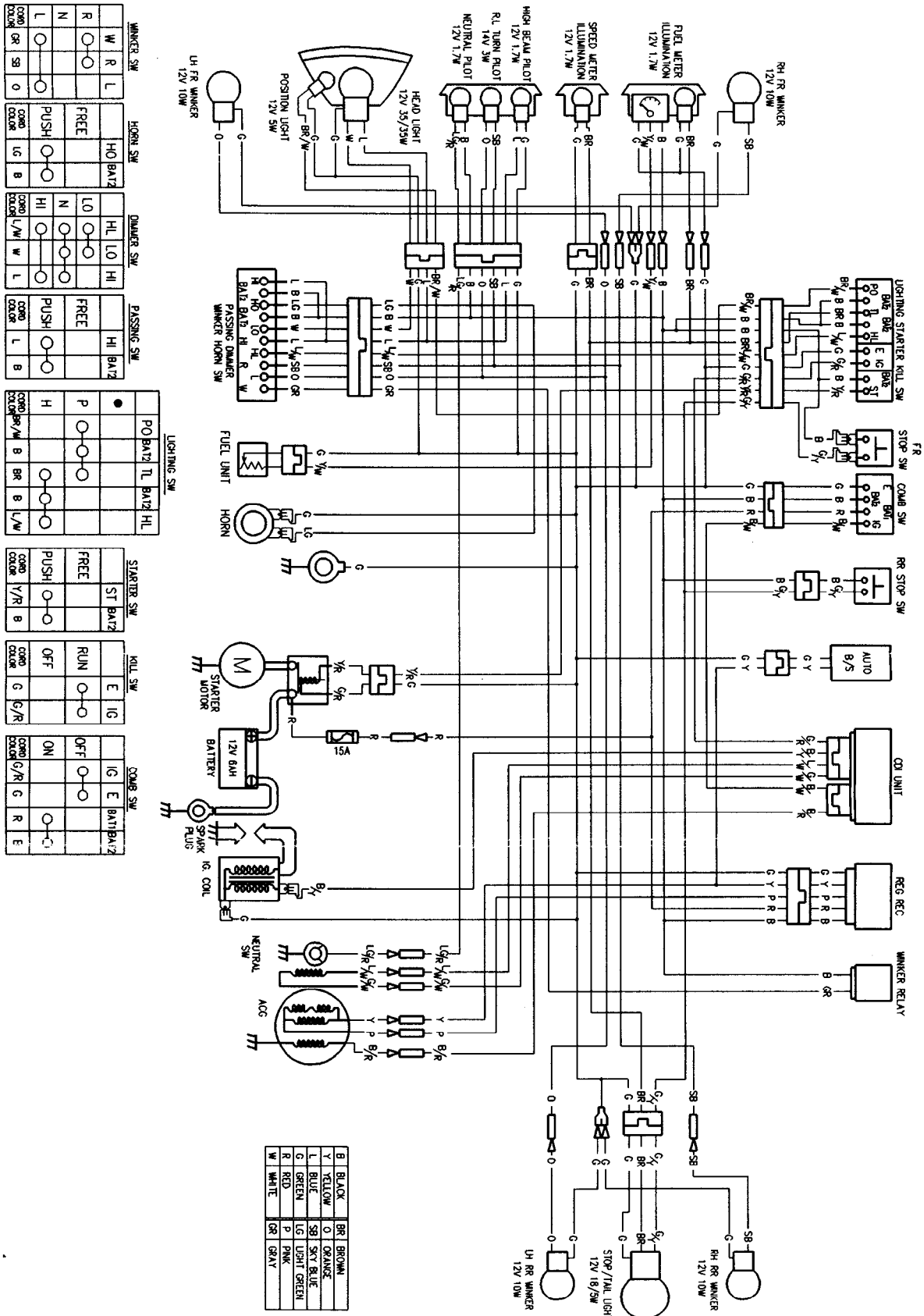

1. GENERAL INFORMATION

TROUBLESHOOTING

ENGINE WILL NOT START OR IS HARD TO START

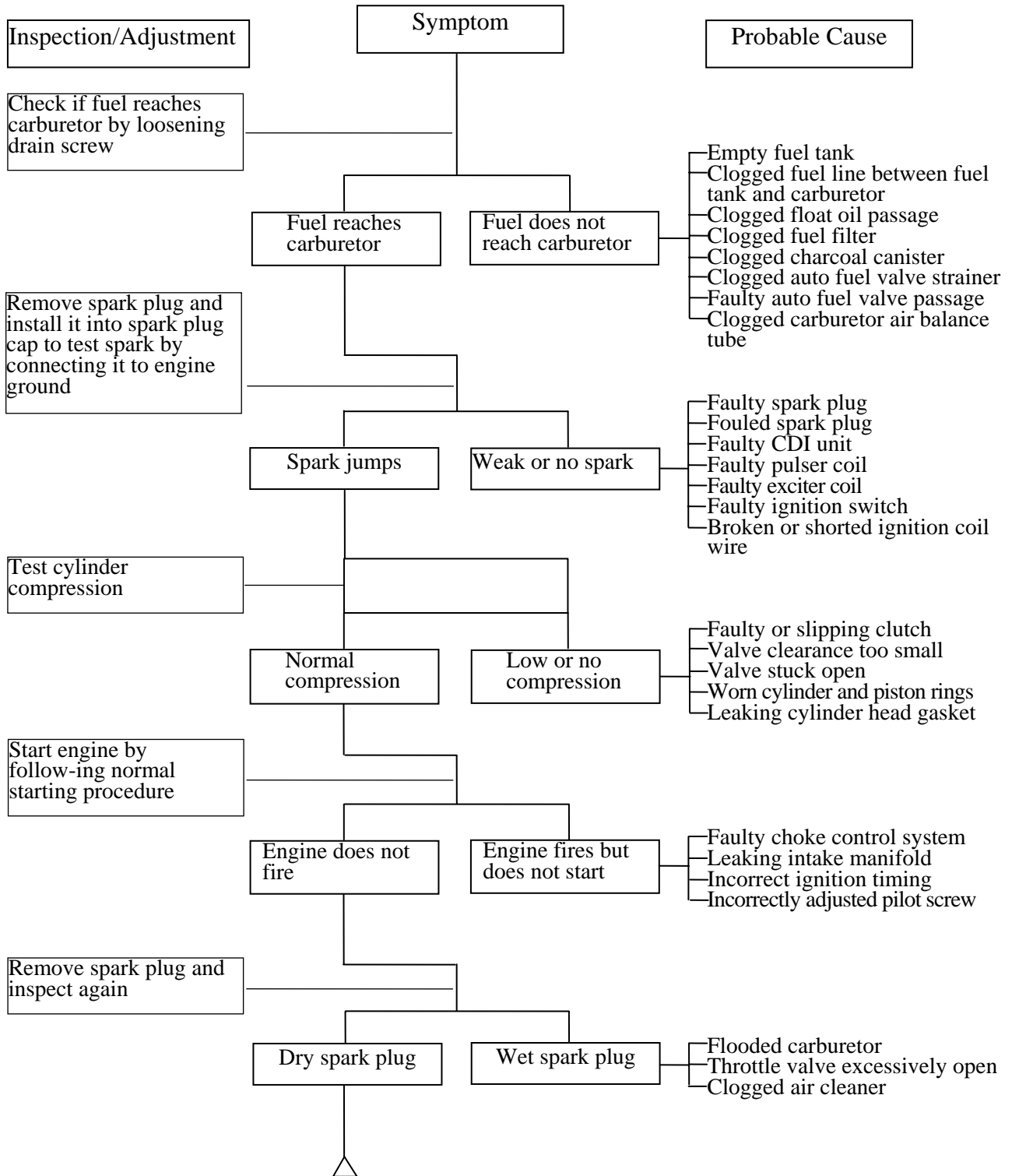

1. GENERAL INFORMATION

POOR PERFORMANCE (ESPECIALLY AT IDLE AND LOW SPEEDS)

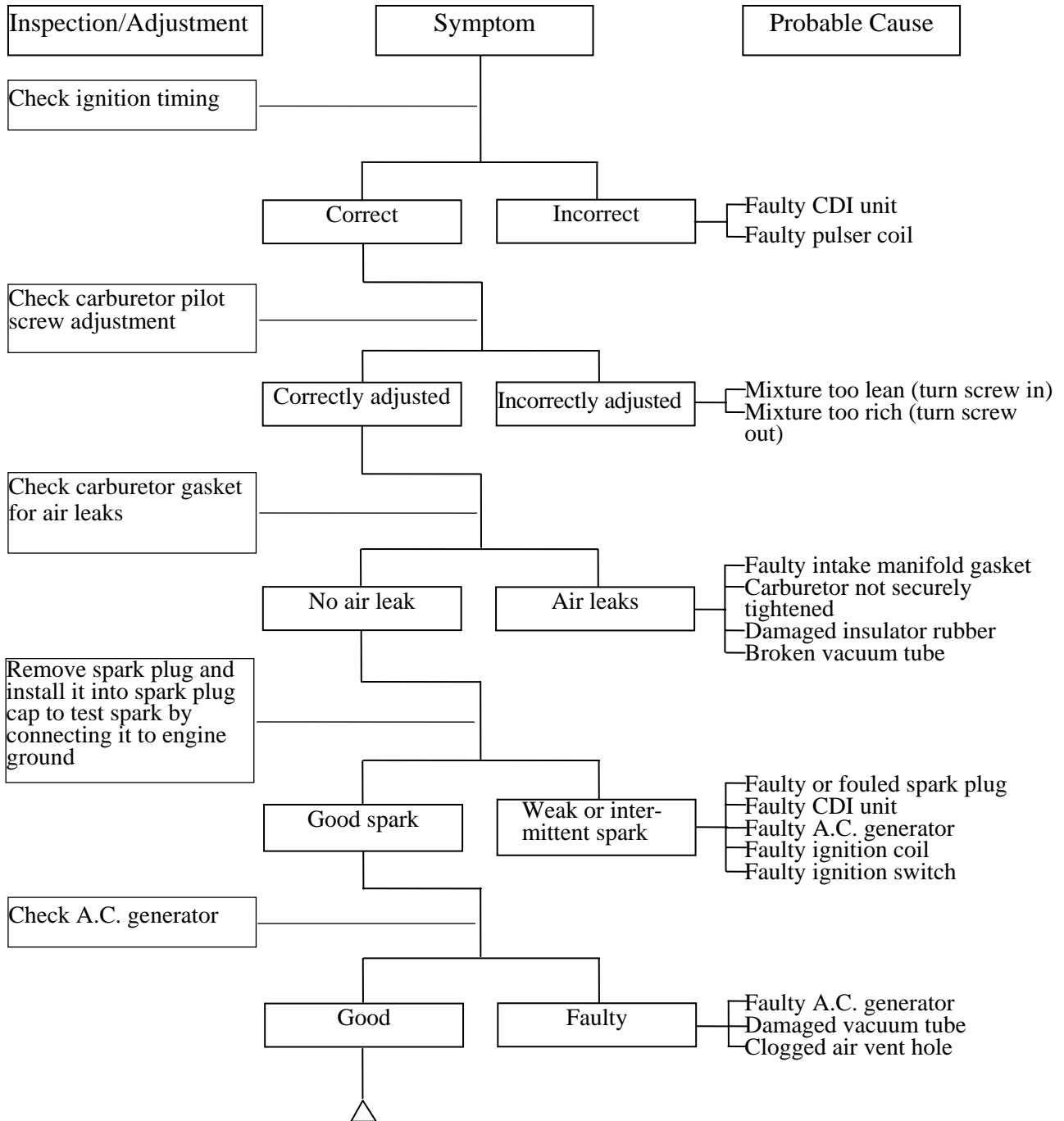

1. GENERAL INFORMATION

POOR PERFORMANCE (ENGINE LACKS POWER)

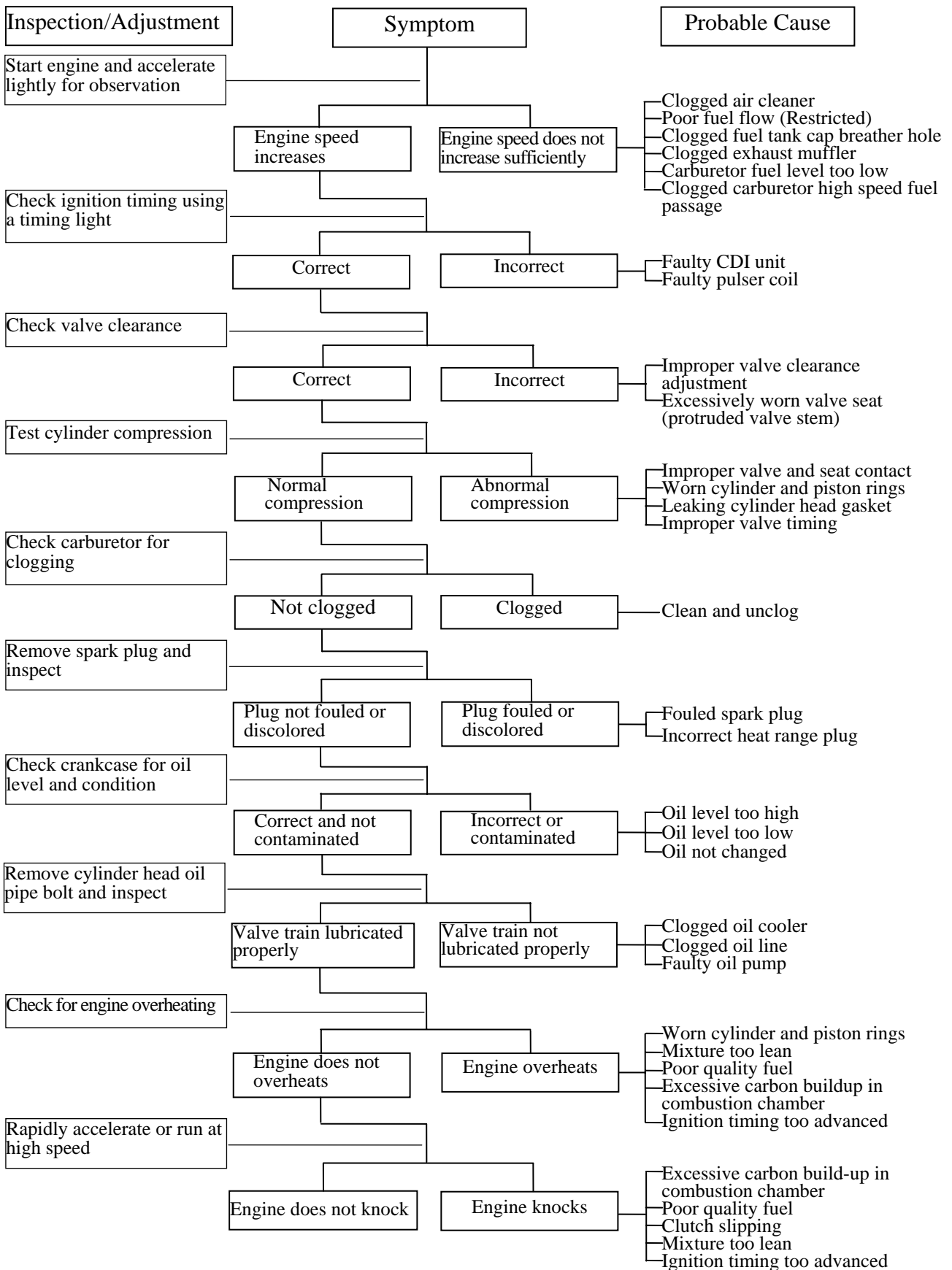

1. GENERAL INFORMATION

POOR PERFORMANCE (AT HIGH SPEED)

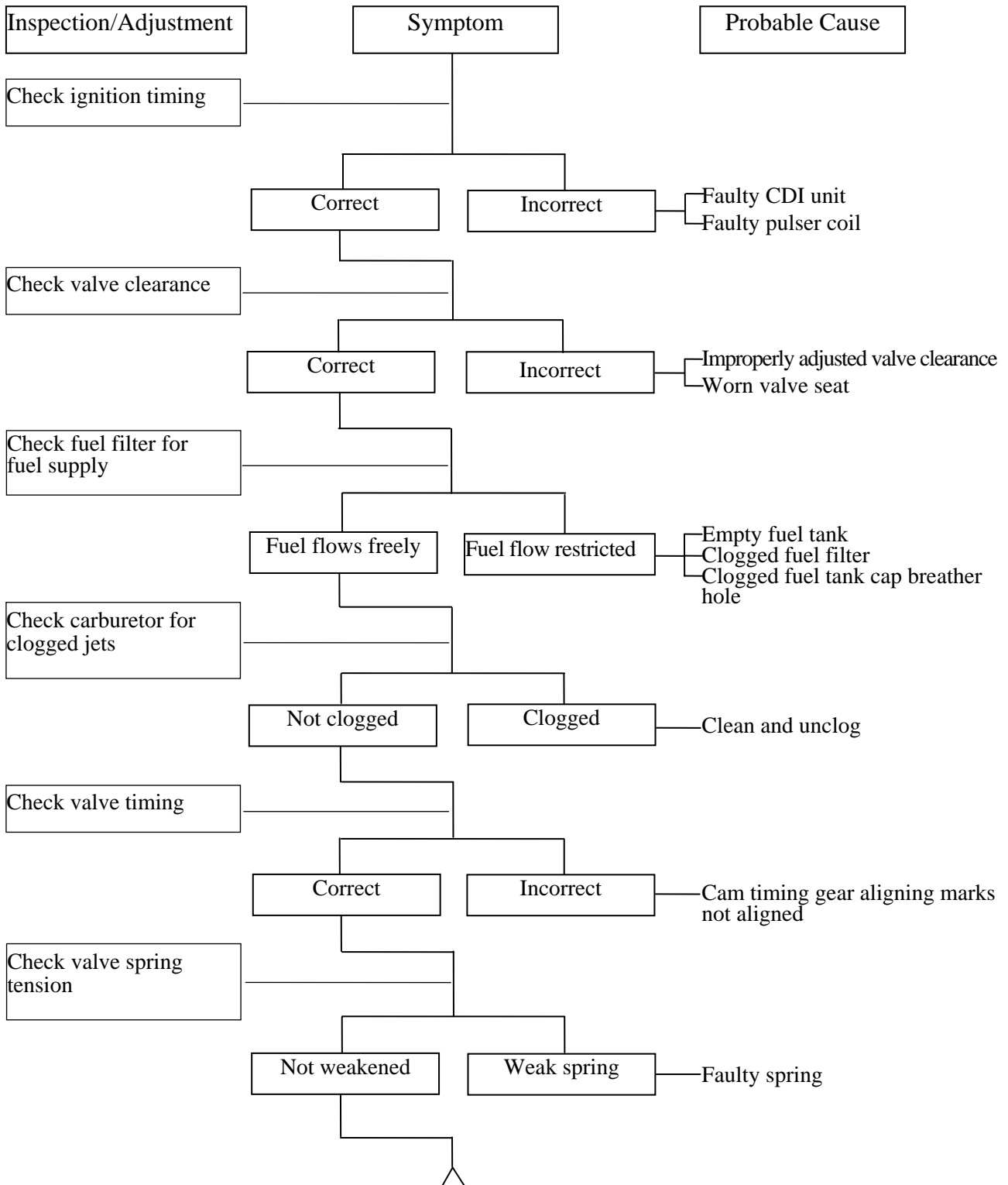

1. GENERAL INFORMATION

POOR CHARGING (BATTERY OVER DISCHARGING OR OVERCHARGING)

Undercharging

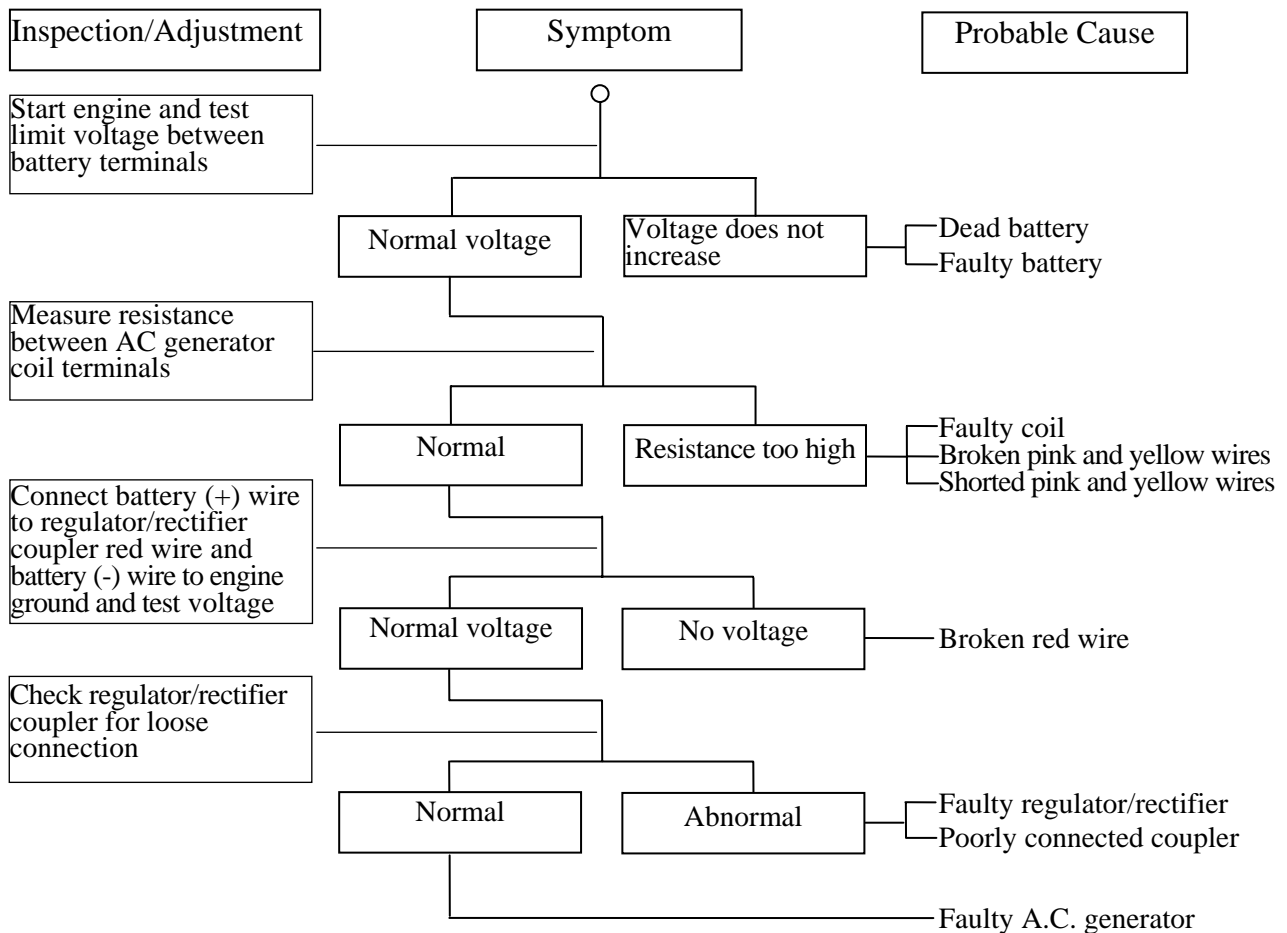

Overcharging

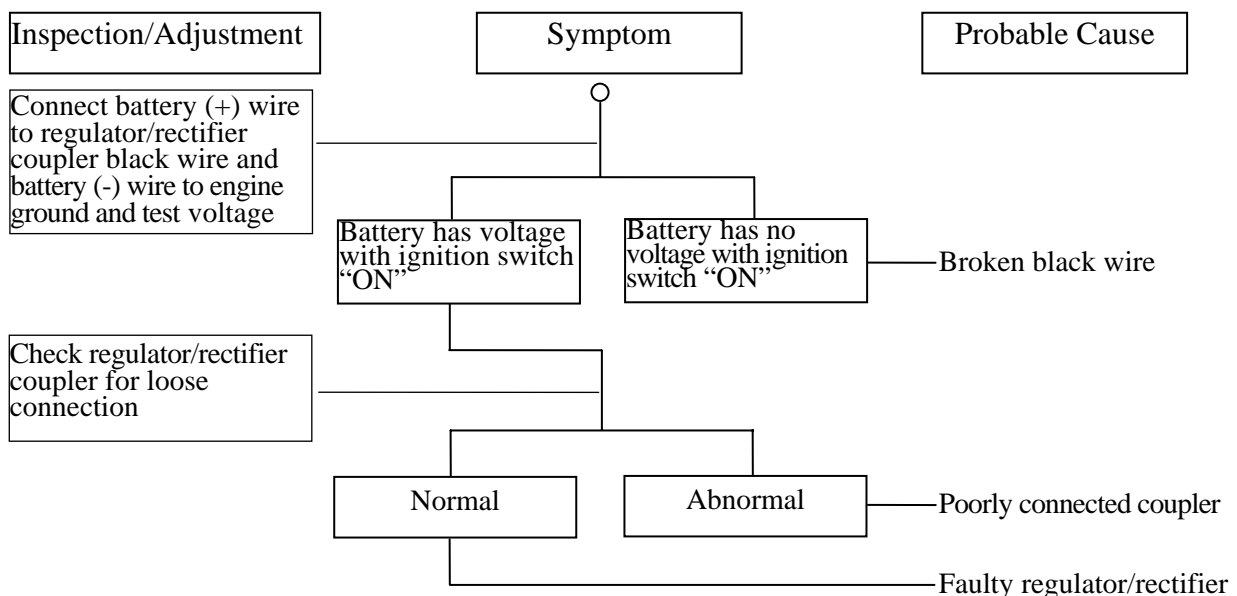

1. GENERAL INFORMATION

NO SPARK AT SPARK PLUG

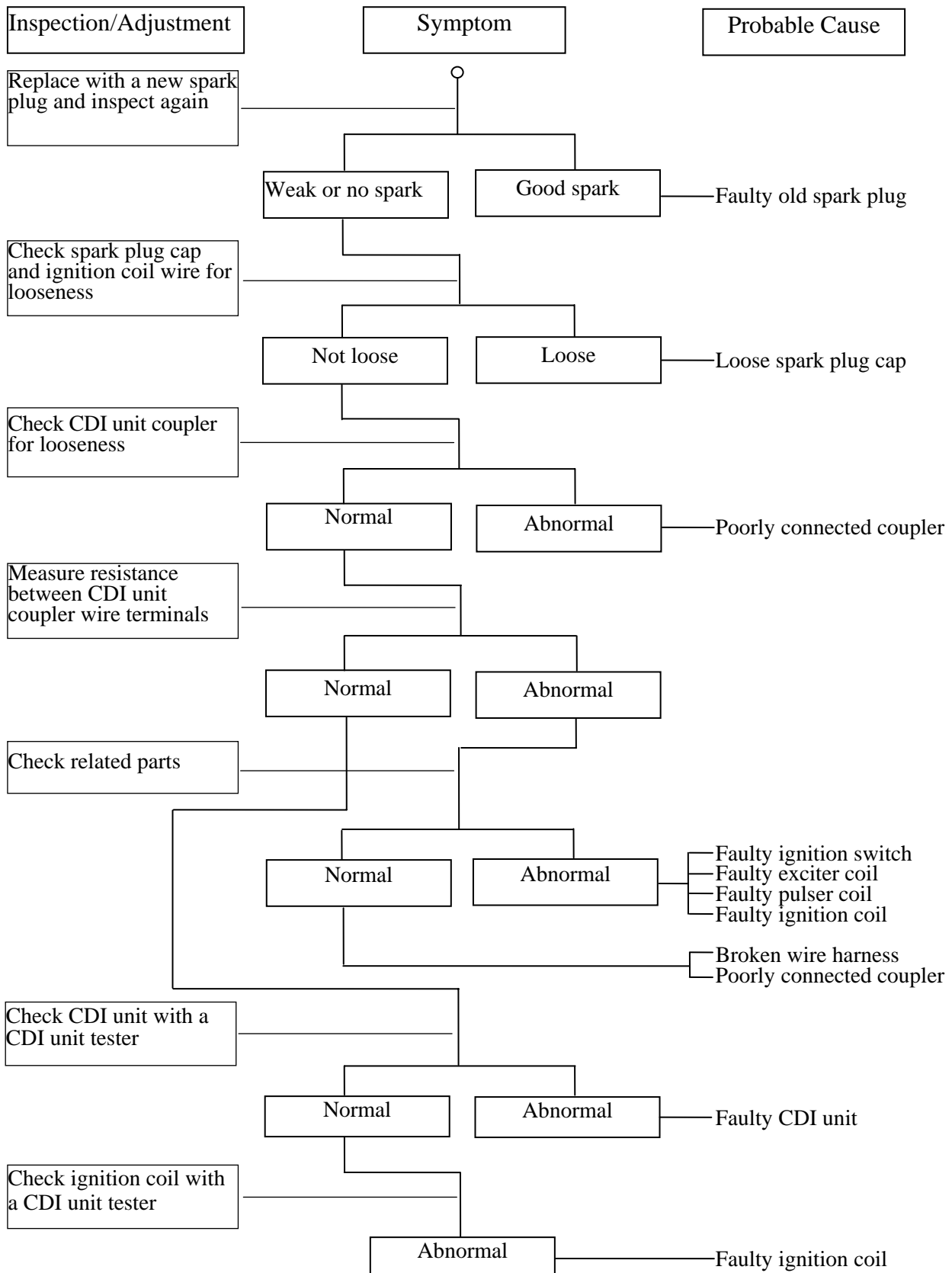

2. INSPECTION/ADJUSTMENT

INSPECTION/ADJUSTMENT

SERVICE INFORMATION-----	2- 1
MAINTENANCE SCHEDULE-----	2- 2
FUEL LINE/FILTER-----	2- 3
THROTTLE OPERATION-----	2- 3
AIR CLEANER-----	2- 4
SPARK PLUG-----	2- 4
VALVE CLEARANCE-----	2- 5
CARBURETOR IDLE SPEED-----	2- 5
IGNITION TIMING-----	2- 6
CYLINDER COMPRESSION-----	2- 6
ENGINE OIL-----	2- 7
DRIVE CHAIN-----	2- 7
BRAKE SHOE/BRAKE ADJUSTMENT-----	2- 8
CLUTCH-----	2- 8
BRAKE FLUID-----	2- 8
SUSPENSION-----	2- 9
NUTS/BOLTS/FASTENERS-----	2- 9
WHEELS/TIRES-----	2- 9
STEERING HANDLEBAR-----	2-10

2. INSPECTION/ADJUSTMENT

SERVICE INFORMATION

GENERAL

WARNING

- Before running the engine, make sure that the working area is well-ventilated. Never run the engine in a closed area. The exhaust contains poisonous carbon monoxide gas which may cause death to people.
- Gasoline is extremely flammable and is explosive under some conditions. The working area must be well-ventilated and do not smoke or allow flames or sparks near the working area or fuel storage area.

SPECIFICATIONS

ENGINE

Throttle grip free play : 2~6mm
Spark plug gap : 0.6~0.7mm
Spark plug specification : DR8EA
Valve clearance : IN: 0.08mm Cold Engine: IN: 0.05mm
EX: 0.08mm EX: 0.05mm
Cylinder compression : 150cc: 16kg/cm²
125cc: 12kg/cm²
Ignition timing : 15°/1600rpm
Idle speed : 1600±100rpm
Engine oil capacity:
At disassembly : 1.1 liter
At change : 1.0 liter

CHASSIS

Front brake free play: 10~20mm
Rear brake free play : 10~20mm
Brake fluid : DOT-3

TIRE PRESSURE

	1 Rider	2 Riders
Front	1.75kg/cm ²	1.75kg/cm ²
Rear	2.0kg/cm ²	2.25kg/cm ²

TIRE SIZE:

Front : 3.00-18
Rear : 130/90-15

TORQUE VALUES

Front axle nut 5.5~7.0kg-m
Rear axle nut 6.0~8.0kg-m

2. INSPECTION/ADJUSTMENT

MAINTENANCE SCHEDULE

Perform the periodic maintenance at each scheduled maintenance period.

I: Inspect, and Clean, Adjust, Lubricate, Refill, Repair or Replace if necessary.

A: Adjust C: Clean R: Replace T: Tighten

Item	Frequency	Whichever comes first ⇔ ↓	Regular Service Mileage (km)											
			1000	2000	3000	4000	5000	6000	7000	8000	9000	10000	11000	12000
Engine oil			R New motorcycle 300km		R		R		R		R		R	
Engine oil filter screen					C				C				C	
Fuel filter screen												R		
Valve clearance			A New motorcycle 300km		A				A				A	
Carburetor					I				I				I	
Air Cleaner	Note 2,3		I		R		I		R		I		R	
Spark plug			Clean at every 3000km and replace if necessary											
Brake system			I		I		I		I		I		I	
Drive chain			A		A		A		A		A		A	
Suspension			I						I					
Nuts, bolts, fasteners			I			T			I				T	
Tire			I						I					I
Steering head bearing			I											I

- In the interest of safety, we recommend these items should be serviced only by an authorized KYMCO motorcycle dealer.

Note: 1. For higher odometer readings, repeat at the frequency interval established here.

2. Service more frequently when riding in dusty or rainy areas.

3. Service more frequently when riding for long distance, in rain or at full throttle.

2. INSPECTION/ADJUSTMENT

FUEL LINE/FILTER

Check the fuel lines and replace any parts which show signs of deterioration, damage or leakage.

* Do not smoke or allow flames or sparks in your working area.

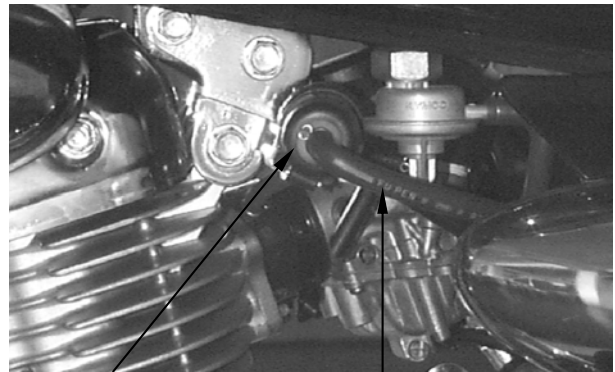

Fuel Filter

Fuel Line

THROTTLE OPERATION

Check for smooth throttle grip movement in all steering positions.

Measure the throttle grip free play.

Free Play: 2~6mm

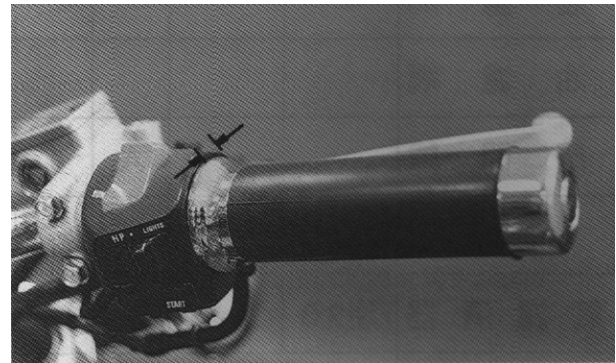

Adjust the throttle grip free play by turning the adjusting nut on the throttle cable. Slide the dust boot out and adjust by loosening the lock nut and turning the adjusting nut.

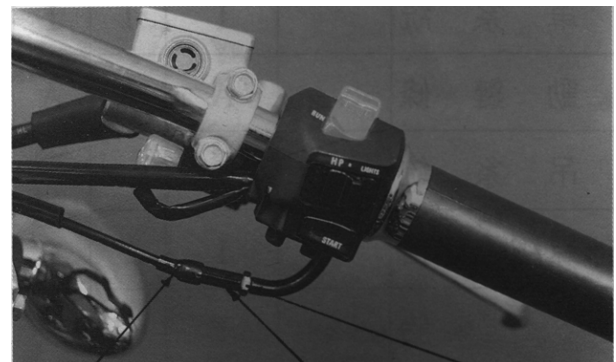

Dust Boot

Adjusting Nut

Lock Nut

Punch Mark

Check if the punch mark on the carburetor accelerating pump is aligned. Align the punch mark by turning the adjusting nut at the accelerating pump cable.



Lock Nut

Adjusting Nut

2. INSPECTION/ADJUSTMENT

AIR CLEANER

AIR CLEANER REPLACEMENT

Remove the right side cover. Remove the two screws attaching the emission control system.

Remove the air cleaner case cover screws and the cover.

Remove the air cleaner screen and element. Check the element and replace it with a new one if it is excessively dirty or damaged.

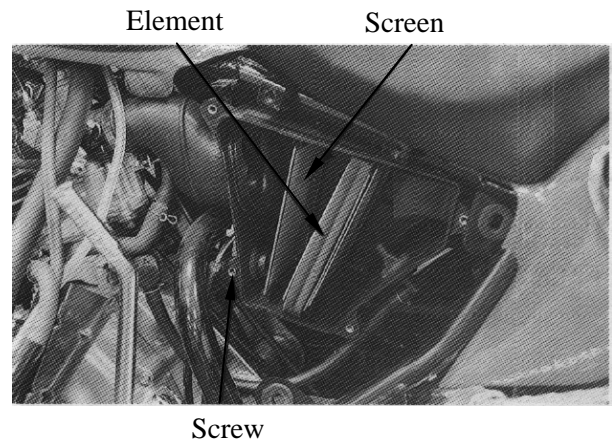

CHANGE INTERVAL

More frequent replacement is required when riding in unusually dusty or rainy areas.

- * If the air cleaner is installed improperly, dust may be sucked into the cylinder directly to reduce the engine horse-power and affect engine service life.
- Do not wash the element in any solvent of high combustibility.

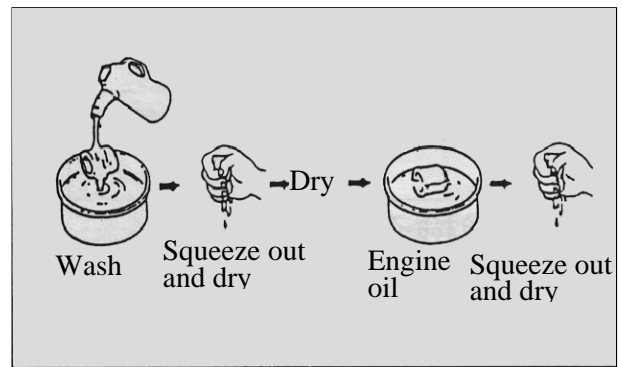

SPARK PLUG

Remove the spark plug.

Check the spark plug for wear, damage and fouling deposits.

Clean any fouling deposits with a spark plug cleaner or a wire brush.

Specified Spark Plug: DR8EA

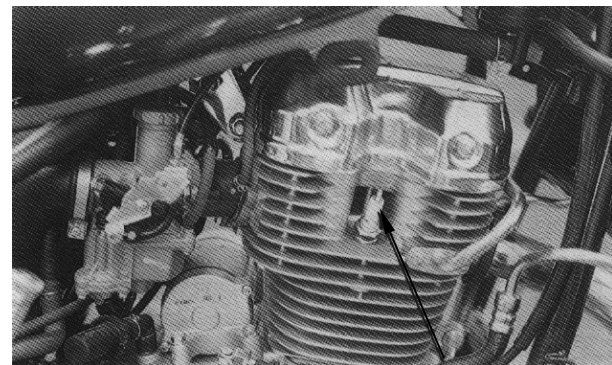

Gap, Wear, and Fouling Deposits

Spark Plug

Measure the spark plug gap.

Spark Plug Gap: 0.6~0.7mm

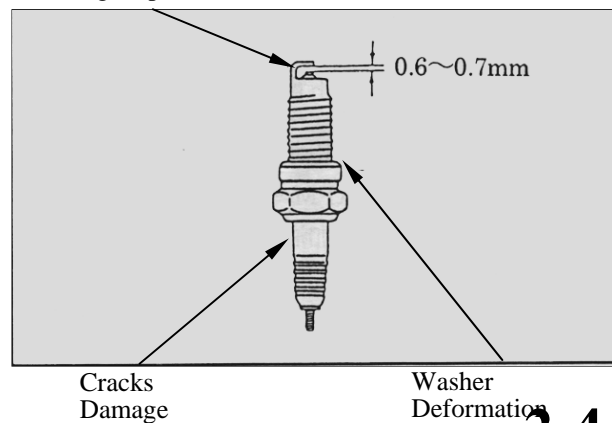

- * When installing, first screw in the spark plug by hand and then tighten it with a spark plug wrench.

2. INSPECTION/ADJUSTMENT

VALVE CLEARANCE

- * Inspect and adjust valve clearance while the engine is cold (below 35°C).

Remove the right and left side covers.
Remove the cylinder head cover protector..
Remove the cylinder head cover.

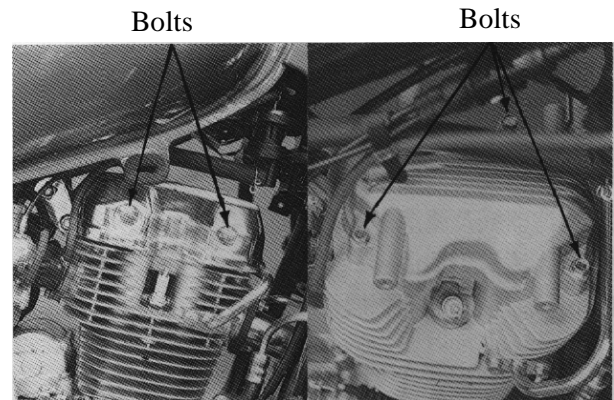

Rotate the generator flywheel to locate the camshaft on the top dead center (TDC) and align the "T" mark on the flywheel with the mark on the left crankcase cover.

- * After adjustment, rotate the crankshaft several turns to make sure that the valve clearance is correct.

Inspect and adjust the valve clearance.

Valve Clearance: IN : 0.08mm
EX: 0.08mm

Cold Engine: IN: 0.05mm
EX: 0.05mm

Loosen the lock nut and adjust by turning the adjusting bolt.

Special

Valve Wrench 780614

- * Check the valve clearance again after the lock nut is tightened.

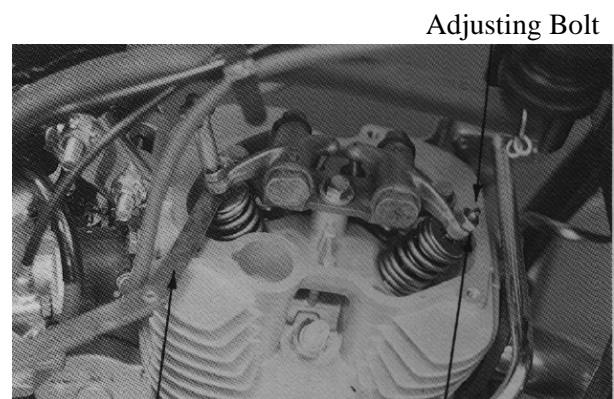
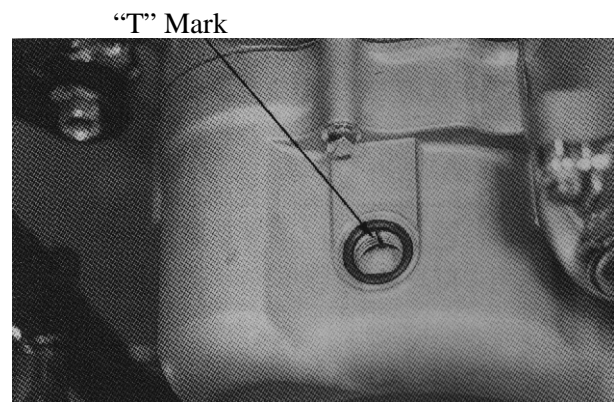

Feeler Gauge

Lock Nut

CARBURETOR IDLE SPEED

- * The engine must be warm for accurate idle speed inspection and adjustment.

Turn the throttle stop screw to obtain the specified idle speed.

Idle Speed: 1600±100rpm

When the engine misses or run erratic, adjust the pilot screw.

- * When adjusting the carburetor, make sure to use a E/M tester.

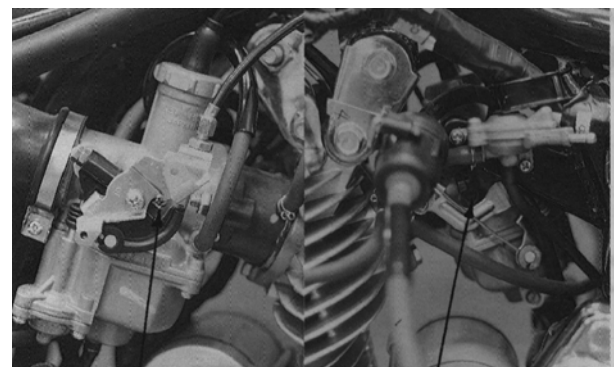

2. INSPECTION/ADJUSTMENT

IGNITION TIMING

- * The CDI unit is not adjustable.
- * If the ignition timing is incorrect, check the ignition system.

Remove the ignition timing eye hole cap on the left crankcase cover.

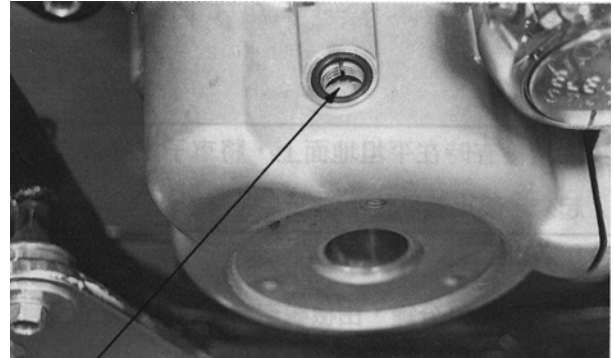

Eye Hole

Check the ignition timing with a timing light. When the engine is running at idle speed, the ignition timing is correct if the index mark on the left crankcase cover aligns with the "F" mark on the flywheel.

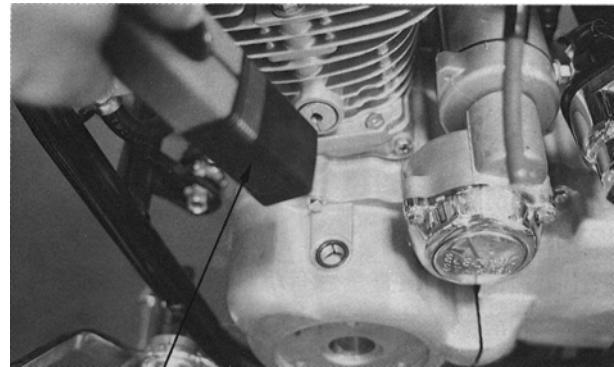

Timing Light

"F" Mark

CYLINDER COMPRESSION

Warm up the engine before compression test. Stop the engine, then remove the spark plug and insert a compression gauge. Open the throttle valve fully and crank the engine with the starter motor or kick lever. Measure the compression.

Compression: 150cc: 16kg/cm²
125cc: 12 kg/cm²

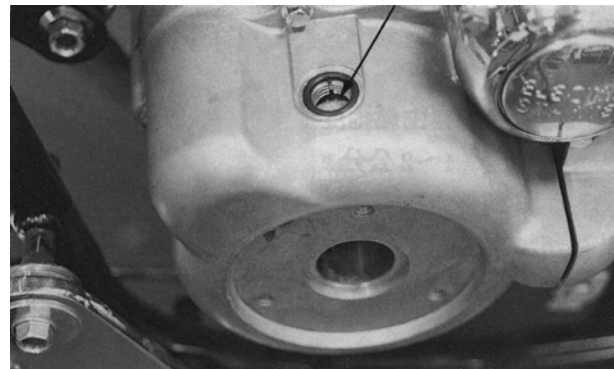

Compression Gauge

If the compression is low, check for the following:

- Leaky valves
- Valve clearance too small
- Leaking cylinder head gasket
- Worn piston rings
- Worn piston/cylinder

If the compression is high, it indicates that carbon deposits have accumulated on the combustion chamber and the piston head.

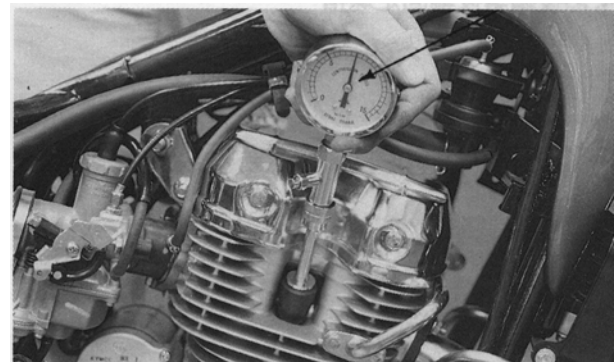

2. INSPECTION/ADJUSTMENT

ENGINE OIL

- * When checking the oil level, place the motorcycle on its main stand on level ground for oil level check.

After the engine is stopped for 10 minutes, check if the oil level is between the upper and lower limits through the watch window. If the oil level is low, add the recommended oil to the proper level.

Recommended Oil: SAE30W#

After oil change, be sure to tighten the drain bolt securely.

Check the drain bolt washer for damage.

Oil Capacity: At disassembly : 1.1 liter
At change : 1.0 liter

Engine Oil Filter Screen Cleaning

Remove the oil filter screen cap.
Remove the oil filter screen and spring and then clean with compressed air.

- * Be careful not to install the oil filter screen in the reverse direction to avoid engine damage.

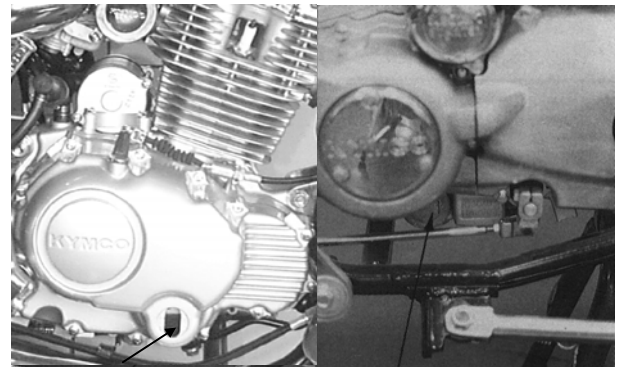

Watch Window

Oil Filter Screen Cap

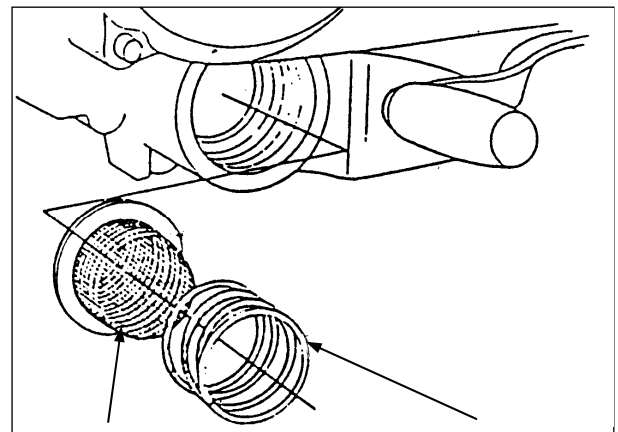

Oil Filter Screen

Spring

DRIVE CHAIN

Check the drive chain slack.

Specified Slack: 1~2cm

Drive Chain Adjustment:

1. Loosen the rear axle nut.
2. Adjust the right and left adjusting nuts to align the right punch mark with the left punch mark.
3. Turn the rear wheel to see if the drive chain slack is within the specified range.
4. Tighten the rear axle nut.

- * After drive chain adjustment, check the rear brake pedal free play and adjust if necessary.

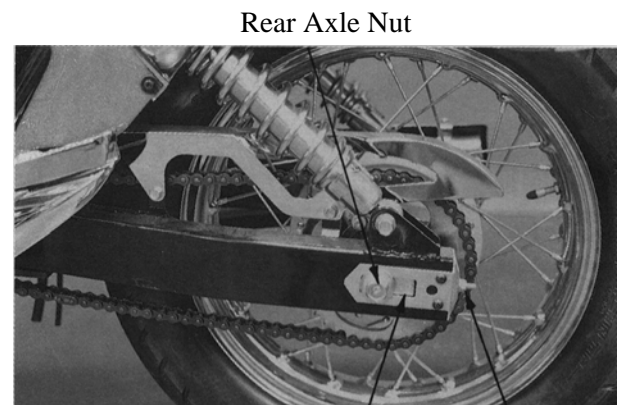

Rear Axle Nut

Punch Mark

Adjusting Nut

2. INSPECTION/ADJUSTMENT

BRAKE SHOE

Inspect the front brake linings for wear.

BRAKE LEVER/PEDAL

Measure the front brake lever free play.

Free Play: 10~20mm

Measure the rear brake pedal free play.

Free Play: 10~20mm

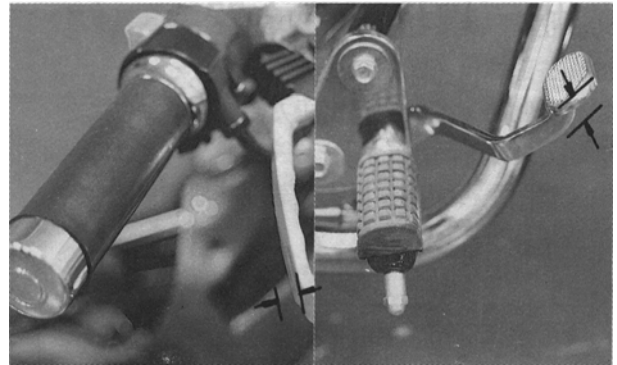

CLUTCH

Measure the clutch lever free play.

Free Play: 10~20mm

When minor adjustment is required, adjust by turning the adjusting nut on the clutch lever side.

When major adjustment is required, adjust by turning the adjusting nut on the clutch cable from the right crankcase cover.

Adjust by loosening the lock nut and turning the adjusting nut. After adjustment, tighten the lock nut.

Adjusting Nut Lock Nut

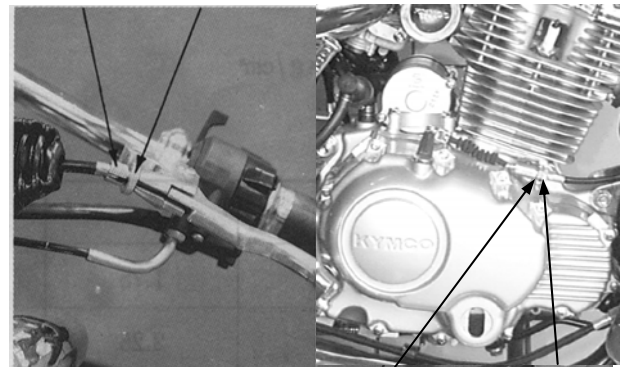

Adjusting Nut Lock Nut

BRAKE FLUID

Turn the steering handlebar upright and check if the brake fluid level is between the upper and lower limits.

Specified Brake Fluid: DOT-3

Lower Limit

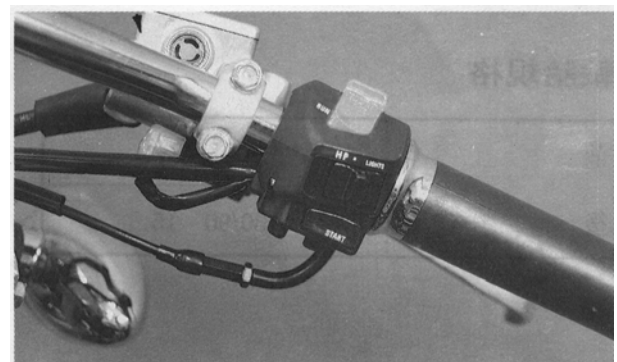

2. INSPECTION/ADJUSTMENT

SUSPENSION

FRONT

Fully apply the front brake lever and check the action of the front shock absorbers by compressing them several times.

Check the entire shock absorber assembly for oil leaks, looseness or damage.

REAR

Check the action of the rear shock absorber by compressing it several times.

Check the entire shock absorber assembly for oil leaks, looseness or damage.

Jack the rear wheel off the ground and move the rear wheel sideways with force to see if the engine hanger bushings are worn.

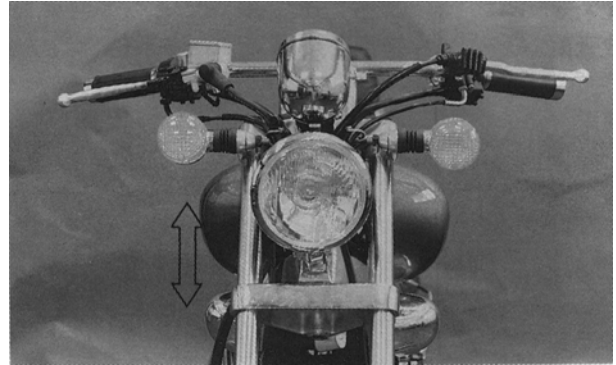

NUTS/BOLTS/FASTENERS

Check all important chassis nuts and bolts for looseness.

Tighten them to their specified torque values if any looseness is found.



WHEELS/TIRES

Check the tires for cuts, imbedded objects or other damages.

Check the tire pressure.

* Tire pressure should be checked when tires are cold.

TIRE PRESSURE

	1 Rider	2 Riders
Front	1.75kg/cm ²	1.75kg/cm ²
Rear	2.00kg/cm ²	2.25kg/cm ²

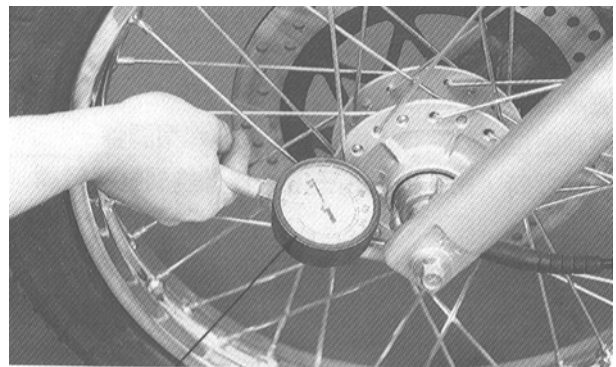

Tire Pressure Gauge

TIRE SIZE

Front	3.00-18
Rear	130/90-15

2. INSPECTION/ADJUSTMENT

Check the front and rear axle nuts for looseness.
If the axle nuts are loose, tighten them to the specified torques.

Torques: Front : 5.5~7.0kg-m

Rear : 6.0~8.0kg-m

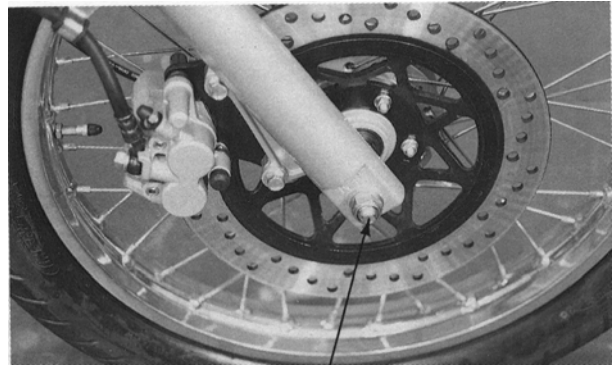

Front Axle Nut

STEERING HANDLEBAR

Check that the control cables do not interfere with handlebar rotation.

Raise the front wheel off the ground and check that the steering handlebar rotates freely.

If the handlebar moves unevenly, binds, or has vertical movement, adjust the steering head bearing.



3. LUBRICATION SYSTEM

LUBRICATION SYSTEM

3

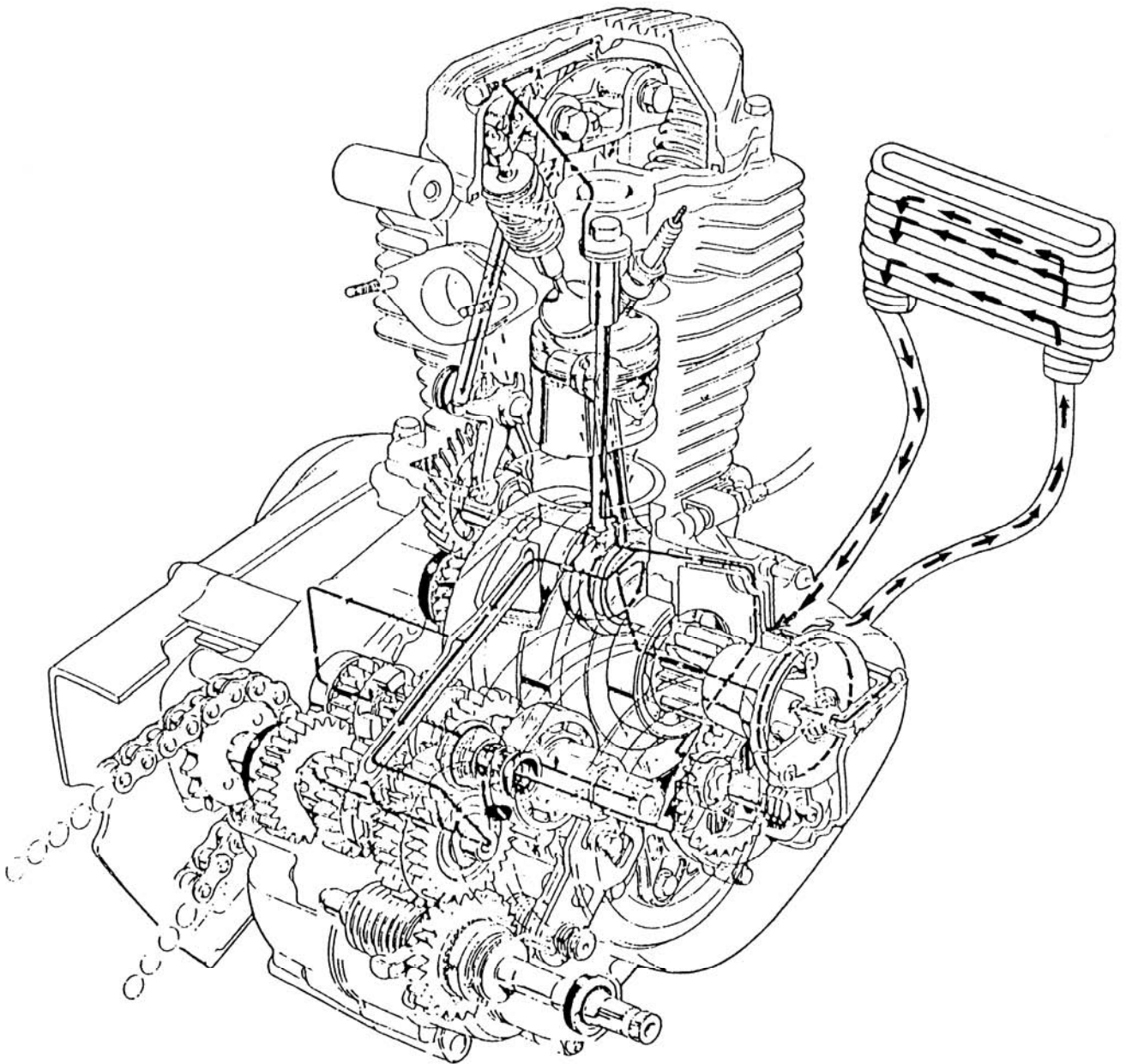

3. LUBRICATION SYSTEM

SERVICE INFORMATION..... 3-1	OIL PUMP/OIL FILTER ROTOR 3-3
TROUBLESHOOTING..... 3-1	OIL COOLER REMOVAL/INSTALLATION... 3-5
ENGINE OIL/OIL FILTER SCREEN..... 3-2	

SERVICE INFORMATION

GENERAL INSTRUCTIONS

- The service and maintenance of this section can be performed with the engine installed in the frame.
- Use care when removing and installing the oil pump not to allow dust and foreign matters to enter the engine and oil line.
- The oil pump must be replaced as a set when it reaches its service life.
- After the oil pump is installed, check each part for oil leaks and improper lubrication.
- When removing and installing the oil cooler, be careful not to bend or deform the oil pipe.

SPECIFICATIONS

Item		Standard (mm)	Service Limit (mm)
Oil pump	Inner rotor-to-outer rotor clearance	—	0.20
	Outer rotor-to-pump body clearance	—	0.20
	Rotor end-to-pump body clearance	0.015~0.10	0.15

Item	Oil Capacity	Oil Pipe Capacity
Oil Cooler	53 cc	7 cc

TROUBLESHOOTING

Oil level too low

- Natural oil consumption
- Oil leaks
- Worn or poorly installed piston rings
- Worn valve guide or seal
- Clogged oil cooler
- Clogged or leaky oil pipe

Engine burns

- Low or no lubrication pressure
- Clogged oil passages
- Not use the specified oil
- Faulty oil cooler
- Clogged oil cooler
- Clogged or leaky oil pipe

3. LUBRICATION SYSTEM

ENGINE OIL/OIL FILTER

OIL LEVEL

- * Place the motorcycle upright on level ground for engine oil level check.
- * Run the engine for 2~3 minutes and check the oil level after the engine is stopped for 2~3 minutes.

Check the oil level through the watch window. If the level is near the lower limit, fill to the upper limit with the specified engine oil.

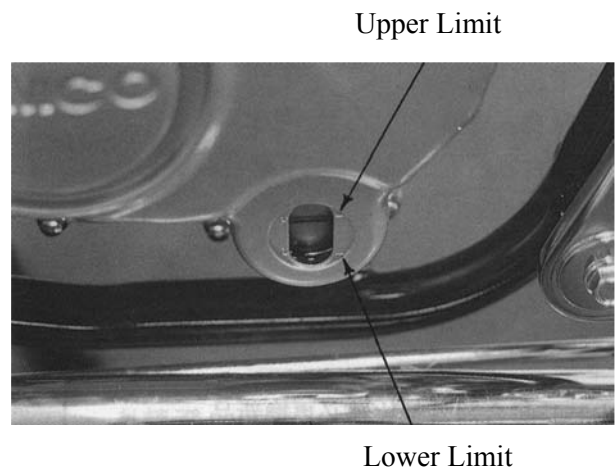

OIL CHANGE

- * The engine oil will drain more easily while the engine is warm.

Remove the drain bolt to drain the engine oil thoroughly.

Check the drain bolt washer for damage or deformation and replace with a new one if necessary.

Remove the oil filter screen cap and then remove the oil filter screen and spring. Clean the oil filter screen with compressed air.

Check the filter screen cap O-ring for damage or deformation and replace if necessary.

Install the oil filter screen, spring and filter screen cap.

Torque: 1.5kg-m

- * Do not install the oil filter screen upside down.

Oil Capacity: At disassembly : 1.1 liter

At change : 1.0 liter

Check for oil leaks and then start the engine and let it idle for few minutes.

Stop the engine and recheck the oil level.

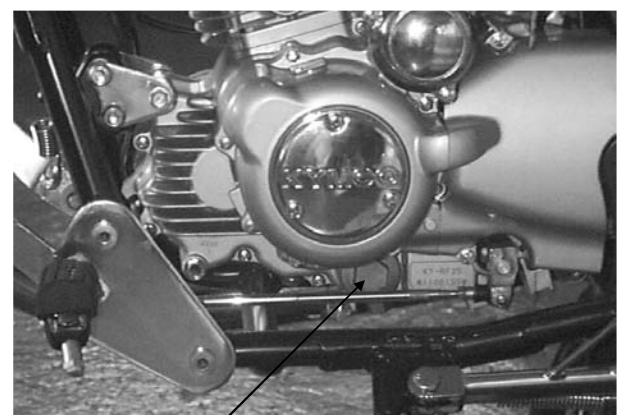
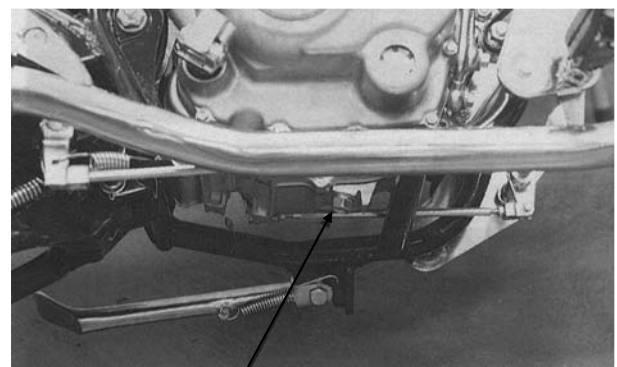

3. LUBRICATION SYSTEM

OIL PUMP/OIL FILTER ROTOR

REMOVAL

1. Remove the kick lever.
2. Disconnect the clutch cable.
3. Remove the right crankcase cover bolts and right crankcase cover.
4. Check the cover gasket, oil seal and O-ring for oil leaks or damage. Replace with new ones if necessary.

* When installing, make sure to use a new right crankcase cover gasket.

Remove the three screws attaching the oil filter rotor cover to remove the cover. Remove the oil filter rotor lock nut with a square socket and then remove the washer and oil filter rotor.

* During installation, install the washer with the mark "OUTSIDE" facing up.

Remove the oil pump gear cover. Remove the 6mm nut on top of the oil pump driven gear. Remove the oil pump driven gear and chain. Remove the two oil pump mounting bolts. Remove the oil pump body.

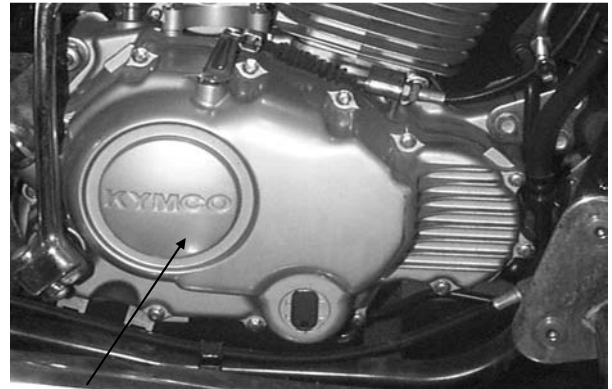

Right Crankcase Cover

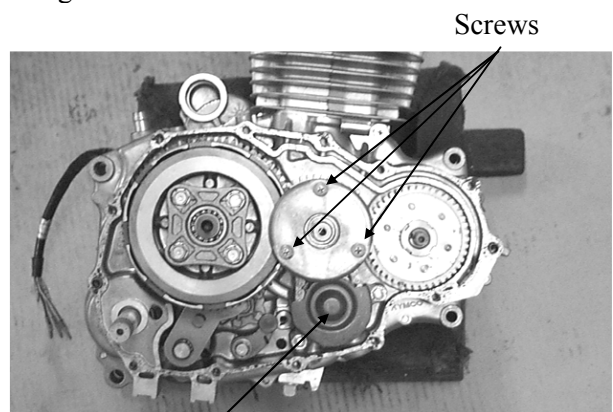

Oil Pump

Oil Filter Rotor

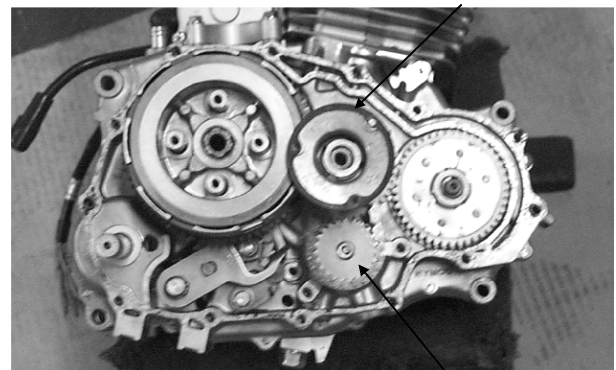

Oil Pump Driven Gear

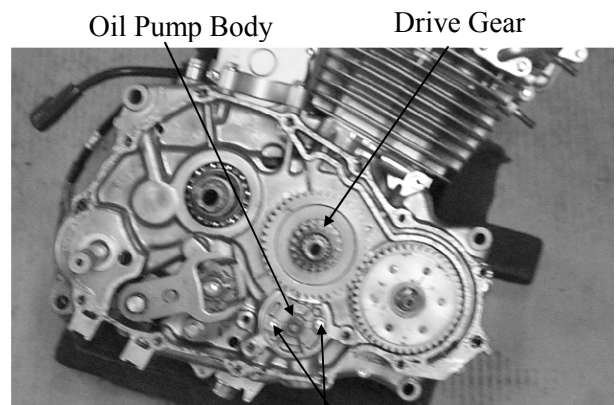

Oil Pump Body

Drive Gear

Bolts

3. LUBRICATION SYSTEM

DISASSEMBLY

Remove the pump cover attaching screw.

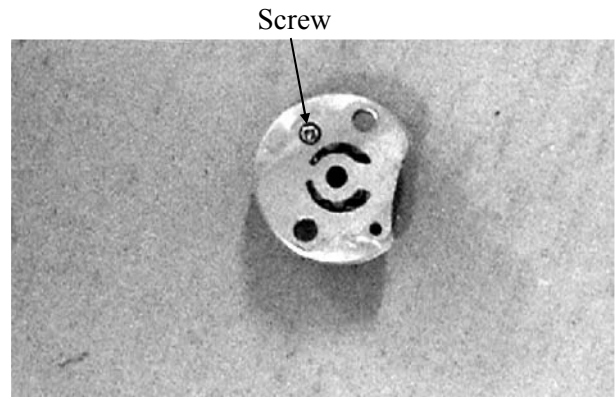

INSPECTION

Measure the pump body-to-outer rotor clearance.

Service Limit: 0.20mm

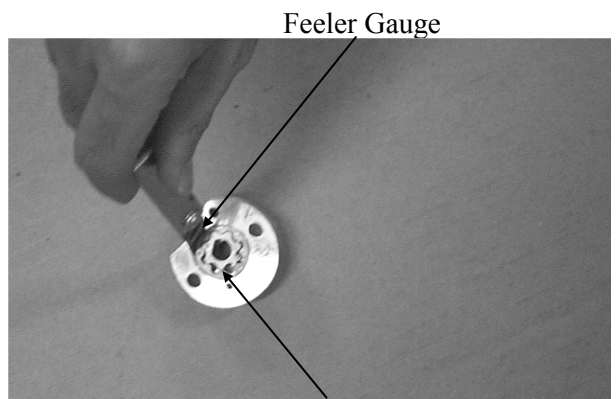

Measure the inner rotor-to-outer rotor clearance.

Service Limit: 0.20mm

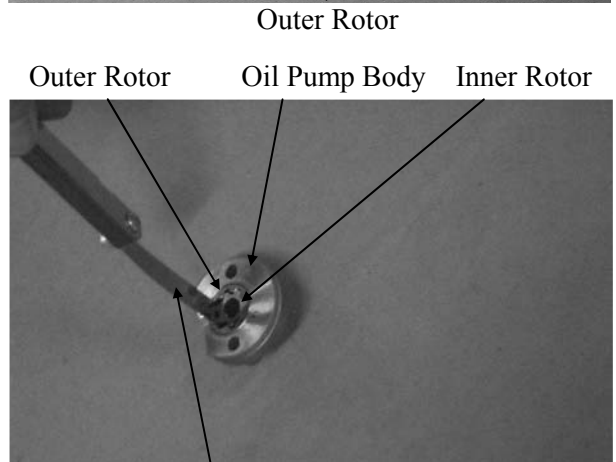

Measure the rotor end-to-pump body clearance.

Service Limit: 0.15mm

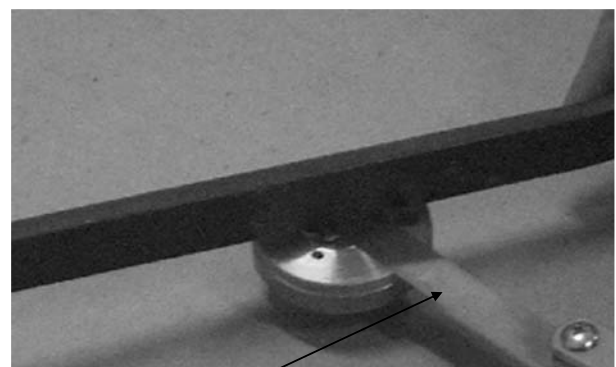

3. LUBRICATION SYSTEM

ASSEMBLY

Install the outer rotor and inner rotor into the pump body. Insert the pump shaft.

- * Insert the pump shaft by aligning the flat on the shaft with the flat in the inner rotor.

Install the gasket and pump cover.
Tighten the screw.
After installation, make sure that the pump shaft rotates freely.

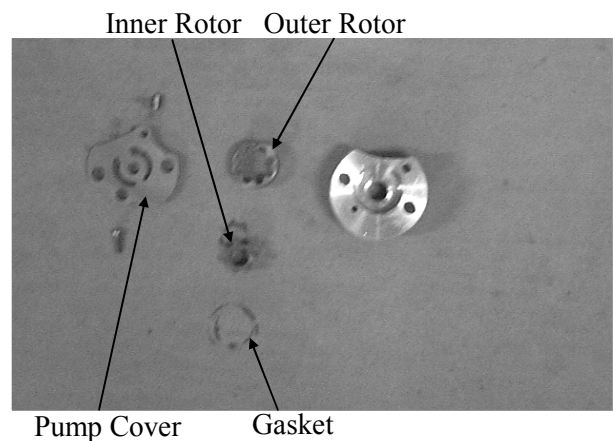

INSTALLATION

Install the pump body and tighten the two mounting bolts.
Install the oil pump driven gear and chain.
Tighten the 6mm nut on top of the oil pump driven gear.
Install the oil pump gear cover and tighten the two bolts.

Torque: 4.0~5.0kg-m

- * During installation, install the washer with the mark "OUTSIDE" facing up.

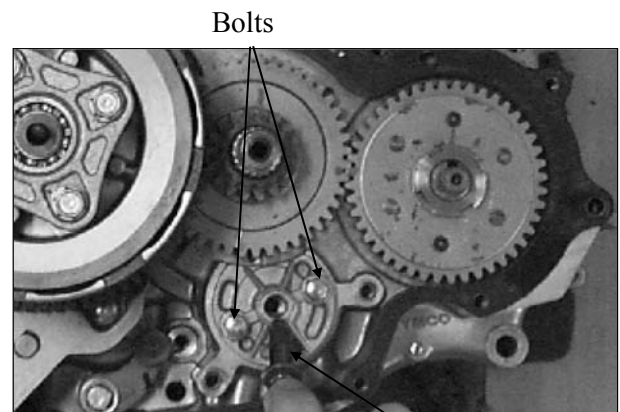

Pump Gear Cover

Install the right crankcase cover.

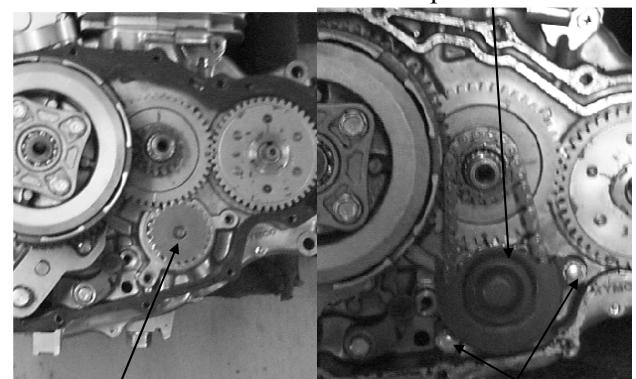

OIL PUMP/OIL FILTER ROTOR

Remove the two oil cooler protective cover mounting bolts and remove the protective cover.

Remove the two inlet pipe bolts and two outlet pipe bolts.

Remove the two oil cooler attaching bolts and oil cooler.

Check the oil cooler for damage or oil leaks.

Installation

Install the oil cooler in the reverse order of removal.

- * The engine oil temperature is very high. This operation must be done when the engine is cold to avoid burns.

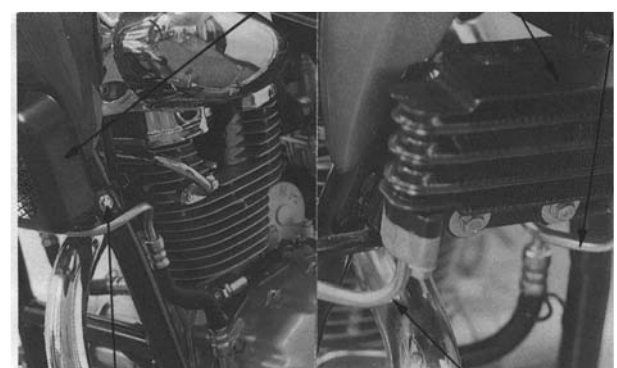

4. FUEL SYSTEM

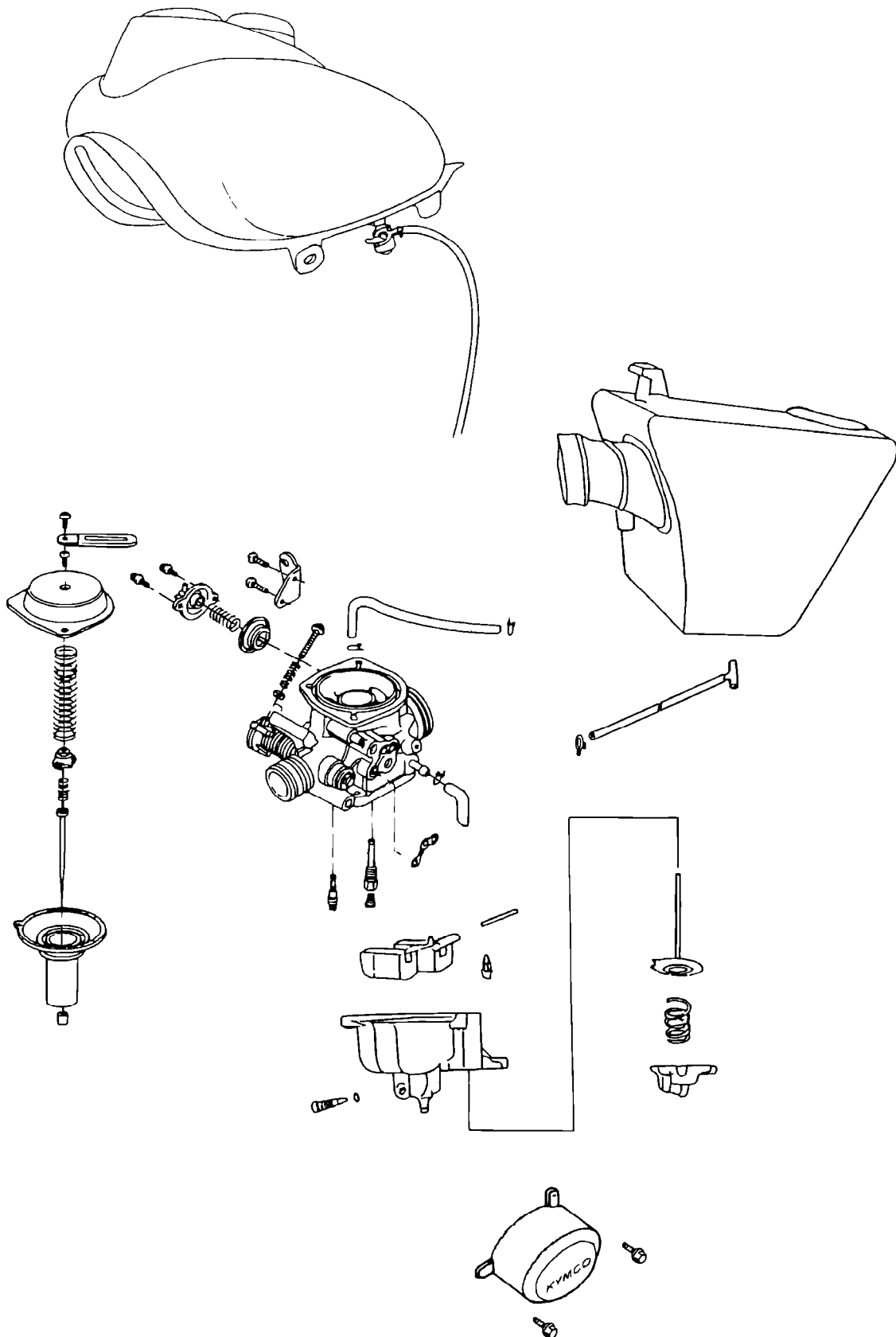

4

4. FUEL SYSTEM

SERVICE INFORMATION	4-1	CARBURETOR INSTALLATION	4- 8
TROUBLESHOOTING	4-2	THROTTLE VALVE ASSEMBLY	4- 8
THROTTLE VALVE DISASSEMBLY	4-3	AIR CUT-OFF VALVE	4- 9
CARBURETOR REMOVAL	4-3	FUEL TANK	4-10
FLOAT/FLOAT VALVE/JETS/ ACCELERATING PUMP	4-4	AIR CLEANER REMOVAL	4-11
FLOAT LEVEL INSPECTION	4-7		

SERVICE INFORMATION

GENERAL INSTRUCTIONS



Gasoline is very dangerous. When working with gasoline, keep sparks and flames away from the working area.
Gasoline is extremely flammable and is explosive under certain conditions. Be sure to work in a well-ventilated area.

- Do not bend or twist control cables. Damaged control cables will not operate smoothly.
- When disassembling fuel system parts, note the locations of O-rings. Replace them with new ones during reassembly.
- Before float chamber disassembly, loosen the drain screw to drain the residual gasoline into a clean container.
- After the carburetor is removed, plug the intake manifold side with a clean shop towel to prevent foreign matters from entering.
- The carburetor air jets and fuel jets must be cleaned with compressed air.
- When the motorcycle is not used for over one month, drain the residual gasoline from the float chamber to avoid erratic idling and clogged slow jet due to deteriorated fuel.

SPECIFICATIONS

Item	Standard
Venturi dia.	φ25
Identification number	CVK003
Float level	17 mm
Main jet	110#
Slow jet	35#
Idle speed	1600±100rpm
Throttle grip free play	2~6mm
Pilot screw opening	2±½

SPECIAL TOOL

Float level gauge

4. FUEL SYSTEM

TROUBLESHOOTING

Engine cranks but won't start

- No fuel in tank
- No fuel to carburetor
- Cylinder flooded with fuel
- No spark at plug
- Clogged air cleaner
- Intake air leak
- Improper throttle operation

Engine idles roughly, stalls or runs poorly

- Excessively used choke
- Ignition malfunction
- Faulty carburetor
- Poor quality fuel
- Lean or rich mixture
- Clogged air cleaner
- Incorrect idle speed
- Faulty charcoal canister

Misfiring during acceleration

- Faulty ignition system
- Faulty carburetor
- Faulty accelerating pump
- Faulty charcoal canister

Backfiring at deceleration

- Float level too low
- Incorrectly adjusted carburetor
- Faulty A.C.V.
- Faulty exhaust muffler
- Faulty A.I.C.V.

Engine lacks power

- Clogged air cleaner
- Faulty carburetor
- Faulty ignition system

Lean mixture

- Clogged carburetor fuel jets
- Float level too low
- Intake air leak
- Faulty charcoal canister
- Restricted fuel line

Rich mixture

- Float level too low
- Clogged air jets
- Clogged air cleaner
- Restricted A.C.V. tube
- Worn throttle needle

4. FUEL SYSTEM

THROTTLE VALVE DISASSEMBLY

Remove the right side cover.
Remove the carburetor cap.
Pull out the throttle valve.

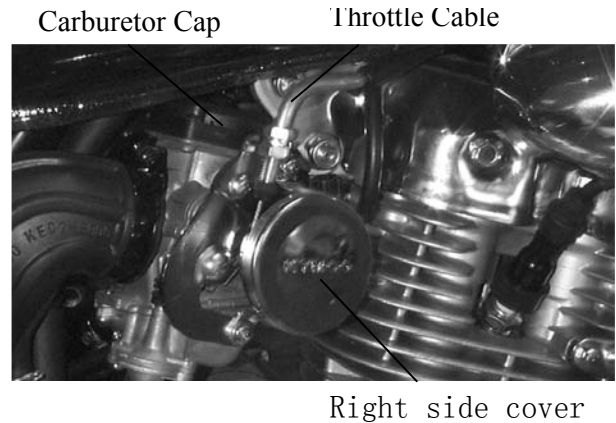

Disconnect the throttle valve and remove the spring from the carburetor cap.

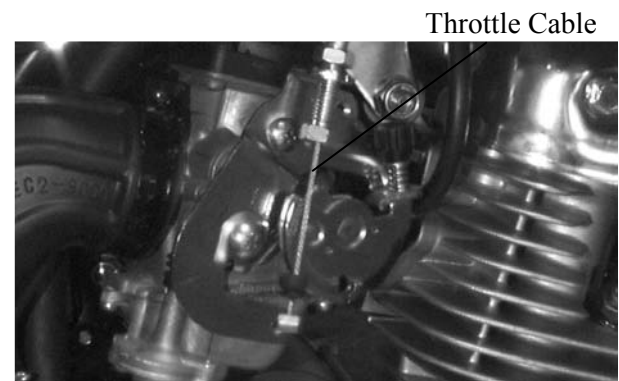

Pry off the needle retainer and remove the jet needle.
Check the throttle valve and jet needle for wear or damage.

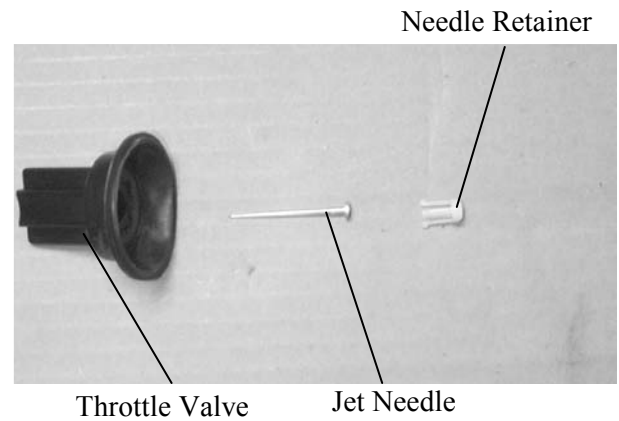

CARBURETOR REMOVAL

Loosen the drain screw to drain the gasoline from the float chamber.

- *

<ul style="list-style-type: none">• Keep sparks and flames away from the work area.• Drain gasoline into a clean container.
--

Disconnect the fuel inlet tube and air cut-off valve (A.C.V.) tubes.

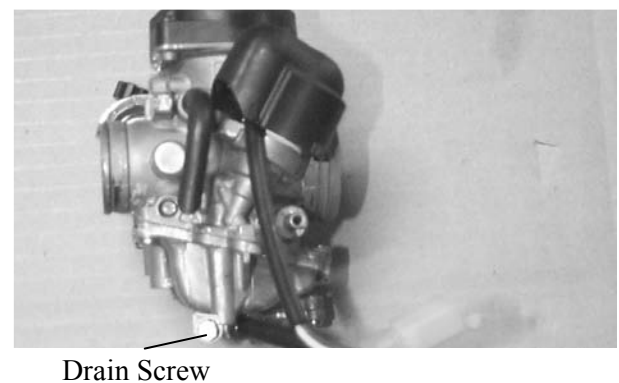

4. FUEL SYSTEM

Loosen the air cleaner connector band screw.
Remove the two carburetor lock nuts.
Remove the carburetor



Screw

Lock Nut

CARBURETOR DISASSEMBLY FLOAT/FLOAT VALVE/JETS/ ACCELERATING PUMP

Float/Float Valve Disassembly

Remove the three float chamber attaching screws and remove the float chamber.

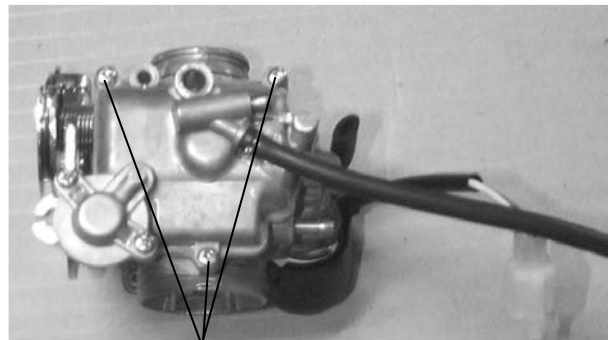

Screws

Remove the float pin, float and float valve.

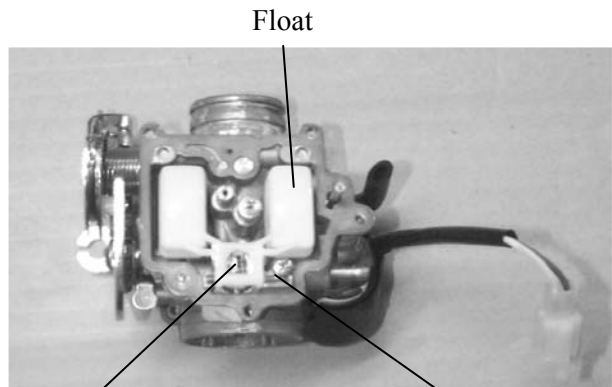

Float

Float Valve

Float Pin

Float/Float Valve Inspection

Inspect the float valve seat for wear or damage.

Inspect the float for damage or fuel level inside the float chamber.

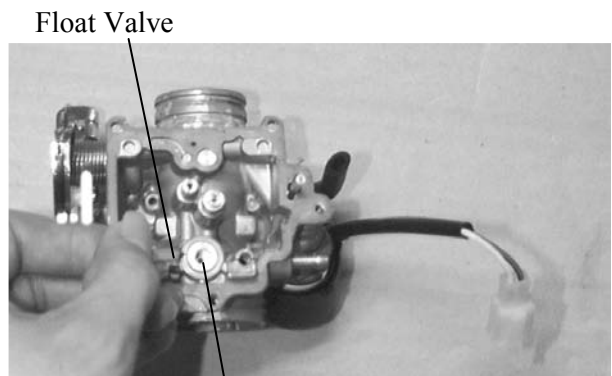

Float Valve

Float Valve Seat

4. FUEL SYSTEM

Main Jet/Jets/Pilot Screw/Throttle Stop Screw Removal

Remove the main jet, needle jet holder, and needle jet.

Remove the slow jet.

Remove the pilot screw and throttle stop screw.

Throttle Stop Screw

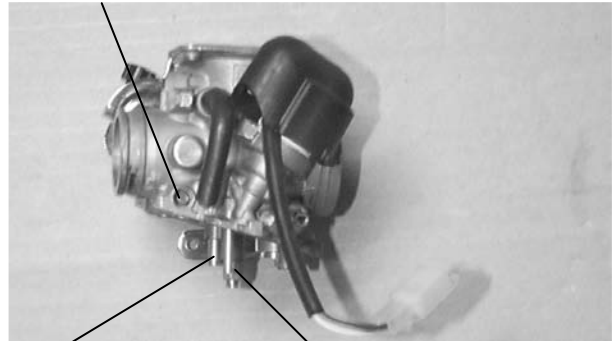

Slow Jet

Main Jet

CAUTIONS !

*

- Be careful not to damage the jets and jet holder when removing them.
- Before removing, turn the throttle stop screw and pilot screw in and carefully count the number of turns until they seat lightly and then make a note of this.
- Do not force the screw against its seat to avoid seat damage.
- Be sure to install the O-ring in the reverse order of removal.

Throttle Stop Screw

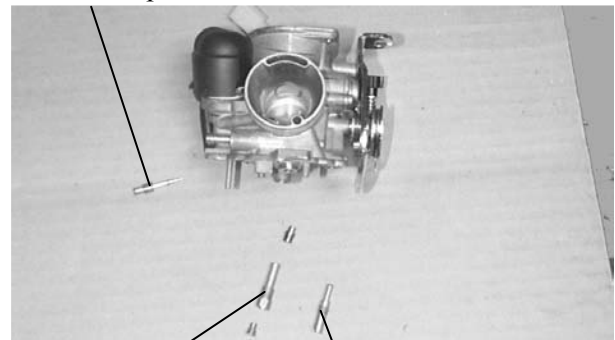

Main Jet

Slow Jet

Accelerating Pump Removal

Remove the three accelerating pump cover screws and accelerating pump cover.

Remove the spring and accelerating pump diaphragm.

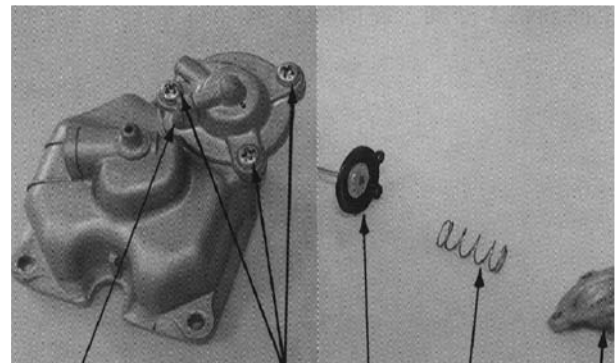

Accelerating Pump Cover

Screws

Diaphragm

Spring

Accelerating Pump Cover

Inspection

Inspect the accelerating pump diaphragm for cracks, damage or deterioration. Replace with a new one if necessary.

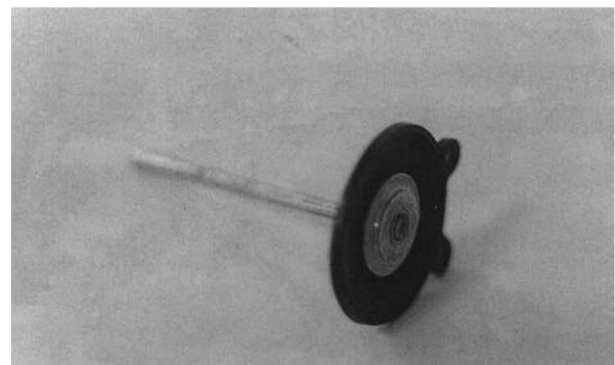

4. FUEL SYSTEM

Accelerating Pump Check Valve Removal Fuel Inlet Ball Check Valve Removal

Remove the check valve nut.
Take out the spring and steel ball.

* When removing, be careful not to drop the tiny spring.

Inlet Hole Inlet Ball Check Valve Steel Ball

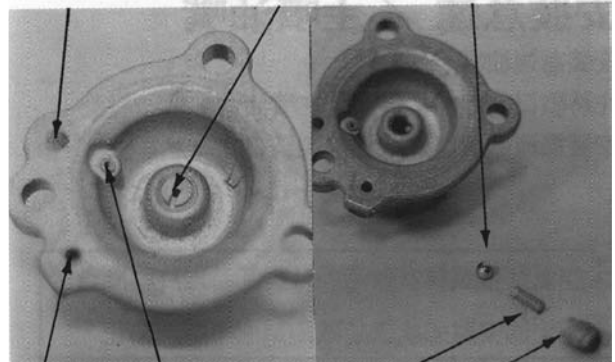

Outlet Hole Bypass Hole Spring Nut

Fuel Outlet Ball Check Valve Removal

Remove the O-ring.
Remove the check valve nut.
Take out the spring and steel ball.

Inspection

Inspect the check valve steel balls for rust and springs for damage.
Replace with new ones if necessary.

Outlet Ball Check Valve O-ring

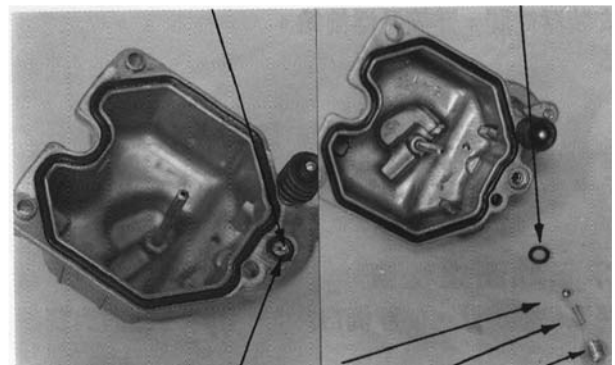

O-ring Steel Ball Spring Nut

Carburetor Cleaning

Blow compressed air through all passages of the carburetor body.

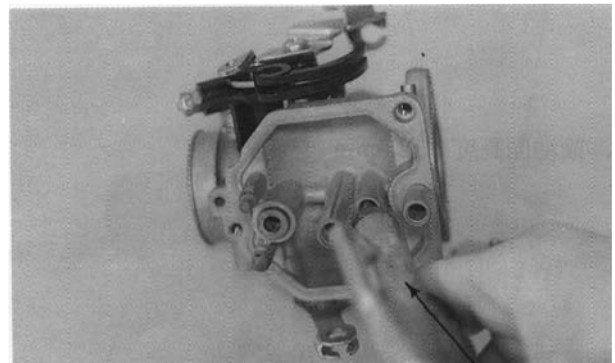

Compressed Air

4. FUEL SYSTEM

Slow Jet/Main Jet Installation

Install the slow jet.

Install the needle jet, needle jet holder and main jet.

Install the throttle stop screw and pilot screw.

- * When installing the pilot screw, return it to the original position as noted during removal
- * After the carburetor is installed, be sure to perform the Exhaust Emission Test.

Install the float valve, float and float pin.

Throttle Stop Screw

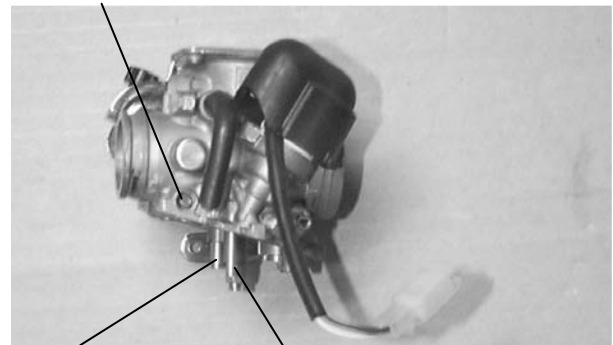

Slow Jet

Main Jet

Float

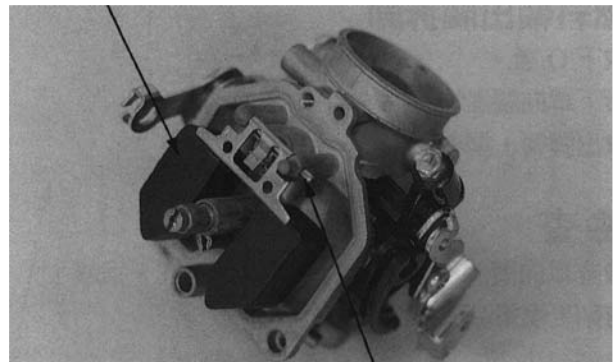

Float Pin

FLOAT LEVEL INSPECTION

Turn the carburetor upside down so that the float will go down to make the float valve contact the float valve seat.

Then slowly tilt the carburetor and measure the float level with the float level gauge while the float pin just contacts with float valve.

Float Level: 17mm

When adjusting, carefully bend the float pin. Check the float for proper operation and then install the float chamber.

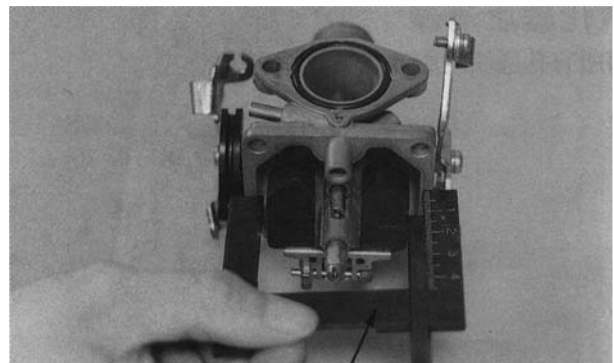

Float Level Gauge

4. FUEL SYSTEM

Accelerating Pump Installation

First install the accelerating pump diaphragm.

Install the spring.

Install the accelerating pump cover and tighten the three screws.

* When installing the diaphragm, be sure to position it correctly.

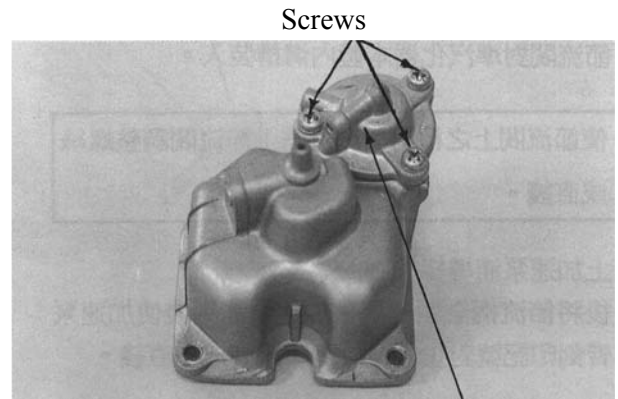

Accelerating Pump Cover

CARBURETOR INSTALLATION

Install the carburetor onto the intake manifold and tighten the two lock nuts.

Torque: 0.8~1.2kg-m

Install the air cleaner connector and tighten the band screw.

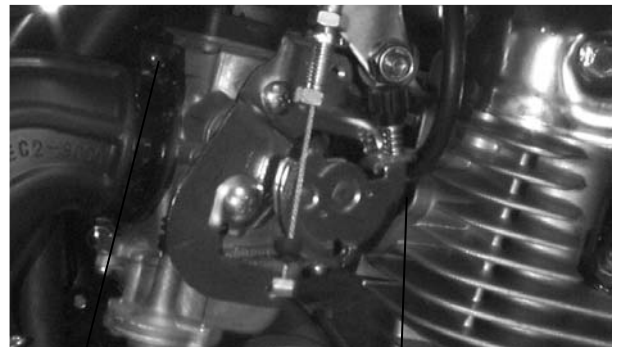

Band Screw

Lock Nut

THROTTLE VALVE ASSEMBLY

Install the jet needle into the throttle valve and secure with the needle retainer.

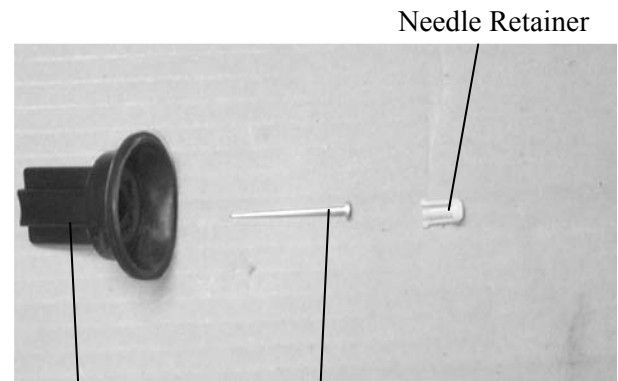

Throttle Valve

Jet Needle

Assemble the rubber cover, carburetor cap and throttle valve spring.
Connect the throttle cable to the throttle valve.

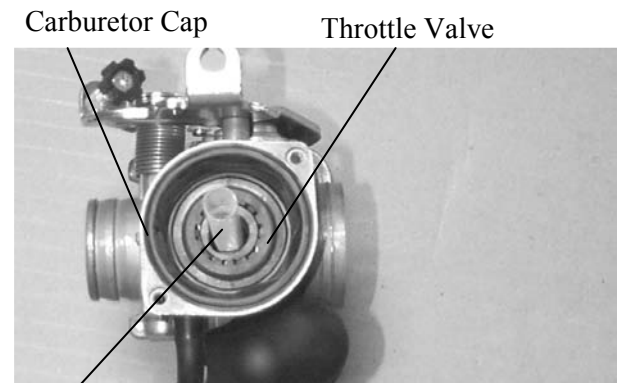

Carburetor Cap

Throttle Valve

Spring

4. FUEL SYSTEM

Install the throttle valve into the carburetor body.

- *

Align the groove in the throttle valve with the throttle stop screw on the carburetor body.

Connect the throttle cable.

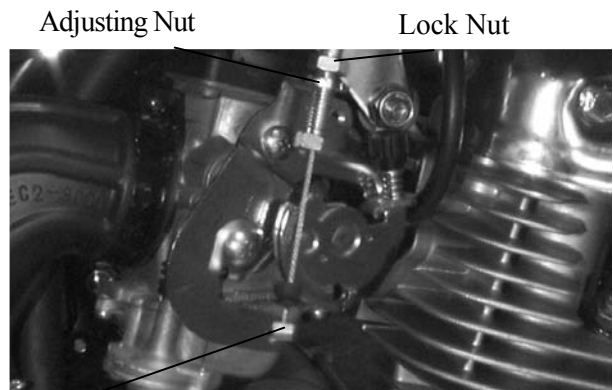

Throttle Cable

Tighten the carburetor cap.
Inspect the throttle grip free play and adjust if necessary.

Throttle Grip Free Play: 2~6mm

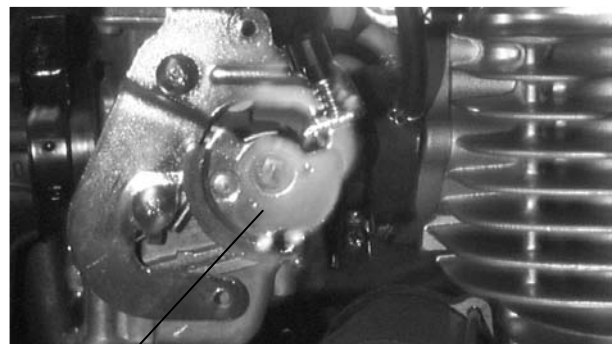

Accelerating Pump Arm

AIR CUT-OFF VALVE (A.C.V.)

REMOVAL

Disconnect the tubes that go to the air cut-off valve.

Remove the two attaching screws.

Remove the air cut-off valve.

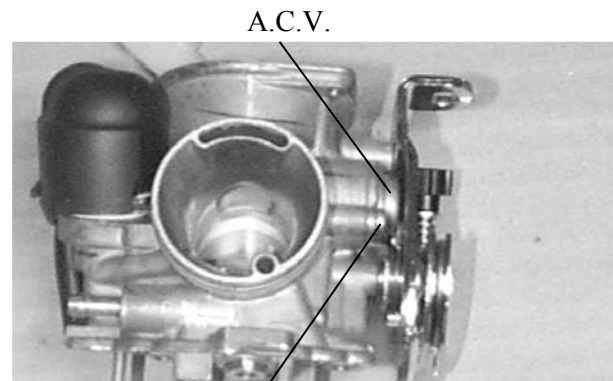

Screws

DISASSEMBLY

Remove the two attaching screws to remove the air cut-off valve cover.

Remove the spring and diaphragm.

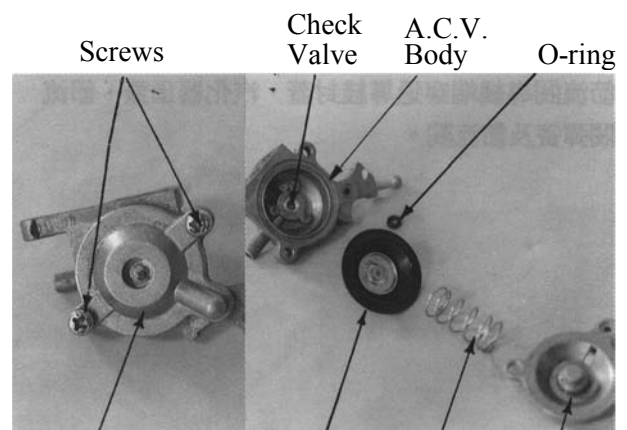

4. FUEL SYSTEM

INSPECTION

Inspect the check valve for proper operation.
Inspect the air cut-off valve diaphragm and O-ring for deterioration or damage.
Replace with new ones if necessary.
Clean each air passage with compressed air.

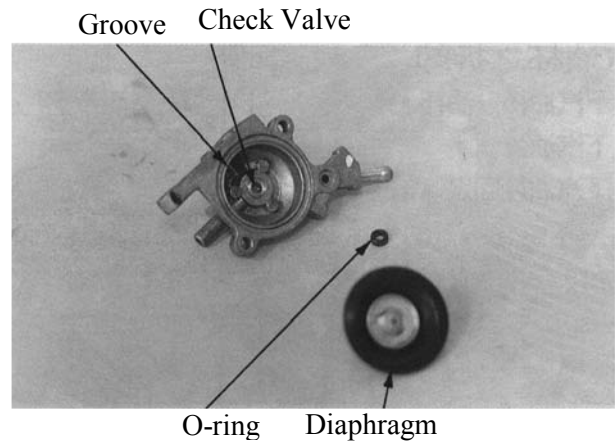

INSTALLATION

First install the diaphragm and O-ring onto the air cut-off valve body and then install the spring and cover. Tighten the screws.

Torque: 0.3~0.4kg-m

- * Install the diaphragm by aligning it with the groove on the air cut-off valve to avoid damage and air leaks.

Connect the tubes that go to the air cut-off valve.

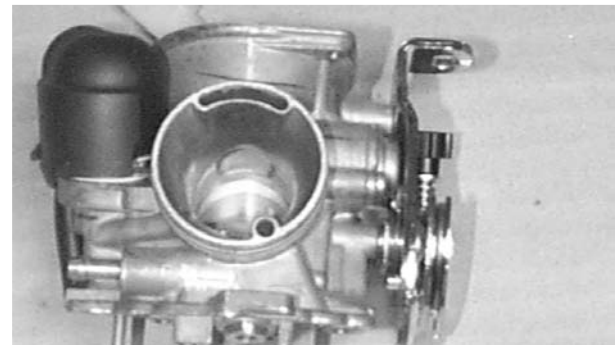

FUEL TANK

FUEL TANK REMOVAL

Warning

- Keep sparks and flames away from the work area.
- Wipe off any spilled gasoline.

Remove the right and left side covers and the right and left decorative covers under the fuel tank.

Remove the four bolts attaching the rear carrier.

Remove the two seat lock bolts.

Remove the auto fuel valve.

Disconnect the fuel tube and remove the bolt on the end of the fuel tank.

Disconnect the fuel unit wire connector and fuel gauge wire.

Remove the fuel tank.

FUEL TANK INSTALLATION

Install the fuel tank in the reverse order of removal.

Check that there is no fuel leakage.

Check the wire connectors for proper connection.

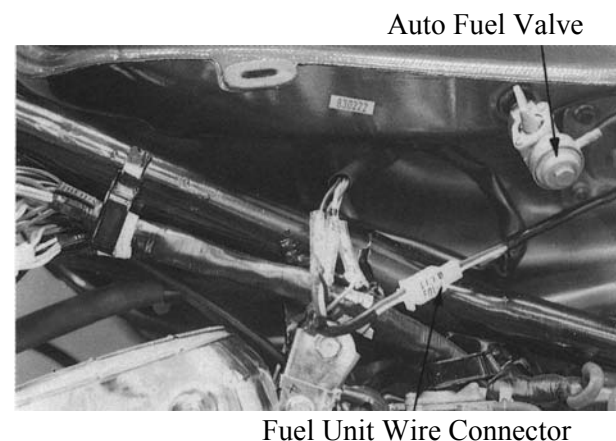
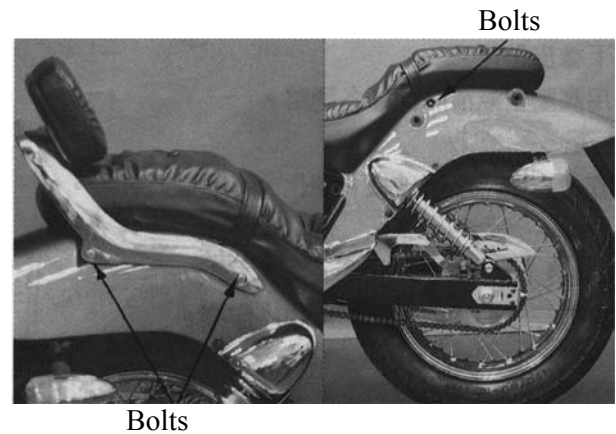

4. FUEL SYSTEM

AIR CLEANER REMOVAL

- Remove the right side cover.
- Remove the two bolts attaching the emission control system.
- Remove the rear carrier. (Refer to 4-10.)
- Remove the seat. (Refer to 4-10.)
- Remove the two air cleaner case attaching bolts.
- Remove the air cleaner and carburetor connecting tube band.
- Remove the air cleaner from the right side.

Bolts

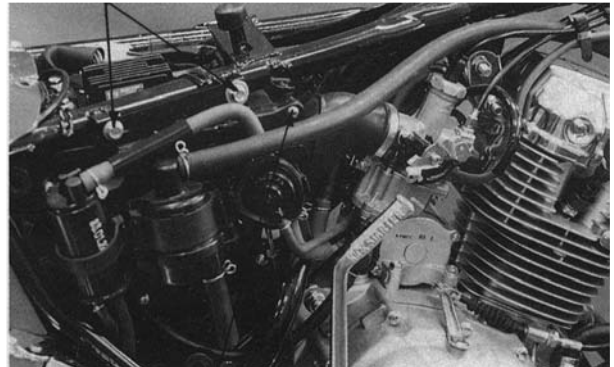

Screw

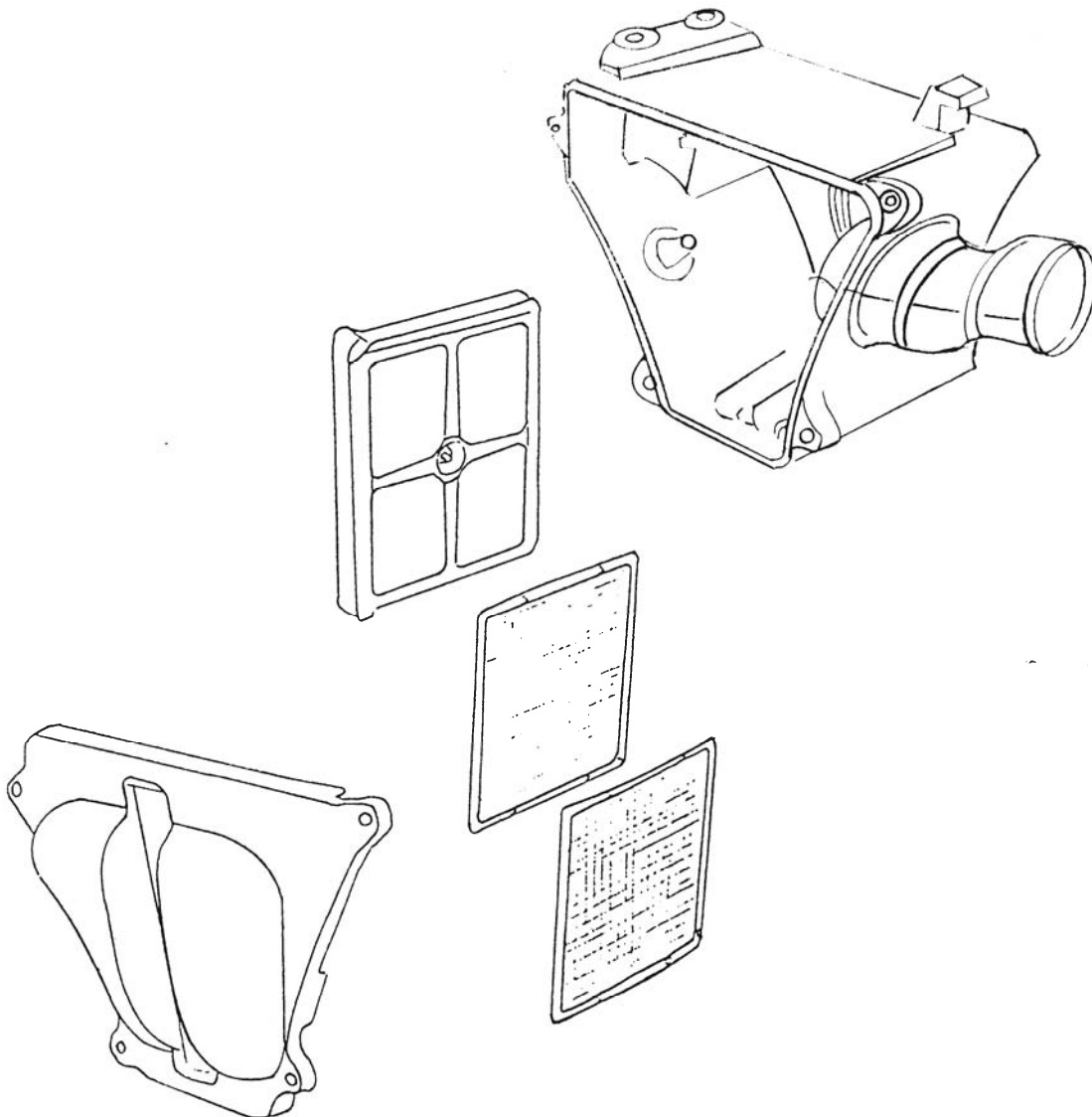

5. ENGINE REMOVAL/INSTALLATION

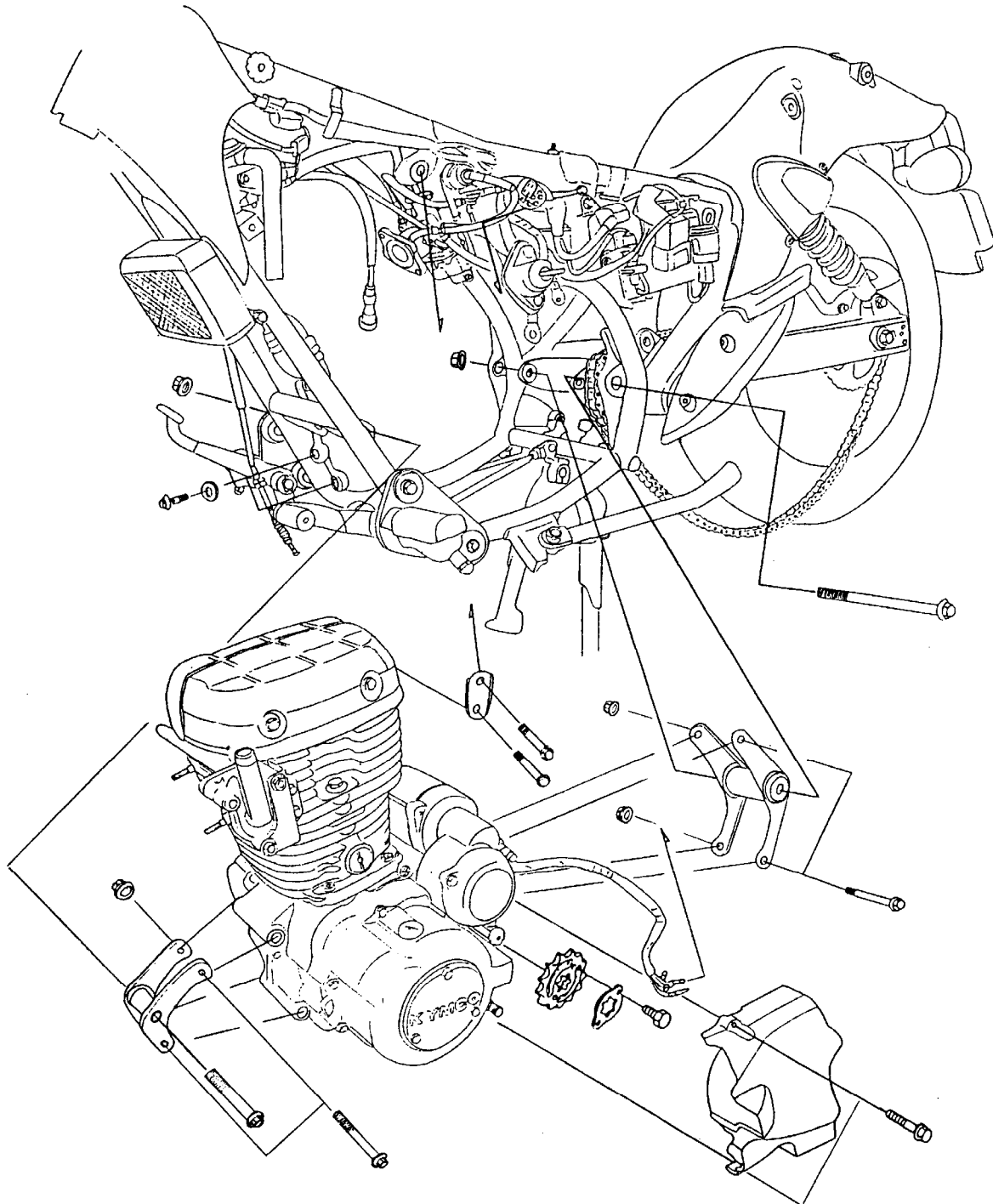

5

5. ENGINE REMOVAL/INSTALLATION

SERVICE INFORMATION	5-1
ENGINE REMOVAL	5-2
ENGINE INSTALLATION	5-3

SERVICE INFORMATION

GENERAL INSTRUCTIONS

- A engine stand or floor jack is required to support and maneuver the engine.
- The following parts can be serviced with the engine installed in the frame:
 - Cylinder head/valves (Section 6)
 - Cylinder/piston (Section 7)
 - Starter motor/generator/left crankcase cover/starter clutch/camshaft (Section 8)
 - Clutch/gear shift mechanism (Section 9)
- When removing and installing the engine, do not use a hammer or screw driver to strike or pry the engine.
- Do not damage the crankcase mating surfaces and clean off all gasket materials from the mating surfaces.
- After crankcase assembly, check that the transmission system operates smoothly.
- After engine installation, start the engine and check that the lubrication system is normal.

Engine oil capacity:

At disassembly : 1.1 liter

At change : 1.0 liter

TORQUE VALUES

Engine bracket bolt	2.0~2.5kg-m
Drive gear lock bolt	0.8~1.2kg-m
Exhaust muffler hanger lock bolt	2.4~3.0kg-m
Rear fork pivot nut	5.5~6.5kg-m
Exhaust muffler joint lock nut	0.8~1.2kg-m

5. ENGINE REMOVAL/INSTALLATION

ENGINE REMOVAL

Remove the right and left decorative covers under the fuel tank.
Remove the carburetor. (Refer to 4-3.)
Disconnect the clutch cable.
Disconnect the oil cooler oil pipes.
Remove the crankcase breather.
Disconnect the secondary air reed valve inlet pipe.
Remove the two exhaust muffler joint lock nuts.
Remove the two socket hex bolts attaching the rear foot rests.
Remove the exhaust muffler hanger lock bolt and exhaust muffler.

- *

<ul style="list-style-type: none">• Drain the engine oil before engine removal.• The exhaust muffler temperature is extremely high. Remove it when the engine is cold.

Remove the spark plug cap.

Disconnect the fuel tube from the auto fuel valve.
Disconnect the A.C. generator wire connector.
Remove the starter motor wire.
Remove the two bolts attaching the left rear crankcase cover and remove the rear crankcase cover.
Remove the two bolts attaching the drive gear set plate and the set plate.
Remove the drive gear and chain.
Remove the gear shift lever bolt and gear shift lever.

Remove the three bolts attaching the engine front bracket and the bracket.
Remove the two engine hanger bolts and the hanger.
Remove the two bolts attaching the engine rear bracket.
Remove the rear fork pivot nut and then remove the rear fork pivot and rear bracket.
Remove the engine from left to right.

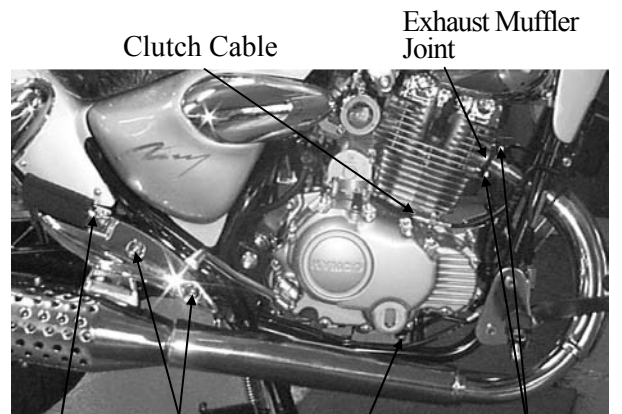

Starter Motor Wire
Generator Wire Connector

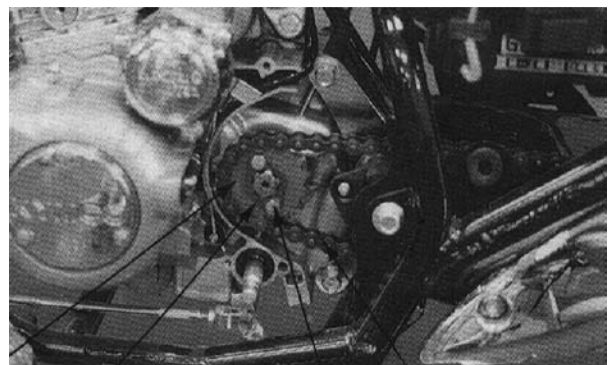

Drive Gear Set Plate Bolt Drive Chain



Rear Fork Pivot Nut Rear Bracket Front Bracket

5. ENGINE REMOVAL/INSTALLATION

ENGINE INSTALLATION

Install the engine in the reverse order of removal. Install the engine to its original position with a jack or other adjustable support.

*

- When installing the engine, do not damage the bolt thread and route the wires and cables properly.
- When installing the engine, be careful to install the oil cooler pipes properly.
- Install the gear shift lever by align the punch mark on the lever with that on the spindle.
- Fill the crankcase to the proper level with recommended engine oil.
- After installation, perform the following inspections and adjustments:
 1. Throttle operation
 2. Clutch lever free play adjustment
 3. Drive chain adjustment

6. CYLINDER HEAD/VALVES

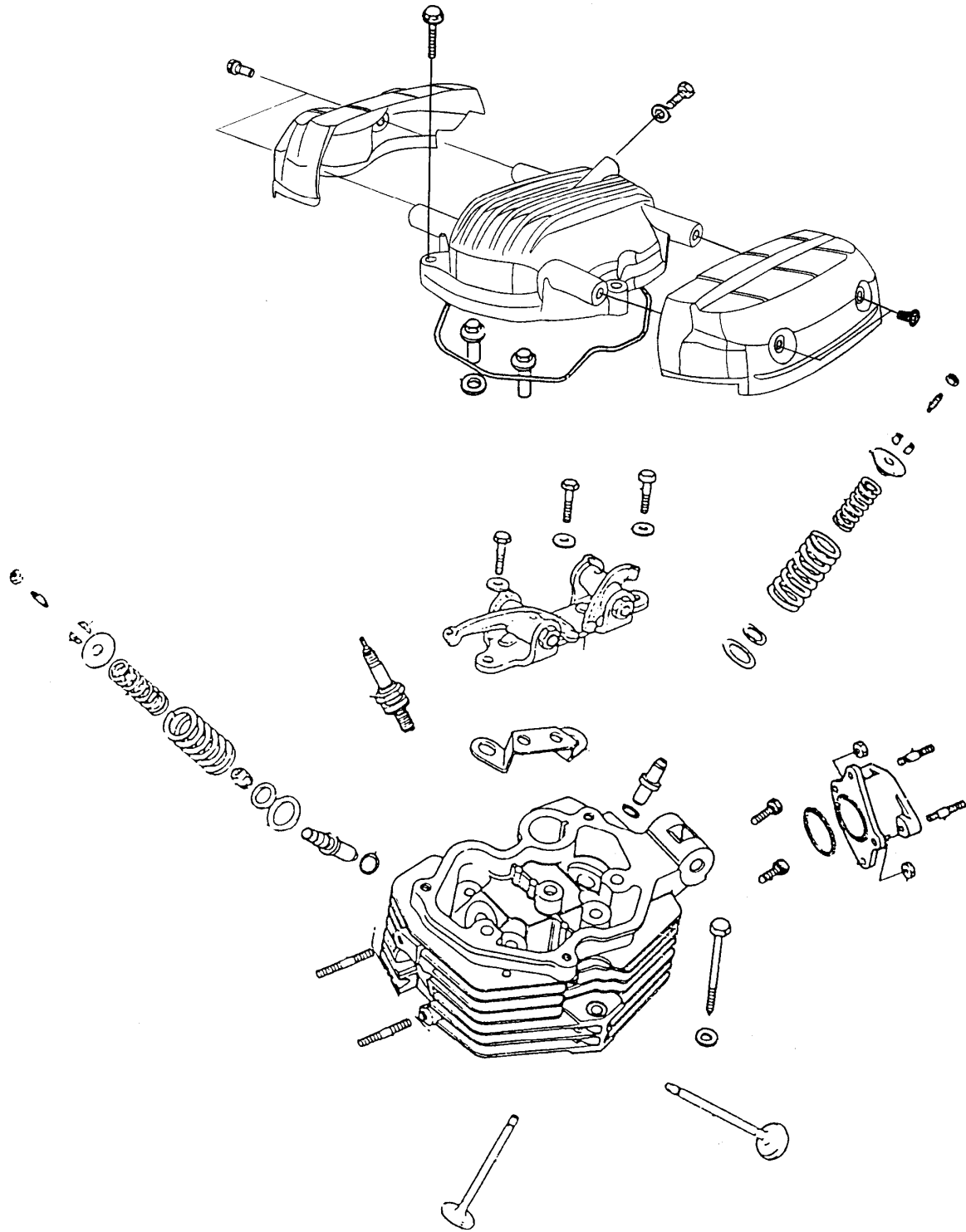

6

6. CYLINDER HEAD/VALVES

SERVICE INFORMATION.....	6-1	VALVE GUIDE REPLACEMENT	6- 6
TROUBLESHOOTING.....	6-3	VALVE SEAT INSPECTION & REFACING	6- 7
ROCKER ARM SET REMOVAL	6-4	CYLINDER HEAD ASSEMBLY	6- 9
CYLINDER HEAD REMOVAL	6-4	CYLINDER HEAD INSTALLATION.....	6-10
CYLINDER HEAD DISASSEMBLY	6-5		

SERVICE INFORMATION

GENERAL INSTRUCTIONS

- The cylinder head can be serviced with the engine installed in the frame.
- When assembling, apply molybdenum disulfide grease or engine oil to the valve guide movable parts, valve arm and camshaft sliding surfaces for initial lubrication.
- The valve rocker arm is lubricated with engine oil through the cylinder head engine oil passages. Clean and unclog the oil passages before cylinder head assembly.
- After disassembly, clean the removed parts and dry them with compressed air before inspection.
- After removal, mark and arrange the removed parts in order. When assembling, install them in the reverse order of removal.

SPECIFICATIONS

Unit: mm

Item		Standard (mm)	Service Limit
Valve clearance (cold)	IN	0.05~0.11	—
	EX	0.05~0.11	—
Cylinder compression pressure kg/cm ²		10~14	8
Cylinder head warpage		0.05	0.1
Rocker arm clearance	IN	0.10~0.025	0.4
	EX	0.10~0.025	0.4
Rocker arm-to-shaft clearance	IN	0.013~0.046	0.126
	EX	0.013~0.046	0.126
Valve seat angle	IN	89°~90°	90°
	EX	89°~90°	90°
Valve stem O.D.	IN	5.30~5.40	5.27
	EX	5.30~5.40	5.27
Valve guide I.D.	IN	5.475~5.485	5.485
	EX	5.475~5.485	5.485
Valve stem-to-guide clearance	IN	0.01~0.035	0.035
	EX	0.03~0.055	0.055

6. CYLINDER HEAD/VALVES

TORQUE VALUES

Cylinder head cover bolt	0.8~1.2kg-m
Cylinder head lock nut	2.3~2.8kg-m
Cam follower bolt	1.5~2.0kg-m
Valve arm bolt	1.5~2.0kg-m

SPECIAL TOOLS

Valve spring compressor	
Valve seat cutter, 24.5mm	45° IN/EX
Valve seat cutter, 25mm	Plane cutter 37.5° IN
Valve seat cutter, 22mm	Plane cutter 37.5° EX
Valve seat cutter, 26mm	Plane cutter 63.5° IN/EX
Cutter clip, 5mm	
Valve spring compressor	
Valve wrench	780614
Valve guide driver	
Valve guide reamer	
Valve guide remover	
Valve spring compressor attachment	

6. CYLINDER HEAD/VALVES

TROUBLESHOOTING

- The poor cylinder head operation can be diagnosed by a compression test or by tracing engine top-end noises.

Poor performance at idle speed

- Compression too low

Compression too low

- Incorrect valve clearance (too small)
- Burned or bent valves
- Incorrect valve timing
- Broken valve spring
- Poor valve and seat contact
- Leaking cylinder head gasket
- Warped or cracked cylinder head
- Poorly installed spark plug

Compression too high

- Excessive carbon build-up in combustion chamber or on piston head

White smoke from exhaust muffler

- Worn or broken valve stem or valve guide
- Damaged valve stem seal
- Worn piston rings

Abnormal noise

- Incorrect valve clearance (too small)
- Burned valve or rocker arm
- Worn camshaft or cam follower
- Worn valve guide

6. CYLINDER HEAD/VALVES

CYLINDER HEAD COVER REMOVAL

Remove the secondary air reed valve. (Refer to 19-19.)

Remove the four bolts attaching the cylinder cover protector to remove the protector.

Remove the three cylinder head cover bolts.

Remove the cylinder head cover.
Inspect the cylinder head cover O-ring for wear or damage and replace if necessary.

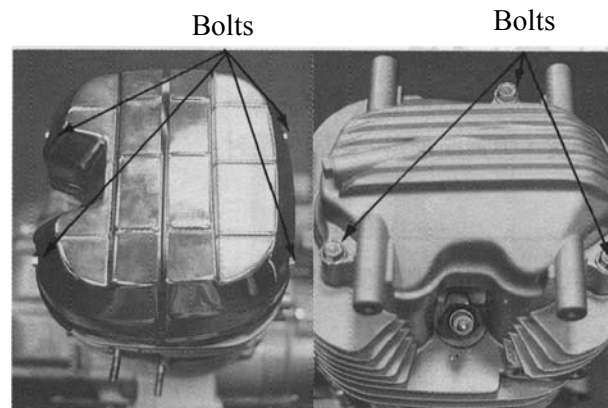

ROCKER ARM SET REMOVAL

Remove the three bolts attaching the rocker arm set.

Remove the rocker arm set.

Measure the right and left rocker arm clearances.

Standard: 0.10~0.25mm

- * • Turn the piston to the top dead center before removing the rocker arm set.
• When removing the rocker arm set, first loosen the center bolt and then the left and right bolts.

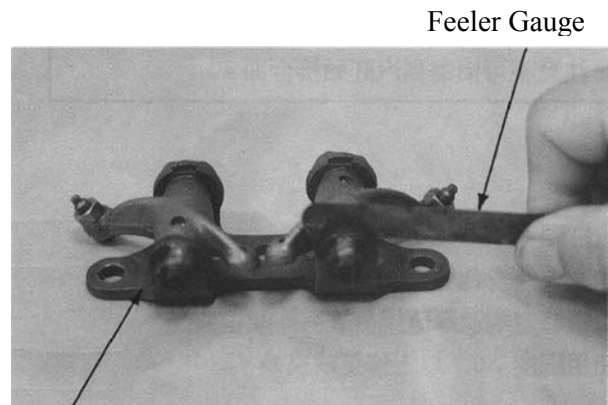
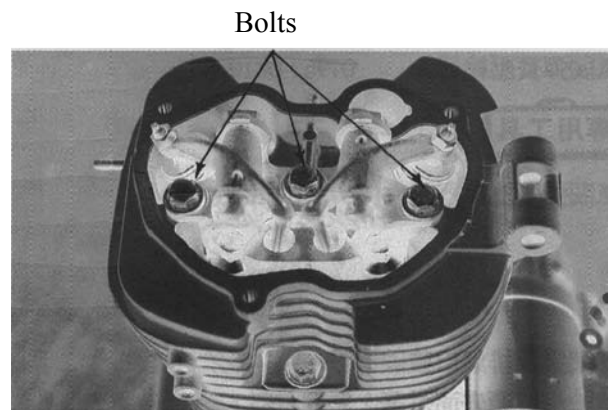

Rocker Arm Set

CYLINDER HEAD REMOVAL

Remove the intake and exhaust valve push bars.

Remove the cam follower shaft bolt.

Remove the cylinder head lock nuts diagonally.

Remove the push bar guide plate.

Remove the cylinder head.

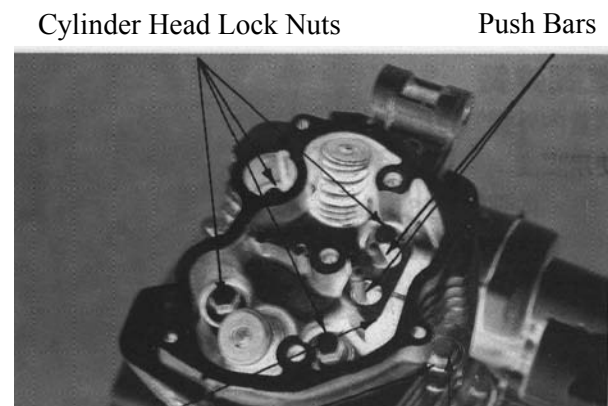

Push Bar Guide Plate

Copper Washer

Cam Follower Shaft Bolt

6. CYLINDER HEAD/VALVES

CYLINDER HEAD DISASSEMBLY

Remove the valve spring cotters, retainers, springs, spring seats, washers and valve stem seals using a valve spring compressor.

- * Be sure to compress the valve springs with a valve spring compressor.
- * Mark all disassembled parts to ensure correct reassembly.

Special

Valve Spring Compressor

Valve Spring Compressor Attachment

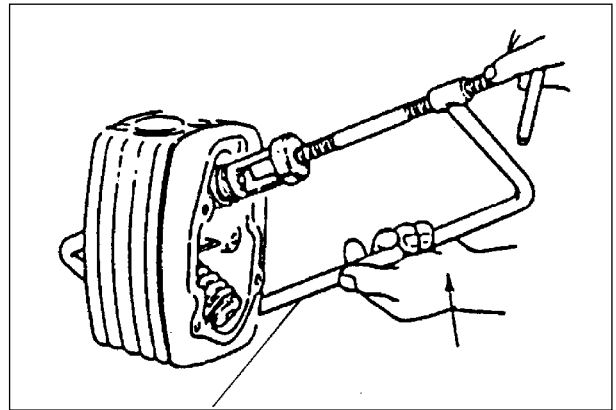

Valve Spring Compressor

Remove carbon deposits from the combustion chamber and exhaust port. Clean off any gasket material from the cylinder head mating surface.

- * Be careful not to damage the cylinder head mating surface.

INSPECTION

CYLINDER HEAD

Check the spark plug hole and valve areas for cracks.

Check the cylinder head for warpage with a straight edge and feeler gauge.

Service Limit: 0.1mm repair or replace if over

VALVE SPRING FREE LENGTH

Measure the free length of the inner and outer valve springs.

Service Limits:

Inner spring : 33.5mm

Outer spring : 40.9mm

Combustion Chamber

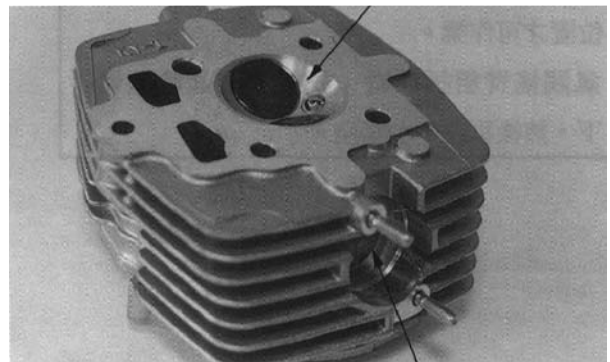

Exhaust Port

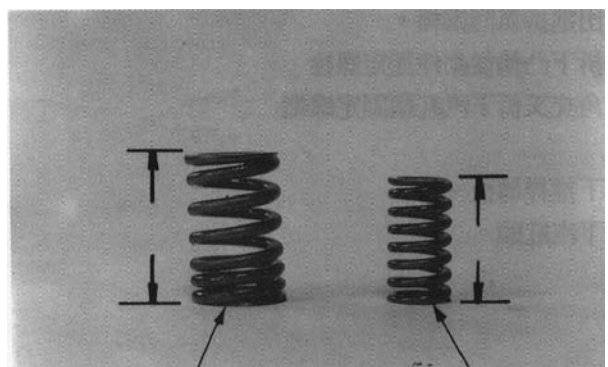

Outer Spring

Inner Spring

6. CYLINDER HEAD/VALVES

VALVE /VALVE GUIDE

Inspect each valve for bending, burning, scratches or abnormal stem wear.

Check valve movement in the guide.

Measure each valve stem O.D.

Service Limits:

IN	5.27mm replace if below
EX	5.27mm replace if below

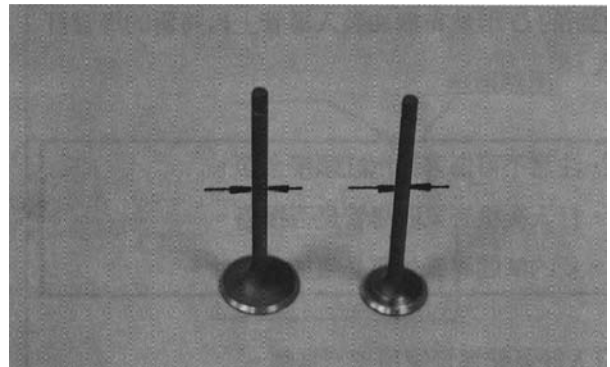

Ream the guides to remove any carbon build-up using a valve guide reamer.

Special Tool

Valve Guide Reamer

- * During this operation, rotate the reamer clockwise and do not insert or remove it straight when it is stopped.

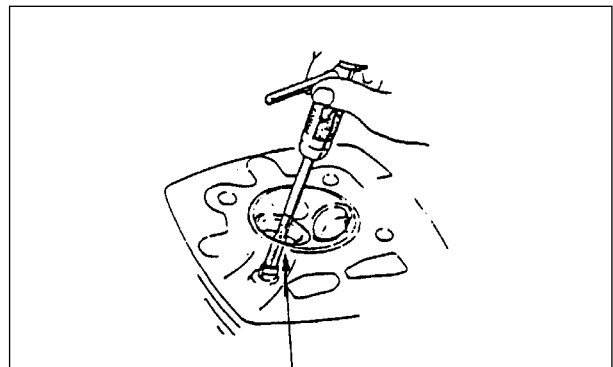

Valve Guide Reamer

Measure each valve guide I.D.

Service Limits: IN: 5.485mm replace if over
EX: 5.485mm replace if over

Subtract each valve stem O.D. from the corresponding guide I.D. to obtain the stem-to-guide clearance.

Service Limits: IN: 0.035mm
EX: 0.055mm

- * If the stem-to-guide clearance exceeds the service limits, replace the guides.
- * Reface the valve seats whenever the valve guides are replaced.

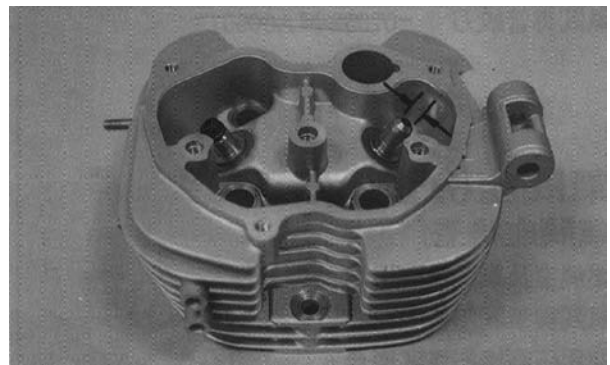

VALVE GUIDE REPLACEMENT

Drive out the old valve guides with the valve guide driver.

- * Remove carbon build-up from the guides before driving them out.
- * Drive the guides out vertically.

Special Tool

Valve Guide Driver

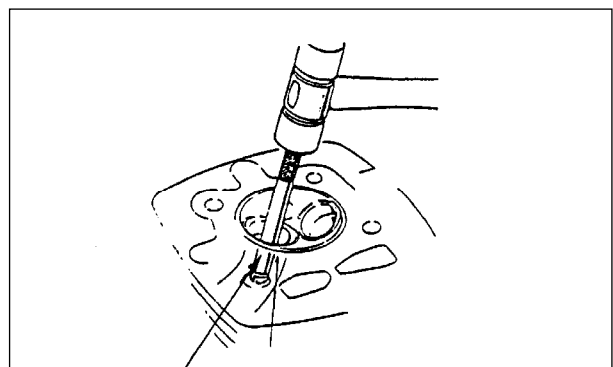

Valve Guide Driver

6. CYLINDER HEAD/VALVES

Apply engine oil to new O-rings and install them to new valve guides.
Then, drive in new valve guides.

- * Be careful not to damage the cylinder head mating surface.
- * Check for damage after driving in the new valve guides.
- * The new valve guides must have oversized O.D.

Ream the new valve guides with a valve guide reamer.

- * Use cutting oil on the reamer during this operation.
- * Rotate the reamer clockwise and do not insert or remove it straight when it is stopped.

Clean the cylinder head and remove any metal particles.

Special

Valve Guide Reamer

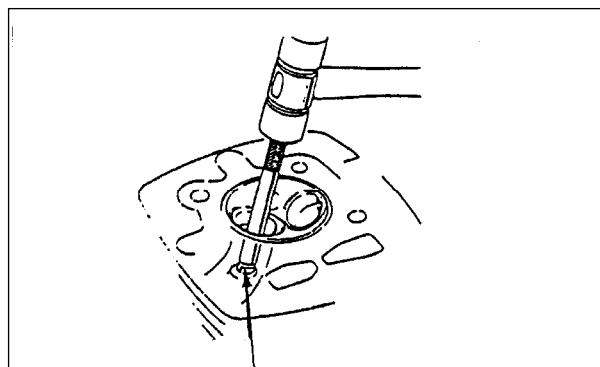

Valve Guide Driver

Valve Guide Reamer

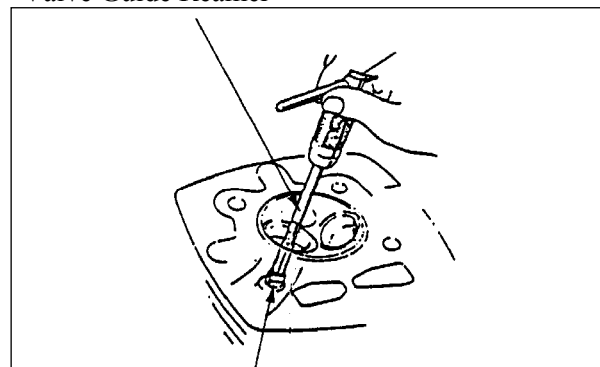

Valve Guide

VALVE SEAT INSPECTION & REFACING

VALVE SEAT INSPECTION

Remove carbon deposits from the combustion chamber and valves.
Apply emery to each valve and valve seat contact face.

Lap each valve using a hand lapper.
Remove the valve and inspect the valve face.
If the valve face is rough, worn unevenly, or contacts the seat improperly, the valve must be replaced.

Inspect the valve seat width.

Service Limit: 1.2~1.5mm replace if over
If the seat is too wide or too narrow or has low spots, the seat must be ground using a valve seat cutter.

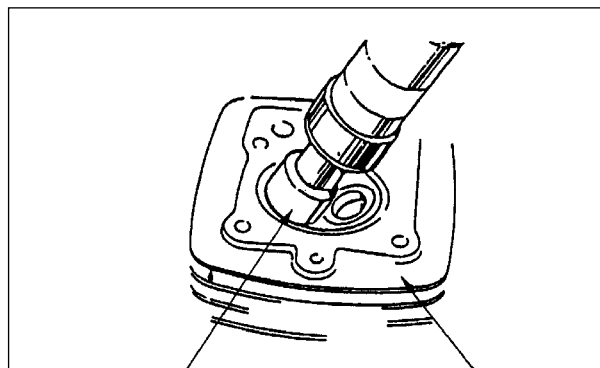

Lapper

Cylinder Head

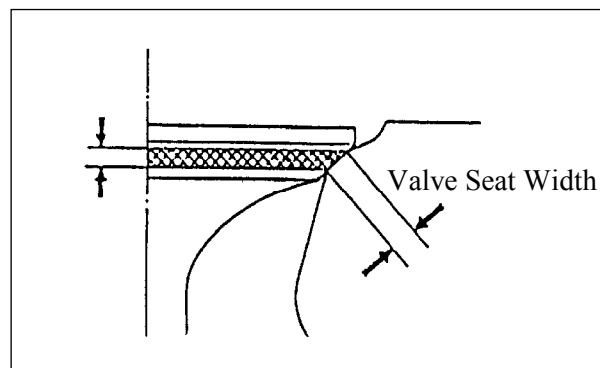

6. CYLINDER HEAD/VALVES

VALVE SEAT GRINDING

Remove any roughness or irregularities from the seat using a 45° cutter.

* Be careful not to grind too much.

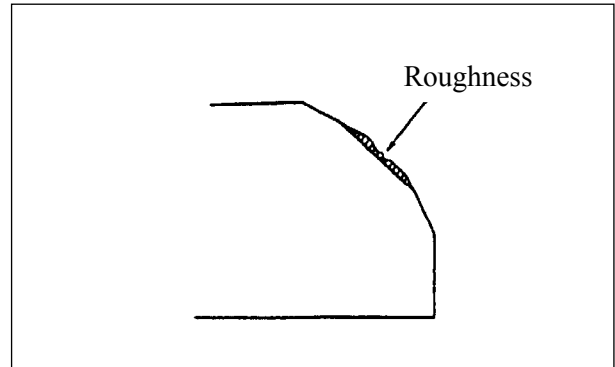

Use a 37.5° cutter to remove the upper existing valve seat material.

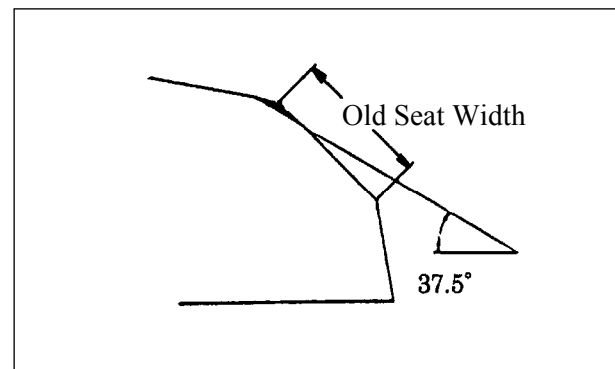

Use a 63.5° cutter to remove the lower existing valve seat material.

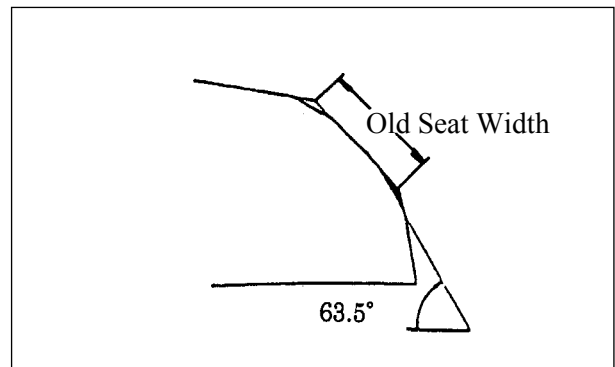

Install a 45° finish cutter and cut the seat to the proper width.

Standard Seat Width: 1.0mm

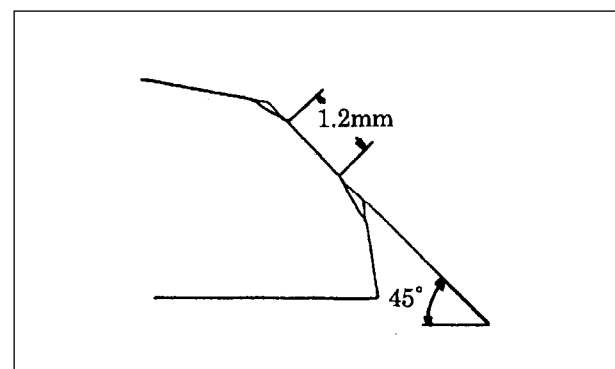

6. CYLINDER HEAD/VALVES

Inspect the valve seat contact area.

If the contact area is too high on the valve, the seat must be lowered using a 37.5° cutter. If the contact area is too low on the valve, the seat must be raised using a 63.5° cutter. Refinish the seat to specifications using a 45° seat cutter.

After cutting the seat, apply emery to each valve contact face and lap the valve using a lapper.

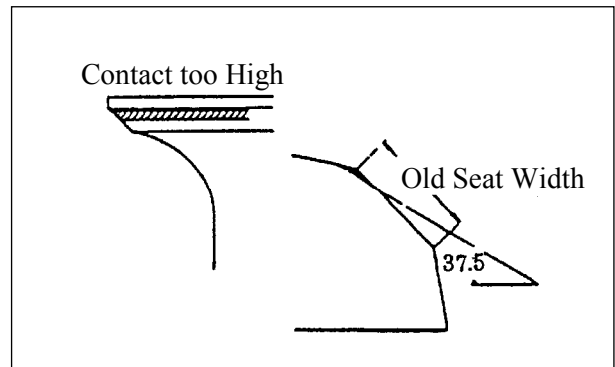

After lapping, wash all residuals off the cylinder head and valves.

- * When lapping, use a light pressure and avoid damaging the valve seat due to forcedly lapping.
- * Use care not to allow emery powder to enter the valve stem and guide.

After refacing and lapping, apply red lead to the 45° valve seat to make sure that the center of the valve contact face is even.

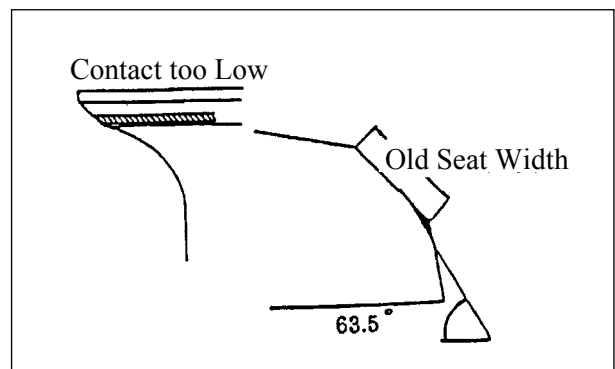

CYLINDER HEAD ASSEMBLY

Lubricate each valve stem with engine oil and insert the valves into the valve guides. Apply engine oil to the valve stem seals and install them into the valve guides.

- * Be sure to install new valve stem seals.

Stem Seal Valve Stem

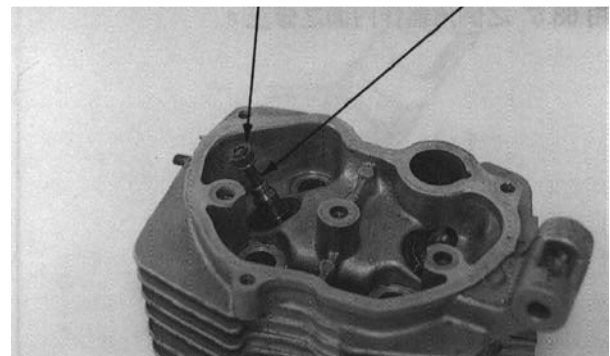

Install the valve spring seats, washers, inner and outer springs, and retainers. Compress the valve springs using the valve spring compressor, then install the valve cotters.

- * Use the valve spring compressor to compress the springs and do not damage the cylinder head surface.
- * Install the cotters with the pointed ends facing down.

Special

Valve Spring Compressor
Valve Spring Compressor Attachment

Valve Spring Compressor

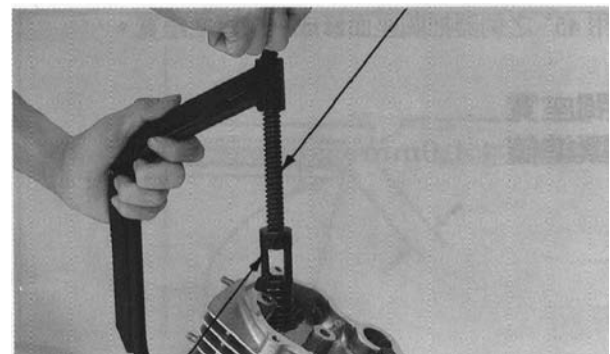

Valve Spring Compressor Attachment

6. CYLINDER HEAD/VALVES

Tap the valve stems gently with a plastic hammer for 2~3 times to firmly seat the cotters.

* Be careful not to damage the valves.

Plastic Hammer

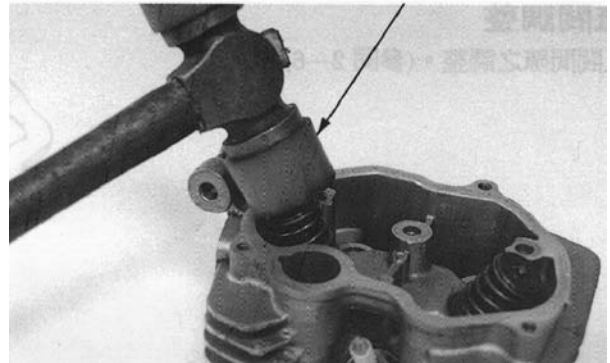

CYLINDER HEAD INSTALLATION

Install the dowel pins and a new gasket onto the cylinder.

Dowel Pins

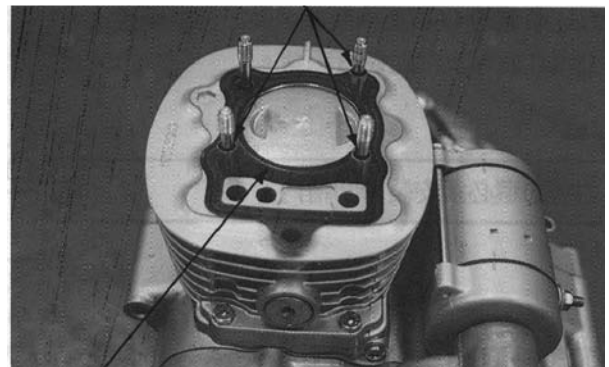

Gasket

Install the cylinder head.
Install the push bar guide plate and the four cylinder head lock nuts.
Tighten the cylinder head lock nuts diagonally.

Torque: 2.3~2.8kg-m

Install the cam follower shaft bolt, copper washer and then tighten the bolt.

Torque: 1.8~2.3kg-m

Cylinder Head Lock Nuts

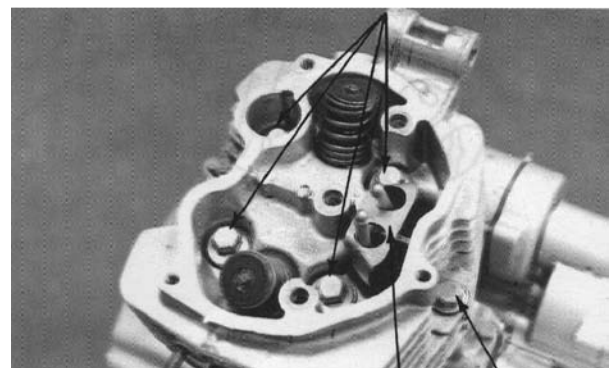

Push Bar Guide Plate Cam Follower Shaft Bolt

Install the two push bars.
Install the rocker arm set, bolts and copper washers.
Tighten the center bolt first and then tighten the left and right bolts.

Torque: 1.5~2.0kg-m

Rocker Arm Set

Bolts

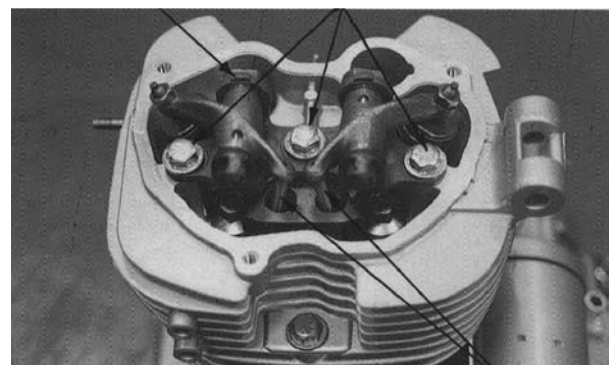

Push Bars

6. CYLINDER HEAD/VALVES

VALVE CLEARANCE ADJUSTMENT

Adjust the valve clearance. (Refer to 2-6.)

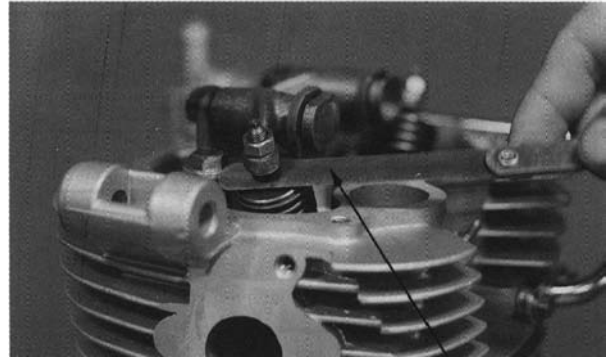

Feeler Gauge

Install a new cylinder head cover O-ring onto the cylinder head cover.
Install the cylinder head cover and cylinder head cover protector.

* Be sure to install the O-ring into the groove properly.

Install and tighten the three cylinder head cover bolts.

Torque: 0.8~1.2kg-m

Cylinder Head Cover O-ring

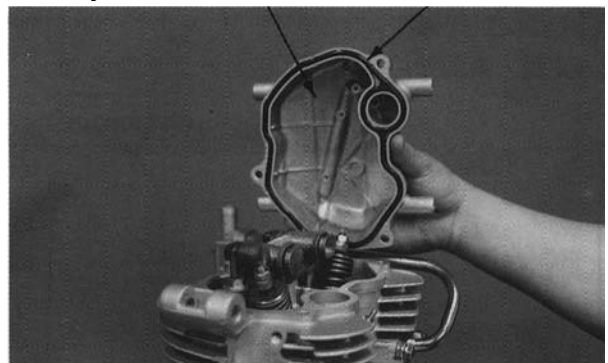

7. CYLINDER/PISTON

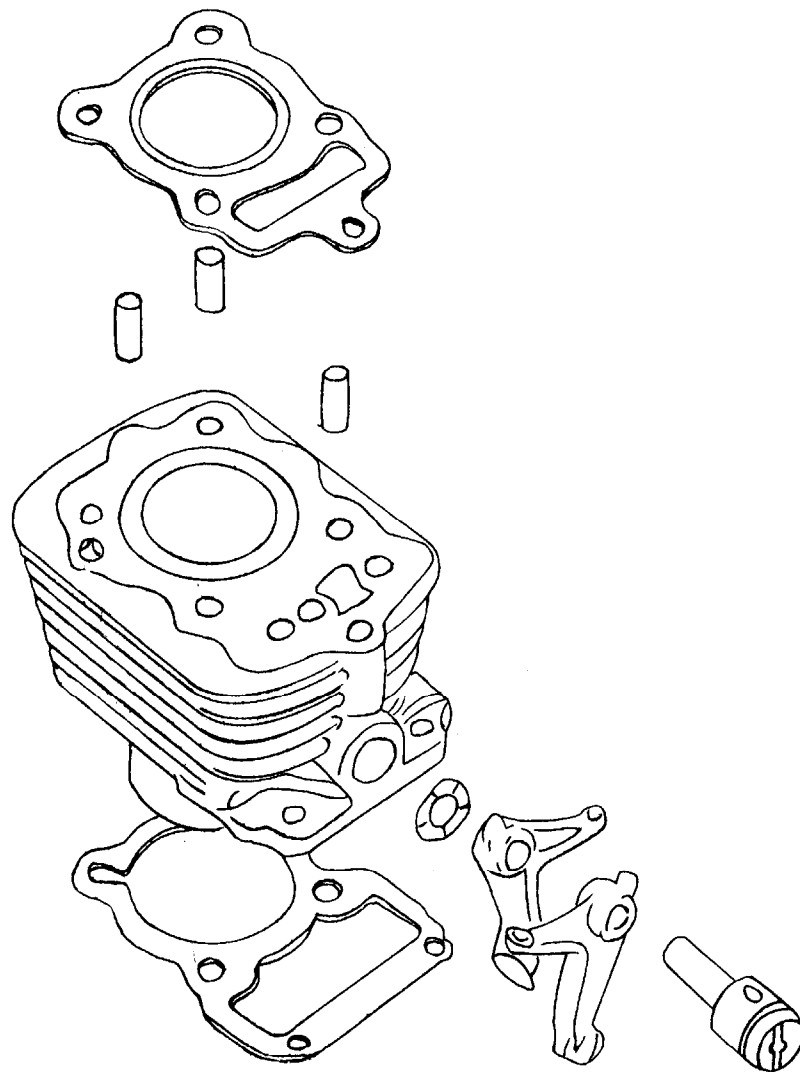

7

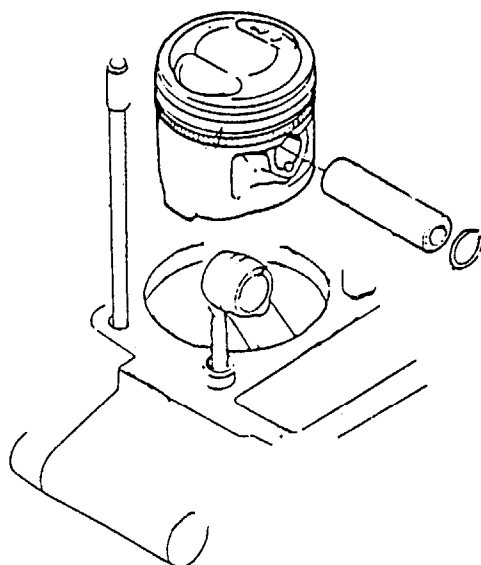

7. CYLINDER/PISTON

SERVICE INFORMATION.....7-1	CAM FOLLOWER REMOVAL.....7-2
TROUBLESHOOTING.....7-1	PISTON REMOVAL.....7-2
CYLINDER REMOVAL.....7-2	CYLINDER INSTALLATION.....7-7

SERVICE INFORMATION

GENERAL INSTRUCTIONS

- The cylinder and piston can be serviced with the engine installed in the frame.
- After disassembly, clean the removed parts and dry them with compressed air before inspection.

Unit: mm

SPECIFICATIONS

Item		Standard		Service Limit	
		125cc	150cc	125cc	150cc
Cylinder	I.D.	56.5~56.51	62~62.01	56.6	62.1
	Warpage	—		—	
	Cylindricity	0.01		0.05	
	True roundness	0.01		0.05	
Piston/ piston ring	Ring-to-groove clearance	Top	0.45~0.7	0.9	
		Second	0.8~1.05	1.2	
	Ring end gap	Top	0.1~0.3	0.5	
		Second	0.1~0.3	0.5	
		Oil side rail	0.3~0.9	1.1	
	Piston O.D.	56.45~56.48	61.97~61.99	56.35	61.87
	Piston O.D. measuring position	10mm from bottom of skirt			
	Piston-to-cylinder clearance	0.005~0.065		0.1	
Piston pin hole I.D.	15.002~15.008		15.012		
Piston pin O.D	14.994~15		14.99		
Piston-to-piston pin clearance	0.001~0.007		0.01		
Connecting rod small end I.D.	15.01~15.028		15.032		

TROUBLESHOOTING

- When hard starting or poor performance at low speed occurs, check the crankcase breather for white smoke. If white smoke is found, it means that the piston rings are worn, stuck or broken.

Compression too low

- Worn, stuck or broken piston rings
- Worn or damaged cylinder or piston

Excessive smoke from exhaust muffler

- Worn or damaged piston rings
- Worn or damaged cylinder or piston

Compression too high

- Excessive carbon build-up in combustion chamber or on piston head

Abnormal noisy piston

- Worn cylinder, piston or piston rings
- Worn piston pin hole or piston pin

7. CYLINDER/PISTON

CYLINDER REMOVAL

Remove the cylinder head. (Refer to 6-5.)
Remove the dowel pins.
Remove the two bolts attaching the cylinder.
Remove the cylinder.

Dowel Pins

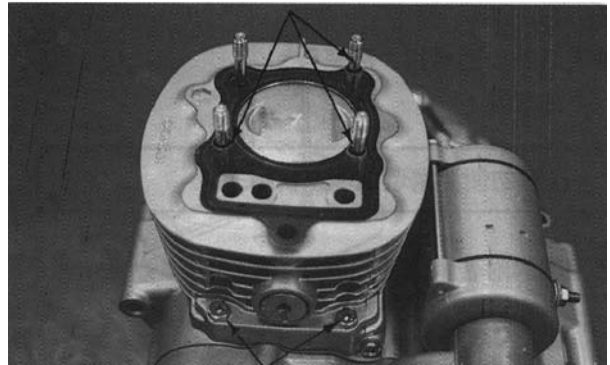

Bolts

CAM FOLLOWER REMOVAL

Remove the cam follower shaft.
Remove the cam follower and 12mm washer (wave washer).



Cam Follower

Cam Follower Shaft

Remove the cylinder gasket and dowel pins.
Clean any gasket material from the cylinder surface.

Cylinder Gasket



Dowel Pin

PISTON REMOVAL

Remove the piston pin clip.

* Place a clean shop towel in the crankcase to keep the piston pin clip from falling into the crankcase.

Press the piston pin out of the piston and remove the piston.

Piston

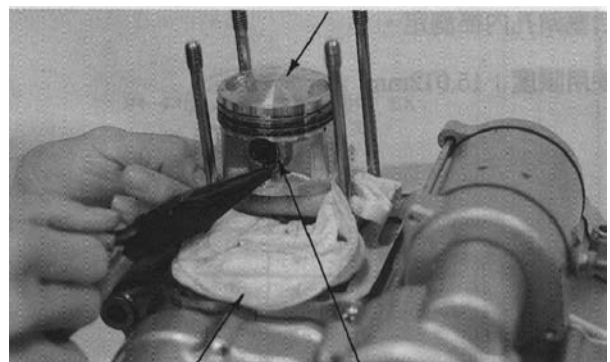

Towel

Clip

7. CYLINDER/PISTON

INSPECTION

Inspect the piston, piston pin and piston rings.

Remove the piston rings.

- * Take care not to damage or break the piston rings during removal.

Remove carbon deposits from the piston ring grooves.

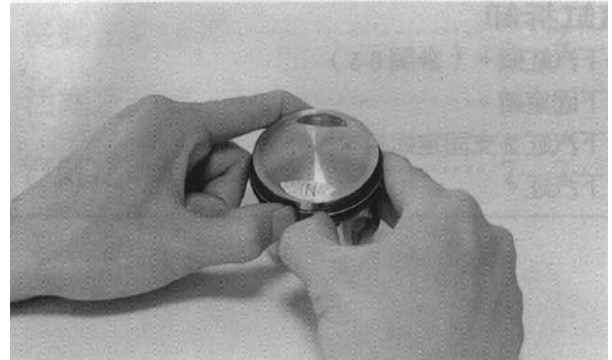

Install the piston rings onto the piston and measure the piston ring-to-groove clearance.

Service Limits: Top: 0.9mm replace if over

2nd: 0.9mm replace if over

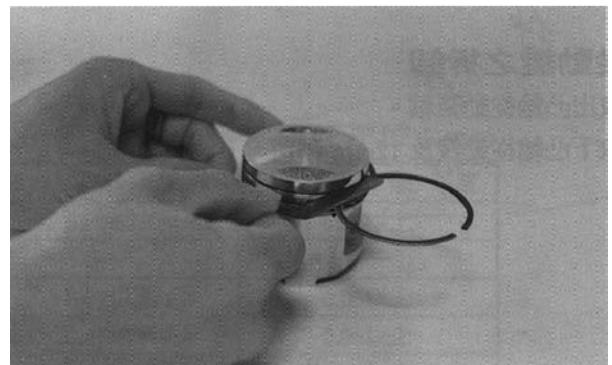

Remove the piston rings and insert each piston ring into the cylinder bottom.

- * Use the piston head to push each piston ring into the cylinder.

Measure the piston ring end gap.

Service Limit: 0.50mm



Measure the piston pin hole I.D.

Service Limit: 15.012mm

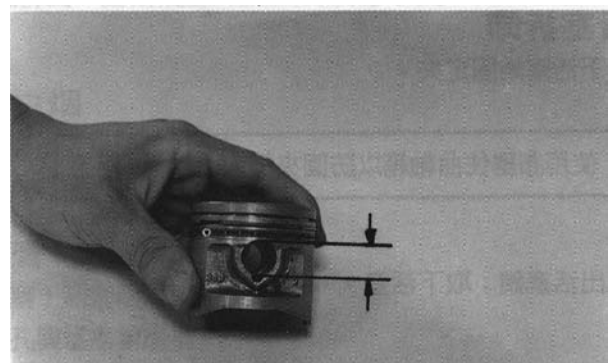

7. CYLINDER/PISTON

Measure the piston pin O.D.

Service Limit: 14.99mm replace if below

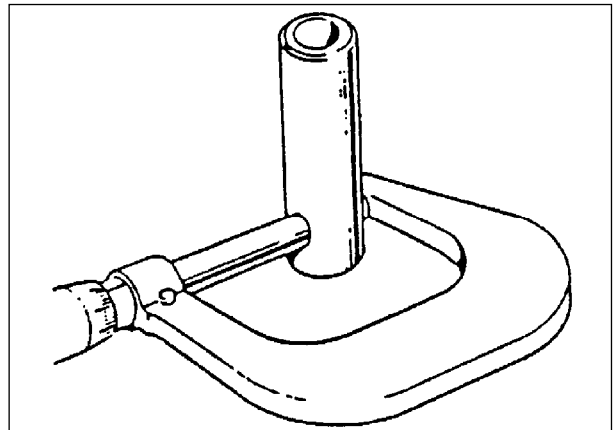

Measure the piston O.D.

* Take measurement at 10mm from the bottom and 90° to the piston pin hole.

Service Limit:

150cc: 61.8mm replace if below

125cc: 56.35mm replace if below

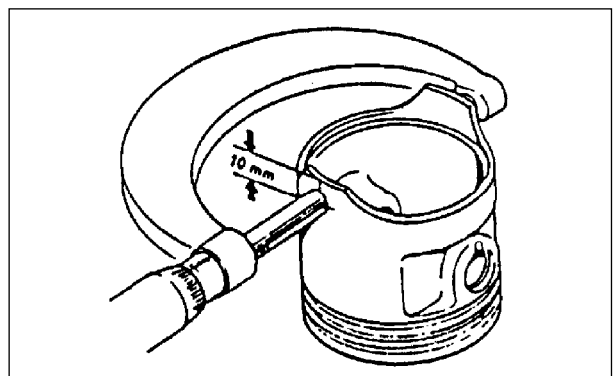

CYLINDER INSPECTION

Inspect the cylinder bore for wear, scratches or damage.

Measure the cylinder I.D. at three levels of top, middle and bottom at 90° to the piston pin (in both X and Y directions).

Service Limit: **150cc:** 62.1mm replace if over
125cc: 56.6mm replace if over

Measure the cylinder-to-piston clearance and take the maximum figure measured.

Service Limit: 0.1mm repair or replace if over

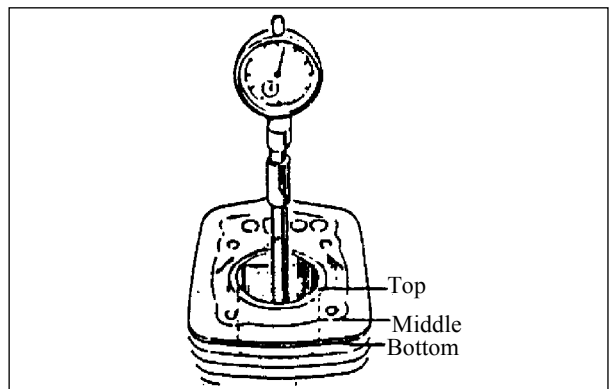

The true roundness is the difference between the values measured in X and Y directions. The cylindricity (difference between the values measured at the three levels in X or Y directions) is subject to the maximum value calculated.

Service Limits:

True Roundness: 0.05mm repair or replace if over

Cylindricity: 0.05mm repair or replace if over

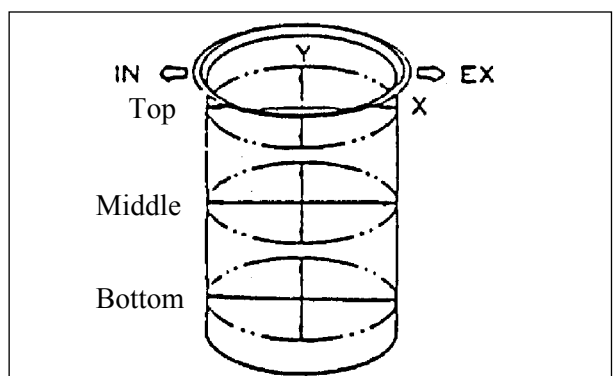

7. CYLINDER/PISTON

Inspect the top of the cylinder for warpage.
Service Limit: 0.05mm repair or replace if over

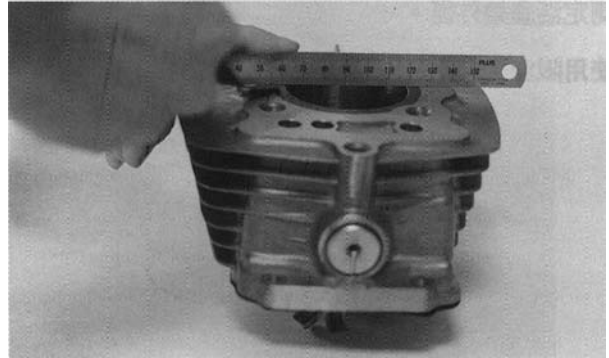

Measure the connecting rod small end I.D.
Service Limit: 15.032mm replace if over

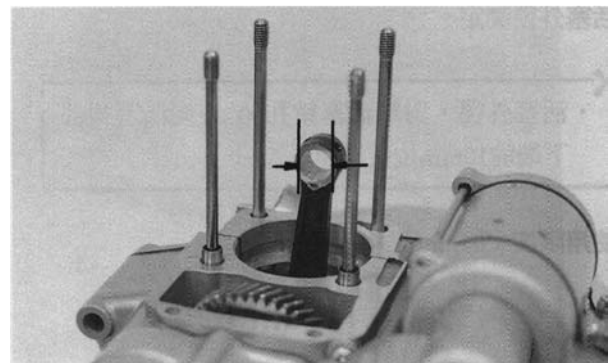

Check the cam follower contact face for wear or peeling of electroplated coating.

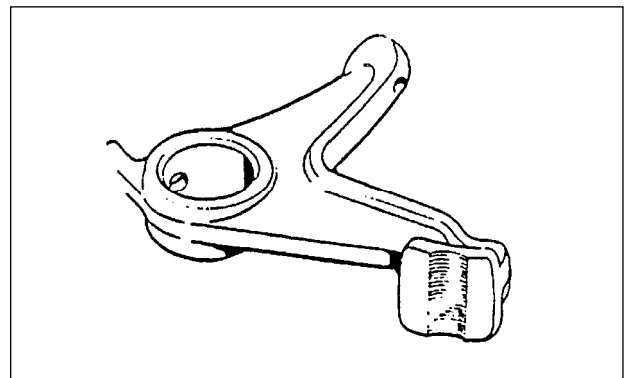

Measure the cam follower shaft I.D.
Service Limit: 12.05mm replace if over

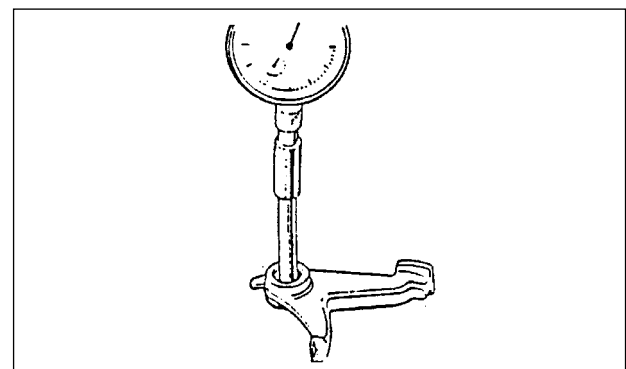

7. CYLINDER/PISTON

Measure the cam follower shaft O.D.

Service Limit: 11.95mm replace if below

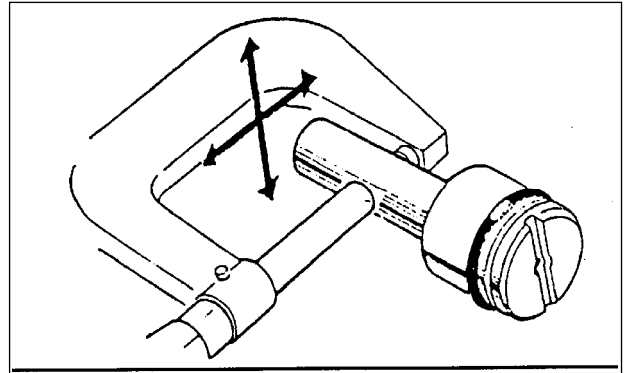

Check the push bar for bending and steel balls for wear or dropping.

Measure the push bar length.

Service Limit: 141mm replace if below

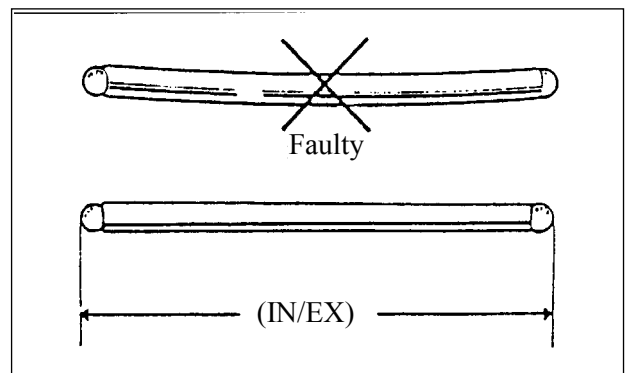

PISTON INSTALLATION

Piston Ring Installation

First install the third ring side rail onto the piston and then install the oil ring, side rail, second ring and the top ring onto the piston. Apply engine oil to each piston ring.

*

- Be careful not to damage or break the piston and piston rings.
- All rings should be installed with the English markings facing up.
- When assembling the piston rings, do not expand the ring end gap larger than 8 times of its thickness.
- After the rings are installed, they should rotate freely without sticking.

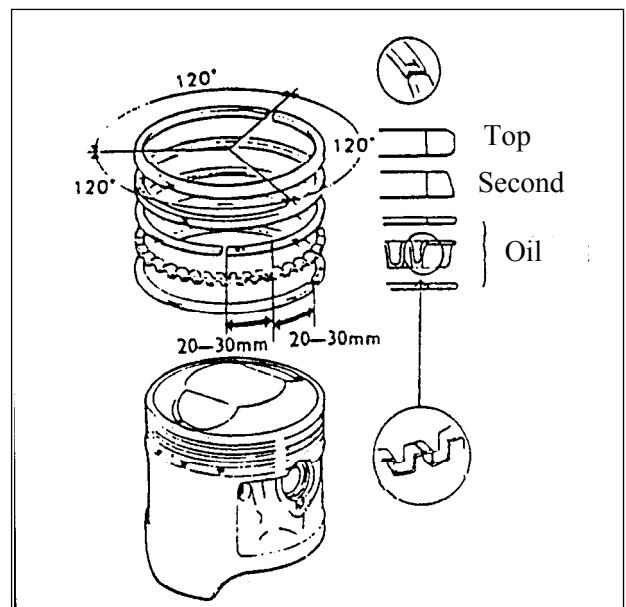

7. CYLINDER/PISTON

Remove any gasket material from the crankcase surface.

- * Place a shop towel in the crankcase to prevent foreign matters from falling into the crankcase.



Gasket

Install the piston, piston pin and a new piston pin clip.

- *
 - Position the piston top “IN” mark on the intake valve side.
 - Place a clean shop towel in the crankcase to prevent the piston pin clip from falling into the crankcase.

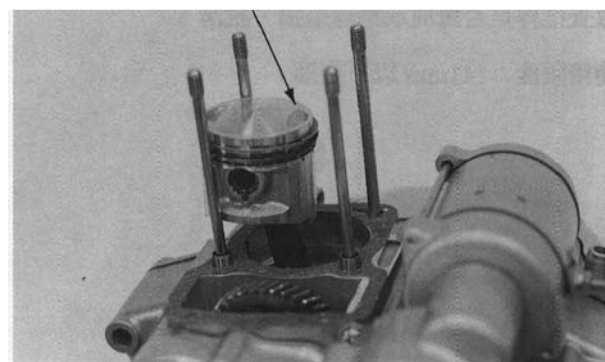

“IN” Mark

CYLINDER INSTALLATION

Install the 12mm washer (wave washer) into the groove.

Install the cam follower and cam follower shaft.

Apply engine oil to the cam follower shaft O-ring and install it with even force.

- * Install the cam follower shaft with the slot on the shaft in vertical position.

dowel pins and a new cylinder gasket on the crankcase.

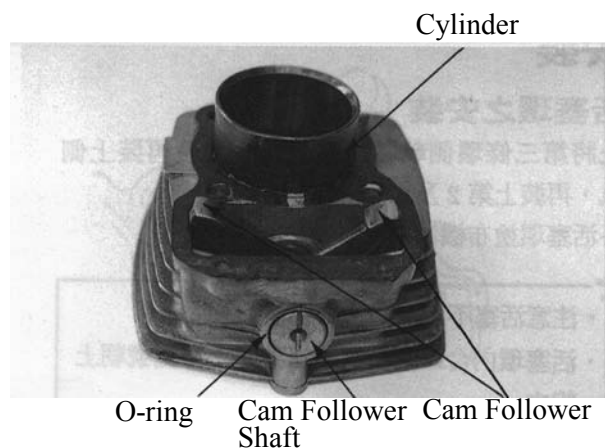

Cylinder

O-ring Cam Follower Cam Follower Shaft

Carefully lower the cylinder over the piston by compressing the piston rings.

- *
 - When installing the cylinder, be careful that the ring end gap should not be 90° to the piston pin.
 - The ring end gaps should align with the four cylinder head lock nuts.

Stagger the ring end gaps as shown. (Refer to 7-6.)

Install the cylinder gasket, dowel pins and O-ring.



Piston

8. STARTER MOTOR/GENERATOR/LEFT CRANK-CASE COVER/STARTER CLUTCH/CAMSHAFT

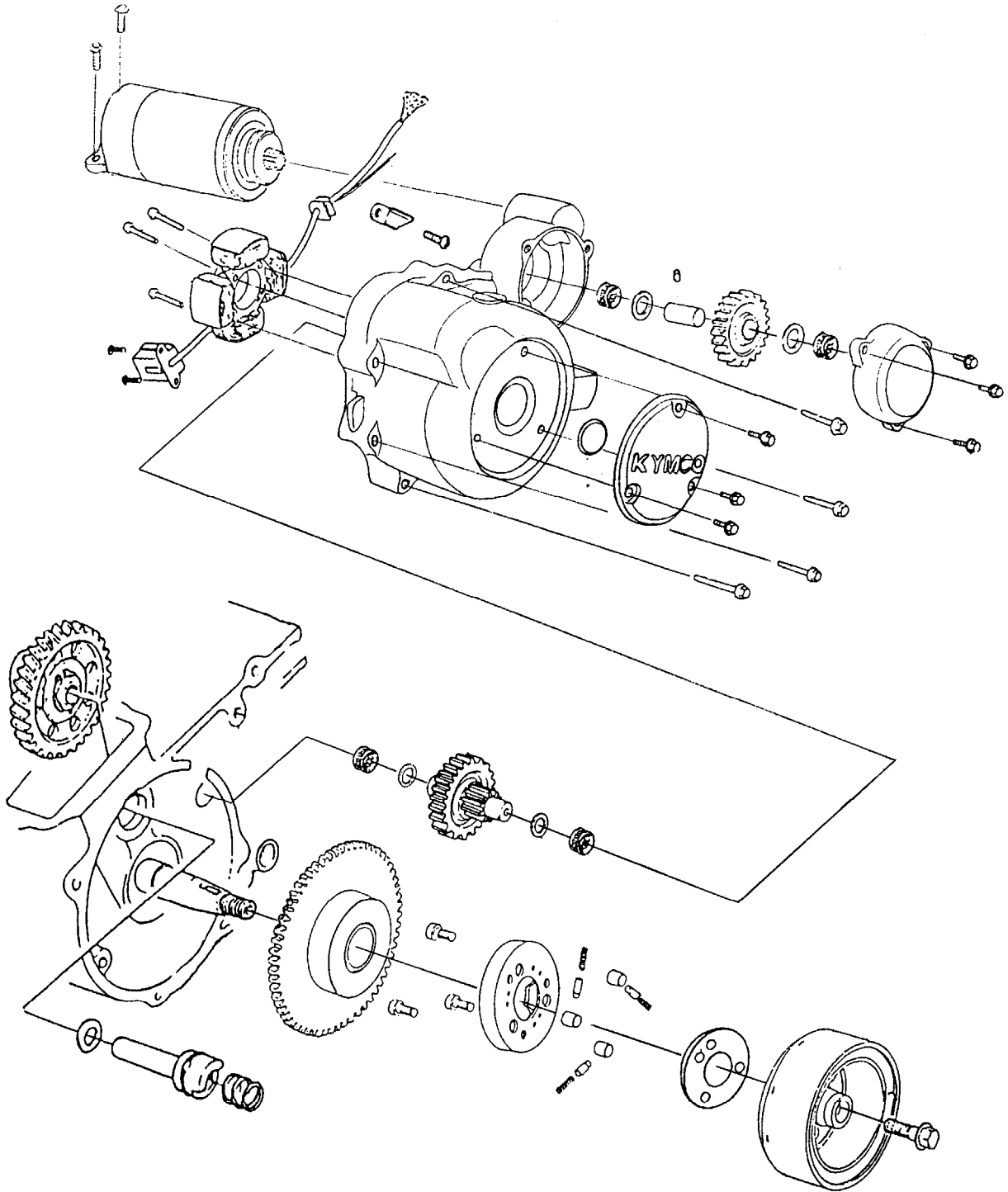

8

8. STARTER MOTOR/GENERATOR/LEFT CRANK-CASE COVER/STARTER CLUTCH/CAMSHAFT

SERVICE INFORMATION	8-1	CAMSHAFT REMOVAL.....	8-4
TROUBLESHOOTING.....	8-1	CAMSHAFT INSTALLATION.....	8-5
STARTER MOTOR	8-2	STARTER GEAR INSTALLATION.....	8-5
LEFT CRANKCASE COVER REMOVAL.....	8-2	GENERATOR INSTALLATION	8-5
GENERATOR REMOVAL.....	8-2	LEFT CRANKCASE COVER INSTALLATION...	8-6
STARTER CLUTCH REMOVAL	8-3	STARTER MOTOR INSTALLATION.....	8-6

SERVICE INFORMATION

GENERAL INSTRUCTIONS

- The starter motor, generator, left crankcase and starter clutch can be serviced in the frame.
- Do not install the starter clutch forcedly.
- Install the generator by aligning the groove in the flywheel with the key on the crankshaft.
- Install the starter motor reduction gear shaft by aligning the shaft pin with the shaft seat groove.

SPECIFICATIONS

Item	Standard (mm)	Service Limit (mm)
Reduction gear shaft O.D.	9.972~9.987	9.932
Reduction gear shaft hole I.D.	10.031~10.056	10.096
Camshaft O.D.	13.966~13.984	13.926
Cam gear shaft hole I.D.	14.06~14.078	14.118
Roller O.D.	9.99~10.005	9.95
Starter gear shaft I.D.	22.01~22.022	22.062
Starter gear shaft O.D.	42.574~42.6	42.534

TORQUE VALUES

Flywheel lock bolt 0.8~1.2kg-m

SPECIAL TOOLS

Flywheel holder
Flywheel puller

TROUBLESHOOTING

Hard starting and poor performance at high speed

- Improperly tightened flywheel lock bolt

Starter clutch slips

- Worn starter clutch roller
- Faulty starter clutch roller or spring
- Worn starter gear shaft O.D.

Starting noise

- Worn reduction gear
- Worn starter gear
- Worn starter clutch roller
- Faulty reduction gear shaft bearing

8. STARTER MOTOR/GENERATOR/LEFT CRANK-CASE COVER/STARTER CLUTCH/CAMSHAFT

STARTER MOTOR REMOVAL

Remove the two starter motor mounting bolts and the motor.
Inspect the starter motor O-ring for damage or deterioration.
Inspect the starter motor pinion for wear or damage.

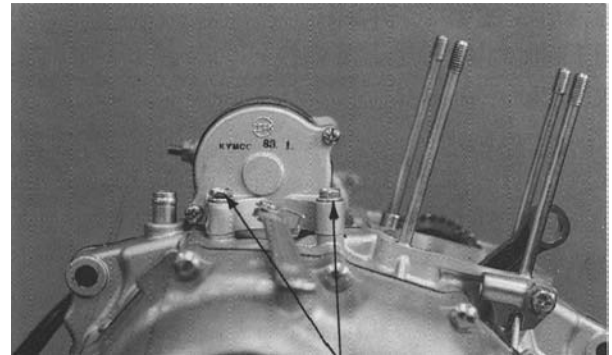

Mounting Bolts

Remove the three bolts attaching the starter motor reduction gear cover.
Remove the reduction gear cover.
Remove the reduction gear, shaft and washers.
Inspect the reduction gear for wear or damage.
Inspect the reduction gear cover O-ring for damage or deterioration.

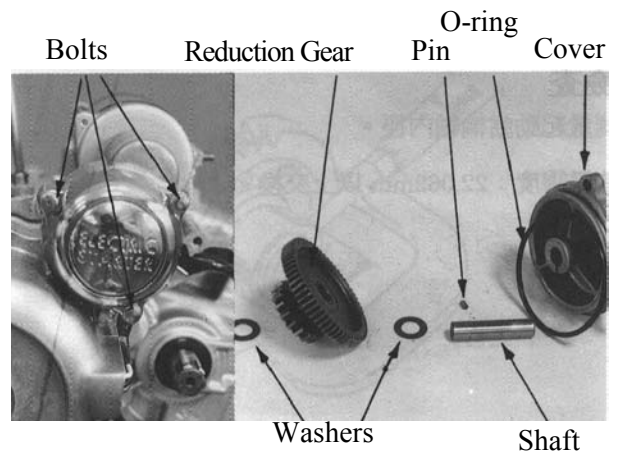

LEFT CRANKCASE COVER/GENERATOR REMOVAL

Disconnect the neutral light switch wire.
Remove the eight left crankcase cover bolts.
Remove the left crankcase cover and two dowel pins.
Clean off all gasket material from the left crankcase cover.
Remove the reduction pinion.

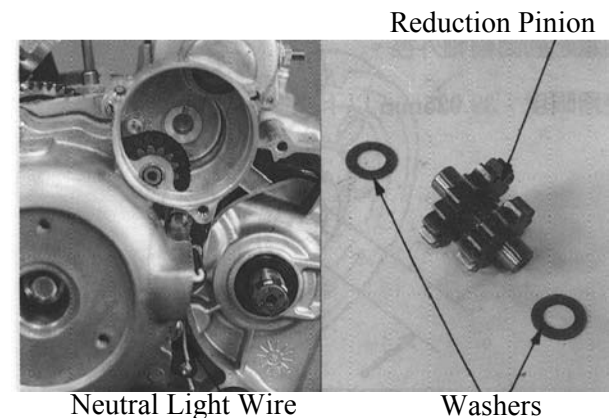

Hold the flywheel with a flywheel holder.
Remove the flywheel lock bolt.
Remove the flywheel using a flywheel puller.

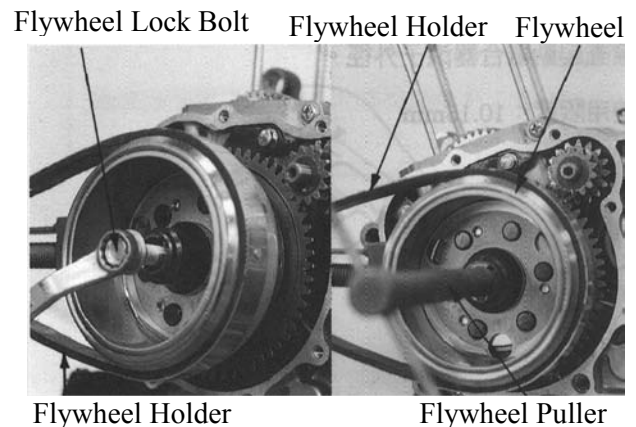

8. STARTER MOTOR/GENERATOR/LEFT CRANK-CASE COVER/STARTER CLUTCH/CAMSHAFT

STARTER CLUTCH REMOVAL

Remove the bolt attaching the starter gear set plate.
Remove the starter gear.

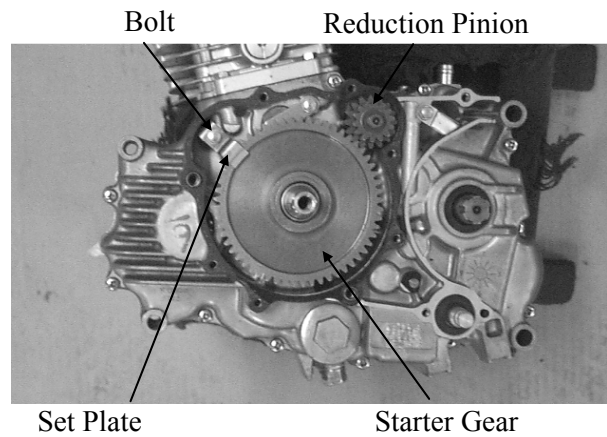

INSPECTION

Measure the starter gear shaft I.D.
Service Limit: 22.062mm replace if over

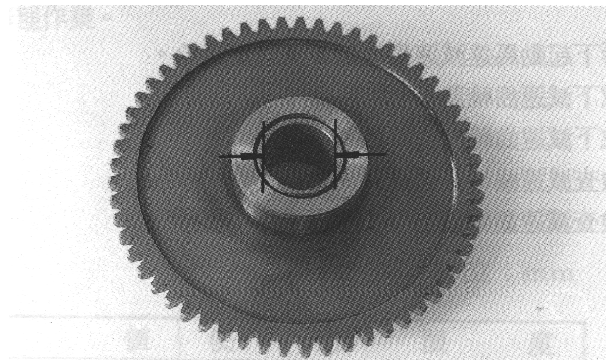

Measure the starter gear shaft O.D.
Service Limit: 42.534mm replace if below

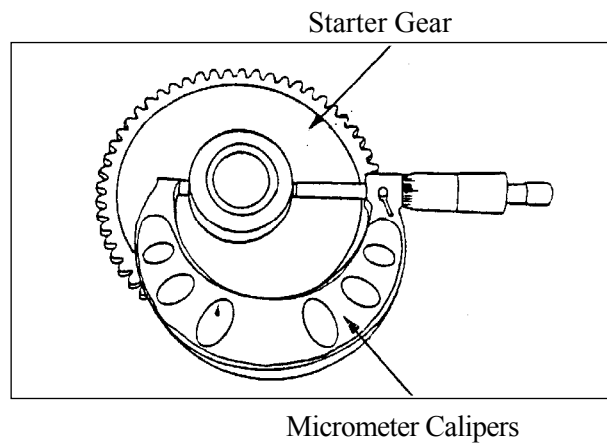

Measure the starter clutch roller O.D.
Service Limit: 9.95mm

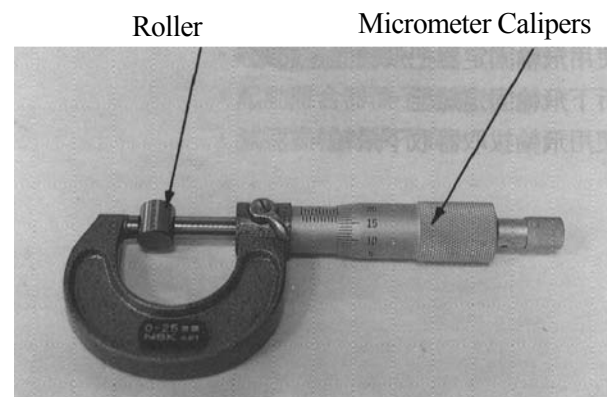

8. STARTER MOTOR/GENERATOR/LEFT CRANK-CASE COVER/STARTER CLUTCH/CAMSHAFT

CAMSHAFT REMOVAL

Remove the camshaft set piece.
Remove the spring, camshaft, washer and cam.
Inspect the camshaft O-ring for wear or damage.

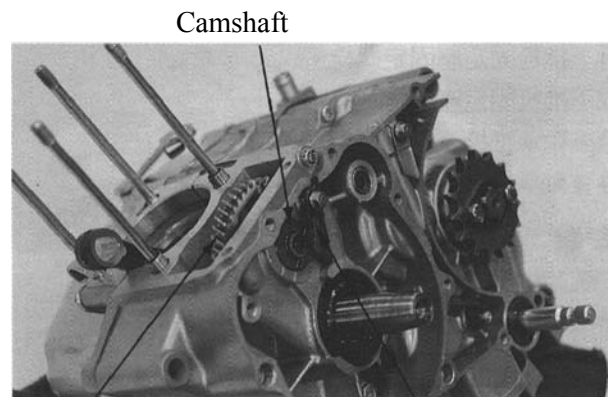

Cam Gear

Set Piece

Measure the cam lobe height.

Service Limit: 32.628mm replace if below

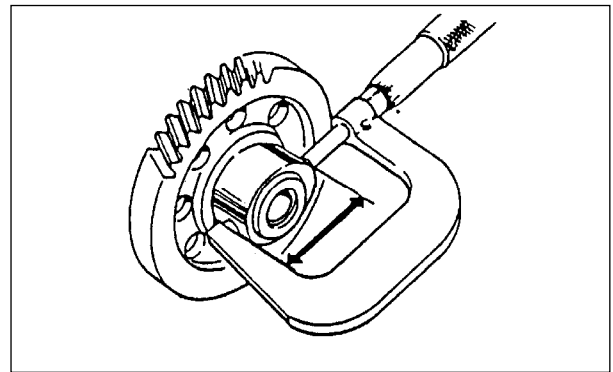

Measure the cam gear shaft hole I.D..

Service Limit: 14.118mm replace if over

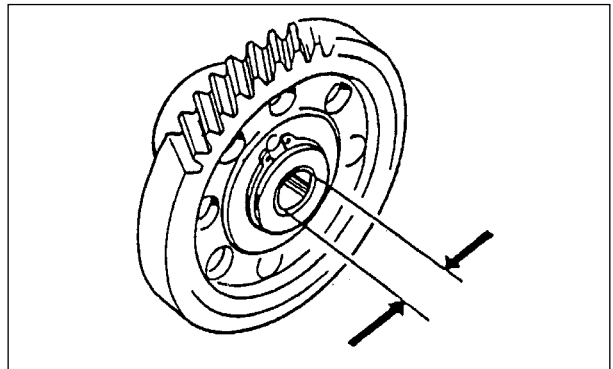

Measure the camshaft O.D..

Service Limit: 13.926mm replace if below

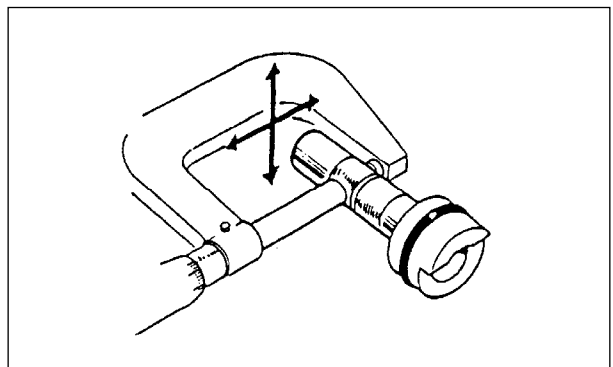

8. STARTER MOTOR/GENERATOR/LEFT CRANK-CASE COVER/STARTER CLUTCH/CAMSHAFT

Remove the push rod holder bolt.
Remove the push rod holder.
Check the bearing push rod for proper operation.
Check the bearing push rod and O-ring for wear or damage.

Installation

Install the bearing push rod by pressing it in squarely and then tighten the bolt.

- * Make sure to install the two aluminum washers.

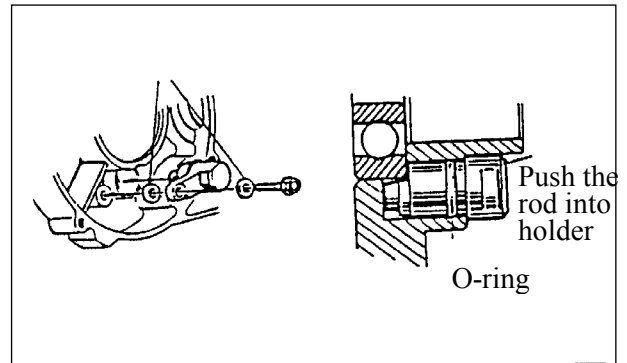

CAMSHAFT INSTALLATION

Install the cam by aligning the punch mark on the cam with the punch mark on the timing gear.
Install the washer, camshaft, spring and camshaft set piece and then tighten the bolt.
Torque: 0.8~1.2kg-m

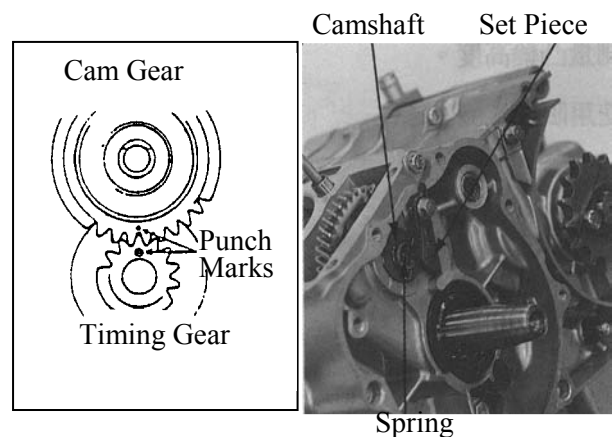

STARTER GEAR INSTALLATION

Install the starter gear and set plate and then tighten the bolt.
Torque: 0.8~1.2kg-m

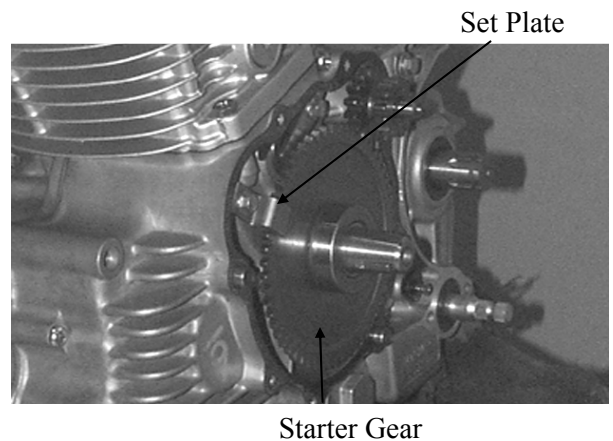

GENERATOR INSTALLATION

Install the generator flywheel. Hold the flywheel with a flywheel holder and tighten the flywheel lock bolt.

- *
 - Install the flywheel by aligning the groove in the flywheel with the key on the crankshaft.
 - When installing, be careful not to damage the starter clutch rollers.

Torque: 4.0~5.2kg-m

Special Tool

Flywheel Holder

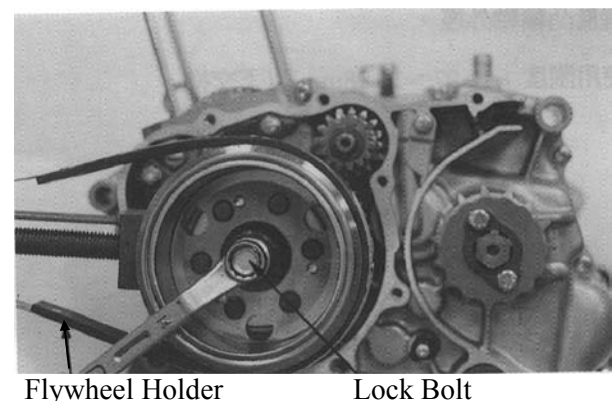

8. STARTER MOTOR/GENERATOR/LEFT CRANKCASE COVER/STARTER CLUTCH/CAMSHAFT

LEFT CRANKCASE COVER INSTALLATION

Install the left crankcase cover and tighten the eight bolts. (Refer to 8-2.)

Torque: 0.8~1.2kg-m



Install the reduction gear, shaft and washers. Then install the reduction gear cover and tighten the three bolts.

Torque: 0.8~1.2kg-m

*

- Install the reduction gear shaft by aligning the shaft pin with the shaft seat groove.
- Apply engine oil to the reduction gear cover O-ring before installation.

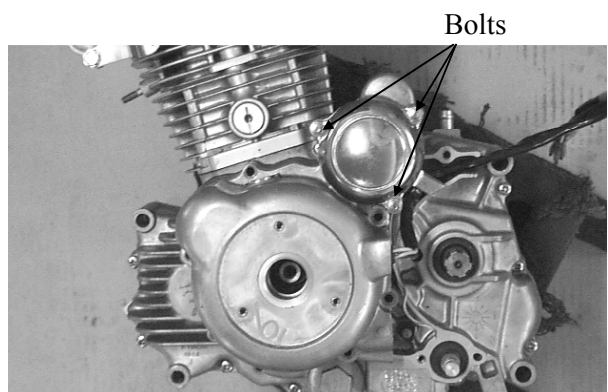

STARTER MOTOR INSTALLATION

Apply engine oil to the starter motor O-ring and then install it.

Install the starter motor.

Tighten the two mounting bolts.

Torque: 0.8~1.2kg-m

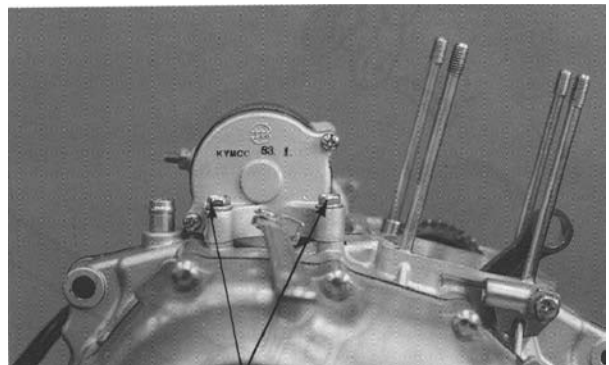

9. CLUTCH/GEAR SHIFT MECHANISM

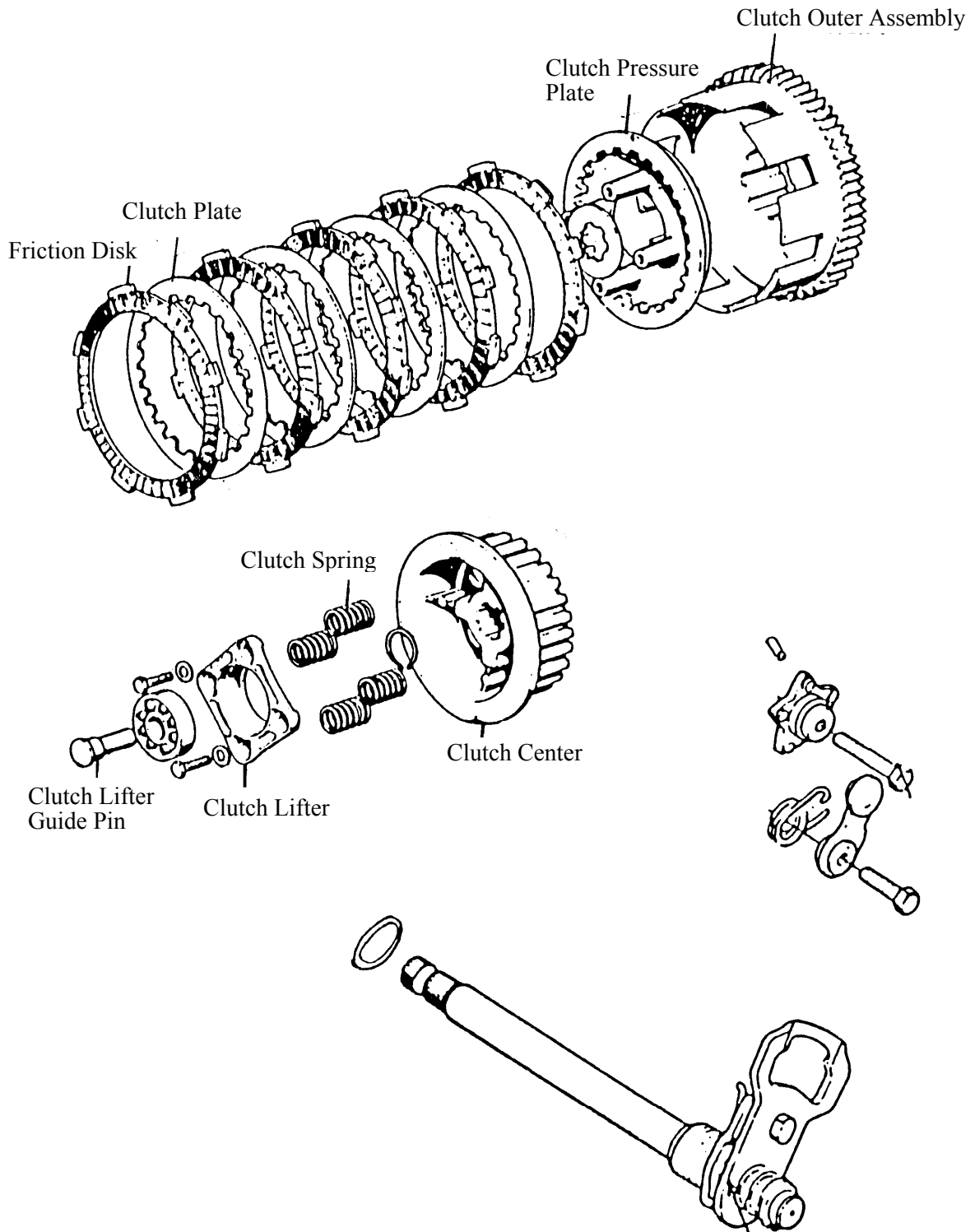

9

9. CLUTCH/GEAR SHIFT MECHANISM

SERVICE INFORMATION	9-1
TROUBLESHOOTING	9-2
RIGHT CRANKCASE COVER REMOVAL	9-3
CLUTCH REMOVAL	9-3
RIGHT CRANKCASE COVER INSTALLATION	9-9

SERVICE INFORMATION

GENERAL INSTRUCTIONS

- The clutch and gear shift mechanism can be serviced in the frame.
- Install the clutch plates in the same chamfer direction.
- Install the thrust washer with the chamfer facing up and the flat facing down.

SPECIFICATIONS

Item		Standard (mm)	Service Limit (mm)
Clutch spring free length		35.5	34.2
Clutch friction disk thickness		2.8~2.9	2.5
Clutch plate bending		0~0.1	0.2
Clutch outer I.D.		111~111.5	112.5
Clutch outer guide	O.D.	29.70~29.85	29.66
	I.D.	30.0~30.021	30.40

TORQUE VALUES

Clutch center lock bolt 0.8~1.2kg-m

SPECIAL TOOLS

Universal holder 5008405

Pliers (open)

9. CLUTCH/GEAR SHIFT MECHANISM

TROUBLESHOOTING

Clutch slips during acceleration

- No free play
- Worn friction disk
- Weak spring

Clutch won't operate

- Excessive free play
- Bent clutch plate

Improper shifting

- Excessive clutch lever free play
- Bent gear shift spindle
- Worn or deformed gear shift plate
- Damaged transmission drum grooves
- Faulty gear shift cam stopper

Clutch won't operate; motorcycle moves slowly

- Excessive free play
- Bent clutch plate

Too much pressure on clutch lever

- Kinked, twisted or damaged clutch cable
- Damaged clutch lifter

Clutch does not operate smoothly

- Improper clutch outer groove machining

Gear tripping

- Faulty gear shift cam stopper
- Bent gear shift spindle
- Worn gear teeth

9. CLUTCH/GEAR SHIFT MECHANISM

RIGHT CRANKCASE COVER REMOVAL

Drain the engine oil.
Remove the kick lever.
Disconnect the clutch cable.
Remove the right crankcase cover attaching bolts and right crankcase cover.
Remove the clutch lever and bearing.

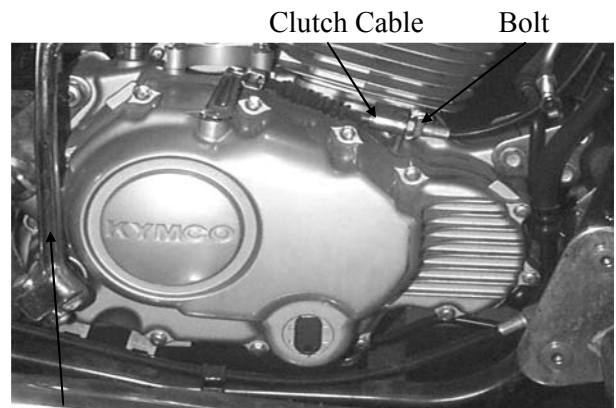

Kick Lever

Remove the oil filter rotor cover. (Refer to 3-3.)
Remove the square nut.
Remove the square nut(left hand threads) on the balance shaft driven gear.
Remove the oil filter rotor.

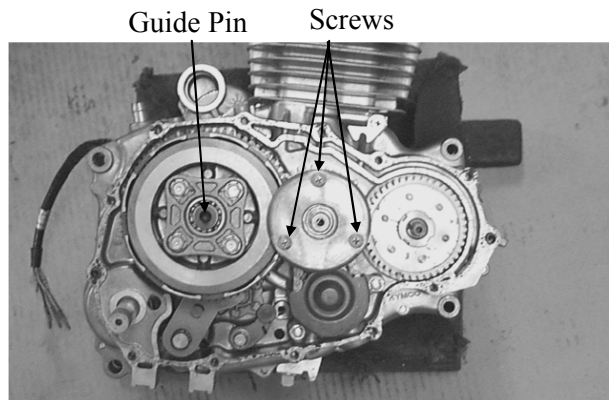

Clutch

Remove the oil pump gear cover.
Remove the 6mm nut on top of the oil pump driven gear.
Remove the oil pump driven gear and chain.
Remove the oil pump drive gear and clutch outer drive gear from the crankshaft.

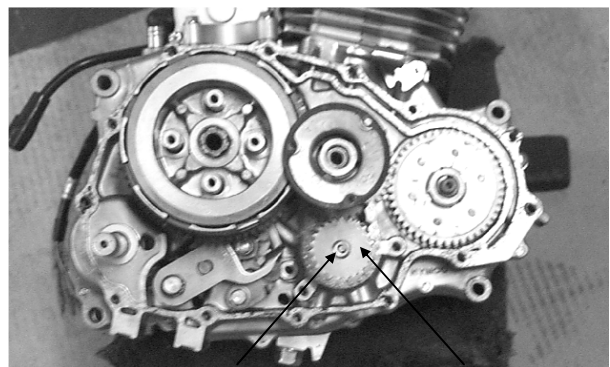

Nut

Driven Gear

CLUTCH REMOVAL

Remove the four clutch lifter bolts.
Remove the clutch lifter and four tension springs.

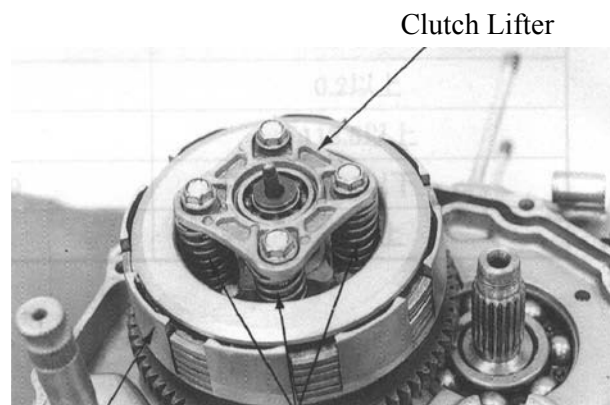

Clutch

Tension Springs

9. CLUTCH/GEAR SHIFT MECHANISM

Remove the 20mm circlip using a pair of pliers and then remove the clutch center, clutch friction disks and plates.

- * When removing the circlip, do not expand it excessively to avoid deformation.
- * Install the circlip with the chamfered side facing down.

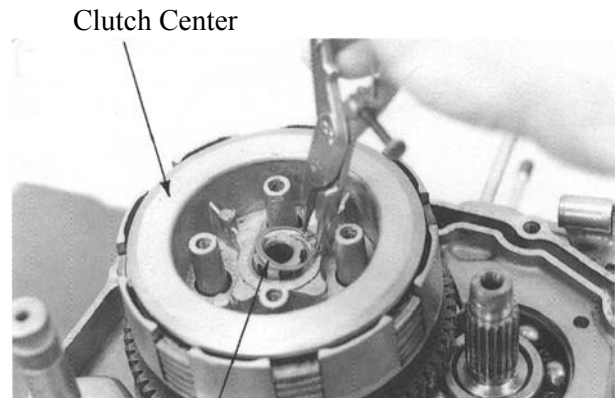

20mm Circlip

Remove the balance shaft drive gear and woodruff key from the crankshaft. Remove the special flange gasket on the balance shaft driven gear, driven gear and woodruff key from the balance shaft. Remove the oil pump shaft.

- * Be careful not to drop or lose the woodruff keys.

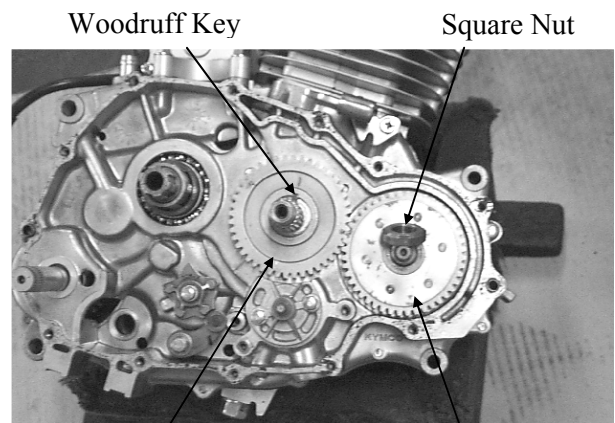

Woodruff Key

Square Nut

Drive Gear

Driven Gear

Remove the thrust washer, clutch outer and outer guide.

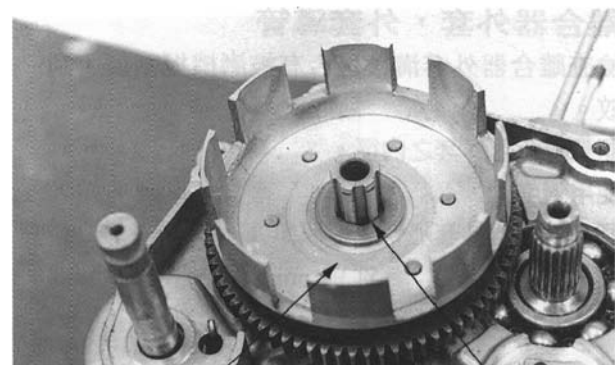

Clutch Outer

Thrust Washer

INSPECTION

CLUTCH TENSION SPRING

Measure each clutch tension spring free length.

Service Limit: 34.20mm

Replace the spring with a new one if it is shorter than the service limit.

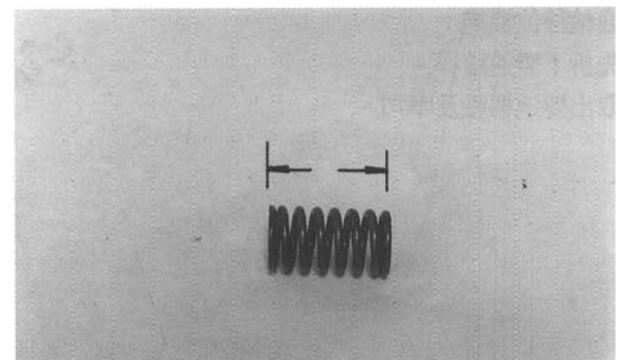

9. CLUTCH/GEAR SHIFT MECHANISM

CLUTCH FRICTION DISK

Measure each clutch friction disk thickness.

Service Limit: 2.5mm

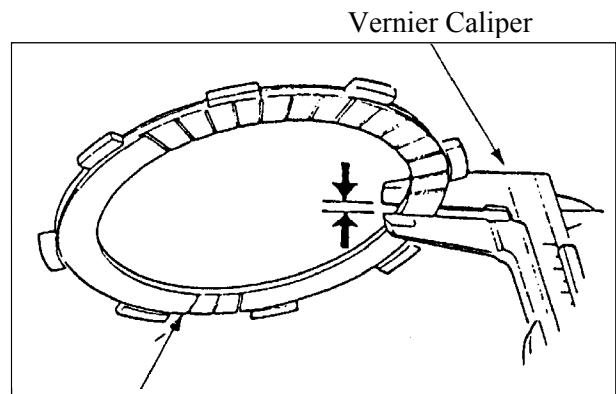

Clutch Friction Disk

CLUTCH PLATE

Measure each clutch plate bending using a feeler gauge.

Service Limit: 0.20mm

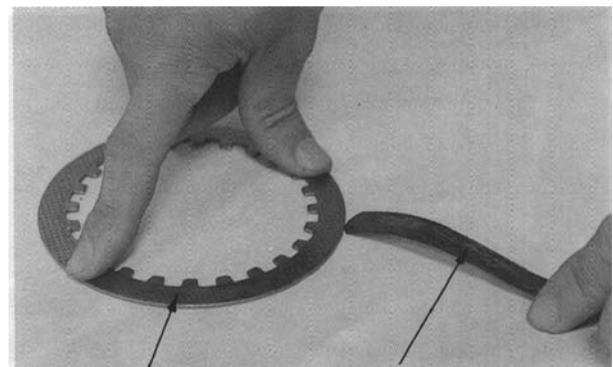

Clutch Plate

Feeler Gauge

CLUTCH OUTER/OUTER GUIDE

Inspect the clutch outer groove for scratches caused by the friction disks.

Measure the clutch outer I.D.

Service Limit: 112.5mm

Measure the clutch outer guide I.D. and O.D.

Service Limits: I.D. : 30.40mm

O.D.: 29.66mm

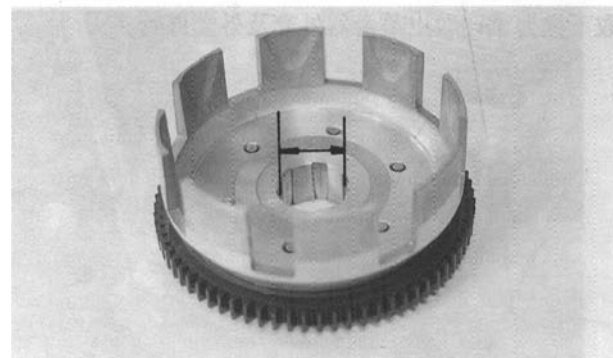

GEAR SHIFT MECHANISM

Remove the gear shift pedal.

Remove the gear shift spindle and washer.

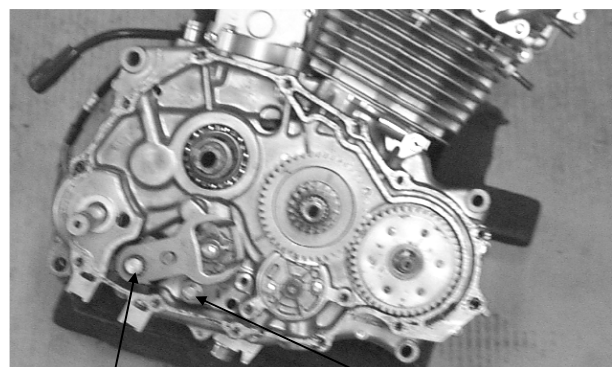

Gear Shift Spindle

Stopper

9. CLUTCH/GEAR SHIFT MECHANISM

Remove the stopper and spring.
Remove the gear shift cam bolt.
Remove the gear shift cam and set pin.

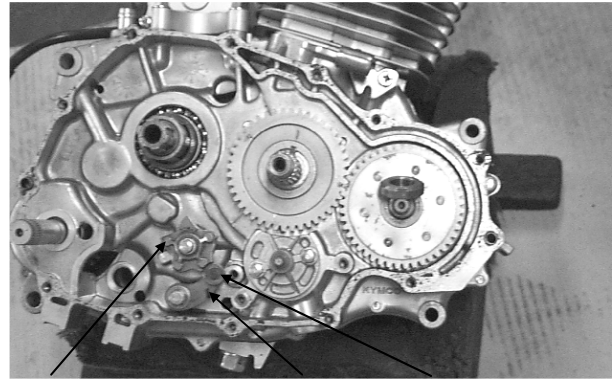

Gear Shift Cam Spring Stopper

Inspection

Inspect the gear shift cam stopper for wear or looseness and replace if necessary.

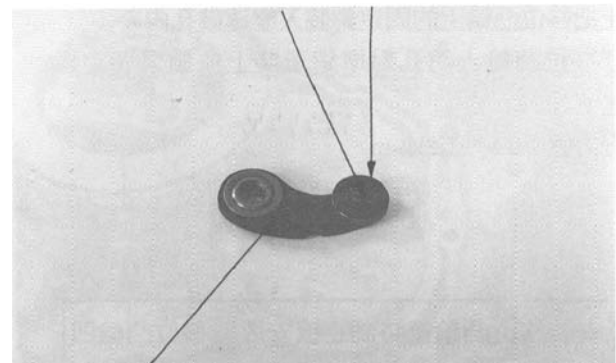

Stopper

Check the gear shift plate for wear or deformation and replace if necessary.

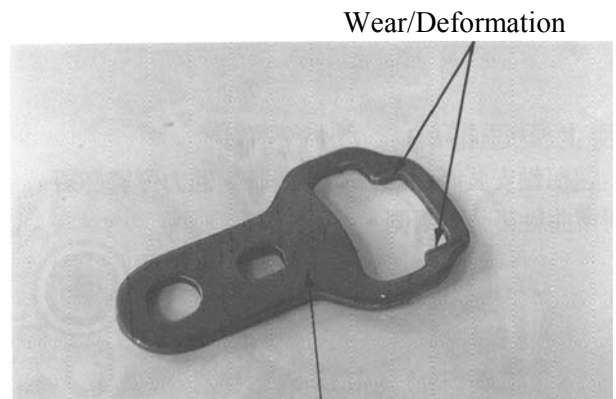

Gear Shift Plate

Inspect the corners of the gear shift cam for wear or damage. Replace the cam if the corners are rounded.

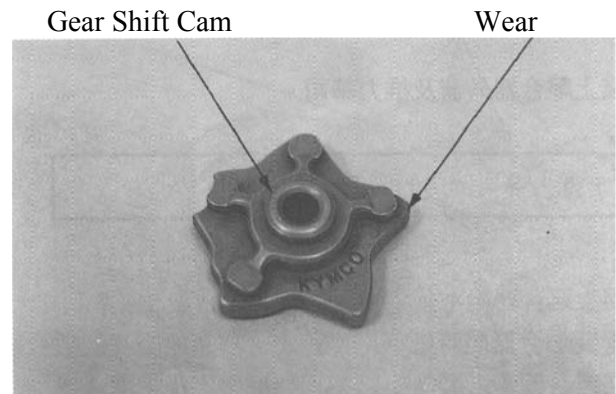

9. CLUTCH/GEAR SHIFT MECHANISM

Installation

Install the gear shift cam stopper and spring.
Tighten the 6mm lock bolt.

Torque: 0.8~1.2kg-m

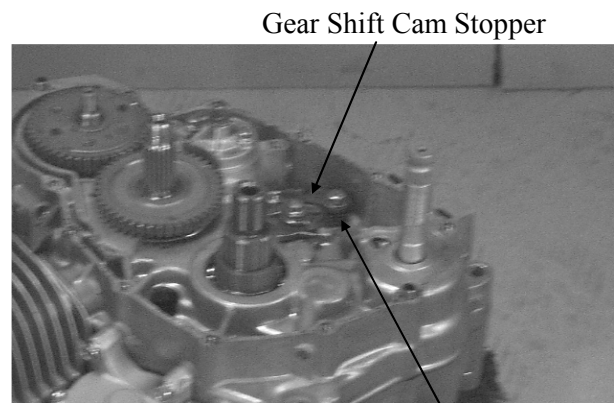

Spring

Install the set pin into the transmission drum hole.

Install the gear shift cam, aligning the pin hole in the gear shift cam with the set pin.
Then, tighten the bolt.

Torque: 0.8~1.2kg-m

- * After the gear shift cam is installed, put the stopper in the gear shift cam groove and tighten the stopper bolt.
- * Rotate the transmission drum to make sure that the stopper operates properly.

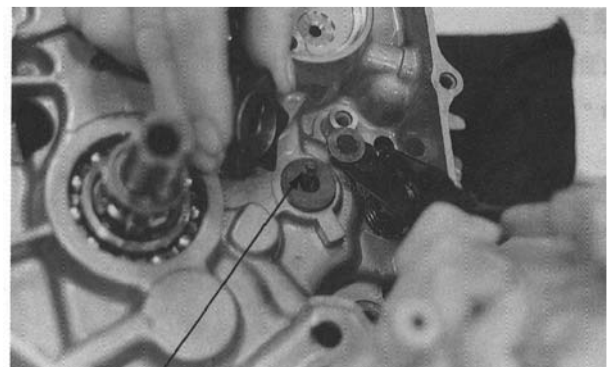

Set pin

Install the gear shift spindle and washer.
During installation, make sure that the return spring aligns with the crankcase tab.

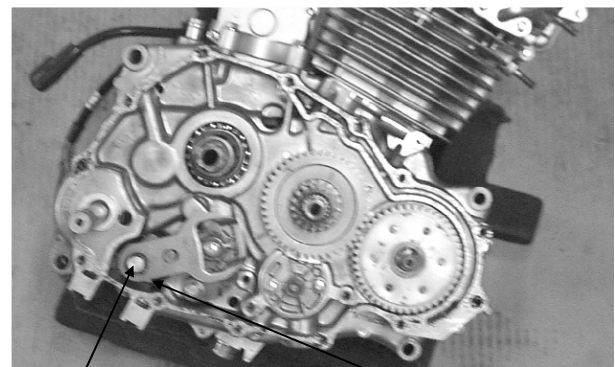

Gear Shift Spindle

Return Spring

Install the oil pump body and insert the pump shaft.

Install the balance shaft drive gear and woodruff key onto the crankshaft.

Install the balance shaft driven gear and woodruff key onto the balance shaft.

- * Be sure to align the punch marks on the drive and driven gears before installing the woodruff key onto the balance shaft.

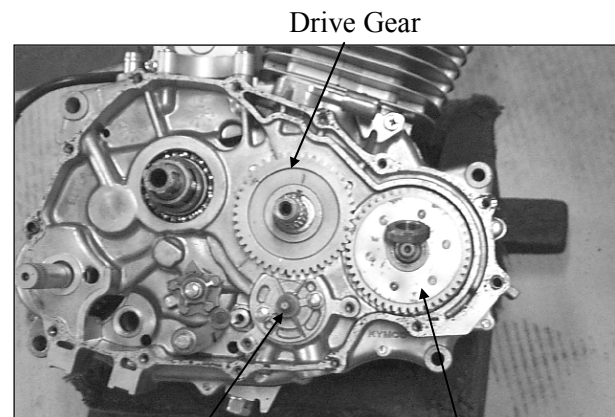

Pump Shaft

Driven Gear

9. CLUTCH/GEAR SHIFT MECHANISM

Install the clutch outer drive gear onto the crankshaft.
Install the oil pump drive gear onto the crankshaft.
Install oil pump driven gear and chain.

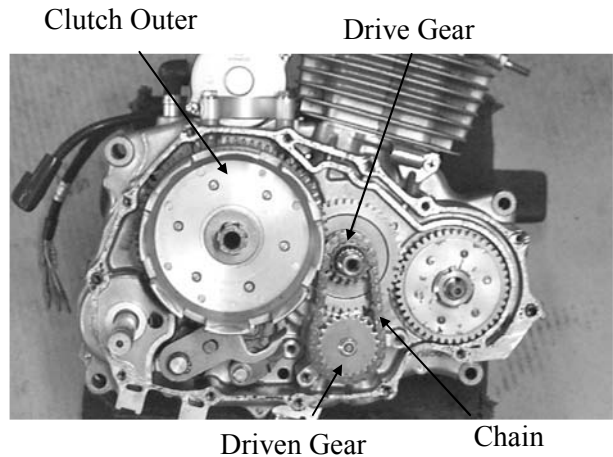

Install the clutch outer and thrust washer.

- * Install the thrust washer with the chamfered side facing up.

Install the oil pump chain and driven gear and secure it with the 6mm nut.
Install the clutch assembly.
Stagger the clutch friction disks and clutch plates and then put them on the clutch center.
Then install the clutch center together with the well-arranged friction disks and plates into the clutch outer.

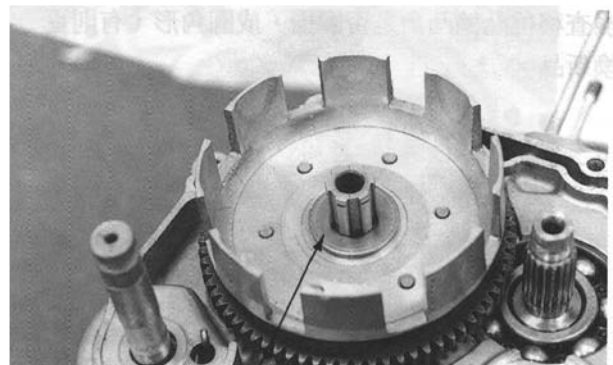

Install the circlip.

- * Install the circlip with the chamfered side facing down.

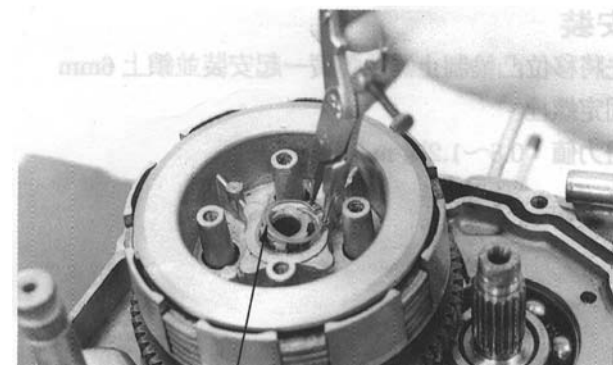

Install the tension springs and clutch lifter.
Install the washers to the bolts and tighten the four bolts.

Torque: 0.8~1.2kg-m
Install the clutch lifter guide pin.

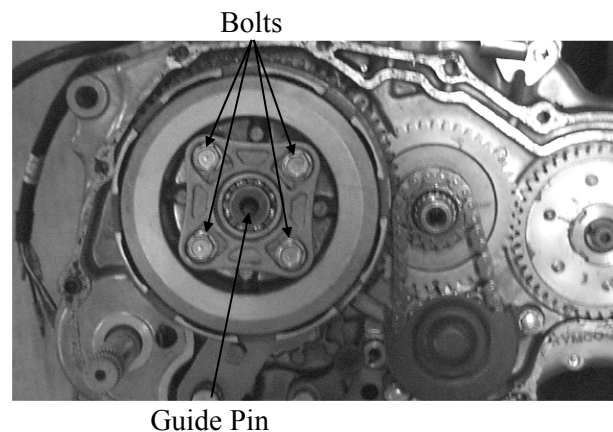

9. CLUTCH/GEAR SHIFT MECHANISM

Install the oil filter rotor.
Install the washer and tighten the square nut.
Torque: 4.0~5.0kg-m

- * Install the washer with the mark "OUTSIDE" facing up.

Install the special flange gasket onto the balance shaft driven gear with the flange facing down and then loosely install the square nut (left hand threads).
Tighten the square nut using the square socket.

Install the oil filter rotor cover.
Check the gasket for wear or damage and replace if necessary.
Install and tighten the three oil filter rotor cover screws.

Torque: 0.3~0.4kg-m

Install the oil pump gear cover and tighten the two bolts.

RIGHT CRANKCASE COVER INSTALLATION

First install the dowel pins and then install the gasket.
Install the right crankcase cover and tighten the cover bolts.

Torque: 0.8~1.2kg-m

- * Tighten the right crankcase cover bolts diagonally.

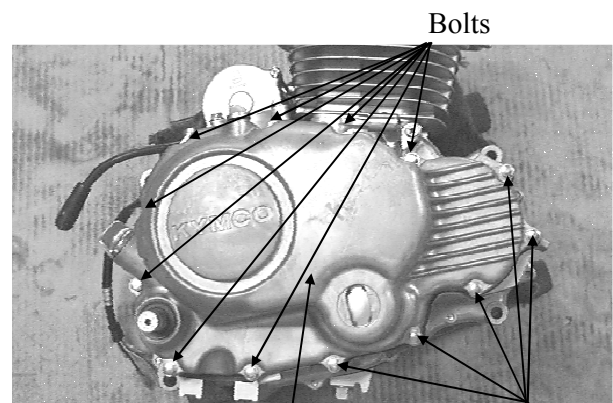
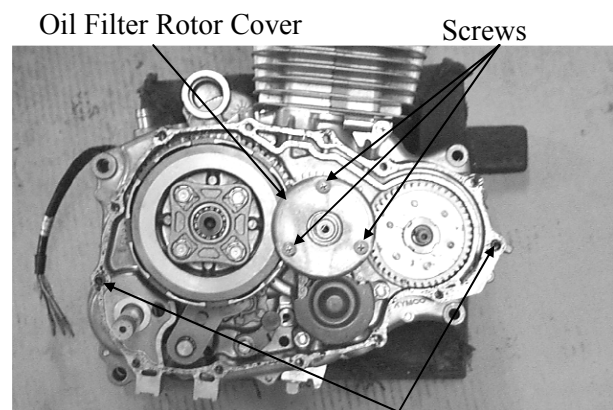
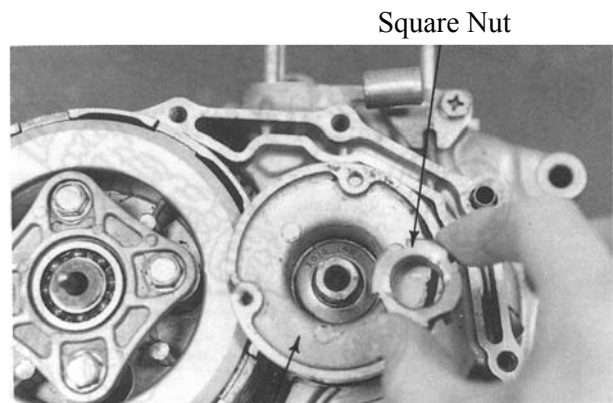

11. FRONT WHEEL/SUSPENSION/ STEERING

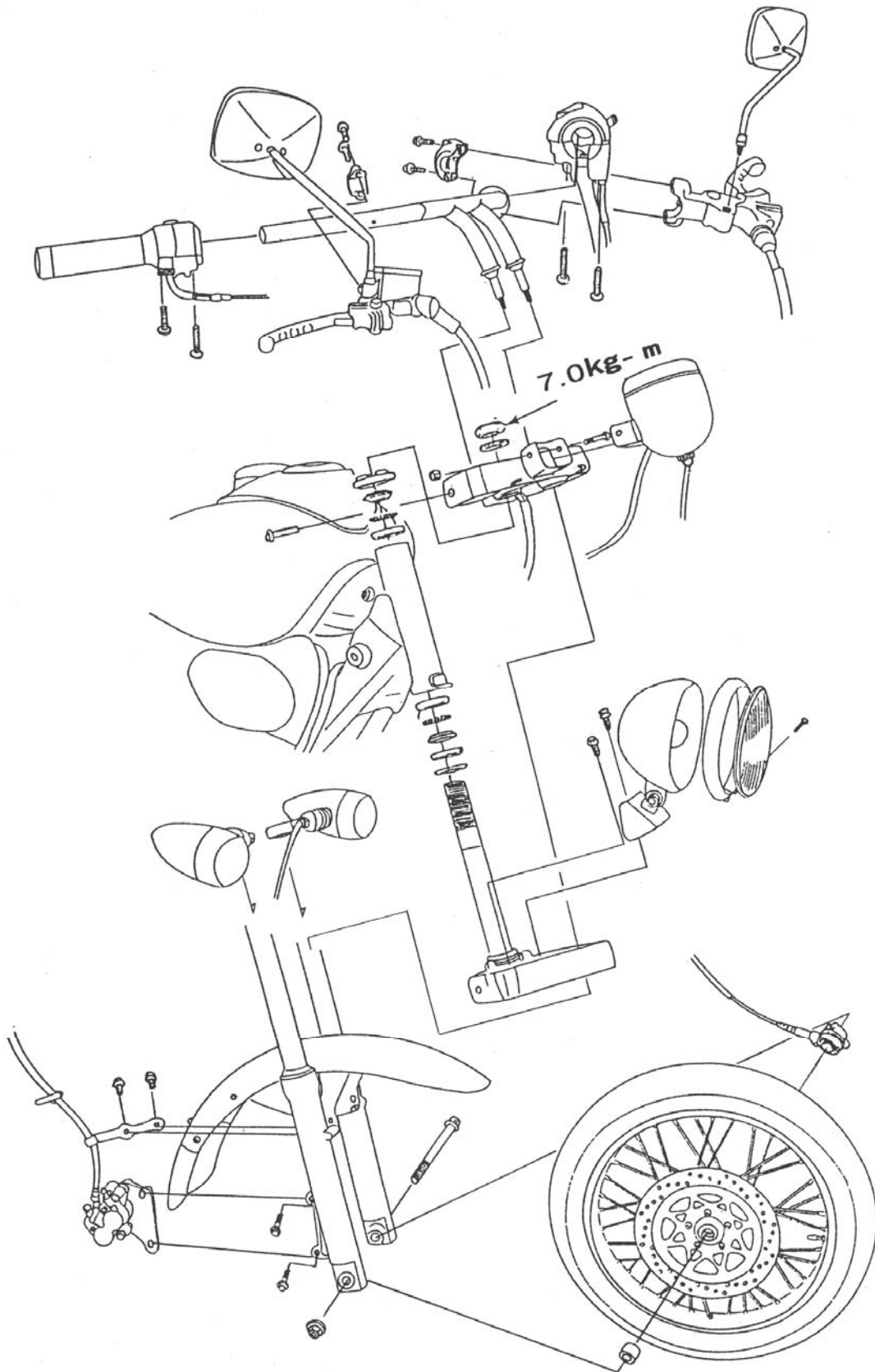

11

11. FRONT WHEEL/SUSPENSION/ STEERING

SERVICE INFORMATION.....	11-1	FRONT WHEEL.....	11- 6
TROUBLESHOOTING.....	11-2	FRONT FORK.....	11-10
HANDLEBAR.....	11-3	STEERING STEM.....	11-14

SERVICE INFORMATION

GENERAL INSTRUCTIONS

SPECIFICATIONS

Item		Standard (mm)	Service Limit (mm)
Front axle shaft runout		—	0.2
Front wheel rim runout	Axial	0.5	2.0
	Radial	0.5	2.0
Front fork spring free length			
Front fork tube runout		—	0.2
Front fork oil capacity			—

TORQUE VALUES

Steering stem nut	6.0~9.0kg-m	Front axle nut	5.5kg-m
Upper fork bridge bolt	0.9~1.3kg-m	Front fork upper mount bolt	2.7kg-m
Master cylinder holder bolt	1.0kg-m	Front fork lower mount bolt	2.3kg-m
Front brake disk nut	1.5kg-m		

SPECIAL TOOLS

Steering stem driver	
Steering stem wrench	5008422
Ball race remover	
Bearing remover	
Bearing remover head, 12m	5008416-03
Bearing remover head, 17m	
Bearing driver handle	
Attachment, 32x35mm	
Attachment, 32x35mm	
Attachment, 37x40mm	
Fork seal driver	
Pilot, 17mm	

11. FRONT WHEEL/SUSPENSION/ STEERING

TROUBLESHOOTING

Hard steering

- Insufficient tire pressure
- Excessively tightened steering stem nut
- Damaged steering stem bearings
- Damaged steering bearing races

Steers to one side or does not track straight

- Uneven front shock absorbers
- Bent front fork
- Bent front axle or uneven tire

Front wheel wobbling

- Improperly tightened axle nut
- Bent rim
- Worn front wheel bearing
- Faulty tire

Soft suspension

- Weak fork springs
- Insufficient front fork oil

Hard suspension

- Incorrect front fork oil level
- Bent front fork tube
- Clogged front fork oil passages

Front suspension noise

- Slider bending
- Loose front fork fasteners
- Insufficient front fork oil
- Worn front fork bearing
- Insufficient speedometer gear grease

11. FRONT WHEEL/SUSPENSION/ STEERING

HANDLEBAR

REMOVAL

Remove the two throttle cover screws and the throttle cover.

Throttle Cover

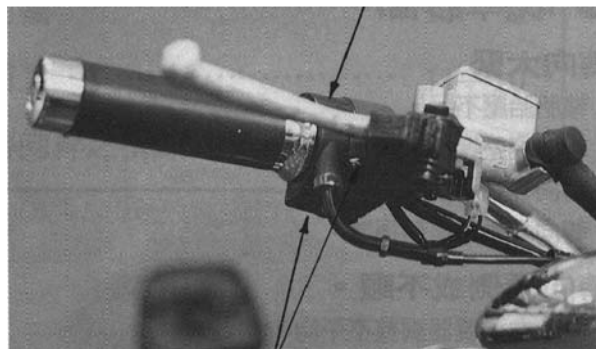

Screws

Disconnect the throttle cable from the throttle grip and then remove the throttle pipe from the handlebar.

Throttle Pipe

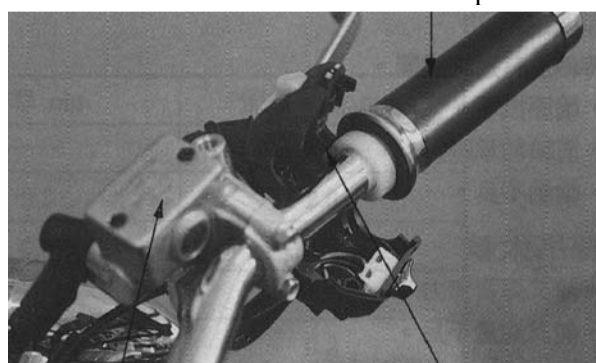

Master Cylinder

Throttle Cable

Remove the two master cylinder holder bolts and the master cylinder.

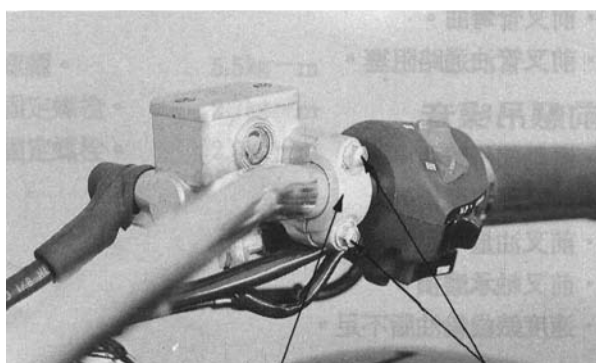

Holder

Bolts

Remove the two left handlebar switch housing screws, then separate and remove the housing.
Remove the two clutch lever holder bolts and the clutch lever holder.

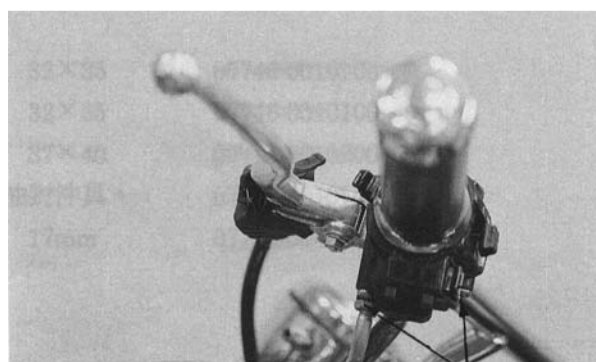

Screws

11. FRONT WHEEL/SUSPENSION/ STEERING

Remove the two handlebar lock nuts to remove the handlebar.

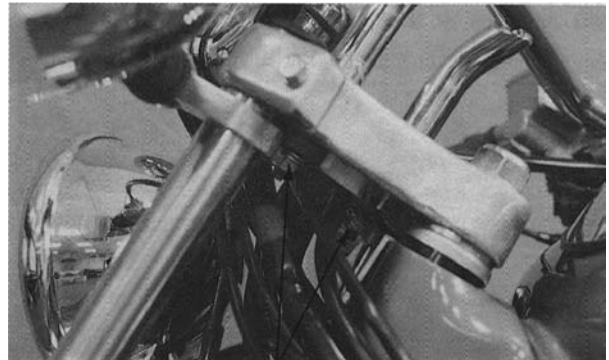

Lock Nuts

INSTALLATION

Install the handlebar in the reverse order of removal.

Torque: 0.8~1.2kg-m

When installing the right and left handlebar switch housings, align the pin on the housing with the hole in the handlebar. Tighten the two switch housing screws.

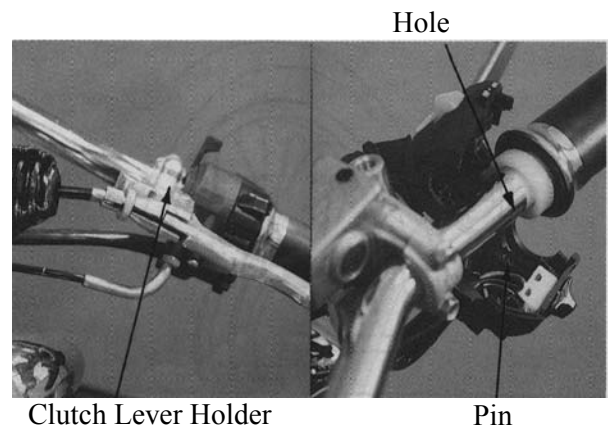

Clutch Lever Holder

Pin

When installing the master cylinder and clutch lever holders, align the tab on the holder with the hole in the handlebar with the holder "UP" mark facing up. First tighten the upper bolt and then the lower bolt.

Torque: 1.0~1.4kg-m

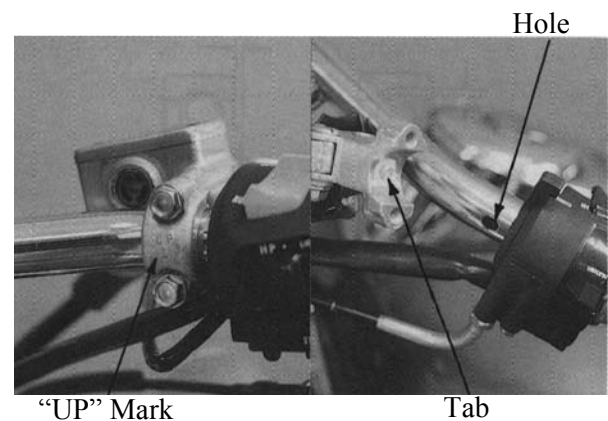

"UP" Mark

Tab

11. FRONT WHEEL/SUSPENSION/ STEERING

THROTTLE PIPE INSTALLATION

Clean the handlebar surface and install the throttle pipe. Check the throttle grip for proper operation.

Clean Surface

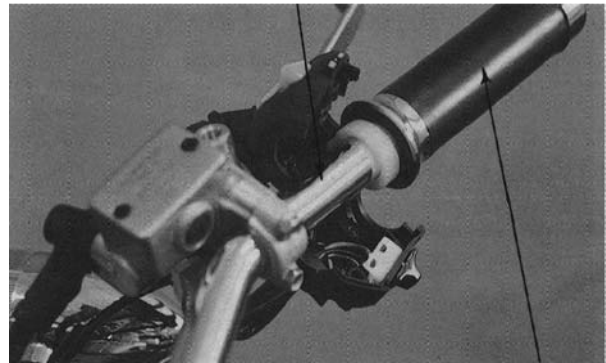

Throttle Pipe

Connect the throttle cable to the throttle grip. Apply grease to the throttle cable. Install the throttle cover by aligning the pin on the cover with the hole in the handlebar and then tighten the two screws.

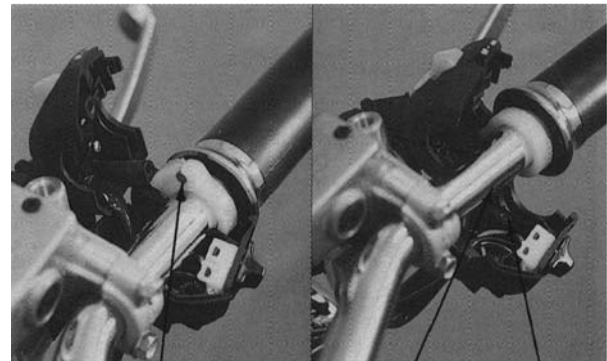

Throttle Cable

Hole

Pin

11. FRONT WHEEL/SUSPENSION/ STEERING

FRONT WHEEL

REMOVAL

Place a jack or other adjustable support under the engine to raise the front wheel off the ground.

Remove the speedometer cable set screw and disconnect the speedometer cable.

Remove the front axle nut and pull out the axle.

Remove the front wheel.

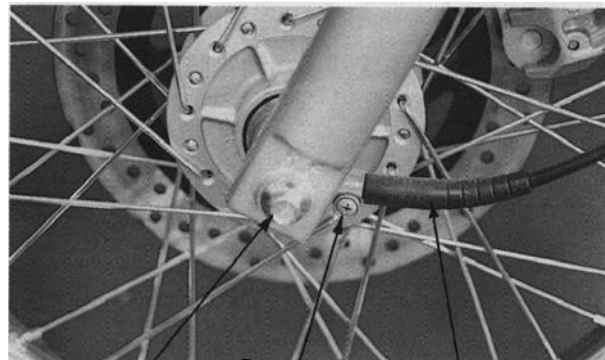

Axle Nut Screw Speedometer Cable

INSPECTION

Set the axle in V blocks and measure the runout using a dial gauge.

Service Limit: 0.2mm replace if over

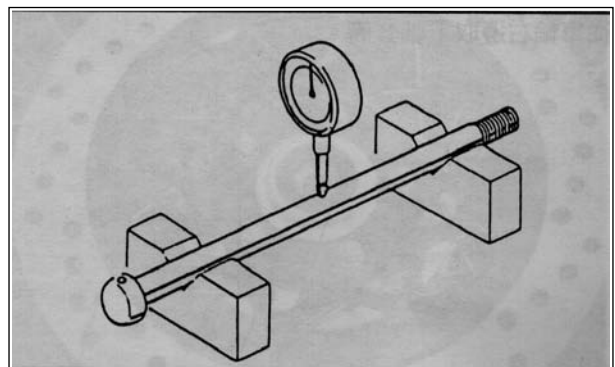

WHEEL RIM INSPECTION

Place the front wheel in a turning stand. Spin the wheel by hand and measure the rim runout using a dial gauge.

Service Limits:

Axial: 2.0mm adjust if over

Radial: 2.0mm adjust if over

Check the wheel spoke wires for looseness. If the wheel rim is made of aluminum alloy, replace with a new one if necessary.

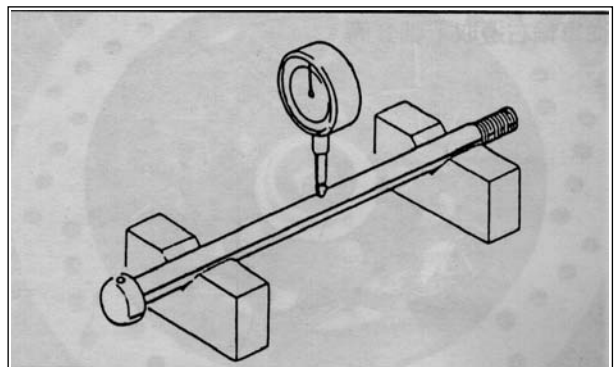

Check the wheel bearing play by placing the wheel in a turning stand and spinning the wheel by hand.

Replace the bearings if they are noisy or have excessive play.

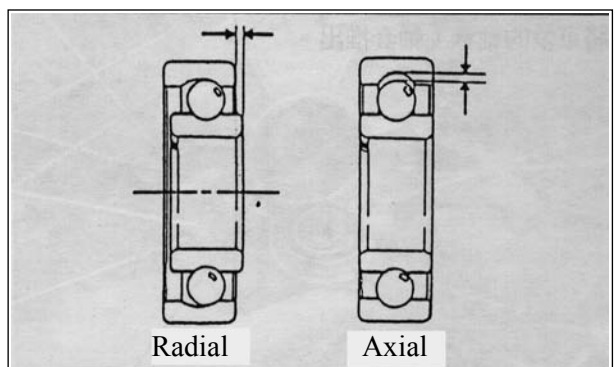

11. FRONT WHEEL/SUSPENSION/ STEERING

DISASSEMBLY

Remove the speedometer gearbox and dust seal from the left side of the wheel.

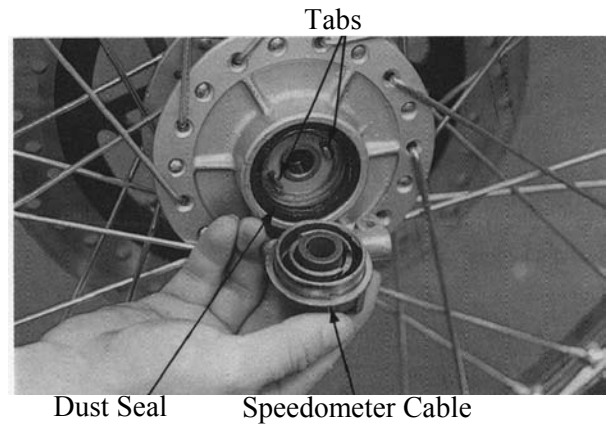

Remove the axle collar from the right side of the wheel.

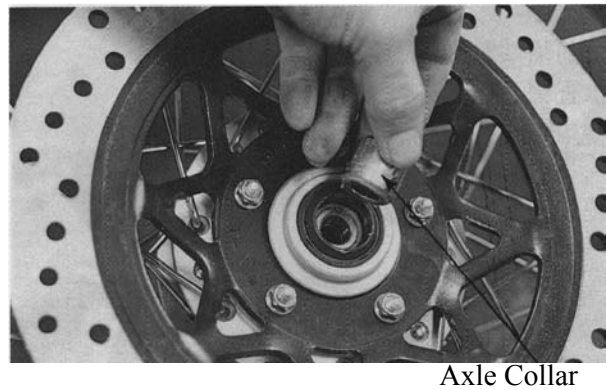

Remove the dust seal.
Remove the five nuts and the brake disk.

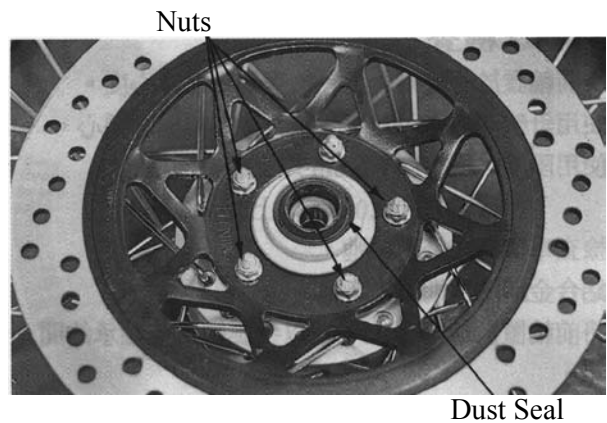

Drive out the wheel bearings and distance collar.



11. FRONT WHEEL/SUSPENSION/ STEERING

ASSEMBLY

Pack all bearing cavities with grease. First drive in the right bearing and then install the distance collar. Finally, drive in the left bearing.

Bearing Driver Handle



Attachment, 37x40mm

Install the brake disk and tighten the five nuts.
Apply grease to the dust seal and install the dust seal.

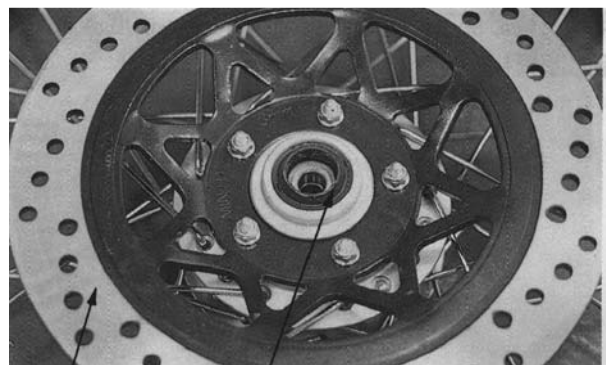

Brake Disk

Dust Seal

Install the speedometer gearbox by aligning the tabs with the grooves.

Tabs

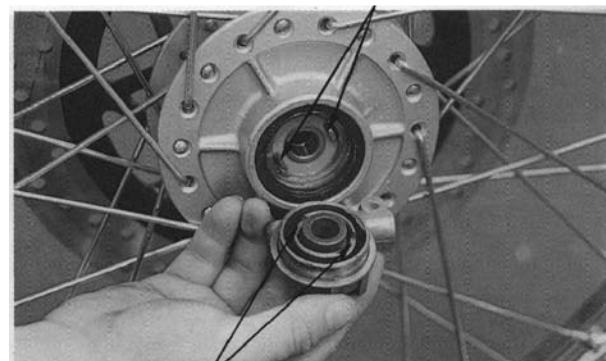

Grooves

Apply grease to the speedometer gearbox and dust seal, then install them to the wheel from the left side.

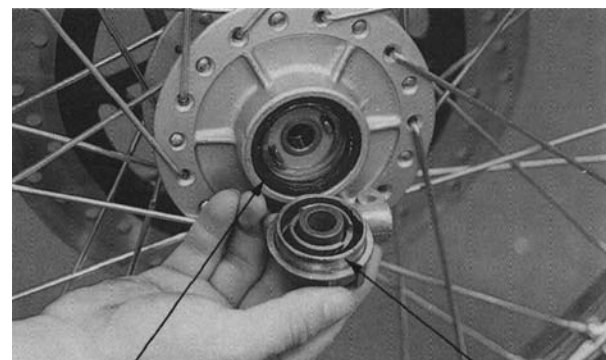

Dust Seal

Speedometer Cable

11. FRONT WHEEL/SUSPENSION/ STEERING

Install the axle collar to the right side of the wheel.

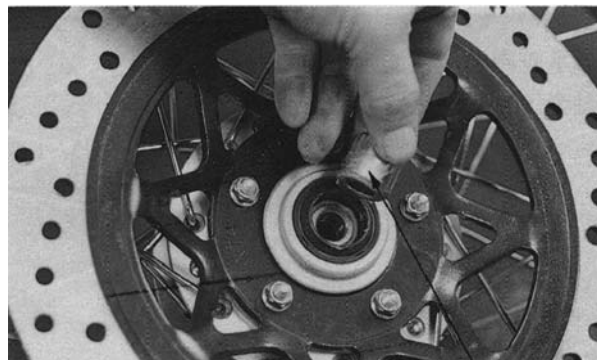

Axle Collar

INSTALLATION

Install the front wheel onto the front fork, aligning the tab on the front fork with the groove in the speedometer gearbox.

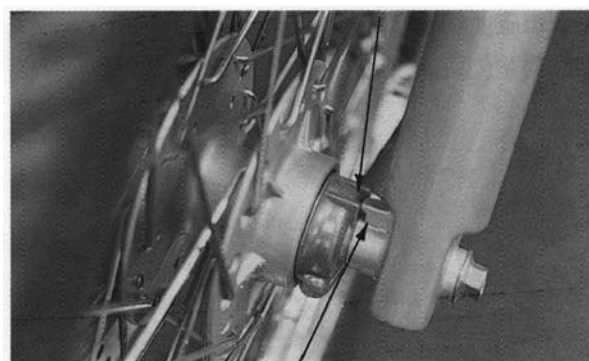

Groove

Tab

Insert the axle shaft and tighten the axle nut.

Torque: 5.5~7.0kg-m

Connect the speedometer cable and secure it with the screw.

*

Install the speedometer cable by aligning the groove with the tab.
--

Front Axle Nut

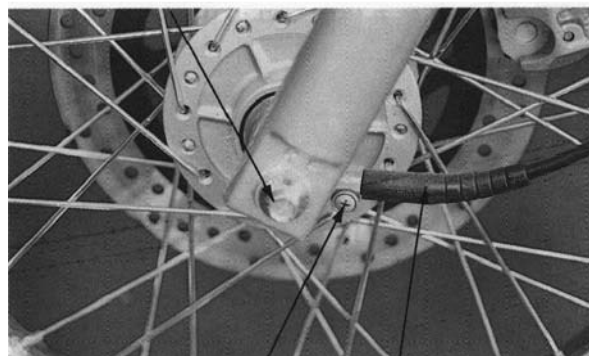

Screw

Speedometer Cable

11. FRONT WHEEL/SUSPENSION/ STEERING

FRONT FORK

REMOVAL

Remove the front wheel. (Refer to 11-6.)
Remove the four front fender bolts and the front fender.
Remove the front brake caliper.
Loosen the upper and lower fork bridge bolts and the bolts attaching the front right and left turn signal lights.
Remove the right and left front forks.

DISASSEMBLY

Place shop towels under the front fork tube.
Use a vise to hold the front fork tube and remove the bolt.

* When removing the front fork bolt, be careful that the spring in the tube may spring out.

Remove the front fork spring from the front fork tube and compress the spring several times to squeeze out the engine oil.

Use a vise to hold the front fork bottom tube and place shop towels under the bottom tube.
Remove the socket head bolt.

*

- When using the vise, do not tighten the front fork bottom tube excessively.
- If it is difficult to remove the socket head bolt, temporarily install the front fork spring and front fork bolt.

Remove the front fork piston and return spring. Remove the front fork bottom tube and the oil stopper.

Upper Fork Bridge Bolts



Lower Fork Bridge Bolt

Front Fork Bolt

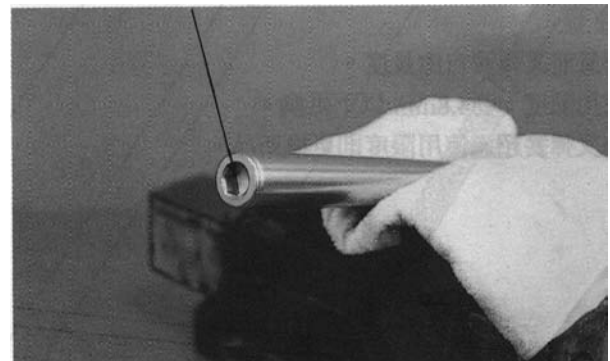

Front Fork Spring

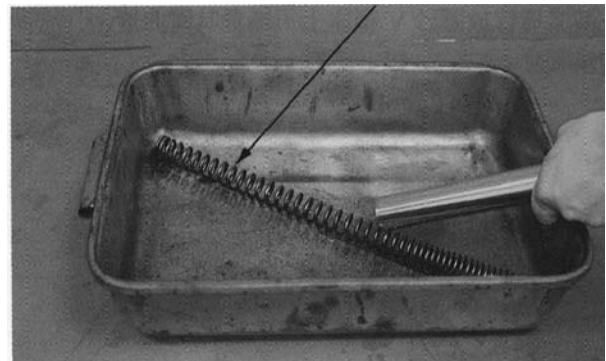

6mm Socket Spanner

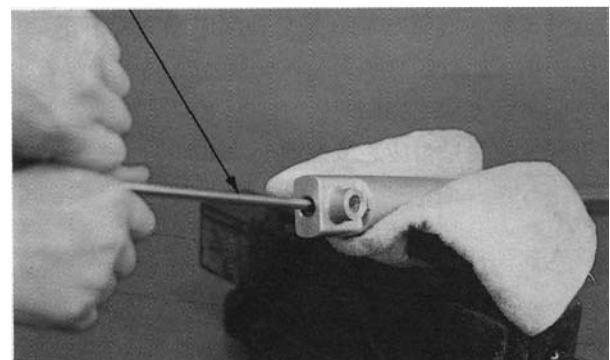

11. FRONT WHEEL/SUSPENSION/ STEERING

Remove the dust seal and snap ring. Take out the oil seal and circlip.

*

- Do not damage the bottom tube when taking out the oil seal and circlip.
- Be sure to replace the removed oil seal and circlip with new ones during assembly.

Oil Seal

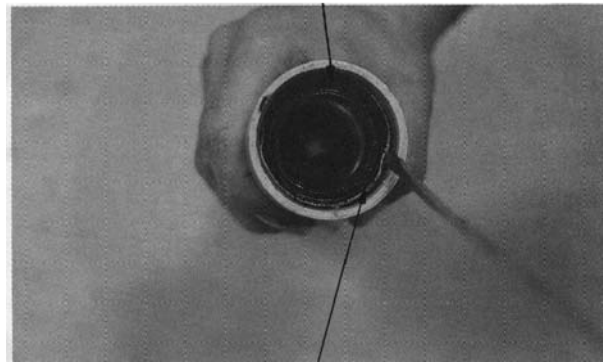

Snap Ring

INSPECTION

Measure the front fork spring free length.

Service Limit: 434.8mm replace if below

Replace the spring with a new one if it exceeds the service limit.

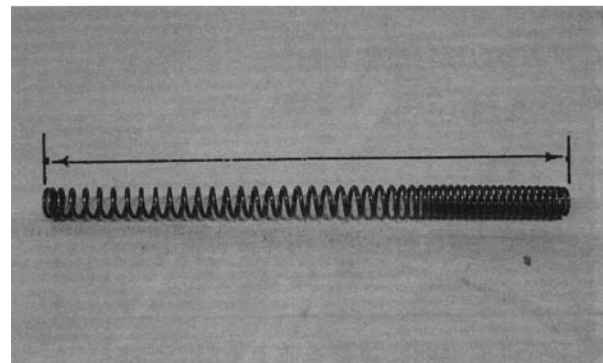

Set the front fork tube in V blocks and measure the tube runout.

Service Limit: 0.2mm replace if over

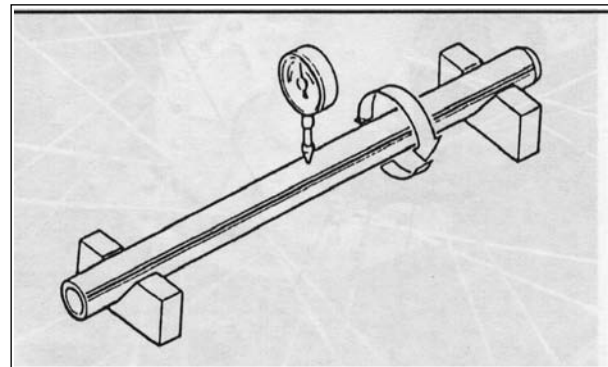

Check the front fork tube, bottom tube and piston for abnormal wear or damage and replace if necessary.

Check the front fork piston ring for wear.

Check the return spring for weakness or damage.

Front Fork Bottom Tube

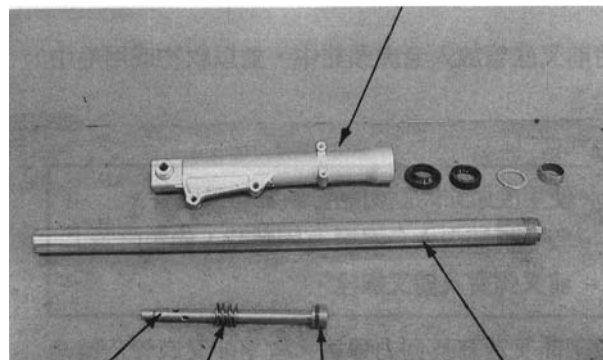

Piston Return Spring Piston Ring Front Fork Tube

11. FRONT WHEEL/SUSPENSION/ STEERING

ASSEMBLY

Before assembly, clean the removed parts with high flash or non-flammable solvent.

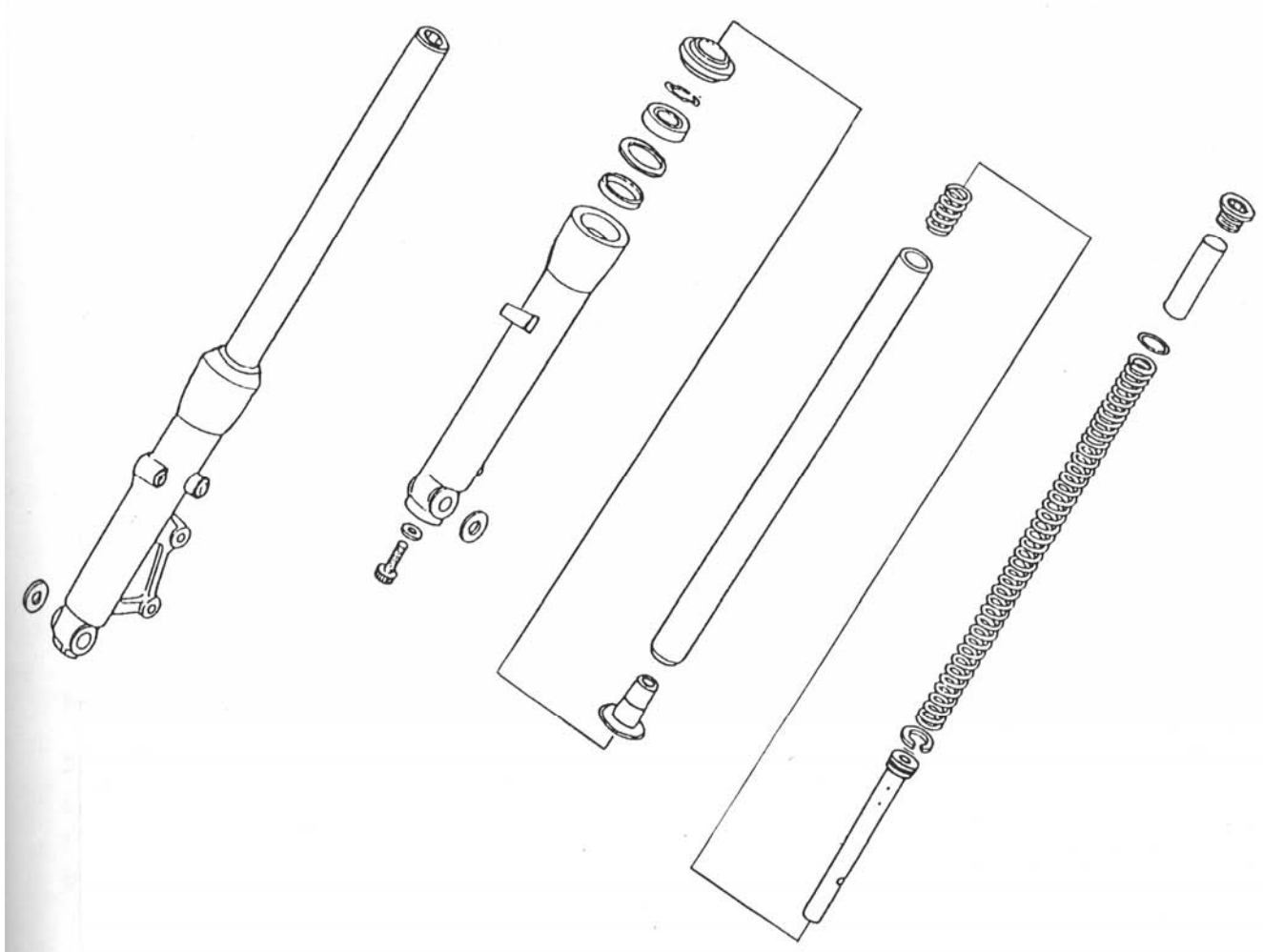

Install the return spring and piston into the front fork tube and then install oil stopper to the piston end. Install the front fork tube into the bottom tube.

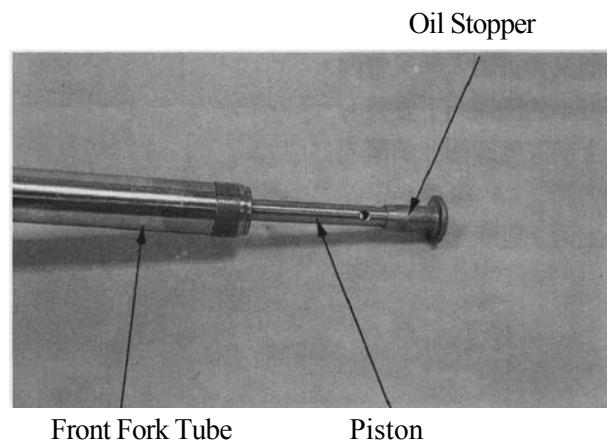

11. FRONT WHEEL/SUSPENSION/STEERING

Place shop towels under the bottom tube and set it in a vise. Apply locking agent to the socket head bolt and then install it into the piston. Tighten the socket head bolt using the socket spanner.

* When tightening the socket head bolt, temporarily install the front fork spring and front fork tube.

Torque: 1.5~2.5kg-m

6mm Socket Spanner

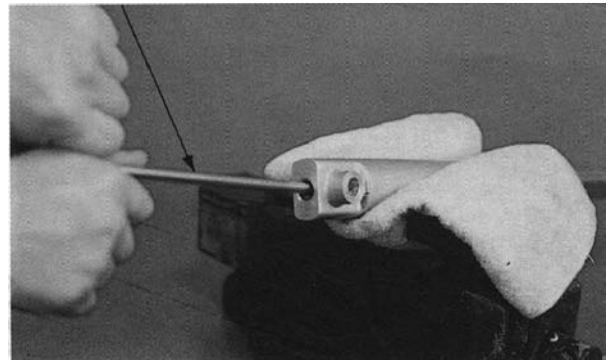

Apply engine oil to a new oil seal and install the oil seal using the fork seal driver. Then, install the snap ring and dust seal.

Fork Seal Driver Head

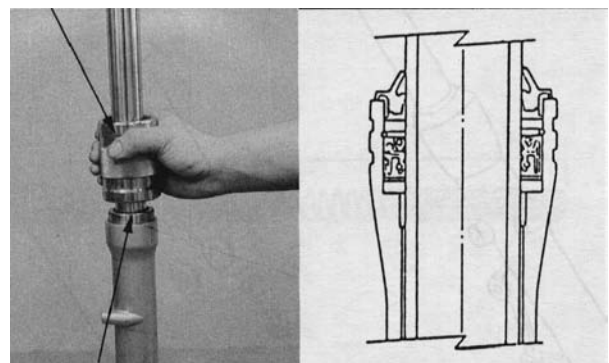

Fork Seal Driver

Fully compress the front fork and fill SAE8# engine oil into the front fork tube.

* Do not fill too much engine oil.

Specified Capacity: 158cc

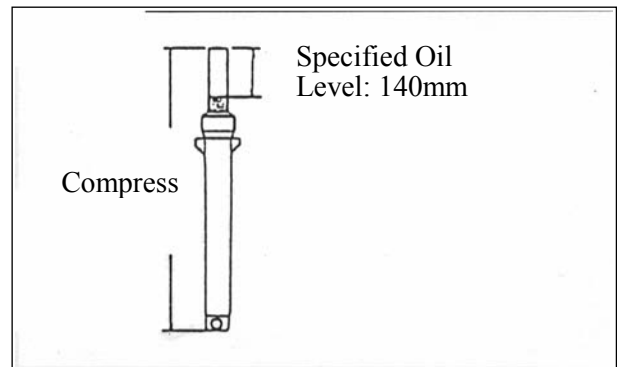

Install the front fork spring into the front fork tube with the closely wound coils facing down.

Install and tighten the front fork bolt.

Torque: 1.5~3.0kg-m

Install the front fork bolt rubber cover.

Front Fork Bolt

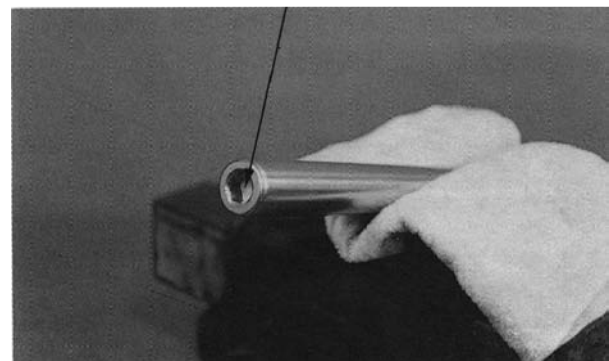

11. FRONT WHEEL/SUSPENSION/ STEERING

INSTALLATION

Install the front fork tubes into the upper and lower fork bridges and the front right and left turn signal light holders.

Install and tighten the attaching bolts.

Bolts

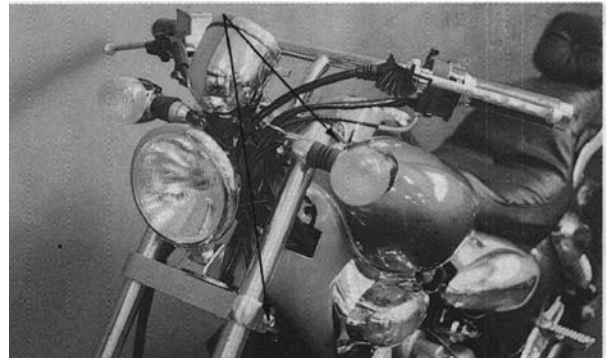

Front Fender Installation

Install the front fender between the front fork tubes, then install and tighten the four bolts.

Torque: 0.8~1.2kg-m

Front Fender

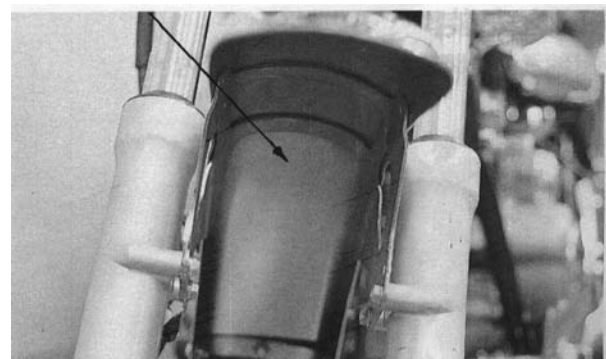

STEERING STEM

REMOVAL

Remove the handlebar. (Refer to 11-3.)

Remove the front fork tubes. (Refer to 11-10.)

Remove the steering stem nut using the lock nut wrench.

Lock Nut Wrench, 30x32mm

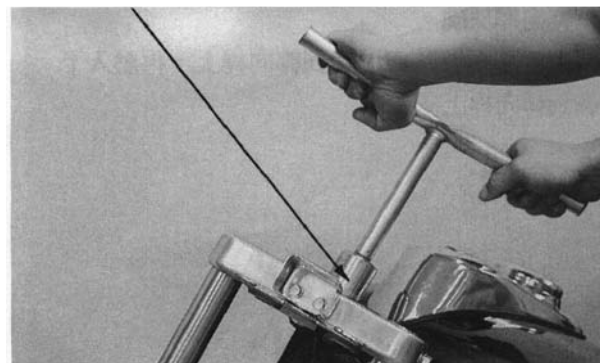

Remove the bearing adjusting nut, top cone race, steering stem and steel balls.

*

Place the steel balls in a parts tray so that they are not lost.



Steering Stem Wrench 5008422

11. FRONT WHEEL/SUSPENSION/ STEERING

Remove the top and bottom ball races.

Ball Race Remover

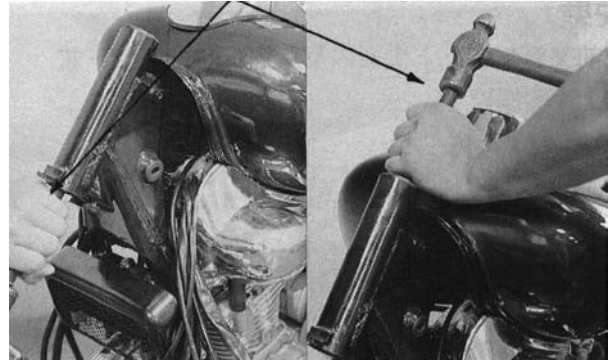

BALL RACE INSTALLATION

Drive the top and bottom ball races into the steering head using a bearing driver.

Bearing Driver Handle

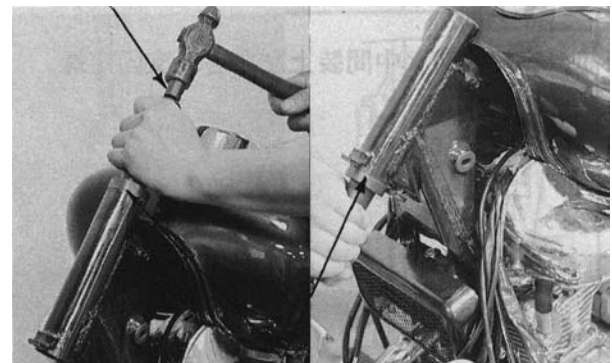

Attachment, 37x40mm

BOTTOM CONE RACE REPLACEMENT

Drive out the bottom cone race.
Install a new washer and dust seal onto the steering stem and then drive in a new bottom cone race onto the steering stem.

Attachment, 37x40mm

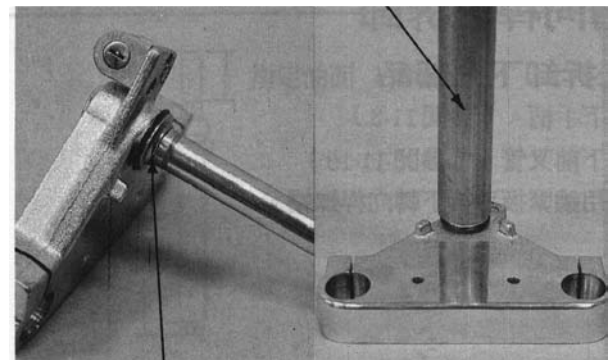

Bottom Cone Race

STEERING STEM INSTALLATION

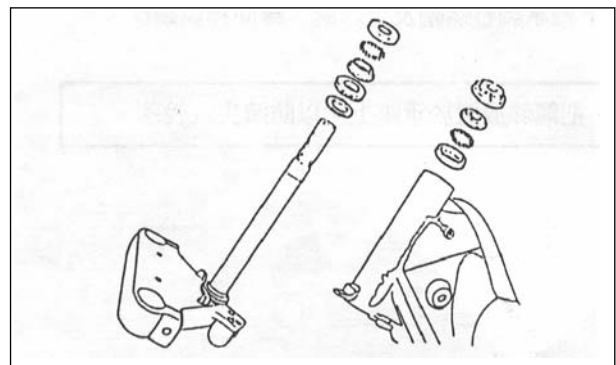

11. FRONT WHEEL/SUSPENSION/ STEERING

Apply grease to the top and bottom ball races and steel balls.
Install 21 steel balls each on the top and bottom ball races.
Install the steering stem into the steering pipe and then install the top cone race and the bearing adjusting nut.

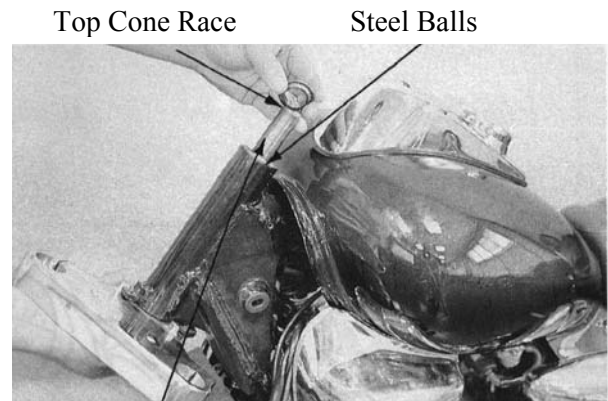

Steering Stem

Tighten the bearing adjusting nut until it seats against the top cone race, then turn it back 1/8 turn.

*

Check that the steering stem rotates freely and that there is no vertical play.

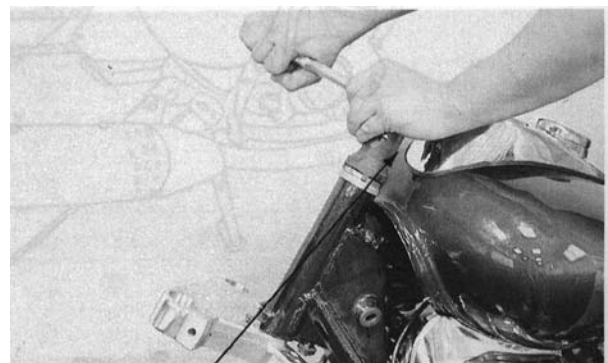

Steering Stem Wrench

Install the front fork. (Refer to 11-14.)
Install the top fork bridge, washer and steering stem nut.
Tighten the steering stem nut.

Torque: 6.0~9.0kg-m

Properly adjust the installed front fork.
(Refer to 11-14.)



Lock Nut Wrench, 30x32mm

12. REAR WHEEL/BRAKE/SUSPENSION

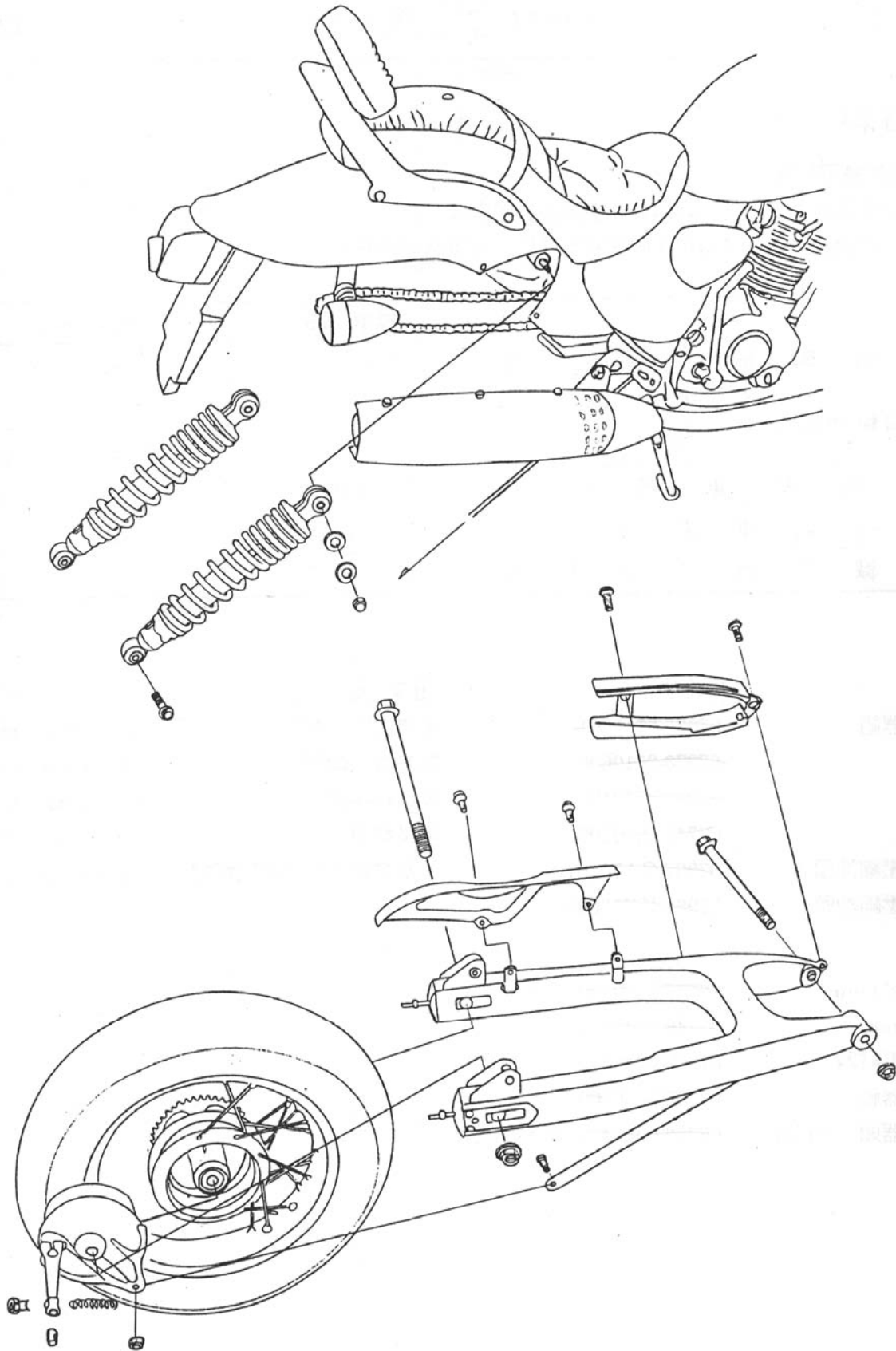

12

12. REAR WHEEL/BRAKE/SUSPENSION

SERVICE INFORMATION	12-1	REAR BRAKE	12-4
TROUBLESHOOTING	12-2	REAR SHOCK ABSORBER	12-8
REAR WHEEL	12-3	REAR FORK	12-9

SERVICE INFORMATION

GENERAL INSTRUCTIONS

- When installing the drive chain joint clip, the cutout of the clip should be opposite to the rotating direction.
- After the drive chain is adjusted, make sure that the rear brake pedal free play is normal and adjust it if necessary.

SPECIFICATIONS

Item	Standard (mm)	Service Limit (mm)
Rear axle shaft runout	—	0.2
Rear rim runout	Axial	2.0
	Radial	2.0
Rear brake drum I.D	130	131
Rear brake lining thickness	4.0	2.0
Rear shock absorber spring free length	—	—

TORQUE VALUES

Rear shock absorber upper mount nut	3.0~4.0kg-m
Rear shock absorber lower mount bolt	3.0~4.0kg-m
Rear axle nut	6.0~8.0kg-m
Rear fork pivot nut	5.5~6.5kg-m
Rear shock absorber damper nut	1.9~2.8kg-m

SPECIAL TOOLS

Bearing remover set	5008406-00-05
Pivot set	
Remover handle	
Block	
Rear shock absorber attachment A	
Rear shock absorber attachment Attachment, 42x47mm	
Pilot, 15mm	
Rear shock absorber compressor	5008411
Bearing remover	
Bearing remover, 15mm	5008416-05

12. REAR WHEEL/BRAKE/SUSPENSION

TROUBLESHOOTING

Rear wheel wobbling

- Bent rim
- Worn rear wheel bearing
- Loose or broken wheel spoke wires
- Faulty tire
- Improperly tightened axle nut
- Loose rear fork pivot nut

Soft suspension

- Weak shock absorber spring
- Improperly adjusted shock absorber
- Damper oil leaks

Hard suspension

- Improperly adjusted shock absorber

Rear suspension noise

- Bent rear shock absorber
- Loose shock absorber fasteners
- Insufficient damper oil

Poor brake performance

- Improperly adjusted brake
- Worn brake linings
- Contaminated or damaged brake linings
- Worn brake cam
- Worn brake drum
- Improperly installed brake linings
- Worn brake shoes at cam contacting area
- Worn camshaft

12. REAR WHEEL/BRAKE/SUSPENSION

REAR WHEEL

REMOVAL

Remove the rear axle nut.
Remove the rear brake adjusting nut.

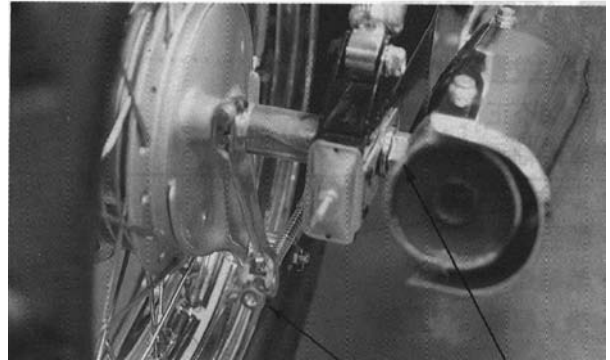

Rear Brake Adjusting Nut Rear Axle Nut

Remove the rear brake panel fixing arm bolt.
Remove the bushing.
Remove the rear brake panel.
Remove the drive chain.
Remove the rear wheel.

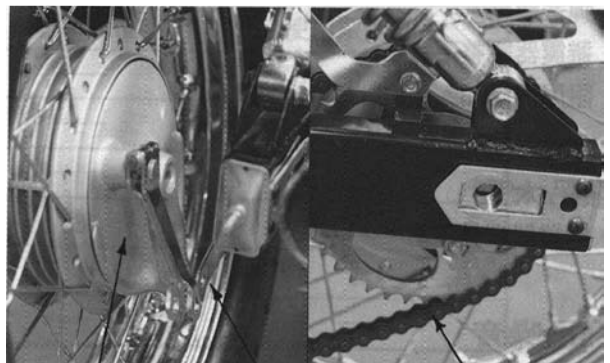

Rear Brake Panel Fixing Arm Bolt Drive Chain

INSPECTION

Set the rear axle in V blocks and measure the runout with a dial gauge.

Service Limit: 0.2mm

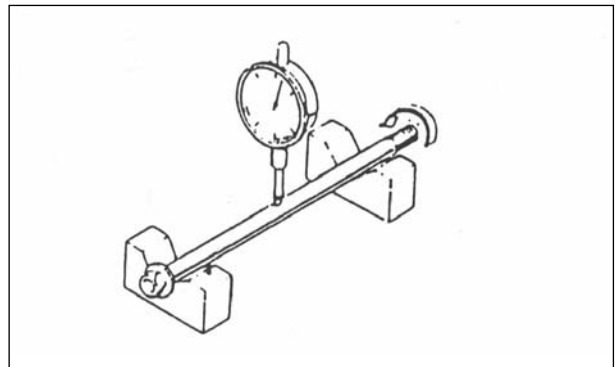

Place the rear wheel in a turning stand and measure the rim runout.

Service Limits:

Axial: 2.0mm replace if over

Radial: 2.0mm replace if over

Check the wheel spoke wires for looseness.

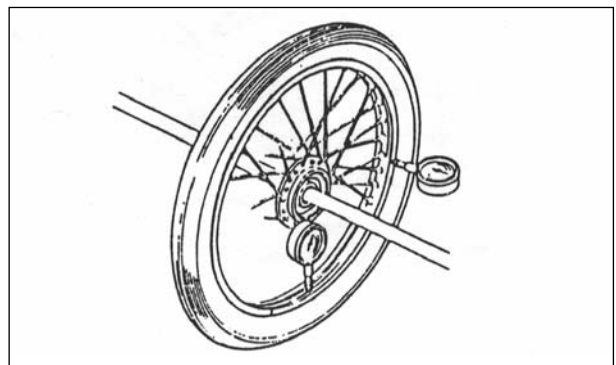

12. REAR WHEEL/BRAKE/SUSPENSION

Check the wheel bearing play by placing the wheel in a turning stand and spinning the wheel by hand.

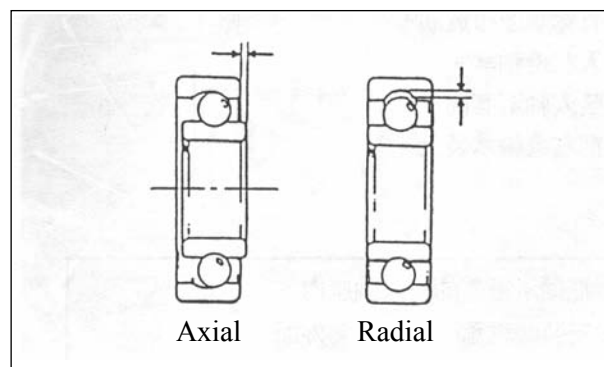

Check the drive chain gear teeth for wear or damage.
Replace the drive chain gear if necessary.

* If the drive chain gear teeth are worn or damaged, also check the drive chain and replace if necessary.

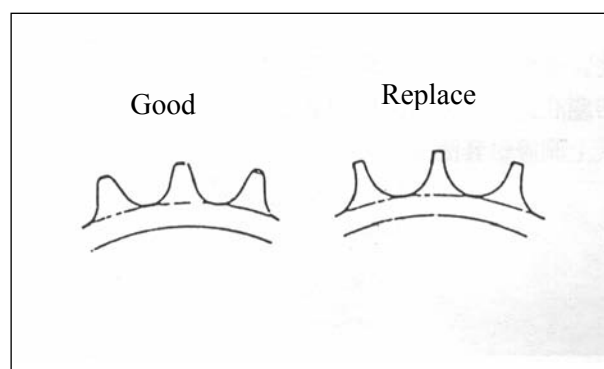

DISASSEMBLY

Remove the side collar and dust seal from the left side of the rear wheel.
First tap the safety piece flat and then remove the four drive chain gear lock nuts.
Remove the safety piece and drive chain gear.
Remove the snap ring and gear gasket.
Check the damping bushings for damage.

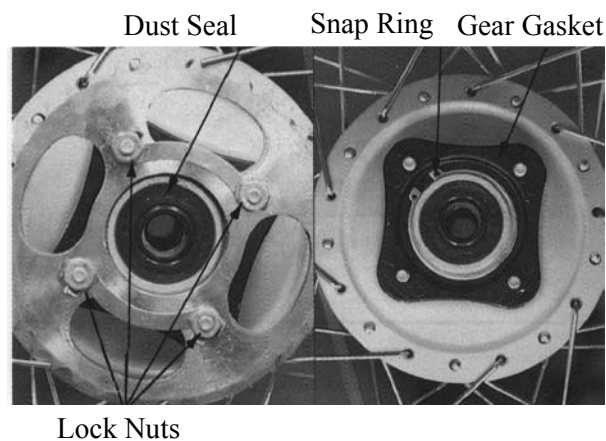

Drive out the wheel bearings and remove the distance collar.

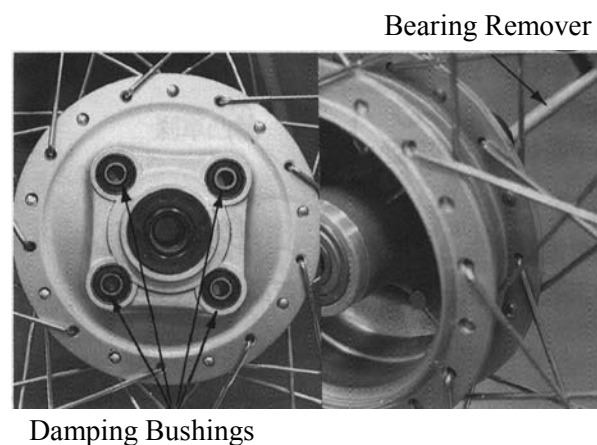

12. REAR WHEEL/BRAKE/SUSPENSION

ASSEMBLY

Pack all bearing cavities with grease.
Drive in the left bearing.
Install the distance collar.
Drive in the right bearing.

*

- Drive in the bearings squarely.
- Install the bearings with the sealed end facing out.

Drive Handle

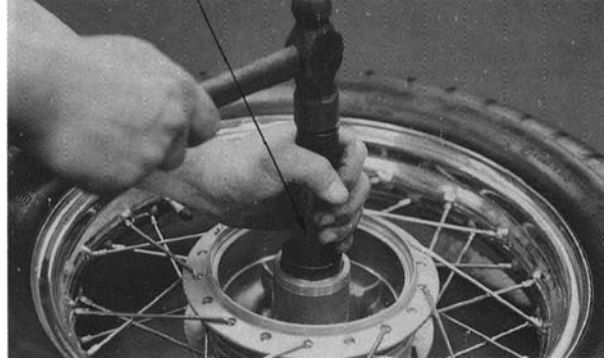

Install the drive chain gear and secure it with the snap ring.
Apply grease to the dust seal and install it to the bearing.
Install the side collar.

Drive Chain Gear

Side Collar

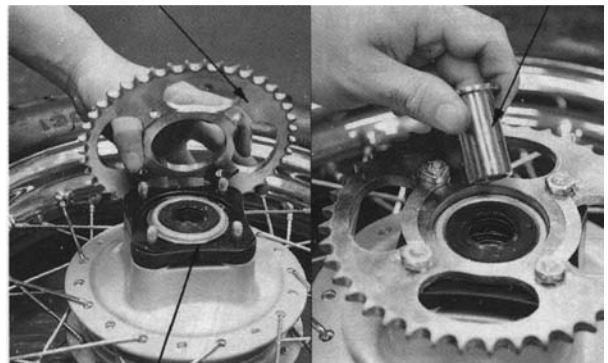

Snap Ring

INSTALLATION

Install the rear wheel in the reverse order of removal.

Drive Chain Slack: 1~2cm

*

After rear wheel installation, be sure to adjust the drive chain tension and the brake pedal free play.

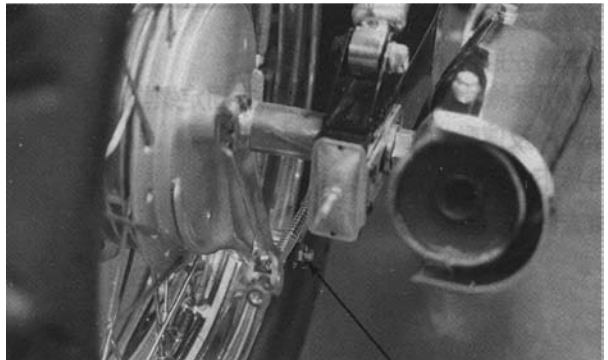

Fixing Arm Bolt

REAR BRAKE

REMOVAL

Remove the rear wheel and rear brake panel.

INSPECTION

Measure the rear brake lining thickness.

Service Limit: 2.0mm replace if below

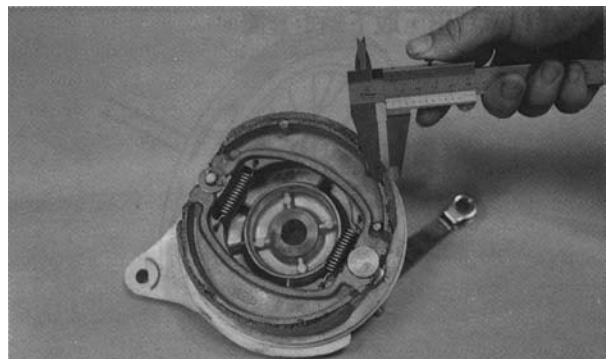

12. REAR WHEEL/BRAKE/SUSPENSION

Measure the brake drum I.D.
Service Limit: 131mm replace if over

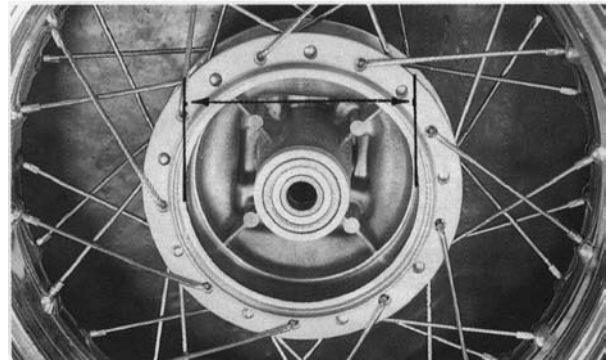

DISASSEMBLY

Remove the cotter pin, washer and brake shoes.

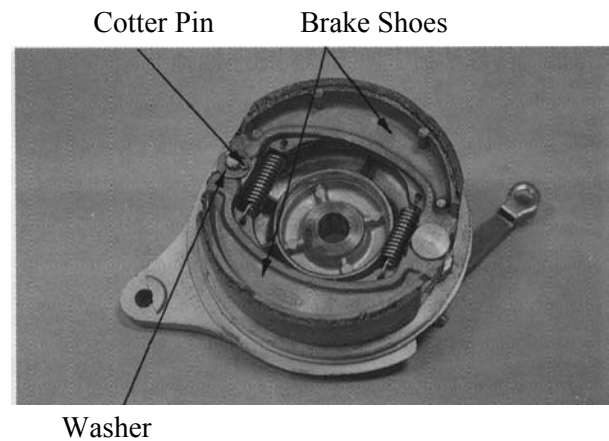

Remove the brake arm bolt to remove the brake arm.
Remove the oil seal.
Remove the brake cam.

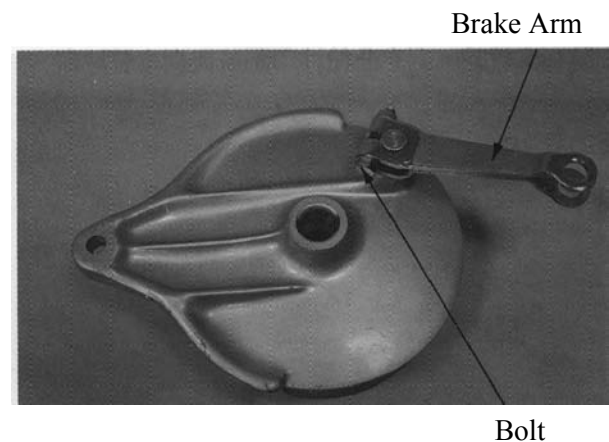

ASSEMBLY

- * **Keep grease off the linings because contaminated brake linings reduce stopping power.**
- When installing, wipe any excess grease off the brake cam.**

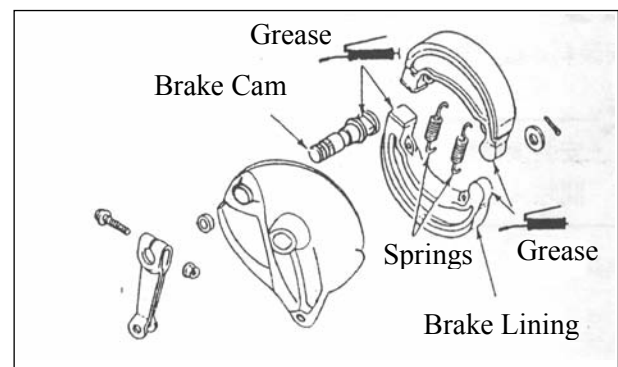

12. REAR WHEEL/BRAKE/SUSPENSION

Apply grease to the brake cam and anchor pin, then install the brake cam to the brake panel.

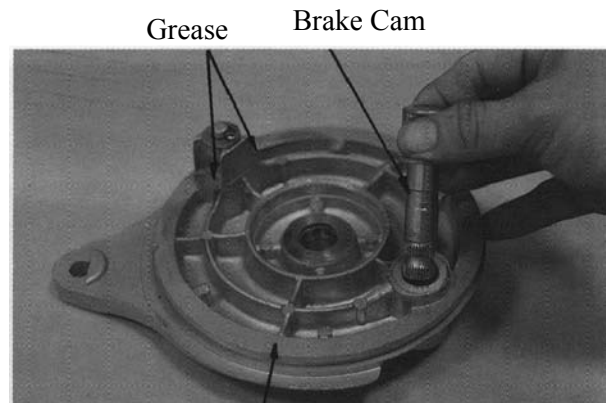

Brake Panel

Apply engine oil to the oil seal and install it to the brake cam.



Oil Seal

Install the brake arm onto the brake cam, aligning the punch mark on the cam with the punch mark on the arm.

Install and tighten the brake arm bolt.

Torque: 0.8~1.2kg-m



INSTALLATION

Install the brake panel and rear wheel in the reverse order of removal.

*

After the rear wheel installation, check the drive chain tension and rear brake pedal free play.

12. REAR WHEEL/BRAKE/SUSPENSION

REAR SHOCK ABSORBER

REMOVAL

Remove the two screws attaching the left shock absorber outer cover and remove the outer cover.
Remove the left shock absorber upper mount nut and washer and then press down the motorcycle to pull out the shock absorber.
Remove the left shock absorber lower mount bolt to remove the left rear shock absorber
Remove the right rear shock absorber in the same steps.

Put the shock absorber in the rear shock absorber compressor and compress the spring.

Loosen the lock nut and remove the upper joint.
Remove the spring and take out the damper to disassemble the shock absorber.

Measure the spring free length.
Service Limit: 227mm

Screws

Upper Mount Nut

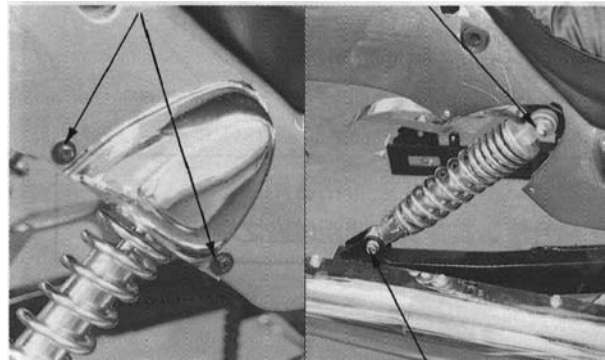

Lower Mount Bolt

Rear Shock Absorber Attachment

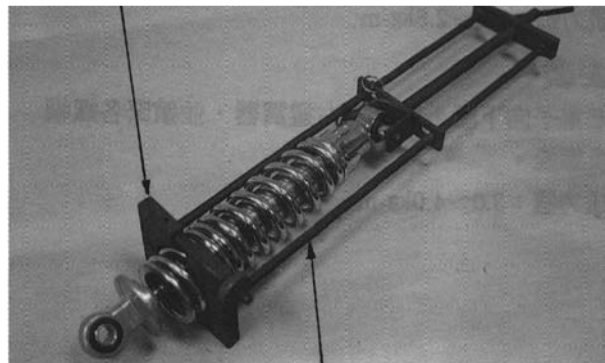

Rear Shock Absorber Compressor

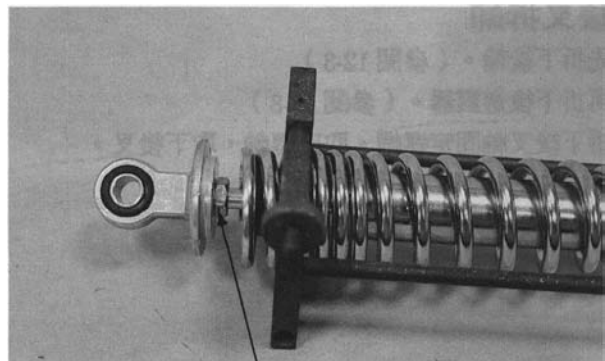

Lock Nut

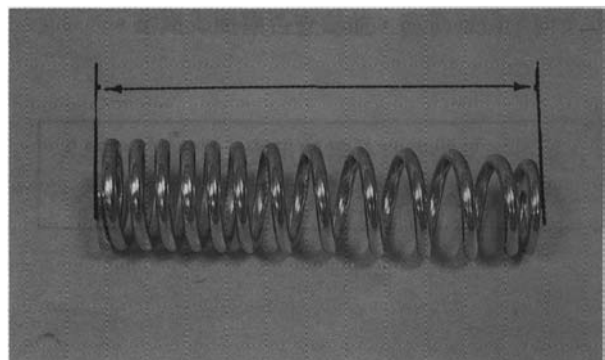

12. REAR WHEEL/BRAKE/SUSPENSION

ASSEMBLY

Assemble the rear shock absorbers in the reverse order of disassembly.

* _____

- Apply locking agent to the lock nut threads and tighten the lock nut.
- Install the shock absorber spring with closely wound coils facing up.

Torque: 1.9~2.8kg-m

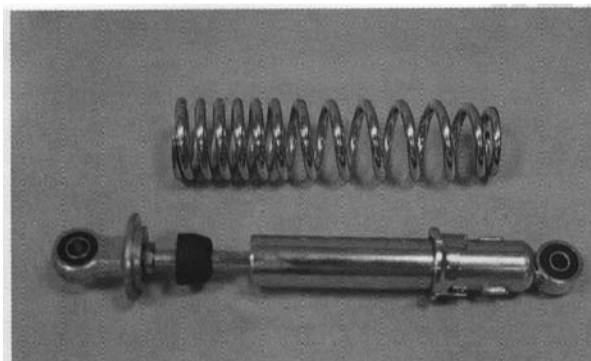

Upper Mount Nut

INSTALLATION

Depress the motorcycle to install the left and right rear shock absorbers. Tighten the shock absorber upper mount nuts and lower mount bolts.

Torque: 3.0~4.0kg-m

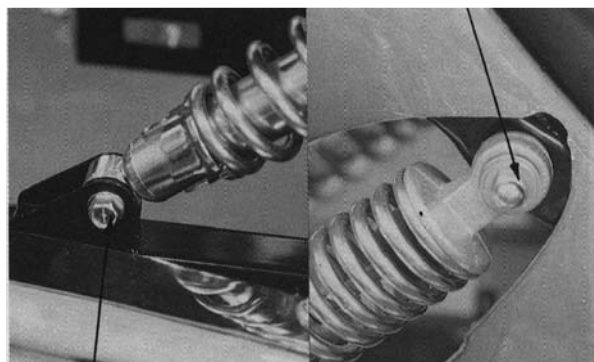

Lower Mount Bolt

REAR FORK

REMOVAL

Remove the rear wheel. (Refer to 12-3.)

Remove the rear shock absorbers. (Refer to 12-8.)

Remove the rear fork pivot nut to remove the pivot and rear fork.

Rear Fork Pivot Nut

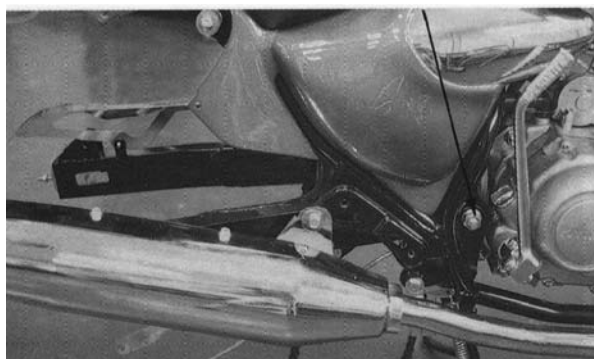

Remove the drive chain slider and check for wear or damage.

* _____

- After the rear fork pivot bushings are replaced, press in the bushings to make them flush with the rear fork.

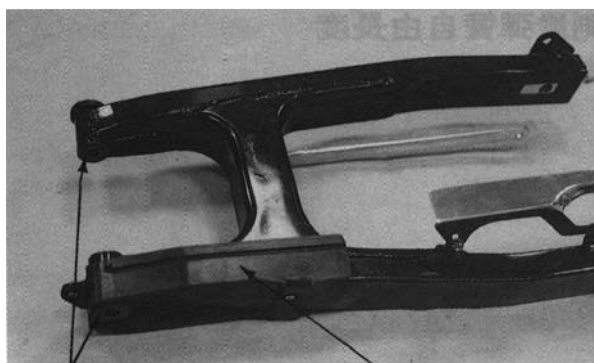

Pivot Bushings

Slider

12. REAR WHEEL/BRAKE/SUSPENSION

INSTALLATION

Install the rear fork in the reverse order of removal.

Tighten the rear fork pivot nut.

Torque: 5.5~6.5kg-m

After the rear fork is installed, install the following parts:

Rear shock absorber (Refer to 12-8)

Rear wheel (Refer to 12-3.)

Rear brake adjustment (Refer to 2-9.)

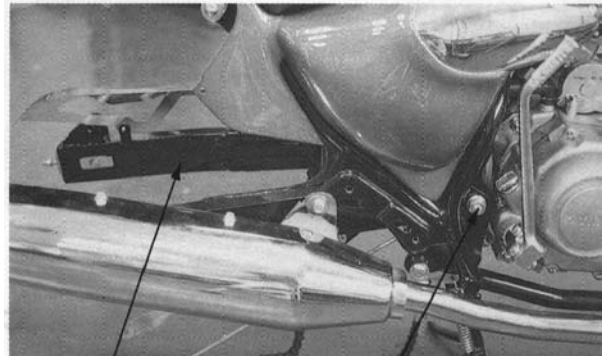

Rear Fork

Rear Fork Pivot Nut

13. HYDRAULIC BRAKE

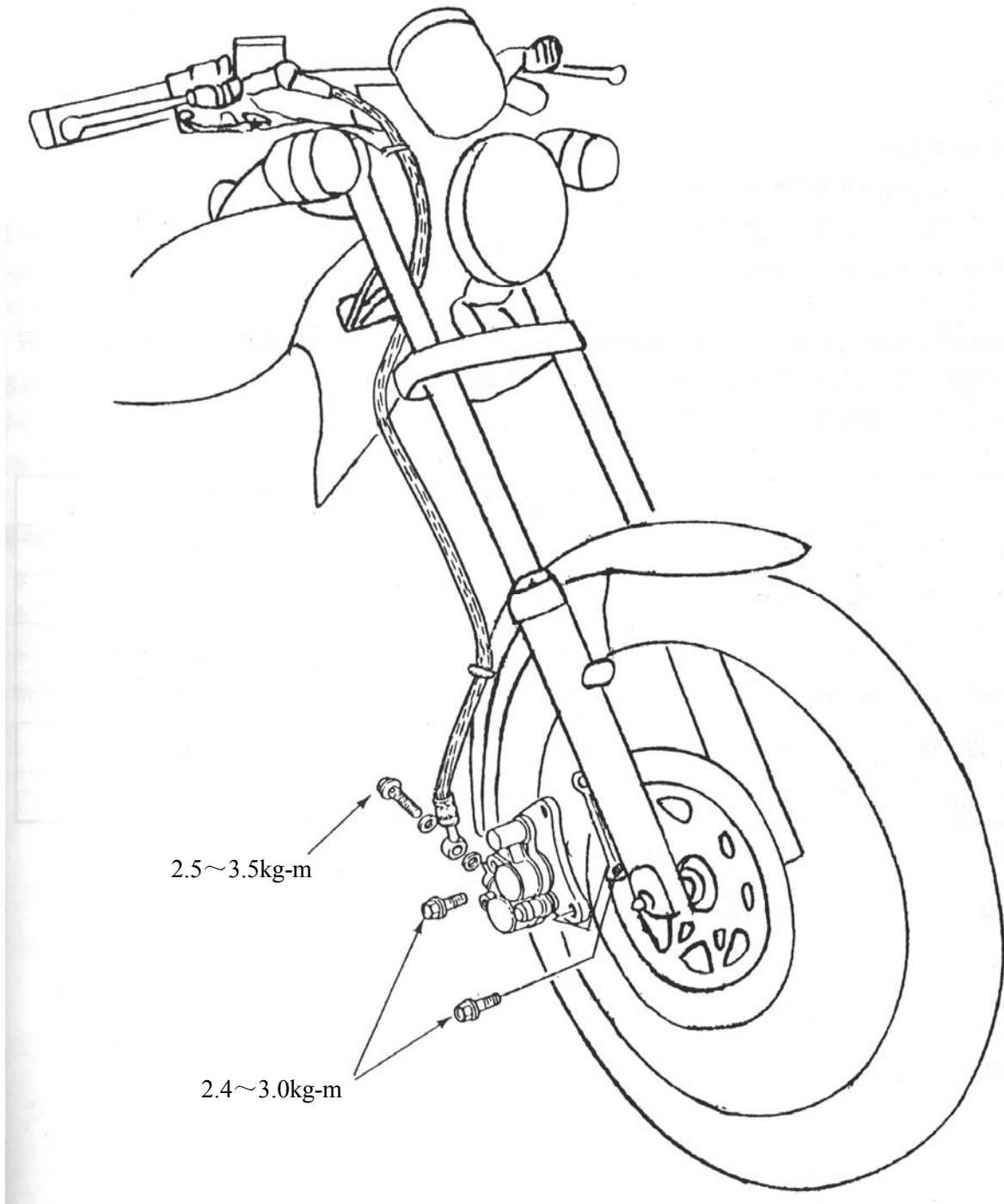

13. HYDRAULIC BRAKE

SERVICE INFORMATION	13-1	BRAKE PAD/DISK.....	13-4
TROUBLESHOOTING	13-2	BRAKE MASTER CYLINDER.....	13-5
BRAKE FLUID CHANGE/AIR BLEED....	13-3	BRAKE CALIPER	13-8

SERVICE INFORMATION

GENERAL INSTRUCTIONS

- Drain the brake fluid from the hydraulic brake system before disassembly.
- Do not allow any foreign matters entering the brake reservoir when filling the brake reservoir with brake fluid.
- Be careful not to splash brake fluid on any coated surfaces and instrument covers to avoid damage.
- Inspect the brake operation before riding.
- Brake fluid will damage painted, coated surfaces and plastic parts. When working with brake fluid, use shop towels to cover and protect painted, rubber and plastic parts. Wipe off any splash of brake fluid with a clean towel. Do not wipe the motorcycle with a towel contaminated by brake fluid.
- Make sure to use recommended brake fluid. Use of other unspecified brake fluids may cause brake failure.

SPECIFICATIONS

Item	Standard (mm)	Service Limit (mm)
Brake disk thickness	4	3.0
Brake disk runout	0.15	—
Brake master cylinder I.D.	12.7~12.743	12.75
Brake master cylinder piston O.D.	12.657~12.684	12.64
Brake caliper piston O.D.	25.335~25.368	25.30
Brake caliper cylinder I.D.	25.4~25.45	25.50

TORQUE VALUES

Caliper holder bolt	2.40~3.0kg-m
Pad pin bolt	1.5~2.0kg-m
Brake fluid tube bolt	2.5~3.5kg-m
Caliper bleed valve	0.4~0.7kg-m
Master cylinder holder bolt	1.0~1.4kg-m

SPECIAL TOOL

Snap ring pliers

13. HYDRAULIC BRAKE

TROUBLESHOOTING

Loose brake lever

- Air in hydraulic brake system
- Brake fluid level too low
- Hydraulic brake system leakage

Tight brake lever

- Seized piston
- Clogged hydraulic brake system
- Smooth or worn brake pad

Hard braking

- Seized hydraulic brake system
- Seized piston

Poor brake performance

- Contaminated brake pad surface
- Brake disk or wheel not aligned

Brake noise

- Contaminated brake pad surface
- Excessive brake disk runout
- Incorrectly installed caliper
- Brake disk or wheel not aligned

13. HYDRAULIC BRAKE

BRAKE FLUID CHANGE/AIR BLEED

Place the motorcycle on its main stand on level ground and set the handlebar upright. Remove the two screws attaching the brake fluid reservoir cap.

- * Use shop towels to cover plastic parts and coated surfaces to avoid damage caused by splash of brake fluid.

Connect a transparent hose to the brake caliper bleed valve and then loosen the bleed valve nut. Use a syringe to draw the brake fluid out through the hose.

BRAKE FLUID REFILLING

Connect a transparent hose and syringe to the brake caliper bleed valve and then loosen the bleed valve nut. Fill the brake reservoir with brake fluid and use the syringe to draw brake fluid into it until there is no air bubbles in the hose. Then, tighten the bleed valve nut.

- *
 - When drawing brake fluid with the syringe, the brake fluid level should be kept over 1/2 of the brake reservoir height.
 - Use only the recommended brake fluid.

Recommended Brake Fluid: DOT-3

BRAKE SYSTEM BLEEDING

Connect a transparent hose to the bleed valve and fully apply the brake lever after continuously pull it several times. Then, loosen the bleed valve nut to bleed air from the brake system. Repeat these steps until the brake system is free of air.

- * When bleeding air from the brake system, the brake fluid level should be kept over 1/2 of the brake reservoir height.

Screws

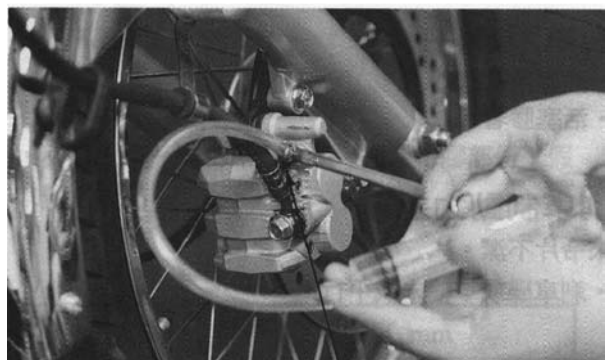

Bleed Valve

Brake Reservoir

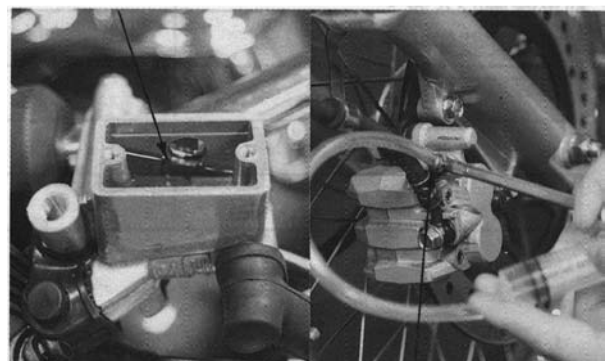

Bleed Valve

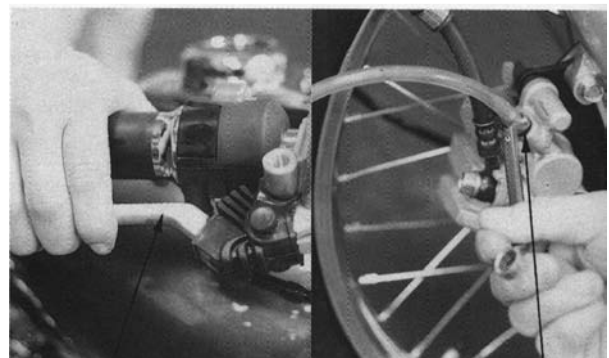

Brake Lever

Bleed Valve

13. HYDRAULIC BRAKE

BRAKE PAD/DISK

BRAKE PAD REPLACEMENT

Remove the two bolts attaching the brake caliper holder.

* The brake pads can be replaced without removing the brake fluid tube.

Remove the brake caliper.

Remove the brake pad pin bolt caps and then remove the pad pin bolts and brake pads.

Remove the pad springs.

ASSEMBLY

Assemble the brake pads in the reverse order of removal.

Tighten the pad pin bolts.

Torque: 1.2~2.0kg-m

Tighten the pad pin bolt caps.

* Do not tighten the pad pin bolt caps excessively.

Torque: 0.2~0.4kg-m

Bolts



Pin Bolts

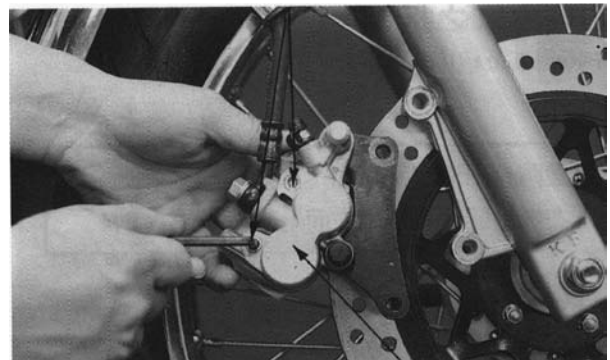

Brake Caliper

Pad Spring

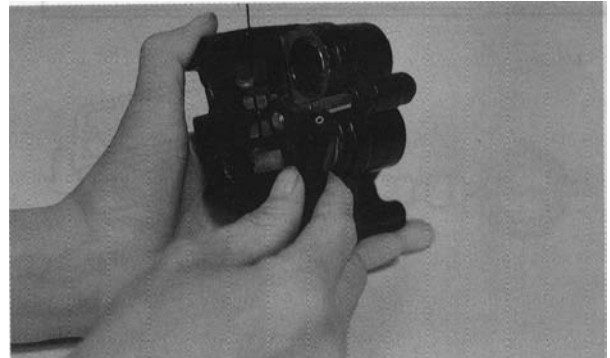

Pin Bolts

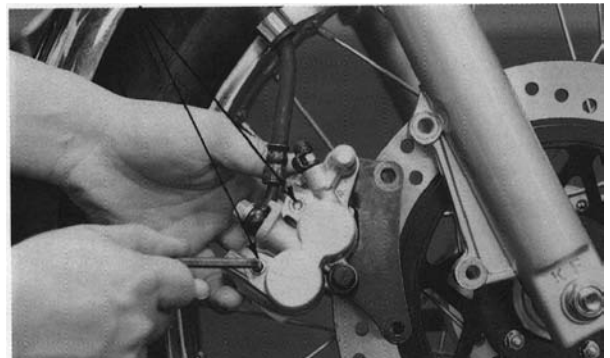

13. HYDRAULIC BRAKE

BRAKE DISK

Measure the brake disk thickness.

Service Limit: 3.0mm

Measure the brake disk runout.

Service Limit: 0.3mm

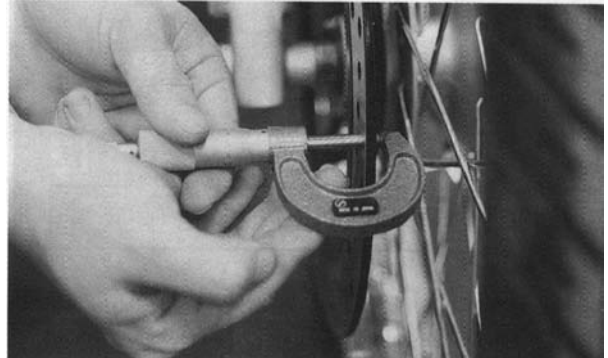

BRAKE MASTER CYLINDER

REMOVAL

Drain the brake fluid from the hydraulic brake system.

- * Do not splash brake fluid onto any rubber, plastic and coated parts. When working with brake fluid, use shop towels to cover these parts.

Remove the two master cylinder holder bolts and remove the master cylinder.

- * When removing the brake fluid tube bolt, be sure to place towels under the tube and plug the tube end to avoid brake fluid leakage and contamination.

Fluid Tube Bolt

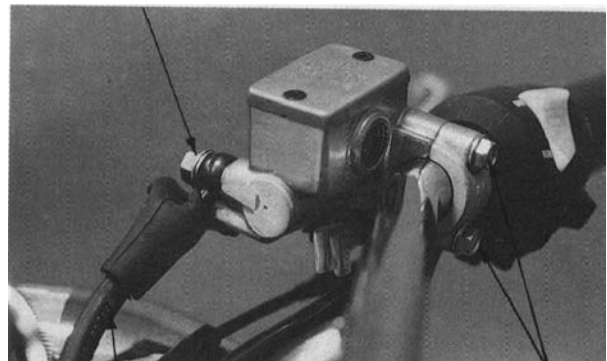

Fluid Tube

Bolts

13. HYDRAULIC BRAKE

DISASSEMBLY

Remove the piston rubber cover and snap ring from the brake master cylinder.

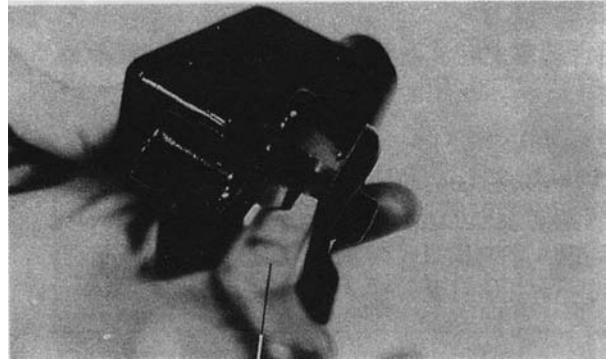

Snap Ring Pliers

Remove the washer, main piston and spring from the brake master cylinder.
Clean the inside of the master cylinder and brake reservoir with brake fluid.

Master Cylinder

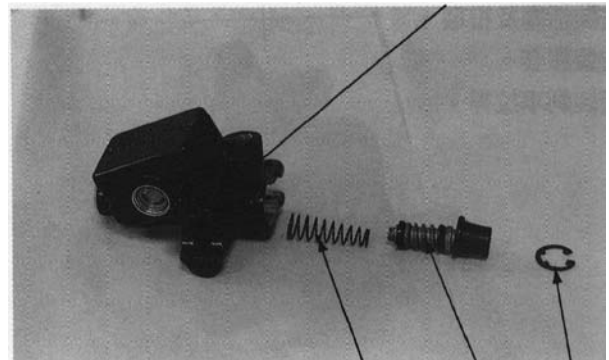

Spring Main Piston Snap Ring

INSPECTION

Measure the brake master cylinder I.D.
Inspect the master cylinder for scratches or cracks.

Service Limit: 12.75mm replace if below

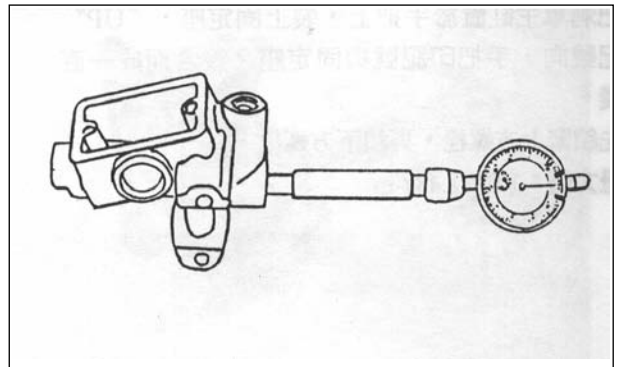

Measure the brake master cylinder piston O.D.

Service Limit: 12.64mm replace if below

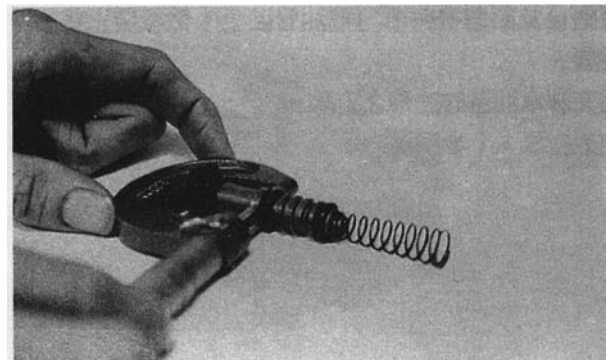

13. HYDRAULIC BRAKE

ASSEMBLY

Before assembly, apply brake fluid to all removed parts.
Install the spring together with the 1st rubber cup.

- * During assembly, the master cylinder, main piston and spring must be installed as a unit without exchange.
- * When assembling the piston, soak the cups in brake fluid for a while.

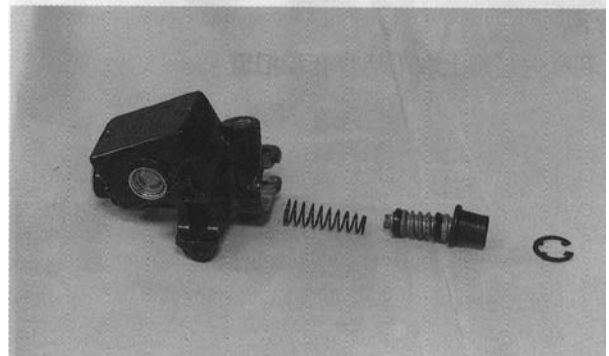

Install the main piston and snap ring.
Install the rubber cover.
Install the brake lever.

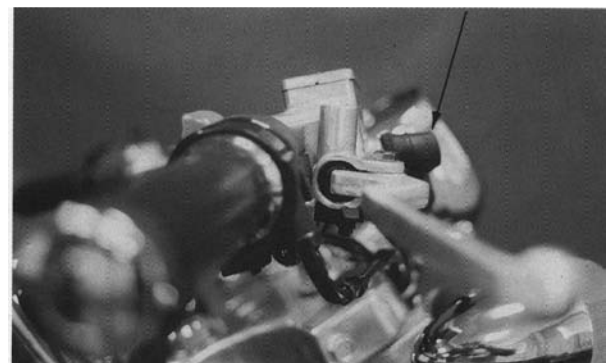

Fluid Tube Bolt

Place the brake master cylinder on the handlebar and install the master cylinder holder with the "UP" mark facing up, aligning the tab on the holder with the hole in the handlebar.
First tighten the upper bolt and then tighten the lower bolt.

Torque: 1.0~1.4kg-m

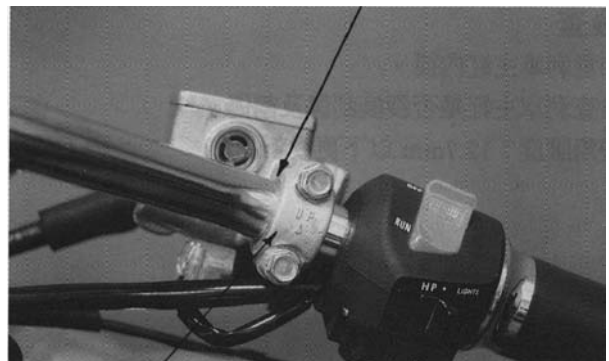

"UP" Mark

Install the brake fluid tube with the bolt and two sealing washers. Then, install the rearview mirror.
Fill the brake reservoir with recommended brake fluid to the upper level.
Bleed air from the hydraulic brake system.
(Refer to 13-3.)

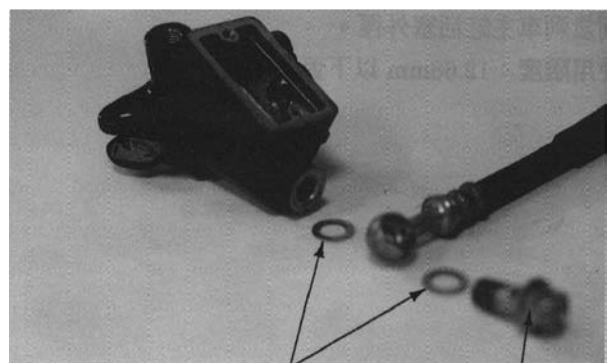

Sealing Washers Bolt

13. HYDRAULIC BRAKE

BRAKE CALIPER

REMOVAL

Remove the brake caliper and brake pad springs. Place a clean container under the brake caliper and disconnect the brake fluid tube from the brake caliper.

* Be careful not to splash brake fluid on any coated surfaces.

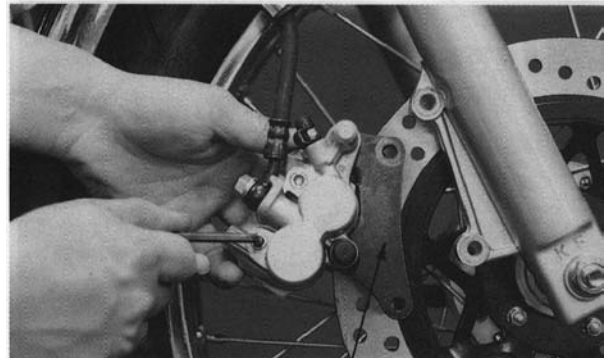

Caliper Seat

DISASSEMBLY

Remove the brake caliper seat from the brake caliper.



Caliper Seat

Remove the pistons from the brake caliper. Use compressed air to press out the pistons through the brake fluid inlet opening and place a shop towel under the caliper to avoid contamination caused by the removed pistons.

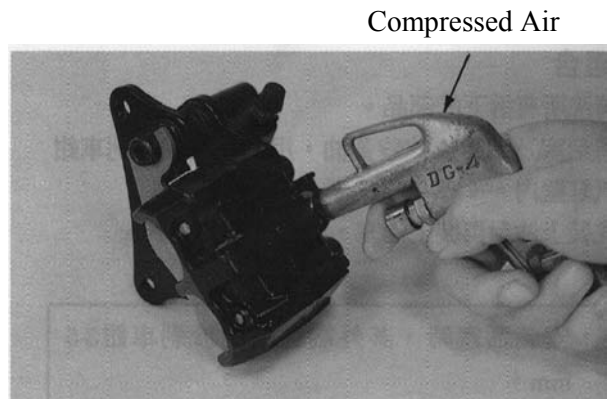

Compressed Air

Push the piston oil seals inward to remove them. Clean each oil seal groove with brake fluid.

* Be careful not to damage the piston surface.



Piston Oil Seals

13. HYDRAULIC BRAKE

INSPECTION

Check each piston for scratches or wear.
Measure each piston O.D. with a micrometer gauge.

Service Limit: 25.30mm replace if below

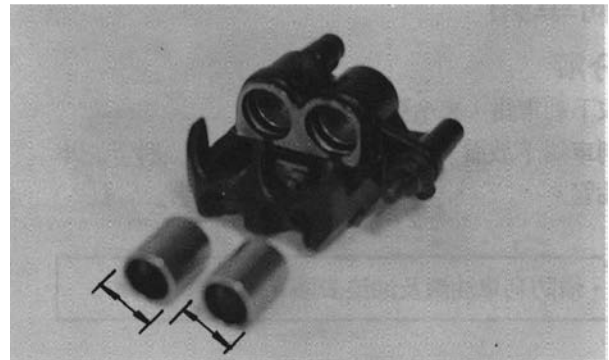

Check each caliper and caliper cylinder for scratches or wear and measure the caliper cylinder I.D.

Service Limit: 25.45mm replace if over

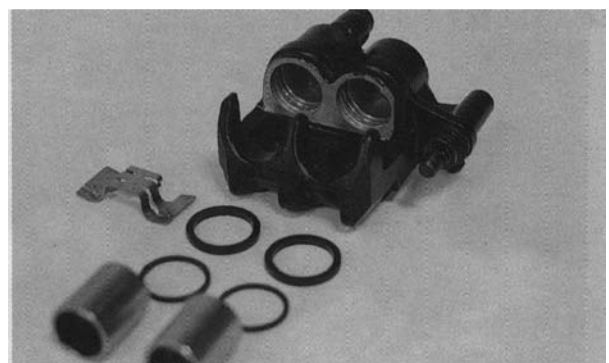

ASSEMBLY

Clean all removed parts.

Apply silicon grease to the pistons and oil seals. Lubricate the brake caliper cylinder inside wall with brake fluid.

Install the oil seals and then install the brake caliper pistons with the grooved side facing out.

* Install the piston with its outer end protruding 3~5mm beyond the brake caliper.

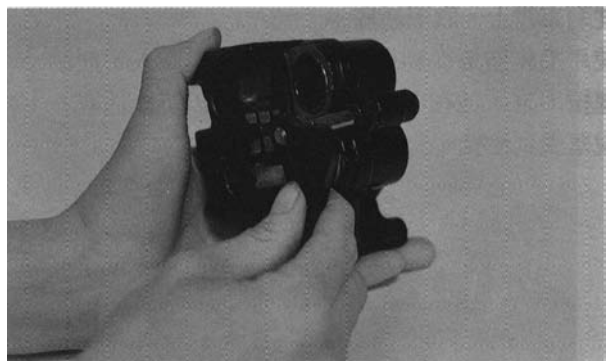

Wipe off excessive brake fluid with a clean shop towel. Apply silicon grease to the brake caliper seat pin and caliper inside.
Install the brake caliper seat.

13. HYDRAULIC BRAKE

INSTALLATION

Install the brake caliper onto the right front fork and tighten the bolts.

Torque: 2.4~3.0kg-m

Connect the brake fluid tube to the brake caliper and tighten the fluid tube bolt.

Torque: 2.4~3.0kg-m

Add the recommended brake fluid into the brake reservoir and bleed air from the brake system. (Refer to 13-3.)



14. REAR CARRIER/REAR FENDER/ EXHAUST MUFFLER

14

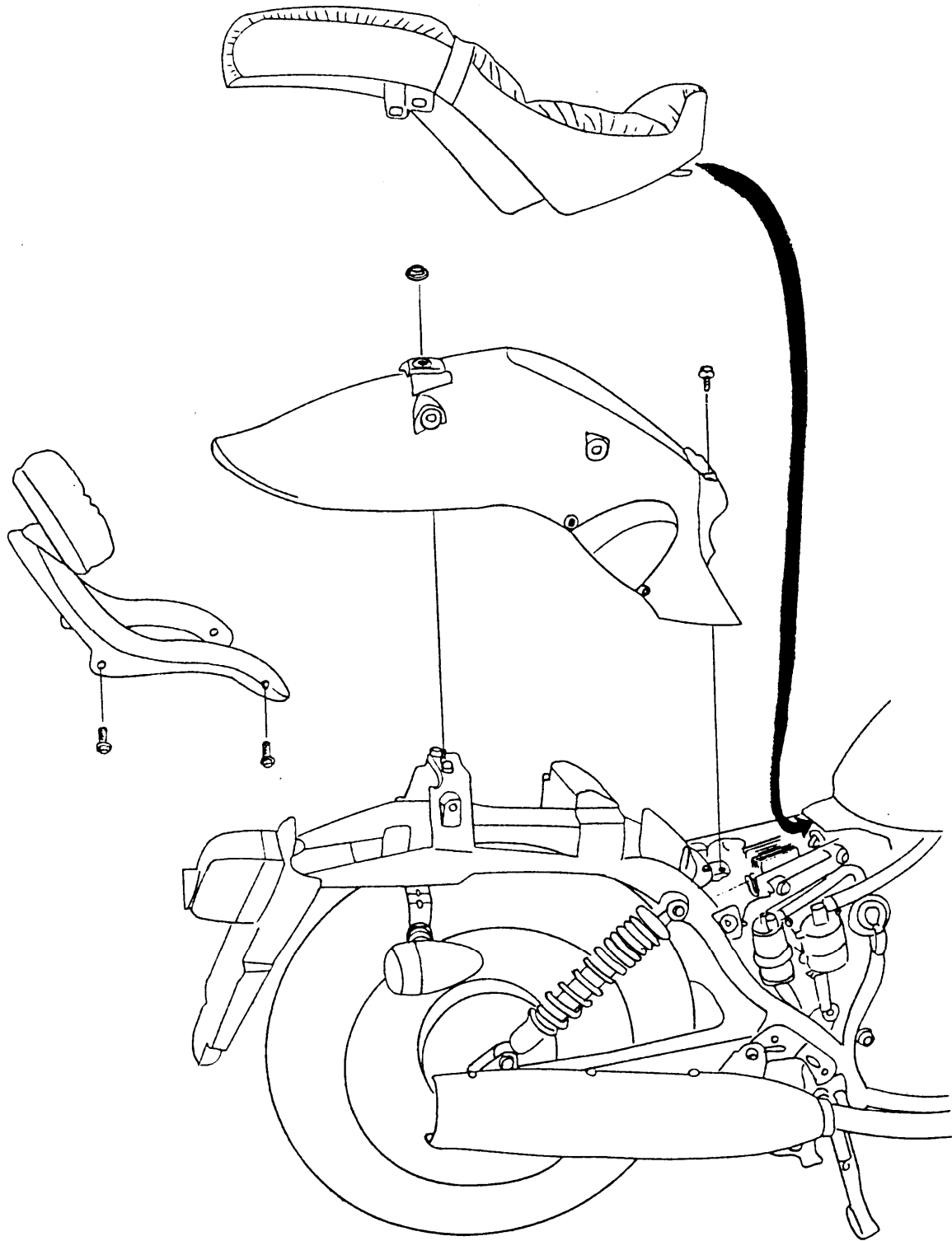

14. REAR CARRIER/REAR FENDER/ EXHAUST MUFFLER

SERVICE INFORMATION.....	14-1	REAR FENDER.....	14-2
REAR CARRIER	14-2	EXHAUST MUFFLER.....	14-3

SERVICE INFORMATION

GENERAL INSTRUCTIONS

- The exhaust muffler must be removed when it is cold to avoid burns.
- When installing the exhaust muffler, first tighten the exhaust muffler joint lock nuts and then tighten the exhaust muffler hanger lock bolt.

TORQUE VALUES

Rear carrier lock bolt	3.0~4.0kg-m
Exhaust muffler joint lock nut	0.8~1.2kg-m

14. REAR CARRIER/REAR FENDER/ EXHAUST MUFFLER

REAR CARRIER

REMOVAL

Remove the two lock bolts on each side of the rear carrier. Remove the rear carrier and two collars.



Rear Carrier Lock Bolts

INSTALLATION

Install the rear carrier in the reverse order of removal.



Collars

REAR CARRIER

REMOVAL

Remove the rear carrier. (Refer to 4-10.)
Remove the seat. (Refer to 4-10.)
Remove the lock nut and two lock bolts attaching the rear fender.
Remove the rear fender.

INSTALLATION

Install the rear fender in the reverse order of removal.

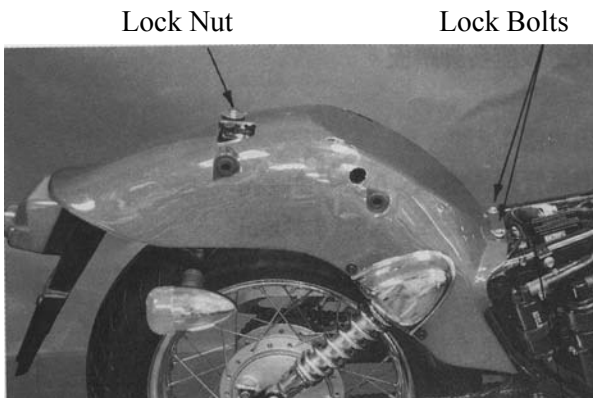

Lock Nut

Lock Bolts

Rear Turn Signal Light Wire Coupler

14. REAR CARRIER/REAR FENDER/ EXHAUST MUFFLER

EXHAUST MUFFLER

REMOVAL

* The exhaust muffler must be removed when it is cold to avoid burns.

Remove the two exhaust muffler joint lock nuts.
Remove the two socket head bolts attaching the rear foot rest.
Remove the exhaust muffler hanger lock bolt.
Remove the exhaust muffler.

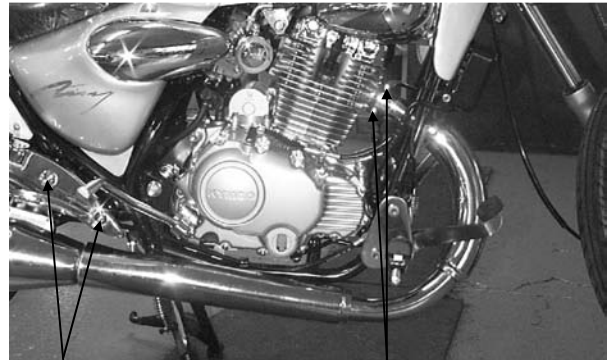

Socket Head Bolts Exhaust Muffler Joint Lock Nuts

INSPECTION

Inspect the exhaust muffler joint and gasket for damage, deformation or leakage.
Replace if necessary.

INSTALLATION

Install the exhaust muffler joint and gasket and then install the exhaust muffler.
First tighten the two exhaust muffler joint lock nuts and then tighten the exhaust muffler hanger lock bolt.
Install the rear foot rest.

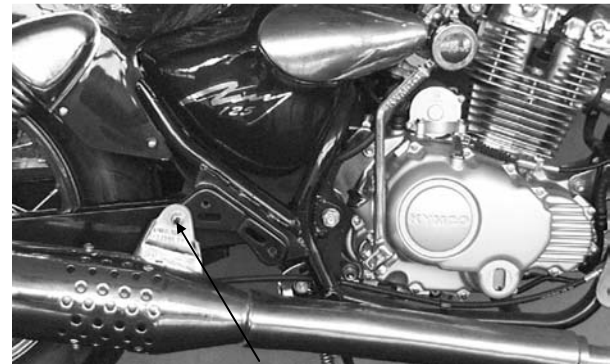

Hanger Lock Bolt

Torques:

Exhaust muffler joint lock nut: 0.8~1.2kg-m
Exhaust muffler hanger lock bolt: 2.4~3.0kg-m

15. IGNITION SYSTEM

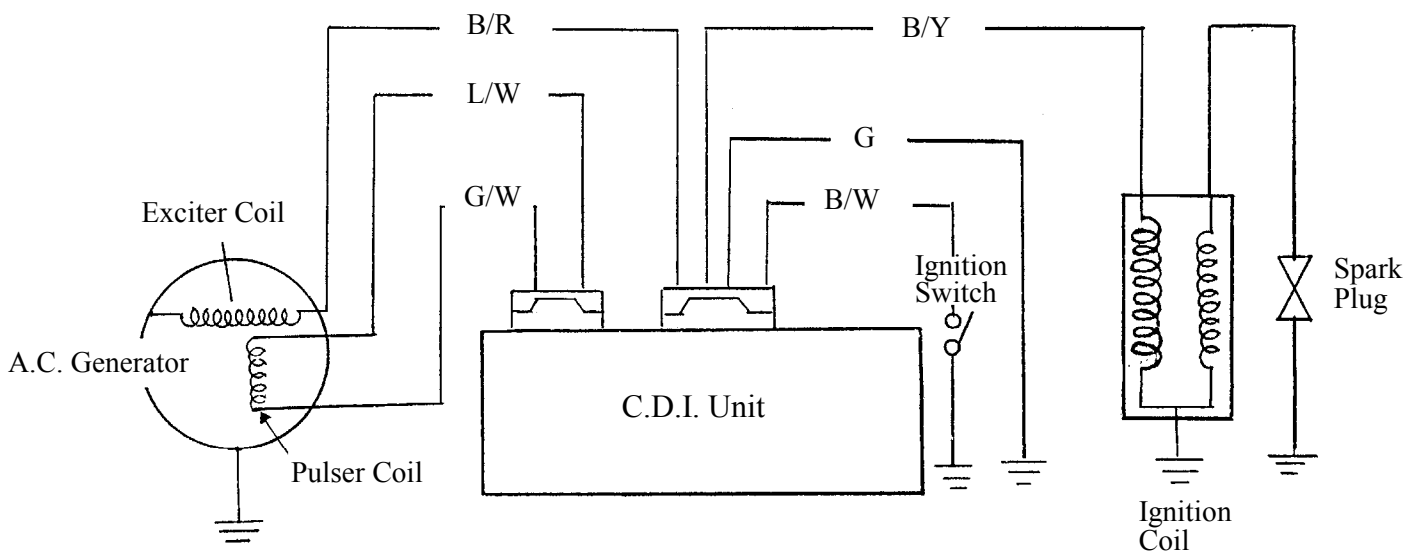
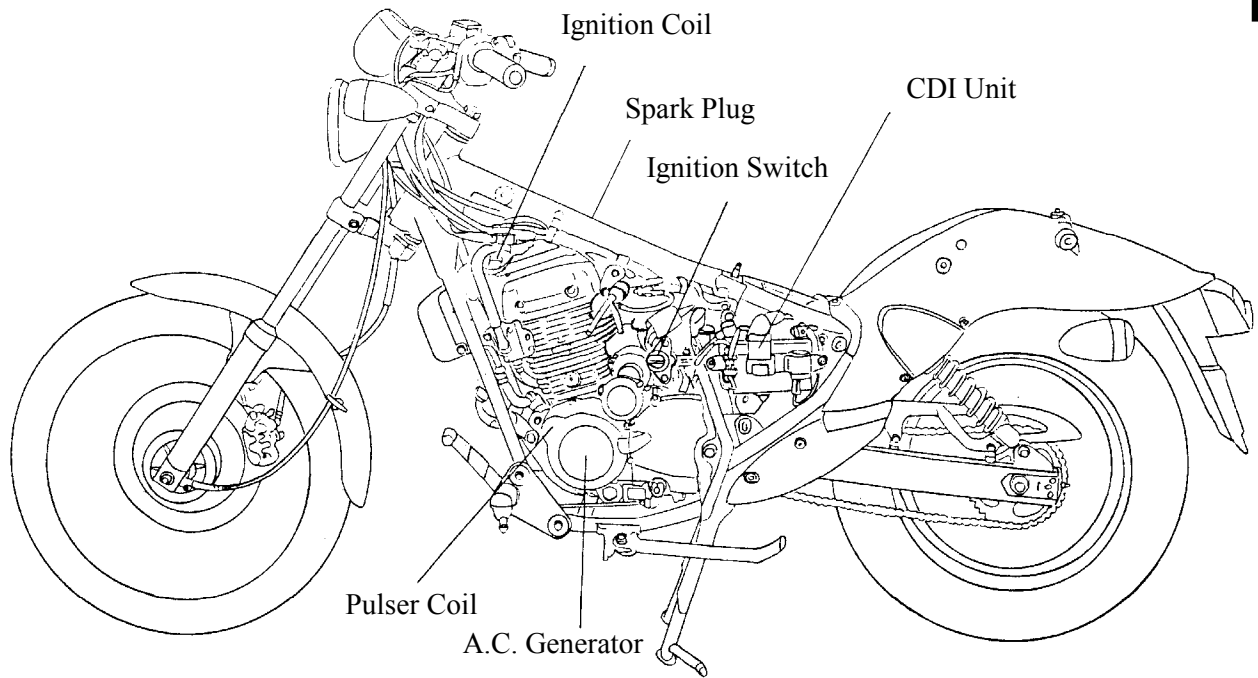

15. IGNITION SYSTEM

SERVICE INFORMATION	15-1	CDI UNIT	15-4
TROUBLESHOOTING	15-2	PULSER COIL.....	15-5
IGNITION COIL.....	15-3	EXCITER COIL.....	15-5

SERVICE INFORMATION

GENERAL INSTRUCTIONS

- Inspect the ignition system according to the sequence specified in the Troubleshooting 15-2.
- The ignition system has an electrical auto aligner in the CDI unit, so the ignition timing is not adjustable.
- Do not drop or impact the CDI unit with strong force to avoid damage. Be careful when removing it.
- Loose connector and poor wire connection are the main causes of faulty ignition system. Check each connector before operation.
- Check the spark plug heat range. Use of spark plug with improper heat range is the main cause of poor engine performance or burned engine.
- Perform inspections according to the servicing procedures specified in each section.

SPECIFICATIONS

Item		Standard	
Spark plug	Standard type	DR8EA	
	Hot type	DR7EA	
	Cold type	DR9EA	
Spark plug gap		0.6~0.7mm	
Ignition timing	“F” mark: 15±2°/1,600rpm Full advance: 34.5±2°/4,000rpm	—	
Ignition coil resistance (20°C)	Primary coil	0.2~0.3Ω	
	Secondary coil	with plug cap	7.6~8.6KΩ
		without plug cap	3.2~4.8KΩ
Pulser coil resistance (20°C)		92~138Ω	
Exciter coil resistance (20°C)		272~408Ω	
Ignition coil primary side max. voltage		140V min.	
Pulser coil max. voltage		1.5V/300rpm min.	
Exciter coil max. voltage		300~1000rpm 400V max.	

TESTING INSTRUMENT

- Electric Tester
- Timing light
- Tachometer

15. IGNITION SYSTEM

TROUBLESHOOTING

Engine stalls immediately after it starts

- Weak spark
- Improper ignition timing
- Faulty CDI unit

No spark at plug

- Faulty ignition switch
- Poorly connected, broken or shorted wire
 - Between pulser coil, CDI unit and ignition coil
 - Between exciter coil and CDI unit
 - Between CDI unit and ignition coil
 - Between CDI unit and ignition switch
 - Between ignition coil and spark plug

Engine starts but runs poorly

- Faulty ignition coil
- Poorly connected wire
- Faulty spark plug
- Spark plug cap electricity leakage
- Faulty A.C. generator
- Stator not installed properly (Loose)
- Faulty CDI unit

15. IGNITION SYSTEM

IGNITION COIL

CONTINUITY TEST

Remove the left decorative cover under the fuel tank.

Disconnect the ignition coil black/yellow wire coupler and measure the resistance between the ignition coil primary wire terminals.

Resistance: 0.2~0.3Ω

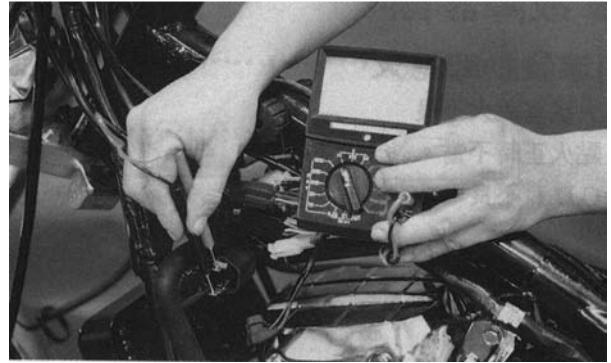

Remove the spark plug cap and measure the secondary coil resistance between the spark plug wire and the primary coil terminal.

Resistance: 3.2~4.8Ω (without plug cap)



* This test is for reference only. Accurate test should be performed with a CDI tester.

Measure the spark plug cap resistance. Remove the spark plug cap and measure the spark plug resistance.

Resistance: 4.2~5.8KΩ

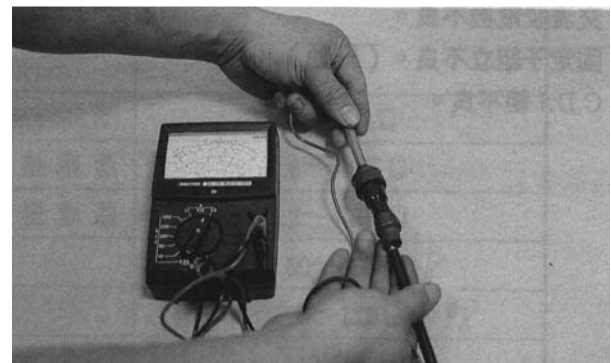

* Measure the resistance in the XKΩ range.

PERFORMANCE TEST

Test performance with a CDI tester.

*

- Operate the CDI tester by following the manufacturer's instructions.
- Use the special connector to connect the CDI unit.

If the spark is weak, inspect the spark plug and CDI unit. If both of them are normal, replace the ignition coil with a new one.

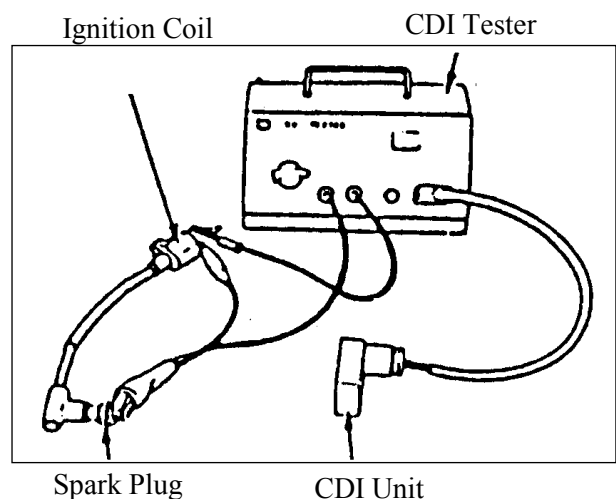

15. IGNITION SYSTEM

CDI UNIT

REMOVAL

Remove the left side cover.
Disconnect the CDI coupler and remove the CDI unit.

CDI Coupler

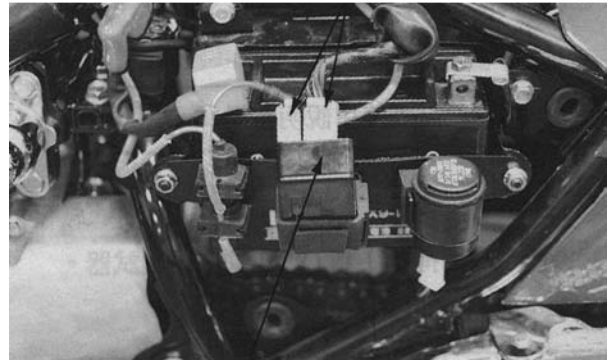

CDI Unit

SW (Black/White) EXT (Black/Red) E2 (Green)

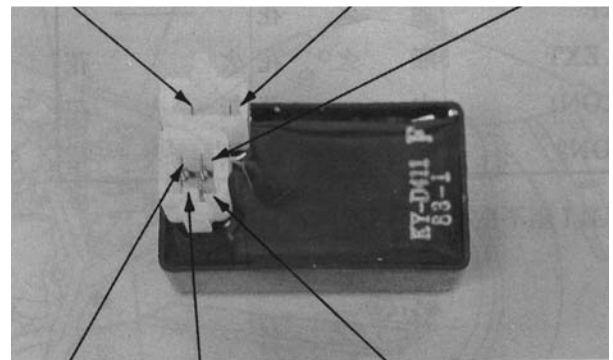

IGN (Black/ Yellow) PC (Blue/ White) E1 (Green/White)

INSPECTION

Measure the resistance between the CDI unit terminals.

Replace the CDI unit if the readings are not within the specifications in the table below.

- * • Due to the semiconductor in circuit, it is necessary to use a specified tester for accurate testing. Use of an improper tester or measurements in an improper range may give false readings. Use a Sanwa Electric Tester SP-100 or Kowa Electric Tester TH-5H for testing.

Testing Range

Use the xKΩ range for the Sanwa Tester.
Use the x100Ω range for the Kowa Tester.

Unit: KΩ

(+)Probe (-)Probe	SW (Black/ White)	EXT (Black/ Red)	PC (Blue/ White)	E2 (Green)	E1 (Green/ White)	IGN (Black/ Yellow)
SW (Black/ White)		∞	∞	∞	∞	∞
EXT (Black/ Red)	3-6K		Needle swings then ∞	Needle swings then ∞	∞	∞
PC (Blue/ White)	35-42K	18-22K		8-10K	8-10K	∞
E2 (Green)	15-18K	4.5-5.5K	7-9K		There is continuity	∞
E1 (Green/ White)	15-18K	4.5-5.5K	7-9K	There is continuity		∞
IGN (Black/ Yellow)	∞	∞	∞	∞	∞	

Note: The readings in this table are taken with a Sanwa Tester.

15. IGNITION SYSTEM

Test the CDI unit using the CDI tester.

* Operate the CDI tester by following the manufacturer's instructions.

Connect the special connector to the CDI coupler and CDI tester.

Switch Range	Good CDI	Faulty CDI
1. OFF	No spark	—
2. P	No spark	—
3. EXT	No spark	Good spark
4. ON1	Good spark	No spark
5. ON2	Good spark	No spark

If the CDI unit is faulty, replace it with a new one.

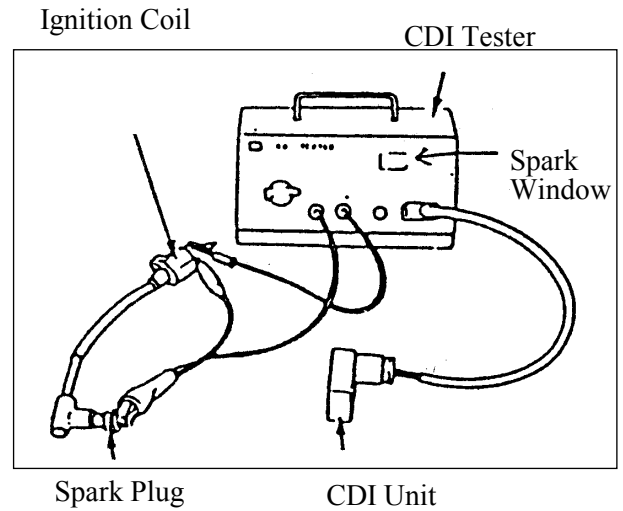

PULSER COIL

INSPECTION

Disconnect the pulser coil wire coupler and measure the resistance between the blue/white and green/white wire terminals.

Resistance: 92~138Ω

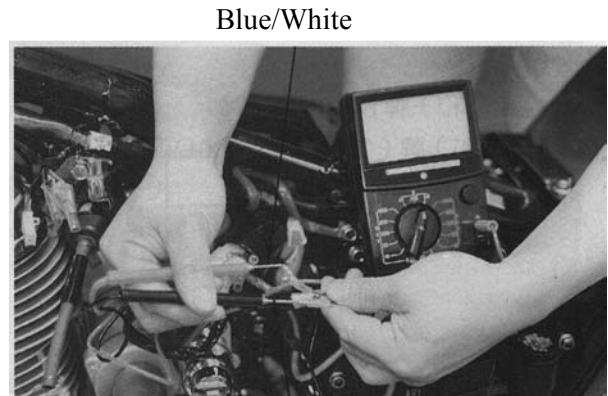

Green/White

EXCITER COIL

INSPECTION

Disconnect the exciter coil wire coupler and measure the resistance between the black/red wire terminal and ground.

Resistance: 272~408Ω

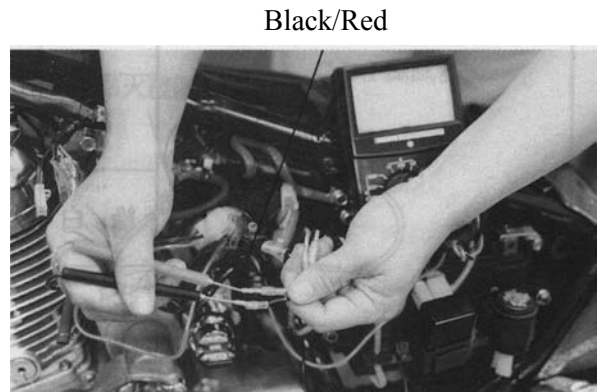

Black/Red

16. CHARGING SYSTEM

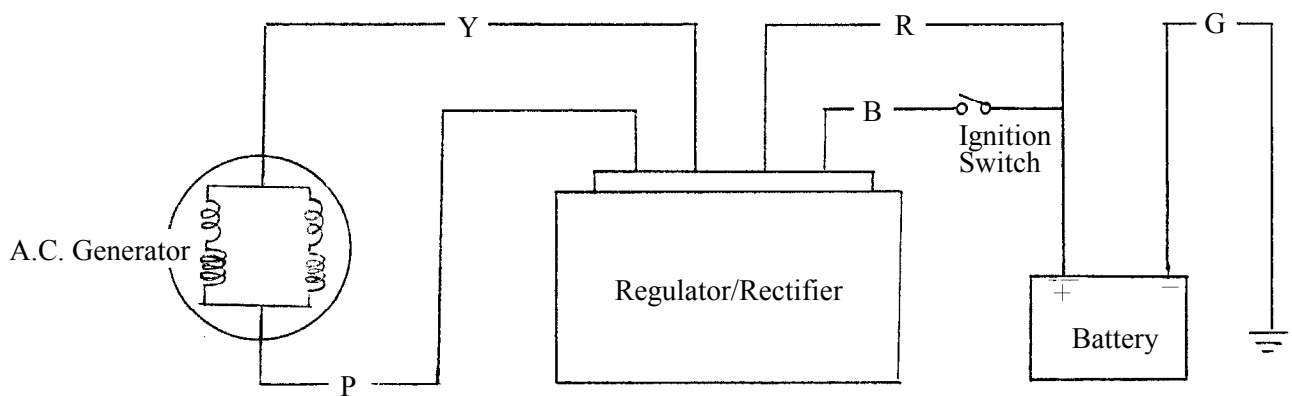
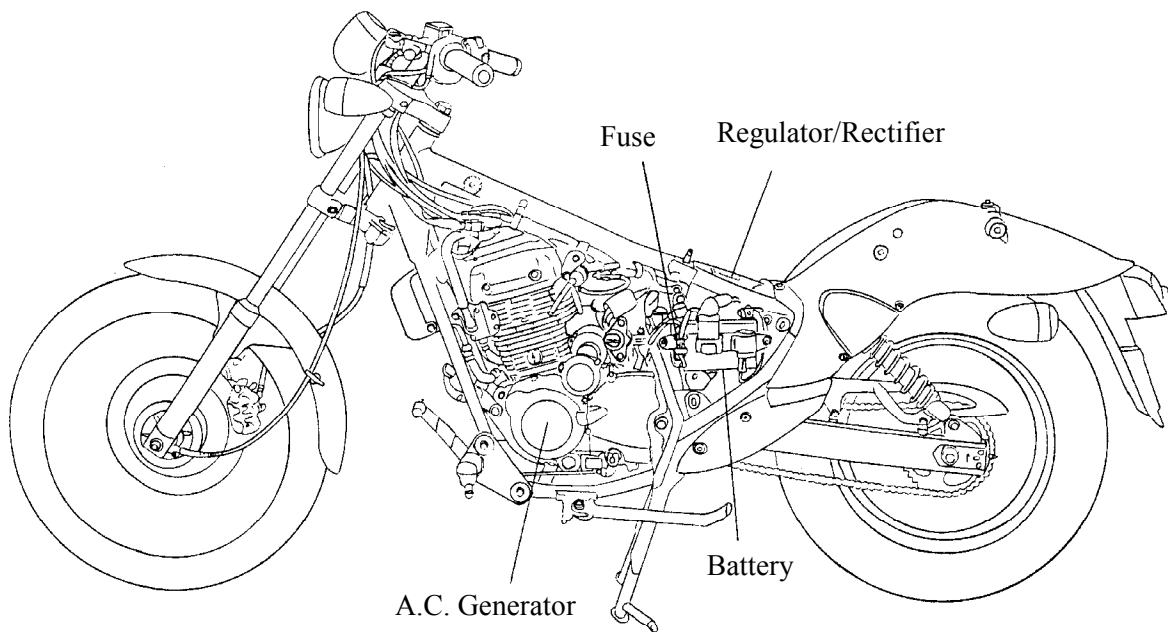

16. CHARGING SYSTEM

SERVICE INFORMATION.....	16-1	PERFORMANCE TEST.....	16-4
TROUBLESHOOTING.....	16-2	A.C. GENERATOR.....	16-4
BATTERY.....	16-3	REGULATOR/RECTIFIER.....	16-5

SERVICE INFORMATION

GENERAL INSTRUCTIONS

- The battery is a MF battery which needs no refilling of distilled water.
- Do not quick charge the battery. Be sure to use a MF battery charger and the battery temperature should not exceed 45°C.
- Remove the battery from the motorcycle for charging. If the battery must be charged on the motorcycle, keep sparks and flames away from a charging battery.
- When inspecting the A.C. generator, use an electric tester.
- Route the charging system wires properly to avoid shorted wire due to wires being twisted or kinked.

SPECIFICATIONS

Battery capacity		12V7AH
Electrolyte specific gravity		1,260~1,280 20°C
Charging current		7.0A max.
A.C. generator	Charging rpm	2,100 rpm (min.)
	Capacity	11A min./3,000 rpm
Regulator/Rectifier		No contact point type
Charging coil resistance		0.2~0.3Ω

TORQUE VALUES

A.C. generator stator bolt	0.8~1.2kg-m
A.C. generator rotor bolt	5.5~6.5kg-m

SPECIAL TOOLS

Flywheel holder
Flywheel puller

TESTING INSTRUMENTS

Kowa electric tester
Sanwa electric tester

16. CHARGING SYSTEM

TROUBLESHOOTING

No power

- Dead battery
- Fuse burned out
- Disconnected battery cable
- Faulty ignition switch

Low power

- Weak battery
- Loose battery connection (terminal)
- Charging system failure
- Faulty regulator/rectifier

Intermittent power

- Loose battery cable connection
- Loose charging system connection
- Loose lighting system connection

Charging system failure

- Loose, broken or shorted wire or connector
- Faulty regulator/rectifier
- Faulty A.C. generator

16. CHARGING SYSTEM

BATTERY

REMOVAL

Remove the left side cover.
First disconnect the battery negative cable and then the positive cable.
Remove the two battery set plate lock nuts.
Remove the battery.

When disconnecting the battery positive (+) cable, do not touch the frame with tool; otherwise it will cause short circuit and sparks to damage the battery and ignite the gasoline.

The installation sequence is the reverse of removal.

First connect the positive (+) cable and then the negative (-) cable to avoid short circuit.

BATTERY VOLTAGE (OPEN CIRCUIT VOLTAGE) INSPECTION

Remove the left side cover.
Disconnect the battery cables.
Measure the voltage between the battery terminals.
Fully charged : 13.1V
Undercharged: 12.3V

* Battery charging inspection must be performed with a voltmeter.

CHARGING

Connect the charger positive (+) cable to the battery positive (+) terminal.
Connect the charger negative (-) cable to the battery negative (-) terminal.

• Keep flames and sparks away from a charging battery.
• Turn power ON/OFF at the charger, not at the battery terminals to prevent sparks near the battery to avoid explosion.
• Charge the battery according to the current specified on the battery.

* • Quick charging should only be done in an emergency.
• Measure the voltage 30 minutes after the battery is charged.

Charging current: Standard : 0.7A
Quick : 3.0A
Charging time : Standard : 5~10 hours
Quick : 1 hour
After charging: Open circuit voltage: 12.8V min.

Terminal (+) Set Plate Terminal (-) Battery

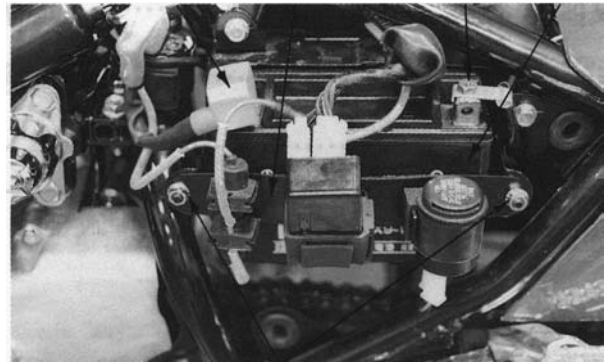

Lock Nuts

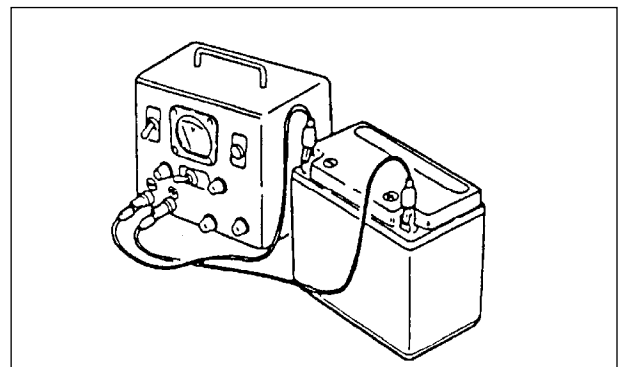
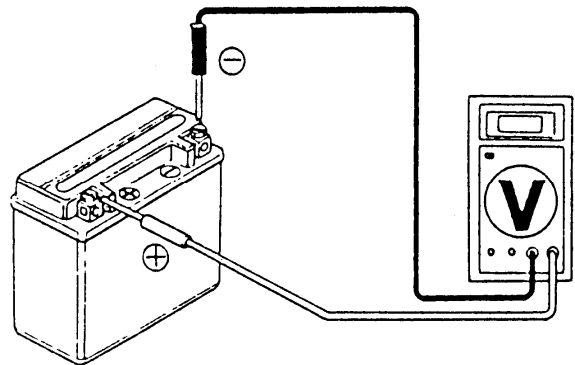

16. CHARGING SYSTEM

PERFORMANCE TEST

Perform this test with a fully charged battery. Start and warm up the engine for 10 minutes. Connect the battery positive cable to the ammeter positive probe and the battery negative cable to the ammeter negative probe.

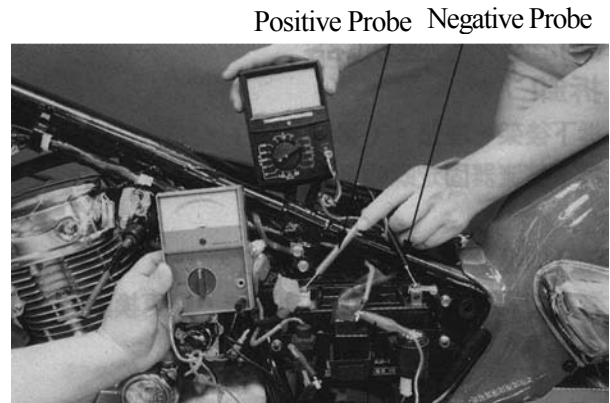

Negative Cable Positive Cable

Then connect the voltmeter across the battery terminals to test the charging voltage.

CHARGING PERFORMANCE:

Headlight Switch Position	Charging rpm	3000 rpm	8000 rpm
OFF (Day)	2150 rpm max.	4A 16V	6.3A 16.7V
ON (Night)	2150 rpm max.	1.1A 14V (1.0A min.)	2.1A 14V (3.7A min.)

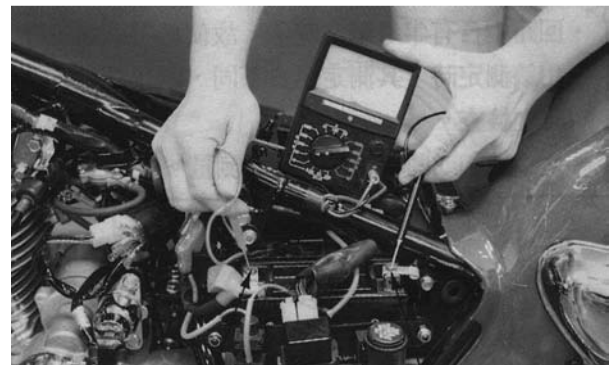

Positive Terminal Negative Terminal

Limit Voltage Test:

Start the engine and gradually increase the engine speed to measure the limit voltage.

Limit Voltage: 14.7±0.4V

Note: Test when the battery is fully charged.

* When testing the limit voltage, use a tachometer for operation.

A.C. GENERATOR

REMOVAL

Remove the A.C. generator. (Refer to 8-2.)

INSPECTION

Disconnect the A.C. generator pink and yellow wires and measure the resistance between the pin and yellow wires.

Resistance: 0.2~0.3Ω

* Do not connect the A.C. generator pink and yellow wires to ground wire.

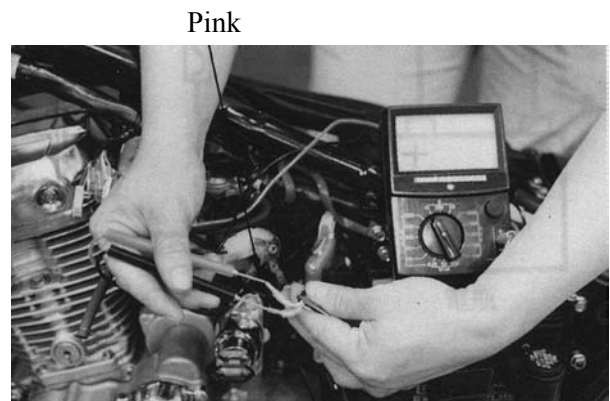

Yellow

16. CHARGING SYSTEM

REGULATOR/RECTIFIER

REMOVAL

Remove the rear carrier and seat. (Refer to 4-10.)

Remove the regulator/rectifier lock nut and disconnect the regulator/rectifier wire coupler.

Measure the resistances between the regulator/rectifier wire terminals. Replace the regulator/rectifier if the readings are not within the specifications in the table below.



Coupler

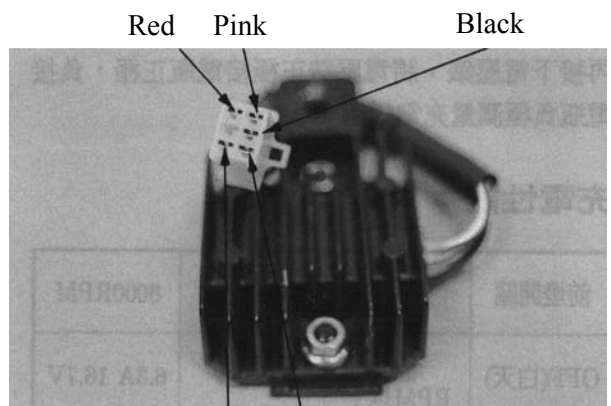

Yellow Green

* • Due to the semiconductor in circuit, it is necessary to use a specified tester for accurate testing. Use of an improper tester or measurements in an improper range may give false readings. Use a Sanwa Electric Tester or Kowa Electric Tester for testing.

Testing Range

Range for the Sanwa Tester: xKΩ

Range for the Kowa Tester: x100Ω

(+)Probe	Pink	Yellow	Red	Green	Black
(-)Probe					
Pink		∞	4-7K	∞	∞
Yellow	∞		4-7K	∞	∞
Red	∞	∞		∞	∞
Green	4-6K	4-6K	13-17K		1-2K
Black	4-7K	4-7K	13-17K	1-2K	

Note: The readings in this table are taken with a Sanwa Tester.

17. STARTING SYSTEM

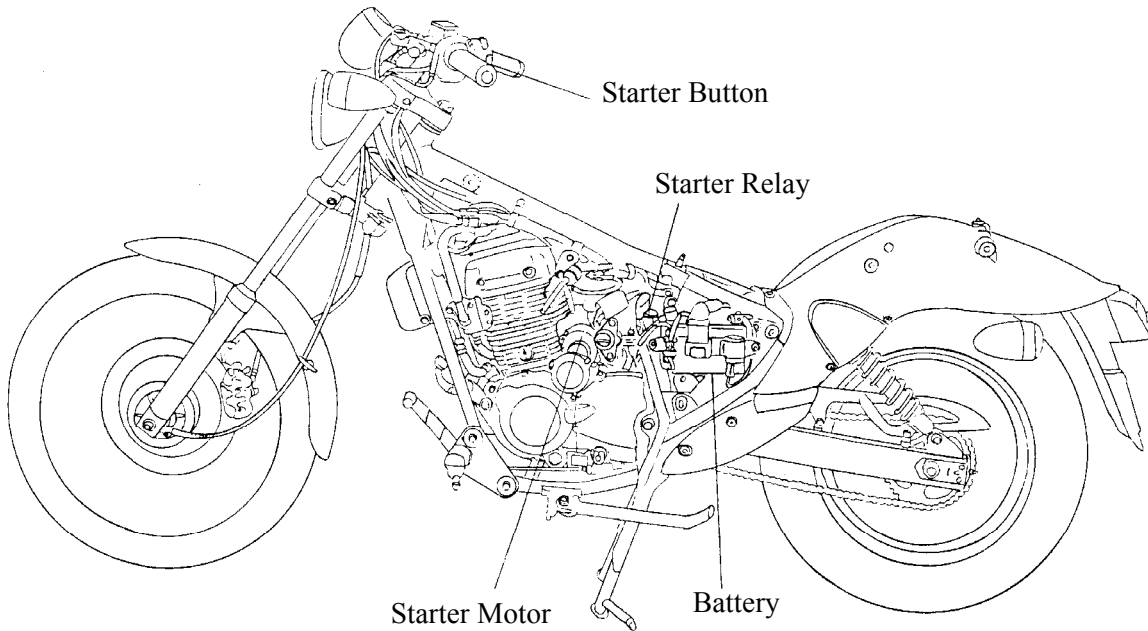

17

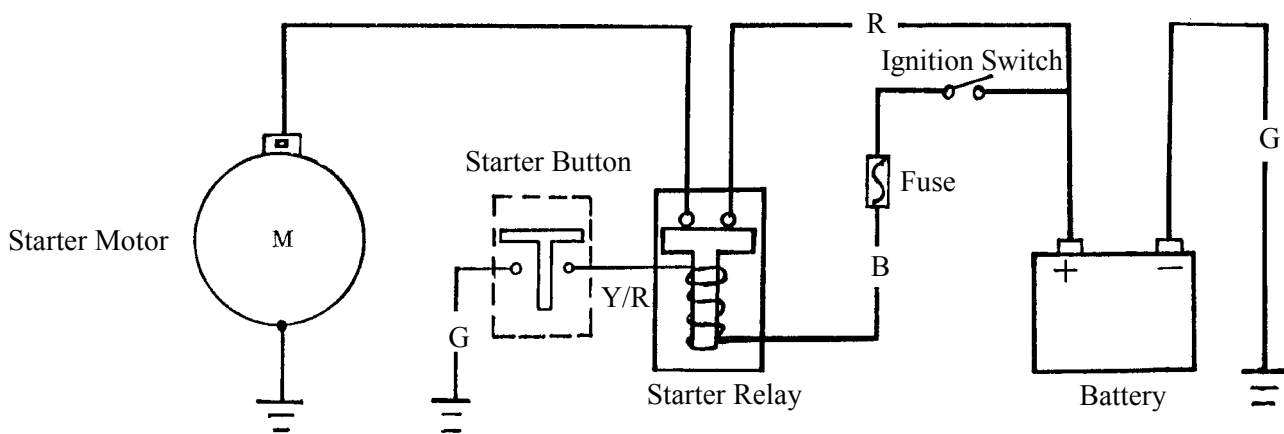

17. STARTING SYSTEM

STARTING SYSTEM DIAGRAM	17-0	STARTER MOTOR	17-2
SERVICE INFORMATION	17-1	STARTER RELAY	17-5
TROUBLESHOOTING	17-1		

SERVICE INFORMATION

GENERAL INSTRUCTIONS

- The removal of starter motor can be accomplished with the engine installed in the frame.
- Refer to Section 8-3 for the removal of starter clutch.
- When connecting the starting system wires, connect them securely to avoid hard starting due to poor connection.

SPECIFICATIONS

Item	Standard (mm)	Service Limit (mm)
Starter motor brush length	—	8.5

TORQUE VALUES

Starter motor bolt	0.3~0.4kg-m
Starter clutch lock nut	1.2kg-m

SPECIAL TOOLS

Flywheel puller
Flywheel holder

TROUBLESHOOTING

Starter motor won't turn

- Fuse burned out
- Weak battery
- Faulty ignition switch
- Faulty starter clutch
- Faulty starter relay
- Poorly connected, broken or shorted wire
- Faulty starter motor

Lack of power

- Weak battery
- Loose wire or connection
- Foreign matter stuck in starter motor or gear

Starter motor rotates but engine does not start

- Faulty starter clutch
- Reverse rotation of starter motor
- Weak battery

17. STARTING SYSTEM

STARTER MOTOR

REMOVAL

* Before removing the starter motor, turn the ignition switch OFF and remove the battery ground. Then, turn on the ignition switch and push the starter button to see if the starter motor operates properly.

Remove the starter motor wire lock nut. Remove the two starter motor mounting bolts and the motor.

DISASSEMBLY

Remove the two starter motor case bolts to remove the front cover, rear cover, commutator, housing and other parts.

INSPECTION

Inspect the removed parts. Inspect the commutator for wear, damage, discoloration and other visual faults. Replace if necessary. Clean the commutator if there is metal powder between the segments.

Check for continuity between pairs of the commutator segments and there should be continuity. Also, make a continuity check between individual commutator segments and the armature shaft. There should be no continuity.

Wire Lock Nut

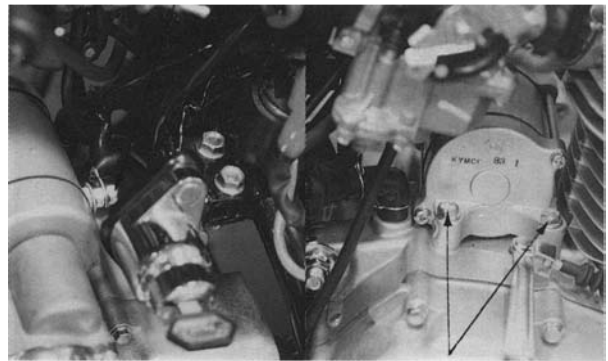

Mounting Bolts

Front Cover

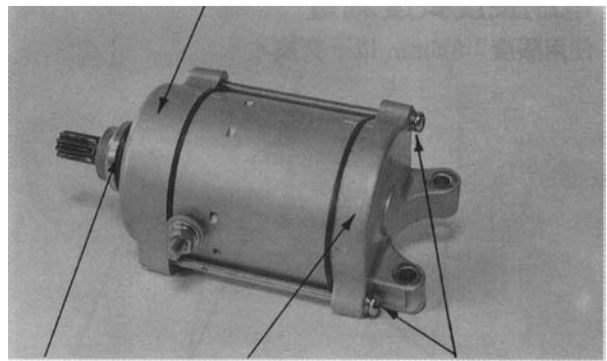

O-ring

Rear Cover

Case Bolts

Commutator

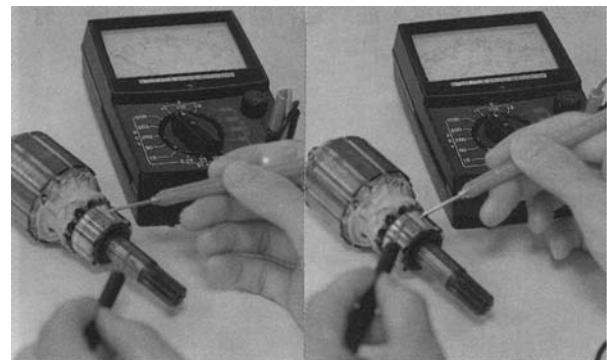
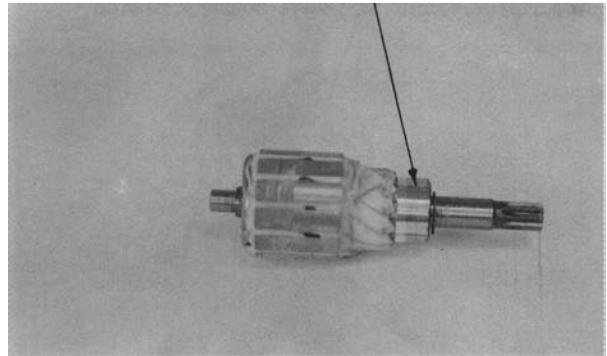

17. STARTING SYSTEM

STARTER MOTOR HOUSING CONTINUITY CHECK

Check to confirm that there is no continuity between the starter motor wire terminal and the motor housing.

Also check for the continuity between the wire terminal and each brush. There should be continuity.

Replace if necessary.

Wire Terminal

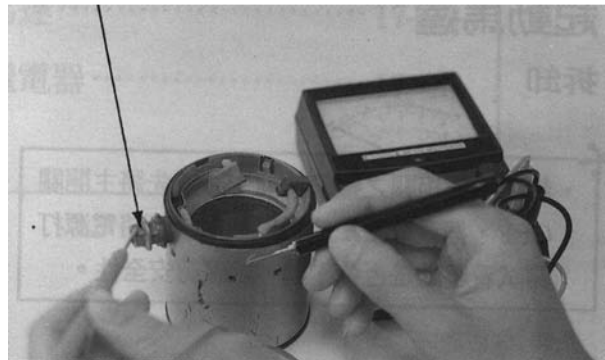

Measure the length of the brushes.

Service Limit: 8.5mm replace if below

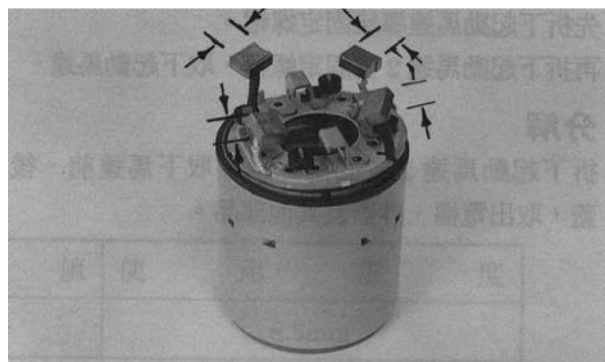

Check for continuity between the brushes.

Replace if there is continuity.

Brushes



Check if the bearing in the front cover turns freely and has no excessive play.

Check the oil seal for wear or damage.

Replace if necessary.

Front Cover

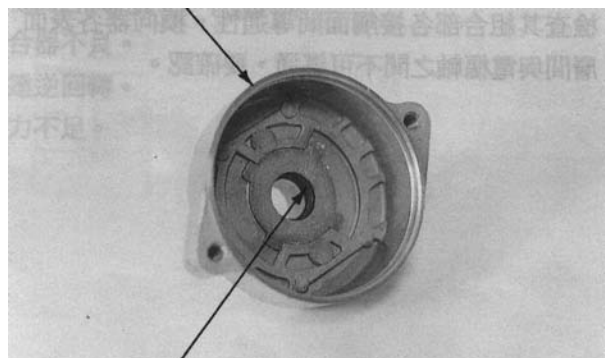

Oil Seal

17. STARTING SYSTEM

Check if the bearing in the rear cover turns freely and has no excessive play.
Replace if necessary.

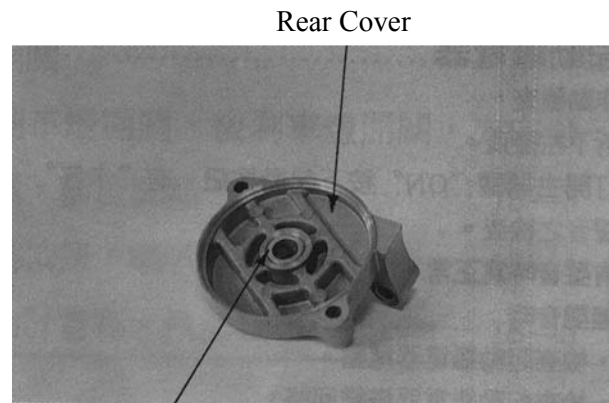

Bearing

ASSEMBLY

First remove the brush springs and then install the brushes onto the brush holders. Insert the commutator into the starter motor housing.

- * Be careful not to damage the brush and commutator contacting surfaces.

Apply a thin coat of grease to the rear cover bearing and then install the washers and rear cover.

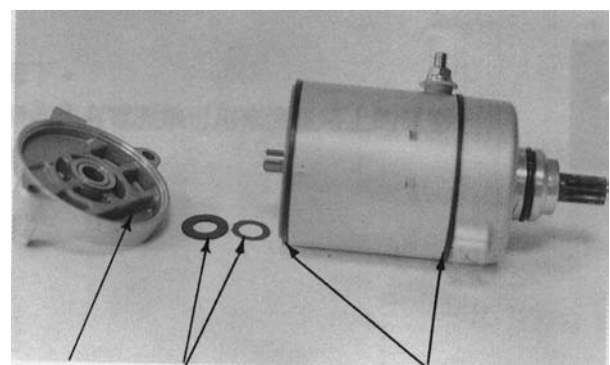

Rear Cover Washers O-rings

Install the brush springs.

- * Make sure that the brushes move freely after installation.

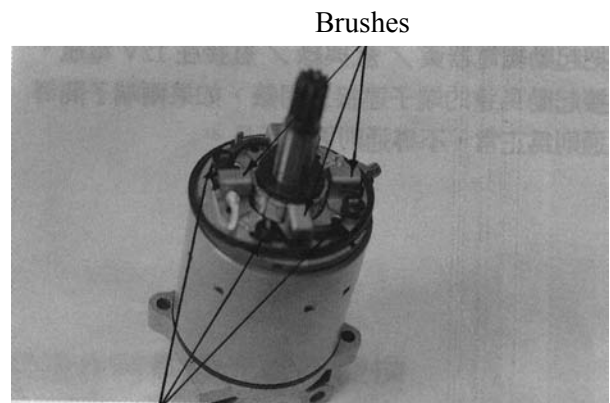

Springs

Apply a thin coat of grease to the front cover oil seal and bearing. Install the O-ring and front cover onto the motor body.

- * Be careful not to damage the oil seal.
- * After the front and rear covers are installed, the punch marks must be aligned with each other.

Tighten the starter motor case bolts.

Torque: 0.8~1.2kg-m

After assembly, check the starter motor for proper operation.

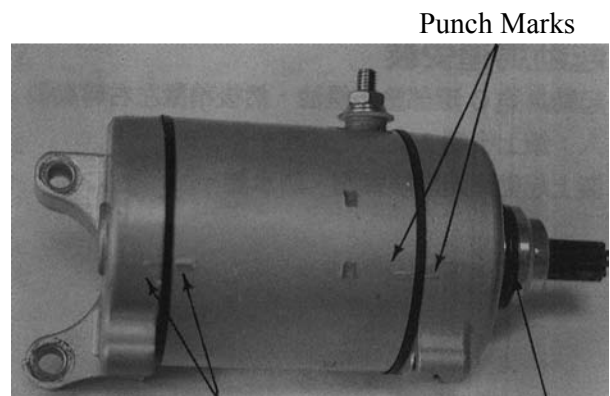

Punch Marks

O-ring

17. STARTING SYSTEM

STARTER RELAY

INSPECTION

Remove the left side cover.
Turn the ignition switch ON and the starter relay is normal if you hear a “click” when the starter button is depressed.

If there is no click sound:

- Inspect the starter relay voltage
- Inspect the starter relay ground circuit
- Check for continuity between the starter relay yellow/red and green/red wire terminals

Starter Relay

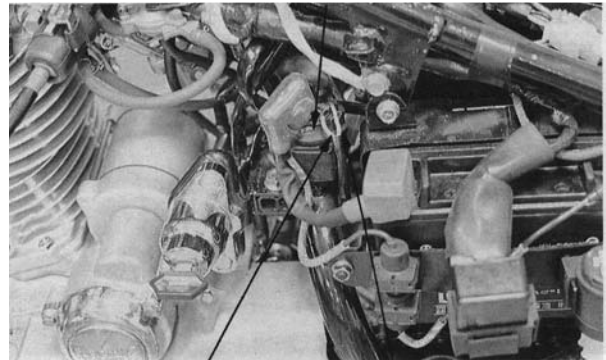

Green/Red

Yellow/Red

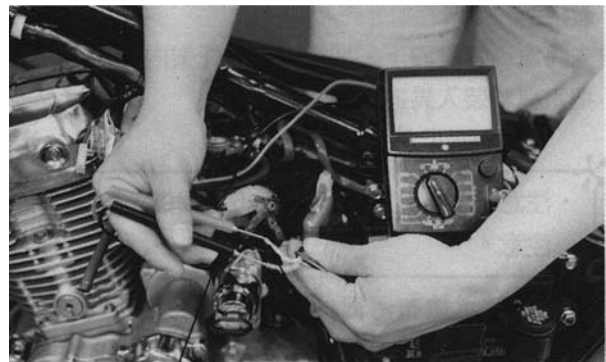

Yellow/Red

Green/Red

Green/Red

Connect the starter relay yellow/red and green/red wires to a 12V battery.
Connect the starter motor terminals to an electric tester and check for continuity between the two terminals.
The relay is normal if there is continuity.
Replace the starter relay with a new one if there is no continuity.

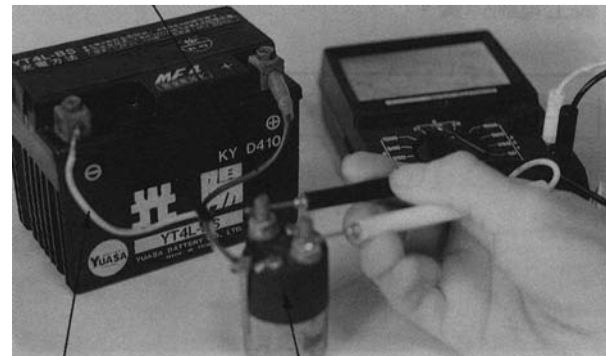

Yellow/Red

Starter Relay

STARTER MOTOR INSTALLATION

Apply engine oil to the starter motor O-ring and install the starter motor. Install and tighten the two mounting bolts.
Install the starter motor wire lock nut and waterproof cover.

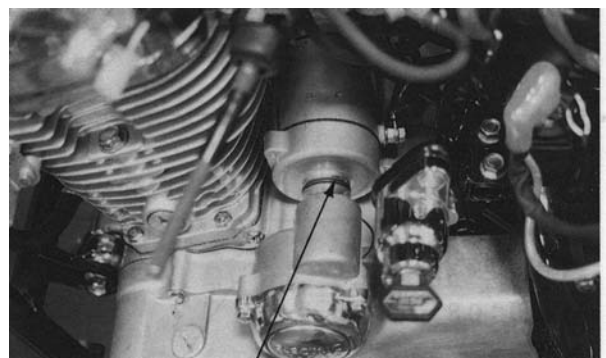

O-ring

18. LIGHTS/INSTRUMENTS/SWITCHES/HORN

SERVICE INFORMATION	18-0	IGNITION SWITCH.....	18-2
TROUBLESHOOTING.....	18-0	STARTER BUTTON/HORN BUTTON/	
HEADLIGHT.....	18-1	FUEL GAUGE.....	18-3
TURN SIGNAL LIGHT	18-2	HANDLEBAR SWITCHES	18-4
STOPLIGHT/TAILLIGHT	18-2	FUEL UNIT	18-6

SERVICE INFORMATION

GENERAL INSTRUCTIONS

- All plastic plugs have locking tabs that must be released before disconnecting.
- An electric tester must be used for checking the continuity between two points. The electric tester also contains a voltmeter which can be used to measure voltage.
- Different bulbs have different specifications. When replacing, use a new bulb of the same specifications to avoid damage of the electrical equipment.
- The continuity check of switches can be made without removing the switches from the motorcycle.

SPECIFICATIONS

Headlight	12V 35/35W
Stoplight/Taillight	12V 18/5W
Turn signal light	12V 10Wx4
Turn signal indicator light	12V 1.7W
Instrument light	12V 1.7Wx2
High beam indicator light	12V 1.7W
Fuse	15A

TROUBLESHOOTING

Light does not come on when ignition switch is "ON"

- Burned bulb
- Faulty ignition or light switch
- Fuse burned out
- Dead battery or loose battery wire

Light comes on but dims

- Weak battery
- Wire or switch resistance too high
- Aged bulb or faulty lighting circuit

Headlight beam does not change when dimmer switch is operated

- Faulty or burned bulb
- Faulty dimmer switch
- Loose wire connection

18. LIGHTS/INSTRUMENTS/SWITCHES/HORN

HEADLIGHT

REMOVAL

Remove the headlight band screw to remove the band.

Remove the headlight unit and disconnect the headlight wire coupler.

Remove the headlight bulb and bulb socket. Check the bulb for damage and replace with a new one if necessary.

Bolt

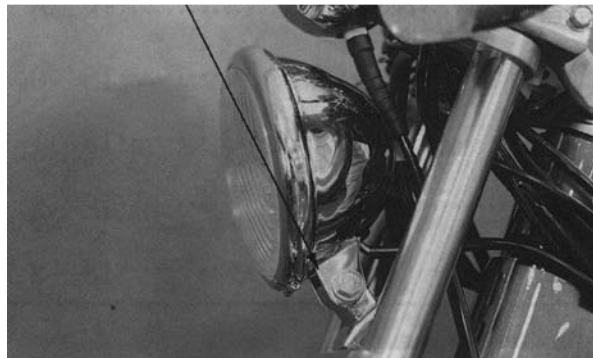

INSTALLATION

Install the headlight in the reverse order of removal.

*

After installation, adjust the headlight beam.

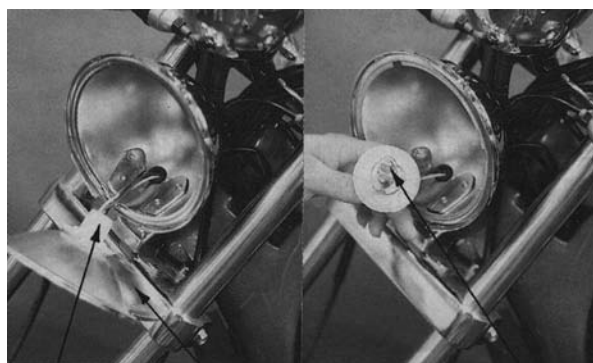

Bulb Socket

Headlight Unit

Bulb

INSTRUMENT (SPEEDOMETER)

REMOVAL

Disconnect the speedometer cable.

Disconnect the speedometer bulb wire coupler.

Remove the two bolts attaching the speedometer seat.

Remove the speedometer.

INSTALLATION

The installation sequence is the reverse of removal.

Instrument

Bolt

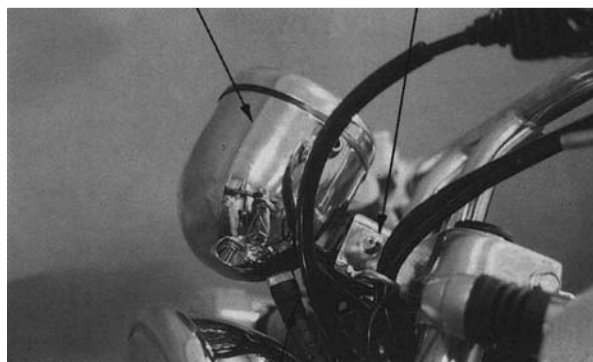

Speedometer Cable

18. LIGHTS/INSTRUMENTS/SWITCHES/HORN

TURN SIGNAL LIGHT

Remove the two turn signal light shell screws and the bulb.
 Check the bulb for damage and replace with a new one if necessary.
 The installation sequence is the reverse of removal.

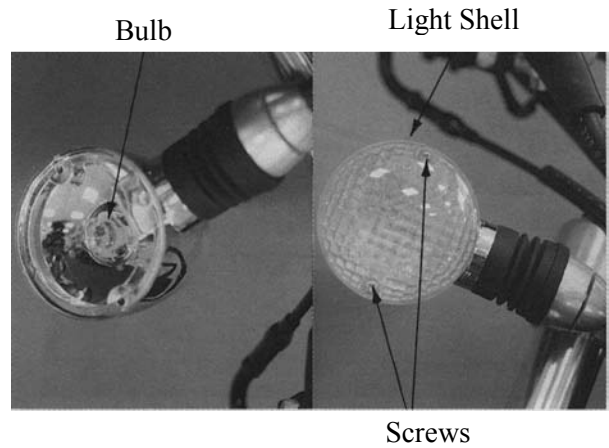

STOP LIGHT/TAILLIGHT

Remove the two taillight shell screws and the shell.
 Remove the bulb and check the bulb for damage. Replace with a new one if necessary.

Bulb Specification: 12V.18/5W

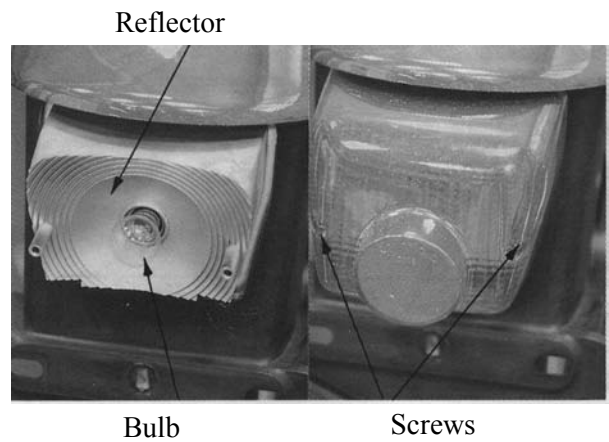

IGNITION SWITCH

Disconnect the ignition switch wire coupler.
 Remove the two bolts attaching the ignition switch.
 Remove the ignition switch.

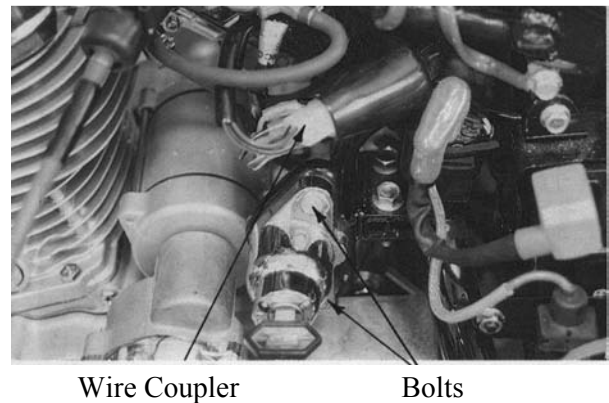

INSPECTION

Check for continuity between the wires indicated below.

Color Position	Black	Red	Black/ White	Green
OFF			○ — ○	○
ON	○ — ○			

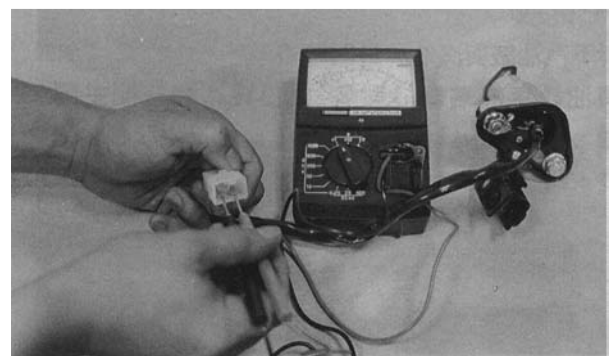

18. LIGHTS/INSTRUMENTS/SWITCHES/HORN

STARTER BUTTON

Remove the decorative covers under the fuel tank.

Disconnect the right switch wire coupler.

Check for continuity between the black and yellow/red wires.

Position \ Color	Black	Yellow/Red
FREE		
PUSH	○ —	○ —

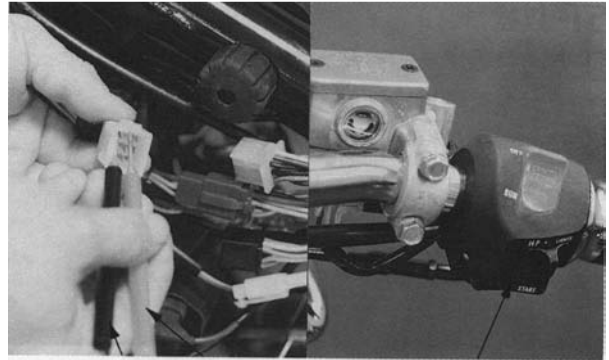

Yellow/Red Black

Starter Button

HORN BUTTON

Remove the decorative covers under the fuel tank.

Disconnect the left switch wire coupler.

Check for continuity between the black and light green wires.

Position \ Color	Black	Light Green
FREE		
PUSH	○ —	○ —

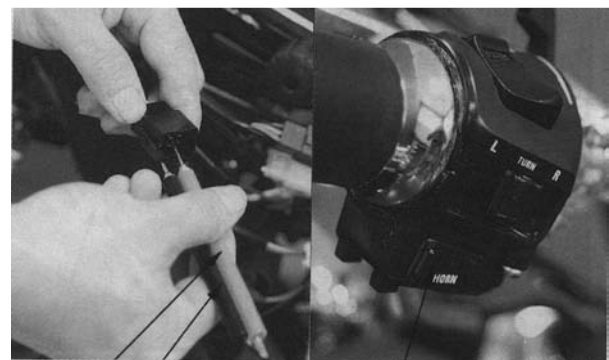

Black Light Green

Horn Button

Black

Light Green

HORN

Remove the steering head decorative cover.

Disconnect the horn wire coupler.

The horn is normal if it sounds when a 12V battery is connected across the horn wire terminals. Replace the horn if it does not sound.

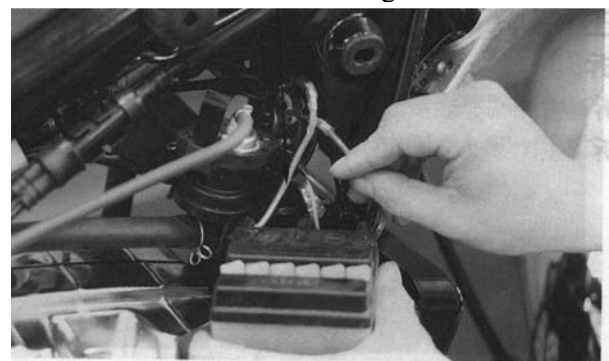

Fuel Gauge

FUEL GAUGE

Disconnect the fuel gauge and fuel unit wire couplers.

Connect the fuel gauge green wire with the yellow/white wire. Turn the ignition switch ON and the fuel gauge is normal if its needle moves from E to F and then moves from F to E when the ignition switch is turned OFF.

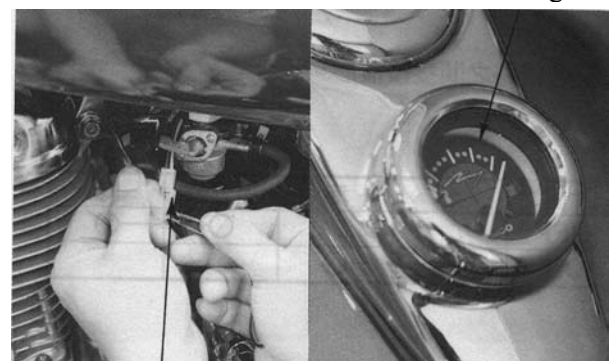

Fuel Gauge Wire Coupler

18. LIGHTS/INSTRUMENTS/SWITCHES/HORN

HANDLEBAR SWITCHES

FRONT STOP SWITCH

Disconnect the front stop switch wire coupler.
 Check for continuity between the front stop switch wires.
 Brake lever applied: There is continuity.
 Brake lever released: There is no continuity.

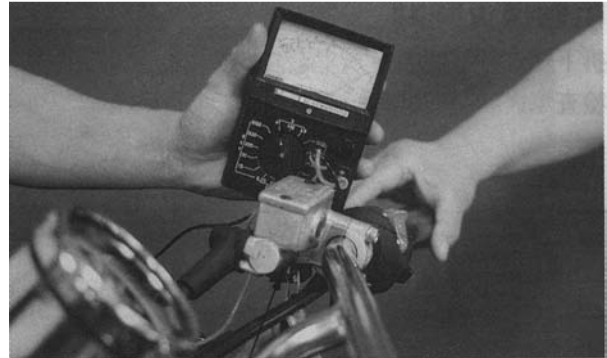

Front Stop Switch

REAR STOP SWITCH

Remove the right side cover.
 Disconnect the rear stop switch wire coupler.
 Check for continuity between the rear stop switch wires.
 Brake pedal depressed: There is continuity.
 Brake pedal released: There is no continuity.

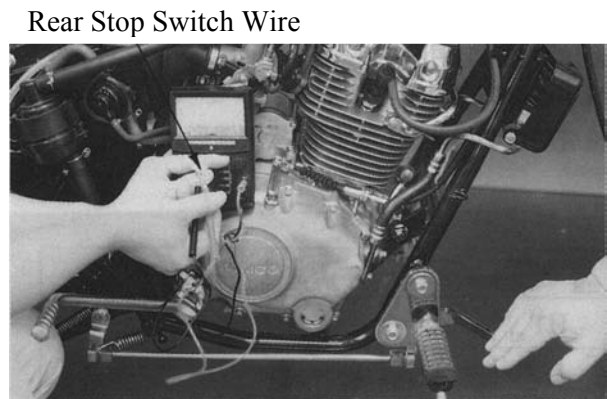

Rear Stop Switch Wire

TURN SIGNAL SWITCH

Disconnect the turn signal switch wire coupler.
 Check for continuity between the turn signal switch wires.

Color \ Position	Orange	Gray	Light Blue
R		○ — ○	○
L	○ — ○		

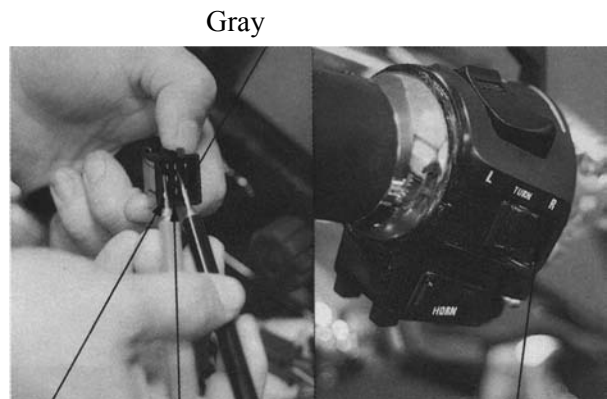

Gray

Light Blue Orange Turn Signal Switch
 Blue/White Black Headlight Switch

HEADLIGHT SWITCH

Disconnect the headlight switch wire coupler.
 Check for continuity between the headlight switch wires.

Color \ Position	Black	Brown	Blue/White
●			
P	○ — ○		
H	○ — ○	○ — ○	○



Brown

18. LIGHTS/INSTRUMENTS/SWITCHES/HORN

ENGINE STOP SWITCH

Disconnect the engine stop switch wire coupler.
Check for continuity between the engine stop switch wires.

Color Position	Black/White	Green
OFF	○ — ○	○ — ○
RUN		

Green Black/White

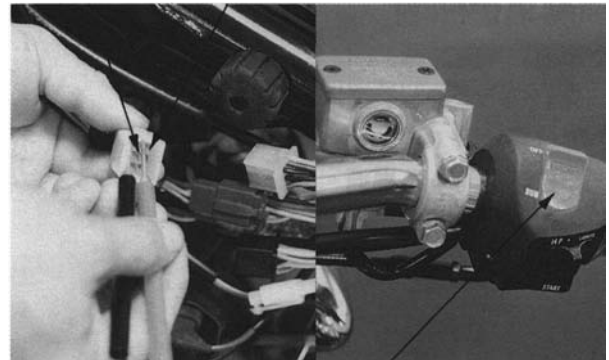

Engine Stop Switch

DIMMER SWITCH

Disconnect the dimmer switch wire coupler.
Check for continuity between the dimmer switch wires.

Color Position	Blue/White	Blue	White	Black
HI	○ — ○			
LO	○ — ○		○ — ○	
PASSING		○ — ○		○ — ○

Blue/White Black Dimmer Switch

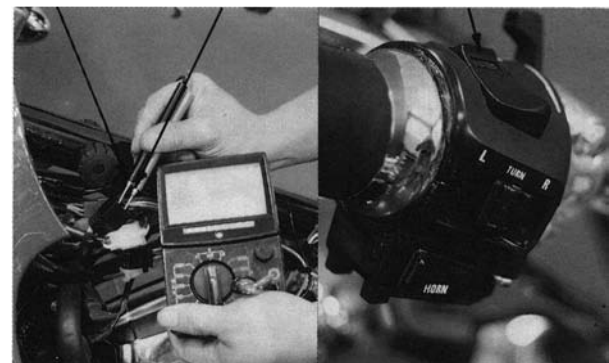

18. LIGHTS/INSTRUMENTS/SWITCHES/HORN

FUEL UNIT

- * Keep flames and sparks away from the working area.

REMOVAL

Remove the seat and fuel tank. (Refer to 4-10.)
Remove the four fuel unit attaching nuts.
Remove the fuel unit.

- * Be careful not to bend or damage the fuel unit float arm.

Fuel Unit

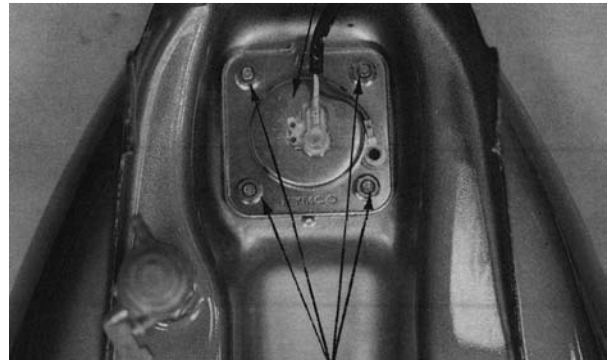

Nuts

INSPECTION

Check the fuel unit O-ring for wear, damage or deformation. Replace if necessary.
Measure the resistances between the fuel unit wire terminals with the float at the upper (Full) and lower (Empty) positions.

Resistances: Upper (Full): 9~25Ω

Lower (Empty): 70~100Ω

Connect the fuel unit wire coupler to the wire harness and turn the ignition switch ON.
Check the fuel gauge needle for correct indication by moving the float up and down.
If the needle does not move to "F" or "E", the fuel gauge is faulty and replace it with a new one.

If the needle swings, the fuel unit is faulty and replace it with a new one.

INSTALLATION

Install the fuel unit in the reverse of removal.

- * Check for fuel leakage after installation.

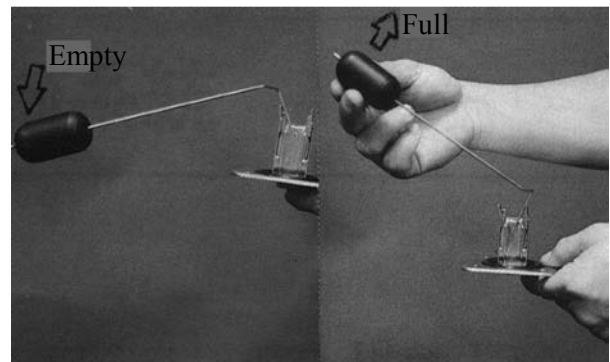

Fuel Gauge

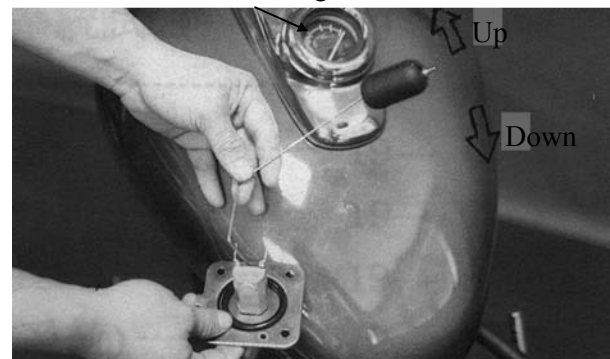

19. EVAPORATIVE/EXHAUST EMISSION CONTROL SYSTEM

19

EVAPORATIVE EMISSION CONTROL SYSTEM

SCHEMATIC DRAWING	19- 1
EVAPORATIVE EMISSION CONTROL SYSTEM FUNCTION	19- 2
TROUBLESHOOTING.....	19- 2
SERVICE INFORMATION.....	19- 3
EVAPORATIVE EMISSION CONTROL SYSTEM MAINTENANCE SCHEDULE	19- 4
MOTORCYCLE ENGINE EVAPORATIVE EMISSION CONTROL SYSTEM TEST	19- 5
PURGE CONTROL VALVE REMOVAL	19- 6
PURGE CONTROL VALVE INSPECTION.....	19- 6
PURGE CONTROL VALVE INSTALLATION.....	19- 7
CHARCOAL CANISTER.....	19- 8
PCV (POSITIVE CRANKCASE VENTILATION) SYSTEM	19- 9
EXHAUST EMISSION RELATED SYSTEM INSPECTION	19-10
EXHAUST EMISSION TEST AND ADJUSTMENT	19-11

19. EVAPORATIVE/EXHAUST EMISSION CONTROL SYSTEM

SCHEMATIC DRAWING

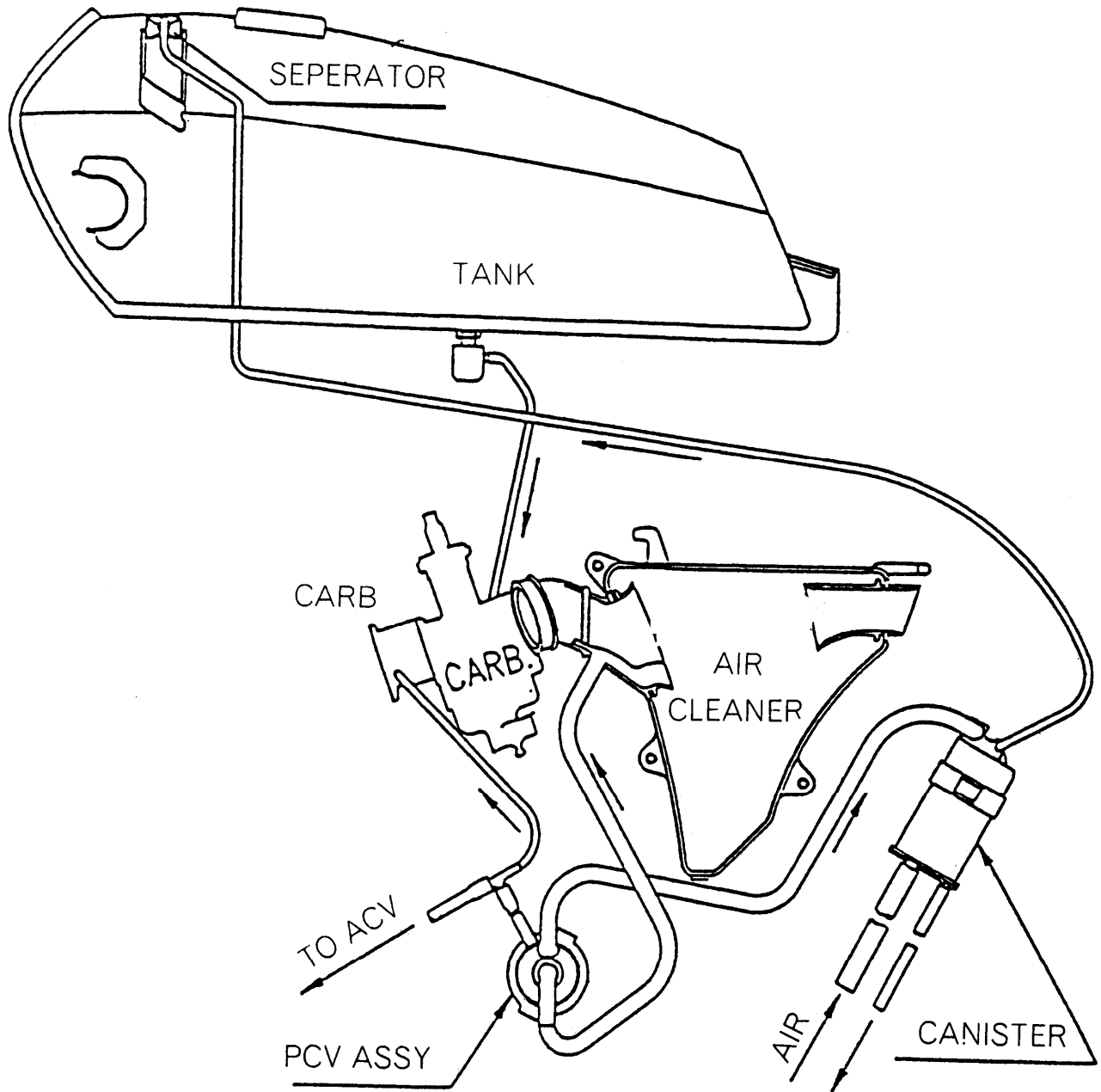

19. EVAPORATIVE/EXHAUST EMISSION CONTROL SYSTEM

EVAPORATIVE EMISSION CONTROL SYSTEM FUNCTION

FOREWORD:

The Evaporative Emission Control System is abbreviated to E.E.C. System. This device collects the fuel vapor from the carburetor and fuel tank and then the fuel vapor is drawn into the engine for re-burning to avoid air pollution caused by the fuel vapor diffused into the air.

FUNCTION

Item	Purpose	Function
Purge Control Valve	Control vaporized HC from fuel tank not to diffuse into the air.	The charcoal canister absorbs vaporized HC from the fuel tank. When the engine is running and the purge control valve is open, the fuel vapor in the charcoal canister is drawn into the engine for re-burning.
Charcoal Canister	Absorb and store the vaporized HC from the fuel tank and carburetor.	The vaporized HC is absorbed in the charcoal canister and the specified volume of HC in the emission should not exceed 2g.
P.C.V. System	Completely recover the HC from blow-by gas in the crankcase for re-burning.	Through the P.C.V. system, the blow-by gas from the crankcase is separated into fuel vapor and fuel and then drawn into the cylinder for re-burning.

TROUBLESHOOTING

Engine loses power or runs erratic at idle speed

1. Clogged P.C.V. system
2. Clogged air cleaner
3. Faulty purge control valve
4. Loose or broken E.E.C. system tubes

Engine idles or accelerates roughly

1. Faulty fuel cut-off valve
2. Faulty purge control valve
3. Clogged or faulty charcoal canister

19. EVAPORATIVE/EXHAUST EMISSION CONTROL SYSTEM

SERVICE INFORMATION

GENERAL INSTRUCTIONS

- Do not smoke or allow flames or sparks near the working area.
- Note the locations of tubes for proper installation.
- Replace any damaged tube with a new one.
- Make sure to tighten the connector of each tube securely.

TOOLS

- Vacuum pump — A937X—014—XXXX
- Pressure pump —

SPECIFICATIONS

Purge control valve vacuum pressure	45mm/Hg
Charcoal canister capacity	90cc

19. EVAPORATIVE/EXHAUST EMISSION CONTROL SYSTEM

1. EMISSION CONTROL SYSTEM MAINTENANCE SCHEDULE:

Item		Inspection	Service Mileage (KM)						
			300	1000	3000	5000	7000	9000	11000
Engine Parts	Drive belt	Belt thickness					○		
	Drive chain	Chain tension & length		○	○	○	○	○	○
	Cam chain	Chain length		○	○	○		○	
	Valve clearance	IN/EX clearance		○	○	○		○	
	Manifold & cylinder head bolts	Bolts	○			○			○
	Air Cleaner	Clean or replace air cleaner element	Clean at every 3000km and replace if necessary						
	Cooling water	Check for engine cooling	Replace at every 10000km or every year						
	Engine oil	Engine lubrication	○	Replace at every 1000km					
	Gear oil	Inspect or change gear oil	○			○			○
Fuel System	Fuel filter	Clean or replace fuel filter screen							○
	Choke system	Check for proper operation			○	○		○	
	Fuel line connectors	Check for leaks, block or breakage		○	○	○			
	Carburetor idle speed	Inspect, clean or adjust		○	○	○	○	○	○
	Oil filter	Clean filter screen	○			○			○
Ignition Parts	Ignition timing	Inspect ignition timing		○	○	○	○	○	○
	Spark plug	Clean, inspect or replace		○	○	○	○	○	○
	Ignition wires	Check wire connectors		○	○	○	○	○	○
Exhaust Emission Control System	Secondary air inlet line	Check for leaks, clogged or loose tube connection		○	○	○	○	○	○
	Intake manifold bolt	Check manifold connector and replace if necessary		○	○	○	○	○	○
Evaporative Emission Control System	Engine compartment pipe connection	Check for leaks, clogged or loose tube connection		○	○	○	○	○	○
	Charcoal canister	Check air vent hole for damage and clean it		○	○	○	○	○	○
	Purge control valve	Check for loose or broken tube connectors		○	○	○	○	○	○

2. EMISSION CONTROL SYSTEM IRREGULAR MAINTENANCE:

Item	Contents
*Burned crankshaft bearing	Before riding, inspect the engine for engine oil leaks to avoid crankshaft bearing burning during riding.
*Burned cylinder or piston	Long-time or severe use may cause worn or seized cylinder or piston. Clean or replace them with new ones.

19. EVAPORATIVE/EXHAUST EMISSION CONTROL SYSTEM

MOTORCYCLE ENGINE EVAPORATIVE EMISSION CONTROL SYSTEM TEST

A. LEAKAGE TEST PIPING DIAGRAM (SIMPLE)

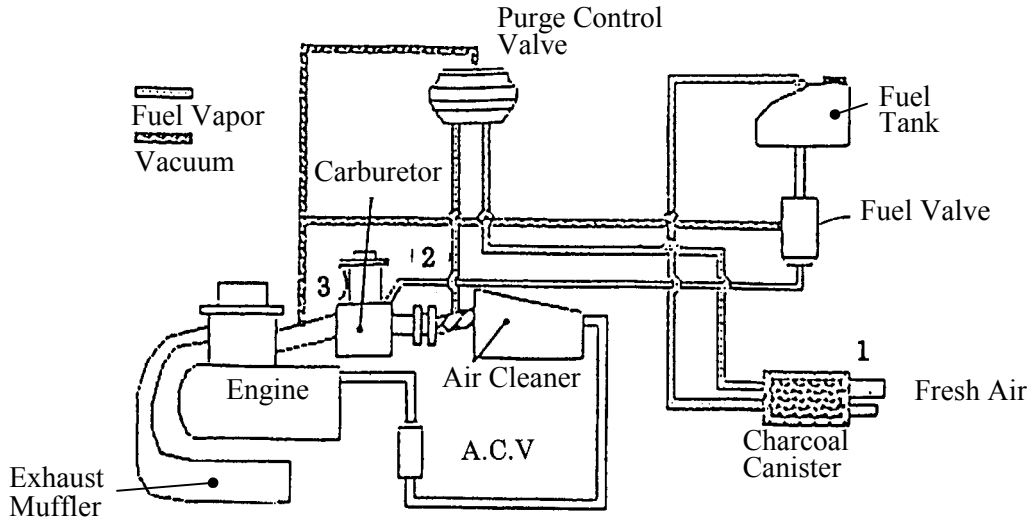

1. Charcoal Canister Plug (Point ①)

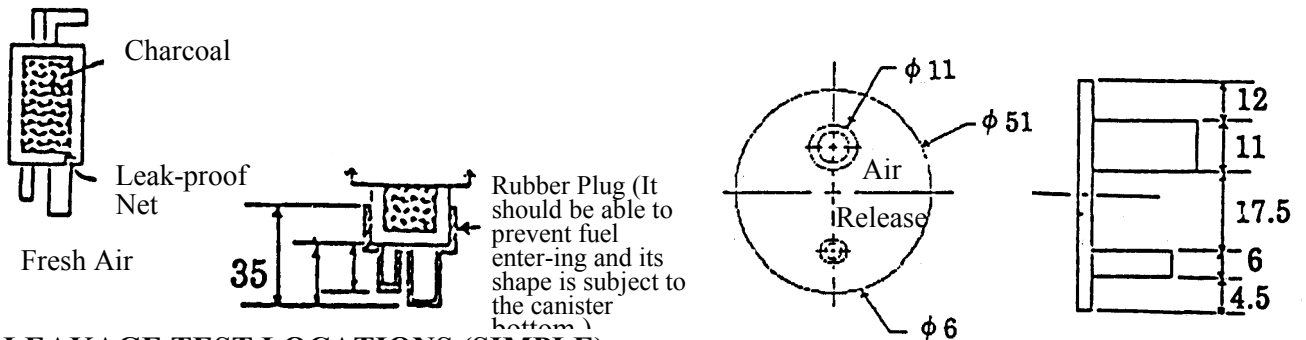

B. LEAKAGE TEST LOCATIONS (SIMPLE)

1. Charcoal canister, fuel tank (Point ②)
Blow compressed air into the tube at Point ② to test leakage.
2. Vacuum tube (Point ③)
Blow compressed air into the tube at Point ③ to test leakage.

C. LEAKAGE TEST DIAGRAM (SIMPLE)

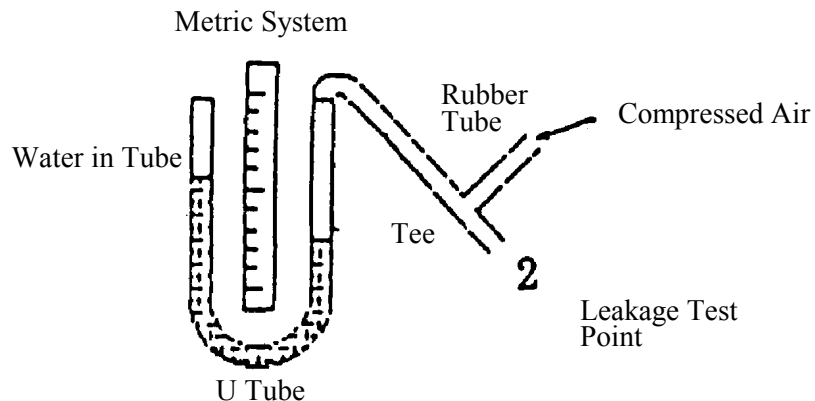

19. EVAPORATIVE/EXHAUST EMISSION CONTROL SYSTEM

PURGE CONTROL VALVE REMOVAL

1. Remove the frame right side cover.
2. Disconnect the purge control valve vacuum tube that goes to the carburetor and the tubes that go to the air cleaner and charcoal canister. Remove the purge control valve.

Purge Control Valve



To Air Cleaner To Charcoal Canister

PURGE CONTROL VALVE INSPECTION

Connect a vacuum pump to the purge control valve tube that goes to the air cleaner and apply vacuum pressure of 250mm/Hg. The specified vacuum must be maintained for one minute. Replace the purge control valve with a new one if vacuum is not maintained.

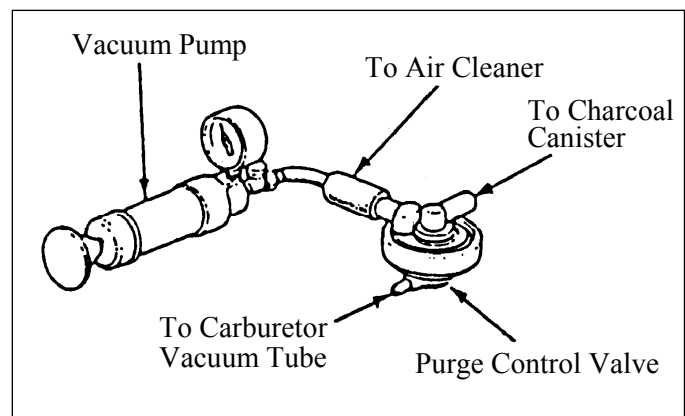

Connect a vacuum pump to the purge control valve tube that goes to the carburetor vacuum tube and apply vacuum pressure of 45mm/Hg. The specified vacuum must be maintained for one minute. Replace the purge control valve with a new one if vacuum is not maintained.

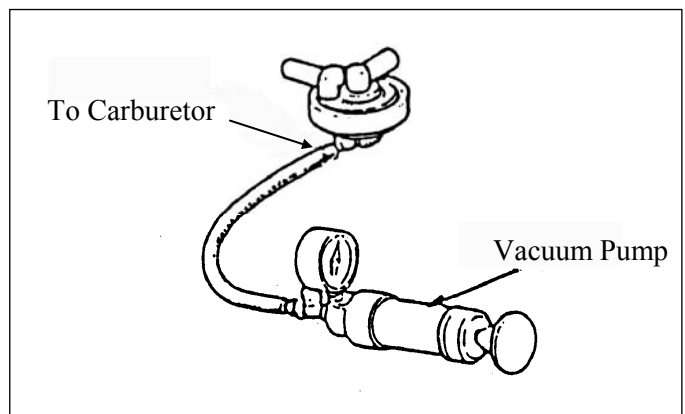

19. EVAPORATIVE/EXHAUST EMISSION CONTROL SYSTEM

PURGE CONTROL VALVE FLOW INSPECTION

1. Connect a vacuum pump to the purge control valve vacuum tube that goes to the carburetor and apply vacuum pressure of 45mm/Hg.
2. Connect a pressure pump to the tube that goes to the charcoal canister and apply pressure. The flow must be over 9.4 liters per minute and replace the purge control valve with a new one if the specified flow is not reached.

* To prevent damage to the purge control valve, do not use high air pressure sources. Use a hand operated pressure pump only.

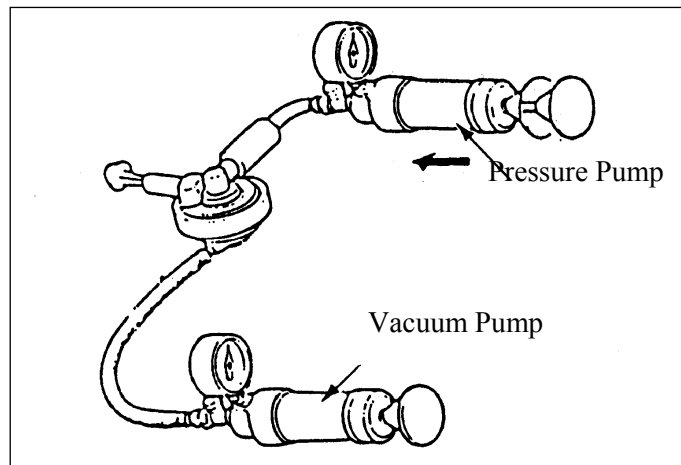

INSTALLATION

1. Install the purge control valve in the reverse order of removal.
2. Route and reconnect the purge control valve tubes properly and securely.

* Be careful not to bend, twist or kink the tubes during installation.

Purge Control Valve



To Air Cleaner

To Charcoal Canister

19. EVAPORATIVE/EXHAUST EMISSION CONTROL SYSTEM

CHARCOAL CANISTER

REMOVAL

1. Remove the frame right side cover.
2. Disconnect the charcoal canister tubes that go to the fuel tank and purge control valve.
3. Remove the charcoal canister.

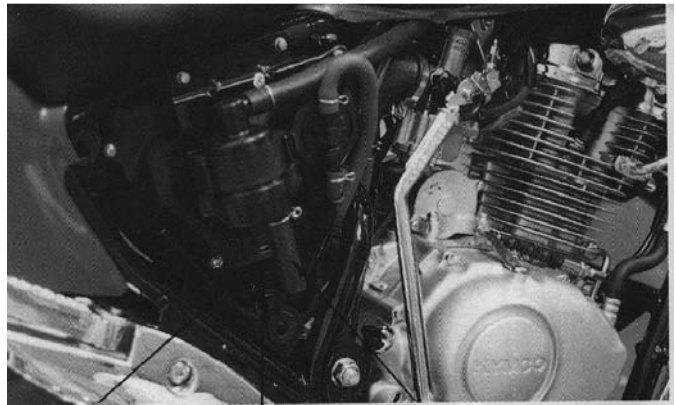

Charcoal Canister To Purge Control Valve To Air

INSPECTION

1. Plug the tube that goes to the fuel tank and plug the blow-by tube. Then connect a hose to the canister. Blow the hose with mouth. The charcoal canister is normal if air can be blown into it. If clogged, replace it with a new one.
2. Check the charcoal for cracks and replace if necessary.

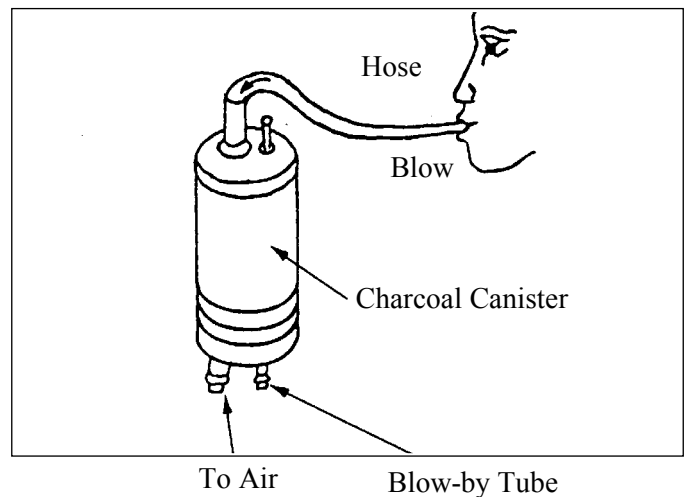

INSTALLATION

Install the charcoal canister in the reverse order of removal.

*

- The charcoal canister must be installed to its original position to avoid affecting its performance.
- Do not bend, twist or kink the tubes during installation.

19. EVAPORATIVE/EXHAUST EMISSION CONTROL SYSTEM

P.C.V. (POSITIVE CRANKCASE VENTILATION) SYSTEM

P.C.V. REMOVAL

Remove the P.C.V. tubes that go to the air cleaner and crankcase.

Remove the P.C.V.

P.C.V.

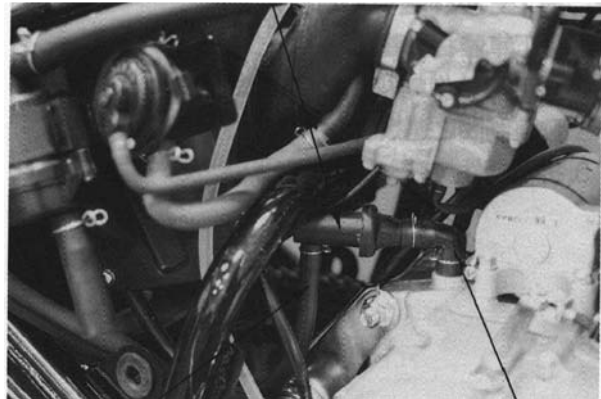

To Air Cleaner

To Crankcase

P.C.V. INSPECTION

Blow compressed air into the P.C.V. tube that goes to the crankcase. If air can be blown into it, the P.C.V. is normal. If clogged, replace it with a new one.

To Air Cleaner

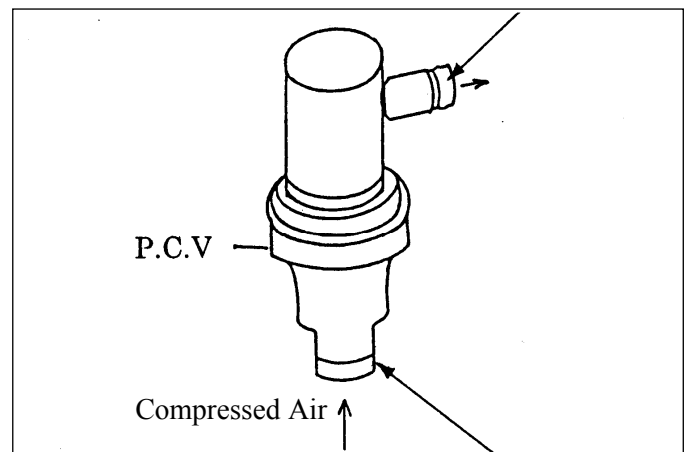

To Crankcase

P.C.V. INSTALLATION

1. Install the P.C.V. in the reverse order of removal.
2. Connect each tube properly.
3. The P.C.V. must be installed upright without tilting.

19. EVAPORATIVE/EXHAUST EMISSION CONTROL SYSTEM

EXHAUST EMISSION RELATED SYSTEM INSPECTION

AIR CLEANER CLEANING

1. Remove the frame right side cover and emission control system plate.
2. Remove the air cleaner cover screws and the air cleaner cover.
3. Remove the air cleaner element.
4. Wash the element, squeeze out and allow to dry. Soak the element in engine oil and squeeze out the excess oil.
5. Install the air cleaner element in the reverse of removal.

*

- Be sure to install the air cleaner properly to avoid dust entering the cylinder.

Air Cleaner Screen

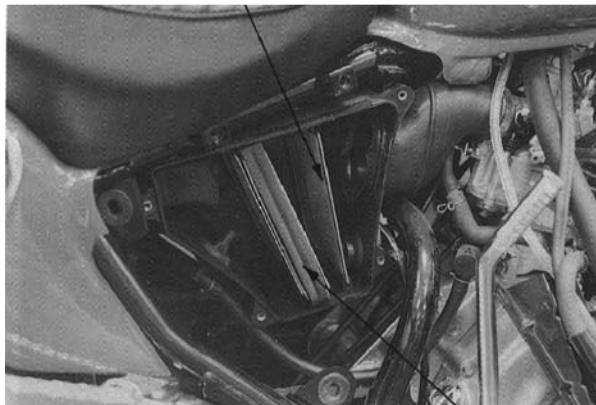

Air Cleaner Element

CARBURETOR REMOVAL/ CLEANING

1. Remove the throttle valve and spring.
2. Remove the accelerating pump.
3. Remove the four float chamber screws and float chamber.
4. Remove the float pin and float.
5. Remove the main jet and slow jet. Clean the jets with compressed air.
6. Remove the pilot screw and throttle stop screw.
7. Clean all passages with compressed air.

*

- When removing the pilot screw, record the number of rotations.

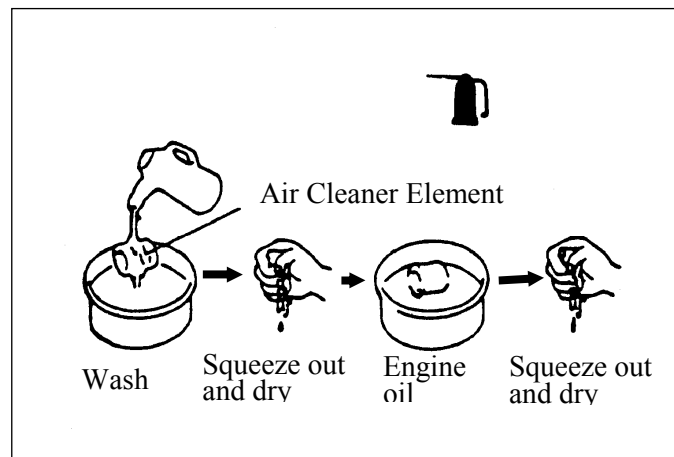

CARBURETOR INSTALLATION

Install the carburetor in the reverse order of removal.

*

- When removing the accelerating pump diaphragm, do not twist or damage it.

Slow Jet

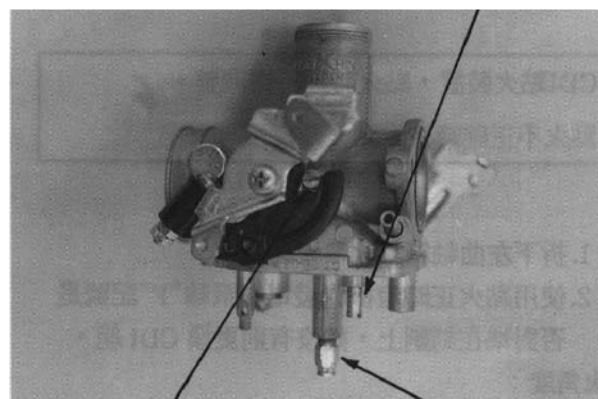

Throttle Stop Screw

Main Jet

19. EVAPORATIVE/EXHAUST EMISSION CONTROL SYSTEM

CARBURETOR ADJUSTMENT

1. Start and warm up the engine for five minutes. Adjust the pilot screw to find the highest idle speed.
2. Turn the throttle stop screw to obtain the specified idle speed of 1600 ± 100 rpm.
3. Rotate the throttle grip slightly to make sure the idle speed is maintained within the specified range.
4. If the engine misses or runs erratic, repeat the above steps.

Pilot Screw Opening: $2 \pm \frac{1}{2}$ turns

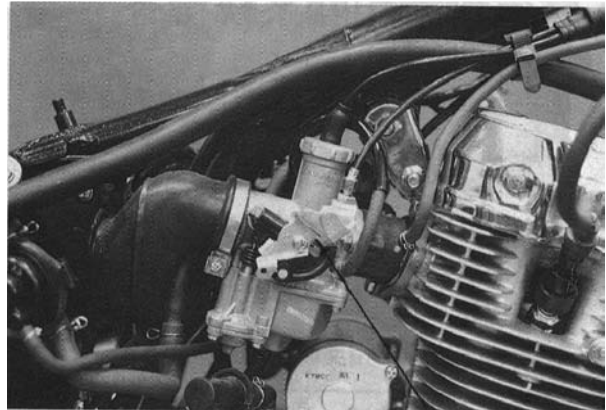

Throttle Stop Screw

SPARK PLUG INSPECTION/ CLEANING

1. Remove the spark plug.
2. Check the spark plug for wear, damage and fouling deposits. Clean any fouling deposits with a spark plug cleaner or a wire brush.

Specified Spark Plug: DR8EA

Spark Plug Gap: $0.6 \sim 0.7$ mm

* When installing, first screw in the spark plug by hand and then tighten it with a spark plug wrench.

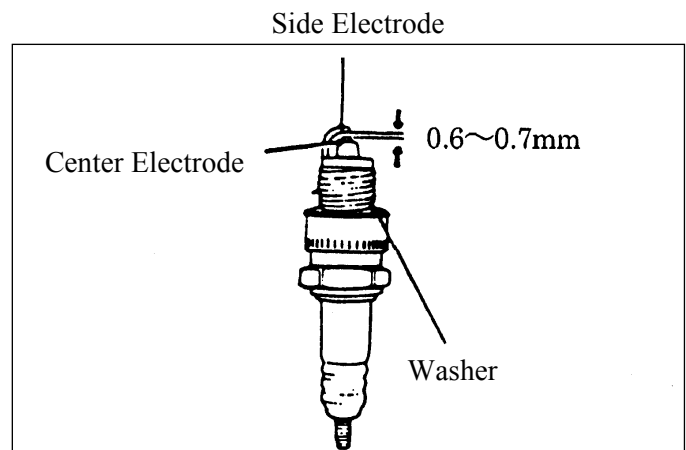

IGNITION SYSTEM INSPECTION

* The CDI unit is not adjustable. If the ignition timing is incorrect, check the ignition system.

1. Remove the ignition timing eye hole cap on the left crankcase cover.
2. Use a timing light to check if the index mark on the left crankcase cover aligns with the "F" mark on the flywheel. If no, replace the CDI unit with a new one.

Ignition Timing: $15^\circ \pm 1.5^\circ / 1600 \pm 100$ rpm

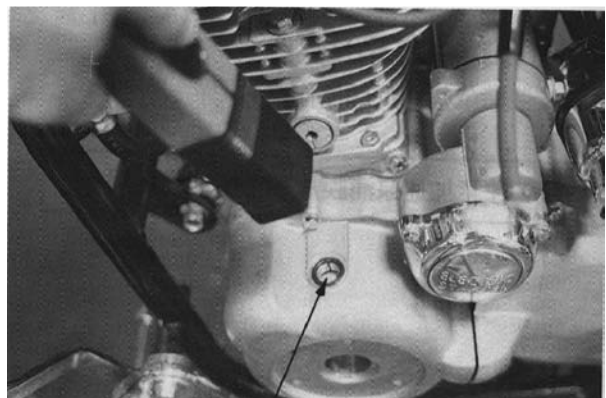

Eye Hole

19. EVAPORATIVE/EXHAUST EMISSION CONTROL SYSTEM

EXHAUST EMISSION TEST AND ADJUSTMENT

1. Start the engine and warm up for several minutes. (Engine surface temperature $60^{\circ}\text{C} \sim 80^{\circ}\text{C}$)
2. Adjust the idle speed to 1600 ± 100 rpm.
3. Connect the emission tester sampling pipe to the exhaust muffler.
Standard: CO: 1.2 ± 0.3 max.
HC: 500PPM max.
4. If CO or HC exceeds the specified values, adjust the carburetor pilot screw (P.S.) until CO and HC are within the specified standard values.
5. If the adjustment of carburetor makes no difference, inspect exhaust emission related system.



Emission Tester Sampling Pipe

19. EVAPORATIVE/EXHAUST EMISSION CONTROL SYSTEM

EXHAUST EMISSION CONTROL SYSTEM

EXHAUST EMISSION CONTROL SYSTEM DIAGRAM.....	19-14
EXHAUST EMISSION CONTROL SYSTEM FUNCTION.....	19-15
TROUBLESHOOTING.....	19-15
SERVICE INFORMATION.....	19-16
SECONDARY AIR CLEANER.....	19-17
AIR INJECTION CUT-OFF VALVE (A.I.C.V.)	19-18
REED VALVE.....	19-19

19. EVAPORATIVE/EXHAUST EMISSION CONTROL SYSTEM

EXHAUST EMISSION CONTROL SYSTEM DIAGRAM SECONDARY AIR INJECTION SYSTEM

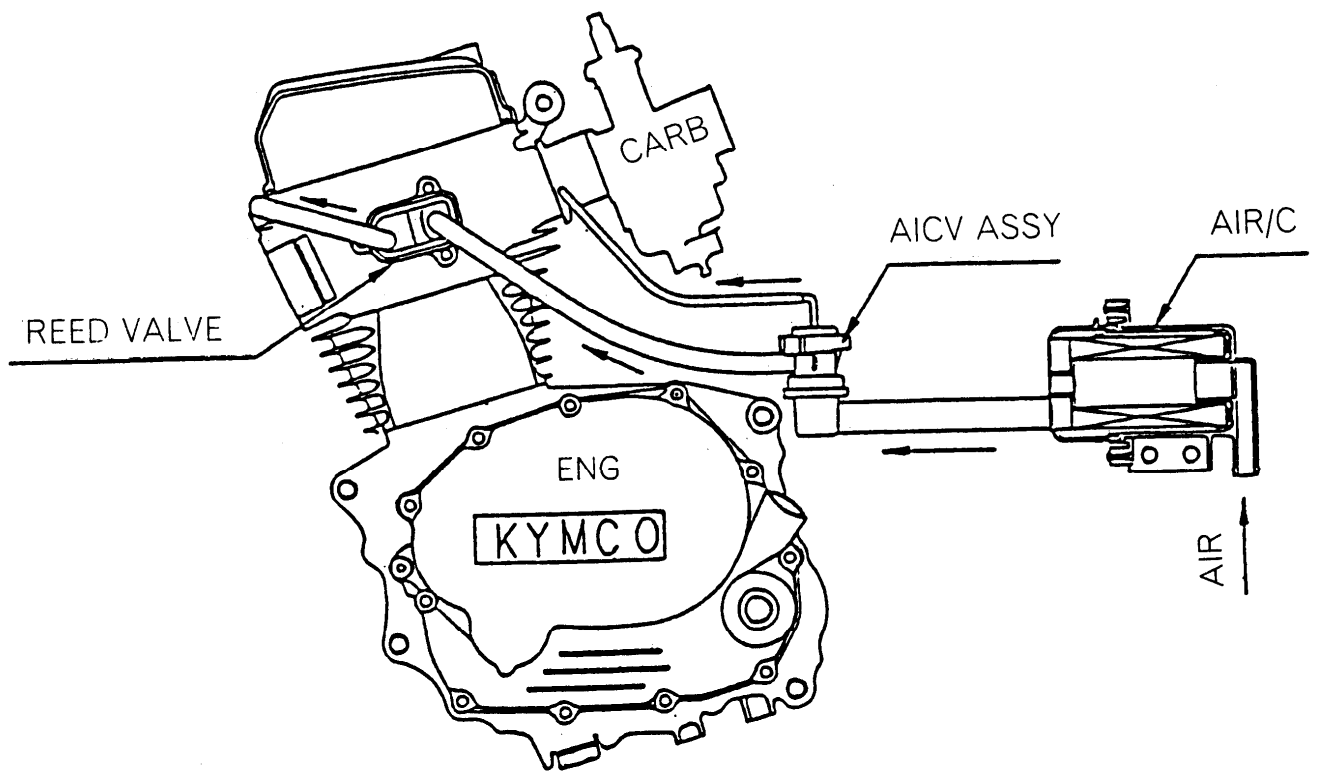

19. EVAPORATIVE/EXHAUST EMISSION CONTROL SYSTEM

EXHAUST EMISSION CONTROL SYSTEM

The exhaust emission control system adopted in this model utilizes the reed valve to draw secondary air into the exhaust system for re-combustion by means of exhaust pulsation so as to minimize the exhaust emission.

FUNCTION

Item	Purpose	Function
Secondary Air Cleaner	Filter secondary air.	It filters the fresh air drawn for re-burning to prevent dirt or dust from affecting the operation of the air injection cut-off valve.
Air Injection Cut-off Valve	Prevent exhaust muffler noise and backfiring at sudden deceleration.	The air injection cut-off valve usually opens to lead air into the exhaust muffler in which air is re-burned to reduce CO. When the throttle valve closes suddenly, the air injection cut-off valve is actuated by vacuum to close and cut off secondary air in order to prevent exhaust muffler backfiring due to air in the exhaust system.
Reed Valve	Control the secondary air inlet to reduce CO.	When the motorcycle speed is less than 50km per hour, the reed valve operates to draw secondary air into the exhaust system for re-combustion.

TROUBLESHOOTING

High CO at idle speed

1. Damaged or clogged reed valve
2. Damaged or clogged air injection cut-off valve
3. Clogged air cleaner

Backfiring at sudden deceleration

1. Damaged reed valve (malfunction)
2. Faulty air injection cut-off valve (unable to close)
3. Carburetor incorrectly adjusted
4. Faulty air cut-off valve
5. Leaking vacuum tube

Exhaust muffler noise

1. Faulty air injection cut-off valve
2. Broken vacuum tube
3. Reed valve failure

19. EVAPORATIVE/EXHAUST EMISSION CONTROL SYSTEM

SERVICE INFORMATION

GENERAL INSTRUCTIONS

- During operation, be careful to avoid scalding caused by the exhaust muffler.
- Note the locations of tubes for proper installation.
- Replace any damaged tube with a new one.
- Make sure to tighten the connector of each tube securely

TOOLS

- Vacuum pump — A937X — 014 — XXXX

SPECIFICATIONS

Air injection cut-off valve actuating pressure — 250mm/Hg — 30 liter/min.

Reed stopper clearance — 4.6mm

19. EVAPORATIVE/EXHAUST EMISSION CONTROL SYSTEM

SECONDARY AIR CLEANER

REMOVAL

1. Remove the right side cover and disconnect the secondary air cleaner connecting tube.
2. Remove the secondary air cleaner case.

Bolt



Right Side Cover

Connecting Tube



Secondary Air Cleaner

DISASSEMBLY

1. Remove the two secondary air cleaner cover screws and the air cleaner cover.
2. Remove the air cleaner element.
3. Inspect the air cleaner for dirt or clogging.

*

- The secondary air cleaner must be assembled and installed properly to avoid dust entering the air cleaner.

Air Outlet Tube

Element

O-ring

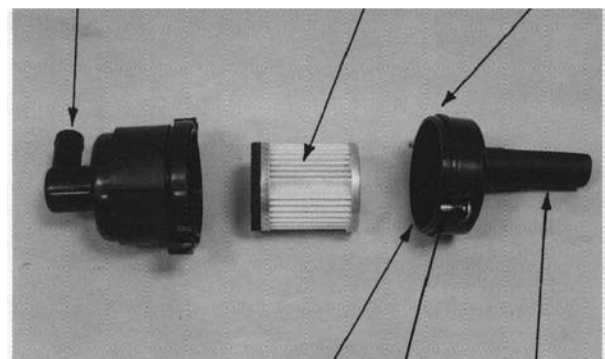

Cover

Screws

Air Inlet Tube

19. EVAPORATIVE/EXHAUST EMISSION CONTROL SYSTEM

AIR INJECTION CUT-OFF VALVE (A.I.C.V.)

REMOVAL

1. Remove the front right decorative cover under the fuel tank.
2. Disconnect all the tubes that go to the air injection cut-off valve.
3. Remove the air injection cut-off valve mounting bolts to remove the air injection cut-off valve.

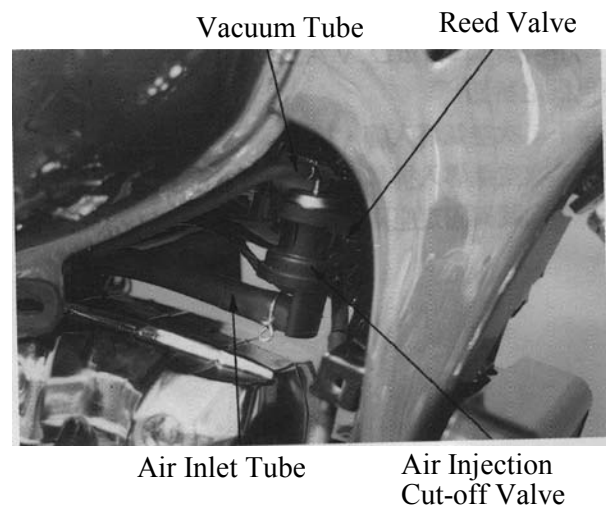

INSPECTION

1. Remove the front right decorative cover under the fuel tank.
2. Inspect the air injection cut-off valve flow using a vacuum pump. If the flow is not within the specified range, replace it with a new one.
3. The flow should be at least 30 liter/min when a vacuum of 250mm/Hg is applied.
4. The flow should be at least 1.6 liter/min when a vacuum of 320mm/Hg is applied.
5. Check each connecting tube for cracks or damage and replace if necessary.

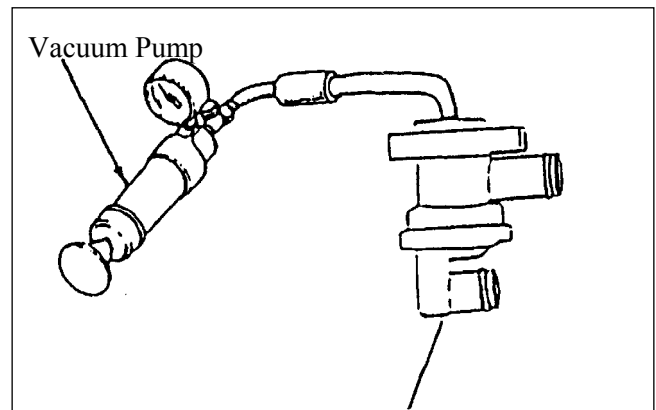

INSTALLATION

The installation sequence is the reverse of removal.

*

- When installing, be careful not to bend or twist the tubes and check for proper installation.
- The tube length is very important to its performance, use the tube of same specification for replacement.

19. EVAPORATIVE/EXHAUST EMISSION CONTROL SYSTEM

REED VALVE

REMOVAL

1. Disconnect the secondary air inlet tube and connector.
2. Remove the two bolts attaching the secondary air exhaust port duct.
3. Remove the two bolts attaching the reed valve unit to remove the reed valve unit.

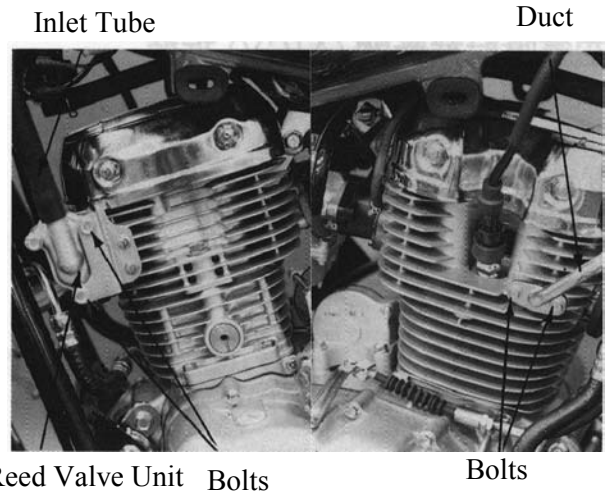

INSPECTION

1. Remove the three bolts attaching the reed valve cover and take out the reed valve.
2. Check the reed valve for cracks, damage, big clearance or weak reeds. Replace if necessary.
3. Check the gasket and O-ring for damage or deterioration and replace if necessary.
4. The reed stopper clearance should be 4.6mm

Reed Stopper

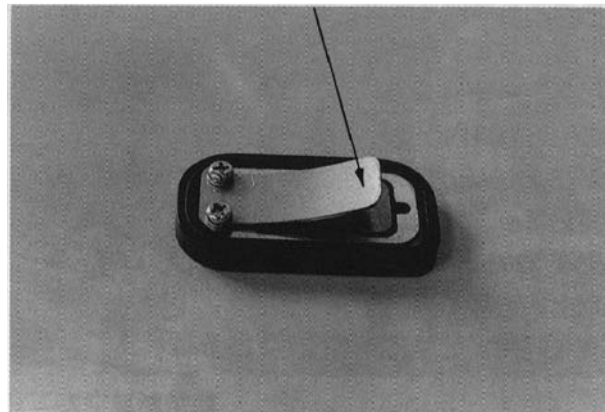

INSTALLATION

Install the reed valve in the reverse order of removal.

*

- When installing, be careful not to bend or twist the tubes and check for proper installation.